

---

---

**Graphic notations for concept  
modelling in terminology work and its  
relationship with UML —**

**Part 1:  
Guidelines for using UML notation in  
terminology work**

*Notations graphiques pour la modélisation des concepts en  
terminologie et ses relations avec UML —*

*Partie 1: Lignes directrices pour l'application de la notation UML dans  
le travail terminologique*





**COPYRIGHT PROTECTED DOCUMENT**

© ISO 2014

All rights reserved. Unless otherwise specified, no part of this publication may be reproduced or utilized otherwise in any form or by any means, electronic or mechanical, including photocopying, or posting on the internet or an intranet, without prior written permission. Permission can be requested from either ISO at the address below or ISO's member body in the country of the requester.

ISO copyright office  
Case postale 56 • CH-1211 Geneva 20  
Tel. + 41 22 749 01 11  
Fax + 41 22 749 09 47  
E-mail [copyright@iso.org](mailto:copyright@iso.org)  
Web [www.iso.org](http://www.iso.org)

Published in Switzerland

# Contents

	Page
<b>Foreword</b> .....	<b>iv</b>
<b>Introduction</b> .....	<b>v</b>
<b>1 Scope</b> .....	<b>1</b>
<b>2 Normative references</b> .....	<b>1</b>
<b>3 Terms and definitions</b> .....	<b>1</b>
<b>4 Abbreviated terms</b> .....	<b>3</b>
<b>5 Mapping UML symbols to terminological concepts</b> .....	<b>3</b>
5.1 General .....	3
5.2 Concept .....	3
5.3 Concept system .....	3
5.4 Attributes (generalization) and characteristics (generic relation) .....	4
5.5 Type of characteristics and criterion of subdivision .....	5
5.6 Concept relations .....	9
<b>6 Common features of UML used to extend concept modelling</b> .....	<b>18</b>
6.1 General .....	18
6.2 Multiplicity .....	18
6.3 Constraint .....	19
<b>Annex A (informative) Table of correspondence between ISO 1087-1 concepts and their adopted symbols in the ISO 24156-1 user-defined UML profile</b> .....	<b>21</b>
<b>Bibliography</b> .....	<b>24</b>

## Foreword

ISO (the International Organization for Standardization) is a worldwide federation of national standards bodies (ISO member bodies). The work of preparing International Standards is normally carried out through ISO technical committees. Each member body interested in a subject for which a technical committee has been established has the right to be represented on that committee. International organizations, governmental and non-governmental, in liaison with ISO, also take part in the work. ISO collaborates closely with the International Electrotechnical Commission (IEC) on all matters of electrotechnical standardization.

The procedures used to develop this document and those intended for its further maintenance are described in the ISO/IEC Directives, Part 1. In particular the different approval criteria needed for the different types of ISO documents should be noted. This document was drafted in accordance with the editorial rules of the ISO/IEC Directives, Part 2 (see [www.iso.org/directives](http://www.iso.org/directives)).

Attention is drawn to the possibility that some of the elements of this document may be the subject of patent rights. ISO shall not be held responsible for identifying any or all such patent rights. Details of any patent rights identified during the development of the document will be in the Introduction and/or on the ISO list of patent declarations received (see [www.iso.org/patents](http://www.iso.org/patents)).

Any trade name used in this document is information given for the convenience of users and does not constitute an endorsement.

For an explanation on the meaning of ISO specific terms and expressions related to conformity assessment, as well as information about ISO's adherence to the WTO principles in the Technical Barriers to Trade (TBT) see the following URL: [Foreword - Supplementary information](#)

The committee responsible for this document is ISO/TC 37, *Terminology and other language and content resources*, Subcommittee SC 1, *Principles and methods*.

This first edition of ISO 24156-1 cancels and replaces ISO/TR 24156:2008, which has been technically revised.

ISO 24156 consists of the following parts, under the general title *Graphic notations for concept modelling in terminology work and its relationship with UML*:

— *Part 1: Guidelines for using UML notation in terminology work*

## Introduction

Terminology work combines elements from many theoretical approaches which concern the processing, ordering, and presentation of knowledge. The basic method of terminology work is concept analysis, which aims to achieve a comprehensive description and presentation of concepts in a subject field. Traditionally, the results of concept analysis in terminology are presented in the form of one or more concept diagrams and a set of terms with textual definitions.

In object-oriented programming, graphic techniques are used to describe entity types which are characterized by certain properties and behaviour. The Unified Modeling Language (UML) is a widely used formal language which can be used for all kinds of object modelling (information modelling, data modelling, etc.).

This part of ISO 24156 describes the application of UML symbols by providing a user-defined UML profile for presenting the results of concept analysis. This UML profile re-uses UML symbols independent of their normal UML semantics to represent terminological concept diagrams in accordance with the principles of ISO 1087-1 and ISO 704. The use of UML symbols is not meant to become a replacement for traditional concept diagrams, but is intended to be an alternative and supplementary notation. This part of ISO 24156 is meant to promote the use of concept analysis when developing concept diagrams (including concept models), information models, and data models.

The core text describes in which way a user-defined UML profile represents concept diagrams. [Annex A](#) contains a table of correspondence between concepts of ISO 1087-1 and suggested representations in UML.

ISO/IEC 19505-1 and ISO/IEC 19505-2 are referenced in this part of ISO 24156. In ISO/IEC 19505-1 and ISO/IEC 19505-2, there is no “Terms and definitions” clause. Instead, every UML concept is described in the normative text. When a reference to ISO/IEC 19505-2 is given in the “Terms and definitions” clause, the definition given in this part of ISO 24156 is adapted from the descriptive text in ISO/IEC 19505-2. Therefore, the definition is noted “Adapted from ISO/IEC 19505-2”.

.....

# Graphic notations for concept modelling in terminology work and its relationship with UML —

## Part 1: Guidelines for using UML notation in terminology work

### 1 Scope

This part of ISO 24156 gives guidelines for using a subset of UML symbols independent of their normal UML meaning, to represent concepts in concept models that result from concept analysis. It describes how UML symbols can be used for that. A UML profile designed for this purpose is used to represent concepts and concept relations in terminology work.

This part of ISO 24156 does not describe UML and its general use in depth. These matters are covered in ISO/IEC 19505-1 and ISO/IEC 19505-2.

This part of ISO 24156 does not describe the principles and methods of terminology work. This is covered in ISO 704.

This part of ISO 24156 does not define the fundamental concepts of terminology work. This is covered in ISO 1087-1.

### 2 Normative references

The following documents, in whole or in part, are normatively referenced in this document and are indispensable for its application. For dated references, only the edition cited applies. For undated references, the latest edition of the referenced document (including any amendments) applies.

ISO 704:2009, *Terminology work — Principles and methods*

ISO 1087-1:2000, *Terminology work — Vocabulary — Part 1: Theory and application*

ISO 10241-1, *Terminological entries in standards — Part 1: General requirements and examples of presentation*

ISO/IEC 19505-1:2012, *Information technology — Object Management Group Unified Modeling Language (OMG UML) — Part 1: Infrastructure*

ISO/IEC 19505-2:2012, *Information technology — Object Management Group Unified Modeling Language (OMG UML) — Part 2: Superstructure*

### 3 Terms and definitions

For the purposes of this document, the terms and definitions given in ISO 1087-1 and the following apply.

#### 3.1

##### **concept diagram**

graphic representation of a concept system

[SOURCE: ISO 1087-1:2000, 3.2.12]

#### 3.2

##### **concept model**

concept diagram (ISO 1087-1:2000, 3.2.12) formed by means of a *formal language* (3.6)

**3.3**  
**concept model view**

image of a defined part of a *concept model* (3.2)

**3.4**  
**concept system**

set of concepts structured according to the relations among them

[SOURCE: ISO 1087-1:2000, 3.2.11]

**3.5**  
**constraint**

semantic restriction of model elements

Note 1 to entry: Adapted from ISO/IEC 19505-2:2012, 7.3.10.

Note 2 to entry: A constraint is used to restrict the possible options for a class or a relationship. In concept modelling, constraints can be used to show how concepts/relationships interact and how they are delimited.

EXAMPLE In a generic relation, no more specific concepts than those depicted are possible [constraint {complete}].

**3.6**  
**formal language**

language whose rules are explicitly established before its use

Note 1 to entry: A formal language is not meant to be spoken. Its purpose is to assure exact communication of information, e.g. between computer systems and between man and computer.

EXAMPLE Web Ontology Language (OWL).

**3.7**  
**multiplicity**

when used in class diagrams *constraint* (3.5) on the range of allowed instances of an object or an attribute

[SOURCE: ISO/IEC 14776-151:2010, modified — By replacing “indication of” with “constraint on”, this terminological entry is made consistent with the other terms and definitions in this part of ISO 24156.]

Note 1 to entry: In concept modelling, a multiplicity constraint specifies how many objects depicted by a certain concept can be related to the objects depicted by another concept, i.e. in an associative or in a partitive relation.

EXAMPLE 1 A characteristic of a month is that it is a period of 28 to 31 days (28..31). Thus, the multiplicity of day with respect to month is “28..31”.

EXAMPLE 2 A mouse (pointing device) can or cannot have a ball, depending on whether it is a mechanical or optical mouse. Thus, it has zero balls or one ball (0..1). In that case, the multiplicity itself is a criterion of subdivision, as a mechanical mouse has exactly one ball (1).

Note 2 to entry: Multiplicity applies to attributes as well.

**3.8**  
**notation**

set of symbols, and the rules for their use, for the representation of data

[SOURCE: ISO/IEC 2382-5:1999, 05.01.01]

**3.9**  
**symbol**

graphic representation of a concept that has meaning in a specific context

[SOURCE: ISO/IEC 2382-1:1993, 01.02.07]



## 4 Abbreviated terms

UML Unified Modeling Language

## 5 Mapping UML symbols to terminological concepts

### 5.1 General

This clause describes how concepts defined in ISO 1087-1 can be represented in concept modelling by means of a limited set of UML symbols. Features which are not described in this clause are outside the scope of this part of ISO 24156.

Each paragraph describes the principles according to which UML symbols can be used in concept modelling. In this part of ISO 24156, UML symbols are only used as graphic representations, hence are not used to equate UML semantics with ISO 1087-1 semantics.

Table A.1 visualizes ISO 1087-1 concepts and their corresponding UML symbols.

### 5.2 Concept

For the modelling of a concept, the UML class symbol (ISO/IEC 19505-2:2012, 7.3.7) can be adopted, which is a solid-outline rectangle displaying the class name. The UML class name is centred in boldface and with an initial uppercase character. (If the class name consists of more than one word, the words are joined together and the initial character of every word is capitalized; for designations, please refer to ISO 10241-1.) The designation (ISO 1087-1) of the concept in the user-defined UML profile is centred, in boldface, and in lowercase, except for uppercase characters that constitute part of the normal spelling of the term in a running text (ISO 10241-1). This applies both to individual concepts (ISO 1087-1) and to general concepts (ISO 1087-1).

UML (ISO/IEC 19505-2:2012)	ISO 1087-1	ISO 24156-1 user-defined UML profile
<b>Class</b>	<b>concept</b>	concept
<b>ClassName</b>	<b>designation</b>	designation

**Figure 1 — Class (class name) and concept (designation)**

### 5.3 Concept system

A concept model (see 3.2) is meant to depict and represent a concept system (see 3.4). A graphic tool can store the concept model in a formal language (see 3.6), making it possible to transform, using a machine-readable format, the concept model to data modelling, information modelling, and software development systems.

EXAMPLE Concept model for pointing devices (see Figure 2).

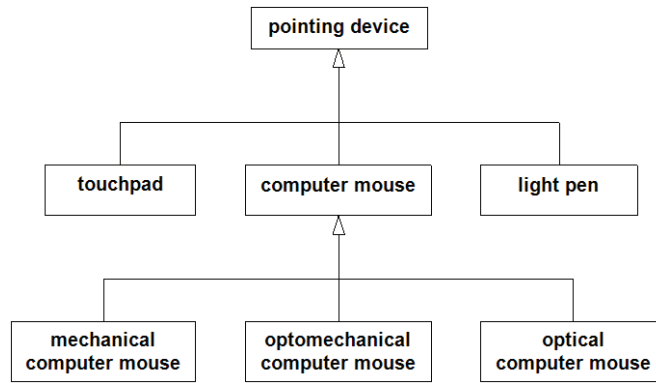


Figure 2 — Concept model that depicts generic relations for pointing devices

### 5.4 Attributes (generalization) and characteristics (generic relation)

For concept modelling using UML symbols, the UML class symbol is used (see Figure 1), which is a rectangle. In it, the top compartment displays the class name (centred, in boldface, and capitalized), and the middle one a list of attribute names (left justified, plain face, and lowercase) and attribute types (left justified, plain face, and capitalized). The bottom compartment in the UML class symbol, used to show class operations in ISO/IEC 19505-2:2012, is not used to represent ISO 1087-1 concepts, and is therefore not shown in this International Standard. To convert the class symbol to an ISO-compatible modelling template, a concept is modelled by a rectangle which has equally two compartments, with the top one displaying the designation (in accordance with ISO 10241-1) and the bottom one displaying the characteristics. The UML string *attribute = value* represents the characteristics.

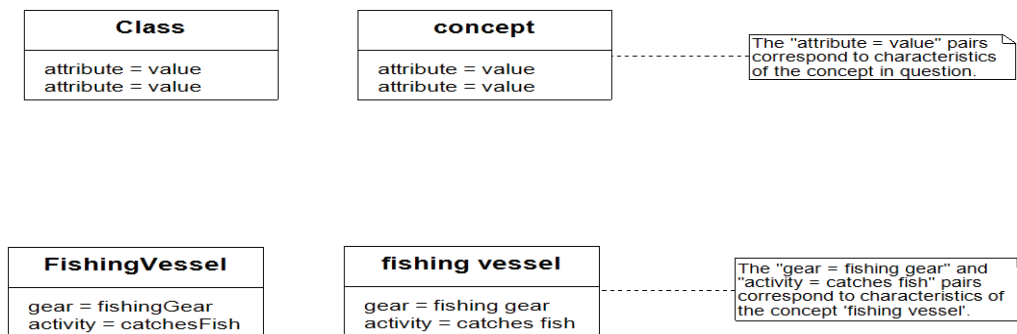


Figure 3 — Attributes and characteristics in UML and in the ISO 24156-1 user-defined UML profile

An ellipsis indicates that there are elements which are not shown in the concept model (see Figure 4).

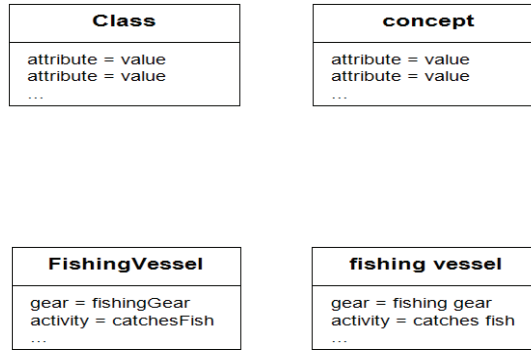


Figure 4 — Attributes and characteristics in UML and in the ISO 24156-1 user-defined UML profile

### 5.5 Type of characteristics and criterion of subdivision

A type of characteristics is defined as a category of characteristics which serves as the criterion of subdivision when establishing concept systems. The criterion of subdivision is defined as a criterion according to which a superordinate concept is divided into subordinate concepts. With UML notation, a criterion of subdivision can be represented using two generalization set notations (ISO/IEC 19505-2:2012, 7.3.20) (see Figures 5 and 6).

To visualize classes and their relationships in a class diagram, together with their criteria of subdivision, UML uses two different notations that can be considered equivalent to the criterion of subdivision in ISO terminology (ISO 1087-1; ISO 704). Either a common generalization arrowhead is used in combination with the name of the relevant generalization set, or a dashed line is drawn across those lines with separate arrowheads that belong to the same generalization set (ISO/IEC 19505-2:2012, 7.3.20). To represent the above UML notation with an equivalent ISO notation (ISO 704:2009, 5.5.2.2.1), the criterion of subdivision is displayed in full wording, either in combination with a common generalization arrowhead or with a dashed line across separate generalization arrowheads (see Figures 5, 6 and 7).

The ISO notation adopts the UML notation in the following mode: the criterion of subdivision is displayed by placing its name next to the relevant generic relation arrow(s), using a dashed line where more than one generic relation arrows are involved. The arrow(s) in turn link(s) the generic concept to its specific concepts by the UML generalization symbol.

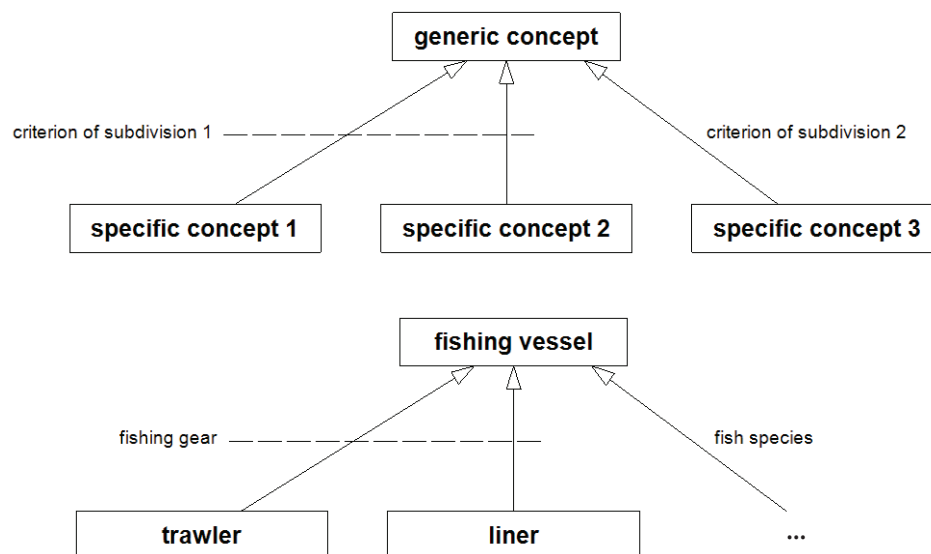


Figure 5 — Criterion of subdivision: ISO 704 > ISO 24156-1 user-defined UML profile

In this ISO 24156-1 user-defined UML profile, the types of characteristics (criteria of subdivision) are the equivalent of the UML generalization sets which refer to the attributes of the superclass. In UML subclasses, attributes are complemented by attribute types and by values. For the concept model, the UML attribute-value strings of subclasses are kept to visualize the characteristics in the user-defined UML profile at hand (see Figures 8 and 9). Figures 8 and 9 adopt the UML template, superpose the corresponding rectangles (classes versus concepts), and propose a user-defined UML profile to represent the terminological principles of ISO 704.

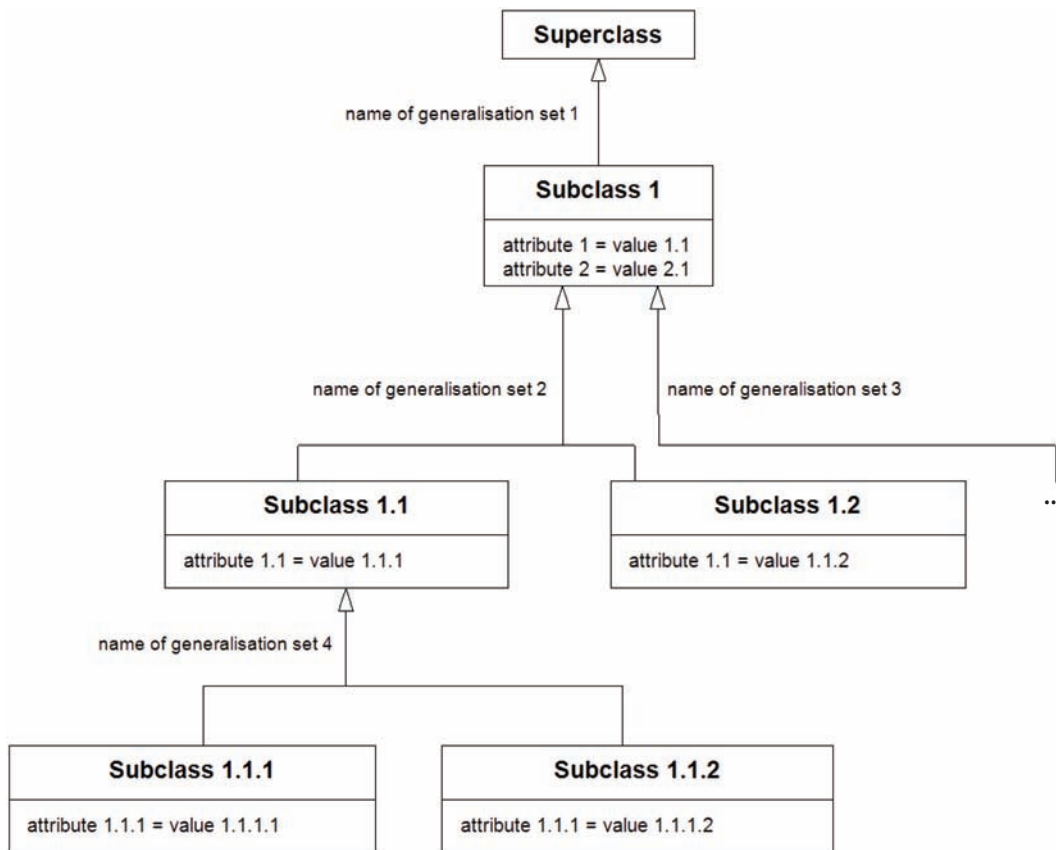


Figure 6 — Modelling of classes with “attribute = value” strings in UML

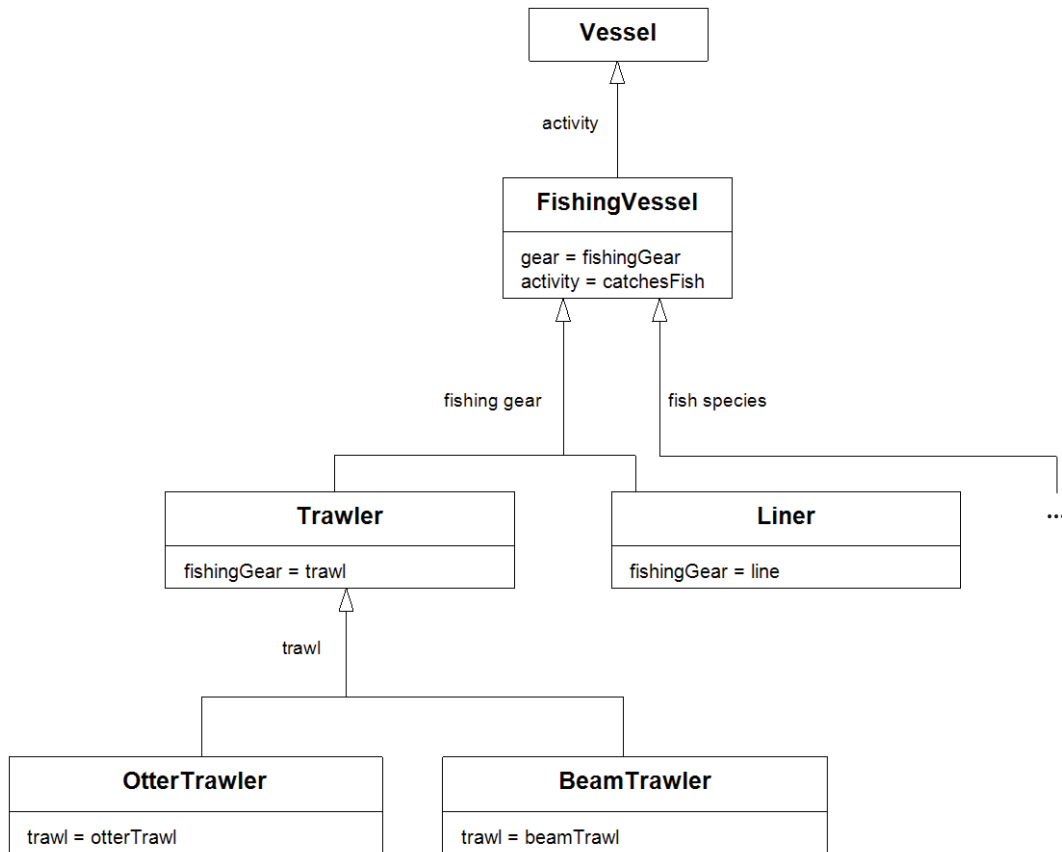


Figure 7 — Modelling of classes with “attribute = value” strings in UML: example

www.iso.org/standard/5966844001

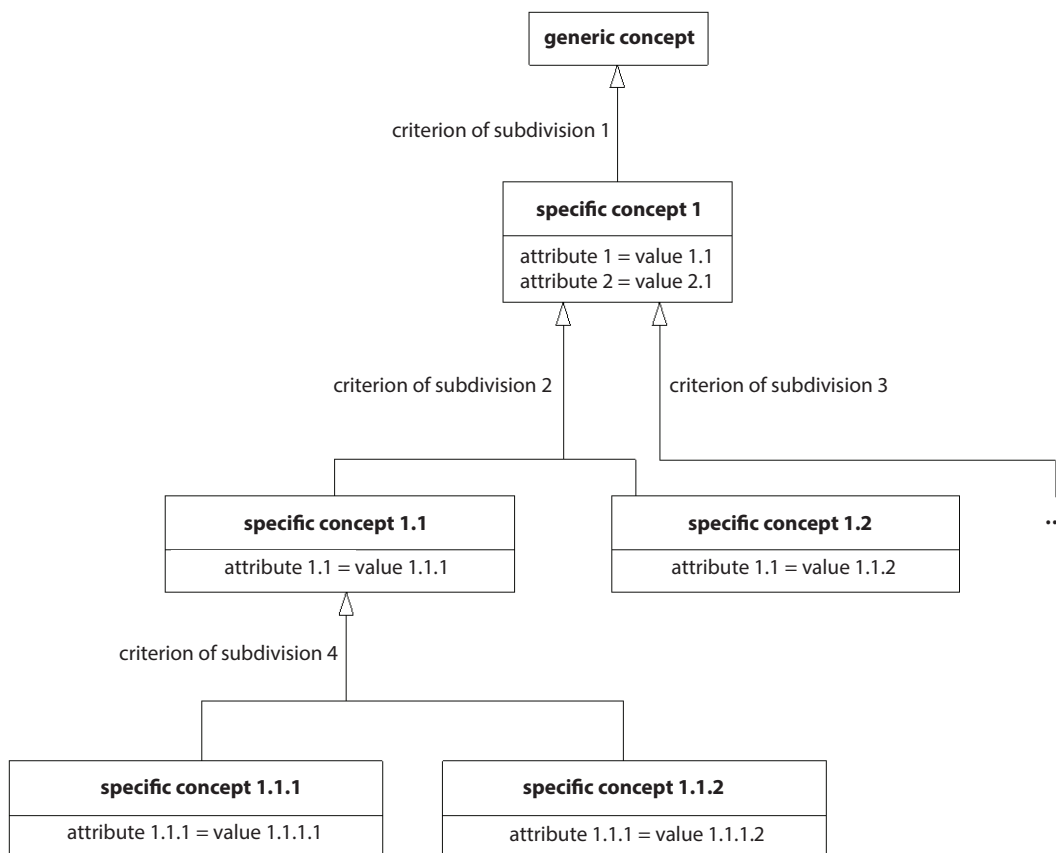
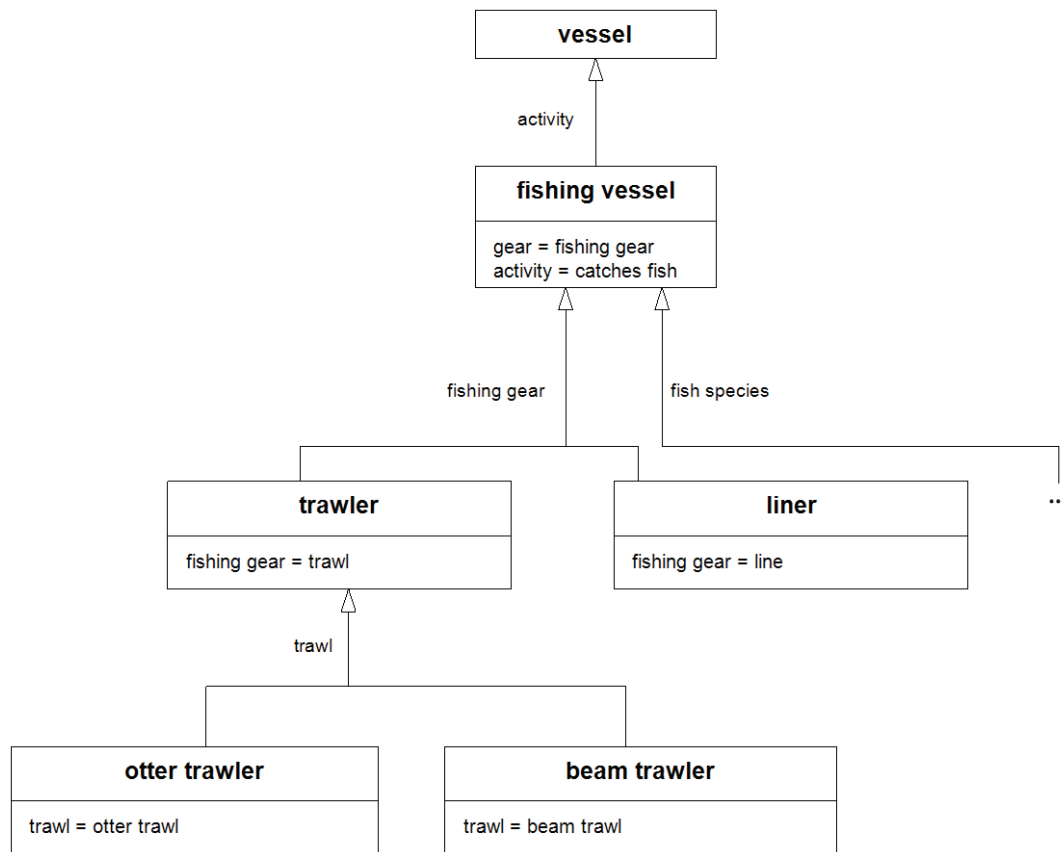


Figure 8 — Concept modelling with characteristics in the ISO 24156-1 user-defined UML profile



**Figure 9 — Concept modelling with characteristics in the ISO 24156-1 user-defined UML profile: example**

## 5.6 Concept relations

In ISO 1087-1, a *hierarchical relation* is defined as a relation between two concepts which can be either a generic relation or a partitive relation (ISO 1087-1). UML does not refer to hierarchical relations between concepts, but refers to generalization and aggregation as two types of associations between classes (ISO/IEC 19505-1:2012, 11.3.1 and ISO/IEC 19505-2:2012, 7.3.3). In other words, UML does not provide a superordinate concept for generalization and aggregation.

### 5.6.1 UML associations and associative relations

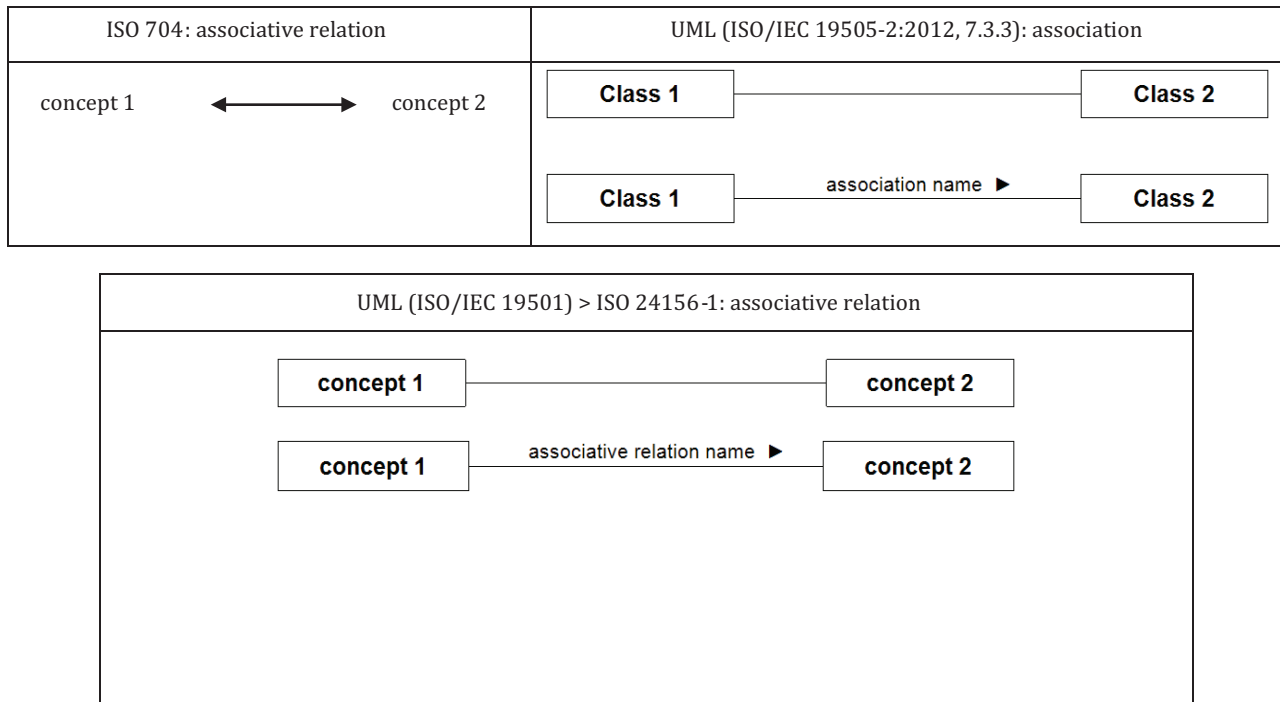
UML associations connect classes in class diagrams and depict the semantic relationships between the classes (ISO/IEC 19505-1:2012, 11.3.1).

UML associations can be represented in an object relational notation either as unidirectional relationships or as bidirectional relationships. A unidirectional association means that the association can be crossed only in one direction, whereas a bidirectional association can be crossed in both directions. An association symbol navigable only in one direction is not common practice in concept modelling. The association usually has complementary names in both directions (reverse of the semantic link: “a fisherman owns a fishing vessel” — “a fishing vessel is owned by a fisherman”). If it is actually the same association that is described in both directions, only one direction has to be named. When a name is added to the association, it can be adorned with a triangular arrow pointing in the name direction.

In International Standards on terminology work (ISO 704 and ISO 1087-1), associative relations are always bidirectional and depicted by a continuous line with arrowheads at both ends, while UML presents them with a continuous line which connects two classes in order to indicate a general association

between them. The line can be supplemented with an association name, indicating the association’s nature, adorned with a solid triangle for indicating the relation’s direction (see [Figure 10](#)). UML is able to represent unidirectional associations, contrary to ISO 704, which always represents bidirectional associations (see [Figure 10](#)).

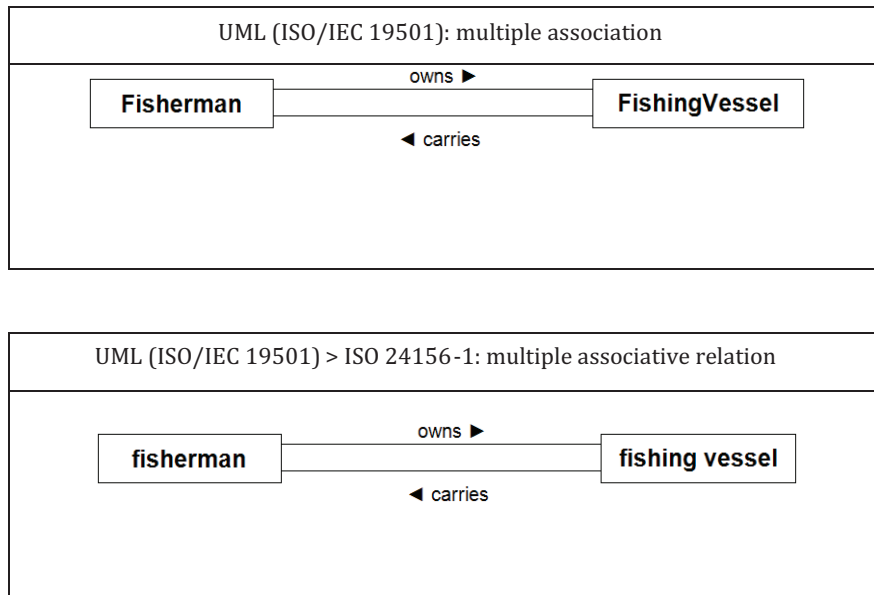
This part of ISO 24156 enriches the current ISO notations (ISO 704) by visualizing both bidirectional as well as unidirectional associative relations between concepts.



**Figure 10 — Associative relation (ISO 704) and association in UML > associative relation in the ISO 24156-1 user-defined UML profile**

There can be two different associations in UML, and each of them can have a name, possibly in different directions (“a fisherman owns a fishing vessel” — “a fishing vessel carries a fisherman”). Two different association lines should be drawn to clearly state that there are two different associations, both of them bidirectional (“a dog is owned by a person”, “a person is bitten by a dog”). This association notation can be adopted in this part of ISO 24156 (see [Figure 11](#)).

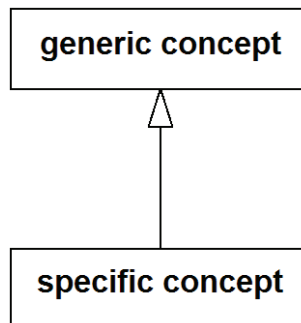




**Figure 11 — Multiple associations in UML and multiple associative relations between concepts in the ISO 24156-1 user-defined UML profile**

### 5.6.2 Generic relations

This part of ISO 24156 adopts the UML generalization symbol (a solid line ending with an unfilled triangular arrowhead pointing towards the superclass) to represent a generic relation between a *specific concept* (ISO 1087-1) and a *generic concept* (ISO 1087-1) (see [Figure 12](#)).



**Figure 12 — Concept model for a generic relation**

If there is more than one specific concept (ISO 1087-1), two presentation options can be adopted from UML: 1) the shared target style and 2) the separate target style. The shared target style depicts a forked solid line that starts from each specific concept, and that ends with an unfilled triangular arrowhead pointing towards the generic concept [see [Figure 13 a](#)].

The separate target style depicts a solid line that starts from each specific concept separately, each of which ends with an unfilled triangular arrowhead pointing towards the generic concept [see [Figure 13 b](#)].

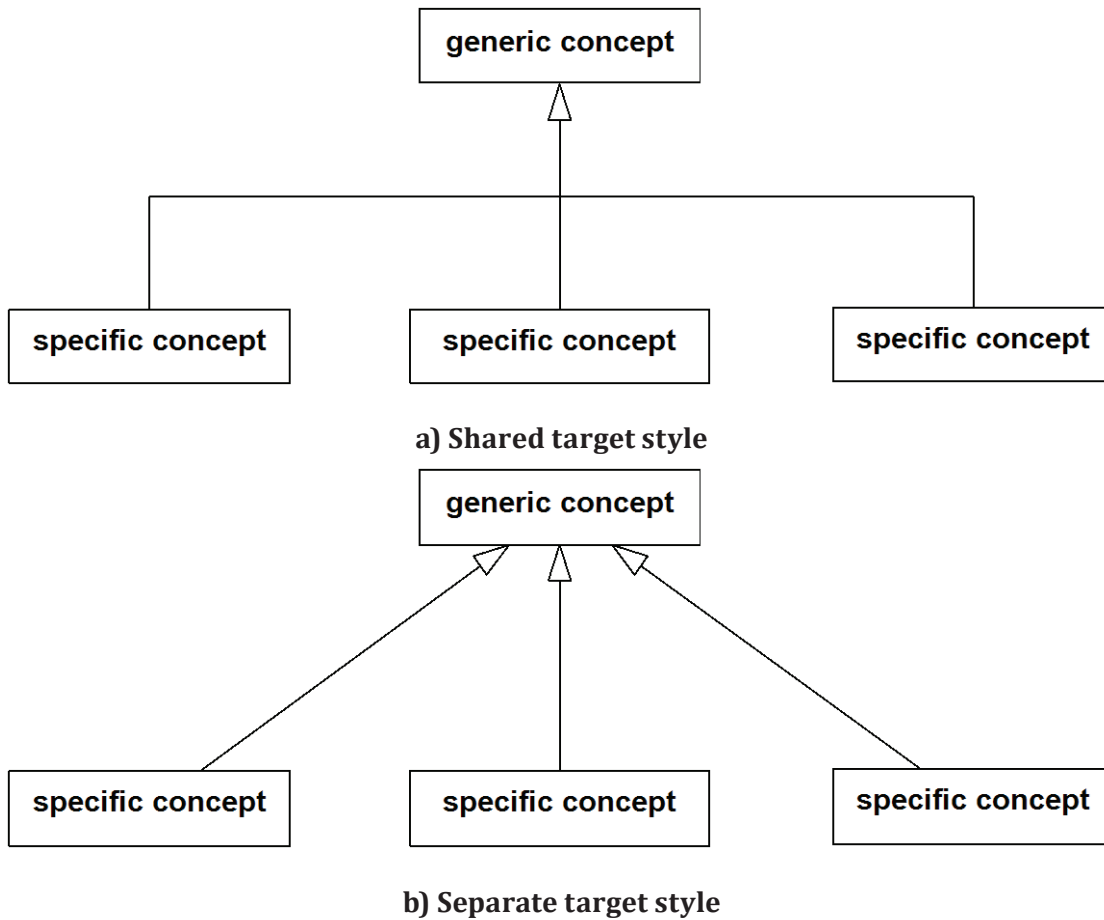
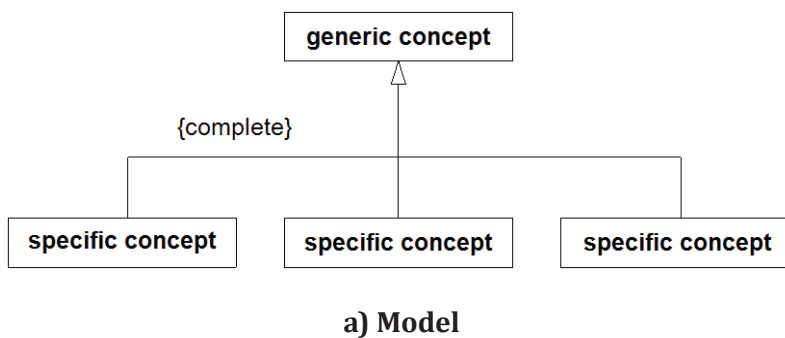
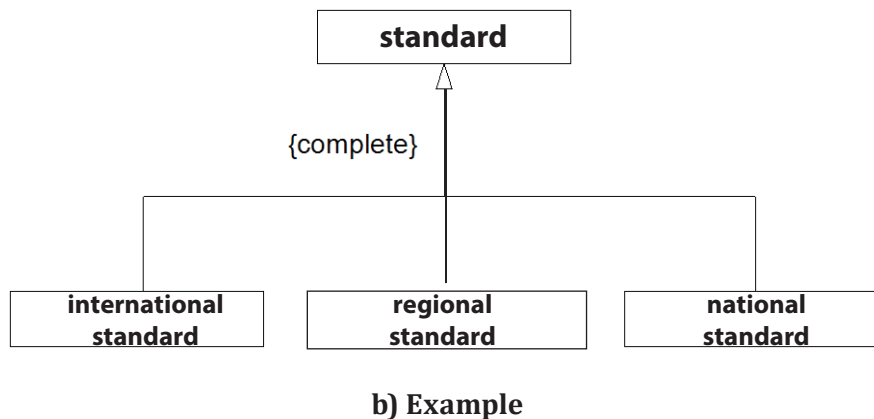


Figure 13 — Concept model for a multiple generic relation

A symbol can be provided which shows whether there can be more specific concepts to a certain generic concept than those depicted. This can be done by means of a constraint (see 3.5), named {complete} or {incomplete} (see 6.3) or by three dots (...) (see Figures 5. 6. 7. 8 and 9).

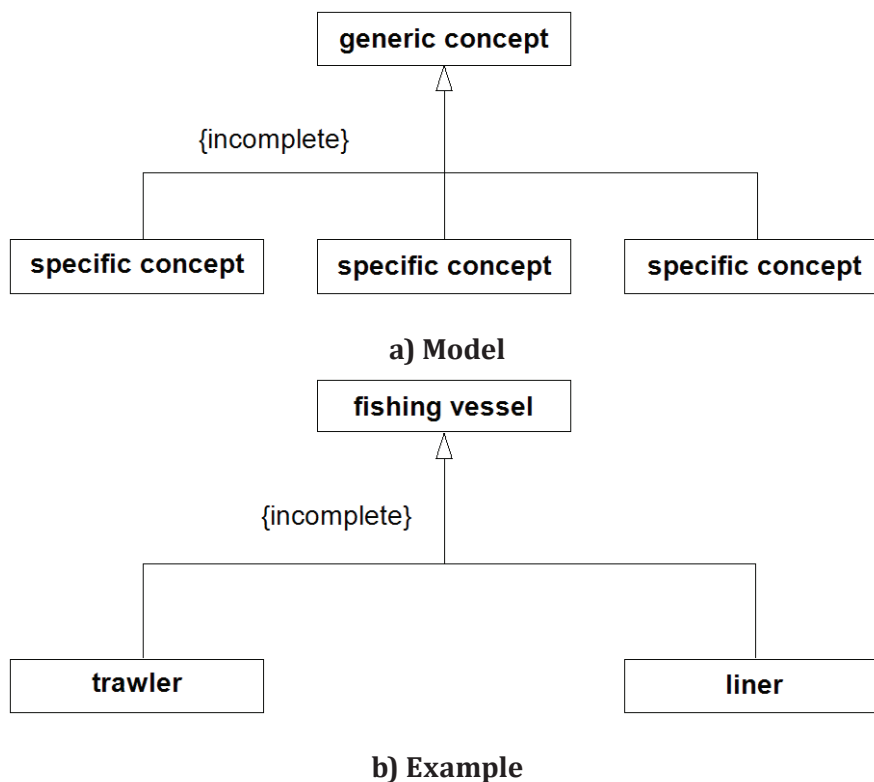
If all existing specific concepts are represented, the generic relation can be marked {complete} as shown in Figure 14 a) and 14 b) or by adding no specific comment (see Figure 13).





**Figure 14 — Concept model for a generic relation with all existing specific concepts represented**

If there are specific concepts that are not represented in the concept model, the generic relation can be marked {incomplete} as in [Figure 15 a\)](#) and [15 b\)](#), or by three dots (...) (see [Figures 5. 6. 7. 8](#) and [9](#)).



**Figure 15 — Concept model for a generic relation in which not all specific concepts are represented**

[Figure 16](#) renders a UML-compatible modelling of a generic relation (ISO 704). The UML symbol adopted for this purpose is an arrow adorned with an unfilled arrowhead. It is used to point towards the generic concept.

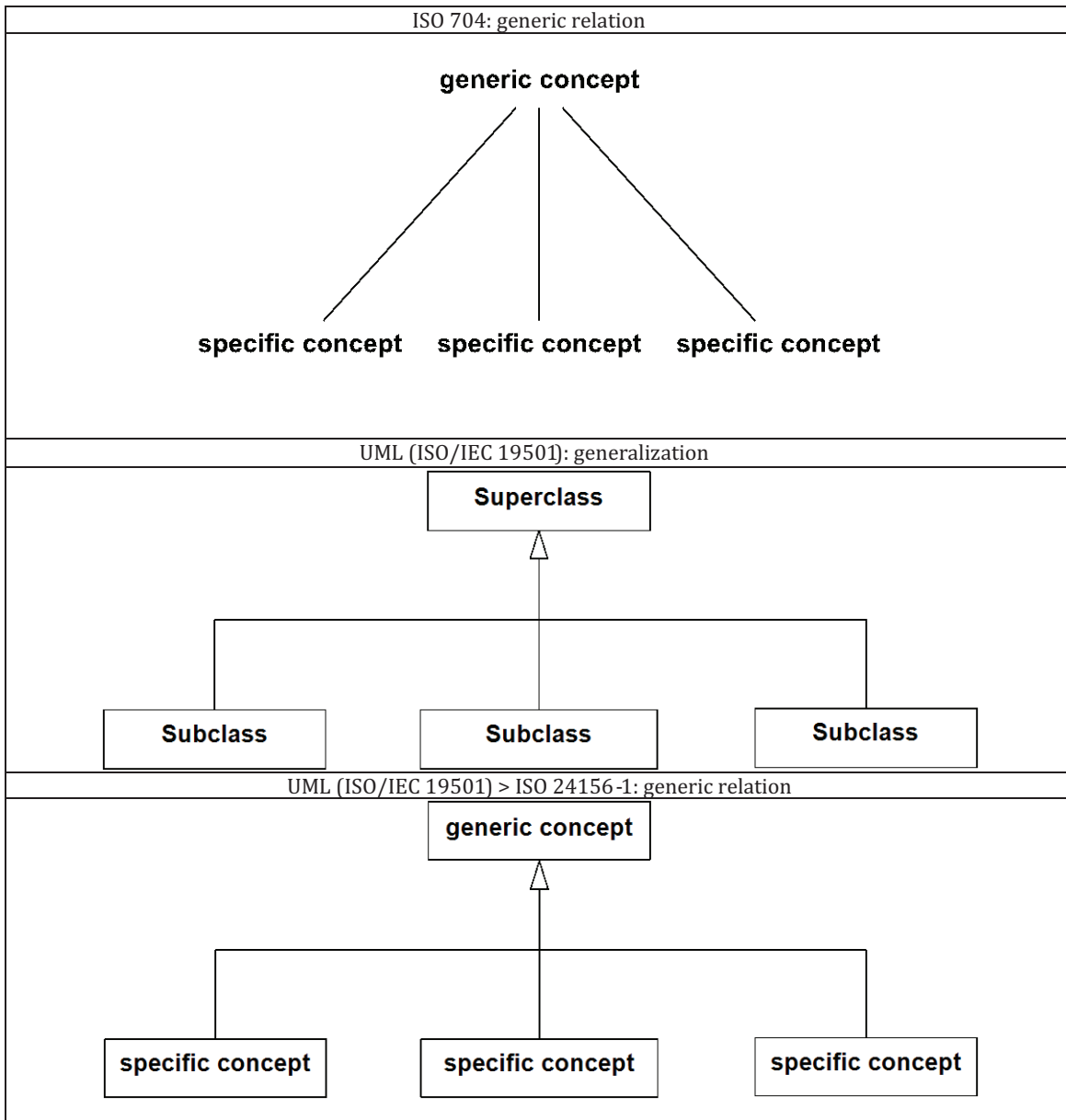


Figure 16 — Generic relation (ISO 704) and UML generalization > generic relation in the ISO 24156-1 user-defined UML profile

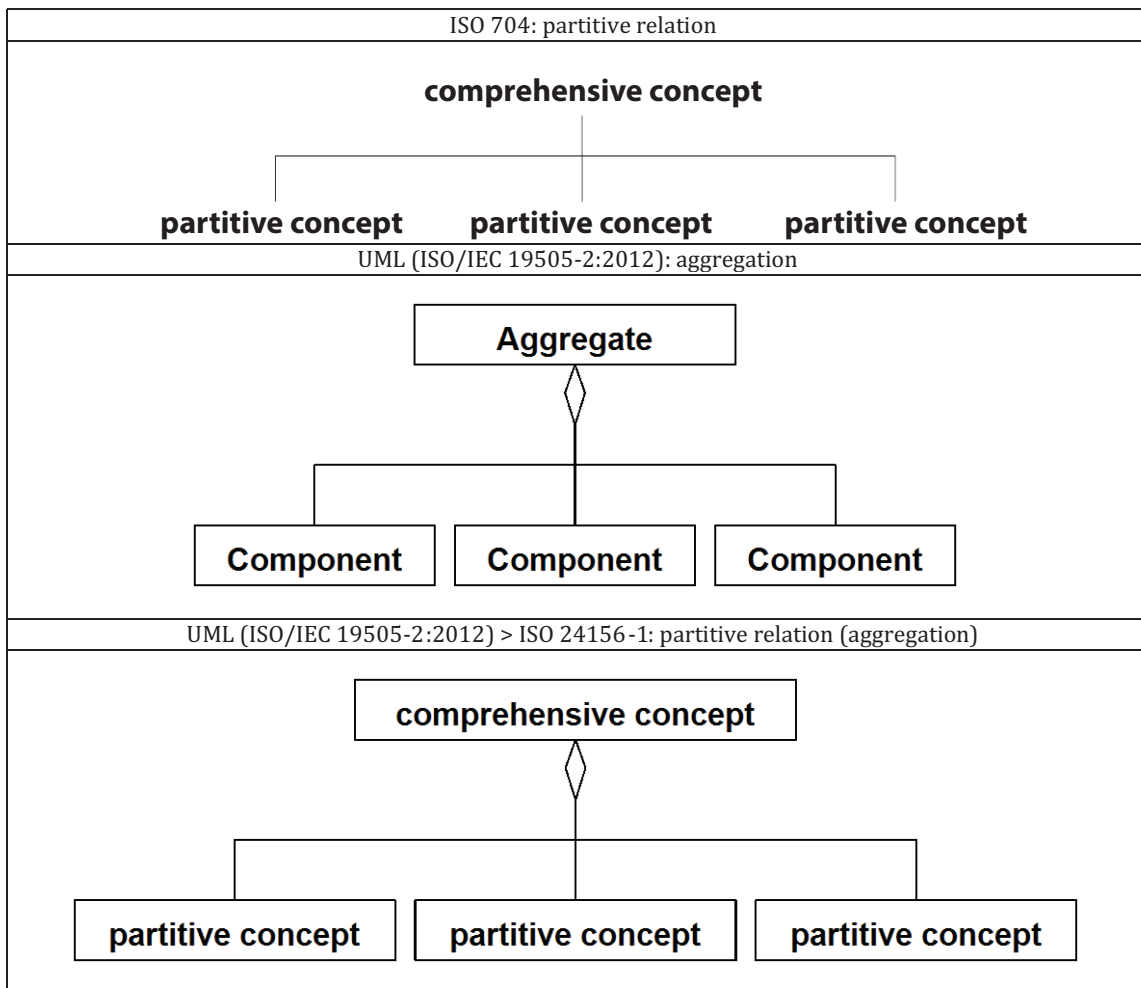
5.6.3 Partitive relations

UML considers an aggregation as an association that specifies a whole-part relationship between the aggregate/composite aggregate (whole) and a component part (ISO/IEC 19505-2:2012, 7.3.3). In this context, ISO 1087-1 and UML differ in that ISO 1087-1 defines a partitive relation (ISO 1087-1, 3.2.20) as a hierarchical relation.

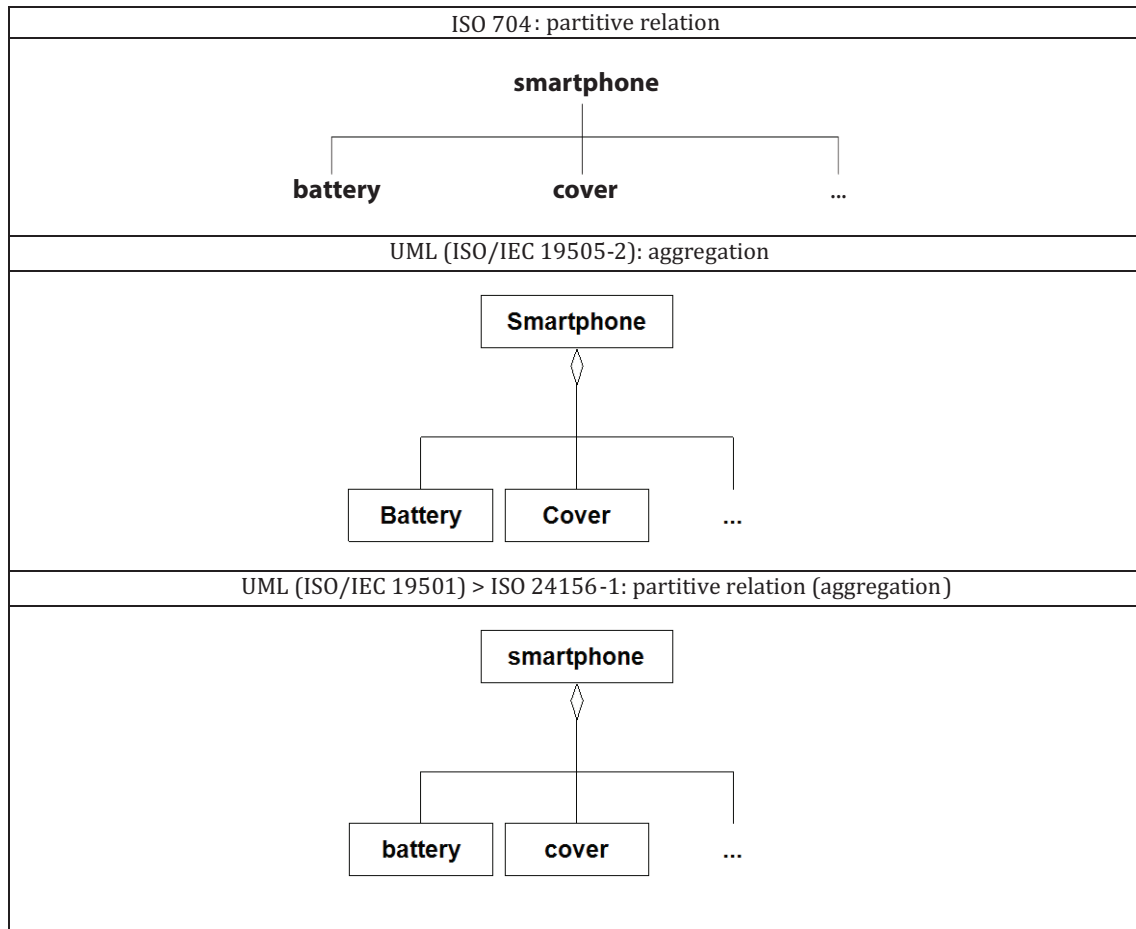
Despite the differences between ISO 1087-1 and UML, it seems appropriate to juxtapose the aggregation and the partitive relation. As a consequence, this part of ISO 24156 represents a partitive relation as an aggregation in a concept model with hierarchical relations [see Figure 17 a) and 17 b)].

A partitive relation should be depicted using a UML aggregation symbol. The symbol is an arrow with a solid line starting at the partitive concept (ISO 1087-1) and an unfilled diamond end pointing towards the comprehensive concept (ISO 1087-1) [see Figure 17 a) and 17 b)].

An unfilled diamond pointing towards both the comprehensive concept and the aggregate is used [see [Figure 17 a](#)]. This type of aggregation does not generate constraints on the components' life cycle (dependencies on the existence of other components).



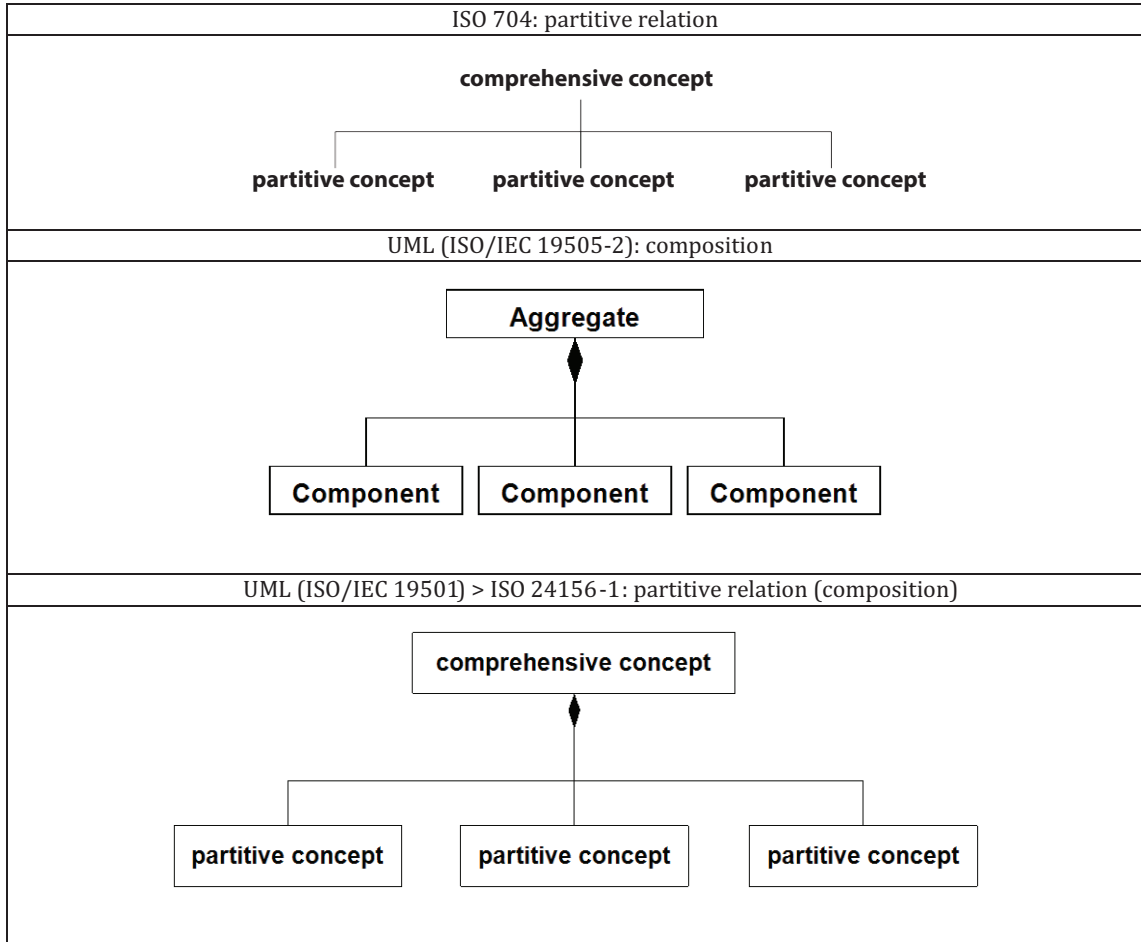
a) Model



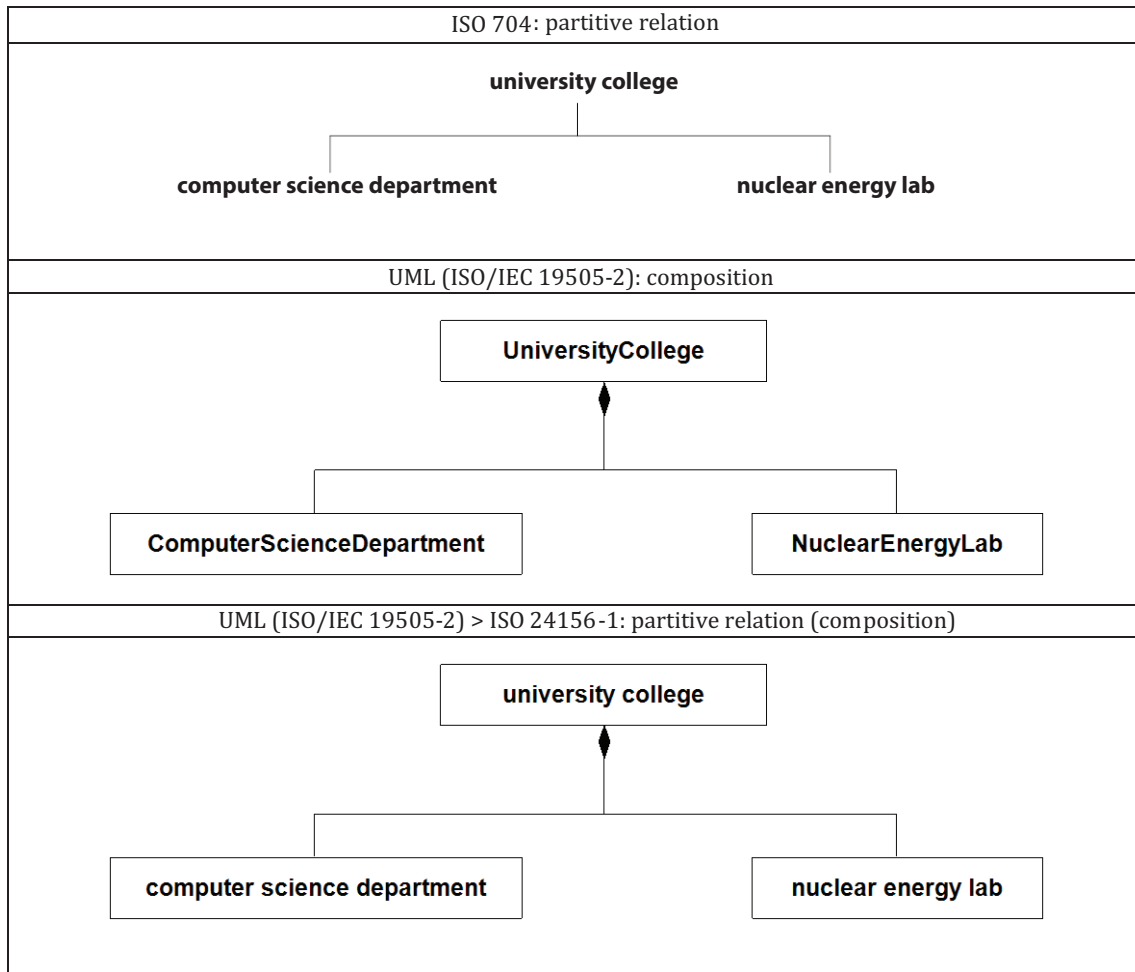
**b) Example**

**Figure 17 — Partitive relation (ISO 704) and UML aggregation > partitive relation (aggregation) in the ISO 24156-1 user-defined UML profile**

Contrary to the ISO partitive relation, UML has an additional aggregation type, which is called *composition* or *composite aggregation*. Adding composition in ISO 704 is possible and improves the current offer of partitive relations in ISO 704. The UML composition symbol (filled diamond) has been adopted [see [Figure 18 a](#)) and [18 b](#))] to visualize composition in this part of ISO 24156.



a) Model



b) Example

Figure 18 — Partitive relation (ISO 704) and UML composition > partitive relation (composition) in the ISO 24156-1 user-defined UML profile

## 6 Common features of UML used to extend concept modelling

### 6.1 General

UML provides a set of special features which can enrich a concept model (see 3.2). The concept model view (see 3.3) can, by means of those features, become more detailed than a common concept diagram, and with those features specified, the conversion to IT models will be safe and avoid both loss of information and need for supplementary input. This clause describes two features which specify certain properties of a concept system: multiplicity (see 3.7) and constraint (see 3.5).

### 6.2 Multiplicity

When modelling associative and partitive relations, it might prove practical to state multiplicity (see 3.7). The ends of an associative or partitive relation symbol can be adorned with their multiplicity, stating how many objects in the extension of the concept at that end can be related to how many objects in the extension of the concept at the other end. The multiplicity could be any range of numbers from 0 to \*, where \* designates any number larger than 1. The notation is “n1..n2”, where n1 is the lower limit of the range and n2 the upper limit of the range. If the occurrences can be only one number, e.g. 0 or 1, only



that number is written. If there is always more than one occurrence, only \* is written. Different series of numbers are allowed and should be separated by commas.

EXAMPLE 1 “0”, “1”, “5”, “0..1”, “0..\*”, “1..\*”, “3..\*”, “10..15”, “\*”, “0..3, 8, 11..\*”.

EXAMPLE 2 A bicycle has two wheels; a wheel does not have to be mounted on a bicycle and cannot be mounted on more than one bicycle at a time (see [Figure 19](#)).

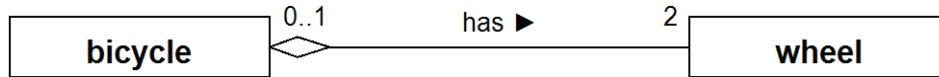


Figure 19 — Multiplicity in partitive relations

EXAMPLE 3 A book has to be written by at least one author and can be written by several authors. An author does not have to write books (can be a playwright or journalist) but can of course write more than one book (see [Figure 20](#)).

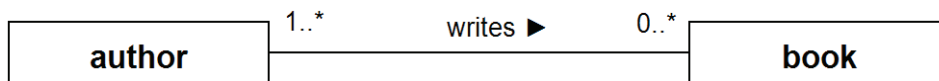


Figure 20 — Multiplicity in associative relations

### 6.3 Constraint

A constraint (see [3.5](#)) represents a delimiting rule for an element or a set of elements in a concept model. One concept can be associated to two other concepts, but only one of the relations can be present at a time. Such a constraint is an “{xor}” constraint (ISO/IEC 19505-2:2012, 7.3.10; see [Figures 21](#) and [22](#)). A generic relation can be complete, meaning that there is no possibility that more specific concepts occur than those depicted. It can be incomplete, stating that there are or can be more specific concepts which are not depicted. This corresponds to the notation in a concept diagram where one or several specific concepts not depicted are shown as “...” in ISO 704.

Equally, a partitive relation can be complete or incomplete, the first alternative meaning that all partitive concepts making up the comprehensive concept are shown.

A constraint (see [3.5](#)) is modelled using a dashed line in either of two ways. One is within curly brackets {constraint}, and the other is as a note symbol connected to the model element or model elements which it constrains. Both notations shown in [Figures 21](#) and [22](#) mean that only one of the two associative relations can be present.

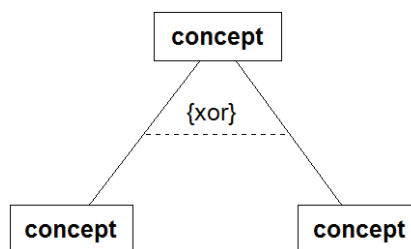


Figure 21 — Constraint between associative relations, notation option 1

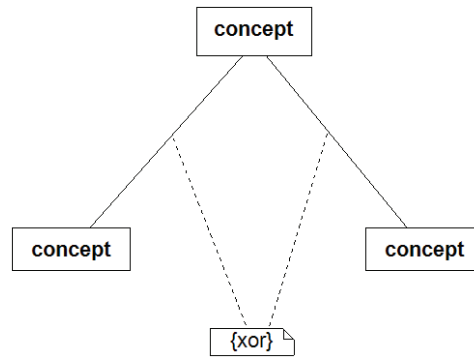


Figure 22 — Constraint between associative relations, notation option 2

## Annex A (informative)

### Table of correspondence between ISO 1087-1 concepts and their adopted symbols in the ISO 24156-1 user-defined UML profile

This part of ISO 24156 suggests the use of UML modelling elements for the representation of concepts and concept systems. [Table A.1](#) below lists a set of concepts from ISO 1087-1 and their corresponding symbols in our user-defined UML profile. Concepts in ISO 1087-1 which are not listed have no corresponding representation or have not been discussed above. For example, different kinds of associative relations are not represented by different kinds of UML elements. Instead, the UML association can be named in such a way that the kind of associative relation is clarified.

Table A.1 — Table of correspondence between ISO 1087-1 concepts and their adopted symbols in the ISO 24156-1 user-defined UML profile


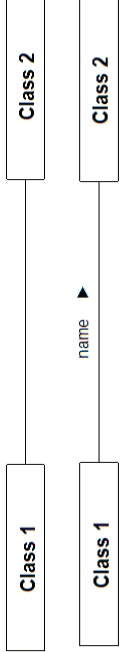
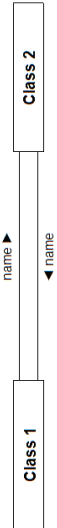
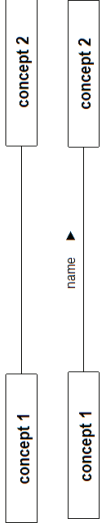
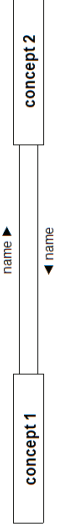
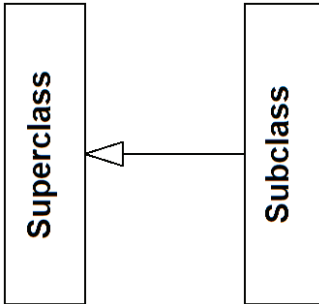
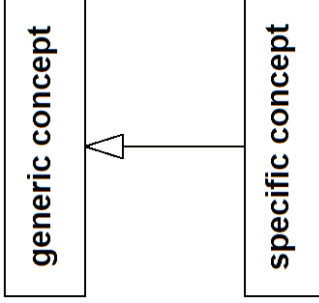
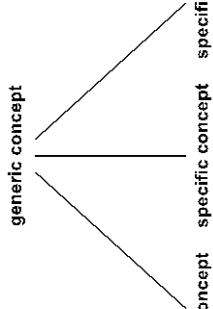
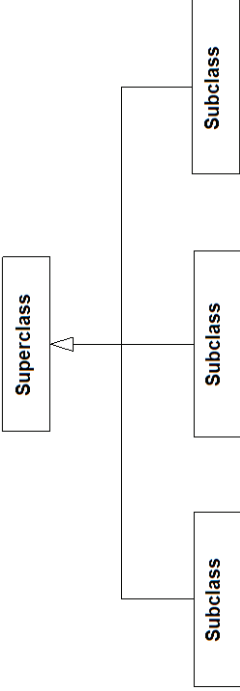
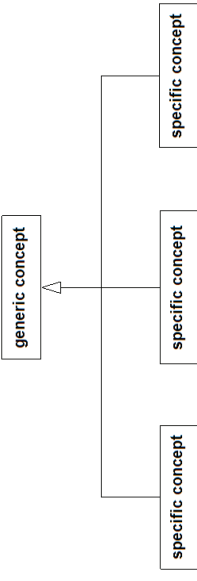

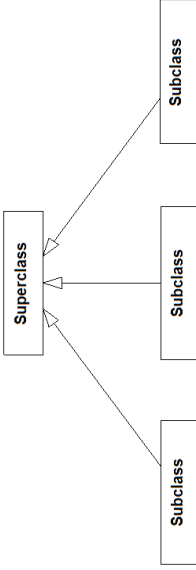
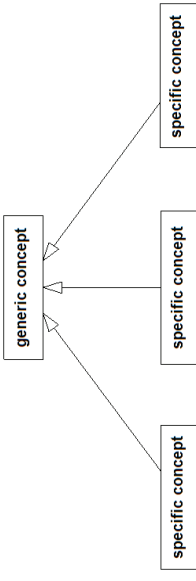

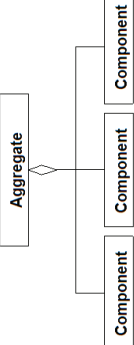
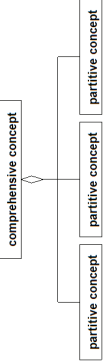

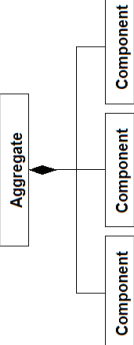
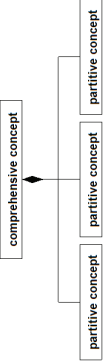
<p>ISO 1087-1</p> <p>associative relation</p>  <p>concept 1 ↔ concept 2</p>	<p>UML (ISO/IEC 19505-2)</p> <p>association</p>  <p>Class 1 — name ▶ Class 2</p> <p>multiple association</p>  <p>Class 1 — name ▶ ◀ name Class 2</p>	<p>ISO 24156-1 user-defined UML profile</p> <p>associative relation</p>  <p>concept 1 — name ▶ concept 2</p> <p>multiple associative relation</p>  <p>concept 1 — name ▶ ◀ name concept 2</p>
<p>concept and characteristics</p> <p>Note: General and individual concepts are represented in the same way.</p>	<p><b>Class</b></p> <p>attribute 1 = value 1.1 attribute 2 = value 2.1</p>	<p><b>Concept</b></p> <p>attribute 1 = value 1.1 attribute 2 = value 2.1</p>
<p>designation</p>	<p>class name</p> <p><b>ClassName</b></p>	<p>designation</p> <p><b>designation</b></p>
<p>generic relation (single)</p> <p><b>generic concept</b></p> <p>_____</p> <p><b>specific concept</b></p>	<p>generalization</p>  <p><b>Superclass</b> ← <b>Subclass</b></p>	<p>generic relation</p>  <p><b>generic concept</b> ← <b>specific concept</b></p>

Table A.1 (continued)

<p>ISO 1087-1</p> <p>generic relation (multiple)</p>  <p>generic concept</p> <p>specific concept</p> <p>specific concept</p> <p>specific concept</p>	<p>UML (ISO/IEC 19505-2)</p> <p>generalization (shared target style)</p>  <p>Superclass</p> <p>Subclass</p> <p>Subclass</p> <p>Subclass</p>	<p>ISO 24156-1 user-defined UML profile</p> <p>generic relation (shared target style)</p>  <p>generic concept</p> <p>specific concept</p> <p>specific concept</p> <p>specific concept</p>
<p>partitive relation</p>  <p>comprehensive concept</p> <p>partitive concept</p> <p>partitive concept</p>	<p>generalization (separate target style)</p>  <p>Superclass</p> <p>Subclass</p> <p>Subclass</p> <p>Subclass</p>	<p>generic relation (separate target style)</p>  <p>generic concept</p> <p>specific concept</p> <p>specific concept</p> <p>specific concept</p>
<p>partitive relation</p>  <p>comprehensive concept</p> <p>partitive concept</p> <p>partitive concept</p>	<p>aggregation</p>  <p>Aggregate</p> <p>Component</p> <p>Component</p>	<p>partitive relation (aggregation)</p>  <p>comprehensive concept</p> <p>partitive concept</p> <p>partitive concept</p>
<p>partitive relation</p>  <p>comprehensive concept</p> <p>partitive concept</p> <p>partitive concept</p>	<p>composition</p>  <p>Aggregate</p> <p>Component</p> <p>Component</p>	<p>partitive relation (composition)</p>  <p>comprehensive concept</p> <p>partitive concept</p> <p>partitive concept</p>

## Bibliography

- [1] ISO 690, *Information and documentation — Guidelines for bibliographic references and citations to information resources*
- [2] ISO/TC 37/SC 1 N 446 (Document prepared by Hanne Erdman Thomsen for ISO/TC 37/WG 3 at the Bogotá annual TC 37 workshop)
- [3] KOCKAERT H., STEURS F., ANTIA B. . In: BHREATHNACH U., & de BARRA CUSACK F. (eds.) TKE 2010: Presenting Terminology and Knowledge Engineering Resources Online: Models and Challenges. TKE 2010, Dublin, 2010, pp. 437–56.
- [4] MADSEN B.N., THOMSEN H.E, VIKNER C. . In: MADSEN B.N., & THOMSEN H.E (eds.) Terminology and content development, Copenhagen: Litera, 2005, pp. 161-174
- [5] MADSEN B.N., & THOMSEN H.E. Terminological Concept Modeling and UML Diagrams. *International Journal of Metadata. Semantics and Ontologies*. 2009, 4 pp. 239–249
- [6] OGDEN C.K., & RICHARDS I.A. *The Meaning of Meaning*. London: Routledge and Kegan Paul, 1923
- [7] SAVINOV A. Concepts and Concept-Oriented Programming. *Journal of Object Technology*. 2008, 7 () pp. 91–106
- [8] SKUCE D., & MEYER I. Concept Analysis and Terminology: a Knowledge-based Approach to Documentation. *Proceedings of the 13th Conference on Computational Linguistics*. 1990, 1: 51-58
- [9] TEMMERMAN R. *Towards New Ways of Terminology Description: The sociocognitive approach*. Amsterdam, Philadelphia: Benjamins, 2000
- [10] WÜSTER E. (Original work published 1979) *Einführung in die allgemeine Terminologielehre und terminologische Lexikographie*. LSP Centre, Copenhagen School of Economics, Copenhagen, 1985



