

---

---

**Space data and information transfer  
systems — Proximity-1 space link  
protocol — Data link layer**

*Systèmes de transfert des informations et données spatiales —  
Protocole pour liaisons spatiales de proximité 1 — Couche de liaisons  
de données*



Reference number  
ISO 22663:2007(E)

© ISO 2007

**PDF disclaimer**

This PDF file may contain embedded typefaces. In accordance with Adobe's licensing policy, this file may be printed or viewed but shall not be edited unless the typefaces which are embedded are licensed to and installed on the computer performing the editing. In downloading this file, parties accept therein the responsibility of not infringing Adobe's licensing policy. The ISO Central Secretariat accepts no liability in this area.

Adobe is a trademark of Adobe Systems Incorporated.

Details of the software products used to create this PDF file can be found in the General Info relative to the file; the PDF-creation parameters were optimized for printing. Every care has been taken to ensure that the file is suitable for use by ISO member bodies. In the unlikely event that a problem relating to it is found, please inform the Central Secretariat at the address given below.



**COPYRIGHT PROTECTED DOCUMENT**

© ISO 2007

All rights reserved. Unless otherwise specified, no part of this publication may be reproduced or utilized in any form or by any means, electronic or mechanical, including photocopying and microfilm, without permission in writing from either ISO at the address below or ISO's member body in the country of the requester.

ISO copyright office  
Case postale 56 • CH-1211 Geneva 20  
Tel. + 41 22 749 01 11  
Fax + 41 22 749 09 47  
E-mail [copyright@iso.org](mailto:copyright@iso.org)  
Web [www.iso.org](http://www.iso.org)

Published in Switzerland

## Foreword

ISO (the International Organization for Standardization) is a worldwide federation of national standards bodies (ISO member bodies). The work of preparing International Standards is normally carried out through ISO technical committees. Each member body interested in a subject for which a technical committee has been established has the right to be represented on that committee. International organizations, governmental and non-governmental, in liaison with ISO, also take part in the work. ISO collaborates closely with the International Electrotechnical Commission (IEC) on all matters of electrotechnical standardization.

International Standards are drafted in accordance with the rules given in the ISO/IEC Directives, Part 2.

The main task of technical committees is to prepare International Standards. Draft International Standards adopted by the technical committees are circulated to the member bodies for voting. Publication as an International Standard requires approval by at least 75 % of the member bodies casting a vote.

Attention is drawn to the possibility that some of the elements of this document may be the subject of patent rights. ISO shall not be held responsible for identifying any or all such patent rights.

ISO 22663 was prepared by Technical Committee ISO/TC 20, *Aircraft and space vehicles*, Subcommittee SC 13, *Space data and information transfer systems*.

This second edition cancels and replaces the first edition (ISO 22663:2006), which has been technically revised.

ISO 22663 was prepared by the Consultative Committee for Space Data Systems (CCSDS) (as CCSDS 211.0-B-4, July 2006) and was adopted (without modifications except those stated in Clause 2 of this International Standard) by Technical Committee ISO/TC 20, *Aircraft and space vehicles*, Subcommittee SC 13, *Space data and information transfer systems*.

© 2010 International Organization for Standardization

# Space data and information transfer systems — Proximity-1 space link protocol — Data link layer

## 1 Scope

This International Standard defines the Proximity-1 space link protocol data link layer (framing, media access, data services, and input-output sublayers). It specifies the protocol data units, framing, media access control, expedited and sequenced controlled data transfer, timing service, i/o control, as well as the procedures for establishing and terminating a session between a caller and responder. The coding and synchronization sublayer is defined in ISO 21459. The physical layer is defined in ISO 21460.

This International Standard does not specify

- a) individual implementations or products;
- b) implementation of service interfaces within real systems;
- c) the methods or technologies required to perform the procedures; or
- d) the management activities required to configure and control the protocol.

The scope and field of application are furthermore detailed in subclause 1.3 of the enclosed CCSDS publication.

## 2 Requirements

Requirements are the technical recommendations made in the following publication (reproduced on the following pages), which is adopted as an International Standard:

CCSDS 211.0-B-4, July 2006, *Proximity-1 space link protocol — Data link layer*.

For the purposes of international standardization, the modifications outlined below shall apply to the specific clauses and paragraphs of publication CCSDS 211.0-B-4.

*Pages i to v*

This part is information which is relevant to the CCSDS publication only.

*Page 1-6*

Add the following information to the reference indicated:

- [2] Document CCSDS 232.1-B-1, September 2003, is equivalent to ISO 22667:2005.
- [3] Document CCSDS 232.0-B-1, September 2003, is equivalent to ISO 22664:2005.
- [4] Document CCSDS 132.0-B-1, September 2003, is equivalent to ISO 22645:2005.
- [5] Document CCSDS 131.0-B-1, September 2003, is equivalent to ISO 22641:2005.

Add the following information to the reference indicated:

- [7] Document CCSDS 301.0-B-3, January 2002, is equivalent to ISO 11104:2003.
- [8] Document CCSDS 211.2-B-1, April 2003, is equivalent to ISO 21459:2006.
- [9] Document CCSDS 211.1-B-3, March 2006, is equivalent to ISO 21460:2007.

### **3 Revision of publication CCSDS 211.0-B-4**

It has been agreed with the Consultative Committee for Space Data Systems that Subcommittee ISO/TC 20/SC 13 will be consulted in the event of any revision or amendment of publication CCSDS 211.0-B-4. To this end, NASA will act as a liaison body between CCSDS and ISO.

## Recommendation for Space Data System Standards

**PROXIMITY-1 SPACE LINK PROTOCOL—  
DATA LINK LAYER**

**RECOMMENDED STANDARD**

**CCSDS 211.0-B-4**

**BLUE BOOK**

**July 2006**

Blank page

## CCSDS RECOMMENDED STANDARD FOR PROXIMITY-1 SPACE DATA LINK PROTOCOL

**AUTHORITY**

Issue:	Blue Book, Issue 4
Date:	July 2006
Location:	Washington, DC, USA

This document has been approved for publication by the Management Council of the Consultative Committee for Space Data Systems (CCSDS) and represents the consensus technical agreement of the participating CCSDS Member Agencies. The procedure for review and authorization of CCSDS Recommendations is detailed in *Procedures Manual for the Consultative Committee for Space Data Systems*, and the record of Agency participation in the authorization of this document can be obtained from the CCSDS Secretariat at the address below.

This Recommendation is published and maintained by:

CCSDS Secretariat  
Office of Space Communication (Code M-3)  
National Aeronautics and Space Administration  
Washington, DC 20546, USA

## STATEMENT OF INTENT

The Consultative Committee for Space Data Systems (CCSDS) is an organization officially established by the management of member space Agencies. The Committee meets periodically to address data systems problems that are common to all participants, and to formulate sound technical solutions to these problems. Inasmuch as participation in the CCSDS is completely voluntary, the results of Committee actions are termed **Recommendations** and are not considered binding on any Agency.

This **Recommendation** is issued by, and represents the consensus of, the CCSDS Plenary body. Agency endorsement of this **Recommendation** is entirely voluntary. Endorsement, however, indicates the following understandings:

- Whenever an Agency establishes a CCSDS-related **standard**, this **standard** will be in accord with the relevant **Recommendation**. Establishing such a **standard** does not preclude other provisions which an Agency may develop.
- Whenever an Agency establishes a CCSDS-related standard, the Agency will provide other CCSDS member Agencies with the following information:
  - The **standard** itself.
  - The anticipated date of initial operational capability.
  - The anticipated duration of operational service.
- Specific service arrangements are made via memoranda of agreement. Neither this Recommendation nor any ensuing standard is a substitute for a memorandum of agreement.

No later than five years from its date of issuance, this **Recommendation** will be reviewed by the CCSDS to determine whether it should: (1) remain in effect without change; (2) be changed to reflect the impact of new technologies, new requirements, or new directions; or, (3) be retired or canceled.

In those instances when a new version of a **Recommendation** is issued, existing CCSDS-related Agency standards and implementations are not negated or deemed to be non-CCSDS compatible. It is the responsibility of each Agency to determine when such standards or implementations are to be modified. Each Agency is, however, strongly encouraged to direct planning for its new standards and implementations towards the later version of the Recommendation.

## CCSDS RECOMMENDED STANDARD FOR PROXIMITY-1 SPACE DATA LINK PROTOCOL

**FOREWORD**

Through the process of normal evolution, it is expected that expansion, deletion, or modification of this document may occur. This Recommendation is therefore subject to CCSDS document management and change control procedures which are defined in the *Procedures Manual for the Consultative Committee for Space Data Systems*. Current versions of CCSDS documents are maintained at the CCSDS Web site:

<http://www.ccsds.org/>

Questions relating to the contents or status of this document should be addressed to the CCSDS Secretariat at the address indicated on page i.

At time of publication, the active Member and Observer Agencies of the CCSDS were:

Member Agencies

- Agenzia Spaziale Italiana (ASI)/Italy.
- British National Space Centre (BNSC)/United Kingdom.
- Canadian Space Agency (CSA)/Canada.
- Centre National d'Etudes Spatiales (CNES)/France.
- Deutsches Zentrum für Luft- und Raumfahrt e.V. (DLR)/Germany.
- European Space Agency (ESA)/Europe.
- Federal Space Agency (Roskosmos)/Russian Federation.
- Instituto Nacional de Pesquisas Espaciais (INPE)/Brazil.
- Japan Aerospace Exploration Agency (JAXA)/Japan.
- National Aeronautics and Space Administration (NASA)/USA.

Observer Agencies

- Austrian Space Agency (ASA)/Austria.
- Belgian Federal Science Policy Office (BFSP0)/Belgium.
- Central Research Institute of Machine Building (TsNIIMash)/Russian Federation.
- Centro Tecnico Aeroespacial (CTA)/Brazil.
- Chinese Academy of Space Technology (CAST)/China.
- Commonwealth Scientific and Industrial Research Organization (CSIRO)/Australia.
- Danish Space Research Institute (DSRI)/Denmark.
- European Organization for the Exploitation of Meteorological Satellites (EUMETSAT)/Europe.
- European Telecommunications Satellite Organization (EUTELSAT)/Europe.
- Hellenic National Space Committee (HNSC)/Greece.
- Indian Space Research Organization (ISRO)/India.
- Institute of Space Research (IKI)/Russian Federation.
- KFKI Research Institute for Particle & Nuclear Physics (KFKI)/Hungary.
- Korea Aerospace Research Institute (KARI)/Korea.
- MIKOMTEK: CSIR (CSIR)/Republic of South Africa.
- Ministry of Communications (MOC)/Israel.
- National Institute of Information and Communications Technology (NICT)/Japan.
- National Oceanic & Atmospheric Administration (NOAA)/USA.
- National Space Organization (NSPO)/Taipei.
- Space and Upper Atmosphere Research Commission (SUPARCO)/Pakistan.
- Swedish Space Corporation (SSC)/Sweden.
- United States Geological Survey (USGS)/USA.

## CCSDS RECOMMENDED STANDARD FOR PROXIMITY-1 SPACE DATA LINK PROTOCOL

**DOCUMENT CONTROL**

<b>Document</b>	<b>Title and Issue</b>	<b>Date</b>	<b>Status</b>
CCSDS 211.0-B-1	Proximity-1 Space Link Protocol	October 2002	Superseded
CCSDS 211.0-B-2	Proximity-1 Space Link Protocol— Data Link Layer	April 2003	Superseded
CCSDS 211.0-B-3	Proximity-1 Space Link Protocol— Data Link Layer	May 2004	Superseded
CCSDS 211.0-B-4	Proximity-1 Space Link Protocol— Data Link Layer, Recommended Standard, Issue 4	July 2006	Current Issue: <ul style="list-style-type: none"> <li>– modifies rules for frame selection prioritization,</li> <li>– adds CARRIER ONLY RECEIVED condition to state tables and to annex D Notifications to Vehicle Controller,</li> <li>– clarifies some terminology.</li> </ul>

NOTE – Changes from the previous issue are flagged by change bars in the inside margin.

**CONTENTS**

<u>Section</u>	<u>Page</u>
<b>1 INTRODUCTION</b> .....	<b>1-1</b>
1.1 PURPOSE.....	1-1
1.2 SCOPE.....	1-1
1.3 APPLICABILITY.....	1-1
1.4 RATIONALE.....	1-2
1.5 CONVENTIONS AND DEFINITIONS.....	1-2
1.6 REFERENCES.....	1-6
<b>2 OVERVIEW</b> .....	<b>2-1</b>
2.1 CONCEPT OF PROXIMITY-1.....	2-1
2.2 OVERVIEW OF SERVICES.....	2-6
<b>3 PROTOCOL DATA UNITS</b> .....	<b>3-1</b>
3.1 CONTEXT OF THE VERSION-3 TRANSFER FRAME.....	3-1
3.2 VERSION-3 TRANSFER FRAME.....	3-1
<b>4 DATA LINK LAYER</b> .....	<b>4-1</b>
4.1 FRAME SUBLAYER.....	4-1
4.2 MEDIUM ACCESS CONTROL (MAC) SUBLAYER.....	4-2
4.3 DATA SERVICES SUBLAYER.....	4-5
4.4 I/O INTERFACE SUBLAYER.....	4-8
<b>5 PROXIMITY-1 TIMING SERVICES</b> .....	<b>5-1</b>
5.1 COUPLED NON-COHERENT PROXIMITY TIMING SERVICE.....	5-1
5.2 PROXIMITY TIME CORRELATION.....	5-1
<b>6 DATA SERVICES OPERATIONS</b> .....	<b>6-1</b>
6.1 OVERVIEW.....	6-1
6.2 PROXIMITY-1 STATE TABLES.....	6-1
6.3 ELEMENTS AND EVENTS THAT AFFECT STATE STATUS.....	6-13
6.4 STATE TRANSITION TABLES AND DIAGRAMS.....	6-18
6.5 SIMPLEX OPERATIONS.....	6-28
6.6 INTERFACES WITH THE PHYSICAL LAYER.....	6-29
6.7 SENDING OPERATIONS.....	6-29
6.8 RECEIVING OPERATIONS.....	6-31

## CCSDS RECOMMENDED STANDARD FOR PROXIMITY-1 SPACE DATA LINK PROTOCOL

**CONTENTS (continued)**

<u>Section</u>	<u>Page</u>
<b>7 COMMUNICATION OPERATIONS PROCEDURE FOR PROXIMITY LINKS (COP-P)</b> .....	<b>7-1</b>
7.1 SENDING PROCEDURES (FOP-P) .....	7-1
7.2 RECEIVING PROCEDURES (FARM-P) .....	7-7
<b>8 INPUT/OUTPUT (I/O) SUBLAYER OPERATIONS</b> .....	<b>8-1</b>
8.1 SENDING OPERATIONS .....	8-1
8.2 RECEIVING OPERATIONS .....	8-2
<b>ANNEX A VARIABLE-LENGTH SUPERVISORY PROTOCOL DATA FIELD FORMATS (Normative)</b> .....	<b>A-1</b>
<b>ANNEX B MANAGEMENT INFORMATION BASE (MIB) PARAMETERS (Normative)</b> .....	<b>B-1</b>
<b>ANNEX C NASA MARS SURVEYOR PROJECT 2001 ODYSSEY ORBITER PROXIMITY SPACE LINK CAPABILITIES (Informative)</b> .....	<b>C-1</b>
<b>ANNEX D NOTIFICATIONS TO VEHICLE CONTROLLER (Normative)</b> .....	<b>D-1</b>
<b>ANNEX E ABBREVIATIONS AND ACRONYMS (Informative)</b> .....	<b>E-1</b>
<b>ANNEX F INFORMATIVE REFERENCES (Informative)</b> .....	<b>F-1</b>

Figure

1-1 Bit Numbering Convention.....	1-6
2-1 Proximity-1 Layered Protocol Model.....	2-4
3-1 Proximity-1 Protocol Data Unit Context Diagram .....	3-1
3-2 Version-3 Transfer Frame.....	3-2
3-3 Transfer Frame Header .....	3-3
3-4 Proximity-1 Transfer Frame Data Field Structure .....	3-7
3-5 Proximity Link Control Word Fields.....	3-12
4-1 COP-P Process.....	4-7
5-1 Proximity Time Tagging and Time Correlation .....	5-3
5-2 Transferring Time to a Remote Asset.....	5-4
6-1 Full Duplex State Transition Diagram.....	6-19
6-2 Half Duplex State Transition Diagram .....	6-23
6-3 Simplex Operations.....	6-28
A-1 Type 1 SPDU Data Field Contents.....	A-2
A-2 SET TRANSMITTER PARAMETERS Directive .....	A-3
A-3 SET CONTROL PARAMETERS Directive .....	A-6
A-4 SET RECEIVER PARAMETERS Directive .....	A-8

**CONTENTS (continued)**

<u>Figure</u>	<u>Page</u>
A-5 SET V(R) Directive .....	A-10
A-6 Report Request.....	A-11
A-7 Proximity Link Control Word .....	A-13
A-8 SET PL EXTENSIONS .....	A-15
A-9 Report Source Spacecraft ID .....	A-19
A-10 Type 2 SPDU Data Field Contents.....	A-20
C-1 NASA Mars Surveyor Project 2001 Odyssey SET TRANSMITTER PARAMETERS Directive .....	C-2
C-2 NASA Mars Surveyor Project 2001 Odyssey SET RECEIVER PARAMETERS Directive .....	C-4
C-3 Proximity Link Control Word Fields.....	C-7

Table

3-1 U-Frame Data Field Construction Rules .....	3-4
3-2 Segment Header Sequence Flags.....	3-8
3-3 Fixed-Length Supervisory Protocol Data Unit.....	3-11
3-4 Variable-Length Supervisory Protocol Data Unit .....	3-14
6-1 Proximity-1 Data Services Operations Roadmap .....	6-1
6-2 States Independent of the DUPLEX Variable .....	6-2
6-3 States When DUPLEX = Full.....	6-3
6-4 States When DUPLEX = Half.....	6-5
6-5 States When DUPLEX = Simplex (receive or transmit) .....	6-6
6-6 Proximity-1 Control Variable Initialization Table.....	6-18
6-7 Full Duplex Session Establishment/Data Services State Transition Table.....	6-20
6-8 Full Duplex Communication Change State Table .....	6-21
6-9 Full Duplex Session Termination State Table .....	6-22
6-10 Half Duplex Session Establishment and Data Services.....	6-23
6-11 Half Duplex Communication Change State Table .....	6-26
6-12 Half Duplex Session Termination State Table .....	6-27
6-13 Simplex State Transition Table.....	6-28
6-14 Data Source Selection for Output Bit Stream with TRANSMIT = <i>on</i> and MODULATION = <i>on</i> .....	6-30

## 1 INTRODUCTION

### 1.1 PURPOSE

The purpose of this document is to provide a Recommendation for Space Data System Standards in the area of Proximity space links. Proximity space links are defined to be short-range, bi-directional, fixed or mobile radio links, generally used to communicate among probes, landers, rovers, orbiting constellations, and orbiting relays. These links are characterized by short time delays, moderate (not weak) signals, and short, independent sessions.

### 1.2 SCOPE

This Recommendation defines the Data Link layer (framing, media access, data services, and input-output sublayers). The specifications for the protocol data units, framing, media access control, expedited and sequenced controlled data transfer, timing service, i/o control as well as the procedures for establishing and terminating a session between a caller and responder are defined in this document. The Coding and Synchronization sublayer is defined in the separate CCSDS recommendation entitled, *Proximity-1 Space Link Protocol—Coding and Synchronization Sublayer*; see reference [8]. The Physical layer is defined in the separate CCSDS recommendation entitled, *Proximity-1 Space Link Protocol—Physical Layer*; see reference [9].

This Recommendation does not specify a) individual implementations or products, b) implementation of service interfaces within real systems, c) the methods or technologies required to perform the procedures, or d) the management activities required to configure and control the protocol.

### 1.3 APPLICABILITY

This Recommendation applies to the creation of Agency standards and to future data communications over space links between CCSDS Agencies in cross-support situations. It applies also to internal Agency links where no cross-support is required. It includes specification of the services and protocols for inter-Agency cross support. It is neither a specification of, nor a design for, systems that may be implemented for existing or future missions.

The Recommendation specified in this document is to be invoked through the normal standards programs of each CCSDS Agency and is applicable to those missions for which cross support based on capabilities described in this Recommendation is anticipated. Where mandatory capabilities are clearly indicated in sections of the Recommendation, they must be implemented when this document is used as a basis for cross support. Where options are allowed or implied, implementation of these options is subject to specific bilateral cross support agreements between the Agencies involved.

## 1.4 RATIONALE

The CCSDS believes it is important to document the rationale underlying the recommendations chosen, so that future evaluations of proposed changes or improvements will not lose sight of previous decisions. Concept and rationale behind the decisions that formed the basis for Proximity-1 will be documented in the CCSDS Proximity-1 Space Link Green Book, which is under development.

## 1.5 CONVENTIONS AND DEFINITIONS

### 1.5.1 DEFINITIONS

#### 1.5.1.1 Definitions from the Open Systems Interconnection (OSI) Basic Reference Model

This Recommendation makes use of a number of terms defined in reference [1]. The use of those terms in this Recommendation shall be understood in a generic sense, i.e., in the sense that those terms are generally applicable to any of a variety of technologies that provide for the exchange of information between real systems. Those terms are as follows:

- a) connection;
- b) Data Link layer;
- c) entity;
- d) physical layer;
- e) protocol control information;
- f) Protocol Data Unit (PDU);
- g) real system;
- h) segmenting;
- i) service;
- j) Service Access Point (SAP);
- k) SAP address;
- l) Service Data Unit (SDU).

#### 1.5.1.2 Terms Defined in This Recommendation

For the purposes of this Recommendation, the following definitions also apply. Many other terms that pertain to specific items are defined in the appropriate sections.

## CCSDS RECOMMENDED STANDARD FOR PROXIMITY-1 SPACE DATA LINK PROTOCOL

**asynchronous channel:** a data channel where the symbol data are modulated onto the channel only for the period of the message. The message must be preceded by an acquisition sequence to achieve symbol synchronization. Bit synchronization must be reacquired on every message. A hailing channel is an example of an asynchronous channel.

**asynchronous data link:** a data link consisting of a sequence of variable-length Proximity Link Transmission Units (PLTUs), which are not necessarily concatenated. Two types of asynchronous data links are:

1) Asynchronous Data Link over an Asynchronous Channel

Hailing provides an example of an asynchronous data link over an asynchronous channel. An important issue is resynchronization between successive hails. Idle is provided for the reacquisition process.

2) Asynchronous Data Link over a Synchronous Channel

Data service provides an example of an asynchronous data link over a synchronous channel. Once the link is established via hailing, communication transitions to a synchronous channel and maintains the link in this configuration until the session is interrupted or ends. If the physical layer does not receive data from the data link layer, it provides idle to maintain a synchronous channel.

**caller and responder:** A **caller transceiver** is the initiator of the link establishment process and manager of negotiation (if required) of the session. A **responder transceiver** typically receives link establishment parameters from the caller. The caller initiates communication between itself and a responder on a pre-arranged communications channel with predefined controlling parameters. As necessary, the caller and responder may negotiate the controlling parameters for the session (at some level between fully controlled and completely adaptive).

**COP-P:** Communication Operations Procedure for Proximity links (COP-P). The COP-P includes both the FARM-P and FOP-P of the caller and responder unit.

**FARM-P:** Frame Acceptance and Reporting Mechanism for Proximity links, for Sequence Controlled service carried out within the receiver in the Proximity-1 link.

**FOP-P:** Frame Operation Procedure for Proximity links for ordering the output frames for Sequence Controlled service carried out in the transmitter in the Proximity-1 link.

**forward link:** that portion of a Proximity space link in which the caller transmits and the responder receives (typically a command link).

**hailing:** the persistent activity used to establish a Proximity link by a caller to a responder in either full or half duplex. It does not apply to simplex operations.

**hailing channel:** the forward and return frequency pairs that a caller and responder use to establish physical link communications.

**mission phase:** a mission period during which specified communications characteristics are fixed. The transition between two consecutive mission phases may cause an interruption of the communications services.

**PCID:** The Physical Channel ID is used to distinguish between Proximity Link Control Words (PLCWs) received on a single receive channel in support of two independent transmitting channels.

**P-frame:** a Version-3 Transfer Frame that contains only self-identified and self-delimited supervisory protocol data units; compare U-frame.

**physical channel:** The RF channel upon which the stream of bits is transferred over a space link in a single direction.

**PLCW:** Proximity Link Control Word. The PLCW is the protocol data unit for reporting Sequence Controlled service status via the return link from the responder back to the caller.

**PLTU:** The Proximity Link Transmission Unit is the data unit composed of the Attached Synchronization Marker, the Version-3 Transfer Frame, and the attached Cyclic Redundancy Check (CRC)-32.

**Protocol object:** directives, PLCWs, or status reports contained within an SPDU.

**Proximity link:** short-range, bi-directional, fixed or mobile radio links, generally used to communicate among probes, landers, rovers, orbiting constellations, and orbiting relays. These links are characterized by short time delays, moderate (not weak) signals, and short, independent sessions.

**pseudo packet ID:** the temporary packet ID assigned by the protocol to a user's packet within the segmentation process.

**resynchronization (COP-P):** process in which sender and receiver nodes readjust their sequence controlled frame numbers via the SET V(R) activity.

**return link:** that portion of a Proximity space link in which the responder transmits and the caller receives (typically a telemetry link).

**Routing ID:** identifier that uniquely identifies a user's packet through the segmentation process. It consists of a PCID, Port ID, and pseudo packet ID.

**Sent queue (Sent Frame queue):** contains sequence controlled frames that have been sent but not yet acknowledged by the receiver.

## CCSDS RECOMMENDED STANDARD FOR PROXIMITY-1 SPACE DATA LINK PROTOCOL

**session:** a continuous dialog between two communicating Proximity link transceivers. It consists of three distinct operational phases: session establishment, data services, and session termination.

**space link:** a communications link between transmitting and receiving entities, at least one of which is in space.

**SPDU:** Supervisory Protocol Data Unit. Used by the local transceiver to either control or report status to the remote partnered transceiver. Consists of one or more directives, reports, or PLCWs.

**synchronous channel:** a data channel where the symbol data are continuously modulated onto the channel at a fixed data rate. If the data link fails to provide frames (data or fill), it is the responsibility of the physical layer to provide the continuous bit stream.

**U-frame:** a Version-3 Transfer Frame that contains user data information; compare P-frame.

**vehicle controller:** the entity (e.g., spacecraft control computer) which receives the notifications defined in annex E and potentially acts upon them.

**Version-3 Transfer Frame:** a Proximity-1 transfer frame.

### 1.5.2 NOMENCLATURE

The following conventions apply throughout this Recommendation:

- a) the words 'shall' and 'must' imply a binding and verifiable specification;
- b) the word 'should' implies an optional, but desirable, specification;
- c) the word 'may' implies an optional specification;
- d) the words 'is', 'are', and 'will' imply statements of fact.

### 1.5.3 CONVENTIONS

In this document, the following convention is used to identify each bit in an  $N$ -bit field. The first bit in the field to be transmitted (i.e., the most left justified when drawing a figure) is defined to be 'Bit 0'; the following bit is defined to be 'Bit 1' and so on up to 'Bit  $N-1$ '. When the field is used to express a binary value (such as a counter), the Most Significant Bit (MSB) shall be the first transmitted bit of the field, i.e., 'Bit 0', as shown in figure 1-1.

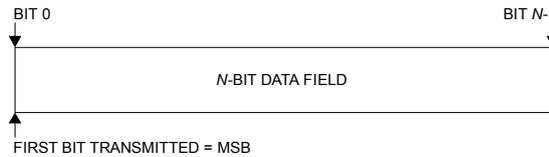

**Figure 1-1: Bit Numbering Convention**

In accordance with standard data-communications practice, data fields are often grouped into 8-bit ‘words’ that conform to the above convention. Throughout this Recommendation, such an 8-bit word is called an ‘octet’.

The numbering for octets within a data structure begins with zero. Octet zero is the first octet to be transmitted.

By CCSDS convention, all ‘spare’ bits shall be permanently set to value ‘zero’.

Throughout this Recommendation, directive, parameter, variable, and signal names are presented with all upper-case characters; data-field and MIB-parameter names are presented with initial capitalization; values and state names are presented with predominantly lower-case characters, and are italicized.

## 1.6 REFERENCES

The following documents contain provisions which, through reference in this text, constitute provisions of this Recommendation. At the time of publication, the editions indicated were valid. All documents are subject to revision, and users of this Recommendation are encouraged to investigate the possibility of applying the most recent editions of the documents indicated below. The CCSDS Secretariat maintains a register of currently valid CCSDS Recommendations.

- [1] *Information Technology—Open Systems Interconnection—Basic Reference Model: The Basic Model*. International Standard, ISO/IEC 7498-1. 2nd ed. Geneva: ISO, 1994.
- [2] *Communications Operation Procedure-1*. Recommendation for Space Data System Standards, CCSDS 232.1-B-1. Blue Book. Issue 1. CCSDS, September 2003.
- [3] *TC Space Data Link Protocol*. Recommendation for Space Data Systems Standards, CCSDS 232.0-B-1. Blue Book. Issue 1. CCSDS, September 2003.
- [4] *TM Space Data Link Protocol*. Recommendation for Space Data System Standards, CCSDS 132.0-B-1. Blue Book. Issue 1. CCSDS, September 2003.
- [5] *TM Synchronization and Channel Coding*. Recommendation for Space Data System Standards, CCSDS 131.0-B-1. Blue Book. Issue 1. CCSDS, September 2003.

## CCSDS RECOMMENDED STANDARD FOR PROXIMITY-1 SPACE DATA LINK PROTOCOL

- [6] *CCSDS Global Spacecraft Identification Field Code Assignment Control Procedures*. Recommendation for Space Data System Standards, CCSDS 320.0-B-3. Blue Book. Issue 3. Washington, D.C.: CCSDS, April 2003.
- [7] *Time Code Formats*. Recommendation for Space Data System Standards, CCSDS 301.0-B-3. Blue Book. Issue 3. Washington, D.C.: CCSDS, January 2002.
- [8] *Proximity-1 Space Link Protocol: Coding and Synchronization Sublayer*. Recommendation for Space Data System Standards, CCSDS 211.2-B-1. Blue Book. Issue 1. Washington, D.C.: CCSDS, April 2003.
- [9] *Proximity-1 Space Link Protocol—Physical Layer*. Recommendation for Space Data System Standards, CCSDS 211.1-B-3. Blue Book. Issue 3. Washington, D.C.: CCSDS, March 2006.

Blank page

## 2 OVERVIEW

### 2.1 CONCEPT OF PROXIMITY-1

#### 2.1.1 LAYERED MODEL

Proximity-1 is a bi-directional Space Link layer protocol to be used by space missions. It consists of a Physical layer (reference [9]), a Coding and Synchronization sublayer (reference [8]) and a Data Link layer. This protocol has been designed to meet the requirements of space missions for efficient transfer of space data over various types and characteristics of Proximity space links. On the send side, the Data Link layer is responsible for providing data to be transmitted by the Coding and Synchronization sublayer and Physical layer. The operation of the transmitter is state-driven. On the receive side, the Data Link layer accepts the serial data output from the receiver and processes the protocol data units received. It accepts directives both from the local vehicle controller and across the Proximity link to control its operations. Once the receiver is turned on, its operation is modeless. It accepts and processes all valid local and remote directives and received service data units.

The layered model consists of two layers (Physical and Data Link) and has five component sublayers within the Data Link layer:

- a) Physical Layer
  - 1) On the send side:
    - i) provides an Output Bit Clock to the Coding & Synchronization sublayer in order to receive the Output Bitstream;
    - ii) provides status i.e., Carrier\_Acquired and Bit\_In\_Lock\_Status signals to the Media Access Control sublayer.
  - 2) On the receive side: Provides the Received Bit Clock/Data to the Coding & Synchronization sublayer.
- b) Coding and Synchronization Sublayer. The C&S sublayer includes PLTU delimiting and verification procedures. In addition this sublayer performs as follows:
  - 1) On the send side:
    - i) includes pre-pending Version-3 frames with the required Attached Synchronization Marker (ASM);
    - ii) includes addition of CRC-32 to PLTUs.
  - 2) On both the send and receive sides: Captures the value of the clock used for time correlation process.

- c) Frame Sublayer. The Frame sublayer includes frame validation procedures, such as transfer frame header checks, and supervisory data processing for supervisory frames. In addition, this sublayer performs as follows:
  - 1) On the send side:
    - i) encapsulates the Input/Output (I/O) sublayer–provided User Data (SDUs) into Version-3 frames;
    - ii) prioritizes and multiplexes the frames for output via the C&S sublayer to the Physical layer for transmission across the link.
  - 2) On the receive side:
    - i) accepts delimited and verified frames from the C&S sublayer;
    - ii) delivers supervisory protocol data units (reports, directives) to the MAC sublayer;
    - iii) passes the user data to the Data Services sublayer;
    - iv) performs a subset of validation checks to ensure that the received data should be further processed.
- d) Medium Access Control Sublayer. The Medium Access Control (MAC) sublayer defines how a session is established, maintained (and how characteristics are modified, e.g., data rate changes), and terminated for point-to-point communications between Proximity entities. This sublayer builds upon the Physical and Data Link layer functionality. The MAC controls the operational state of the Data Link and Physical layers. It accepts and processes Supervisory Protocol Data Units (SPDUs) and provides the various control signals that dictate the operational state. In addition this sublayer:
  - 1) decodes the directives from the local vehicle’s controller (e.g., spacecraft control computer);
  - 2) decodes the directives received via the remote transceiver (extracting and processing SPDUs from the Frame Data Field);
  - 3) stores and distributes the Management Information Base (MIB) parameters (implementation-specific) and status variables;
  - 4) maintains and distributes the state control variables (MODE, TRANSMIT, DUPLEX, see figure 2-1);
  - 5) provides status information to the local vehicle controller.
- e) Data Services Sublayer. The Data Services sublayer defines the Frame Acceptance and Reporting Mechanism for Proximity links (FARM-P) (receive side) and the Frame Operations Procedures for Proximity links (FOP-P) (send side) associated with

## CCSDS RECOMMENDED STANDARD FOR PROXIMITY-1 SPACE DATA LINK PROTOCOL

the Expedited and Sequence Controlled data services including how the FOP-P and FARM-P (COP-P) operate in the Sequence Controlled service.

- f) Input/Output Sublayer. The Input/Output (I/O) interface sublayer provides the interface between the transceiver and the on-board data system and their applications. In addition, this sublayer performs as follows:
- 1) On the receive side:
    - i) accepts received U-frames;
    - ii) extracts the SDUs from U-frames;
    - iii) provides required packet aggregation services;
    - iv) routes SDUs to data service users via the specified Port ID.
  - 2) On the send side: accepts local user-provided SDUs and associated routing and control information (SCID, PCID, Source-or-Destination ID, QOS, Port ID):
    - i) aggregates these SDUs as required to form U-frame data fields;
    - ii) provides required packet segmentation services;
    - iii) delivers these U-frame data fields to the Data Services sublayer;
    - iv) delivers acknowledgements to spacecraft vehicle controller for SDUs delivered via Sequence Controlled service.

The interactions of the Proximity-1 layers and associated data and control flows are shown in figure 2-1.

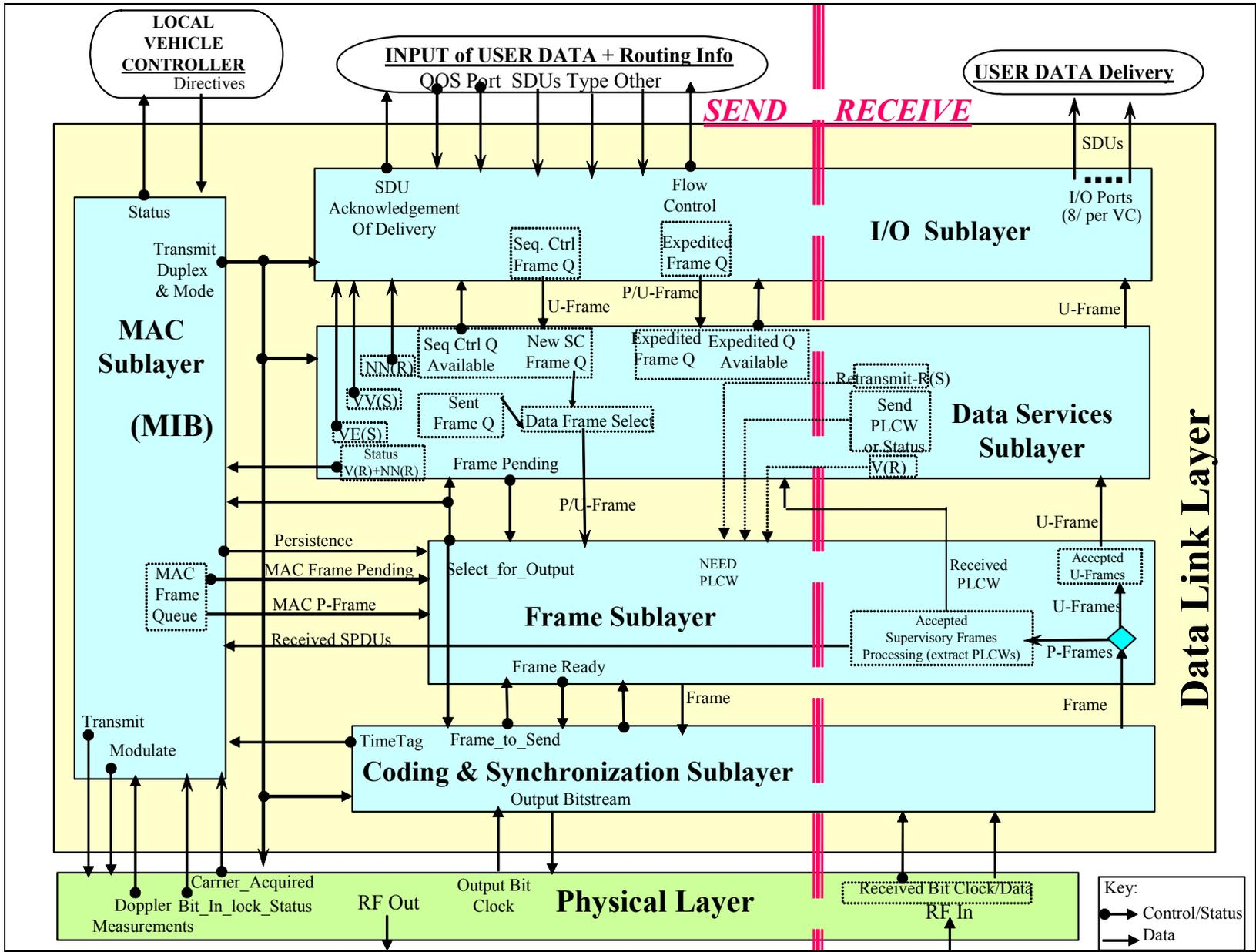

Figure 2-1: Proximity-1 Layered Protocol Model

## CCSDS RECOMMENDED STANDARD FOR PROXIMITY-1 SPACE DATA LINK PROTOCOL

**2.1.2 PROTOCOL-UNIQUE FEATURES**

The Proximity-1 protocol controls and manages data interchange across the communications link. This Data Link layer protocol provides the capability to send user data, control reports, and control directives between the transceiver units. The directives are used for selection of communications frequencies, data rates, modulation, coding, and link directionality (full duplex, half duplex, and simplex). The Data Link layer provides for the transfer of both packets and user-defined data units. All of these units can be transferred using either an Expedited or a Sequence Controlled (reliable) service supportive of applications involving remote space vehicles.

State tables and diagrams describe the actions the protocol takes when responding to events during full duplex, half duplex, and simplex operations. See section 6, Data Services Operations, and Section 7, Communication Operations Procedure for Proximity Links (COP-P).

The terms ‘transfer frame’ and ‘frame’ in this text refer to the Version-3 Transfer Frame. Each transfer frame contains a header, which provides protocol control information for processing the Transfer Frame Data field. This data field contains either:

- a) Service Data Units (SDUs), i.e., user data for delivery to applications within the receiving node;
- b) Supervisory Protocol Data Units (SPDUs):
  - 1) protocol directives:
    - i) for configuring and controlling the protocol processor at the receiving node,
    - ii) for the establishment, maintenance, and termination of a communications session;
  - 2) protocol reports:
    - i) for reporting the configuration and status of the transmitting node,
    - ii) for reporting the status of a Sequence Controlled data transfer operating in the opposite direction, i.e., PLCW.

The list of protocol directives and reports is extended for use in controlling and reporting status for the Physical layer process when the Data Link layer and Physical layers are collocated.

**2.1.3 PLTU TYPE**

The PLTU is flexibly sized to fit its variable-length data content (e.g., variable-length frame containing variable-length packets). This PLTU is intended for use on links characterized by short time delays, moderate (not weak) signals, and short, independent sessions. These link characteristics determine the type of ASM (24-bit), its associated bit error tolerance for

synchronization, and coding (32-bit Cyclic Redundancy Check) employed for the PLTUs. Symbol and bit synchronization is maintained in the data channel by the insertion of an idle sequence between PLTUs, and these variable-length PLTUs are only inserted into the data link when a physical connection has been achieved. The data field of a variable-length frame can contain an integer number of unsegmented packets, a single packet segment, or a collection of user-provided octets. See figure 3-1 and reference [8] for the definition of this PLTU.

#### 2.1.4 ADDRESSING

A triad of addressing capabilities is incorporated for specific functionality within the link. The Spacecraft Identifier (SCID) identifies the source or destination of transfer frames transported in the link connection based upon the Source-or-Destination Identifier. The Physical Channel Identifier (PCID) provides two independently multiplexed channels, each capable of supporting both the Sequence Controlled and Expedited services. The Port ID provides the means to route user data internally (at the transceiver's output interface) to specific logical ports, such as applications or transport processes, or to physical ports, such as on-board buses or physical connections (including hardware command decoders).

#### 2.1.5 PROTOCOL DESCRIPTION

The Proximity-1 protocol is described in terms of:

- a) the services provided to the users (transfer of SDUs);
- b) the Protocol Data Units (PDUs);
- c) the protocol directives and reports (SPDUs described in 3.2.8);
- d) the procedures performed by the protocol as described in the state tables.

This protocol specification also defines the requirements for the underlying services provided by the lower layers.

### 2.2 OVERVIEW OF SERVICES

#### 2.2.1 COMMON FEATURES OF SERVICES

Proximity-1 provides users with data transfer services known as Space Data Link Proximity-1 services. The point at which a service is provided by a protocol entity to a user is called a Service Access Point (SAP). For each Physical Channel (PC), there are two receiving SAPs (one for Sequence Controlled service, and the other for Expedited service) through which input data (SDUs) are received (presumably from the spacecraft vehicle controller). There are also eight output SAPs (port addresses) through which received telemetered data are distributed to the on-board data systems and their applications.

## CCSDS RECOMMENDED STANDARD FOR PROXIMITY-1 SPACE DATA LINK PROTOCOL

**2.2.2 SERVICE TYPES****2.2.2.1 General**

The Proximity-1 protocol provides data and timing services. Data services are of two types: the first accepts and delivers packets, while the second accepts and delivers user-defined data. The timing service provides time tagging upon ingress/egress of selected PLTUs. See 5.1 for details on the Proximity-1 Timing Service.

**2.2.2.2 CCSDS Packet Delivery Service**

The packet delivery service provides for the transfer of packets (CCSDS source packets, Space Communications Protocol Specification (SCPS)—Network Protocol (SCPS-NP) packets, IPv4 packets, and encapsulation packets—see reference [4]) across the Proximity space link. The packets are multiplexed into transfer frames (when they are smaller than the maximum frame data field size allowed in the link), or they are segmented before being inserted into transfer frames and then reassembled into packets for delivery (when they are greater than the maximum frame data field size allowed in the asynchronous link). In this service the delivery process makes use of the Port ID to identify the specific physical or logical port through which the packet is to be routed.

**2.2.2.3 User Defined Data Delivery Service**

The user defined data delivery service provides for the transfer of a single user's collection of octets (format unknown to the protocol) via the Port ID specified in the Transfer Frame Header. The service does not utilize any information from the Frame Data field. The user data will be placed in one or more frames as required based upon the size of the received data. In this service the delivery process makes use of the Port ID to identify the specific physical port through which the octets are to be routed.

**2.2.2.4 Timing Service**

Timing services are required for Proximity operations in order to provide time (spacecraft clock) correlation data among communicating units and time-derived ranging measurements. See 5.1.

**2.2.3 SERVICE QUALITIES****2.2.3.1 General**

The Proximity-1 data services protocol provides two grades of service (Sequence Controlled and Expedited) that determine how reliably SDUs supplied by the sending user are delivered to the receiving user. The controlling procedure is called COP-P and consists of a Frame Operations Procedure for Proximity links (FOP-P), used on the sending side of the service, and a Frame Acceptance and Reporting Mechanism for Proximity links (FARM-P), used on the receiving side of the service.

Each of these two service grades is accessed through its own SAP. For each SDU, the user must additionally specify the output port through which the data are to be delivered by the receiving transceiver and the type of data units provided. Packetized data units that are larger than the maximum frame size in asynchronous frames can be transferred only by using the segmentation process, utilizing either the Sequence Controlled service or the Expedited service.

### 2.2.3.2 Sequence Controlled Service

The Sequence Controlled service ensures that data are reliably transferred across the space link and delivered in order, without gaps, errors, or duplications within a single communication session without COP-P resynchronization during the session (see 4.3.2). This service is based on a 'go-back-n' type of Automatic Repeat Queuing (ARQ) procedure that utilizes sequence-control mechanisms of both sending and receiving ends and a standard report (PLCW) returned from the receiving end to the sending end.

Sequence Controlled SDUs supplied by a sending user at the Sequence Controlled SAP are inserted into transfer frames as required and transmitted on a Physical Channel (PC) initially in the order in which they are presented at the SAP. SDUs are passed to the receiving user via the identified port. The retransmission mechanism ensures with a high probability of success that:

- a) no SDU is lost;
- b) no SDU is duplicated;
- c) no SDU is delivered out of sequence.

### 2.2.3.3 Expedited Service

The Expedited service is nominally used with upper-layer protocols that provide their own retransmission features, or in exceptional operational circumstances such as during spacecraft recovery operations.

Expedited SDUs supplied by the sending user are transmitted without ARQ. At the sending end, Expedited SDUs are transmitted on specified PCs independently of the Sequence Controlled SDUs waiting to be transmitted on the same PC. At the receiving end, the SDUs are passed to the receiving user via the identified port. Note that Expedited SDUs may be sent once or multiple times, but they are not sent again as a result of a request for retransmission. If such a request occurs it is performed outside the purview of the protocol.

There is no guarantee that all Expedited SDUs will be delivered to the receiving user. Expedited service delivers only complete SDUs to the user.

NOTE – In Expedited service the capability is provided to deliver portions of user-defined data units that are greater than the maximum frame size allowed for the link.

### 3 PROTOCOL DATA UNITS

#### 3.1 CONTEXT OF THE VERSION-3 TRANSFER FRAME

See figure 3-1 for the Proximity-1 protocol data unit context diagram.

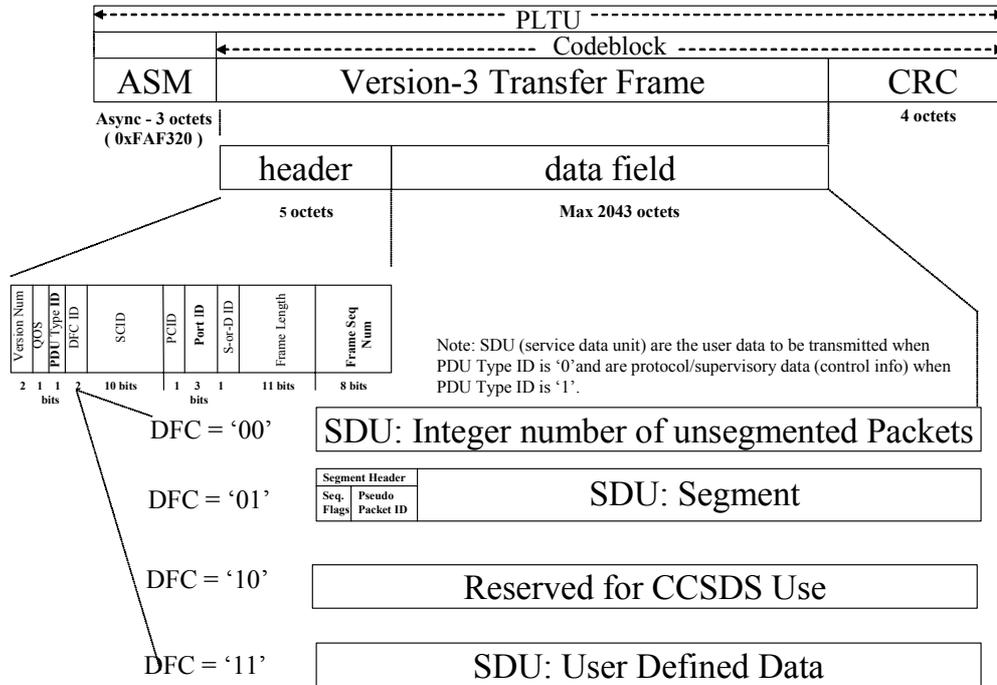

Figure 3-1: Proximity-1 Protocol Data Unit Context Diagram

#### 3.2 VERSION-3 TRANSFER FRAME

##### 3.2.1 VERSION-3 TRANSFER FRAME STRUCTURE

A Version-3 Transfer Frame shall encompass the following fields, positioned contiguously, in the following sequence:

- a) Transfer Frame Header (five octets, mandatory);
- b) Transfer Frame Data Field (up to 2043 octets).

NOTES

- 1 The Version-3 Transfer Frame is the PDU transmitted from the sending end to the receiving end by Proximity-1.
- 2 The maximum transfer frame length allowed by a particular spacecraft or ground implementation on a particular PC may be less than the maximum specified here.
- 3 The composition of the Version-3 Transfer Frame is shown in figure 3-2.

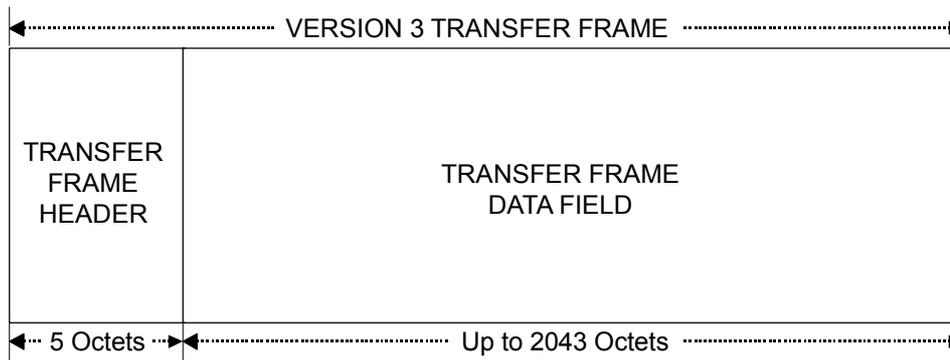

Figure 3-2: Version-3 Transfer Frame

3.2.2 TRANSFER FRAME HEADER

3.2.2.1 Summary of Header Fields

The Transfer Frame Header is mandatory and shall consist of ten mandatory fields, positioned contiguously, in the following sequence:

- a) Transfer Frame Version Number (2 bits);
- b) Quality of Service (QOS) Indicator (1 bit);
- c) Protocol Data Unit (PDU) Type ID (1 bit);
- d) Data Field Construction Identifier (DFC ID) (2 bits);
- e) Spacecraft Identifier (SCID—see reference [6]) (10 bits);
- f) Physical Channel Identifier (PCID) (1 bit);
- g) Port ID (3 bits);
- h) Source-or-Destination Identifier (1 bit);
- i) Frame Length (11 bits);
- j) Frame Sequence Number (interpretation is QOS dependent) (8 bits).

NOTE – The format of the Transfer Frame Header is shown in figure 3-3.

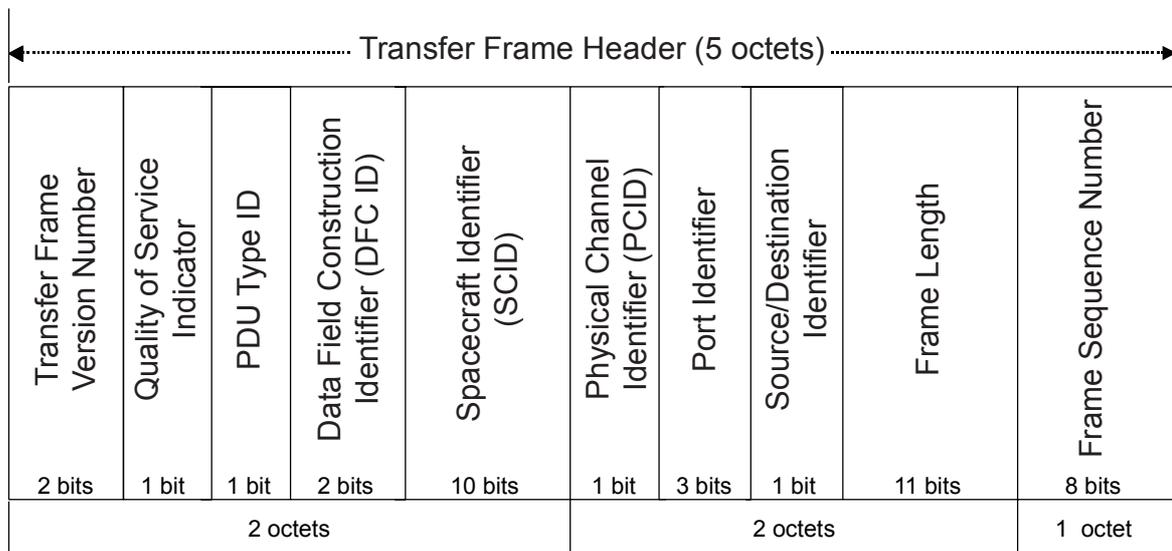

Figure 3-3: Transfer Frame Header

**3.2.2.2 Transfer Frame Version Number**

**3.2.2.2.1** Bits 0–1 of the Transfer Frame Header shall contain the Transfer Frame Version Number.

**3.2.2.2.2** The Transfer Frame Version Number field shall contain the binary value ‘10’.

NOTE – This Recommendation defines the Version-3 Transfer Frame. For other transfer frames defined by CCSDS for use with other protocols, see references [3] and [4].

**3.2.2.3 Quality of Service Indicator**

**3.2.2.3.1** Bit 2 of the Transfer Frame Header shall contain the QOS Indicator.

**3.2.2.3.2** The single-bit QOS Indicator shall control the application of Frame Acceptance Checks by the receiving end.

- a) Setting this Indicator to ‘0’ specifies that this transfer frame is a Sequence Controlled transfer frame, and acceptance of this transfer frame by the receiving end shall be subject to the Frame Acceptance Checks, which provide the ‘reliable’ Sequence Controlled service.
- b) Setting this indicator to ‘1’ specifies that this transfer frame is an Expedited transfer frame, and the Frame Acceptance Checks used for Sequence Controlled service by the receiving end shall be bypassed.

**3.2.2.4 PDU Type ID**

**3.2.2.4.1** Bit 3 of the Transfer Frame Header shall contain the PDU Type ID.

**3.2.2.4.2** The PDU Type ID shall be used to specify whether the Transfer Frame Data field is conveying protocol supervisory data or user data information.

- a) Setting the PDU Type ID to ‘0’ indicates that the Transfer Frame Data field contains user data information.
- b) Setting the PDU Type ID to ‘1’ indicates that the Transfer Frame Data field contains supervisory protocol data, i.e., control information, used for controlling operations of the Proximity-1 protocol processor. See 3.2.8 for an explanation of when this PDU type must be used.

**3.2.2.5 Data Field Construction ID**

**3.2.2.5.1** Bits 4–5 of the Transfer Frame Header shall contain the Data Field Construction ID (DFC ID).

**3.2.2.5.2** The DFC ID shall signal the data field construction rules used to build the U-Frame Data field.

**3.2.2.5.3** The four frame data field construction rules are defined in table 3-1.

**Table 3-1: U-Frame Data Field Construction Rules**

<b>DFC ID</b>	<b>PLTU Type</b>	<b>Frame Data Field Content</b>	<b>Subsection</b>
‘00’	Asynchronous	Packets (integer number of unsegmented packets)	3.2.4
‘01’	Asynchronous	Segment Data (a complete or segmented packet)	3.2.5
‘10’	Reserved for future CCSDS definition.	Reserved for future CCSDS definition.	3.2.6
‘11’	Asynchronous	User-defined Data	3.2.7

**3.2.2.6 Spacecraft Identifier (SCID)**

**3.2.2.6.1** Bits 6–15 of the Transfer Frame Header shall contain the SCID.

## CCSDS RECOMMENDED STANDARD FOR PROXIMITY-1 SPACE DATA LINK PROTOCOL

**3.2.2.6.2** The 10-bit SCID shall provide the identification of the spacecraft that is either the source or the destination of the data contained in the transfer frame.

NOTE – See Source-or-Destination Identifier for the definition of the value of the SCID.

### 3.2.2.7 Physical Channel Identifier (PCID)

**3.2.2.7.1** Bit 16 of the Transfer Frame Header shall contain the PCID.

**3.2.2.7.2** The PCID shall be used to identify the transmitter (FOP-P Protocol Unit, see 7.1) within a spacecraft:

- a) setting the PCID to ‘0’ indicates PCID 0;
- b) setting the PCID to ‘1’ indicates PCID 1.

### 3.2.2.8 Port ID

**3.2.2.8.1** Bits 17–19 of the Transfer Frame Header shall contain the Port ID.

**3.2.2.8.2** The Port ID shall be used to address different physical or logical connection ports to which user data are to be routed.

NOTE – There are eight Port IDs (i.e., 0 through 7).

**3.2.2.8.3** Port IDs shall be independent of physical channel assignment.

EXAMPLE – A Port ID could designate that the contents of the Frame Data field should be delivered via the addressed physical data port (e.g., a port to a spacecraft bus), or to a defined process within the connected command and data handling system.

### 3.2.2.9 Source-or-Destination Identifier

**3.2.2.9.1** Bit 20 of the Transfer Frame Header shall contain the Source-or-Destination Identifier.

**3.2.2.9.2** The Source-or-Destination Identifier shall identify the link node to which the value in the SCID field applies:

- a) a setting of ‘0’ shall indicate that:
  - 1) the SCID refers to the **source** of the transfer frame,
  - 2) the test of the SCID shall be included in the Frame sublayer only when `Test_Source` is *true*;

b) a setting of '1' shall indicate that:

- 1) the SCID refers to the **destination** of the transfer frame,
- 2) the test of the SCID shall be included in the frame sublayer.

**3.2.2.9.3** When the Source-or-Destination ID is set to '0', i.e., *source*, the value of the SCID shall be contained in the MIB parameter, *Local\_Spacecraft\_ID*.

NOTE – Assignment procedures for SCIDs in Proximity-1 Transfer Frames are controlled by reference [6].

**3.2.2.9.4** When the Source-or-Destination ID is set to '1', i.e., *destination*, the value of the SCID shall be contained in the MIB parameter, *Remote\_Spacecraft\_ID*.

### 3.2.2.10 Frame Length

**3.2.2.10.1** Bits 21–31 of the Transfer Frame Header shall contain the frame length.

**3.2.2.10.2** This 11-bit field shall contain a length count *C*, which equals one fewer than the total number of octets in the transfer frame.

- a) the count shall be measured from the first octet of the Transfer Frame Header to the last octet of the Transfer Frame Data field;
- b) the length count *C* is expressed as:  $C = (\text{total number of octets in the transfer frame}) - 1$ .

NOTE – The size of the Frame Length field limits the maximum length of a transfer frame to 2048 octets ( $C = 2047$ ). The minimum length is 5 octets ( $C = 4$ ).

### 3.2.2.11 Frame Sequence Number (Sequence Controlled or Expedited)

**3.2.2.11.1** Bits 32–39 of the Transfer Frame Header shall contain the Frame Sequence Number (FSN).

**3.2.2.11.2** The FSN shall increment monotonically and independently for the set of frames within a PC that are associated with the Sequence Controlled service (QOS Indicator set to '0'). In this case, the FSN is called the *Sequence\_Controlled\_FSN* (SEQ\_CTRL\_FSN).

**3.2.2.11.3** The FSN shall increment monotonically for the set of frames for a given PC that are associated with the Expedited Data Service (QOS Indicator set to '1'). In this case, the FSN is called the *Expedited\_FSN* (EXP\_FSN).

#### NOTES

- 1 The FSN (controlled within the Data Services sublayer) for each service is initialized to '0' by the SET INITIALIZE MODE directive (see 6.3.6.1.2).

CCSDS RECOMMENDED STANDARD FOR PROXIMITY-1 SPACE DATA LINK PROTOCOL

- 2 The SEQ\_CTRL\_FSN enables the Sequence Controlled process to number sequentially and then check the sequence of incoming Sequence Controlled transfer frames.
- 3 The EXP\_FSN is not used in the frame validation process but is required for correlations associated with timing services.
- 4 The FSN is PC-dependent for both the Sequence Controlled and Expedited services.

**3.2.3 TRANSFER FRAME DATA FIELD**

The Transfer Frame Data field shall:

- a) follow, without gap, the Transfer Frame Header;
- b) be of variable length;
- c) contain from zero octets up to 2043 octets (maximum frame length of 2048 less five octets for the frame header);
- d) contain either an integer number of octets of data corresponding to one or more SDUs, or an integer number of octets of protocol information.

NOTE – These octets may contain an SDU and other data fields based upon the DFC ID. See figure 3-4.

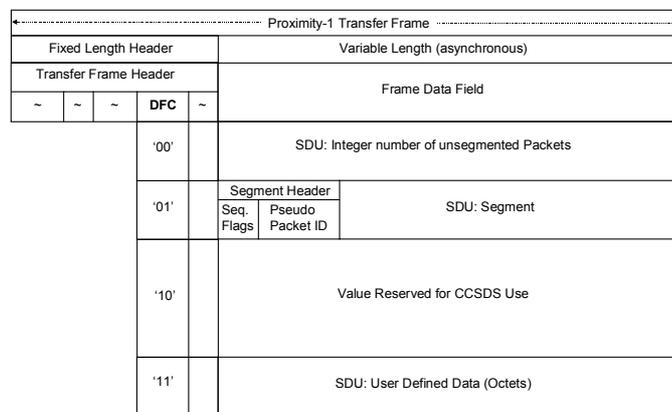

**Figure 3-4: Proximity-1 Transfer Frame Data Field Structure**

**3.2.4 PACKETS**

**3.2.4.1** When the DFC ID field contains the binary value '00' (pertaining to asynchronous PLTUs), the Frame Data field shall consist of an integer number of packets each designated to the same Port ID (see figure 3-4).

3.2.4.2 The first bit of the Frame Data field shall be the first bit of a packet header.

**3.2.5 SEGMENT DATA UNITS**

3.2.5.1 When the DFC ID field contains the binary value ‘01’ (pertaining to asynchronous PLTUs), the Frame Data field contains a Segment Data Unit consisting of an eight-bit segment header followed by a segment of a packet (see figure 3-4).

3.2.5.2 The contents of the segment header and segment data field shall be as follows:

- a) bits 0 and 1 of the segment header compose the sequence flag, which shall identify the position of the segment relative to the packet of which the segment is a part as specified in table 3-2;
- b) the remaining six bits compose an identifier field, the pseudo packet identifier, which shall adaptively be used to associate all the segments of a packet data unit;
- c) segments must be placed into the data link in the proper order:
  - 1) segments of the same packet must be sent in frames of the same PCID and Port ID,
  - 2) segments from another packet may be interspersed but only in frames containing a different PCID or Port ID.

**Table 3-2: Segment Header Sequence Flags**

Sequence Flags	Interpretation
‘01’	first segment
‘00’	continuing segment
‘10’	last segment
‘11’	no segmentation (i.e., contains the entire packet)

3.2.5.3 Prior to delivery to the user, the Data Link layer shall re-assemble all the segments using the same Routing ID, i.e., using the same PCID, Port ID, and pseudo packet ID, into a packet.

NOTE – See 1.5.1.3 for the definitions of Routing ID and pseudo packet ID.

3.2.5.4 Only complete packets shall be sent on to the user.

3.2.5.5 The accumulated packet shall be discarded and this event shall be logged into the session accountability report whenever any of the following errors occur:

## CCSDS RECOMMENDED STANDARD FOR PROXIMITY-1 SPACE DATA LINK PROTOCOL

- a) the packet length field does not agree with the number of bytes received and aggregated from the segments;
- b) the first segment received for a Routing ID is not the start segment of the data unit;
- c) the last segment for a Routing ID is not received before the starting segment of a new packet is received.

**3.2.6 CCSDS RESERVED FIELD**

The binary value '10' for the DFC ID field is reserved by CCSDS and shall not be used.

**3.2.7 USER-DEFINED DATA**

When the DFC ID field contains the binary value '11', the Frame Data field shall consist of User Defined Data (see figure 3-4).

**3.2.8 SUPERVISORY PDU (SPDU)**

NOTE – The protocol data units discussed in this subsection are used by the local transceiver either for local control within the transceiver, or for reporting status to and controlling the remote transceiver acting as the communication partner over the Proximity space link.

**3.2.8.1 General**

**3.2.8.1.1** SPDUs are of either fixed or variable length based upon the value of the SPDU format ID. Currently there is only one fixed-length SPDU defined, i.e., PLCW. Variable-length SPDUs provide the capability for concatenating and multiplexing protocol objects, i.e., directives, status reports, and PLCWs. Note that the positions of the individual fields within the fixed-length PLCW differ from those of the variable-length PLCW. Each SPDU Type is further described in tables 3-3 and 3-4.

**3.2.8.1.2** SPDUs can be transmitted using only the expedited QOS (QOS = '1').

**3.2.8.1.3** SPDUs are all self-identifying and self-delimiting. Only variable-length SPDUs further decompose into specific types of supervisory directives, reports, or PLCWs. See annex A for the detailed specification of variable-length SPDUs.

**3.2.8.2 Overview of SPDU Formats**

**3.2.8.2.1** Fixed-length SPDUs consist of an SPDU Format ID, SPDU Type Identifier, and a Supervisory Data field. Variable-length SPDUs consist of an SPDU Format ID, SPDU Type Identifier, length of SPDU field, and a Supervisory Data field.

**3.2.8.2.2** For fixed-length SPDUs these fields are defined and are positioned contiguously, in the following sequence as:

- a) SPDU Header (two bits) consisting of:
  - 1) SPDU Format ID (one bit),
  - 2) SPDU Type Identifier (one bit);
- b) Supervisory Data field (14 bits) consisting of either the data field of a fixed-length PLCW or the data field of a CCSDS reserved SPDU.

**3.2.8.2.3** For variable-length SPDUs, these fields are defined and are positioned contiguously, in the following sequence as:

- a) SPDU Header (one octet) consisting of:
  - 1) SPDU Format ID (one bit),
  - 2) SPDU Type Identifier (three bits),
  - 3) Data Field Length (four bits) (this represents the actual number of octets in the data field of the SPDU);

NOTE – Data Field Length is not a ‘length minus one’ field.

- b) Supervisory Data field (variable length, i.e., 0 to 15 octets) consisting of one or more supervisory directives, status reports, or PLCWs of the same SPDU type.

**Table 3-3: Fixed-Length Supervisory Protocol Data Unit**

Fixed-Length SPDU (16 bits)	SPDU Header (2 bits)		SPDU Data Field (14 bits)
	SPDU Format ID (Bit 0)	SPDU Type Identifier (Bit 1)	(contains 1 protocol object, i.e., directive or report or PLCW)  (Bits 2 through 15)
Type F1	‘1’	‘0’	Fixed Length PLCW (See 3.2.8.3.2)
Type F2	‘1’	‘1’	Reserved for CCSDS Use

### 3.2.8.3 Fixed-Length SPDU

#### 3.2.8.3.1 General

A ‘1’ in the SPDU Format ID field identifies a 16-bit fixed-length SPDU. This format provides for only two fixed SPDUs, which are differentiated by the SPDU Type Identifier field. A ‘zero’ in bit 1 identifies the SPDU as a PLCW, while an SPDU identified by a ‘one’ in bit 1 is reserved for future CCSDS specification.

#### 3.2.8.3.2 Type F1 SPDU: Proximity Link Control Word (PLCW)

##### 3.2.8.3.2.1 General

**3.2.8.3.2.1.1** The Proximity Link Control Word (PLCW) shall consist of seven fields, positioned contiguously in the following sequence (described from least significant bit, bit 15, to most significant bit, bit 0):

- a) Report Value (eight bits);
- b) Expedited Frame Counter (three bits);
- c) Reserved Spare (one bit);
- d) PCID (one bit);
- e) Retransmit Flag (one bit);
- f) SPDU Type Identifier (one bit);
- g) SPDU Format ID (one bit).

**3.2.8.3.2.1.2** The PLCW shall be transmitted using the Expedited QOS.

NOTE – The structural components of the PLCW are shown in figure 3-5. This format applies only to the fixed-length PLCW; i.e., it does not apply to the PLCW defined in the variable-length SPDU section. See C4.3 for NASA Mars Surveyor Project 2001 Odyssey PLCW definition.

Bit 0							Bit 15
SPDU Header		SPDU Data Field					
SPDU Format ID	SPDU Type Identifier	Retrans- mit Flag	PCID	Reserved Spare	Expedited Frame Counter	Report Value (Frame Sequence Number)	
1 bit	1 bit	1 bit	1 bit	1 bit	3 bits	8 bits	

**Figure 3-5: Proximity Link Control Word Fields**

**3.2.8.3.2.2 Report Value**

**3.2.8.3.2.2.1** Bits 8–15 of the PLCW shall contain the Report Value.

**3.2.8.3.2.2.2** The Report Value field shall contain the value of V(R).

**3.2.8.3.2.2.3** Separate Report Values shall be reported for each PC independent of the I/O port.

**3.2.8.3.2.3 Expedited Frame Counter**

**3.2.8.3.2.3.1** Bits 5–7 of the PLCW shall contain the EXPEDITED\_FRAME\_COUNTER.

**3.2.8.3.2.3.2** The EXPEDITED\_FRAME\_COUNTER shall provide a modulo-8 counter indicating that Expedited frames have been received.

**3.2.8.3.2.4 Reserved Spare**

**3.2.8.3.2.4.1** Bit 4 of the PLCW shall contain a Reserved Spare bit.

**3.2.8.3.2.4.2** The Reserved Spare bit field shall be set to ‘0’.

**3.2.8.3.2.5 Physical Channel Identification**

**3.2.8.3.2.5.1** Bit 3 of the PLCW shall contain the PCID field.

**3.2.8.3.2.5.2** The one-bit PCID field shall contain the PCID of the Physical Channel with which this report is associated. See 6.2.3.10, ‘RECEIVING\_PCID\_BUFFER’.

## CCSDS RECOMMENDED STANDARD FOR PROXIMITY-1 SPACE DATA LINK PROTOCOL

NOTE – Each PCID in use has its own PLCW reporting activated.

**3.2.8.3.2.6 PLCW Retransmit Flag**

**3.2.8.3.2.6.1** Bit 2 of the PLCW shall contain the PLCW Retransmit Flag.

**3.2.8.3.2.6.2** A setting of '0' in the PLCW Retransmit Flag shall indicate that there are no outstanding frame rejections in the sequence received so far, and thus retransmissions are not required.

**3.2.8.3.2.6.3** A setting of '1' in the PLCW Retransmit Flag shall indicate that a received frame failed a frame acceptance check and, therefore, that a retransmission of that frame is required.

**3.2.8.3.2.7 SPDU Type Identifier**

**3.2.8.3.2.7.1** Bit 1 of the PLCW shall contain the SPDU Type Identifier.

**3.2.8.3.2.7.2** The one-bit SPDU Type Identifier field shall identify the SPDU type as a PLCW and shall contain the binary value '0'.

**3.2.8.3.2.8 SPDU Format ID**

**3.2.8.3.2.8.1** Bit 0 of the PLCW shall contain the SPDU Format ID.

**3.2.8.3.2.8.2** The one-bit SPDU format ID field shall identify the SPDU as being of fixed length and shall contain the binary value '1'.

**Table 3-4: Variable-Length Supervisory Protocol Data Unit**

Variable-Length SPDU	SPDU Header (1 octet, fixed)			SPDU Data Field (0-15 octets)
	Format ID (Bit 0)	SPDU Type Identifier (Bits 1,2,3)	Length of SPDU Data Field (Bits 4,5,6,7)	
				(contains 1 or more protocol objects, i.e., directives, reports, PLCWs)
Type 1	'0'	'000'	Length in Octets	Directives/Reports/PLCWs (see note)
Type 2	'0'	'001'	"	TIME DISTRIBUTION PDU
Type 3	'0'	'010'	"	Status Reports
Type 4	'0'	'011'	"	Reserved for CCSDS Use
Type 5	'0'	'100'	"	Reserved for CCSDS Use
Type 6	'0'	'101'	"	Reserved for CCSDS Use
Type 7	'0'	'110'	"	Reserved for CCSDS Use
Type 8	'0'	'111'	"	Reserved for CCSDS Use

NOTE – Directives and PLCWs can be multiplexed within the SPDU Data Field.

**3.2.8.4 Variable-Length SPDU**

**3.2.8.4.1 General**

A '0' in the SPDU Format ID field identifies a variable-length SPDU data field, which may contain from 0 to 15 octets of supervisory data. This form of SPDU uses bits 1 through 3 of the SPDU header to identify one of eight possible SPDU Types. Currently three of these eight types are defined in the following two subsections. The remainder are reserved for future CCSDS specification.

**3.2.8.4.2 Type 1 SPDU: Directives/Reports/PLCWs**

An SPDU with SPDU Type Identifier equal to '000' identifies its data field to contain from zero to seven (16 bit) concatenated and multiplexed protocol objects, i.e., directives, reports, or PLCWs.

NOTE – See table 3-4 for this type specification. See annex A for the formats of the type 1 SPDU data field.

## CCSDS RECOMMENDED STANDARD FOR PROXIMITY-1 SPACE DATA LINK PROTOCOL

**3.2.8.4.3 Type 2 SPDU: TIME DISTRIBUTION PDU**

An SPDU with SPDU Type Identifier equal to '001' identifies its data field to contain from one to fifteen octets of TIME DISTRIBUTION supervisory data. Octet 0 of the data field contains the TIME DISTRIBUTION directive type, followed by the actual time field value (one to fourteen octets).

NOTE – See table 3-4 for this type specification. See annex A for the format of the type 2 SPDU data field.

**3.2.8.4.4 Type 3 SPDU: Status Reports**

An SPDU with SPDU Type Identifier equal to '010' identifies its data field to contain from zero to fifteen octets of Status Report information. The format of these reports is enterprise specific and is left up to the implementation.

NOTE – Provision is made in the protocol to identify when a status report is required (NEED\_STATUS\_REPORT) and when a status report is requested (See Type 1 SPDU Report Request).

Blank page

## 4 DATA LINK LAYER

### 4.1 FRAME SUBLAYER

#### 4.1.1 FRAME SUBLAYER FUNCTIONS

**4.1.1.1** At the sending end, the Frame sublayer (see 2.1.1) shall perform the following functions:

- a) accept frames supplied by the Data Services and MAC sublayers and modify field values as necessary;
- b) formulate PLCWs and status reports and incorporate them into a P-frame as required;
- c) determine the order of frame transmission;
- d) transfer the frames to the C&S sublayer.

**4.1.1.2** At the receiving end, the Frame sublayer shall perform the following functions:

- a) receive a frame from the C&S sublayer;
- b) validate that the received frame is a Version-3 Transfer Frame;
- c) validate that the frame should be accepted by the local transceiver based on the Spacecraft ID field and the Source-or-Destination ID of the transfer frame;
- d) if the frame is a valid U-frame, route it to the data services sublayer;
- e) if the frame is a valid P-frame, route the contents of the frame (SPDUs) to the MAC sublayer;
- f) if the frame is a valid P-frame and contains a PLCW, route it to the Data Services sublayer.

#### 4.1.2 FRAME SELECTION FOR OUTPUT PROCESSING AT THE SENDING END

**NOTE** – The Frame sublayer provides the control for formulating the frame headers and the SPDU data for transmission. The frame is delivered to the C&S sublayer to be assembled into a PLTU prior to delivery to the Physical layer.

##### 4.1.2.1 Frame Multiplexing Process Control

**4.1.2.1.1** Frames shall be generated and sent as required when the TRANSMIT parameter (6.2.2.3) is set to *on*. When the PLTU contents are ready for transmission and while TRANSMIT is *on*, the data shall be transferred to the C&S sublayer for processing.

**4.1.2.1.2** When either NEED\_PLCW or NEED\_STATUS\_REPORT is set to *true*, the required status and/or PLCW data shall be generated and inserted into a P-frame for delivery.

#### 4.1.2.2 Frame Selection

Each time a frame is to be dispatched to the C&S sublayer, its selection from a series of sources shall be based on the following priority scheme:

- a) first priority shall be given to a frame from the MAC queue in the MAC sublayer;
- b) second priority shall be given to a PLCW or status report, if *U-frame\_last\_sent* is *True*;
- c) third priority shall be given to an Expedited frame from the Expedited Frame queue in the I/O sublayer;
- d) fourth priority shall be given to a Sequence Controlled frame, first from the Sent queue if required, and then from the Sequence Controlled Frame queue in the I/O sublayer;
- e) fifth priority shall be given to a PLCW or status report, if *U-frame\_last\_sent* is *False*.

#### NOTES

- 1 *U-frame\_last\_sent* is set to *True* on session initialization.
- 2 *U-frame\_last\_sent* is set to *False* whenever a PLCW or Status\_report is sent.
- 3 *U-frame\_last\_sent* is set to *True* for all other frames sent.

## 4.2 MEDIUM ACCESS CONTROL (MAC) SUBLAYER

### 4.2.1 OVERVIEW

The Medium Access Control (MAC) sublayer is responsible for the establishment and termination of each communications session. It is also responsible for any operational changes in the Physical layer configuration made during the data services phase.

Some of the operations performed by the MAC sublayer require a 'handshaking' process between the sending transceiver and the responding transceiver. This handshake is often based upon interpretation of values of the physical layer control signals, i.e., CARRIER\_ACQUIRED and BIT\_INLOCK\_STATUS. Because of the potential for loss of an inter-transceiver control message due to corruption across the space link, MAC control activities require a 'persistence' process to ensure that the expected results of an activity are verified before any other activity is started. This process is generically defined as a persistent activity.

## 4.2.2 PERSISTENT ACTIVITY PROCESS

### 4.2.2.1 Overview

A persistent activity is a process for ensuring reliable communication between a caller and a responder using the expedited QOS while transmitting from the MAC queue. Because of the potential for frame loss due to corruption across the space link, these MAC control activities require a persistence process to ensure that supervisory protocol directives are received and acted upon correctly. Persistence activities may be linked in series to accomplish a task, but persistence applies to only a single activity at a time. The protocol defines three persistent activities: Hailing, i.e., Session Establishment (see 6.2.4 and tables 6-8 and 6-11); COMM\_CHANGE (see 6.2.4 and tables 6-9 and 6-12); and Resynchronization (see 7.1.3.2 and 7.1.3.3).

### 4.2.2.2 General

**4.2.2.2.1** Each persistent activity is named and consists of one or more actions (e.g., issuing selective directives), followed by a WAITING\_PERIOD during which a specific RESPONSE is expected.

**4.2.2.2.2** Upon initiation of a persistent activity, a hold (PERSISTENCE signal is set to *true*) shall be placed upon the Frame sublayer to inhibit the selection of any frame other than a frame from the MAC queue.

**4.2.2.2.3** The success or failure of the activity shall be determined by the detection of the expected RESPONSE within the activity's LIFETIME:

- a) no response within the activity's LIFETIME time period shall be deemed a failure;
- b) in either case, a NOTIFICATION of the activity's success or failure shall be communicated back to the vehicle controller, and the PERSISTENCE signal shall be set to *false*.

### 4.2.2.3 Persistence Activity Parameters

The parameters associated with a persistent activity are described below; their values vary based on the activity to be performed, and are defined per activity in the MIB:

- a) ACTIVITY: the name of the persistent activity;
- b) WAITING\_PERIOD: the amount of time specified for the RESPONSE to be received before the process declares that the activity is to be either repeated or aborted;
- c) RESPONSE: the acknowledgement by the responder that the persistent activity has been accepted;
- d) NOTIFICATION: the message provided to the local vehicle controller, e.g., spacecraft C&DH by the caller and responder upon success or failure of the persistent activity;

- e) LIFETIME: the time period during which the persistent activity shall be repeated until the expected RESPONSE is detected.

NOTE – If the RESPONSE is not detected within the LIFETIME, the activity is aborted. The LIFETIME can be locally defined in terms of a duration or a maximum number of times this activity shall be repeated before the activity is aborted.

### 4.2.3 MAC CONTROL MECHANISMS

NOTE – The following mechanisms are used to coordinate and control operations between the MAC and other sublayers.

#### 4.2.3.1 PERSISTENCE

The PERSISTENCE signal when *true* shall set a hold on the frame selection process in the Frame sublayer, allowing only frames from the MAC queue to be selected for output. When *false*, no restriction applies.

#### 4.2.3.2 MAC\_FRAME\_PENDING

The MAC\_FRAME\_PENDING parameter is provided from the MAC sublayer to the Frame sublayer. The MAC\_FRAME\_PENDING is set to *true* when a complete frame is loaded into the MAC queue. MAC\_FRAME\_PENDING is set to *false* when the last bit of the frame is extracted from the MAC queue.

#### 4.2.3.3 TIME\_COLLECTION

The TIME\_COLLECTION variable is used to indicate the status of collecting time correlation data (time and associated frame sequence numbers) during Timing Services. The Time Collection variable has three states:

- a) *inactive*;
- b) *collecting data*;
- c) *collection complete* (but not yet read out).

### 4.2.4 DIRECTIVE DECODER

Implementations of the Proximity-1 Space Link Protocol shall include a Directive Decoder function for processing supervisory protocol directives defined in 3.2.8 and annex A.

## CCSDS RECOMMENDED STANDARD FOR PROXIMITY-1 SPACE DATA LINK PROTOCOL

NOTE – The Directive Decoder is a function that decodes supervisory protocol directives received either from the local Proximity link controller or from the remote vehicle controller. The directive decoder processes the received directives, setting the configuration (state and parameters) of both the Physical and Data Link layers.

## 4.2.5 MAC BUFFERS

### 4.2.5.1 SENT\_TIME\_BUFFER

The SENT\_TIME\_BUFFER shall store all of the egress clock times and associated frame sequence numbers when TIME\_COLLECTION is in either the ‘*collecting data*’ or the ‘*collection complete*’ state.

### 4.2.5.2 RECEIVE\_TIME\_BUFFER

The RECEIVE\_TIME\_BUFFER shall store all of the ingress clock times and associated frame sequence numbers when TIME\_COLLECTION is in either the ‘*collecting data*’ or the ‘*collection complete*’ state.

## 4.3 DATA SERVICES SUBLAYER

### 4.3.1 OVERVIEW OF FUNCTIONALITY

#### 4.3.1.1 Send Side Functionality

The send side:

- a) runs the FOP-P process;
- b) processes received PLCWs;
- c) acknowledges delivery of complete SDUs to the I/O sublayer;
- d) provides frame accountability to the I/O sublayer;
- e) accepts either an Expedited or a Sequence Controlled frame from the I/O sublayer.

#### 4.3.1.2 Receive Side Functionality

The receive side:

- a) runs the FARM-P process;
- b) accepts U-frames from the frame sublayer.

### 4.3.2 GENERAL

**4.3.2.1** The Data Services sublayer shall control the order of transfer of the user data (including user-supplied directives) that are to be transmitted within the session.

**4.3.2.2** The Data Services sublayer shall provide the following two grades of service:

- a) Expedited service shall ensure transmission without errors of Expedited frame data in the order received;
- b) Sequence Controlled service shall guarantee that data within a communication session are delivered in order without errors, gaps, or duplications.

### NOTES

- 1 The guarantee of reliable data delivery by the Sequence Controlled service is constrained to a single communication session without COP-P resynchronization. Sessions in which COP-P resynchronization occurs may result in duplicate or lost data, because of factors outside the scope of the Proximity-1 protocol.
- 2 The mechanisms provided in this specification will not eliminate duplicate data associated with the transition between the end of one session and the beginning of the next. Elimination of this problem is left to the controlling data system.
- 3 These services are provided by the Communication Operations Procedure for Proximity links (COP-P). The Data Services sending operations are described in 7.1, and the Data Services receiving operations are described in 7.2.

### 4.3.3 OVERVIEW OF THE COP-P PROTOCOL

The COP-P protocol is used with one Sender Node, one Receiver Node, and a direct link between them. The Sender delivers frames to the Receiver. The Receiver accepts all valid Expedited frames, and valid Sequence Controlled frames that arrive in sequence. The Receiver provides feedback to the Sender in the form of a Proximity Link Control Word (PLCW). The Sender uses this feedback to retransmit Sequence Controlled frames when necessary. Expedited Frames are never retransmitted by the COP-P protocol.

Concurrent bi-directional data transfer is a capability. In this case, each node has both sender and receiver functionality as shown in figure 4-1, COP-P Process.

CCSDS RECOMMENDED STANDARD FOR PROXIMITY-1 SPACE DATA LINK PROTOCOL

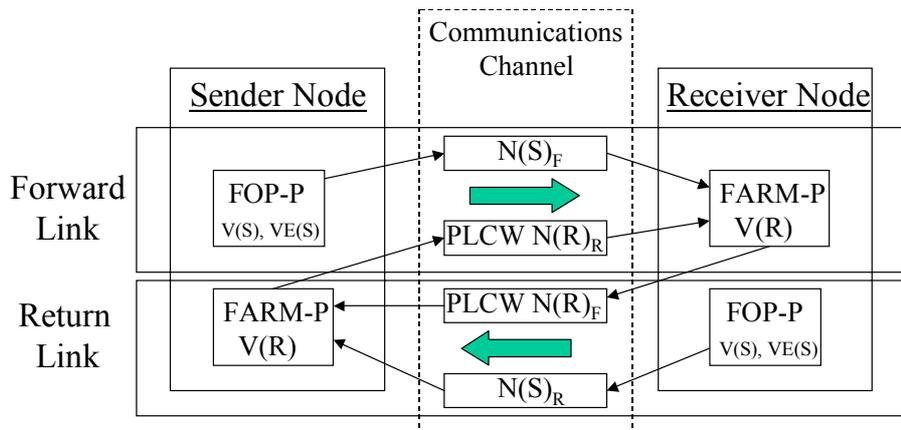

Notes:

- 1 The User data frames (U-frames) in the forward link contain the frame sequence number  $N(S)_F$ . The U-frames in the return link contain the frame sequence number  $N(S)_R$ .
- 2 The PLCW Supervisory protocol frames (P-frames) in the forward link are reporting return link progress and contain the frame sequence number  $N(R)_R$ . The P-frames in the return link are reporting forward link progress and contain the frame sequence number,  $N(R)_F$ .

**Figure 4-1: COP-P Process**

Both the Sender Node and the Receiver Node contain two types of procedures: the send side procedures, i.e., the Frame Operations Procedures for Proximity links (FOP-P); and the receive side procedures, i.e., the Frame Acceptance and Reporting Mechanism for Proximity links (FARM-P).

The FOP-P drives the Expedited and Sequence Controlled services. It is responsible for ordering and multiplexing the user-supplied data and maintaining synchronization with the FARM-P. It initiates a retransmission when required. If a valid PLCW is not received in a reasonable time period (defined by the MIB parameter, *Synch\_Timeout*), the Sender Node's FOP-P notifies the local controller that it is not synchronized with the Receiver Node's FARM-P. If the MIB parameter *Resync\_Local* equals *false*, it is the responsibility of the local controller to decide how synchronization will be re-established. Otherwise, the Sender Node's FOP-P forces a resynchronization by executing the SET V(R) activity.

The FARM-P is data-driven, i.e., it simply reacts to what it receives from the FOP-P and provides appropriate feedback via the PLCW. The FARM-P utilizes the services of the Coding and Synchronization sublayer to verify that the frame was received error free. It depends upon the Frame sublayer to verify that the frame is a valid Version-3 Transfer Frame and that it should be accepted for processing by the Data Services sublayer.

The FOP-P and FARM-P procedures control both Expedited and Sequence Controlled qualities of service.

#### 4.3.4 INTERFACE TO HIGHER SUBLAYER

FOP-P provides frame level accounting, i.e., V(S) and VE(S) to the I/O sublayer for every Sequence Controlled and Expedited frame it numbers.

### 4.4 I/O INTERFACE SUBLAYER

#### 4.4.1 FUNCTIONS

4.4.1.1 Upon input, the I/O interface sublayer shall:

- a) accept for transfer the data for which the user specifies:
  - 1) the required QOS,
  - 2) the output port ID,
  - 3) PDU type (user data or protocol directives),
  - 4) the frame data field construction rules to build a Version-3 Transfer Frame (see 3.2.2.5),
  - 5) Remote\_Spacecraft\_ID,
  - 6) PCID,
  - 7) Source-or-Destination Identifier;
- b) using the value of the MIB parameter, Maximum\_Packet\_Size, organize the received data (including metadata) to form the Frame Data Unit and the Transfer Frame Header (frame sequence number shall be set to null);

NOTE – This process will determine how to integrate the received packets into the frames. It includes segmenting packets (asynchronous data links) when their size is too large to fit within the maximum allowed frame size.

- c) notify the user when an Expedited SDU is radiated;
- d) notify the user when a Sequence Controlled SDU has been successfully transferred across the communication channel.

4.4.1.2 The I/O interface sublayer shall output received and accepted SDUs:

- a) receive U-frames accepted via the lower sublayers;
- b) assemble received segments into packets and verify that each packet is complete;
- c) deliver only complete packets to the user (length of the rebuild packet must match packet length field), and discard incomplete packets;

## CCSDS RECOMMENDED STANDARD FOR PROXIMITY-1 SPACE DATA LINK PROTOCOL

- d) deliver the packets/user-defined data via the specified output port ID in the U-frame header.

#### 4.4.2 INTERFACE TO THE LOWER SUBLAYERS

**4.4.2.1** The I/O interface sublayer shall pass the service data units that require the Sequence Controlled service via the Sequence Controlled queue, and shall pass those for the Expedited service via the Expedited queue.

**4.4.2.2** This sublayer shall provide two queues (Expedited queue and Sequence Controlled queue) for the received U-frames capable of supporting the maximum data rate expected using the communications channel with that transceiver.

**4.4.2.3** For Sequence Controlled service, the I/O sublayer maintains an association between each SDU provided to the Data Services sublayer and the frame sequence number of the frame which contains the last octet of that SDU.

**4.4.2.4** For Sequence Controlled service, the I/O sublayer evaluates NN(R) to validate that a complete SDU was received from the Data Services sublayer, and notifies the user when acknowledged transfer of the SDU has been accomplished.

#### 4.4.3 I/O SUBLAYER QUEUES AND ASSOCIATED CONTROL SIGNALS

**4.4.3.1** While any data units are stored within the Sequence Controlled Frame queue, SEQUENCE\_CONTROLLED\_FRAME\_AVAILABLE shall be *true*; otherwise, it shall be *false*.

NOTE – The Sequence Controlled Frame queue contains Sequence Controlled frames that are ready for transmission but have not yet been sent. This name is abbreviated to ‘SEQ queue’ in the COP-P Sender state table (FOP-P).

**4.4.3.2** While any data units are stored within the Expedited Frame queue, EXPEDITED\_FRAME\_AVAILABLE shall be *true*; otherwise, it shall be *false*.

NOTE – The Expedited Frame queue contains Expedited frames that are ready for transmission but have not yet been sent. This name is abbreviated to ‘EXP queue’ in the COP-P Sender state table (FOP-P).

**4.4.3.3** When the Data Services sublayer extracts a frame from either queue, that frame is permanently removed from the queue, and the appropriate frame available parameter is re-evaluated.

NOTE – The local directive, CLEAR QUEUE (*Queue Type*) allows for the clearing of frames based upon the queue type specified in the directive.

.....

Blank page

## 5 PROXIMITY-1 TIMING SERVICES

### 5.1 COUPLED NON-COHERENT PROXIMITY TIMING SERVICE

5.1.1 Timing Services are required for Proximity operations in order to provide the following three capabilities:

- a) on-board Proximity clock correlation between Proximity nodes;
- b) time transfer to a Proximity node;
- c) coupled non-coherent time-derived ranging measurements between Proximity nodes.

5.1.2 All three of these capabilities require that MODE is *active* and the transceiver is operating in the Data Services sublayer. Timing Services can occur in full duplex, half duplex, or simplex operations.

NOTE – Timing services can occur concurrently with other data-taking activities. The method utilized to carry out the timing services is specified in 5.2.

### 5.2 PROXIMITY TIME CORRELATION

#### 5.2.1 OVERVIEW

The same time-tag capture method is used as the basis for all three time services capabilities. The method requires that both the initiating and recipient transceiver shall have the capability of time tagging the trailing edge of the last bit of the Attached Synchronization Marker of every incoming and every outgoing Proximity frame. This method allows for the simultaneous time tagging of transfer frames upon ingress to and egress from a Proximity transceiver (two-way) as well as one-way time tagging depicted in figure 5-1. The time code format is provided in reference [7], i.e., the unsegmented time code of 4 bytes of course time (> 1 sec) and 3 bytes of fine time (< 1 sec). See figure 5-1, Proximity Time Tagging and Time Correlation.

#### 5.2.2 TIME TAG CAPTURE METHOD

The time tag capture method shall be composed of the following steps:

- a) The vehicle controller shall issue a SET CONTROL PARAMETERS (*local time tag*) directive to the initiating transceiver, instructing it to capture its local time reference and associated frame sequence numbers over a commanded interval of frames. Upon receipt of this directive, the MAC sublayer shall set the TIME\_COLLECTION variable from *inactive* to *collecting data*, indicating that time collection has started.
- b) The initiating transceiver shall build and transmit the SET CONTROL PARAMETERS (*Time Sample*) directive. Upon egress of each frame during the commanded interval (based upon the value of Time Sample), the initiating transceiver shall capture the

time and frame sequence number of every Proximity frame being radiated. The application processes, which use the collected data, will also require information about any internal signal path delays associated with the radiation process. Once the commanded interval has been reached (the prescribed number of frame time tags have been captured), the MAC sublayer shall set the TIME\_COLLECTION variable to *collection complete*, indicating that those times and sequence numbers are available for transfer. Coincidentally upon receipt of the SET CONTROL PARAMETERS directive, the recipient transceiver shall identify and decode the directive and capture the subsequent time and frame sequence number of every Proximity frame received over the commanded interval. The recipient transceiver shall also keep track of any internal signal path delays in the process. Upon readout of the collected data set, TIME\_COLLECTION shall be set to *inactive*.

- c) When the time collection process is completed, both the initiating and remote transceivers shall transfer their captured times, associated frame sequence numbers, and direction (indication of whether time tagging was performed upon frame egress or ingress) of every transmitted and received Proximity-1 frame over the commanded interval to their respective vehicle controllers.
- d) The vehicle controller (CDS) shall create a Proximity time correlation packet consisting of the series of points (time tag, frame sequence number, time tag direction) it received from its local transceiver collected over the commanded interval. In addition, the internal signal path delays in the transmission and reception chains of the transceiver are required to be known a priori.

#### NOTES

- 1 Time tag direction is labeled as either egress or ingress.
- 2 The internal delays may have coding and rate components.
- 3 These time correlation packets need to be processed together.
- 4 Simultaneous collections of time correlation packets in both directions would increase the accuracy of the processing.
- 5 By exchanging time correlation packets, either node can compute the correlation between the two Proximity clocks.
- 6 The REPORT REQUEST Directive (annex A) can be used to initiate a request to the remote transceiver to start up a time tag exchange.
- 7 A separate TIME\_COLLECTION variable is required for two-way operations (simultaneous time tagging in both directions).

CCSDS RECOMMENDED STANDARD FOR PROXIMITY-1 SPACE DATA LINK PROTOCOL

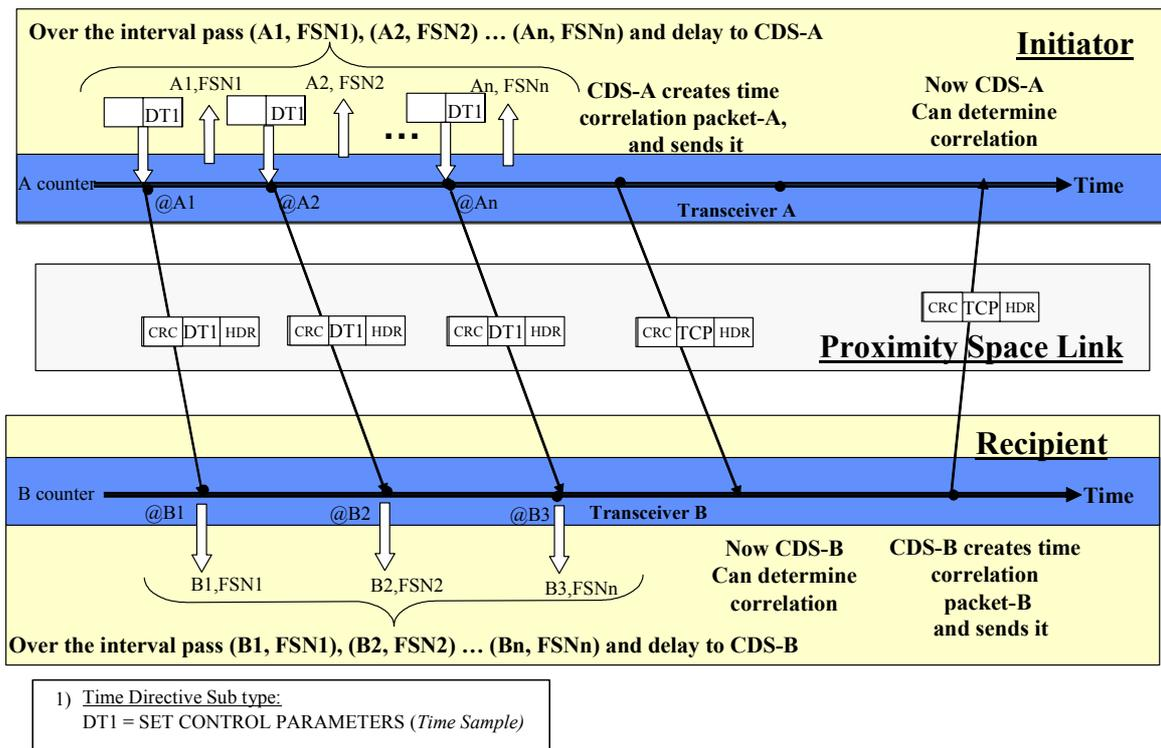

Figure 5-1: Proximity Time Tagging and Time Correlation

5.2.3 TRANSFERRING TIME TO A REMOTE ASSET

NOTE – In order to transfer time to a remote asset (i.e., the recipient), the initiator must know the correlation between the initiator’s clock and the recipient’s clock. It is also assumed that the initiator maintains a correlation between the master clock for the Enterprise and its local Proximity clock.

The method for transferring time to a remote asset shall consist of the following steps:

- a) As soon as possible after a Proximity time correlation between the initiator and recipient is completed, the initiator shall build and transmit the TIME DISTRIBUTION (*Time Transfer*) directive over the Proximity link. This directive contains the correlation between the Enterprise’s master clock and the recipient’s clock.
- b) The recipient transceiver shall decode the directive and transfer the contents of the directive (the Enterprise’s master clock to local Proximity clock correlation) to its vehicle controller.
- c) The recipient vehicle controller shall apply the correlation in order either to project the Enterprise’s master clock values into the future, or to correct past clock values.

NOTE – See figure 5-2, Transferring Time to a Remote Asset.

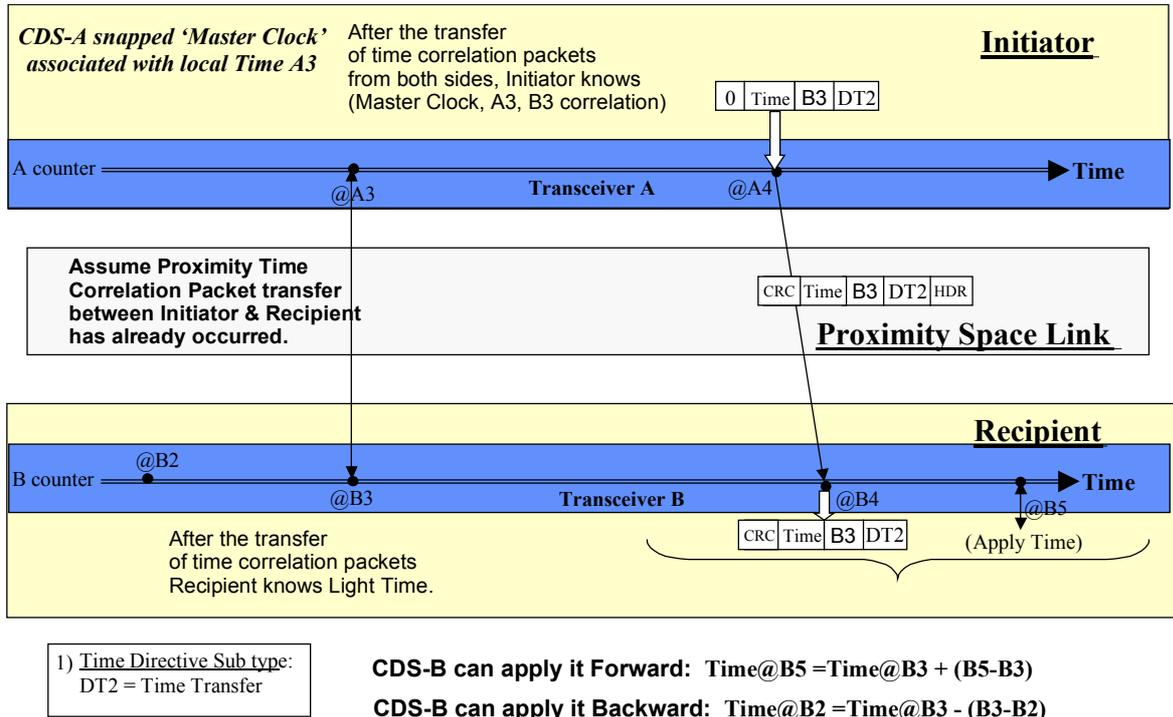

Figure 5-2: Transferring Time to a Remote Asset

## 6 DATA SERVICES OPERATIONS

### 6.1 OVERVIEW

Section 6 consists of a comprehensive set of state tables, state variable descriptions, and state diagrams for Proximity-1 data services operations. Table 6-1 provides a roadmap to help navigate through this section.

**Table 6-1: Proximity-1 Data Services Operations Roadmap**

Operations	Applicable Proximity-1 State Tables	Applicable State Transition Tables	Applicable State Transition Diagram
Full Duplex	Tables 6-2, 6-3	Session Establishment and Data Services: table 6-7  COMM_CHANGE: table 6-8  Session Termination: table 6-9	Full Duplex Operations: figure 6-1
Half Duplex	Tables 6-2, 6-4	Session Establishment and Data Services: table 6-10  COMM_CHANGE: table 6-11  Session Termination: table 6-12	Half Duplex Operations: figure 6-2
Simplex	Tables 6-2, 6-5	Simplex State Transition Table: table 6-13	Simplex Operations: figure 6-3

### 6.2 PROXIMITY-1 STATE TABLES

#### 6.2.1 OVERVIEW

The operating states for the Proximity-1 protocol are shown in tables 6-2 through 6-5. These states are dependent on four state-controlling variables: DUPLEX, MODE, TRANSMIT (T), and SUB-STATE (SS). The Receive and Send State Descriptions consist of the values *off*, *on*, *synchronous* (channel) and *asynchronous* (channel). Currently, Proximity-1 is solely defined for asynchronous data links. See 1.5.1.2 for these definitions.

Table 6-2: States Independent of the DUPLEX Variable

State Name	State Description	Receive State Desc.	Send State Desc.	MODE	T	SS	DESCRIPTION
S1	Inactive	<i>off</i>	<i>off</i>	<i>inactive</i>	N/A	0	The only actions that are permitted in state S1 are those in response to local directives. In this state the Data Services operational variables and MIB parameter values can be modified and their status read via local directives from the local controller. When the protocol enters this state the variables identified in table 6-6 are initialized. The Local SET INITIALIZE MODE directive will force entry to this state.
S2	Waiting for HAIL	<i>on</i>	<i>off</i>	<i>connecting-L</i>	N/A	0	In this state, receiving operations are enabled. FARM-P operations are enabled but only for processing received supervisory directives; i.e., transfer frame header PDU TYPE ID = '1'. Note that only receiving operations are enabled so that transmission is not permitted.

Table 6-3: States When DUPLEX = Full

State Name	State Description	Receive State Desc.	Send State Desc.	MODE	T	SS	DESCRIPTION
S31	Start Hail Action	<i>on</i>	<i>async</i>	<i>connecting-T</i>	<i>on</i>	1	In this state the HAIL Activity starts with the radiation of the carrier signal.
S32	Send Hail Acquisition	<i>on</i>	<i>async</i>	<i>connecting-T</i>	<i>on</i>	2	In this state the idle pattern is radiated to achieve bit lock with the hailed remote unit.
S33	Send Hail Directives	<i>on</i>	<i>async</i>	<i>connecting-T</i>	<i>on</i>	3	In this state the HAIL directives (SET_TRANSMITTER_PARAMETERS and SET_RECEIVER_PARAMETERS) are radiated to initiate a session with the hailed remote unit, i.e., the responder.
S34	Send Hail Tail	<i>on</i>	<i>async</i>	<i>connecting-T</i>	<i>on</i>	4	In this state the idle pattern is radiated to allow the HAIL directives to be received and processed through the decoding chain of the responder.
S35	Wait for Hail Response	<i>on</i>	<i>async</i>	<i>connecting-T</i>	<i>off</i>	5	In this state the transmitter is turned off and the receiver awaits a response from the hailed remote unit.
S41	Radiate Carrier Only	<i>on</i>	<i>sync</i>	<i>active</i>	<i>on</i>	1	In this state the receiver is <i>on</i> and ready to process all received data while the transmission process is started with carrier radiation only.
S42	Radiate Acquisition Idle	<i>on</i>	<i>sync</i>	<i>active</i>	<i>on</i>	2	In this state the receiver is <i>on</i> and processing all received data while the transmission process is trying to achieve bit lock with a potential partnered transceiver, i.e., the caller transceiver.

Table 6-3: States When DUPLEX = Full (continued)

State Name	State Description	Receive State Desc.	Send State Desc.	MODE	T	SS	DESCRIPTION
S40	Data services	<i>on</i>	<i>sync</i>	<i>active</i>	<i>on</i>	0	In this state data transfer services controlled by the COP-P protocol are conducted with a partnered transceiver.
S48	COMM_CHANGE	<i>on</i>	<i>sync</i>	<i>active</i>	<i>on</i>	6	This state is involved with the protocol actions required to perform a data rate or frequency change with a partnered transceiver. This state contains numerous sub-states whose transitions are described in table 6-8.
S45	Terminating Tail	<i>on</i>	<i>sync</i>	<i>active</i>	<i>on</i>	4	In this state the receiver is <i>on</i> and processing all received data while the transmission process is terminating. See table 6-9.

Table 6-4: States When DUPLEX = Half

State Name	State Description	Receive State Desc.	Send State Desc.	MODE	T	SS	DESCRIPTION
S11	Start Hail Action	<i>off</i>	<i>async</i>	<i>connecting-T</i>	<i>on</i>	1	In this state the HAIL Activity starts with the radiation of the carrier signal.
S12	Send Hail Acquisition	<i>off</i>	<i>async</i>	<i>connecting-T</i>	<i>on</i>	2	In this state the idle pattern is radiated to achieve bit lock with the hailed remote unit.
S13	Send Hail Directives	<i>off</i>	<i>async</i>	<i>connecting-T</i>	<i>on</i>	3	In this state the HAIL directives (SET_TRANSMITTER_PARAMETERS and SET_RECEIVER_PARAMETERS) are radiated to initiate a session with the hailed remote unit, i.e., the responder.
S14	Send Hail Tail	<i>off</i>	<i>async</i>	<i>connecting-T</i>	<i>on</i>	4	In this state the idle pattern is radiated to allow the HAIL directives to be received and processed through the decoding chain of the responder.
S36	Wait for Hail Response	<i>on</i>	<i>off</i>	<i>connecting-T</i>	<i>off</i>	5	In this state the transceiver awaits a response from the called remote unit.
S51	Radiate Carrier Only	<i>off</i>	<i>sync</i>	<i>active</i>	<i>on</i>	1	In this state the transmission process is started with carrier radiation only.
S52	Radiate Acquisition Idle	<i>off</i>	<i>sync</i>	<i>active</i>	<i>on</i>	2	In this state the transmission process is trying to achieve bit lock with a potential partnered transceiver.
S50	Data Services (send)	<i>off</i>	<i>sync</i>	<i>active</i>	<i>on</i>	0	In this state the user data transmission process functions.
S54	Terminate Reply	<i>off</i>	<i>sync</i>	<i>active</i>	<i>on</i>	3	In this state the transmission process is sending the termination directive.

Table 6-4: States When DUPLEX = Half (continued)

State Name	State Description	Receive State Desc.	Send State Desc.	MODE	T	SS	DESCRIPTION
S55	Tail Before Quit	<i>off</i>	<i>sync</i>	<i>active</i>	<i>on</i>	7	In this state the transmission process is sending the terminating tail sequence bits.
S56	Token Pass or COMM_CHANGE	<i>off</i>	<i>sync</i>	<i>active</i>	<i>on</i>	6	In this state the transmission process is sending either a Token or the COMM_CHANGE directive.
S58	Tail before Switch	<i>off</i>	<i>sync</i>	<i>active</i>	<i>on</i>	4	In this state the transmission process is sending the terminating tail sequence bits.
S60	Data Services (receive)	<i>on</i>	<i>off</i>	<i>active</i>	<i>off</i>	0	In this state the receiver is processing received data.
S61	Awaiting First Frame	<i>on</i>	<i>off</i>	<i>active</i>	<i>off</i>	1	In this state the receiver is <i>on</i> , waiting receipt of the first frame for processing.
S62	Wait for Carrier	<i>on</i>	<i>off</i>	<i>active</i>	<i>off</i>	2	In this state the receiver is <i>on</i> , waiting for the CARRIER_ACQUIRED physical layer signal to transition to <i>true</i> .

Table 6-5: States When DUPLEX = Simplex (receive or transmit)

State Name	State Description	Receive State Desc.	Send State Desc.	MODE	T	SS	DESCRIPTION
S71	Simplex Transmit	<i>off</i>	<i>on</i>	<i>active</i>	<i>on</i>	0	In this state only the transmission operations are enabled while receiving operations are inhibited.
S72	Simplex Receive	<i>on</i>	<i>off</i>	<i>active</i>	<i>off</i>	0	In this state only the receiving operations are enabled while transmission operations are inhibited.

## CCSDS RECOMMENDED STANDARD FOR PROXIMITY-1 SPACE DATA LINK PROTOCOL

**6.2.2 STATE CONTROL VARIABLES**

NOTE – These variables are contained within the Proximity-1 State Tables: MODE, DUPLEX, TRANSMIT, and SUB-STATE.

**6.2.2.1 MODE**

The MODE parameter shall provide control information for operations within the Data Link layer, and control operations within the Physical layer. The allowable states of MODE (set via the local SET MODE directive) are as follows:

- a) **inactive**: In the Inactive state the transceiver's transmitter and receiver shall both be turned off.
- b) **connecting-T**: In the Physical layer, the Connecting-Transmit state in full duplex shall dictate that the receiver (sequentially in half duplex) and transmitter are powered on and enabled to process received frames, and that the transmitter is enabled for asynchronous channel operations. (In half duplex, only the transmitter is powered on.) The Hail Activity shall be conducted while MODE is *connecting-T*.
- c) **connecting-L**: In the Connecting-Listen state, the receiver shall be powered on and enabled to process received frames while the transmitter is turned off.
- d) **active**: In the Active state the receiver shall be powered on and enabled to process received frames; the transmitter shall be enabled for synchronous channel operations responding to the control of the TRANSMIT parameter.

NOTE – The Local SET INITIALIZE MODE directive puts MODE into the inactive state, and initializes the COP-P variables described in 6.3.6.1.2, SET INITIALIZE MODE.

**6.2.2.2 DUPLEX**

DUPLEX shall identify the physical channel communications characteristics so that the protocol can perform within the transceiver's operational constraints. The allowable values of DUPLEX (set via the local SET DUPLEX directive) shall be:

- a) **full**: both the receiver and transmitter shall be simultaneously enabled;
- b) **half**: operation switches between receiving and transmitting within a communications session, with only the receiver or the transmitter enabled at one time;
- c) **simplex transmit**: the transmitter but not the receiver shall be enabled;
- d) **simplex receive**: the receiver but not the transmitter shall be enabled.

### 6.2.2.3 TRANSMIT

The TRANSMIT parameter shall be used to control Physical layer operations when MODE is not equal to *inactive*. This parameter has two states, as follows:

- a) *off*: the Physical layer shall be signaled to transition the transmitter to *off*;
- b) *on*: the Physical layer shall be signaled to transition the transmitter to *on*.

### 6.2.2.4 SS (SUB-STATE)

The SS variable shall be used to keep track of sequencing through Proximity-1 states in response to events in order to uniquely identify these states. It is also used to determine what data to load into the output FIFO. See table 6-14.

## 6.2.3 OPERATIONAL CONTROL VARIABLES

### 6.2.3.1 X (Session Termination)

X (Session Termination) shall be used to track the sub-states of the full and half duplex session termination process. In half duplex, it shall be shared between receive and transmit functionality. The values and definitions of the states of X are as follows:

- a) X=0: Bi-directional data passing in progress. Neither transceiver has declared that it is out of data to send. Used in full and half duplex.
- b) X=1: Local transceiver informed that there is locally no more data to send, i.e., LOCAL\_NO\_MORE\_DATA (LNMD). Used in half duplex only.
- c) X=2: Local transceiver has received the LNMD local directive and is sending the REMOTE\_NO\_MORE\_DATA (RNMD) directive to the remote transceiver. When an RNMD directive is received in this state, session termination begins. Used in full and half duplex.
- d) X=3: Local transceiver has data to send and it has received an RNMD directive from the remote transceiver. Used in half duplex only.
- e) X=4: Local transceiver has received the RNMD directive. When there is locally no more data to send, an RNMD directive is sent to the remote transceiver. Used in full and half duplex.
- f) X=5: Both local and remote transceivers have no more data to send. Once the RNMD directive is sent, the session is terminated and X is reset to 0. Used in full- and half duplex.

## CCSDS RECOMMENDED STANDARD FOR PROXIMITY-1 SPACE DATA LINK PROTOCOL

**6.2.3.2 Y (COMM\_CHANGE)**

Y (COMM\_CHANGE) shall be used to track the sub-states during the commanding of a Physical layer communications change. In half duplex, it shall be set on the transmit side and reset on the receive side. Valid values for Y in both full and half duplex shall be: 0 through 3. Values 4 and 5 pertain to full duplex only. The values and the states of Y are as follows:

- a) Y=0: No COMM\_CHANGE in progress.
- b) Y=1: Local directive received to initiate the COMM\_CHANGE (LCCD).
- c) Y=2: COMM\_CHANGE Directive being sent across the Proximity link.
- d) Y=3: COMM\_CHANGE Directive sent, and now waiting for the COMM\_CHANGE acknowledgement.
- e) Y=4: Receive the Remote COMM\_CHANGE Directive (RCCD). Used only in Full duplex.
- f) Y=5: Act upon the remote COMM\_CHANGE Directive received (RCCD). Used only in Full duplex.

**6.2.3.3 Z (BIT\_INLOCK\_STATUS)**

Z (BIT\_INLOCK\_STATUS) shall be used during a Physical layer communications change to track non-deterministic events within State 48 (COMM\_CHANGE in Data Services), as follows:

- a) Z=0: BIT\_INLOCK\_STATUS has not transitioned to *false*;
- b) Z=1: BIT\_INLOCK\_STATUS has transitioned to *false*.

**6.2.3.4 MODULATION**

MODULATION is an interface variable with the Physical layer which shall control the modulation of the transmitted carrier. When MODULATION=*true* (on), the data are modulated onto the radiated carrier; when MODULATION=*false* (off), the radiated output is not modulated (i.e., carrier only).

**6.2.3.5 PERSISTENCE**

See 4.3.2, Persistent Activity Process.

### 6.2.3.6 NEED\_PLCW and NEED\_STATUS\_REPORT

6.2.3.6.1 NEED\_PLCW and NEED\_STATUS\_REPORT shall be used in the data selection for output process to determine if a PLCW or status report should be sent. These variables where applicable shall be set to *true*:

- a) at initialization;
- b) by events in the state transition processes;
- c) by PLCW Timer; and
- d) by actions within the COP-P.

6.2.3.6.2 NEED\_PLCW shall be set to *false* when a PLCW is selected for output. NEED\_STATUS\_REPORT shall be set to *false* when a status report is selected for output.

### 6.2.3.7 REMOTE\_SCID\_BUFFER

REMOTE\_SCID\_BUFFER holds the value of the spacecraft ID that shall be used in testing all frames whose Source-or-Destination ID is set to *destination*.

### 6.2.3.8 COMMUNICATION\_VALUE\_BUFFER

COMMUNICATION\_VALUE\_BUFFER shall be used to hold the communication values for the HAIL and COMM\_CHANGE directives and operations.

### 6.2.3.9 RECEIVING\_SCID\_BUFFER

RECEIVING\_SCID\_BUFFER shall be used in the frame acceptance process to compare a received spacecraft ID value with that held within this buffer. This buffer may be loaded by a directive from the local vehicle controller, or it may be loaded with the spacecraft ID contained in the first valid received frame.

### 6.2.3.10 RECEIVING\_PCID\_BUFFER

RECEIVING\_PCID\_BUFFER shall be used in the frame reception process. This buffer shall be loaded with the PCID contained in the first valid received frame.

## 6.2.4 MIB PARAMETERS

### 6.2.4.1 Local\_Spacecraft\_ID

Local\_Spacecraft\_ID shall contain the value of the spacecraft ID for this Protocol Unit (this local spacecraft).

#### 6.2.4.2 Test\_Source

The Test\_Source parameter shall be used to determine whether the received frames whose Source-or-Destination IDs are set to *source* shall be tested for acceptance. Test\_Source=*false* means no test shall be performed. Test\_Source=*true* means a test shall be performed if the RECEIVING\_SCID\_BUFFER is non-zero, i.e., contains a valid SCID. When the RECEIVING\_SCID\_BUFFER is zero and Test\_Source is *true*, the value of the SCID field in the header of the first received frame whose Source-or-Destination ID is *source* shall be loaded into RECEIVING\_SCID\_BUFFER.

#### 6.2.4.3 Carrier\_Only\_Duration

Carrier\_Only\_Duration represents the time that shall be used to radiate an unmodulated carrier at the beginning of a transmission.

#### 6.2.4.4 Acquisition\_Idle\_Duration

Acquisition\_Idle\_Duration represents the time that shall be used to radiate the idle sequence pattern after carrier only to enable the receiving transceiver to achieve bit synchronization and decoder lock.

#### 6.2.4.5 Tail\_Idle\_Duration

Tail\_Idle\_Duration represents the time that shall be used to radiate the idle sequence pattern at the end of a transmission to enable the receiving transceiver to process the last transmitted frame (i.e., push the data through the decoders).

#### 6.2.4.6 Carrier\_Loss\_Timer\_Duration

Carrier\_Loss\_Timer\_Duration is the value loaded into the CARRIER\_LOSS\_TIMER based upon the conditions defined in 6.3.2 (CARRIER\_LOSS\_TIMER and Associated Events).

#### 6.2.4.7 Comm\_Change\_Waiting\_Period

Comm\_Change\_Waiting\_Period represents the time that the caller will wait for the Comm\_Change\_Response to the COMM\_CHANGE directive.

#### 6.2.4.8 Comm\_Change\_Response

The acknowledgement by the responder that the persistent activity has been accepted. For the Full Duplex Comm\_Change\_Response see table 6-8, Events E17 and E20. For the Half Duplex Comm\_Change\_Response, see table 6-11, Event E68.

#### 6.2.4.9 Comm\_Change\_Notification

The message provided to the local vehicle controller, e.g., spacecraft C&DH by the caller and/or responder upon success or failure of the COMM\_CHANGE activity. See annex E (Notifications to Vehicle Controller).

#### 6.2.4.10 Comm\_Change\_Lifetime

The time period during which the COMM\_CHANGE activity shall be repeated until the MAC sublayer detects the expected Comm\_Change\_Response. The Comm\_Change\_Lifetime can be locally defined in terms of a duration or a maximum number of times this activity shall be repeated before the activity is aborted.

#### 6.2.4.11 Hail\_Wait\_Duration

Hail\_Wait\_Duration represents the time that the initiating transceiver will wait for a response to the HAIL.

#### 6.2.4.12 Hail\_Response

The acknowledgement by the responder that the persistent activity has been accepted. In this case, either a valid transfer frame has been received or BIT\_INLOCK\_STATUS (physical layer) = *true* (implementation option). For Full Duplex, see table 6-7, Event 9; for Half Duplex, see table 6-10, Event 37.

#### 6.2.4.13 Hail\_Notification

The message provided to the local vehicle controller, e.g., spacecraft C&DH by the caller and/or responder upon success or failure of the persistent activity. See also annex E (Notifications to Vehicle Controller).

#### 6.2.4.14 Hail\_Lifetime

The time period during which the persistent activity shall be repeated until the MAC detects the expected Hail\_Response. The Hail\_Lifetime can be locally defined in terms of a duration or a maximum number of times this activity shall be repeated before the activity is aborted.

#### 6.2.4.15 Hailing\_Channel

The hailing channel is enterprise specific. The default configuration of the Physical layer parameters (established by the enterprise) defines the hailing channel frequencies that enables two transceivers to initially communicate (via a demand or negotiation process) so that they can establish a configuration for the data services portion of the session. Hailing channel assignments are defined in the Physical layer.

## CCSDS RECOMMENDED STANDARD FOR PROXIMITY-1 SPACE DATA LINK PROTOCOL

**6.2.4.16 Hailing\_Data\_Rate**

Data rate assigned during the Hail Activity. Proximity data rates are defined in the Physical layer.

**6.2.4.17 Send\_Duration**

Send\_Duration represents the maximum time that the half duplex transmitter shall transmit data before it relinquishes the Token (transfers to receive).

**6.2.4.18 Receive\_Duration**

Receive\_Duration represents the maximum time that the half duplex receiver is anticipating that the sending side shall be transmitting.

**6.2.4.19 PLCW\_Repeat\_Interval**

PLCW\_Repeat\_Interval represents the maximum transmission time between successive PLCWs, even if PLCWs are not required for Sequence Control operations. A zero value represents an infinite time period.

**6.3 ELEMENTS AND EVENTS THAT AFFECT STATE STATUS**

## NOTES

- 1 The Interval\_Clock applies to all timers. It is a frequency (e.g., 100 Hz) that is used for interval timing. It is recommended that the OUTPUT\_BIT\_CLOCK could be substituted for this clock for counting down the acquisition and tail sequence periods.
- 2 The following behavior applies to all timers: When the timer counts down to 1, the event associated with the timer occurs. Subsequently, the timer then underflows to zero, which is the inactive state for the timer.

**6.3.1 WAIT TIMER (WT) AND ITS ASSOCIATED EVENTS**

NOTE – The WAIT TIMER is a down counter. The count-down is enabled only when the timer is non-zero.

The values loaded into the timer shall represent a desired time value consistent with the Interval Clock frequency. The timer shall be loaded with the required MIB parameter value (see state tables ), and shall be counted down using the Interval\_Clock. The value in the timer shall be counted down until underflow.

## NOTES

- 1 The timer may be reset to zero by specific actions identified in the state transition tables.
- 2 The WAIT TIMER event (WT=1) occurs when the value in the timer/counter is equal to 1. Subsequently, the timer then underflows to zero, which is the inactive state for the timer.

**6.3.2 CARRIER\_LOSS\_TIMER AND ASSOCIATED EVENTS**

The CARRIER\_LOSS\_TIMER:

- a) Contains the duration during which the session shall be maintained even though the carrier is no longer present. This mechanism is intended to reduce complexities from momentary (short term) carrier loss due to multipath or obstacles in the communications path. When the CARRIER\_LOSS\_TIMER counts down to 1: a) this signals that either the spacecraft is no longer in view or the RF null was larger than expected; b) the vehicle controller (see annex E) will be notified and it can decide whether the session shall be terminated or if the link shall be reestablished by re-hailing.
- b) Shall be a down counter that is driven by the Interval Clock. The countdown is enabled only when the timer is non-zero. The value loaded into the timer shall represent a desired time value consistent with the Interval Clock's frequency.
- c) Shall be loaded with the value contained in the MIB parameter Carrier\_Loss\_Timer\_Duration and down counting enabled when the following conditions are simultaneously satisfied:
  - 1) the CARRIER\_ACQUIRED (Physical layer) signal is *false*;
  - 2) the CARRIER\_LOSS\_TIMER value is 0;
  - 3) MODE = *Active*;
  - 4) either [DUPLEX = *full* or (DUPLEX = *half* .AND. TRANSMIT = *off*)].
- d) Shall be reset to zero when the CARRIER\_ACQUIRED (Physical layer) signal is *true*.

NOTE – The CARRIER\_LOSS\_TIMER event occurs when the value in the timer/counter is equal to 1, which indicates that the Carrier signal has not been received for the MIB specified Carrier\_Loss\_Timer\_Duration period. Subsequently, the timer then underflows to zero, which is the inactive state for the timer.

### 6.3.3 PLCW TIMER AND ASSOCIATED EVENTS

The PLCW TIMER shall be used periodically to request the issuance of a PLCW. The PLCW TIMER is a down counter that is driven by the Interval\_Clock. When the PLCW Timer=1, the NEED\_PLCW variable shall be set *true*. Subsequently, the timer then underflows to zero, which is the inactive state for the timer. The Timer shall be loaded with the value in the PLCW\_Repeat\_Interval MIB parameter whenever a PLCW is transmitted (see the COP-P State Tables in section 7 for when the NEED\_PLCW variable is set to *true*).

NOTE – The PLCW TIMER does not appear in the state transition tables.

### 6.3.4 OUTPUT FIFO

NOTE – The Output FIFO is a FIFO cache for the storage of bits that are serially output to the Physical layer for radiation.

The FIFO shall be filled with data per the specification defined in table 6-14. The data in the FIFO shall be serially shifted out using the output clock provided by the Physical layer, which is consistent with the physical link data rate. The ‘Output FIFO =empty’ signals that no data are contained within the FIFO, and more data must be input to the FIFO to keep the output bit stream synchronous.

### 6.3.5 NO\_FRAMES\_PENDING

The No\_Frames\_Pending event shall occur when the Output FIFO becomes empty and there are no frames selectable for output.

### 6.3.6 DIRECTIVES

#### 6.3.6.1 Local Directives

NOTE – Local directives are sent internally, i.e., not across the Proximity link.

##### 6.3.6.1.1 SET MODE

- a) **Connecting-L:** This value shall set the MODE variable to *connecting-listen*.
- b) **Connecting-T:** This value shall set the MODE variable to *connecting-transmit* which starts the HAIL activity.
- c) **Inactive:** This value shall set the MODE variable to *inactive*, and shall initialize the Proximity-1 control variables described in table 6-6.
- d) **Active:** This value shall set the MODE variable to *active*. It is typically used for simplex operations.

#### 6.3.6.1.2 SET INITIALIZE MODE

The SET INITIALIZE MODE directive shall use the directive SET MODE *inactive* to put MODE into the *inactive* state, and shall trigger the COP-P events SE0 and RE0 described in the state tables in 7.1.3.3 and 7.2.1.

#### 6.3.6.1.3 LOCAL COMM\_CHANGE (LCCD)

The LOCAL COMM\_CHANGE directive consists of the functionality identified in the SET TRANSMITTER PARAMETERS and SET RECEIVER PARAMETERS directives, which shall initiate a change in one or more communication channel physical parameters.

NOTE – The Remote COMM\_CHANGE Directive (RCCD) consists of the functionality within the SET TRANSMITTER PARAMETERS and SET RECEIVER PARAMETERS directives and is sent across the Proximity link.

#### 6.3.6.1.4 LOAD COMMUNICATIONS VALUE BUFFER

The LOAD COMMUNICATIONS VALUE BUFFER directive shall load the values for the remote transmitter and receiver associated with either the HAIL, COMM\_CHANGE, or half duplex receiver/transmitter switching activities.

#### 6.3.6.1.5 LOCAL\_NO\_MORE\_DATA (LNMD)

The LOCAL\_NO\_MORE\_DATA directive shall inform the transceiver that the local data source has no more data to send. This directive shall initiate the session termination process.

#### 6.3.6.1.6 SET DUPLEX

The SET DUPLEX directive shall configure the local transmitter and/or receiver for either full duplex, half duplex, or simplex operations.

#### 6.3.6.1.7 SET RECEIVING SCID BUFFER

The SET RECEIVING SCID BUFFER directive shall be used by the vehicle controller to load the RECEIVING\_SCID\_BUFFER.

#### 6.3.6.1.8 READ STATUS

The READ STATUS directive shall selectively read the local status registers and buffers (including timing services) within the transceiver.

## CCSDS RECOMMENDED STANDARD FOR PROXIMITY-1 SPACE DATA LINK PROTOCOL

**6.3.6.2 Remote Directives**

NOTE – Remote directives are sent over the Proximity link. SET TRANSMITTER PARAMETERS and SET RECEIVER PARAMETERS directives (as described below) are used for both the hail directive and for Physical layer communication changes. SET CONTROL PARAMETERS directive is used to 1) swap receive/transmit functionality in half-duplex, 2) terminate the session, 3) change duplex, and 4) set up the timing service.

**6.3.6.2.1 SET TRANSMITTER PARAMETERS**

SET TRANSMITTER PARAMETERS shall be used to set the transmission parameters that control the data rate, encoding, modulation, and frequency in the transceiver receiving the directive. Upon receipt, this transceiver shall use the local directive SET MODE *active* to put the receiver's MODE parameter into the *active* state.

NOTE – This directive is formulated using the values contained in the sender's COMMUNICATION VALUE BUFFER. See annex A for a complete definition.

**6.3.6.2.2 SET RECEIVER PARAMETERS**

SET RECEIVER PARAMETERS shall be used to set the receiver parameters that control the data rate, decoding, modulation, and frequency in the transceiver receiving the directive. Upon receipt this transceiver shall use the local directive SET MODE *active* to put the receiver's MODE parameter into the *active* state.

NOTE – This directive is formulated using the values contained in the sender's COMMUNICATION VALUE BUFFER. See annex A for a complete definition.

**6.3.6.2.3 SET CONTROL PARAMETERS**

NOTE – This directive provides the capability of changing zero or more Proximity-1 control parameters at a time. See annex A for a complete definition.

SET CONTROL PARAMETERS shall be used to provide transmit operational control information during a session. It includes the following fields:

- a) **Token Field:** When this field is non-zero, it notifies the recipient that the sender is relinquishing the 'Send Token' and is switching to receive.
- b) **Remote\_No\_More\_Data Field (RNMD):** When this field is non-zero, it shall notify the recipient that the sending Protocol Unit has no more data to send, and that the session may be terminated when the recipient also has no more data to send.
- c) **Duplex Field:** When this field is non-zero, it shall notify the recipient to change communication directionality (*full, half, simplex-transmit, simplex-receive*).

- d) **Time Sample Field:** When this field is non-zero it shall notify the recipient to capture the time and sequence number for the next n frames received (where ‘n’ is the value, i.e., number of frames contained within the Time Sample Field).

**6.3.7 INITIALIZED PROXIMITY-1 CONTROL VARIABLES (WHENEVER MODE= *inactive*)**

NOTE – These variables are used whenever MODE is set to *inactive*. See table 6-6.

**Table 6-6: Proximity-1 Control Variable Initialization Table**

Variables	Value
TRANSMIT, MODULATION, PERSISTENCE	<i>off, off, false</i>
SS, X, Y and Z	0
WAIT TIMER (WT), CARRIER_LOSS_TIMER, PLCW_TIMER	0

**6.4 STATE TRANSITION TABLES AND DIAGRAMS**

**6.4.1 OVERVIEW**

The following subsections contain State Transition Tables and State Transition Diagrams which should be read in conjunction with one another for completeness.

The State Transition Diagrams are intended to illustrate transitions from one state to another, and the events that trigger them. States are shown in boxes. Events that cause transitions from one state to a resultant state are given in italic text beside arrows that indicate the transition between states.

States, which have a descriptive title, are assigned the letter S and a number in the State Transition Tables. These tables are organized by event number in column 1. Column 2 describes the event that causes the state to transition from the starting state (column 3) to the resulting state (column 4). Column 5 contains any additional actions (in addition to what is described in tables 6-2 through 6-5) that take place as a result of entering that state.

The diagrams do not show all possible states for reasons of simplicity and clarity. For completeness, the State Transition Tables and accompanying text contain a description of all states and events not included in the diagrams.

6.4.2 FULL DUPLEX OPERATIONS

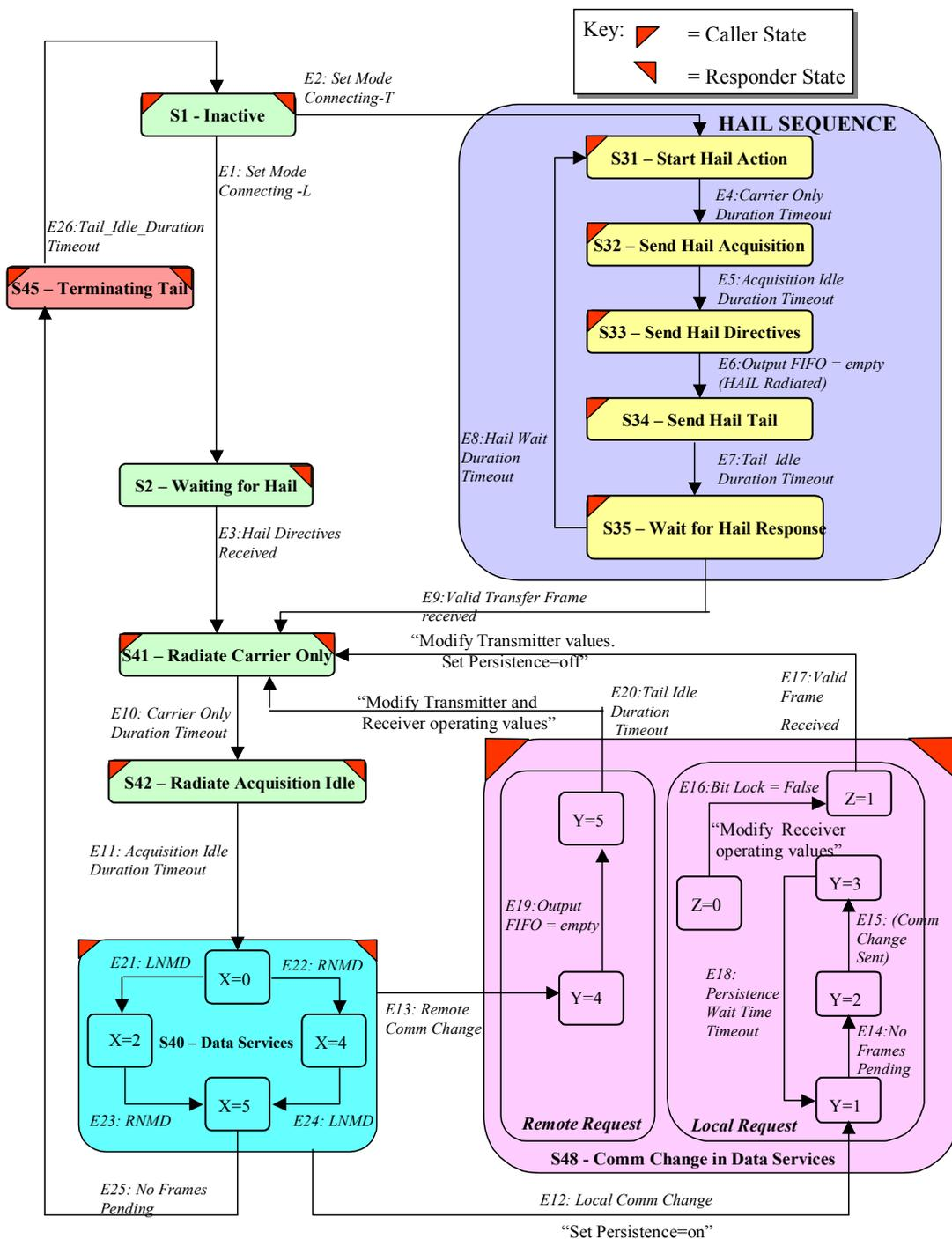

Figure 6-1: Full Duplex State Transition Diagram

**Table 6-7: Full Duplex Session Establishment/Data Services State Transition Table**

Event No.	Event Causing the Transition (Description)	Starting State (from)	Resulting State (to)	Action(s) in Addition to Tables 6-2, 6-3 and Comments
E1	Local Directive - SET MODE <i>Connecting-L</i>	S1	S2	
E2	Local Directive - SET MODE <i>Connecting-T</i>	S1	S31	- WT=Carrier_Only_Duration - Set PERSISTENCE= <i>true</i> - Form and load HAIL Directives into Comm Value Buffer
E3	HAIL Directives Received (Receive SET_TRANSMITTER/ SET_RECEIVER_PARAMETERS Directives)	S2	S41	- WT=Carrier_Only_Duration - Set TRANSMIT = <i>on</i> - Set NEED_PLCW= <i>true</i> - Set Receiver and Transmitter parameters per HAIL directives - Send Hail_Notification to C&DH
E4	WT=1 Carrier_Only_Duration Timeout	S31	S32	- WT=Acquisition_Idle_Duration - Set MODULATION= <i>on</i>
E5	WT=1 Acquisition_Idle_Duration Timeout	S32	S33	- Radiate Hail
E6	Output FIFO=empty	S33	S34	<i>Hail Radiated</i> - WT=Tail_Idle_Duration
E7	WT=1 Tail_Idle_Duration Timeout	S34	S35	- WT=Hail_Wait_Duration - Set TRANSMIT = <i>off</i>
E8	WT=1 Hail_Wait_Duration Timeout	S35	S31	- WT=Carrier_Only_Duration - Set MODULATION= <i>off</i> - Set TRANSMIT = <i>on</i> - if CARRIER ONLY RECEIVED, send carrier received notification to C&DH
E9	Valid Transfer Frame Received (or BIT_INLOCK_STATUS= <i>true</i> — implementation option. See Hail_Response MIB parameter.)	S35	S41	- Set Transmitter values from Comm Value Buffer - WT=Carrier_Only_Duration - Set MODULATION= <i>off</i> - Set PERSISTENCE= <i>false</i> - Send Hail_Notification to C&DH
E10	WT=1 Carrier_Only_Duration Timeout	S41	S42	- WT=Acquisition_Idle_Duration - Set MODULATION= <i>on</i>
E11	WT=1 Acquisition_Idle_Duration Timeout	S42	S40	<i>Data Service begins</i>
NOTE	- FOP-P Data operations (7.1) occur within State 40. FARM-P operations (7.2) occur in States 40, 41, 42 and 48 whenever MODE is active and the receiver is on. Comm Value Buffer is the local MAC buffer used for staging the transmit and receive parameters in support of the hailing and COMM_CHANGE directives. Values can be sent in locally or remotely.			

## CCSDS RECOMMENDED STANDARD FOR PROXIMITY-1 SPACE DATA LINK PROTOCOL

Table 6-8: Full Duplex Communication Change State Table

Event No.	Event Causing the Transition (Description)	Starting State (from)	Resulting State (to)	Action(s) in Addition to Tables 6-2, 6-3 and Comments
E12	LOCAL COMM_CHANGE Request	S40(Y=0)	S48(Y=1)	- Set Y=1 - Set PERSISTENCE= <i>true</i>
E13	Remote COMM_CHANGE Request	S40(Y=0)	S48(Y=4)	- Set Y=4 - Set PERSISTENCE= <i>true</i>
E14	No Frames Pending	S48(Y=1)	S48(Y=2)	- Form and Send Remote COMM_CHANGE Directive (RCCD) - Set Y=2
E15	Output FIFO=empty (COMM_CHANGE sent)	S48(Y=2)	S48(Y=3)	- WT=Persistence_Wait_Time - Set Y=3
E16	Bit Lock = <i>false</i>	S48(Y=1 or 2 or 3)	S48(Z=1)	- Set Z=1 - SET_RECEIVER_PARAMETERS from Comm Value Buffer
E17	Valid Frame Received and Z=1	S48(Z=1)	S41	- Set Y=0 - Set PERSISTENCE= <i>false</i> , - Set Z=0 - SET_TRANSMITTER_PARAMETERS from Comm Value Buffer - WT=Carrier_Only_Duration - Set MODULATION= <i>off</i>
E18	WT=1 Persistence_Wait_Time Timeout	S48(Y=3)	S48(Y=1)	- Set Y=1 <i>No Response to RCCD received yet</i>
E19	Output FIFO = empty	S48(Y=4)	S48(Y=5)	- WT=Tail_Idle_Duration - Set Y=5
E20	WT=1 Tail_Idle_Duration Timeout	S48(Y=5)	S41	- Set Y=0 - Set PERSISTENCE= <i>false</i> - SET_TRANSMITTER_PARAMETERS & SET_RECEIVER_PARAMETERS into Comm Value Buffer - WT=Carrier_Only_Duration, Set MODULATION= <i>off</i>
NOTE – X, Y, Z are sub-state variables used in the process of session termination (X) and COMM_CHANGE (Y, Z).				

**Table 6-9: Full Duplex Session Termination State Table**

Event No.	Event Causing the Transition (Description)	Starting State (from)	Resulting State (to)	Action(s) in Addition to Tables 6-2, 6-3 and Comments
E21	Receive LNMD (X=0)	S40(X=0)	S40(X=2)	- Form and Load RNMD directive into the MAC queue - Set X=2 - Send RNMD
E22	Receive RNMD (X=0)	S40(X=0)	S40(X=4)	- Set X=4
E23	Receive RNMD (X=2)	S40(X=2)	S40(X=5)	- Set X=5 <i>Begin Termination Process</i>
E24	Receive LNMD (X=4)	S40(X=4)	S40(X=5)	- Form and Load RNMD directive into MAC queue - Set X=5 - Send RNMD
E25	No_Frames_Pending (X=5)	S40(X=5)	S45	- WT=Tail_Idle_Duration,
E26	WT=1 Tail_Idle_Duration Timeout	S45	S1	- Local directive SET MODE <i>inactive</i> - Notify vehicle controller: End of Session(# octets received)
E27	CARRIER_LOSS_TIMER Underflows	All states where MODE= <i>active</i>	S1	NOTE – Not Shown on Full Duplex Transition Diagram. - Notify vehicle controller: End of Session(# octets received)
E28	Receive a Local SET MODE = <i>Inactive</i> Directive or SET INITIALIZE MODE Directive	Any state	S1	NOTES 1 Not Shown on Full Duplex Transition Diagram. 2 E28 initializes Prox-1 control variables See table 6-6. - Notify vehicle controller: End of Session(# octets received)
NOTE – LNMD = LOCAL_NO_MORE_DATA Directive received from the local controller; RNMD is the REMOTE_NO_MORE_DATA Directive received over the Proximity link.				

CCSDS RECOMMENDED STANDARD FOR PROXIMITY-1 SPACE DATA LINK PROTOCOL

6.4.3 HALF DUPLEX OPERATIONS

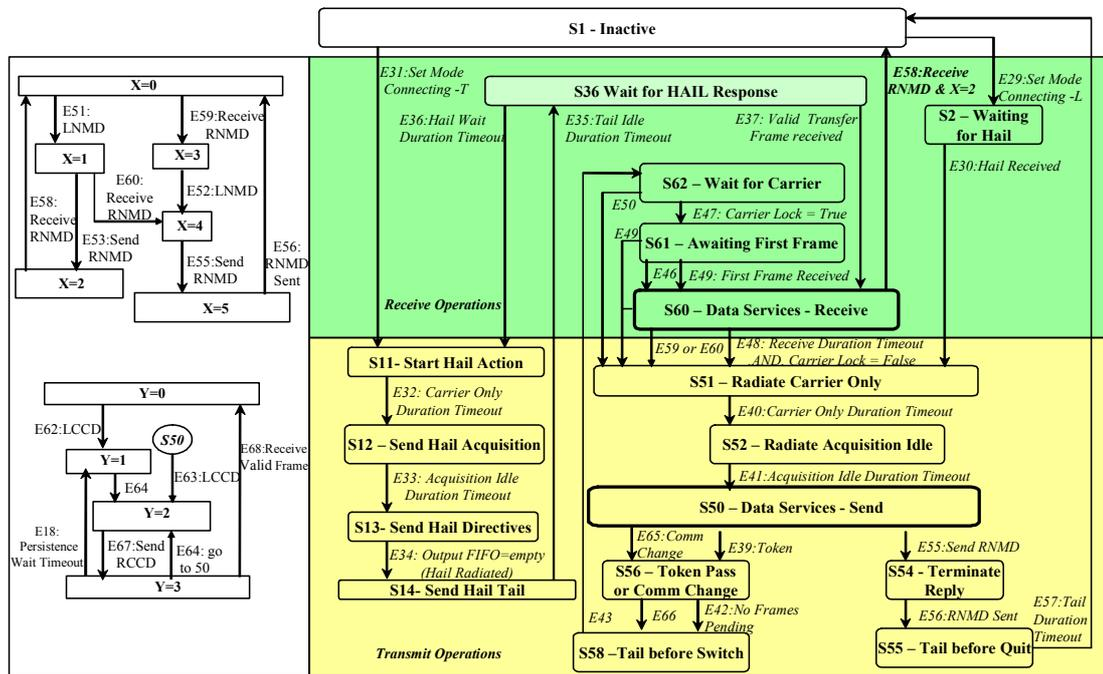

Figure 6-2: Half Duplex State Transition Diagram

Table 6-10: Half Duplex Session Establishment and Data Services

Event No.	Event Causing the Transition (Description)	Starting State (from)	Resulting State (to)	Action(s) in Addition to Tables 6-2, 6-4 and Comments
E29	Local Directive - SET MODE <i>Connecting-L</i>	S1	S2	- Set NEED_PLCW=true
E30	HAIL Received	S2	S51	- WT=Carrier_Only_Duration - Set Receiver and Transmitter values per HAIL directives - Set TRANSMIT = on - Send Hail_Notification to C&DH
E31	Local Directive - SET MODE <i>Connecting-T</i>	S1	S11	- WT=Carrier_Only_Duration - Load HAIL directives to Comm Value Buffer - Set PERSISTENCE = true - Set Receiver Values per HAIL directive
E32	WT=1 Carrier_Only_Duration Timeout	S11	S12	- WT=Acquisition_Idle_Duration - Set MODULATION =on
E33	WT=1 Acquisition_Idle_Duration Timeout	S12	S13	- Radiate HAIL

**Table 6-10: Half Duplex Session Establishment and Data Services (continued)**

Event No.	Event Causing the Transition (Description)	Starting State (from)	Resulting State (to)	Action(s) in Addition to Tables 6-2, 6-4 and Comments
E34	Output FIFO=empty	S13	S14	<b>Hail Radiated</b> - WT=Tail_Idle_Duration
E35	WT=1 Tail_Idle_Duration Timeout	S14	S36	- WT=Hail_Wait_Duration - Set MODULATION = <i>off</i> - Set TRANSMIT = <i>off</i>
E36	WT=1 Hail_Wait_Duration Timeout	S36	S11	- Set TRANSMIT = <i>on</i> - WT=Carrier_Only_Duration - Set Load HAIL directives to Comm Value Buffer - if CARRIER ONLY RECEIVED, send carrier received notification to C&DH
E37	Valid Transfer Frame Received (or BIT_INLOCK_STATUS = <i>true</i> )-implementation option See Hail_Response MIB parameter	S36	S60	- Set Transmitter values per Comm Value Buffer - Set PERSISTENCE= <i>false</i> (get ready for next transmit contact) - WT=Receive_Duration - Send Hail_Notification to C&DH
E38	(Transmit Timer Event – End of Send Period)  WT=1 Send_Duration Timeout	S50	S50	- Set PERSISTENCE= <i>true</i>  <i>Setting PERSISTENCE blocks the transmission of data from data services. Now only send from the MAC queue. Therefore, no frames pending will occur.</i>
E39	No Frames Pending AND. Y=0 .AND. NEED_PLCW is <i>false</i>	S50 Y=0	S56	- Form and Load the Token via SET CONTROL PARAMETERS Directive into the MAC queue
E40	WT=1 Carrier_Only_Duration Timeout	S51	S52	- WT=Acquisition_Idle_Duration - Set MODULATION= <i>on</i>
E41	(End of Acquire)  WT=1 Acquisition_Idle_Duration Timeout	S52	S50	- WT=Send_Duration
E42	No Frames Pending (Y=0)	S56, Y=0	S58	- WT=Tail_Idle_Duration
E43	WT=1 Tail_Idle_Duration Timeout .AND. Y≠2	S58 Y≠2	S62	- WT=Receive_Duration - Set PERSISTENCE= <i>false</i> - Set MODULATION = <i>off</i> - Switch transmit to receive

## CCSDS RECOMMENDED STANDARD FOR PROXIMITY-1 SPACE DATA LINK PROTOCOL

**Table 6-10: Half Duplex Session Establishment and Data Services (continued)**

Event No.	Event Causing the Transition (Description)	Starting State (from)	Resulting State (to)	Action(s) in Addition to Tables 6-2, 6-4 and Comments
E44	WT=1 Receive_Duration Timeout .AND. Carrier Lock= <i>true</i>	S60	S60	- WT=Receive_Duration - Notify vehicle controller: Sender exceeded prescribed transmission interval
E45	WT=1 Receive_Duration Timeout .AND. Carrier Lock= <i>true</i>	S61	S61	- WT=Receive_Duration - Notify vehicle controller: No data transferred during contact period
E46	Receive Valid frame .AND. Y≠3	S61 Y≠3	S60	
E47	Carrier Lock = <i>true</i>	S62	S61	
E48	WT=1 Receive_Duration Timeout .AND. Carrier Lock = <i>false</i>	S60	S51	- WT=Carrier_Only_Duration <i>back-up action for missed token</i> - Switch receive to transmit
E49	Receive Token - SET CONTROL PARAMETERS Directive	S60/S61	S51	- WT=Carrier_Only_Duration - Switch receive to transmit
E50	WT=1 Receive_Duration Timeout .AND. Carrier Lock = <i>false</i>	S62	S51	- WT=Carrier_Only_Duration - Notify vehicle controller: No carrier received for contact period - Switch receive to transmit
NOTE	– FOP-P Data operations occur within State 50 and are described in 7.1. FARM-P operations occur within States 60 and 61 are described in 7.2.1.			

**Table 6-11: Half Duplex Communication Change State Table**

Event No.	Event Causing the Transition (Description)	Starting State (from)	Resulting State (to)	Additional Action(s) and Comments
E62	Receive LOCAL COMM_CHANGE Directive (LCCD)	Any State other than State S50 Y=0	No State Change Y=1	- Load SET TRANSMITTER/SET RECEIVER PARAMETERS Directives values into Comm Value Buffer
E63	Receive LOCAL COMM_CHANGE Directive (LCCD)	S50	S50 Y=2	- Set PERSISTENCE= <i>true</i> - SET RECEIVER PARAMETERS from Comm Value Buffer
E64	Transition to State 50	Y=1 .OR. Y=3	S50 Y=2	- Set Y=2, Set PERSISTENCE= <i>true</i> - SET RECEIVER PARAMETERS from Comm Value Buffer
E65	No Frames Pending .AND. Y=2	S50 Y=2	S56	- Form and load into the Comm Value Buffer the COMM_CHANGE Directives
E66	No Frames Pending	S56 Y=2	S58 Y=2	- WT=Tail_Idle_Duration COMM_CHANGE <i>Sent</i>
E67	WT=1 Tail_Idle_Duration Timeout .AND. Y=2	S58 Y=2	S62 Y=3	-WT=Receive_Duration - Switch transmit to receive
E47	Carrier Lock = <i>true</i>	S62	S61	<i>Same event - provided for clarity</i>
E68	Receive Valid Frame	S61 Y=3	S60 Y=0	- SET TRANSMITTER PARAMETERS from Comm Value Buffer - Set Y=0 - PERSISTENCE= <i>false</i>
E69	Receive COMM_CHANGE (Not Shown in State Transition Diagram)	S60/S61	S51	- Set Transmitter & Receiver Parameters into Comm Value Buffer - Set NEED_PLCW= <i>true</i>

## CCSDS RECOMMENDED STANDARD FOR PROXIMITY-1 SPACE DATA LINK PROTOCOL

Table 6-12: Half Duplex Session Termination State Table

Event No.	Event Causing the Transition (Description)	Starting State (from)	Resulting State (to)	Additional Action(s) and Comments
E51	Receive LNMD (can be received at any time)	X=0	X=1	- Set X=1
E52	Receive LNMD (can be received at any time)	X=3	X=4	- Set X=4
E53	No Frames Pending .AND. X=1	S50 X=1	S50 X=2	- Form and Load RNMD into the MAC queue, - Set X=2 - Send RNMD
E55	No Frames Pending .AND. X=4	S50 X=4	S54 X=5	- Form and Load RNMD into the MAC queue, - Set X=5; Send RNMD
E56	No Frames Pending .AND. X=5	S54 X=5	S55 X=0	- WT=Tail_Idle_Duration - Set X=0 <i>Transmission of RNMD complete</i>
E57	WT=1 Tail_Duration Timeout	S55	S1	- SET MODE Inactive - Notify vehicle controller: End of Session(# octets received)
E58	Receive RNMD .AND. X=2	S60/S61 X=2	S1 X=0	- SET MODE <i>Inactive</i> - Set X=0 <i>Both nodes have no more data to send; Notify vehicle controller: End of Session(# octets received)</i>
E59	Receive RNMD .AND. X=0	S60/S61 X=0	S51 X=3	- Set X=3 <i>WT = Carrier_Duration_Only</i>
E60	Receive RNMD .AND. X=1	S60/S61 X=1	S51 X=4	- Set X=4 <i>WT = Carrier_Duration_Only</i>
E61	Receive a Local SET MODE <i>Inactive</i> directive	any	S1	- SET MODE <i>Inactive</i> - Notify vehicle controller: End of Session(# octets received) <i>Not shown on Half Duplex State Transition Diagram</i>

6.5 SIMPLEX OPERATIONS

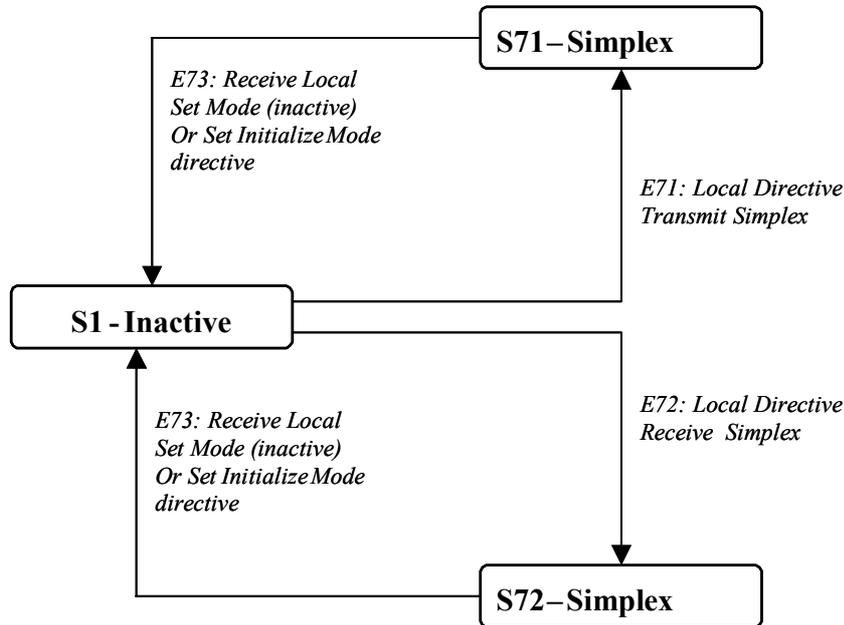

Figure 6-3: Simplex Operations

Table 6-13: Simplex State Transition Table

Event No	Starting State (from)	Resulting State (to)	Event Causing the Transition (Description)	Action(s) in addition to Tables 6-2, 6-5
E71	S1	S71	Receive Local or Remote Directive - Simplex Transmit	- Set DUPLEX = <i>Simplex transmit</i> - Set TRANSMIT = <i>on</i> - Local Directive SET MODE = <i>active</i>
E72	S1	S72	Receive Local or Remote Directive - Simplex Receive	- Set DUPLEX = <i>Simplex receive</i> - Set TRANSMIT = <i>off</i> - Local Directive SET MODE = <i>active</i>
E73	S71 or S72	S1	Receive a Local SET MODE = <i>Inactive</i> Directive	- Notify vehicle controller: End of Session(# octets received)

## 6.6 INTERFACES WITH THE PHYSICAL LAYER

### 6.6.1 OUTPUT INTERFACES

**6.6.1.1** When *on*, the TRANSMIT variable requires the transceiver to have its transmitter 'on'.

**6.6.1.2** The Output Bitstream Port shall supply the series of bits to be radiated.

**6.6.1.3** When *true*, the MODULATION Signal requires the transceiver to modulate the carrier with the data provided on the Output Bitstream.

### 6.6.2 INPUT INTERFACES

- a) OUTPUT\_BIT\_CLOCK. The OUTPUT\_BIT\_CLOCK is provided by the transceiver and shall control the rate at which data are shifted from the Output Bitstream FIFO, via the Output Bitstream Port, to the transceiver's modulator for radiation.
- b) Received Bitstream Data.
- c) Received Bit Clock.
- d) CARRIER\_ACQUIRED. The CARRIER\_ACQUIRED signal shall signal that the receiver has acquired a carrier signal. The CARRIER\_ACQUIRED signal shall be set to *true* when the receiver is locked to the received RF signal, and *false* when not in lock.
- e) BIT\_INLOCK\_STATUS. BIT\_INLOCK\_STATUS shall be used to signal that bit synchronization has been acquired, and that the received serial bit stream is being provided to the C&S sublayer by the Physical layer. The BIT\_INLOCK\_STATUS signal shall be set to *true* when the receiver is confident that its bit detection processes are synchronized to the modulated bit stream, and that the bits output are of an acceptable quality for processing by the Data Link layer. It shall be set to *false* when the receiver is not in bit lock.

## 6.7 SENDING OPERATIONS

### 6.7.1 OVERVIEW

A Local SET TRANSMITTER PARAMETERS and Local SET RECEIVER PARAMETERS directive will set the local transceiver to the desired physical configuration. As required for the session, the loading of the Test\_Source MIB parameter is also completed.

The Local SET MODE (*Connecting-T*) directive initiates the HAIL activity and starts the session establishment process (see 6.4.2 for full duplex operation and 6.4.3 for half duplex operation).

Once a frame is ready for output, an ASM is pre-pended, and a CRC is computed and appended to the frame. The output bitstream is formulated for radiation in accordance with table 6-14.

NOTE – An idle pattern generated by an Idle Pattern Generator (described in reference [8]) is used for acquisition periods, i.e., periods when no frames are available for transmission, as well as for providing a tail stream (which provides the added bits required to push the data through the receiving and decoding processes at the remote terminus of the link).

6.7.2 OUTPUT BITSTREAM FORMULATION

Table 6-14: Data Source Selection for Output Bit Stream with TRANSMIT = on and MODULATION = on

Based Upon the Values Below, Take the Following Action					Action
SS (SUB- STATE)	SPDU Pending	PERSISTENCE	NEED_ PLCW or Status	SDU Pending	Data to be loaded into output FIFO when Output FIFO is empty
2,or4,or7	X	X	X	X	IDLE (Acquisition or Tail)
0,or3,or6	<i>true</i>	X	X	X	ASM+P-frame(SPDU)+CRC
0,or3,or6	<i>false</i>	<i>true</i>	X	X	IDLE
0,or3,or6	<i>false</i>	<i>false</i>	<i>true</i>	X	ASM+PLCW/Status +CRC
0,or3,or6	<i>false</i>	<i>false</i>	<i>false</i>	<i>true</i>	ASM+U-frame(SDU) +CRC
0,or3,or6	<i>false</i>	<i>false</i>	<i>false</i>	<i>false</i>	IDLE

NOTES

- 1 X means do not care what the value is.
- 2 SPDU Pending is *true* if there is a supervisory protocol data unit available to send.
- 3 SDU Pending is *true* if there is a service data unit (user data) available to send.
- 4 When NEED\_PLCW is *true*, NEED\_STATUS\_REPORT can optionally be set to *true*, enabling the generation and transmission of a status report as well.
- 5 PERSISTENCE is a variable used for selected Supervisory protocol activities. See 4.2.2.
- 6 The selection of an SDU issues an extract data unit request to the FOP-P. (See FOP-P data selection, described in 7.1.)

### 6.7.3 PROVISION OF U-FRAME FOR SELECTION

NOTE – The provision of a U-frame for selection through use of the procedures contained in table 6-14 is defined in the FOP-P portion of the COP-P specification (see 7.1). Operations on a single Physical Channel (PC) is described in this specification. The simultaneous use of multiple PCs is possible, but concurrent COP-P procedures are required and the reporting is then required to contain the status for each PC. Data prioritization and its multiplexing for selection into the output bitstream of simultaneous multiple PC operations as specified above is outside the scope of this document.

### 6.7.4 EVENTS RELATED TO DATA HANDLING ACTIVITIES

**6.7.4.1** Reset `NEED_PLCW` or `NEED_STATUS_REPORT` (i.e., set to *false*) shall be generated whenever a PLCW or status report is chosen for output.

**6.7.4.2** `No_Frames_Pending` shall be *true* when none of the conditions for selecting an SPDU (including a PLCW) or U-frame are satisfied.

**6.7.4.3** `Output_FIFO = empty` shall be *true* when the last bit contained within the Output FIFO is extracted.

## 6.8 RECEIVING OPERATIONS

**6.8.1** The SET MODE (*Connecting-L*) or SET MODE (*Connecting-T*) local directives shall establish the physical channel characteristics and initializes the receiving procedures.

**6.8.2** When the Receive State is *on*, the received bitstream shall be processed to delimit the contained frames (this process requires frame synchronization and frame length determination using the frame header length field).

**6.8.3** Frame Validation Criteria are as follows:

- a) The delimited frame and the attached CRC-32 shall be processed to determine if the frame contains errors. Erred frames shall be rejected as invalid.
- b) The Frame Version Number shall equal binary '10'; otherwise the frame shall be rejected as invalid.
- c) The Spacecraft ID (SCID) field in the transfer frame header shall contain the value of the `Local_Spacecraft_ID` (MIB parameter) when the Source-or-Destination Identifier value equals '0', i.e., *destination*; otherwise the frame shall be rejected as invalid.
- d) The Spacecraft ID (SCID) field in the transfer frame header shall contain the value equal to the `RECEIVING_SCID_BUFFER` for all frames received (i.e., `Remote_Spacecraft_ID`, MIB parameter) when the Source-or-Destination Identifier

value equals '1', i.e., *source*, and *Test\_Source* is *true*; otherwise, a session violation has occurred and the vehicle controller shall be notified. See annex E.

NOTE – The *EXPEDITED\_FRAME\_COUNTER* will increment for each validated expedited frame received.

**6.8.4** Validated received User Data frames (U-frames) shall be processed per the COP-P process described in 4.3.3.

**6.8.5** Validated Supervisory Protocol frames (P-frames) shall be processed by first delimiting the contained SPDUs. One or more PLCWs contained within SPDUs shall be transferred to the COP-P processor while all other reports or directives are processed for protocol actions.

## 7 COMMUNICATION OPERATIONS PROCEDURE FOR PROXIMITY LINKS (COP-P)

### NOTES

- 1 An important overview of the COP-P protocol is provided in 4.3.3.
- 2 The sending and receiving procedures for COP-P use single octet variables that are modulo-256 counters. When subtracting or comparing any two of these variables, special handling is required.

Subtraction: The difference,  $A-B$ , is the number of times  $B$  must be incremented to reach  $A$ .

Comparison:  $B < A$  is true if the difference,  $A-B$ , is between 1 and 127.

$B > A$  is true if the difference,  $A-B$ , is between 128 and 255.

$B = A$  is true if the difference,  $A-B$ , is 0.

### 7.1 SENDING PROCEDURES (FOP-P)

#### 7.1.1 QUEUE

The FOP-P shall maintain a single output queue. The **Sent Frame queue** contains Sequence Controlled frames that have been sent but not yet acknowledged by the Receiver. (This name is abbreviated to 'Sent queue' in the state table).

NOTE – The local directive CLEAR QUEUE (*Queue Type*) allows for the clearing of frames within a specified queue.

#### 7.1.2 FOP-P VARIABLES

- a) VE(S): an 8-bit positive integer whose value shall represent the sequence number (modulo 256) of the next Expedited Frame to be sent.
- b) V(S): an 8-bit positive integer whose value shall represent the sequence number (modulo 256) of the next new Sequence Controlled frame to be sent.
- c) VV(S): an 8-bit positive integer whose value shall represent the sequence number (modulo 256) to be assigned to the next Sequence Controlled frame to be sent. It equals V(S) unless a retransmission is in-progress.
- d) N(R): an 8-bit positive integer that is a copy of the Report Value (see 3.2.8) from the current PLCW. It shall represent the sequence number plus one (modulo 256) of the last Sequence Controlled frame acknowledged by the Receiver.

- e) NN(R): an 8-bit positive integer system variable known both inside and outside of the FOP-P state table. It shall contain a copy of the Report Value from the previous valid PLCW.
- f) R(R): a Boolean variable (i.e., its value is either *true* or *false*) that is a copy of the Retransmit Flag from the current PLCW. It shall indicate whether or not Sequence Controlled frame(s) need to be retransmitted.
- g) RR(R): a Boolean variable that is copy of the Retransmit Flag from the previous valid PLCW.
- h) NEED\_PLCW/NEED\_STATUS\_REPORT: Boolean system variables known both inside and outside of the FOP-P state table. See 6.2.3.6 for complete usage. They shall indicate whether or not a new PLCW or status report needs to be sent (the PLCW needs to be sent whenever its contents change).
- i) SYNCH\_TIMER: a countdown timer that contains the time a Sender will wait to receive a valid PLCW from a Receiver before taking action to synchronize with the Receiver. The MIB parameter associated with this timer, Synch\_Timeout, represents a desired time value consistent with the Interval Clock frequency (see 6.3). The SYNCH\_TIMER counts down when its value is non-zero. When the SYNCH\_TIMER counts down to 1, the SYNCH\_TIMER expires and the Start Local Resync Event, SE6 is triggered. Subsequently, the timer then underflows to zero, which is the inactive state for the timer.
- j) RESYNC: a Boolean variable that tracks the status of resynchronization within the COP-P. This variable is set to *true* when the SET V(R) activity occurs, indicating that FOP-P is resynchronizing. It is reset to *false* by the End Local Resync event, SE7.

### 7.1.3 FOP-P STATE TABLE EVENTS

#### 7.1.3.1 General Procedures

- a) 'Initialize':
  - 1)  $V(S) = VE(S) = VV(S) = NN(R) = N(R) = 0$ ,
  - 2)  $R(R) = RR(R) = RESYNC = false$ ,
  - 3)  $NEED\_PLCW$  and  $NEED\_STATUS\_REPORT = true$ ,
  - 4) CLEAR QUEUE (*Sent queue*); CLEAR QUEUE (*Seq queue*);
- b) 'Remove acknowledged frames from Sent queue':
 

remove  $n$  frames from the Sent queue, where  $n = N(R) - NN(R)$  (i.e., the number of times that NN(R) has to be incremented to reach N(R));

## CCSDS RECOMMENDED STANDARD FOR PROXIMITY-1 SPACE DATA LINK PROTOCOL

## c) 'Start SYNCH\_TIMER':

if the SYNCH\_TIMER is equal to 0, set the SYNCH\_TIMER to the value of the MIB parameter Synch\_Timeout;

NOTE – If the value of Synch\_Timeout is 0, then the SYNCH\_TIMER never expires.

## d) 'Clear SYNCH\_TIMER':

Set the SYNCH\_TIMER value to 0;

NOTE - This does not trigger a resynchronization.

## e) 'Store this PLCW':

- 1) assign the value of N(R) to NN(R),
- 2) assign the value of R(R) to RR(R);

## f) 'Send EXP (Expedited) Frame':

- 1) remove frame from EXP queue,
- 2) assign VE(S) to the frame,
- 3) increment VE(S),
- 4) report VE(S) to the I/O sublayer,
- 5) transfer this frame to the Frame sublayer;

## g) 'Resend SEQ (Sequence Controlled) Frame':

- 1) copy frame number VV(S) from the Sent queue,
- 2) increment VV(S),
- 3) transfer this frame to the Frame sublayer;

## h) 'Send New SEQ Frame':

- 1) remove frame from SEQ queue,
- 2) assign V(S) to the frame,
- 3) insert a copy of the frame to the end of the Sent queue,
- 4) increment V(S),
- 5) increment VV(S),
- 6) report V(S) to the I/O sublayer,
- 7) transfer this frame to the Frame sublayer.

**7.1.3.2 SET V(R) Persistent Activity**

NOTE – The SET V(R) persistent activity (including setup of the MIB parameters before the execution of this activity) is defined below. See 4.2.2, ‘Persistent Activity Process’ for a general overview of how the MIB parameters relate to the persistent activity.

**7.1.3.2.1** Configure the SET V(R) persistent activity. The MIB Parameters required for setup are:

- a) Activity is SET V(R), i.e., Resync;
- b) Resync\_Waiting\_Period (implementation specific) is the amount of time specified for the Resync\_Response to be received before the process declares that this activity is to be either repeated or aborted;
- c) Resync\_Response is the acknowledgement from the Receiver Node that the SET V(R) directive has been accepted, i.e., a valid PLCW with report value of N(R) = NN(R) and R(R) = *false* has been received, when RESYNC = *true* (see State S2, Event SE2, FOP-P State table);
- d) Resync\_Notification is a notification to inform the vehicle controller of success or failure of resynchronization;
- e) Resync\_Lifetime (implementation specific) is the time period during which the Resynchronization activity shall be repeated until the Resync\_Response is detected;
- f) Resync\_Local is set to *true*.

**7.1.3.2.2** Execute the SET V(R) persistent activity:

- a) the FOP-P requests a SET V(R) Persistent Activity by setting RESYNC = *true* (see state S1, event SE4 in the FOP-P state table);
- b) the MAC sublayer builds a SET V(R) directive by: 1) copying NN(R) into the SEQ\_CTRL\_FSN field within the SET V(R) directive and 2) setting the PCID field in the SET V(R) directive to the value associated with this FOP-P;
- c) the MAC sublayer loads this directive into the MAC queue for transmission and sets MAC\_FRAME\_PENDING = *true*;
- d) the MAC sublayer sets PERSISTENCE = *true*;

NOTE – This initiates the SET V(R) persistent activity.

- e) the FOP-P terminates the SET V(R) Persistent Activity when the SET V(R) Resync\_Response is received or when the Resync\_Lifetime expires. See 7.1.3.2.1 c).

## CCSDS RECOMMENDED STANDARD FOR PROXIMITY-1 SPACE DATA LINK PROTOCOL

## 7.1.3.3 FOP-P State Table

Event Number/Name	Resulting Action in State S1 Active	Resulting Action in State S2 Resync
SE0 Startup (See note 1)	<i>Initialize.</i> (See note 2)	N/A
SE1 Frame sublayer needs frame to transmit (See note 3)  (See note 4)	If Expedited_Frame_Available=true <i>Send EXP Frame.</i> Else if VV(S) < V(S) # Continue the in-progress retransmission: <i>Resend SEQ Frame.</i> Else if (SEQUENCE_CONTROLLED_FRAME_AVAILABLE=true and V(S)-NN(R)<Transmission_Window) <i>Send New SEQ Frame.</i> Else if NN(R) < V(S) # Initiate a Progressive Retransmission: VV(S)=NN(R) <i>Resend SEQ Frame.</i> Else # There is no Data Services frame to send. Endif	N/A
SE2 Valid PLCW Received (See note 5)	If N(R) > NN(R) <i>Remove acknowledged frames from Sent queue.</i> Endif If R(R) = true or N(R)>VV(S) VV(S) = N(R) Endif <i>Store this PLCW.</i> <i>Clear SYNCH_TIMER.</i>	If R(R) = false and N(R)=NN(R) Resync=false Persistence=false <b>State=S1</b> Endif
SE3 Invalid PLCW Received (See note 5)	<i>Start SYNCH_TIMER.</i> VV(S) = NN(R)	Ignore
SE4 Synch-timer Expired (See note 6)	Notify vehicle controller that <i>SYNCH_TIMER</i> expired (see annex E). If Resync_Local (MIB parameter) = true RR(R)=false Resync=true <b>State=S2</b> Endif	N/A
SE5 Set Transmission_Window Request	Accept. Set.	Accept. Set.

CCSDS RECOMMENDED STANDARD FOR PROXIMITY-1 SPACE DATA LINK PROTOCOL

SE6 Set Synchronisation Timeout Request	Accept. Set.	Accept. Set.
SE7 Reset Request	Accept. <i>Initialize.</i>	Accept. <i>Initialize.</i> <b>State=S1</b>
SE8 Invalid Request	Reject.	Reject.

NOTES

- 1 At program startup, enter state S1 and trigger event SE0 before allowing any other events to occur.
- 2 Procedures are in italics and are described in 7.1.3.1; comments are preceded by the '#' sign.
- 3 'Progressive Retransmission' causes the frames on the Sent queue to be retransmitted.
- 4 Transmission\_Window (MIB parameter): The maximum number of Sequence Controlled frames that can be unacknowledged at any given time. For example, if the Transmission\_Window is 10 and the Sender sends 10 Sequence Controlled frames, the Sender must wait for at least one of those frames to be acknowledged by the Receiver before it can send any additional Sequence Controlled frames. The value of Transmission\_Window cannot exceed 127. When selecting a value for this parameter, the system designer should consider the latency involved whenever frames are required to be retransmitted from the Sent queue before a new Sequence Controlled frame can be transmitted.
- 5 An incoming PLCW is invalid if any of these conditions is true:
  - a) PLCW does not match PLCW format.
  - b)  $N(R) < NN(R)$  'Invalid N(R)—too small'
  - c)  $N(R) > V(S)$  'Invalid N(R)—too large'
  - d)  $R(R) = true$  and  $N(R) = V(S)$  'Retransmit is set though all frames are acknowledged'
  - e)  $R(R) = false$  and  $RR(R) = true$  and  $N(R) = NN(R)$  'Retransmit has cleared though no new frames are acknowledged'

Otherwise, the PLCW is valid.
- 6 Setting Resync=*true* causes a Set V(R) persistent activity to be initiated; see 7.1.3.2, 4.2.2, and annex E.

## CCSDS RECOMMENDED STANDARD FOR PROXIMITY-1 SPACE DATA LINK PROTOCOL

**7.2 RECEIVING PROCEDURES (FARM-P)****7.2.1 FARM-P STATE TABLE**

Events	Event #/Name	Action
'Entered this state' when turned 'on'	<b>RE0</b> <b>Initialization</b>	R(S) = <i>false</i> ; V(R) = 0; EXPEDITED_FRAME_COUNTER = 0; NEED_PLCW AND NEED_STATUS_REPORT = <i>true</i> ;
Invalid frame arrives	<b>RE1</b> <b>Invalid Frame</b>	Discard the frame;
Valid 'SET V(R)' directive arrives	<b>RE2</b> <b>SET V(R)</b>	R(S) = <i>false</i> ; Set V(R) to the SEQ_CTRL_FSN in the directive; NEED_PLCW = <i>true</i> ;
Valid Expedited frame arrives	<b>RE3</b> <b>Valid Expedited Frame</b>	Accept/Pass the frame to I/O sublayer; Increment EXPEDITED_FRAME_COUNTER;
Valid Sequence Controlled frame arrives, N(S) = V(R)	<b>RE4</b> <b>Sequence Frame</b> <b>'in-sequence'</b>	Accept/Pass the frame to I/O sublayer; R(S) = <i>false</i> ; Increment V(R); NEED_PLCW = <i>true</i> ;
Valid Sequence Controlled frame arrives, N(S) > V(R)	<b>RE5</b> <b>Sequence Frame</b> <b>'gap detected'</b>	Discard the frame; R(S) = <i>true</i> ; NEED_PLCW = <i>true</i> ;
Valid Sequence Controlled frame arrives, N(S) < V(R)	<b>RE6</b> <b>Sequence Frame</b> <b>'already received'</b>	Discard the frame;
Frame sublayer requests content for PLCW	<b>RE7</b> <b>Report PLCW contents</b>	Report value of R(S), V(R), and EXPEDITED_FRAME_COUNTER;

**7.2.2 INTERNAL FARM-P VARIABLES**

- a) V(R): an eight-bit positive integer whose value shall represent the sequence number plus one (modulo 256) of the last Sequence Controlled frame acknowledged by the Receiver.
- b) R(S): a Boolean variable (i.e., its value is either *true* or *false*) that is copied to the PLCW and shall indicate whether or not Sequence Controlled frame(s) need to be retransmitted.
- c) N(S): an eight-bit positive integer whose value shall represent the sequence number (modulo 256) contained in the transfer frame header of the Proximity-1 Frame.

- d) **EXPEDITED\_FRAME\_COUNTER**: a three-bit positive integer whose value represents the number of Expedited frames received (modulo 8). This counter may be used by the receiver to keep track of the number of expedited frames received over a communications session.

### **7.2.3 INTERFACE TO THE I/O LAYER**

FARM-P shall pass valid expedited and valid in-sequence U-frames to the I/O sublayer where they shall be buffered, assembled into packets as required, and then delivered via the specified output port.

## 8 INPUT/OUTPUT (I/O) SUBLAYER OPERATIONS

NOTE – The I/O sublayer provides the interface with the spacecraft data provider and data recipient. This section describes operations with a single user data source and single physical channel. Note that implementations are not limited to a single data source. The fundamental role of the I/O sublayer is to form the frame data units for transfer across the link, and to pass received data units out to the physical and logical destinations identified in the received frame.

### 8.1 SENDING OPERATIONS

NOTE – The sending side of the I/O sublayer interfaces with the data supplier.

At the sending side, the I/O sublayer:

- a) shall provide the procedures that accept the user service data units and prepare them for transfer across the communications channel;
- b) may be required to parse large input packets into segments compatible with the maximum frame data size allowed in the asynchronous link;
- c) shall assemble the data units for inclusion into frames in accordance with the restrictions imposed by various MIB parameters;
- d) shall receive the user service data unit along with its routing and control instructions;

NOTE – These instructions are required for the formulation of the frame header and to determine whether data units can be combined into the same frame or not. The frame construction rules state that all data units within the same frame must be addressed to the same spacecraft destination, contain the same PDU type ID, the same physical channel ID, the same output Port ID, have the same QOS and must be of the same service data unit type (DFC ID).

- e) shall have the responsibility to inform the data supplier which service data units were transmitted and, in the case of Sequence Controlled service, which data units were acknowledged as received by the communications partner.

NOTE – This notification is essential to enable reliable data service operations across multiple sessions, if desired. Sending operations also includes Simplex-Transmit.

## 8.2 RECEIVING OPERATIONS

NOTE – The receiving side of the I/O sublayer interfaces has a multitude of possible interfaces with the spacecraft. One of eight possible output ports can be identified per PCID in the frame using the Port ID field.

**8.2.1** At the receiver side, the role of the I/O sublayer shall be to route a received ‘complete’ data unit to the identified port.

**8.2.2** When segmentation is used, the I/O sublayer shall accept received segments and try to re-assemble the user’s data unit.

**8.2.3** The I/O sublayer shall deliver only completely reassembled data units; i.e., partial data units shall not be delivered to the end user.

NOTE – Receiving operations also includes Simplex-Receive.

**ANNEX A****VARIABLE-LENGTH SUPERVISORY  
PROTOCOL DATA FIELD FORMATS****(Normative)**

## NOTES

- 1 See table 3-4 for a complete overview of the variable-length SPDU structure including the SPDU header and SPDU data field. This annex specifies the format of the data field only.
- 2 The Directive Type field is defined from bits 13 through 15, inclusive, in order to maintain backward compatibility with the NASA Mars Surveyor Project 2001 Odyssey orbiter.

**A1 SPDU TYPE 1: DIRECTIVE/REPORT/PLCW SPDU DATA FIELD****A1.1 GENERAL**

**A1.1.1** The Directive/Report/PLCW SPDU shall be used for space link supervisory configuration and control of the transceiver and its operation.

**A1.1.2** The SPDU data field shall be a container that can hold up to seven sixteen-bit discrete self-delimiting and self-identifying directives:

- a) each directive shall have a specific functionality;
- b) each directive shall be sixteen bits in length and shall be self identified by the value in the Directive Type field (contained in bits 13, 14, and 15 of the directive);
- c) the directives shall be concatenated without intervening bits within the data field.

NOTE – See figure A-1 for TYPE 1 SPDU Data Field Contents.

										<b>Directive Type 3 bits (13,14,15)</b>	
Mode (0,1,2)		Data Rate (3,4,5,6)			Modulation (7)		Data encoding (8,9)		Frequency (10,11,12)		'000' = SET TRANSMITTER PARAMETERS
Time Sample (0,1,2,3,4,5)		Duplex (6,7,8)	Reserved (9,10)		Remote No More Data (11)			Token (12)		'001' = SET CONTROL PARAMETERS	
Mode (0,1,2)		Data Rate (3,4,5,6)			Modulation (7)		Data decoding (8,9)		Frequency (10,11,12)		'010' = SET RECEIVER PARAMETERS
Receiver Frame Sequence Number (SEQ_CTRL_FSN)(0,1,2,3,4,5,6,7)					Reserved (8,9,10,11,12)					'011' = Set V(R)	
Reserved (0,1,2)		Status Report Request (3,4,5,6,7)		Time-Tag Request (8,9,10)		PCID 0 PLCW Request (11)		PCID 1 PLCW Request (12)		'100' = Report Request	
Report Value (0,1,2,3,4,5,6,7)				Expedited Frame counter (8,9,10)		PCID (11)		Retransmit (12)		'101' = PLCW	
Direction (0)	Freq Table (1)	Rate Table (2)	Carrier Mod (3,4)	Data Mod (5,6)	Mode Select (7,8)	scrambler (9,10)	Diff. Encoding (11)	R-S Code (12)	'110' = SET PL EXTENSIONS		
Source Spacecraft ID (0,1,2,3,4,5,6,7,8,9)					Reserved (10,11,12)					'111' = Report Source SCID	

Figure A-1: Type 1 SPDU Data Field Contents

**A1.2 SET TRANSMITTER PARAMETERS DIRECTIVE**

**A1.2.1 General**

The SET TRANSMITTER PARAMETERS directive shall consist of six fields, positioned contiguously in the following sequence (described from least significant bit, bit 15, to most significant bit, bit 0):

- a) Directive Type (three bits);
- b) Transmitter Frequency (three bits);
- c) Transmitter Data Encoding (two bits);
- d) Transmitter Modulation (one bit);
- e) Transmitter Data Rate (four bits);
- f) Transmitter (TX) Mode (three bits).

NOTE – The structural components of the SET TRANSMITTER PARAMETERS directive are shown in figure A-2.

CCSDS RECOMMENDED STANDARD FOR PROXIMITY-1 SPACE DATA LINK PROTOCOL

Bit 0						Bit 15
TX Mode 3 bits	TX Data Rate 4 bits	TX Modulation 1 bit	TX Data encoding 2 bits	TX Frequency 3 bits	Directive Type 3 bits	
0,1,2	3,4,5,6	7	8,9	10,11,12	13,14,15	

**Figure A-2: SET TRANSMITTER PARAMETERS Directive**

**A1.2.2 Directive Type**

**A1.2.2.1** Bits 13–15 of the SET TRANSMITTER PARAMETERS directive shall contain the Directive Type.

**A1.2.2.2** The 3-bit Directive Type field shall identify the type of protocol control directive and shall contain the binary value ‘000’ for the SET TRANSMITTER PARAMETERS directive.

**A1.2.3 Transmitter Frequency**

**A1.2.3.1 General**

Bits 10–12 of the SET TRANSMITTER PARAMETERS directive shall be used to set the transmitter frequency of the partnered transceiver to the desired value.

**A1.2.3.2 Return Transmitter Frequency (e.g., Orbiter as Initiator; Landed Asset as Responder)**

In the context of the forward link, this three-bit field shall define the receive frequency of the Responder. Actual frequency assignments are given in the Physical layer (see reference [9]).

‘000’	‘001’	‘010’	‘011’	‘100’	‘101’	‘110’	‘111’
Ch0R	Ch1R	Ch2R	Ch3R	Ch4R	Ch5R	Ch6R	Ch7R

**A1.2.3.3 Transmitter Data Encoding**

Bits 8–9 of the SET TRANSMITTER PARAMETERS directive shall contain the following coding options:

- a) ‘00’ = Reserved;

CCSDS RECOMMENDED STANDARD FOR PROXIMITY-1 SPACE DATA LINK PROTOCOL

- b) '01' = Convolutional Code(7,1/2) (G2 vector inverted) with attached CRC-32 (see reference [8]);
- c) '10' = By-pass Convolution Code;
- d) '11' = Concatenated (RS(204,188), CC(7,1/2)) Codes.

NOTE – RS(204,188) with CC(7,1/2) code is an ETSI standard. This option is not required for cross support. See reference [F1] for more details.

**A1.2.3.4 Transmitter Modulation**

Bit 7 of the SET TRANSMITTER PARAMETERS directive shall contain the transmission modulation options:

- a) '1' = Non-coherent PSK;
- b) '0' = Coherent PSK.

**A1.2.3.5 Transmitter Data Rate**

**A1.2.3.5.1** Bits 3–6 of the SET TRANSMITTER PARAMETERS directive shall contain one of the following transmission data rates (rates in kbps, i.e., powers of 10).

NOTE – Because of the NASA Mars Surveyor Project 2001 Odyssey implementation, there is an added constraint on the use of the values in the Data Rate field for 8, 32, 128, 256 Kbps. Data rate selection is linked to the modulation field value as shown in the tables below. NC indicates non-coherent PSK, and C indicates coherent PSK. R1 through R4 indicate the field is reserved for future definition by the CCSDS.

**A1.2.3.5.2 Ordered by Data Rate:**

'1000'	'1001'	'0000'	'0001'	'1100'	'0010'	'0011'	'1101'	'0100'	'0101'	'0110'	'0111'	'1010'	'1011'	'1110'	'1111'
2	4	8 NC	8 C	16	32 NC	32 C	64	128 NC	128 C	256 NC	256 C	R1	R2	R3	R4

**A1.2.3.5.3 Ordered by Bit pattern:**

'0000'	'0001'	'0010'	'0011'	'0100'	'0101'	'0110'	'0111'	'1000'	'1001'	'1010'	'1011'	'1100'	'1101'	'1110'	'1111'
8 NC	8 C	32 NC	32 C	128 NC	128 C	256 NC	256 C	2	4	R1	R2	16	64	R3	R4

**A1.2.3.6 Transmitter Mode**

Bits 0–2 of the SET TRANSMITTER PARAMETERS directive shall contain the Transmitter Mode options. This field identifies the data link layer protocol utilized by the transmitter:

- a) '000' = Mission Specific;

## CCSDS RECOMMENDED STANDARD FOR PROXIMITY-1 SPACE DATA LINK PROTOCOL

- b) '001' = Proximity-1 Protocol;
- c) '010' = Mission Specific;
- d) '011' = Mission Specific;
- e) '100' = Mission Specific;
- f) '101' = Mission Specific;
- g) '110' = Reserved by CCSDS;
- h) '111' = Reserved by CCSDS.

NOTE – See annex C for NASA Mars Survey Project 2001 Odyssey Orbiter Transmitter Mode mission specific values.

### A1.3 SET CONTROL PARAMETERS

#### A1.3.1 General

**A1.3.1.1** The SET CONTROL PARAMETERS directive shall consist of six fields, positioned contiguously in the following sequence (described from least significant bit, bit 15, to most significant bit, bit 0):

- a) Directive Type (3 bits);
- b) Token (1 bit);
- c) Remote No More Data (1 bit);
- d) Reserved (2 bits);
- e) Duplex (3 bits);
- f) Time Sample (6 bits).

**A1.3.1.2** This directive is used to set from zero to four control parameters at a time: 1) setting the token for half duplex operations; 2) setting the Remote No More Data condition for session termination in full or half duplex; 3) setting the Duplex parameter; 4) setting the number of time samples to be taken during Timing Services.

NOTE – The structural components of the SET CONTROL PARAMETERS directive are shown in figure A-3.

Bit 0			Bit 15		
Time Sample 6 bits	Duplex 3 bits	Reserved 2 bits	Remote No More Data 1 bit	Token 1 bit	Directive Type 3 bits
0,1,2,3,4,5	6,7,8	9,10	11	12	13,14,15

**Figure A-3: SET CONTROL PARAMETERS Directive**

**A1.3.2 Directive Type**

**A1.3.2.1** Bits 13–15 of the SET CONTROL PARAMETERS directive shall contain the Directive Type.

**A1.3.2.2** The three-bit Directive Type field shall identify the type of protocol control directive and shall contain the binary value ‘001’ to identify the SET CONTROL PARAMETERS directive.

**A1.3.3 Token**

Bit 12 of the SET CONTROL PARAMETERS directive shall contain the value of the Token field. Either this field notifies the remote node that there is no change in who has permission to transmit (i.e., ignore this field), or it commands the remote node to the transmit state, as follows:

- a) ‘0’ = No Change;
- b) ‘1’ = Transmit.

**A1.3.4 Remote No More Data**

Bit 11 of the SET CONTROL PARAMETERS directive shall contain the Remote No More Data field. Either this field notifies the recipient node that there is no change in the remote node’s data state (i.e., ignore this field), or it notifies the recipient node that the remote node has no more data to send, in which case the session may be terminated when the recipient node locally has no more data to send, as follows:

- a) ‘0’ = No Change;
- b) ‘1’ = Remote Node has No More Data to Send (RNMD).

**A1.3.5 Reserved**

Bits 9-10 of the SET CONTROL PARAMETERS directive shall contain spares and be set to ‘all zero’.

## CCSDS RECOMMENDED STANDARD FOR PROXIMITY-1 SPACE DATA LINK PROTOCOL

**A1.3.6 Duplex**

Bits 6-8 of the SET CONTROL PARAMETERS directive shall contain the Duplex field. Either this field notifies the recipient node that there is no change in the remote node's Duplex state (i.e., ignore this field), or it notifies the recipient node to change the directionality of communication accordingly, as follows:

- a) '000' = No Change;
- b) '001' = Full Duplex;
- c) '010' = Half Duplex;
- d) '011' = Simplex Transmit;
- e) '100' = Simplex Receive;
- f) '101' = Reserved;
- g) '110' = Reserved;
- h) '111' = Reserved.

**A1.3.7 Time Sample**

Bits 0-5 of the SET CONTROL PARAMETERS directive shall contain the Time Sample field. When this field is non-zero, it notifies the recipient to capture the time and frame sequence number (associated with the Proximity Timing Service, see section 5) for the next  $n$  frames received, where  $n$  is the number of Proximity transfer frames contained within the Time Sample Field.

**A1.4 SET RECEIVER PARAMETERS DIRECTIVE****A1.4.1 General**

The SET RECEIVER PARAMETERS directive shall consist of six fields, positioned contiguously in the following sequence (described from least significant bit, bit 15, to most significant bit, bit 0):

- a) Directive Type (three bits);
- b) Receiver Frequency (three bits);
- c) Receiver Data Decoding (two bits);
- d) Receiver Modulation (one bit);
- e) Receiver Data Rate (four bits);
- f) Receiver (RX) Mode (three bits).

NOTE – The structural components of the SET RECEIVER PARAMETERS directive are shown in figure A-4.

Bit 0					Bit 15
RX Mode 3 bits	RX Rate 4 bits	RX Modulation 1 bit	RX Data Decoding 2 bits	RX Frequency 3 bits	Directive Type 3 bits
0,1,2	3,4,5,6	7	8,9	10,11,12	13,14,15

**Figure A-4: SET RECEIVER PARAMETERS Directive**

**A1.4.2 Directive Type**

**A1.4.2.1** Bits 13–15 of the SET RECEIVER PARAMETERS directive shall contain the Directive Type.

**A1.4.2.2** The three-bit Directive Type field shall identify the type of protocol control directive and shall contain the binary value ‘010’ for the SET RECEIVER PARAMETERS directive.

**A1.4.3 Receiver Frequency**

**A1.4.3.1 General**

Bits 10–12 of the SET RECEIVER PARAMETERS directive shall be used to set the Receiver frequency of the partnered transceiver to the desired value.

**A1.4.3.2 Forward Receive Frequency (e.g., Orbiter as Initiator; Landed Asset as Responder)**

In the context of the forward link, this three-bit field shall define the receive frequency of the Responder. Actual frequency assignments are given in the Physical layer (see reference [9]).

‘000’	‘001’	‘010’	‘011’	‘100’	‘101’	‘110’	‘111’
Ch0F	Ch1F	Ch2F	Ch3F	Ch4F	Ch5F	Ch6F	Ch7F

**A1.4.4 Receiver Data Decoding**

Bits 8–9 of the SET RECEIVER PARAMETERS directive shall contain the following coding options:

‘00’ = Reserved;

CCSDS RECOMMENDED STANDARD FOR PROXIMITY-1 SPACE DATA LINK PROTOCOL

‘01’ = Convolutional Code(7,1/2) (G2 vector inverted) with attached CRC-32 (see reference [8]);

‘10’ = By-pass Convolutional Code;

‘11’ = Concatenated RS(204,188), CC(7,1/2).

NOTE – RS(204,188) with CC(7,1/2) code is an ETSI standard. This option is not required for cross support. See reference [F1] for more details.

**A1.4.5 Receiver Modulation**

Bit 7 of the SET RECEIVER PARAMETERS directive shall contain the following transmission modulation options:

- a) ‘1’ = Non-coherent PSK;
- b) ‘0’ = Coherent PSK.

**A1.4.6 Receiver Data Rate**

**A1.4.6.1** Bits 3–6 of the SET RECEIVER PARAMETERS directive shall contain one of the following receiver data rates (rates in kbps, i.e., powers of 10).

NOTE – Because of the NASA Mars Surveyor Project 2001 Odyssey implementation, there is an added constraint on the use of the values in the Data Rate field for 8, 32, 128, and 256 Kbps. Data rate selection is linked to the modulation field value as shown in the tables below (‘NC’ indicates non-coherent, and c indicates coherent). R1 through R4 indicates the field is reserved for future definition by the CCSDS.

**A1.4.6.2** Ordered by Data Rate:

‘1000’	‘1001’	‘0000’	‘0001’	‘1100’	‘0010’	‘0011’	‘1101’	‘0100’	‘0101’	‘0110’	‘0111’	‘1010’	‘1011’	‘1110’	‘1111’
2	4	8 NC	8 C	16	32 NC	32 C	64	128 NC	128 C	256 NC	256 C	R1	R2	R3	R4

**A1.4.6.3** Ordered by Bit pattern:

‘0000’	‘0001’	‘0010’	‘0011’	‘0100’	‘0101’	‘0110’	‘0111’	‘1000’	‘1001’	‘1010’	‘1011’	‘1100’	‘1101’	‘1110’	‘1111’
8 NC	8 C	32 NC	32 C	128 NC	128 C	256 NC	256 C	2	4	R1	R2	16	64	R3	R4

**A1.4.7 Receiver Mode**

Bits 0–2 of the SET RECEIVER PARAMETERS directive shall contain the Receiver Mode options. This field identifies the data link layer protocol utilized by the receiver:

- a) ‘000’ = Mission Specific;

- b) '001' = Proximity-1 Protocol;
- c) '010' = Mission Specific;
- d) '011' = Mission Specific;
- e) '100' = Mission Specific;
- f) '101' = Mission Specific;
- g) '110' = Reserved by CCSDS;
- h) '111' = Reserved by CCSDS.

NOTE – See annex C for NASA Mars Survey Project 2001 Odyssey Orbiter Receiver Mode mission specific values.

**A1.5 SET V(R) DIRECTIVE**

**A1.5.1 General**

The SET V(R) directive shall consist of three fields, positioned contiguously in the following sequence (described from least significant bit, bit 15, to most significant bit, bit 0):

- a) Directive Type (3 bits);
- b) Spare (5 bits);
- c) Receiver Frame Sequence Number (SEQ\_CTRL\_FSN) (8 bits).

NOTE – The structural components of the SET V(R) directive are shown in figure A-5.

Bit 0		Bit 15
Receiver Frame Sequence Number SEQ_CTRL_FSN 8 bits	Spare 5 bits	Directive Type 3 bits
0,1,2,3,4,5,6,7	8,9,10,11,12	13,14,15

**Figure A-5: SET V(R) Directive**

**A1.5.2 Directive Type**

**A1.5.2.1** Bits 13–15 of the SET V(R) directive shall contain the Directive Type.

**A1.5.2.2** The three-bit Directive Type field shall identify the type of protocol control directive and shall contain the binary value '011' to identify the SET V(R) directive.

## CCSDS RECOMMENDED STANDARD FOR PROXIMITY-1 SPACE DATA LINK PROTOCOL

**A1.5.3 Spare**

Bits 8–12 of the SET V(R) directive shall contain spare bits, set to ‘all zero’.

**A1.5.4 Receiver Frame Sequence Number**

Bits 0–7 of the SET V(R) directive shall contain the value of the Frame Sequence Number (SEQ\_CTRL\_FSN) to which the receiving unit of the partnered transceiver is to be set.

**A1.6 REPORT REQUEST DIRECTIVE****A1.6.1 General**

The REPORT REQUEST directive is the mechanism by which either (1) a status report, (2) a time-tag, or (3) a PLCW per PCID can be requested of a sender or responder. It shall consist of seven fields, positioned contiguously in the following sequence (described from least significant bit, bit 15, to most significant bit, bit 0):

- a) Directive Type (three bits);
- b) PCID 1 PLCW Request (one bit);
- c) PCID 0 PLCW Request (one bit);
- d) Time-Tag Request (three bits);
- e) Status Request (five bits);
- f) Spare (three bits).

NOTE – The structural components of the REPORT REQUEST directive are shown in figure A-6.

Bit 0			Bit 15		
Spare	Status Report Request	Time-Tag Request	PCID 0 PLCW Request	PCID 1 PLCW Request	Directive Type
3 bits	5 bits	3 bit	1 bit	1 bit	3 bits
0,1,2	3,4,5,6,7	8,9,10	11	12	13,14,15

**Figure A-6: Report Request**

**A1.6.2 Directive Type**

**A1.6.2.1** Bits 13–15 of the REPORT REQUEST directive shall contain the Directive Type.

**A1.6.2.2** The three-bit Directive Type field shall identify the type of protocol control directive and shall contain the binary value '100'.

#### **A1.6.3 Physical Channel 1 PLCW Report Request Field**

Bit 12 of the REPORT REQUEST directive shall indicate whether a PLCW report for PC1 is required:

- a) '1' = PLCW report is needed for PC1;
- b) '0' = PLCW report is not required.

#### **A1.6.4 Physical Channel 0 PLCW Report Request Field**

Bit 11 of the REPORT REQUEST directive shall indicate whether a PLCW report for PC0 is required:

- a) '1' = PLCW report is needed for PC0;
- b) '0' = PLCW report is not required.

#### **A1.6.5 Time-Tag Request Field**

Bits 8–10 of the directive, if set to a value other than '000', shall indicate a request to the remote transceiver to initiate a Proximity-1 time tag exchange (see section 5).

#### **A1.6.6 Status Report Request**

**A1.6.6.1** The value contained in bits 3–7 of the REPORT REQUEST directive shall indicate the type of status report desired.

**A1.6.6.2** If set to '00000', a status report is not required.

**A1.6.6.3** The types of status reports are reserved for CCSDS use.

#### **A1.6.7 Spares**

Bits 0–2 of the REPORT REQUEST directive shall contain spare bits set to 'all zero'.

## CCSDS RECOMMENDED STANDARD FOR PROXIMITY-1 SPACE DATA LINK PROTOCOL

**A1.7 PROXIMITY LINK CONTROL WORD (PLCW)****A1.7.1 General**

The Proximity Link Control Word (PLCW) shall consist of five fields, positioned contiguously in the following sequence (described from least significant bit, bit 15, to most significant bit, bit 0):

- a) Directive Type (three bits);
- b) Retransmit Flag (one bit);
- c) PCID (one bit);
- d) Expedited Frame Counter (three bits);
- e) Report Value (eight bits).

NOTE – The structural components of the PLCW are shown in figure A-7. This format applies only to PLCWs contained within variable-length SPDUs. See C4.3 for the PLCW format used on NASA Mars Surveyor Project 2001 Odyssey.

Bit 0					Bit 15
Report Value (SEQ_FSN)	Expedited Frame Counter	PCID	Retransmit Flag	Directive Type	
8 bits	3 bits	1 bit	1 bit	3 bits	

**Figure A-7: Proximity Link Control Word**

**A1.7.2 Quality of Service**

The PLCW shall be transmitted using the Expedited Quality of Service.

**A1.7.3 Directive Type**

**A1.7.3.1** Bits 13–15 of the PLCW shall contain the Directive Type.

**A1.7.3.2** The three-bit Directive Type field shall identify the type of protocol report and shall contain the binary value ‘101’.

**A1.7.4 PLCW RETRANSMIT Flag**

**A1.7.4.1** Bit 12 of the PLCW shall contain the PLCW Retransmit Flag.

**A1.7.4.2** A setting of '0' in the PLCW Retransmit Flag shall indicate that there are no outstanding frame rejections in the sequence received so far, and thus retransmissions are not required.

**A1.7.4.3** A setting of '1' in the PLCW Retransmit Flag shall indicate that a received frame failed a frame acceptance check and, therefore, a retransmission of that frame is required.

### **A1.7.5 Physical Channel Identification**

**A1.7.5.1** Bit 11 of the PLCW shall contain the PCID field.

**A1.7.5.2** The one-bit PCID field shall contain the PCID of the Physical Channel with which this report is associated. See 6.2.3.10, 'RECEIVING\_PCID\_BUFFER'.

NOTE – Each PCID in use has its own PLCW reporting activated.

### **A1.7.6 Expedited Frame Counter**

**A1.7.6.1** Bits 8-10 of the PLCW shall contain the EXPEDITED\_FRAME\_COUNTER.

**A1.7.6.2** The EXPEDITED\_FRAME\_COUNTER shall provide a modulo-8 counter indicating that Expedited frames have been received.

### **A1.7.7 Report Value**

**A1.7.7.1** Bits 0-7 of the PLCW shall contain the Report Value.

**A1.7.7.2** The Report Value field shall contain the next Sequence Controlled Frame Sequence Number (SEQ\_FSN), i.e., N(R).

**A1.7.7.3** Separate Report Values shall be maintained for each PC independent of the I/O port.

## **A1.8 SET PL EXTENSIONS (PHYSICAL LAYER)**

NOTE – The SET PL EXTENSIONS directive is the mechanism by which additional Physical layer parameters defined outside of the Proximity-1 Physical layer can be enabled or disabled. This directive is transferred across the Proximity link from the local transceiver to the remote transceiver. This directive is provided for compatibility between transceivers with physical layer extensions in addition to those discussed in this Proximity-1 Recommendation.

## CCSDS RECOMMENDED STANDARD FOR PROXIMITY-1 SPACE DATA LINK PROTOCOL

**A1.8.1 General**

The SET PL EXTENSIONS directive shall consist of ten fields, positioned contiguously in the following sequence (described from least significant bit, bit 15, to most significant bit, bit 0):

- a) Directive Type (three bits);
- b) R-S Code (1 bit);
- c) Differential Mark Encoding (1 bit);
- d) Scrambler (2 bits);
- e) Mode Select (2 bits);
- f) Data Modulation (2 bits);
- g) Carrier Modulation (2 bits);
- h) Rate Table (1 bit);
- i) Frequency Table (1 bit);
- j) Direction (1 bit).

NOTE – The structural components of the SET PL EXTENSIONS directive are shown in figure A-8.

Bit 0										Bit 15
Direction	Freq Table	Rate Table	carrier MOD	Data MOD	Mode Select	scrambler	Differential Mark Encoding	R-S Code	Directive Type	
1 bit	1 bit	1 bit	2 bits	2 bits	2 bits	2 bits	1 bit	1 bit	3 bits	
(0)	(1)	(2)	(3,4)	(5,6)	(7,8)	(9,10)	(11)	(12)	13,14,15	

**Figure A-8: SET PL EXTENSIONS**

**A1.8.2 Directive Type**

**A1.8.2.1** Bits 13–15 of the SET PL EXTENSIONS directive shall contain the Directive Type.

**A1.8.2.2** The three-bit Directive Type field shall identify the directive type and shall contain the binary value ‘110’.

### A1.8.3 Reed-Solomon (R-S) Code

Bit 12 of the SET PL EXTENSIONS directive shall indicate which R-S Code is used:

- a) '0' = R-S(204,188) code;
- b) '1' = R-S(255,239) code.

NOTE – Neither of these R-S Codes is specified by CCSDS in other Recommendations.

### A1.8.4 Differential Mark Encoding

Bit 11 of the SET PL EXTENSIONS directive shall indicate whether Differential Mark Encoding is enabled:

- a) '0' = No differential encoding;
- b) '1' = Differential encoding enabled. The current data bit is exclusive ORed with the previously transmitted bit to determine the value of the current transmitted bit. When the current data bit is a '1', then the current encoder output bit level changes relative to the previous output value. If the data bit is a '0', then the current encoder output bit level remains constant relative to the previous output value.

### A1.8.5 Scrambler

Bits 9-10 of the SET PL EXTENSIONS directive shall indicate if and what type of digital bit scrambling is used:

- a) '00' = By-pass all bit scrambling;
- b) '01' = CCITT bit scrambling enabled (see reference [F2]);
- c) '10' = By-pass all bit scrambling;
- d) '11' = IEES bit scrambling enabled (see reference [F3]).

### A1.8.6 Mode Select

Bits 7-8 of the SET PL EXTENSIONS directive shall indicate the type of carrier suppression used:

- a) '00' = Suppressed Carrier;
- b) '01' = Residual Carrier;
- c) '10' = Reserved;
- d) '11' = Reserved.

## CCSDS RECOMMENDED STANDARD FOR PROXIMITY-1 SPACE DATA LINK PROTOCOL

**A1.8.7 Data Modulation**

Bits 5-6 of the SET PL EXTENSIONS directive shall indicate the type of data modulation used:

- a) '00' = NRZ;
- b) '01' = Bi-Phase-Level (Manchester);
- c) '10' = Reserved;
- d) '11' = Reserved.

**A1.8.8 Carrier Modulation**

Bits 3-4 of the SET PL EXTENSIONS directive shall indicate the type of carrier modulation to be used:

- a) '00' = No Modulation;
- b) '01' = PSK;
- c) '10' = FSK;
- d) '11' = QPSK.

**A1.8.9 Rate Table**

Bit 2 of the SET PL EXTENSIONS directive shall indicate which set of data rates shall be used:

- a) '0' = Default Set defined in the Data Rate Field of the SET TRANSMITTER PARAMETERS and SET RECEIVER PARAMETERS Directives in this annex;
- b) '1' = Extended Physical Layer Data Rate Set defined below.

'0000' = 1000 bps	'0110' = 64000 bps	'1100' = 4096000 bps
'0001' = 2000 bps	'0111' = 128000 bps	'1101' = Reserved
'0010' = 4000 bps	'1000' = 256000 bps	'1110' = Reserved
'0011' = 8000 bps	'1001' = 512000 bps	'1111' = Reserved
'0100' = 16000 bps	'1010' = 1024000 bps	
'0101' = 32000 bps	'1011' = 2048000 bps	

**A1.8.10 Frequency Table**

**A1.8.10.1 General**

Bit 1 of the SET PL EXTENSIONS directive shall indicate what set of frequencies shall be used:

- a) '0' = Channels 0 – 7 defined in the Frequency Field of the SET TRANSMITTER PARAMETERS and SET RECEIVER PARAMETERS Directives and specifically in the Proximity-1 Physical layer;
- b) '1' = Channels 8 – 15 defined in the Extended Physical Layer Frequency Set defined below.

**A1.8.10.2 Forward Link (e.g., Orbiter as Initiator; Landed Asset as Responder)**

In the context of the forward link, this three-bit field shall define the receive frequency of the Responder. Actual frequency assignments are given in the Physical layer (see reference [9]).

'000'	'001'	'010'	'011'	'100'	'101'	'110'	'111'
Ch8F	Ch9F	Ch10F	Ch11F	Ch12F	Ch13F	Ch14F	Ch15F

**A1.8.10.3 Return Link (e.g., Orbiter as Initiator; Landed Asset as Responder)**

In the context of the return link, this three-bit field shall define the transmit frequency of the Responder. Actual frequency assignments are given in the Physical layer (see reference [9]).

'000'	'001'	'010'	'011'	'100'	'101'	'110'	'111'
Ch8R	Ch9R	Ch10R	Ch11R	Ch12R	Ch13R	Ch14R	Ch15R

**A1.8.11 Direction**

Bit 0 of the SET PL EXTENSIONS directive shall indicate if the fields in this directive apply to the transmit or receive side of the transceiver:

- a) '0' = Transmit side;
- b) '1' = Receive side.

## CCSDS RECOMMENDED STANDARD FOR PROXIMITY-1 SPACE DATA LINK PROTOCOL

**A1.9 REPORT SOURCE SPACECRAFT ID****A1.9.1 General**

The REPORT SOURCE SPACECRAFT ID is the mechanism by which the local transceiver can provide status of its source spacecraft ID to the remote transceiver across the Proximity link. It shall consist of three fields, positioned contiguously in the following sequence (described from least significant bit, bit 15, to most significant bit, bit 0):

- a) Directive Type (three bits);
- b) Reserved (three bits);
- c) Source Spacecraft ID (ten bits).

NOTE – The structural components of the REPORT SOURCE SPACECRAFT ID are shown in figure A-9.

Bit 0	Bit 15
Source Spacecraft ID	Reserved Directive Type
10 bits	3 bits 3 bits
0,1,2,3,4,5,6,7,8,9	10,11,12 13,14,15

**Figure A-9: Report Source Spacecraft ID**

**A1.9.2 Directive Type**

**A1.9.2.1** Bits 13–15 of the REPORT SOURCE SPACECRAFT ID status report shall contain the Directive Type.

**A1.9.2.2** The three-bit Directive Type field shall identify the type of status report and shall contain the binary value ‘111’.

**A1.9.3 Reserved**

Bits 10–12 of the REPORT SOURCE SPACECRAFT ID status report shall contain reserved bits, set to ‘all zero’.

**A1.9.4 Spacecraft ID**

Bits 0-9 of the REPORT SOURCE SPACECRAFT ID status report shall contain the Spacecraft ID of the source of the transfer frame.

**A2 SPDU TYPE 2: TIME DISTRIBUTION SPDU DATA FIELD**

NOTE – See table 3-4 for a complete overview of the variable-length SPDU structure including the SPDU header and SPDU data field.

**A2.1 GENERAL**

**A2.1.1** The TIME DISTRIBUTION SPDU Data Field is the container that describes both the type and value of the time entity for distribution.

**A2.1.2** A single Time Distribution directive shall be contained within a TIME DISTRIBUTION SPDU.

**A2.1.3** The format of the TIME DISTRIBUTION SPDU Data Field shall consist of two fields, positioned contiguously, in the following sequence:

- a) TIME DISTRIBUTION directive type (1 octet);
- b) Time field (variable: 1 to 14 octets).

NOTE – The structural components of the TIME DISTRIBUTION SPDU Data Field are shown in figure A-10.

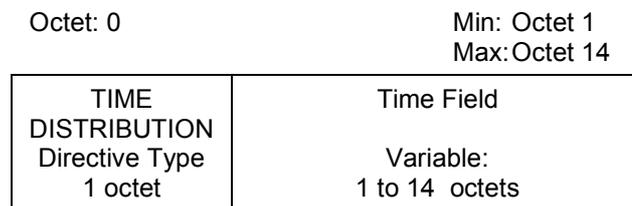

**Figure A-10: Type 2 SPDU Data Field Contents**

**A2.2 TIME DISTRIBUTION DIRECTIVE TYPE**

**A2.2.1** Octet 0 of the TIME DISTRIBUTION SPDU Data Field shall contain the TIME DISTRIBUTION directive type field indicating the function to be performed (if any) with the time contents.

**A2.2.2** TIME DISTRIBUTION Types are:

- a) ‘00000000’ = NULL;
- b) ‘00000001’ = TIME TRANSFER;
- c) ‘00000010’ = BROADCAST SPACECRAFT CLOCK TIME;
- d) all others = Reserved for CCSDS use.

## CCSDS RECOMMENDED STANDARD FOR PROXIMITY-1 SPACE DATA LINK PROTOCOL

**A2.3 TIME FIELD**

Octet 1 through octet 14 shall contain the time value associated with the directive. The time code selected for this field shall comply with the CCSDS Time Code Format Recommendation (reference [7]).

Blank page

## ANNEX B

## MANAGEMENT INFORMATION BASE (MIB) PARAMETERS

## (Normative)

This table lists each MIB parameter in the document along with how it is used and in what layer or sublayer it is used. Values for the Layer/Sub-layer field are: P = Physical, C = C&S, F = Frame, M = MAC, D = Data Services, I = I/O. Parameter Definitions are provided where they are referenced in the specification.

Parameter	Use	Layer
Acquisition_Idle_Duration	Mandatory. Used in Full, Half Duplex, and Simplex session establishment. Session static. See 6.2.4.4.	M
Carrier_Loss_Timer_Duration	Mandatory. Used in Full and Half Duplex Operations. Session static. See 6.2.4.6.	D
Carrier_Only_Duration	Mandatory. Used in Full, Half Duplex, and Simplex session establishment. Session static. See 6.2.4.3.	M
Comm_Change_Lifetime	Mandatory. Used in the Comm Change persistent activity. Session static. See 6.2.4.10.	M
Comm_Change_Notification	Mandatory. Used in the Comm Change persistent activity. Session static. See 6.2.4.9.	M
Comm_Change_Response	Mandatory. Used in the Comm Change persistent activity. Session static. See 6.2.4.8.	M
Comm_Change_Waiting_Period	Mandatory. Used in the Comm Change persistent activity. Session static. See 6.2.4.7.	M
Hail_Lifetime	Mandatory. Used in the Hail persistent activity. Session static. See 6.2.4.14.	M
Hail_Notification	Mandatory. Used in the Hail persistent activity. Session static. See 6.2.4.13.	M
Hail_Response	Mandatory. Used in the Hail persistent activity. Session static. See 6.2.4.12.	M

CCSDS RECOMMENDED STANDARD FOR PROXIMITY-1 SPACE DATA LINK PROTOCOL

Parameter	Use	Layer
Hail_Wait_Duration	Mandatory. Used in the Hail persistent activity. Session static. See 6.2.4.11.	M
Hailing_Channel	Mandatory. Channel assignment used in the Hail persistent activity during Link Establishment. Session static. See 6.2.4.15.	P,M
Hailing_Data_Rate	Mandatory. Data rate used in the Hail persistent activity during Link Establishment. Session static. See 6.2.4.16.	P,M
Interval_Clock	Mandatory. A frequency (e.g., 100 Hz) that is used for interval timing. Session static. See 6.3.	C
Local_Spacecraft_ID	Mandatory. Used as a frame validation check when Source-or-Destination ID equals <i>source</i> . Session static. See 3.2.2.9.3.	M
Maximum_Packet_Size	Mandatory if packets are used. Maximum size of a packet in octets. Used in the segmentation process. Session static. See 4.4.1.1.	I
Persistence_Wait_Time	Mandatory. Defines the maximum amount of time the initiating transceiver stays in persistence until either (1) it receives an acknowledgement from the remote transceiver that the COMM_CHANGE was acted upon, or (2) the wait timer times out. See table 6-8, 'Full Duplex Communication Change State Table'.	M
PLCW_Repeat_Interval	Mandatory. Used in COP-P. Session static. See 6.2.4.19.	D
Receive_Duration	Mandatory. Used in Half Duplex Data Services. Session static. See 6.2.4.18.	D
Remote_Spacecraft_ID	Mandatory. Used to address one or several remote spacecraft as opposed to the local spacecraft. Session dynamic. See 3.2.2.9.4.	F,M,D,I

## CCSDS RECOMMENDED STANDARD FOR PROXIMITY-1 SPACE DATA LINK PROTOCOL

Parameter	Use	Layer
Resync_Local	Mandatory. If Resync_Local equals <i>false</i> , it is the responsibility of the local controller to decide how synchronization will be re-established. Otherwise, if <i>true</i> , the Sender Node's FOP-P forces synchronization by requesting a SET V(R) persistent activity. Session static. See 7.1.3.2, 'SET V(R) Persistent Activity'.	D
Resync_Lifetime	Mandatory. Used in the FOP-P SET V(R) persistent activity. Session static. See 7.1.3.2.	M,D
Resync_Notification	Mandatory. Used in the FOP-P SET V(R) persistent activity. Session static. See 7.1.3.2.	M,D
Resync_Response	Mandatory. Used in the FOP-P SET V(R) persistent activity. Session static. See 7.1.3.2.	M,D
Resync_Waiting_Period	Mandatory. Used in the FOP-P SET V(R) persistent activity. Session static. See 7.1.3.2.	M,D
Send_Duration	Mandatory. Used in Half Duplex Data Services. Session static. See 6.2.4.17.	D
Synch_Timeout	Mandatory. Defines the value to which the SYNCH_TIMER is initialized or reinitialized. Session static. See 7.1.2.	D
Tail_Idle_Duration	Mandatory. Used in Full, Half Duplex, and Simplex session establishment. Session static. See 6.2.4.5.	M
Test_Source	Mandatory. Used in the verification of the spacecraft ID when the Source-or-Destination ID is <i>source</i> . Session static. See 6.2.4.2.	F
Transmission_Window	Mandatory. Sets the maximum size of the transmission window for the COP-P. Session static. See 7.1.3.3, note 3.	D

Blank page

.....

## ANNEX C

### NASA MARS SURVEYOR PROJECT 2001 ODYSSEY ORBITER PROXIMITY SPACE LINK CAPABILITIES

#### (Informative)

NOTE – The following capability is being used by the NASA Mars Surveyor Project 2001 Odyssey orbiter and is being provided for information only.

#### C1 TONE BEACON MODE

**C1.1** The Tone Beacon Mode configures the transceiver to transmit a CW tone. This mode can be used to signal microprobes to transmit their data to the orbiter. Addressing of multiple microprobes is accomplished by using four unique CW frequencies. Microprobes can respond in any transmit configuration compatible with valid orbiter receive configurations.

**C1.2** The four orbiter CW beacon frequencies are:

- a) 437.1000 MHz;
- b) 440.7425 MHz;
- c) 444.3850 MHz;
- d) 448.0275 MHz.

**C1.3** The lander CW beacon frequency is 401.585625.

**C1.4** The Tone Beacon Mode can be used to perform Doppler measurements. The orbiter can provide a CW tone at 437.1 MHz and the lander can coherently transpond with the CW tone at 401.585625 MHz.

#### C2 TRANSMIT STANDBY MODE

Transmit Standby mode prevents the transceiver from transmitting. This is the default mode when multiple landed elements are within the field of view of an orbiter hailing. It prevents interference caused by several landed elements responding simultaneously.

#### C3 CONVOLUTIONAL CODE IMPLEMENTATION

The rate 1/2, constraint-length 7 convolutional code employed does not contain symbol inversion on the output path of connection vector G2 as specified in reference [5]. In order to be compatible with the NASA Mars Surveyor Project 2001 Odyssey orbiter, implementations

will need to set the encoding data parameter field of the SET TRANSMITTER PARAMETERS and SET RECEIVER PARAMETERS directives as indicated in C4 in the directives below.

**C4 DIRECTIVE AND PROTOCOL DATA UNITS**

NOTE – The SET TRANSMITTER PARAMETERS and SET RECEIVER PARAMETERS directives are always transmitted together.

**C4.1 SET TRANSMITTER PARAMETERS DIRECTIVE**

**C4.1.1 General**

The SET TRANSMITTER PARAMETERS directive shall consist of six fields, positioned contiguously in the following sequence (described from least significant bit, bit 15, to most significant bit, bit 0):

- a) Set Directive Type (three bits);
- b) Transmitter Frequency (three bits);
- c) Transmitter Data Encoding (two bits);
- d) Transmitter Modulation (one bit);
- e) Transmitter Data Rate (four bits);
- f) Transmitter Mode (three bits).

NOTE – The structural components of the SET TRANSMITTER PARAMETERS directive are shown in figure C-1.

Bit 0						Bit 15
TX Mode 3 bits	TX Data Rate 4 bits	TX Modulation 1 bit	TX Data encoding 2 bits	TX Frequency 3 bits	Set Directive Type 3 bits	
0,1,2	3,4,5,6	7	8,9	10,11,12	13,14,15	

**Figure C-1: NASA Mars Surveyor Project 2001 Odyssey SET TRANSMITTER PARAMETERS Directive**

**C4.1.2 Set Directive Type**

**C4.1.2.1** Bits 13–15 of the SET TRANSMITTER PARAMETERS directive shall contain the Set Directive Type.

**C4.1.2.2** The three-bit Set Directive Type field shall identify the type of protocol control directive and shall contain the binary value ‘000’ for the SET TRANSMITTER PARAMETERS directive.

## CCSDS RECOMMENDED STANDARD FOR PROXIMITY-1 SPACE DATA LINK PROTOCOL

**C4.1.3 Transmitter Frequency**

**C4.1.3.1** Bits 10–12 of the SET TRANSMITTER PARAMETERS directive shall be used to set the transmitter frequency of the partnered transceiver to the desired value.

**C4.1.3.2** This three-bit field shall contain the value '000' indicating that the Responder's transmit return frequency, 401.585625 MHz, shall be used.

**C4.1.4 Transmitter Data Encoding**

Bits 8–9 of the SET TRANSMITTER PARAMETERS directive shall contain the following coding options:

- a) '00' = Scrambler;
- b) '01' = Convolutional Code (7,1/2) without G2 inverter (CRC-32 attached);
- c) '10' = By-pass Convolutional Code;
- d) '11' = N/A.

**C4.1.5 Transmitter Modulation**

Bit 7 of the SET TRANSMITTER PARAMETERS directive shall contain the transmission modulation options:

- a) '1' = PSK;
- b) '0' = PSK Coherent.

**C4.1.6 Transmitter Data Rate**

Bits 3–6 of the SET TRANSMITTER PARAMETERS directive shall contain the transmission data rate.

'0000'	'0001'	'0010'	'0011'	'0100'	'0101'	'0110'	'0111'	'1000'	'1001'	'1010'	'1011'	'1100'	'1101'	'1110'	'1111'
8 NC	8 C	32 NC	32 C	128 NC	128 C	256 NC	256 C	N/A	N/A	N/A	N/A	N/A	N/A	N/A	N/A

NOTE – Rates are in kbps, i.e., powers of 10; C indicates PSK coherent modulation, and NC indicates PSK non-coherent modulation.

**C4.1.7 Transmitter Mode**

Bits 0–2 of the SET TRANSMITTER PARAMETERS directive shall contain the Transmission Mode options:

- a) '000' = Standby;

- b) '001' = Sequence Controlled;
- c) '010' = Expedited;
- d) '011' = Unreliable Bitstream;
- e) '100' = Tone Beacon;
- f) '101' = Canister Mode.

**C4.2 SET RECEIVER PARAMETERS DIRECTIVE**

**C4.2.1 General**

The SET RECEIVER PARAMETERS directive shall consist of six fields, positioned contiguously in the following sequence (described from least significant bit, bit 15, to most significant bit, bit 0):

- a) Set Directive Type (three bits);
- b) Receiver Frequency (three bits);
- c) Receiver Data Decoding (two bits);
- d) Receiver Modulation (one bit);
- e) Receiver Data Rate (four bits);
- f) Receiver Mode (three bits).

NOTE – The structural components of the SET RECEIVER PARAMETERS directive are shown in figure C-2.

Bit 0			Bit 15		
RX Mode 3 bits	RX Rate 4 bits	RX Modulation 1 bit	RX Data Decoding 2 bits	RX Frequency 3 bits	Set Directive Type 3 bits
0,1,2	3,4,5,6	7	8,9	10,11,12	13,14,15

**Figure C-2: NASA Mars Surveyor Project 2001 Odyssey SET RECEIVER PARAMETERS Directive**

**C4.2.2 Set Directive Type**

**C4.2.2.1** Bits 13–15 of the SET RECEIVER PARAMETERS directive shall contain the Directive Type.

CCSDS RECOMMENDED STANDARD FOR PROXIMITY-1 SPACE DATA LINK PROTOCOL

**C4.2.2.2** The three-bit Set Directive Type field shall identify the type of protocol control directive and shall contain the binary value ‘010’ for the SET RECEIVER PARAMETERS directive.

**C4.2.3 Receiver Frequency**

**C4.2.3.1** Bits 10–12 of the SET RECEIVER PARAMETERS directive shall be used to set the receiver frequency of the partnered transceiver to the desired value.

**C4.2.3.2** This three-bit field shall contain the value ‘000’ indicating that the Responder’s receive forward frequency shall be set to 437.1 MHz.

**C4.2.4 Receiver Data Decoding**

Bits 8–9 of the SET RECEIVER PARAMETERS directive shall contain the following coding options:

- a) ‘00’ = Scrambler;
- b) ‘01’ = Convolutional Code (7,1/2) without G2 Inverter (CRC-32 attached);
- c) ‘10’ = By-pass Convolutional Code;
- d) ‘11’ = N/A.

**C4.2.5 Receiver Modulation**

Bit 7 of the SET RECEIVER PARAMETERS directive shall contain the transmission modulation options:

- a) ‘1’ = PSK;
- b) ‘0’ = PSK Coherent.

**C4.2.6 Receiver Data Rate**

Bits 3–6 of the SET RECEIVER PARAMETERS directive shall contain the Receiver Data Rate.

‘0000’	‘0001’	‘0010’	‘0011’	‘0100’	‘0101’	‘0110’	‘0111’	‘1000’	‘1001’	‘1010’	‘1011’	‘1100’	‘1101’	‘1110’	‘1111’
8 NC	8 C	32 NC	32 C	128 NC	128 C	256 NC	256 C	N/A	N/A	N/A	N/A	N/A	N/A	N/A	N/A

NOTE – Rates are in kbps, i.e., powers of 10; C indicates PSK coherent modulation, and NC indicates PSK non-coherent modulation.

### C4.2.7 Receiver Mode

Bits 0–2 of the SET RECEIVER PARAMETERS directive shall contain the Receiver Mode options:

- a) '000' = Standby;
- b) '001' = Sequence Controlled;
- c) '010' = Expedited;
- d) '011' = Unreliable Bitstream;
- e) '100' = Tone Beacon.

## C4.3 PROXIMITY LINK CONTROL WORD (PLCW)

### C4.3.1 General

**C4.3.1.1** The Proximity Link Control Word (PLCW) shall consist of seven fields (see figure C-3), positioned contiguously, and described from least (bit 15) to most significant bit (bit 0) in the following sequence:

- a) Report Value (eight bits);
- b) Expedited Frame Counter (three bits);
- c) Reserved Spare (one bit);
- d) PCID (one bit);
- e) Retransmit Flag (one bit);
- f) SPDU Type Identifier (one bit);
- g) SPDU Format ID (one bit).

**C4.3.1.2** The PLCW shall be transmitted using the Expedited QOS.

NOTE – At the time of the implementation of the Proximity-1 Protocol for NASA Mars Surveyor Project 2001 Odyssey the PCID field was called VCID. However the functionality of that implementation is equivalent to a Physical Channel ID.

## CCSDS RECOMMENDED STANDARD FOR PROXIMITY-1 SPACE DATA LINK PROTOCOL

Bit 0							Bit 15
SPDU Header		SPDU Data Field					
SPDU Format ID	SPDU Type Identifier	Retransmit Flag	PCID	Reserved Spare	Expedited Frame Counter	Report Value (Frame Sequence Number)	
1 bit	1 bit	1 bit	1 bit	1 bit	3 bits	8 bits	

Figure C-3: Proximity Link Control Word Fields

**C4.3.2 Report Value**

**C4.3.2.1** Bits 8–15 of the PLCW shall contain the Report Value.

**C4.3.2.2** The Report Value field shall contain the next Sequence Controlled Frame Sequence Number (SEQ\_FSN), i.e., N(R).

**C4.3.2.3** Separate Report Values shall be maintained for each PC independent of the I/O port.

**C4.3.3 Expedited Frame Counter**

**C4.3.3.1** Bits 5–7 of the PLCW shall contain the EXPEDITED\_FRAME\_COUNTER.

**C4.3.3.2** The EXPEDITED\_FRAME\_COUNTER shall provide a modulo-8 counter indicating that Expedited frames have been received. This value is set to ‘all zero’, indicating that it is not used.

**C4.3.4 Reserved Spare**

**C4.3.4.1** Bit 4 of the PLCW shall contain a Reserved Spare bit.

**C4.3.4.2** The Reserved Spare bit field shall be set to ‘0’.

**C4.3.5 Physical Channel Identification**

**C4.3.5.1** Bit 3 of the PLCW shall contain the PCID field.

**C4.3.5.2** The one-bit PCID field shall contain the PCID of the Physical Channel with which this report is associated. The PCID field is set to ‘0’, indicating PCID 0.

NOTE – Each PCID in use has its own PLCW reporting activated.

### **C4.3.6 PLCW Retransmit Flag**

**C4.3.6.1** Bit 2 of the PLCW shall contain the PLCW Retransmit Flag.

**C4.3.6.2** A setting of '0' in the PLCW Retransmit Flag shall indicate that there are no outstanding frame rejections in the sequence received so far, and thus retransmissions are not required.

**C4.3.6.3** A setting of '1' in the PLCW Retransmit Flag shall indicate that a received frame failed a frame acceptance check and, therefore, that a retransmission of that frame is required.

### **C4.3.7 SPDU Type Identifier**

**C4.3.7.1** Bit 1 of the PLCW shall contain the SPDU Type Identifier.

**C4.3.7.2** The one-bit SPDU Type Identifier field shall identify SPDU type as a PLCW and shall contain the binary value '0'.

### **C4.3.8 SPDU Format ID**

**C4.3.8.1** Bit 0 of the PLCW shall contain the SPDU Format ID.

**C4.3.8.2** The one-bit SPDU format ID field shall indicate that the length of the SPDU is fixed and shall contain the binary value '1'.

## ANNEX D

## NOTIFICATIONS TO VEHICLE CONTROLLER

## (Normative)

This table summarizes all of the conditions throughout the document under which the vehicle controller is notified from within the protocol.

Number	Condition	Reference
1	RESULT OF PERSISTENT ACTIVITY Notification of the success or failure of a persistent activity.	See 4.2.2, 'Persistent Activity Process'.
2	STATE CONTROL STATUS Status of the Proximity-1 State Control Variables.	See State Tables contained in section 6.
3	INVALID FRAME SOURCE When the SCID field and RECEIVING_SCID_BUFFER disagree, and Test_Source is <i>true</i> , then a session violation has occurred and the vehicle controller shall be notified.	See 6.8, 'RECEIVING OPERATIONS'.
4	TIMING SERVICES INSTANCE At the end of receiving the SET CONTROL PARAMETERS ( <i>time sample</i> ) directives, the recipient transceiver notifies its vehicle controller that Proximity time tags and frame sequence numbers are available.	See section 5, 'Proximity-1 Timing Services'.
5	NO CARRIER RECEIVED—HALF DUPLEX	State table 6-10, Event 50.
6	NO DATA TRANSFERRED—HALF DUPLEX	State table 6-10, Event 45.
7	SENDER EXCEEDED PRESCRIBED TRANSMISSION PERIOD—HALF DUPLEX	State table 6-10, Event 44.
8	COP-P LOSS OF SYNCHRONIZATION When FOP-P detects out-of-synchronization condition (SYNCH_TIMER Expires).	See 7.1.3.3, 'FOP-P State Table', Event SE4.
9	CARRIER_LOSS_TIMER UNDERFLOWS	State table 6-9, Event 27.
10	END OF SESSION(# octets received) Notify the vehicle controller of the number of octets received during the session.	State table 6-9, Events E26, E27, E28. State table 6-12, Events E57, E58, E61. State table 6-13, Event E73.
11	CARRIER ONLY RECEIVED Caller notifies vehicle controller that carrier only was detected immediately after the 'Wait for Hail Response' state terminated.	State Table 6-7, Event E8. State Table 6-10, Event E36.

.....

Blank page

## ANNEX E

## ABBREVIATIONS AND ACRONYMS

## (Informative)

ARQ	Automatic Repeat Queuing
ASM	Attached Synchronization Marker
BER	Bit Error Rate
C&S	Coding and Synchronization
CCSDS	Consultative Committee for Space Data Systems
CDS	Command and Data Handling System
COP-P	Communication Operations Procedure Proximity
CRC	Cyclic Redundancy Check
CW	Continuous Wave
DFC ID	Data Field Construction Identifier
ETSI	European Telecommunications Standards Institute
FARM-P	Frame Acceptance and Reporting Mechanism Proximity
FIFO	First In First Out
FOP-P	Frame Operations Procedure – Proximity
IPv4	Internet Protocol Version 4
ITU	International Telecommunications Union
MAC	Medium Access Control
MEX	ESA Mars Express Orbiter
MIB	Management Information Base
MSB	Most Significant Bit
NN(R)	Previous acknowledged frame sequence number +1
N(R)	Last acknowledged frame sequence number +1
N(S)	Frame Sequence Number within the Proximity-1 Frame Header

## CCSDS RECOMMENDED STANDARD FOR PROXIMITY-1 SPACE DATA LINK PROTOCOL

ODY	NASA Mars Survey Project 2001 Odyssey Orbiter
OSI	Open Systems Interconnection
PC	Physical Channel
PCID	Physical Channel ID
PCM	Pulse Code Modulation
PDU	Protocol Data Unit
P-frame	Supervisory/Protocol Frame
PLCW	Proximity Link Control Word
PLTU	Proximity Link Transmission Unit
PSK	Phase Shift Keyed
QOS	Quality of Service
RF	Radio Frequency
RHCP	Right Hand Circular Polarized
R-S	Reed-Solomon
RX	Receive
SAP	Service Access Point
SCID	Spacecraft Identifier
SCPS-NP	Space Communications Protocol Standards-Network Protocol
SDU	Service Data Unit
SPDU	Supervisory Protocol Data Unit
TCP	Time Correlation Packet
TX	Transmit
U-frame	User Data Frame
UHF	Ultra High Frequency
VE(S)	Value of the next Expedited Frame Sequence Number to be sent
V(S)	Value of the next Sequence Controlled Frame Sequence Number to be sent

## ANNEX F

## INFORMATIVE REFERENCES

**(Informative)**

NOTE – The references in this annex define Physical layer techniques that are not part of the Proximity-1 Physical layer specification. They are included here so that transceivers with an extended Physical Layer can interoperate.

- [F1] *Digital Video Broadcasting (DVB); Framing Structure, Channel Coding, and Modulation for 11/12 GHz Satellite Services*. ETSI EN 300 421 V1.1.2 (1997-08). Valbonne: ETSI, 1997.
- [F2] *A 48/56/64 kbit/s Data Circuit-terminating Equipment Standardized for Use on Digital Point-to-Point Leased Circuits*. ITU-T Recommendation V.38. Geneva: ITU, October 1996.
- [F3] *Performance Characteristics for Intermediate Data Rate Digital Carriers Using Convolutional Encoding/Viterbi Encoding and QPSK Modulation (QPSK/IDR) (Standard A, B, C, E and F Earth Stations)*. Intelsat Earth Station Standard, IESS-308. Rev. 10. Washington, D.C.: Intelsat, February 2000.

---

---

**ICS 49.140**

Price based on 123 pages