**Plastics — Determination of scratch
properties**

Plastiques — Détermination du comportement à la rayure



Reference number
ISO 19252:2008(E)

© ISO 2008

PDF disclaimer

This PDF file may contain embedded typefaces. In accordance with Adobe's licensing policy, this file may be printed or viewed but shall not be edited unless the typefaces which are embedded are licensed to and installed on the computer performing the editing. In downloading this file, parties accept therein the responsibility of not infringing Adobe's licensing policy. The ISO Central Secretariat accepts no liability in this area.

Adobe is a trademark of Adobe Systems Incorporated.

Details of the software products used to create this PDF file can be found in the General Info relative to the file; the PDF-creation parameters were optimized for printing. Every care has been taken to ensure that the file is suitable for use by ISO member bodies. In the unlikely event that a problem relating to it is found, please inform the Central Secretariat at the address given below.



COPYRIGHT PROTECTED DOCUMENT

© ISO 2008

All rights reserved. Unless otherwise specified, no part of this publication may be reproduced or utilized in any form or by any means, electronic or mechanical, including photocopying and microfilm, without permission in writing from either ISO at the address below or ISO's member body in the country of the requester.

ISO copyright office
Case postale 56 • CH-1211 Geneva 20
Tel. + 41 22 749 01 11
Fax + 41 22 749 09 47
E-mail copyright@iso.org
Web www.iso.org

Published in Switzerland

Contents

Page

Foreword	iv
1 Scope	1
2 Normative references	1
3 Terms and definitions	2
4 Principle	4
5 Apparatus	4
6 Test specimens	6
7 Procedure	7
8 Expression of results	10
9 Test report	14
Annex A (informative) Photographic illustrations of different types of scratch behaviour	16
Annex B (informative) Test machine	17
Bibliography	18

Foreword

ISO (the International Organization for Standardization) is a worldwide federation of national standards bodies (ISO member bodies). The work of preparing International Standards is normally carried out through ISO technical committees. Each member body interested in a subject for which a technical committee has been established has the right to be represented on that committee. International organizations, governmental and non-governmental, in liaison with ISO, also take part in the work. ISO collaborates closely with the International Electrotechnical Commission (IEC) on all matters of electrotechnical standardization.

International Standards are drafted in accordance with the rules given in the ISO/IEC Directives, Part 2.

The main task of technical committees is to prepare International Standards. Draft International Standards adopted by the technical committees are circulated to the member bodies for voting. Publication as an International Standard requires approval by at least 75 % of the member bodies casting a vote.

Attention is drawn to the possibility that some of the elements of this document may be the subject of patent rights. ISO shall not be held responsible for identifying any or all such patent rights.

ISO 19252 was prepared by Technical Committee ISO/TC 61, *Plastics*, Subcommittee SC 2, *Mechanical properties*.

Plastics — Determination of scratch properties

IMPORTANT — The electronic file of this document contains colours which are considered to be useful for the correct understanding of the document. Users should therefore consider printing this document using a colour printer.

1 Scope

1.1 This International Standard specifies a method for determining the scratch properties of plastics under defined conditions. The method involves making a scratch by moving a hard instrument (scratch tip) of specified geometry under specified conditions of load and speed across the surface of a test specimen and then assessing the result.

1.2 The method is used to investigate the behaviour of specified types of specimen under the scratch conditions defined and for classifying the type of scratch of specimens within the limitations inherent in the test conditions. It can also be used to determine comparative data for different types of material by means of a so-called scratch map in which the types of scratch behaviour for each set of test conditions of test load and test speed are determined using the basic method of constant-load testing, and also by means of the so-called critical normal load (see 3.8) determined using an alternative method of linearly increasing load testing.

1.3 The method is suitable for use with uncoated and unlacquered thermoplastic moulding materials and thermosetting moulding materials.

1.4 The method specifies the preferred dimensions for the test specimen and the preferred scratch-tip geometry.

2 Normative references

The following referenced documents are indispensable for the application of this document. For dated references, only the edition cited applies. For undated references, the latest edition of the referenced document (including any amendments) applies.

ISO 291, *Plastics — Standard atmospheres for conditioning and testing*

ISO 294-1, *Plastics — Injection moulding of test specimens of thermoplastic materials — Part 1: General principles, and moulding of multipurpose and bar test specimens*

ISO 3167:2002, *Plastics — Multipurpose test specimens*

ISO 10724-1:1998, *Plastics — Injection moulding of test specimens of thermosetting powder moulding compounds (PMCs) — Part 1: General principles and moulding of multipurpose test specimens*

3 Terms and definitions

For the purposes of this document, the following terms and definitions apply.

3.1 scratch
damage made by a hard instrument (scratch tip) when moved across a test specimen surface under specified conditions of tip geometry, test load and test speed (see Figure 1)

NOTE The term “surface”, as used in this definition, applies to the macroscopic surface and not the microscopic surface.

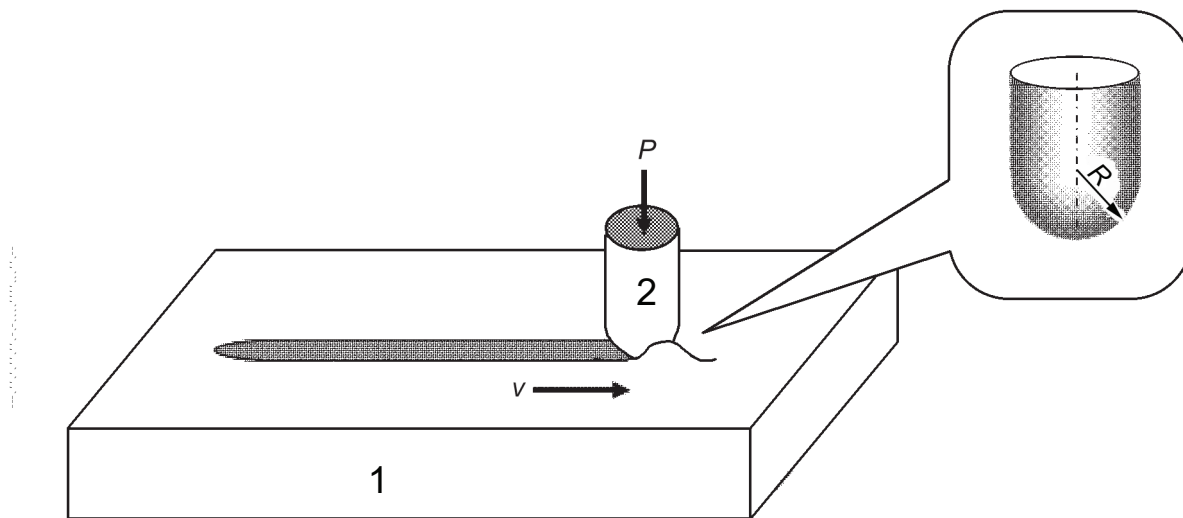

- Key**
- 1 test specimen
 - 2 scratch tip
 - P test load
 - v test speed

Figure 1 — Schematic representation of a scratch (see 3.1)

3.2 test load
 P
load applied by the scratch tip perpendicularly to the test specimen during the test

NOTE It is expressed in newtons.

3.3 test speed
 v
relative rate of displacement between the scratch tip and the test specimen during the test

NOTE It is expressed in millimetres per second.

3.4 scratch force
 F_s
horizontal force between the scratch tip and the test specimen at any given moment during the test

NOTE It is expressed in newtons.

3.5 scratch-tip displacement

d

vertical displacement of the scratch tip relative to the test specimen surface at any given moment during the test

NOTE It is expressed in micrometres.

3.6 scratch distance

s

horizontal distance travelled by the scratch tip relative to the test specimen at any given moment during the test

NOTE It is expressed in millimetres.

3.7 scratch behaviour

type of deformation of the material under the action of the scratch tip

NOTE Scratch behaviour is classified into three types: ploughing (p), wedge formation (w) and cutting (c), as defined in 3.7.1 to 3.7.3.

3.7.1 ploughing

p

scratch behaviour in which the scratch force and scratch-tip displacement are constant over the scratch distance during the test (see Figure 2)

NOTE 1 The surface of the scratch is smooth along its whole length rather than rough.

NOTE 2 A small, inherent level of episodic signal oscillation (of amplitude less than 3 N in the scratch force and 10 µm in the tip displacement) is acceptable.

3.7.2 wedge formation

w

scratch behaviour in which the scratch force and/or scratch-tip displacement oscillate, resulting in a corresponding increase in the actual distance travelled by the scratch tip during the test (see Figure 2)

NOTE The surface of the scratch exhibits a continuous serrated or wedge-like pattern, and stick-slip occurs.

3.7.3 cutting

c

scratch behaviour in which the scratch force and/or scratch-tip displacement vary randomly, resulting in a corresponding increase in the actual distance travelled by the scratch tip during the test (see Figure 2)

NOTE During the test, chips are cut from the surface.

3.8 critical normal load

P_c

minimum normal load at which wedge formation or cutting, whichever occurs first, takes place at a given test speed

NOTE It is expressed in newtons.

4 Principle

A standard test specimen is scratched by a hard tip which applies a load perpendicular to the test specimen and moves lengthwise across the surface at a constant speed along the centreline of the test specimen. During the scratch, the horizontal force between the scratch tip and the test specimen (the scratch force), the vertical displacement of the scratch tip (tip displacement) and the scratch distance are each measured continuously and recorded. The scratch force/scratch distance and tip displacement/scratch distance diagrams thus produced describe the scratch behaviour of the test specimen. Using the basic method of constant-load testing, the type of scratch behaviour can be determined for a series of test conditions (load and speed) and expressed as a so-called scratch map. Using an alternative method of linearly increasing load testing, the critical normal load can be determined at a given test speed (see Table 1). Changes in slope and/or spikes in the scratch force/scratch distance curve indicate transitions from one type of scratch behaviour to another (e.g. from ploughing to wedge formation or to cutting).

5 Apparatus

5.1 Test machine

5.1.1 General

The test machine shall consist essentially of a frame with a specimen support, a scratch tip with its associated fittings, and a device for applying the load (see Annex B), and shall meet the specifications given in 5.1.2 to 5.1.8.

5.1.2 Frame

The frame of the machine shall be capable of being levelled and shall not be deformed by more than 3 μm under the maximum load.

5.1.3 Scratch tip

The scratch tip shall be hardened to at least Rockwell HRC 64 hardness, shall be polished to a roughness of less than 0,20 μm and shall not show any deformation or damage after a test.

The scratch tip shall be hemispherical in shape, with an outside radius R of 0,5 mm \pm 0,025 mm.

NOTE Tips made from hardened and polished steel or tungsten carbide have been found to be satisfactory.

5.1.4 Test load

The machine shall be capable of maintaining the test load within a tolerance of $\pm 1\%$, for any test load chosen as specified in 7.2.3, and shall be capable of applying the load perpendicular to the test specimen within a tolerance of $\pm 5^\circ$.

5.1.5 Test speed

The machine shall be capable of maintaining the test speed within a tolerance of $\pm 1\%$, except over the first and the last 10 mm of the scratch distance, for any test speed chosen as specified in 7.2.4 and shall be capable of reaching the test speed within 10 mm and stopping within 10 mm.

5.1.6 Test specimen support

The test specimen support shall be flat, smooth and free of holes in the area where the test specimen will be placed.

The clamping system for holding the test specimen on the support shall be attached to the test machine so that the longitudinal axis of the test specimen coincides with the line of scratch.

The clamping system shall not cause any premature fracture of the test specimen, and the test specimen shall be held in such a way that it cannot slip relative to the specimen support.

5.1.7 Load indicator

The load indicator shall incorporate a mechanism capable of showing the horizontal force between the scratch tip and the test specimen continuously during the test. The mechanism shall be essentially free from inertia lag at the specified test speeds and shall indicate the load with an accuracy equal to or within $\pm 1\%$ of the actual value.

5.1.8 Scratch tip displacement gauge

A mechanical or, preferably, an electronic device shall be used which incorporates a mechanism capable of indicating the vertical displacement of the scratch tip to an accuracy of $\pm 1\ \mu\text{m}$ or better under static conditions. The mechanism shall be essentially free from inertia lag at the specified test speeds and shall be capable of indicating the vertical displacement of the scratch tip to an accuracy of $\pm 10\ \mu\text{m}$ or better continuously during the test.

5.2 Instruments for measuring the test specimen dimensions

The width b of the test specimen shall be measured using a micrometer or gauge with an accuracy of $\pm 0,01\ \text{mm}$ or better. For measuring the thickness h of the test specimen, a micrometer with a flat circular foot reading to $\pm 0,01\ \text{mm}$ or less shall be used.

5.3 Monitoring and inspection devices (optional)

5.3.1 Monitoring device

A monitoring device, such as a video camera equipped with a recording system and a magnifying mechanism, is useful for monitoring the area around the scratch tip during the test (see 7.2.9, 8.2 and 8.4).

The device shall not have any thermal effect on the specimen.

5.3.2 Scratch inspection device

In addition to inspection with the naked eye, a device such as a magnifying glass, microscope, flatbed scanner or interferometer is useful for observing the appearance of the surface of the scratch after the test (see 7.2.9, 8.2 and 8.4).

The device shall not have any thermal effect on the specimen.

NOTE When testing using a linearly increasing load (the alternative method), an image of the surface of the scratch at the critical normal load can be generated with the aid of computer software using, for instance, a "grey-level threshold" programme (see Figure 4).

6 Test specimens

6.1 Shape and dimensions

Type A multipurpose test specimens as specified in ISO 3167:2002 shall be used.

6.2 Preparation

6.2.1 Moulding

Test specimens shall be directly injection-moulded in accordance with ISO 294-1 or ISO 10724-1, as appropriate, under conditions defined in the relevant standard for the material under examination.

The specimens shall be suitably marked outside the test area to indicate the melt-flow direction, the particular cavity from which the specimen came (when using a multi-cavity mould) as well as the side of the mould (cavity-plate side or fixed-plate side) on which a particular specimen face was formed (see e.g. ISO 10724-1:1998, Annex B).

NOTE Certain types of material may show different scratch behaviour depending on the face of the specimen which is tested and/or the melt-flow direction.

Strict control of all conditions during specimen preparation is essential to ensure that all test specimens are in the same state.

6.2.2 Inspection of specimens and measurement of specimen dimensions

Test specimens shall be free of twist. The faces and edges shall be free from scratches, pits, sink marks, flash and other imperfections.

Test specimens shall be checked for conformity with these requirements by visual observation, using straight edges, squares and flat plates, and by measuring the dimensions (thickness and width) of the parallel-sided section to the nearest 0,01 mm with instruments as specified in 5.2.

Specimens showing measurable or observable departure from any of these requirements shall be rejected.

With injection-moulded specimens, it is not necessary to measure the dimensions of each specimen. It is sufficient to measure one specimen from each set. When using multi-cavity moulds, measure the dimensions of a specimen from each cavity. If the difference in dimensions between mould cavities is greater than 0,02 mm, the specimens from each cavity shall be treated as different batches.

6.3 Number of test specimens

For determining the type of scratch behaviour as specified in 8.2, a single specimen is required for each set of test conditions if only one type of scratch behaviour occurs during a single test. Three specimens are required for each set of test conditions when several types of scratch behaviour occur during a single test.

In order to obtain a scratch map as specified in 8.3, it is recommended that at least 25 different sets of test conditions (for example, five different constant test loads and five different test speeds), and hence a total of at least 25 specimens, be used.

To determine the critical normal load as specified in 8.4, three specimens are required for each set of test conditions (i.e. for each test speed).

6.4 Conditioning

Unless otherwise specified in the standard for the material under test or agreed upon by the interested parties, specimens shall be conditioned for at least 16 h in one of the standard atmospheres specified in ISO 291.

7 Procedure

7.1 Test atmosphere

The atmosphere used for the test shall be the same as that used for conditioning, unless otherwise agreed upon by the interested parties, e.g. for testing at high or low temperatures. It is recommended that one of the standard atmospheres specified in ISO 291 be used.

The test temperature shall be measured and recorded during the test.

7.2 Scratch test

7.2.1 General

The scratch test shall be conducted on each specimen in turn in accordance with the procedure and conditions specified in 7.2.2 to 7.2.9.

7.2.2 Scratch tip

Use the scratch tip specified in 5.1.3.

Before the test, check that the baseline against which vertical scratch-tip displacement will be measured along the intended scratch line is constant to within 10 μm .

NOTE 1 The scratch-tip displacement baseline can be checked using, for example, a flat metal bar, whose thickness is known to within a few microns, clamped on to the test specimen support.

Before testing each specimen, check under at least $\times 10$ magnification that the surface of the scratch tip is not coated with any plastic filings and is not damaged in any way.

NOTE 2 The scratch tip can be checked using, for example, a microscope, a magnifying glass or the monitoring or inspection device (see 5.3).

7.2.3 Test load

7.2.3.1 General

Before the test, verify that the test loads to be used are applied within the tolerance limits specified in 5.1.4.

Depending on the method to be used (see Table 1), select the test load in accordance with 7.2.3.2 or 7.2.3.3.

7.2.3.2 Constant load (basic method)

To determine the type of scratch behaviour (see 8.2) and to obtain a scratch map (see 8.3), use a constant load produced by means of weightpiece.

It is recommended that the test load for determining the type of scratch behaviour be chosen from the six following loads:

1 N, 2 N, 5 N, 10 N, 20 N, 50 N (constant to within $\pm 1\%$).

To obtain a scratch map (see Figure 3), select at least five different constant test loads from the series above. The preferred loads are the following:

1 N, 5 N, 10 N, 20 N, 50 N (constant to within $\pm 1\%$).

7.2.3.3 Linearly increasing load (alternative method)

Use the linearly increasing load method for determining the critical normal load (see 8.4).

The test load for this method shall be increased linearly from 1 N to 50 N (to within ± 1 %) over a distance of 100 mm ± 0,5 mm at the specified test speed.

Table 1 — Method used and test conditions

Method	Use	Test load, P^a	Overall scratch distance, s^b	Scratch length assessed c
Basic method d	Determination of the type of scratch behaviour under given conditions (see 8.2) To obtain a scratch map (see 8.3)	Constant load: 1 N, 2 N, 5 N, 10 N, 20 N, 50 N	At least 100 mm	50 mm (within the parallel-sided section of the specimen)
Alternative method e	Determination of the critical normal load at a given test speed (see 8.4)	Linearly increasing load: 1 N to 50 N	100 mm ± 0,5 mm	100 mm (i.e. whole scratch distance)
a Test load as specified in 7.2.3. b Overall scratch distance as specified in 7.2.7.7. c See 8.2 and 8.4. d Preferred method for determining the type of scratch behaviour and for obtaining a scratch map. e Preferred method for determining the critical normal load.				

7.2.4 Test speed

Verify that the machine used meets the requirements specified in 5.1.5, for example by checking the scratch distance versus time relationship before and/or during the test.

It is recommended that the test speed be chosen from the eight following speeds:

1 mm/s, 2 mm/s, 5 mm/s, 10 mm/s, 20 mm/s, 50 mm/s, 100 mm/s, 200 mm/s (constant to within ± 1 % except for the first and the last 10 mm of the scratch distance).

To obtain a scratch map (see Figure 3), select at least five different test speeds from the series above. The preferred speeds are the following:

1 mm/s, 5 mm/s, 10 mm/s, 50 mm/s, 100 mm/s (constant to within ± 1 % except for the first and the last 10 mm of the scratch distance).

7.2.5 Test direction

The test direction, i.e. the direction in which the scratch is made, shall be in the melt-flow direction with respect to the injection moulding of the test specimen.

NOTE See also Annex B.

7.2.6 Clamping

Place a test specimen on the specimen support with the face formed by the cavity plate of the mould facing upwards, taking care to align the longitudinal axis of the specimen with the axis of the test machine and making sure that the scratch direction is as specified in 7.2.5.

Tighten the grips evenly and firmly to avoid slippage of the specimen.

During these operations, the surface of the specimen shall not become contaminated, for example with oil due to finger contact.

To avoid over-stressing due to clamping, especially with specimens made of less rigid materials, the clamping pressure shall be only slightly above that required to prevent slippage.

7.2.7 Testing

7.2.7.1 Check that the specimen is properly mounted on the specimen support and that the melt-flow direction coincides with the scratch direction. Remove any dust on the specimen using a jet of air.

7.2.7.2 Check under at least $\times 10$ magnification that the scratch tip is not coated with any plastic filings and is not damaged (see 7.2.2).

7.2.7.3 Lower the scratch tip gently onto the specimen surface under an initial load not exceeding 0,5 N.

7.2.7.4 Set the scratch-tip displacement gauge to zero.

7.2.7.5 Apply the test load smoothly and gently within 5 s.

7.2.7.6 Within 30 s to 1 min after application of the test load, start the movement of the scratch tip relative to the specimen surface.

7.2.7.7 For constant-load tests, the distance from the start to the end of the scratch-tip travel shall be at least 100 mm and for linearly increasing load tests it shall be $100 \text{ mm} \pm 0,5 \text{ mm}$.

7.2.7.8 A test specimen shall not be tested more than once, even on the other face of the specimen, because the damage produced by the previous test may change the specimen thickness and hence alter the scratch behaviour.

7.2.8 Recording of data

Record the scratch force, the tip displacement and the corresponding values of the scratch distance during the test. The data obtained are used to produce scratch force/scratch distance and tip displacement/scratch distance diagrams (see Figure 2).

The recording shall not be interrupted before the scratch tip has travelled the required scratch distance.

7.2.9 Monitoring of scratch behaviour and inspection of the scratched surface (optional)

The scratch behaviour during the test may be monitored using a device in accordance with 5.3.1.

The appearance of the scratched surface after the test may be inspected using a device in accordance with 5.3.2.

NOTE Monitoring of the scratch behaviour during the test and inspection of the scratched surface after the test provide information which is useful when expressing the results (see 8.2 and 8.4).

8 Expression of results

8.1 General

From the scratch force/scratch distance diagrams and tip displacement/scratch distance diagrams obtained during the tests, the type of scratch behaviour of each specimen is classified as ploughing (p), wedge formation (w) or cutting (c), as defined in 3.7.1 to 3.7.3. Both types of diagram are required for this (see 8.2).

When the basic (constant-load) method has been used, the type of scratch behaviour under several different sets of test conditions can be determined and expressed as a scratch map (see 8.3).

When the alternative (linearly increasing load) method has been used, the transition in the type of scratch behaviour from ploughing (p) to wedge formation (w) or to cutting (c), whichever comes first, will be seen to occur at a certain test speed. The load corresponding to this transition point is determined and expressed as the critical normal load (see 8.4).

8.2 Determination of type of scratch behaviour

Using the scratch force/scratch distance and tip displacement/scratch distance diagrams obtained using the basic (constant-load) method, evaluate a scratch distance of 50 mm within the narrow parallel-sided section of the specimen. Determine whether the scratch force and tip displacement are constant, cyclic or random with respect to the scratch distance, i.e. whether the diagrams show ploughing (p), wedge formation (w) or cutting (c) behaviour, as defined in 3.7.1 to 3.7.3 and shown in Figure 2.

Monitoring of the scratch behaviour during the test and/or inspection of the scratched surface after the test (see 7.2.9 and the photos at the bottom of Figure 2) may be helpful in determining the result. A smooth scratched surface indicates ploughing, a serrated surface indicates wedge formation and the presence of chips indicates cutting behaviour.

For specimens showing more than one type of scratch behaviour, give cutting precedence over wedge formation and ploughing, and give wedge formation precedence over ploughing.

NOTE 1 A small, inherent level of episodic signal oscillation (amplitude of less than 3 N in the scratch force and 10 μm in the scratch tip displacement) can be ignored.

NOTE 2 The scratch force F_s tends to be much more responsive to changes in scratch behaviour than the scratch-tip displacement d .

NOTE 3 In the case of cutting, the mean value of the scratch-tip displacement d is large compared to the value observed with ploughing or wedge formation.

NOTE 4 The purpose of monitoring and inspection is simply to assist in the determination of the type of scratch behaviour using the diagrams.

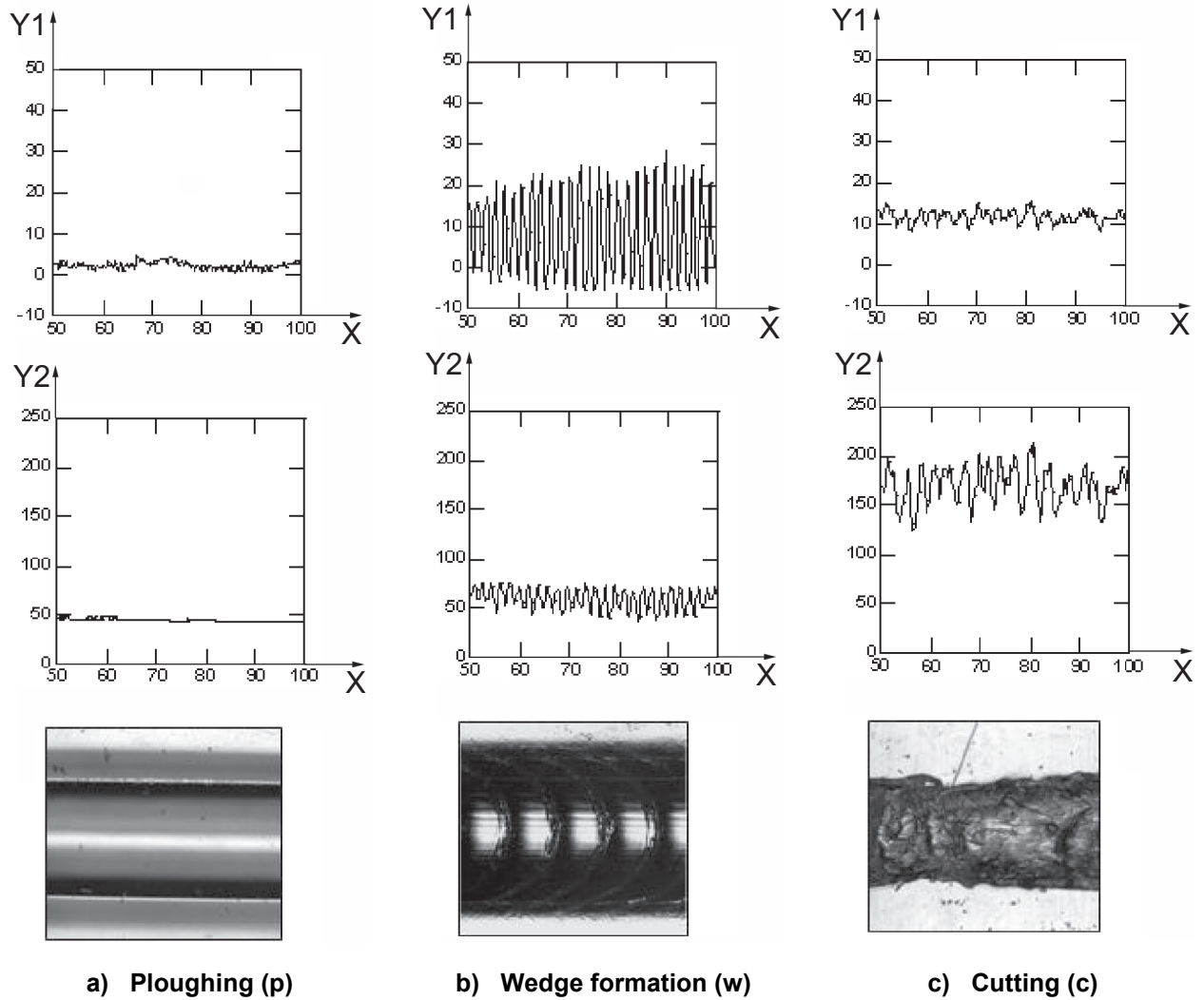

Key

- X scratch distance, s (mm)
- Y_1 scratch force, F_s (N)
- Y_2 scratch-tip displacement, d (μm)

p ploughing

The scratch force and scratch-tip displacement are constant over the whole scratch distance and the scratched surface is smooth along the whole length of the scratch (see 3.7.1).

w wedge formation

The scratch force and/or scratch-tip displacement oscillate as the scratch distance increases, the scratched surface exhibits a continuous serrated or wedge-like pattern and stick-slip occurs (see 3.7.2).

c cutting

The scratch force and/or scratch-tip displacement vary randomly as the scratch distance increases and chips are produced (see 3.7.3).

Figure 2 — Typical scratch force/scratch distance diagram, tip displacement/scratch distance diagram and photo of scratched surface for each type of scratch behaviour specified in 3.7.1 to 3.7.3

8.3 Creation of scratch map

Using the results obtained with the various test loads and test speeds selected in 7.2.3.2 and 7.2.4, respectively, create a scratch map by indicating the types of scratch behaviour obtained as a log-log plot of test load versus test speed, as shown in Figure 3.

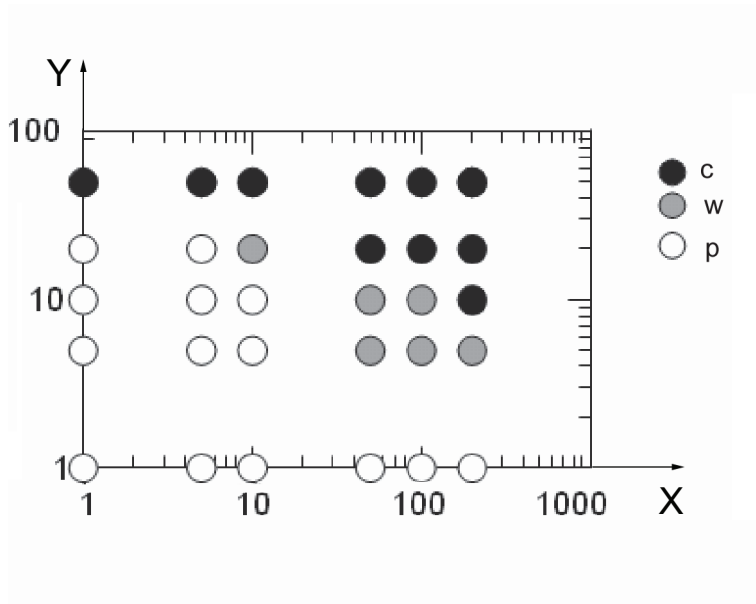

Key

- X test speed, v (mm/s)
- Y test load, P (N)
- c cutting
- w wedge formation
- p ploughing

Figure 3 — Example of a scratch map

8.4 Determination of critical normal load

From the results obtained using the alternative (linearly increasing load) method, prepare a scratch force/scratch distance diagram for the scratch distance of $100 \text{ mm} \pm 0,5 \text{ mm}$. Any changes in the slope of the scratch force/scratch distance curve and the presence of spikes (sudden changes) in the curve represent changes in the type of scratch behaviour (e.g. from ploughing to wedge formation or to cutting).

For each test specimen, determine the point at which the slope of the scratch force/scratch distance curve first changes. The test load applied at this point is taken to be the critical normal load for that particular specimen (see Figure 4).

Monitoring of the scratch behaviour during the test and/or inspection of the scratched surface after the test as described in 7.2.9 may also be used in support of the determination of the critical normal load. The change in the appearance of the scratched surface assists in detecting the transition from one type of scratch behaviour to another.

From the scratch distance at which the transition occurred, the critical normal load for each test specimen can also be calculated for each test specimen using the following equation:

$$P_{Ci} = 1 + (50 - 1)s_{Ci}/100 \quad (1)$$

where

P_{Ci} is the critical normal load for the i th specimen, in newtons;

s_{Ci} is the scratch distance at which the first transition (from ploughing to wedge formation or to cutting) occurs for the i th specimen, in millimetres;

Take the mean value for all the test specimens as the critical normal load P_C , calculated using the following equation:

$$P_C = \frac{1}{n} \sum_{i=1}^{i=n} P_{Ci} \quad (2)$$

where

P_C is the critical normal load, in newtons;

P_{Ci} is the critical normal load for the i th specimen, in newtons.

NOTE 1 The point at which the critical normal load occurs can also be detected from the image of the scratched surface with the aid of computer software, e.g. a "grey-level threshold" programme (see Note 2 to Figure 4).

NOTE 2 In principle, the data obtained on these transition points can be used to construct a scratch map.

NOTE 3 No correlation has yet been established between the basic (constant-load) method and the alternative (linearly increasing load) method.

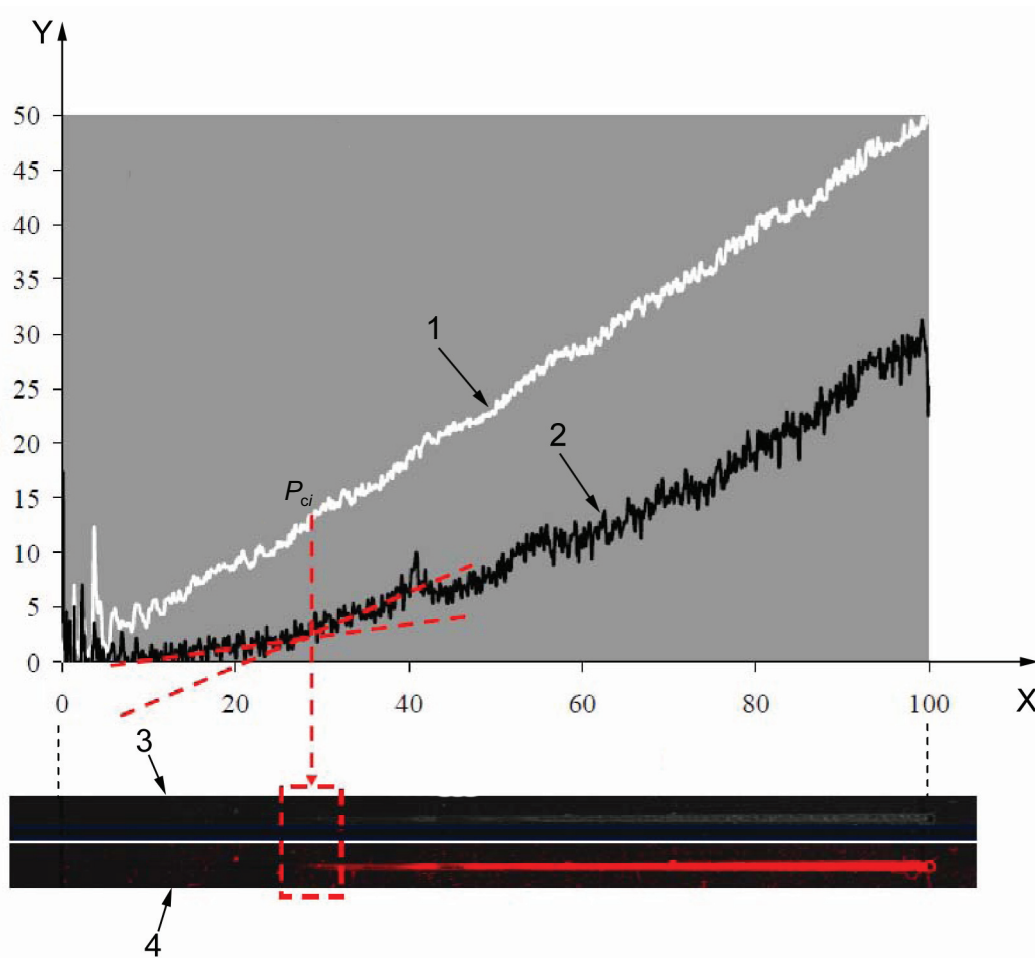

Key

X scratch distance, s (mm)
 Y test load/scratch force (N)

- 1 test load vs scratch distance
 - 2 scratch force vs scratch distance
 - 3 image of scratched surface as seen using an ordinary scratch inspection device (see 5.3.2)
 - 4 computer-enhanced image of scratched surface
- P_{ci} critical normal load for i th specimen

NOTE 1 The critical normal load P_c is the normal force at the point at which the slope of the “scratch force” curve first changes from ploughing to wedge formation or to cutting behaviour (see 8.4).

NOTE 2 The two horizontal strips under the main plot show images of the scratched surface. While the scratch can barely be seen in the upper image, the digitized image enhanced using “grey-level threshold” software (e.g. Image J) (lower image) can be seen to be a useful aid in the detection of the transition in scratch behaviour.

Figure 4 — Determination of critical normal load

9 Test report

The test report shall include the following information:

- a) a reference to this International Standard;

- b) all information necessary for complete identification of the material tested, including type, source, manufacturer's code-number, grade and history, where these are known;
- c) details of the method used to prepare the test specimens;
- d) the width and thickness of the test specimens;
- e) the standard atmosphere used for conditioning and testing and the temperature measured during the test;
- f) the test loads P and test speeds v used;
- g) the total number of specimens tested;
- h) the scratch force/scratch distance diagram and scratch-tip displacement/scratch distance diagram produced for each individual specimen (see Figure 2), if required;
- i) the scratch map (see Figure 3) produced in the case of the basic (constant-load) method, if individual results (see item j) are not required;
- j) the individual results for each test specimen, i.e. the type of scratch behaviour and the scratch conditions used in the case of the basic (constant-load) method, if a scratch map (see item i) is not required, presented for instance in the following way:

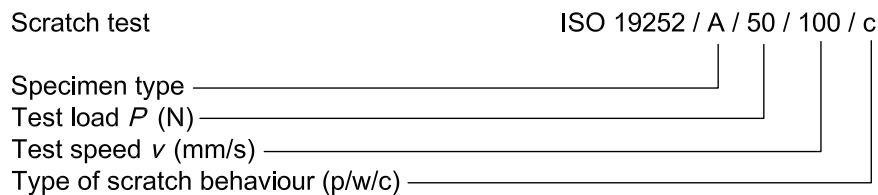

- k) the critical normal load P_c determined (see 8.4) in the case of the alternative (linearly increasing load) method;
- l) the image of the scratched surface for each specimen, if required;
- m) the date of testing.

Annex A (informative)

Photographic illustrations of different types of scratch behaviour

Figure A.1 shows typical photographs taken during the scratching of specimens exhibiting different types of scratch behaviour.

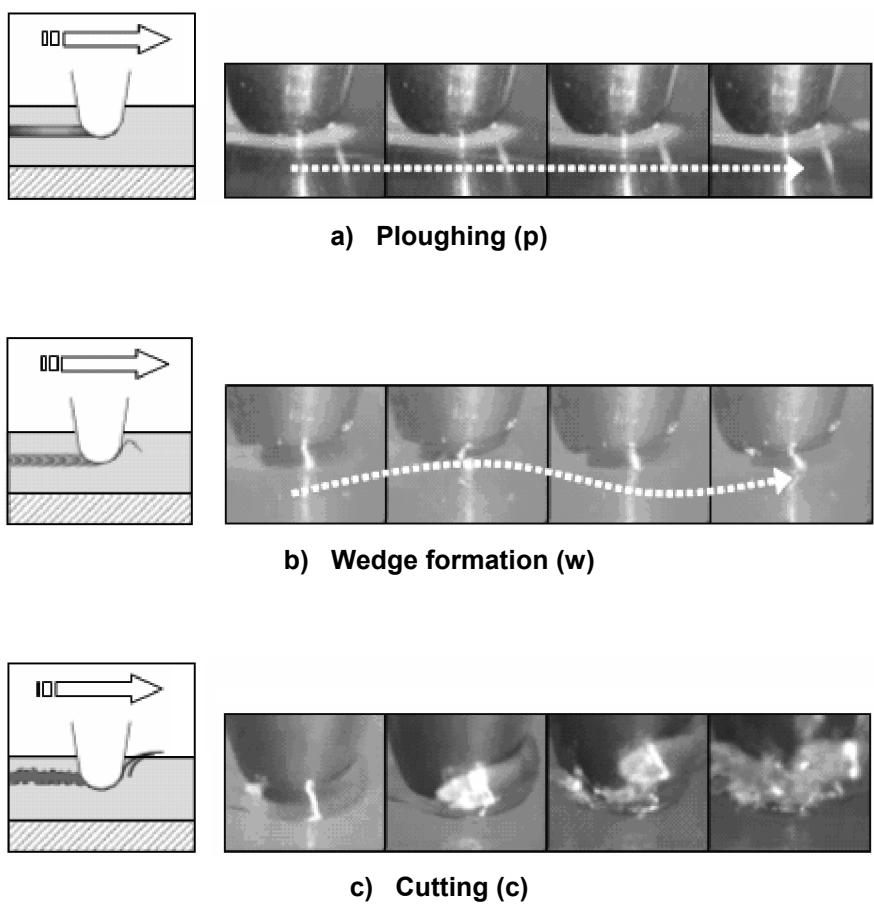
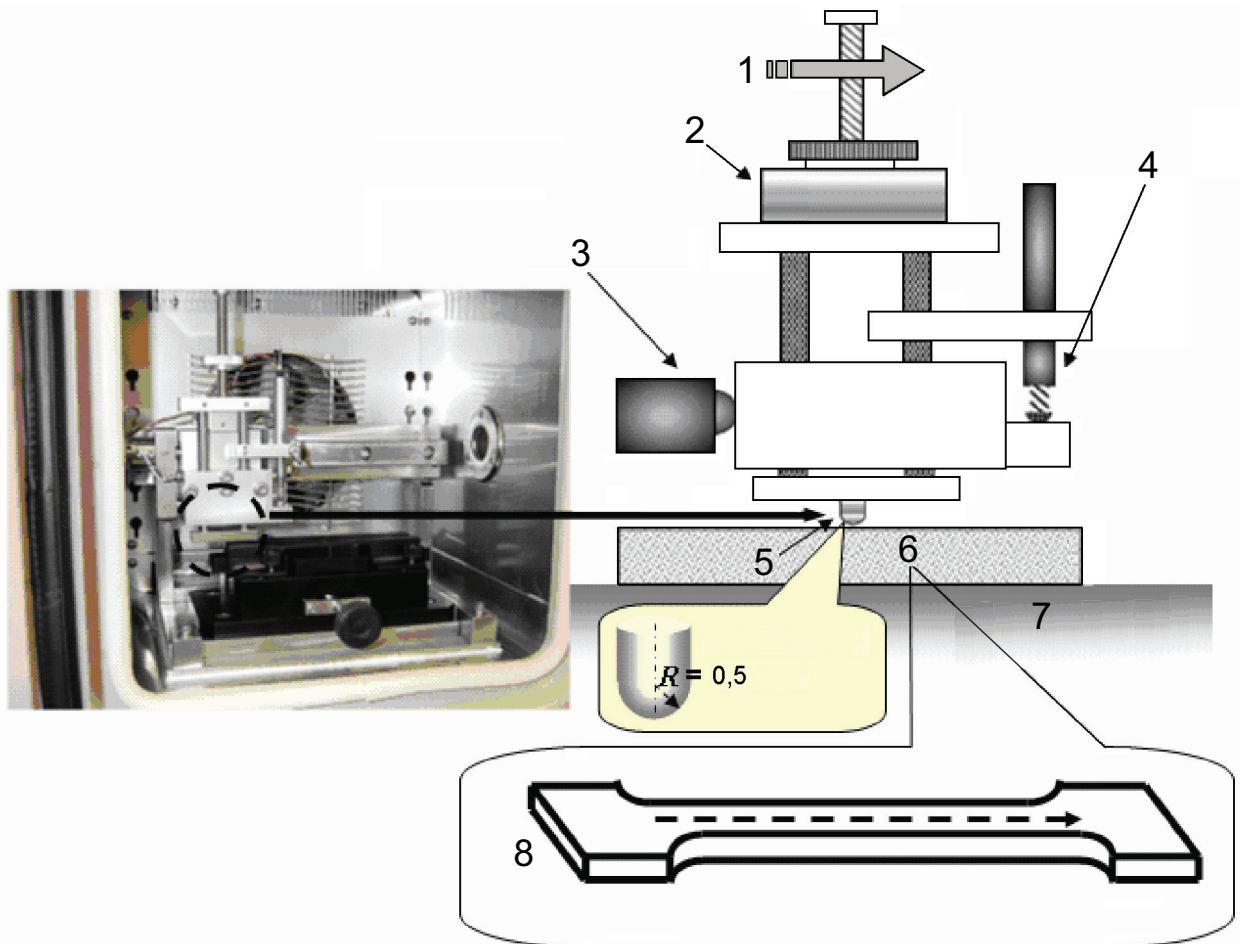

Figure A.1 — Photographs of different types of scratch behaviour as defined in 3.7.1 to 3.7.3

Annex B
(informative)

Test machine

Dimensions in millimetres



Key

- | | | | |
|---|---|---|--------------------------------|
| 1 | test speed v (1 mm/s to 200 mm/s) | 5 | scratch tip |
| 2 | weightpiece for applying the test load P (1 N to 50 N) | 6 | test specimen |
| 3 | load cell for measuring the scratch force F_s | 7 | specimen support |
| 4 | extensometer for measuring the scratch-tip displacement d | 8 | injection gate end of specimen |

Figure B.1 — An example of a scratch test machine

Bibliography

- [1] KITA, H., MAKI, M., KITAMURA, T., KURIYAMA, T.: *ANTEC proceedings*, p. 1938 (2004)
- [2] KITA, H., ISHIKI, M., MAKI, M., KITAMURA, T., KURIYAMA, T.: *ANTEC proceedings*, p. 2992 (2003)
- [3] KOTAKI, M., XIA, Z.-Y., SLAY, J.B., STRAUB, C., SUE, H.-J.: *ICAPP*, p. 52 (2001)
- [4] KOTAKI, M., XIANG, C., SUE, H.-J.: *ICAPP*, p. 64 (2001)
- [5] ASTM D 7027, *Standard Test Method for Evaluation of Scratch Resistance of Polymeric Coatings and Plastics Using an Instrumented Scratch Machine*
- [6] BROWNING, R.L., LIM, G.-T., MOYSE, A., SUE, H.-J., CHEN, H., EARLS, J.D.: *Surface and Coatings Technology*, **201**, pp. 2970-2976 (2006)
- [7] WONG, M., LIM, G.-T., MOYSE, A., REDDY, J.N., SUE, H.-J.: *Wear*, **256**, pp. 1214-1227 (2004)

© 2005 International Organization for Standardization

ICS 83.080.01

Price based on 18 pages