**Geographic information — Linear
referencing**

Information géographique — Référencement linéaire

© ISO 2012



Reference number
ISO 19148:2012(E)

© ISO 2012



COPYRIGHT PROTECTED DOCUMENT

© ISO 2012

All rights reserved. Unless otherwise specified, no part of this publication may be reproduced or utilized in any form or by any means, electronic or mechanical, including photocopying and microfilm, without permission in writing from either ISO at the address below or ISO's member body in the country of the requester.

ISO copyright office
Case postale 56 • CH-1211 Geneva 20
Tel. + 41 22 749 01 11
Fax + 41 22 749 09 47
E-mail copyright@iso.org
Web www.iso.org

Published in Switzerland

Contents

Page

Foreword	iv
Introduction.....	v
1 Scope	1
2 Conformance	1
2.1 Conformance overview	1
2.2 Conformance classes	2
3 Normative references.....	3
4 Terms and definitions	3
5 Abbreviated terms	6
6 Linear referencing	6
6.1 Introduction.....	6
6.2 Package: Linear Referencing System	17
6.3 Package: Linear Referencing Towards Referent	31
6.4 Package: Linear Referencing Offset.....	33
6.5 Package: Linear Referencing Offset Vector	39
6.6 Package: Linearly Located Event	41
6.7 Package: Linear Segmentation	47
Annex A (normative) Abstract test suite	52
Annex B (informative) Generalized model for linear referencing.....	56
Annex C (informative) Commonly used linear referencing methods and models	59
Annex D (informative) Event and segmentation examples.....	79
Bibliography.....	86

Foreword

ISO (the International Organization for Standardization) is a worldwide federation of national standards bodies (ISO member bodies). The work of preparing International Standards is normally carried out through ISO technical committees. Each member body interested in a subject for which a technical committee has been established has the right to be represented on that committee. International organizations, governmental and non-governmental, in liaison with ISO, also take part in the work. ISO collaborates closely with the International Electrotechnical Commission (IEC) on all matters of electrotechnical standardization.

International Standards are drafted in accordance with the rules given in the ISO/IEC Directives, Part 2.

The main task of technical committees is to prepare International Standards. Draft International Standards adopted by the technical committees are circulated to the member bodies for voting. Publication as an International Standard requires approval by at least 75 % of the member bodies casting a vote.

Attention is drawn to the possibility that some of the elements of this document may be the subject of patent rights. ISO shall not be held responsible for identifying any or all such patent rights.

ISO 19148 was prepared by Technical Committee ISO/TC 211, *Geographic information/Geomatics*.

.....

Introduction

This International Standard is a description of the data and operations required to support linear referencing. This includes Linear Referencing Systems, linearly located events and linear segments.

Linear Referencing Systems enable the specification of positions along linear objects. The approach is based upon the Generalized Model for Linear Referencing^[3] first standardized within ISO 19133:2005, 6.6. This International Standard extends that which was included in ISO 19133, both in functionality and explanation.

ISO 19109 supports features representing discrete objects with attributes having values which apply to the entire feature. ISO 19123 allows the attribute value to vary, depending upon the location within a feature, but does not support the assignment of attribute values to a single point or length along a linear feature. Linearly located events provide the mechanism for specifying attribution of linear objects when the attribute value varies along the length of a linear feature. A Linear Referencing System is used to specify where along the linear object each attribute value applies. The same mechanism can be used to specify where along a linear object another object is located, such as guardrail or a traffic accident.

It is common practice to segment a linear object having linearly located events, based upon one or more of its attributes. The resultant linear segments are attributed with just the attributes used in the segmentation process, insuring that the linear segments are homogeneous in value for these segmenting attributes.

This International Standard differs from ISO 19133:2005, 6.6 in the following areas.

- a) All occurrences of Linear Reference Method and Linear Reference System have been changed to Linear Referencing Method and Linear Referencing System, respectively.
- b) LR_Element has been renamed LR_LinearElement and further defined as being a feature or geometry or topology. These shall support the newly introduced interface ILinearElement, meaning that it is possible to measure (linearly) along them.
- c) The newly introduced ILinearElement interface includes operations for returning the default Linear Referencing Method of the linear element and any of its length or weight attribute values. It also includes operations for translating between Linear Referencing Methods and/or linear elements.
- d) The types of Linear Referencing Methods have been formalized as a CodeList. Names of common Linear Referencing Methods have been added as an informative annex.
- e) An additional attribute, constraint[0..*], has been added to Linear Referencing Method to specify the constraints imposed by the method, such as “only allows reference marker referents”. This is an alternative to subtyping the methods that would force a too-structured approach, inconsistent with the Generalized Model, and would be indeterminate due to the wide variety of Linear Referencing Methods currently in use.
- f) The Linear Referencing Method “project” operation has been renamed “lrPosition” and moved to the ISpatial interface and a second, opposite, operation “point” has been added. Only LR_Curves realize this interface since their spatial representation is requisite for the two operations, along with the ILinearElement interface.
- g) The LR_PositionExpression measure attribute has been extracted out into a Distance Expression along with the optional referent and offset roles consistent with the original theoretical model. This allows for specifying only an LR_DistanceExpression when the LR_LinearElement and LR_LinearReferencingMethod are already known.
- h) Reference Marker has been generalized to LR_Referent to enable support for other referent types such as intersections, boundaries and landmarks. This type has been formalized as a CodeList.

ISO 19148:2012(E)

- i) A second, optional (towards) Referent has been added in a new (optional) package, Linear Referencing Towards Referent (LRTR), for those Linear Referencing Methods which allow this to disambiguate measurement direction.
- j) Lateral Offsets have been moved to a new (optional) package, Linear Referencing Offset (LRO). Horizontal, vertical, and combined horizontal and vertical offsets are now supported. Offset referent has been generalized to allow for feature instances as well as character strings.
- k) Vector Offsets have been adopted from ISO 19141. They exist in a new (optional) package, Linear Referencing Offset Vector (LROV). An optional offset vector Coordinate Reference System (CRS) can be provided if it is different from the CRS of the linear element.
- l) The theoretical model on which the original standard was built is explained in Annex B.
- m) More descriptive text is added throughout this International Standard to explain the concepts being presented.
- n) Minor changes to some class, attribute and role names have been made.
- o) A new (optional) package, Linearly Located Event (LE) has been added which uses linearly referenced positions to specify where along a linear feature a particular attribute value or other feature instance applies.
- p) A new (optional) package, Linear Segmentation (LS) has been added to support the generation of homogeneous attributed linear segments from linear features with length-varying attribution.
- q) Absolute Linear Referencing Method with non-zero linear element start is now accommodated.
- r) `lateralOffsetReferentType` and `verticalOffsetReferentType` have been changed from CodeLists to Character Strings.

Geographic information — Linear referencing

1 Scope

This International Standard specifies a conceptual schema for locations relative to a one-dimensional object as measurement along (and optionally offset from) that object. It defines a description of the data and operations required to use and support linear referencing.

This International Standard is applicable to transportation, utilities, location-based services and other applications which define locations relative to linear objects.

2 Conformance

2.1 Conformance overview

Clause 6 of this International Standard uses the Unified Modelling Language (UML) to present conceptual schemas for describing the constructs required for Linear Referencing. These schemas define conceptual classes that shall be used in application schemas, profiles and implementation specifications. This International Standard concerns only externally visible interfaces and places no restriction on the underlying implementations other than what is required to satisfy the interface specifications in the actual situation, such as

- interfaces to software services using techniques such as SOAP;
- interfaces to databases using techniques such as SQL;
- data interchange using encoding as defined in ISO 19118.

Few applications require the full range of capabilities described by this conceptual schema. Clause 6, therefore, defines a set of conformance classes that support applications whose requirements range from the minimum necessary to define data structures to full object implementation. This flexibility is controlled by a set of UML types that can be implemented in a variety of manners. Implementations that define full object functionality shall implement all operations defined by the types of the chosen conformance class, as is common for UML designed object implementations. It is not necessary for implementations that choose to depend on external “free functions” for some or all operations, or forgo them altogether, to support all operations, but they shall always support a data type sufficient to record the state of each of the chosen UML types as defined by its member variables. It is acceptable to use common names for concepts that are the same but have technically different implementations. The UML model in this International Standard defines abstract types, application schemas define conceptual classes, various software systems define implementation classes or data structures, and the XML from the encoding standard (ISO 19118) defines entity tags. All of these reference the same information content. There is no difficulty in allowing the use of the same name to represent the same information content even though at a deeper level there are significant technical differences in the digital entities being implemented. This “allows” types defined in the UML model to be used directly in application schemas.

2.2 Conformance classes

2.2.1 General

Conformance to this International Standard shall consist of either data type conformance or both data type and operation conformance.

2.2.2 Data type conformance

Data type conformance includes the usage of data types in application schemas or profiles that instantiate types in this International Standard. In this context, “instantiate” means that there is a correspondence between the types in the appropriate part of this International Standard, and the data types of the application schema or profile in such a way that each standard type can be considered as a supertype of the application schema data type. This means that an application schema or profile data type corresponding to a standard type contains sufficient data to recreate that standard type's information content.

Table 1 assigns conformance tests to each of the packages in Clause 6. Each row in the table represents one conformance class. A specification claiming data type conformance to a package in the first column of the table shall satisfy the requirements specified by the tests given in the remaining columns to the right.

Table 1 — Data type conformance tests

Package	Conformance test					
	A.1.1	A.1.2	A.1.3	A.1.4	A.1.5	A.1.6
Linear Referencing System	X	—	—	—	—	—
Linear Referencing Towards Referent	X	X	—	—	—	—
Linear Referencing Offset	X	—	X	—	—	—
Linear Referencing Offset Vector	X	—	X	X	—	—
Linearly Located Event	X	—	—	—	X	—
Linear Segmentation	X	—	—	—	X	X

2.2.3 Operation conformance

Operation conformance includes both the consistent use of operation interfaces and data type conformance for the parameters, and return values used by those operations. Operation conformance also includes get and set operations for attributes.

Table 2 assigns conformance tests to each of the packages in Clause 6. Each row in the table represents one conformance class. A specification claiming operation conformance to a package in the first column of the table shall satisfy the requirements specified by the tests given in the remaining columns to the right.

Table 2 — Operation conformance tests

Package	Conformance test					
	A.1.1 A.2.1	A.1.2 A.2.2	A.1.3 A.2.3	A.1.4 A.2.4	A.1.5 A.2.5	A.1.6 A.2.6
Linear Referencing System	X	—	—	—	—	—
Linear Referencing Towards Referent	X	X	—	—	—	—
Linear Referencing Offset	X	—	X	—	—	—
Linear Referencing Offset Vector	X	—	X	X	—	—
Linearly Located Event	X	—	—	—	X	—
Linear Segmentation	X	—	—	—	X	X

3 Normative references

The following referenced documents are indispensable for the application of this document. For dated references, only the edition cited applies. For undated references, the latest edition of the referenced document (including any amendments) applies.

ISO/TS 19103, *Geographic information — Conceptual schema language*

ISO 19107, *Geographic information — Spatial schema*

ISO 19108, *Geographic information — Temporal schema*

ISO 19111, *Geographic information — Spatial referencing by coordinates*

4 Terms and definitions

For the purposes of this document, the following terms and definitions apply.

4.1

attribute event

value of an attribute of a **feature** (4.4) that may apply to only part of the feature

NOTE 1 An attribute event includes the **linearly referenced location** (4.16) where the attribute value applies along the **attributed feature** (4.2).

NOTE 2 An attribute event may be qualified by the **instant** (4.8) in which, or **period** (4.20) during which, the attribute value applied.

4.2

attributed feature

feature (4.4) along which an **attribute event** (4.1) applies

4.3

direct position

position (4.21) described by a single set of coordinates within a coordinate reference system

[ISO 19107:2003, 4.26]

4.4

feature

abstraction of real world phenomena

[ISO 19101:2002, 4.11]

4.5

feature event

information about the occurrence of a **located feature** (4.17) along a **locating feature** (4.18)

NOTE 1 A feature event includes the **linearly referenced location** (4.16) of the located feature along the locating feature.

NOTE 2 A feature event may be qualified by the **instant** (4.8) in which, or **period** (4.20) during which, the feature event occurred.

4.6

geometric primitive

geometric object representing a single, connected, homogeneous element of space

[ISO 19107:2003, 4.48]

4.7
height
h, H
distance of a point from a chosen reference surface measured upward along a line perpendicular to that surface

[ISO 19111:2007, 4.29]

NOTE The surface is normally used to model the surface of the Earth.

4.8
instant
0-dimensional **geometric primitive** (4.6) representing **position** (4.21) in time

[ISO 19108:2002, 4.1.17]

NOTE The geometry of time is discussed in ISO 19108:2002, 5.2.

4.9
linear element
1-dimensional object that serves as the axis along which **linear referencing** (4.10) is performed

NOTE Also known as curvilinear element.

EXAMPLES **Feature** (4.4), such as “road”; curve geometry; directed edge topological primitive.

4.10
linear referencing
specification of a **location** (4.19) relative to a **linear element** (4.9) as a measurement along (and optionally offset from) that element

NOTE An alternative to specifying a location as a two- or three- dimensional **spatial position** (4.22).

4.11
Linear Referencing Method
manner in which measurements are made along (and optionally offset from) a **linear element** (4.9)

4.12
Linear Referencing System
set of **Linear Referencing Methods** (4.11) and the policies, records and procedures for implementing them^[1]

4.13
linear segment
part of a linear **feature** (4.4) that is distinguished from the remainder of that feature by a subset of attributes, each having a single value for the entire part

NOTE 1 A linear segment is a one-dimensional object without explicit geometry.

NOTE 2 The implicit geometry of the linear segment can be derived from the geometry of the parent feature.

4.14
linearly located
located using a **Linear Referencing System** (4.12)

4.15
linearly located event
occurrence along a **feature** (4.4) of an attribute value or another feature

NOTE 1 The event **location** (4.19) is specified using **linearly referenced locations** (4.16).

NOTE 2 A linearly located event may be qualified by the **instant** (4.8) in which, or **period** (4.20) during which, the linearly located event occurred.

NOTE 3 ISO 19108 limits events to a single instant in time and does not include the specification of a location.

4.16

linearly referenced location

location whose **position** (4.21) is specified using **linear referencing** (4.10)

4.17

located feature

feature (4.4) that is **linearly located** (4.14) along an associated (locating) feature

EXAMPLE A feature “bridge” may be a located feature along the feature “railway” [a **locating feature** (4.18)].

4.18

locating feature

feature (4.4) that is used to identify the **location** (4.19) of **linearly located** (4.14) features

EXAMPLE A feature “road” may be the locating feature for a feature “pedestrian crossing” [a **located feature** (4.17)].

4.19

location

identifiable geographic place

[ISO 19112 :2003, 4.4]

NOTE A location is represented by one of a set of data types that describe a **position** (4.21), along with metadata about that data, including coordinates (from a coordinate reference system), a measure [from a **Linear Referencing System** (4.12)], or an address (from an address system). [ISO 19133].

4.20

period

one-dimensional **geometric primitive** (4.6) representing extent in time

[ISO 19108:2002, 4.1.27]

NOTE A period is bounded by two different **temporal positions** (4.23).

4.21

position

data type that describes a point or geometry potentially occupied by an object or person

[ISO 19133:2005, 4.18]

NOTE A **direct position** (4.3) is a semantic subtype of position. Direct positions as described can define only a point and, therefore, not all positions can be represented by a direct position. That is consistent with the “is type of” relation. An ISO 19107 geometry is also a position, just not a direct position.

4.22

spatial position

direct position (4.3) that is referenced to a 2- or 3-dimensional coordinate reference system

NOTE An alternative to specifying a **location** (4.19) as a **linearly referenced location** (4.16).

4.23

temporal position

location (4.19) relative to a **temporal reference system** (4.24)

[ISO 19108:2002, 4.1.34]

4.24

temporal reference system

reference system against which time is measured

[ISO 19108:2002, 4.1.35]

4.25

valid time

time when a fact is true in the abstracted reality

[ISO 19108:2002, 4.1.39]

5 Abbreviated terms

CRS Coordinate Reference System

LRM Linear Referencing Method

LRS Linear Referencing System

SOAP Single Object Access Protocol

SQL Structured Query Language

UML Unified Modelling Language

XSP Cross-Sectional Positioning

NOTE The UML notation described in ISO/TS 19103 is used in this International Standard.

6 Linear referencing

6.1 Introduction

6.1.1 Linear referencing concepts

6.1.1.1 General

Linear Referencing Systems are in wide use in transportation but are also appropriate in other areas such as utilities. They allow for the specification of positions along linear elements by using measured distances along (and optionally offset from) the element. This is in contrast to using spatial positions that use two- or three-dimensional coordinates, consistent with a particular Coordinate Reference System (CRS).

Linearly referenced locations are significant for several reasons. First, a significant amount of information is currently held in huge databases from legacy systems that pre-date Geographic Information Systems (GIS). Many useful applications can and have been built on these data with no understanding of where on the earth's surface the data are located. Knowing where they are located relative to a linear element such as a roadway route or pipeline is sufficient to support these applications and can be used as a means of integrating data from multiple, disparate sources.

In some situations, having a linearly referenced location along a known linear element is more advantageous than knowing its spatial position. Consider a crash in need of emergency assistance. Knowing the linear element (Northbound I-95) and the approximate linear location is superior to having a potentially more precise spatial GPS location that is not of significant accuracy to determine whether it is northbound or southbound I-95, especially if an impassable barrier separates the two carriageways.

The linearly referenced location as specified in this International Standard as a position expression, therefore, has many uses. It can be used to tie information about a linear facility to a specific location along that facility. It can also be used to find a position on the face of the earth by specifying how far along the position is (and optionally offset from) on a particular linear element.

This International Standard proposes a consistent specification for describing linearly referenced locations that also enables translation between different referencing methods and/or linear elements. It also specifies how these position expressions can be used to specify how information that pertains to only a part of a linear element can be specified as linearly located events.

A Linear Referencing System is a set of Linear Referencing Methods (LRM) and the policies, records and procedures for implementing them. There are numerous, seemingly disparate, Linear Referencing Methods in use today. There is no single, best method, as each has advantages in certain situations. It is, therefore, unreasonable to propose a single standard Linear Referencing Method. The Generalized Model for Linear Referencing^[3] has been developed which instead categorizes Linear Referencing Methods into a basic set of common concepts. The additional advantage of this approach is that it also enables a singular method for translating linearly referenced locations into locations specified by another method or along an alternative linear element. This translation method is both closed and transitive, insuring round-tripping and translation chaining.

The Generalized Model standardizes the content of a linearly referenced location as containing three components: that which is being measured (linear element), the method of measurement (Linear Referencing Method) and the measured value (distance expression).

6.1.1.2 Linear element

Linear element is the general term which encompasses anything that can be measured using linear referencing. This includes ISO 191 m features, linear geometries and linear topologies.

Features do not have to be linear. A road feature, for example, may have multiple spatial representations to support multiple applications. These can be high-precision linear curves to support civil engineering design, low-resolution straight linestrings to support GIS applications, or areas to support pavement management applications. The only requirement is that it be possible to measure along the feature in a linear, one-dimensional, sense.

Features may represent fundamental entities, like a road element between two intersections, or more complex entities, such as a highway route spanning an entire state or country. Depending on the application schema, the feature can represent the entire road (width-wise) or only one of its carriageways. Therefore, this International Standard uses the word “roadway” intentionally to mean either the full road or a single carriageway.

Linear element features may have no geometry at all. Many existing systems store information about roads by defining roadway characteristics along the roadway, without specifying where the road is physically located. This does preclude the ability to translate spatial positions into linearly referenced locations along the feature. However, it is possible to translate linearly referenced locations to other linear elements or to other Linear Referencing Methods. Using linear referencing instead of its geometry to define roadway characteristics directly against the feature enables the definition of multiple geometries for the feature without having to repeat the roadway characteristics for each spatial representation. It also allows for the definition of roadway characteristics when no geometry exists.

The linear geometry type of linear element includes instances of geometric curves, as these can be measured along and their geometric location is known. It is, therefore, possible to project a spatial position onto the linear geometry and represent its location as a linearly referenced location along the geometry. It is also possible to translate a linearly referenced location along the geometry into two- or three-dimensional space.

Geometric curves are typically represented as attributes of features. Once a spatial position has been projected onto the curve, it is then possible to translate this location into a linearly referenced location on the feature itself.

The linear topology type of linear element includes instances of directed edges. Edges usually do not have a length attribute but do have one or more weights associated with the cost of traversing the edge. Measuring along an edge, therefore, entails *pro rata* distribution based upon the weight value(s). Only a limited number of Linear Referencing Method types can be used for measuring edges.

Linear elements can have attributes. If specified for the linear element, the value of these attributes applies to the entire linear element. Attribute events enable attribute values to apply to part of the linear element (see 6.1.1.5).

6.1.1.3 Linear Referencing Method

How a linear element is measured is specified by the Linear Referencing Method. Example Linear Referencing Methods are included in Annex C. The Linear Referencing Method specifies whether the measurement is absolute, relative, or interpolative. Absolute measurements, such as milepoint, hecto-metre and kilometre-point, are made from the start of the linear element. Relative measurements, such as a milepost, kilopost or reference post, are made from some known location along the linear element, called a referent. Interpolative measurements, such as percentage or normalized, use linear interpolation along the entire length of the linear element.

The Linear Referencing Method specifies if an additional, offset measurement can be made perpendicular to the linear element to specify a location that does not lie directly on the linear element. The offset measurement can be made from the linear element itself or relative from an offset referent, for example, 5 m from the reference line of a road or 5 ft from the back of the curb, respectively.

The Linear Referencing Method specifies the units of measure for measuring along the linear element. This results in the fundamental difference between a milepoint versus a kilometre-point Linear Referencing Method; the first measures in miles, the second in kilometres. If a Linear Referencing Method allows offsets, the Linear Referencing Method also specifies the units of measure for offset measurements.

Because of the wide variety of Linear Referencing Methods currently in use, it is possible to enumerate particular constraints about the method, for example, to allow only reference marker type of referents for a Reference Post Linear Referencing Method. Constraints for commonly used Linear Referencing Methods are suggested in Annex C.

6.1.1.4 Distance Expression

6.1.1.4.1 Distance Along

The measured value which defines the location along the linear element in accordance with the Linear Referencing Method is specified with a distance expression. In its simplest form, this is the “distance along” the linear element for an absolute Linear Referencing Method. It specifies how far along the linear element to measure from the start of the linear element in the direction towards the end of the linear element. The resultant “along” location A is on the linear element, as shown in Figure 1. For example, a distance expression with a “distance along” of 4,0 for a kilometre-point Linear Referencing Method along Route 1 specifies a location on Route 1 that is measured 4,0 kilometres along the route from its start.

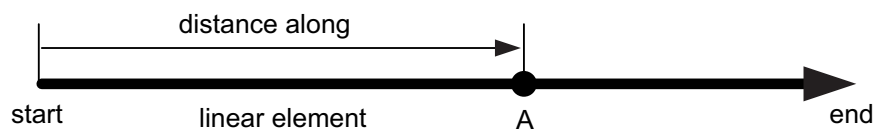

Figure 1 — Linearly referenced along location A with an absolute Linear Referencing Method

It is often the case that the measure at the start of the linear element is not equal to zero for a particular absolute type of Linear Referencing Method. For example, in Figure 2, the linear element start has a kilometre-point value of 0,5 km. An “absolute zero” point is, therefore, introduced to specify where an absolute Linear Referencing Method shall begin measuring distance along values.

In Figure 2, absolute zero occurs 0,5 km prior to the start of the linear element for the specified absolute Linear Referencing Method. A position expression having this Linear Referencing Method of kilometre-point and a distance expression with a distance along value of 4,0 km specifies a location that is measured 4,0 km

along the linear element from absolute zero. The result is an along location A that is 3,5 km from the start of the linear element.

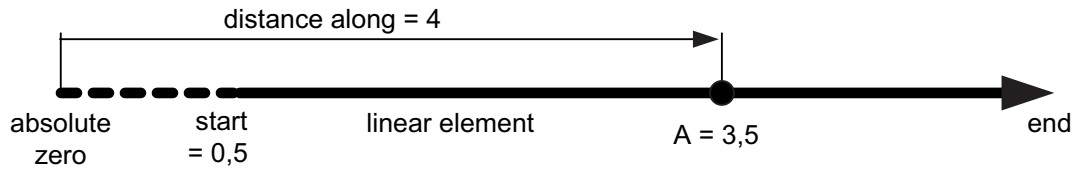

Figure 2 — Absolute Linear Referencing Method with non-zero linear element start

For an interpolative Linear Referencing Method, the distance expression is comprised of a single measure value. Here this value is used with linear interpolation to determine the location along the linear element based on the length (or weight) of the linear element as shown in Figure 3. A distance expression with a measured value of 60 for a percentage Linear Referencing Method along Route 1, which has a length of 50 km, specifies an along location A on Route 1 which is 30 km along the route from its start.

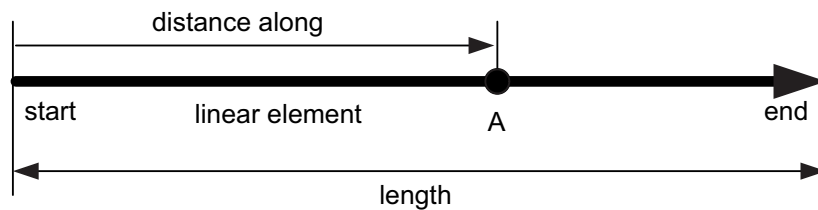

Figure 3 — Linearly referenced along location A with an interpolative Linear Referencing Method

6.1.1.4.2 Referents

For relative Linear Referencing Methods, the “distance along” is measured along the linear element from a known location on the linear element, called a “from referent”, as shown in Figure 4. For example, a distance expression with a “distance along” of 0,5 for a kilometre-post Linear Referencing Method along Route 1 specifies an along location A on Route 1 that is 0,5 km along the route from the specified kilometre-post located at referent location R. If the kilometre-post is located 4,0 km from the start of Route 1, then the resultant location is 4,5 km from the start of the route.

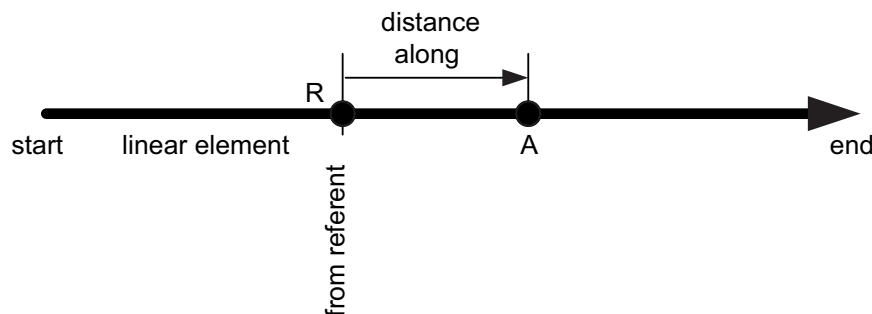

Figure 4 — Linearly referenced along location A with a relative Linear Referencing Method

Referent types vary between Linear Referencing Methods. These include, for example, intersections, administrative and maintenance boundaries, landmarks and physical reference markers.

If the Linear Referencing Method is of type Linear Referencing Method With Towards Referent, a “towards referent” can be added to a distance expression to disambiguate the direction in which the measurement is

made, as shown in Figure 5. Measurements are made in the direction from the “from referent” towards the “towards referent”, regardless of the directional sense of the linear element being measured.

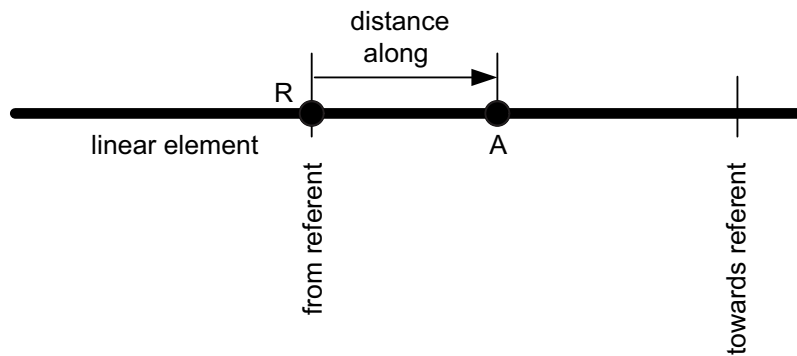

Figure 5 — Linearly referenced along location A with from and towards referents

6.1.1.4.3 Offsets

If the Linear Referencing Method is of type Linear Referencing Method With Offset, the distance expression may include an offset expression to specify locations not directly on the linear element. Each position expression may have either

- a) a lateral offset
 - 1) measured left or right (perpendicular to) the linear element reference line from the distance along point,
 - 2) measured left or right (perpendicular to) a lateral offset referent,
 - 3) measured in a “lateral” direction defined by the LRS from the distance along point,
 - 4) specified by convention;
- b) a vertical offset
 - 1) measured opposite to or in the direction of gravity, above or below the linear element from the distance along point,
 - 2) measured opposite to or in the direction of gravity above or below a vertical offset referent,
 - 3) measured in a “vertical” direction defined by the LRS from the distance along point;
- c) a lateral offset and a vertical offset, measured as stated above;
- d) a vector offset measured along a vector from the linear element; or
- e) no offset at all.

For lateral offsets, the lateral offset distance specifies the distance measured perpendicular to the linear element at the location specified by the “distance along” (point A) to the linearly referenced offset location O, as shown in Figure 6.

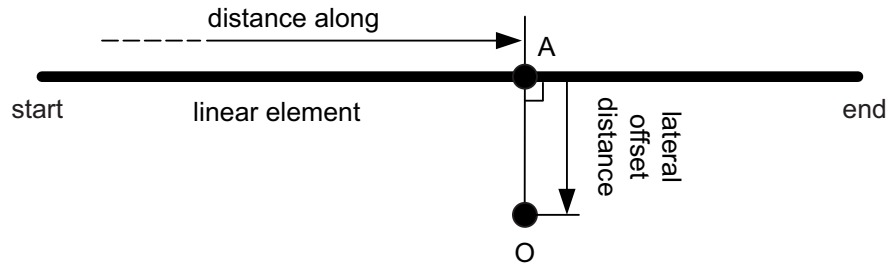

Figure 6 — Linearly referenced offset location O with a lateral offset distance

If a lateral offset referent is also included, then the resultant location is determined as shown in Figure 7. First, an along location A is determined by the distance along the linear element. Then a referent offset location RO is determined by intersecting the lateral offset referent with a normal to the linear element through location A. If A is a vertex of the linear element, then that part of the linear element occurring just prior to A is used to determine the direction of the normal. Finally, the offset location O can be determined by measuring the lateral offset distance along a line that is normal to the lateral offset referent at location RO. If RO is a vertex of the lateral offset referent, then that part of the lateral offset referent occurring just prior to RO is used to determine the direction of the normal. Here, “just prior” assumes that the lateral offset referent is defined in the same relative direction as the linear element.

The lateral offset referent can be the name of an entity in the real world, such as curb, to enable the specification of the location as “5 ft back of curb”. Alternatively, the offset referent can be an instance of a feature, such as a feature representing the curb. If the linear element and feature instance have associated linear geometries, then it is possible to calculate the spatial position of the linearly referenced location.

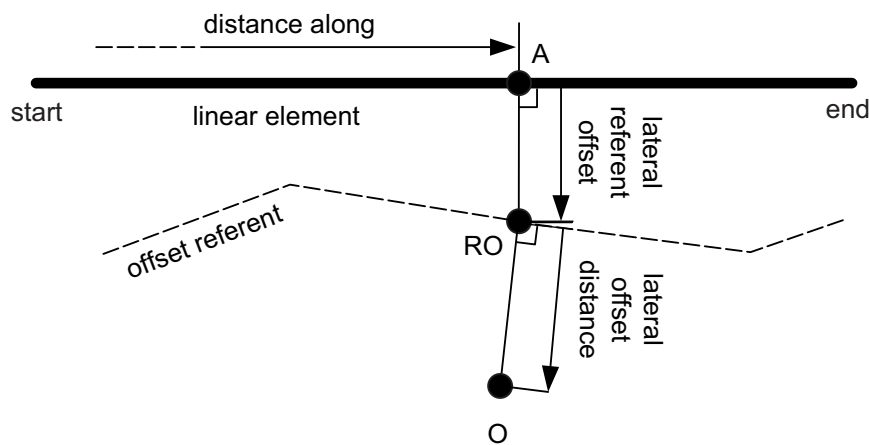

Figure 7 — Linearly referenced offset location O with an offset referent

In some countries, lateral positioning conventions have been established for named partitioning of the roadway cross-section. For example, in the UK and Canada, the cross-sectional positioning (XSP) convention assigns abbreviations and indexes to strips and lines that comprise the roadway cross-section. Strips are roadway cross-section sub-features, like individual lanes, whereas lines represent edges of features, such as the edge of a carriageway.

EXAMPLE Strip -L1 is the right-most left additional nearside lane and line RE is the right (carriageway) edge (see C.5.2).

These positions are accommodated by specifying them as an offset referent.

With a Linear Referencing Method With Offset, a distance expression may have a vertical offset. If no lateral offset is specified, then the resultant linearly referenced location is directly above or below the linear element

at along location A. If a lateral offset is specified, then the resultant linearly referenced location is directly above or below laterally offset location O as shown in Figure 6 or location RO as shown in Figure 7 if a lateral offset referent is included. Vertical offsets are measured in the direction away from (up) or towards (down) the centre of the earth.

If the distance expression contains a vertical offset referent, then the vertical offset distance is measured up or down from that referent. Otherwise, it is measured up or down from the height of along location A on the linear element.

The approach taken with lateral (and vertical) offsets is appropriate for many transportation domains such as road and rail where the linear elements are close to being horizontal. There are, however, some anomalies. Determination of the linearly referenced location of a point from a linear element might not be deterministic, as many such linearly referenced locations are possible. There are also offset points that cannot be linearly located offset from a linear element using lateral offsets. In other domains, such as piping, lateral and vertical offsets might not apply if the linear element is a section of pipe that is itself vertically oriented. For these cases, the Linear Referencing System can include semantic rules for defining “lateral” and “vertical” directions. An alternative approach, vector offsets, is also available.

Figure 8 demonstrates the case where the determination of a linearly referenced location along a linear element is non-deterministic for offset location O. An along location A_1 with a lateral offset distance lod-1 results in the specification of offset location O. However, along location A_2 with a lateral offset distance lod-2 specifies the same offset location O. In order to make the projection operation deterministic, the along location with the lowest absolute distance along measure shall be returned. For the projection of location O onto the linear element, A_1 shall be returned as the resultant location because its absolute distance along the linear element is less than that of A_2 .

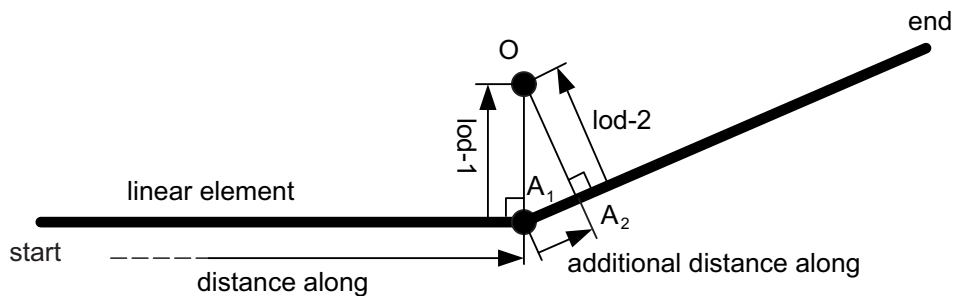

Figure 8 — Non-deterministic offset location

Of greater concern is the unsatisfiable condition shown in Figure 9. Two possible offset locations, O_1 and O_2 , can be reached from the same along location A using equal lateral offset distances lod-1 and lod-2. There is no way of specifying offset locations in the grey region between O_1 and O_2 using a linearly referenced location and the linear element shown. The size of this region is dependent upon the deflection angle of the linear element at A as well as the magnitude of the lateral offset distance. If the discontinuity in the linear element were replaced by a circular arc, this problem would no longer exist, though the deterministic case mentioned above can still result.

To make calculations deterministic, the following assumption shall be made. If the distance along results in a point of discontinuity in the linear element, the offset shall be measured perpendicular to that part of the linear element that is terminated by the point of discontinuity. In Figure 9, location A represents a discontinuity in the linear element shown. A linearly referenced location having a distance along resulting in location A shall, therefore, specify location O_1 for an offset measure of lod-1.

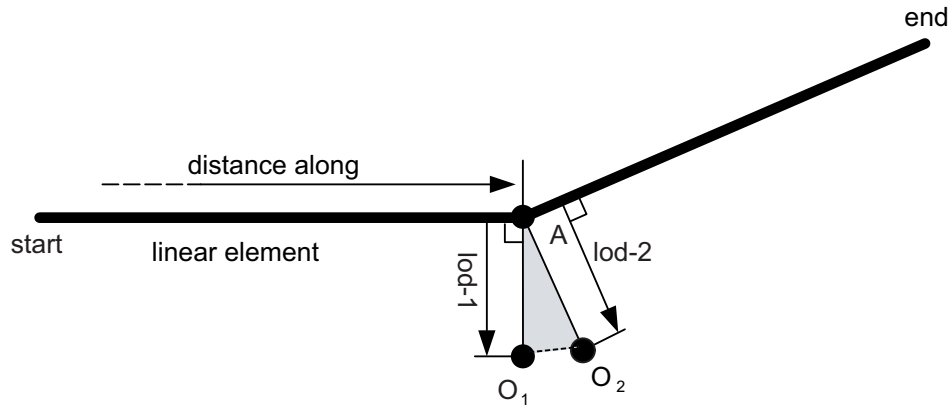

Figure 9 — Unsatisfiable offset location

To accommodate the above unsatisfiable case as well as cases where the linear element is not close to horizontal, vector offsets are appropriate. For vector offsets, the offset distance and bearing from along location A is given by an offset vector as shown in Figure 10. An accompanying CRS is necessary to orient the offset vector. For each vector offset distance expression, a CRS shall be specified or else the CRS of the expression's linear element is used. Offset referents are not supported with vector offsets. Vector offsets cannot be combined with lateral or vertical offsets.

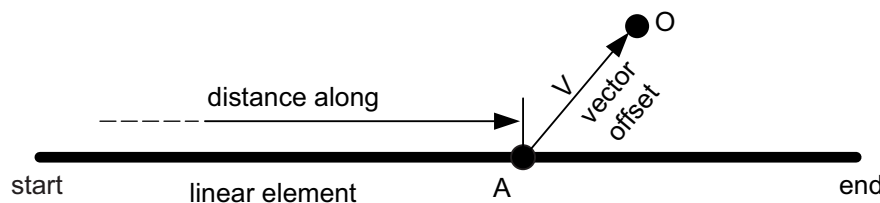

Figure 10 — Linearly referenced offset location O with a vector offset

6.1.1.5 Linearly located events

6.1.1.5.1 Feature and attribute events

A linearly located event is an event that is located using a Linear Referencing System. It may reflect something which happens, like an automobile crash, or something that exists, like a roadway characteristic such as pavement type. Linearly located events are either feature events or attribute events. Feature events allow the location of a (located) feature along another (locating) feature. Attribute events allow the application of an attribute value to only a portion of a linear element, like the asphalt pavement type may apply only to the first half of Route 1, after which it changes to concrete.

Feature events locate a feature that occurs at a spatial extent defined by linearly referenced locations along another feature and possibly further qualified as occurring at an instant in, or during a period of, time. In the first case, they have an event location. Events can be further qualified with an instant or period event time. The occurring feature is referred to as a “located feature” and the other feature along which it is located is referred to as a “locating feature”.

An attribute event is an attribute value of a feature that applies to a limited extent along that feature. The applicable spatial extent is defined by linearly referenced locations along the attributed feature and possibly further qualified as applying at an instant in, or during a period of, time. In the first case, they have an event location. Events can be further qualified with an instant or period event time. The feature is referred to as an “attributed feature”.

The choice between feature and attribute event is similar to the choice between features and attributes. A feature represents something in the real world about which information is kept. Attributes are the bits of information kept about a feature. Features have a unique identifier; attributes do not. Features can have one or more geometries, each of which is an attribute of the feature.

A similar case can be made for feature event versus attribute event. If a feature is linearly located along another feature, it is represented as a feature event of the locating feature. The feature event tells where, and optionally when, along the locating feature that the located feature exists. The located feature is a feature, so it has a unique identifier and can have any number of attributes, including spatial geometry, to indicate where it exists on the face of the earth, independent of the locating feature.

If a feature has an attribute, the value of that attribute applies to the entire feature. If this is not the case, then an attribute event is used instead of a traditional attribute. Like a traditional attribute, an attribute event has a value. But, unlike the traditional attribute, it also has linearly referenced locations to specify where it is along the attributed feature that this particular value applies.

6.1.1.5.2 Event location

Event locations are used to specify where a linearly located feature event occurs or where a linearly located attribute value applies. An event location can be either an “at” location or a “fromTo” location.

If the event occurs at a single point along or offset from the locating feature, an “at” location is specified as the event location. The spatial extent is specified with a single linearly referenced location. If the event occurs throughout a contiguous spatial interval along or offset from the locating feature, a “fromTo” location is specified as the event location. The spatial extent is specified with two linearly referenced locations marking the start and end of the interval. “At” and “from/To” locations are depicted in Figure 11. The location labelled as L_{AT} is the location “at” which the event occurs along the linear element. The locations labelled as L_{FROM} and L_{TO} are the “from” and “to” locations, respectively, along the linear element which bound the spatial interval throughout which the event occurs.

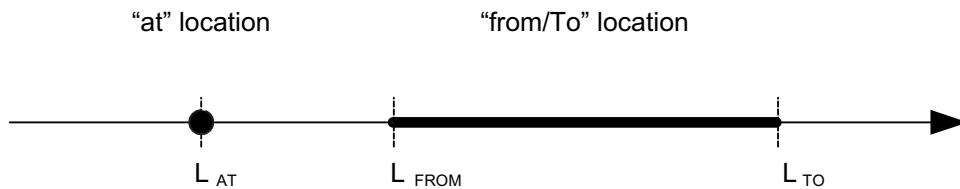

Figure 11 — At and from/To event locations

A single event instance occurs only in a single place. However, this single place may be described by both “at” and “from/To” locations. For example, a single city feature instance may have separate, scale-dependent “at” and “from/To” locations even though these two locations represent the same place.

6.1.1.5.3 Event time

It is also possible to specify the time at or during which an event is relevant^[2]. The instants and periods used to specify the temporal extent are valid times. Instant granularities vary and may be as short as defining a time precise to a fraction of a second or as long as an entire day or more.

Figure 12 shows how event times can be combined with event locations. The location labelled as L_{AT} is the event location, being the location “at” which an event occurs along the linear element. The locations labelled as L_{FROM} and L_{TO} are the “from” and “to” event locations, respectively, along the linear element which bound the spatial interval throughout which an event occurs. The time labelled as T_{AT} is the event time, being the instant “at” which the event occurs along a timeline. The times labelled as T_{FROM} and T_{TO} are the “from” and “to” event times, respectively, along the timeline which bound the time interval during which the event occurs.

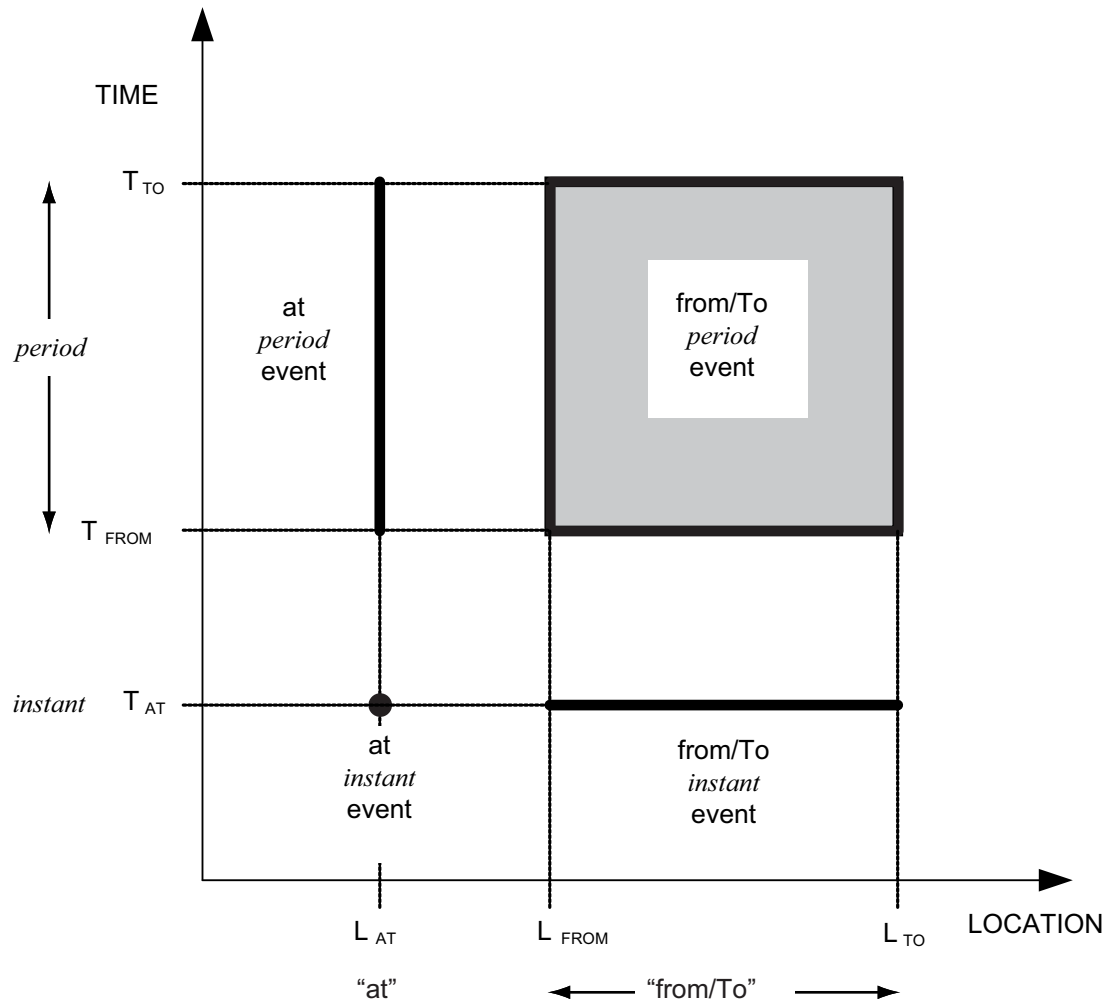

Figure 12 — Events with location and time

Examples of events with location and time are

- at instant event: crash;
- at period event (with offset): traffic sign;
- from/To instant event: street sweeping;
- from/To period event: pavement type.

Organizations may classify their events differently without deviating from this International Standard. The examples given are just possible choices among several possibilities. In a particular application schema, a particular crash can be modelled as a from/To period event to reflect a higher level of location precision. The key consideration is whether the location is specified at a single location or along a continuum delimited by two locations. This is analogous to a city feature having separate, scale-dependent point and polygon geometries.

6.1.1.6 Linear segmentation

Linear elements can have a number of attributes. Some of these have a single value for the entire linear element. Others can change their value as the linear element is traversed. For example, for the linear element representing a road, the pavement type value can change part of the way down the road. Different attributes

can change their value at different locations along the linear element. Some systems have segmented linear elements whenever any attribute value changes. As the number of attributes increases, this can result in numerous very short segments with most of the attribute values being retained for the subsequent segment. An alternative approach is to use attribute events to specify where along a linear element a particular attribute value changes. Then, for a particular display or analysis, the linear segment can be dynamically segmented by only the subset of the attributes that are of interest at the time. This results in linear segments homogeneous in value for all of the segmenting attributes.

A linear segment is a one-dimensional object having no explicit geometry, generated by segmenting a linear feature according to a particular subset of the attribute events along the feature. The resultant linear segments are attributed with the attribute values defined by the events such that every one of the resultant segment attributes has the same value for the entire length of the linear segment. Linear feature attributes not included in the segmentation subset are abstracted away and are not included in the attributes of the generated linear segments (see segmentation example in D.2). Each linear segment corresponds to a part of the parent linear feature, enabling a derivation of the geometry for the linear segment from one of the possible geometries of that feature.

The primary purpose of providing this functionality is to be able to generate segments homogeneous in a particular set of attributes, usually for display or analysis purposes. Because the resultant segments are abstractions of this original segmented linear element (the only attributes retained are those that participated in the segmentation operation), they are intended to persist only long enough to ensure read consistency. It is not advisable to edit segment attribute values directly. Instead, attribute events along the linear element should be edited and then the linear element should be re-segmented.

It is conceivable that an application schema might wish to segment by feature events as well as attribute events. Though this International Standard does not explicitly support such segmentation, it does not preclude it.

6.1.2 Linear referencing packages

This International Standard incorporates the following UML packages:

- (Core) Linear Referencing System (LR);
- Linear Referencing Towards Referent (LRTR);
- Linear Referencing Offset (LRO);
- Linear Referencing Offset Vector (LROV);
- Linearly Located Event (LE);
- Linear Segmentation (LS).

The LR package represents the core functionality of this International Standard and shall be implemented by all conforming implementations. All other packages are optional. Conforming implementations shall state which of these optional packages are supported. If a package is claimed as being supported, it and all of the packages it is dependent upon shall be supported in their entirety. Dependencies between packages are shown in Figure 13.

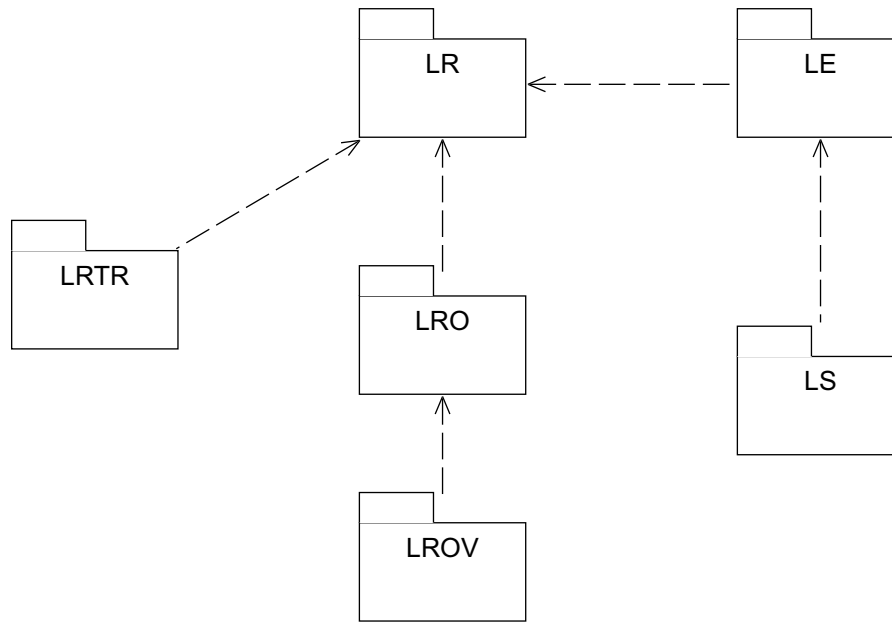

Figure 13 — Linear referencing package dependencies

6.2 Package: Linear Referencing System

6.2.1 Semantics

The core package “Linear Referencing System” supplies classes and types to the definition of Linear Referencing Systems. The UML classes for Linear Reference Systems and their relationships are depicted in Figure 14. An application claiming conformance to this International Standard shall support all of the Linear Referencing System package (LR) classes shown in Figure 14.

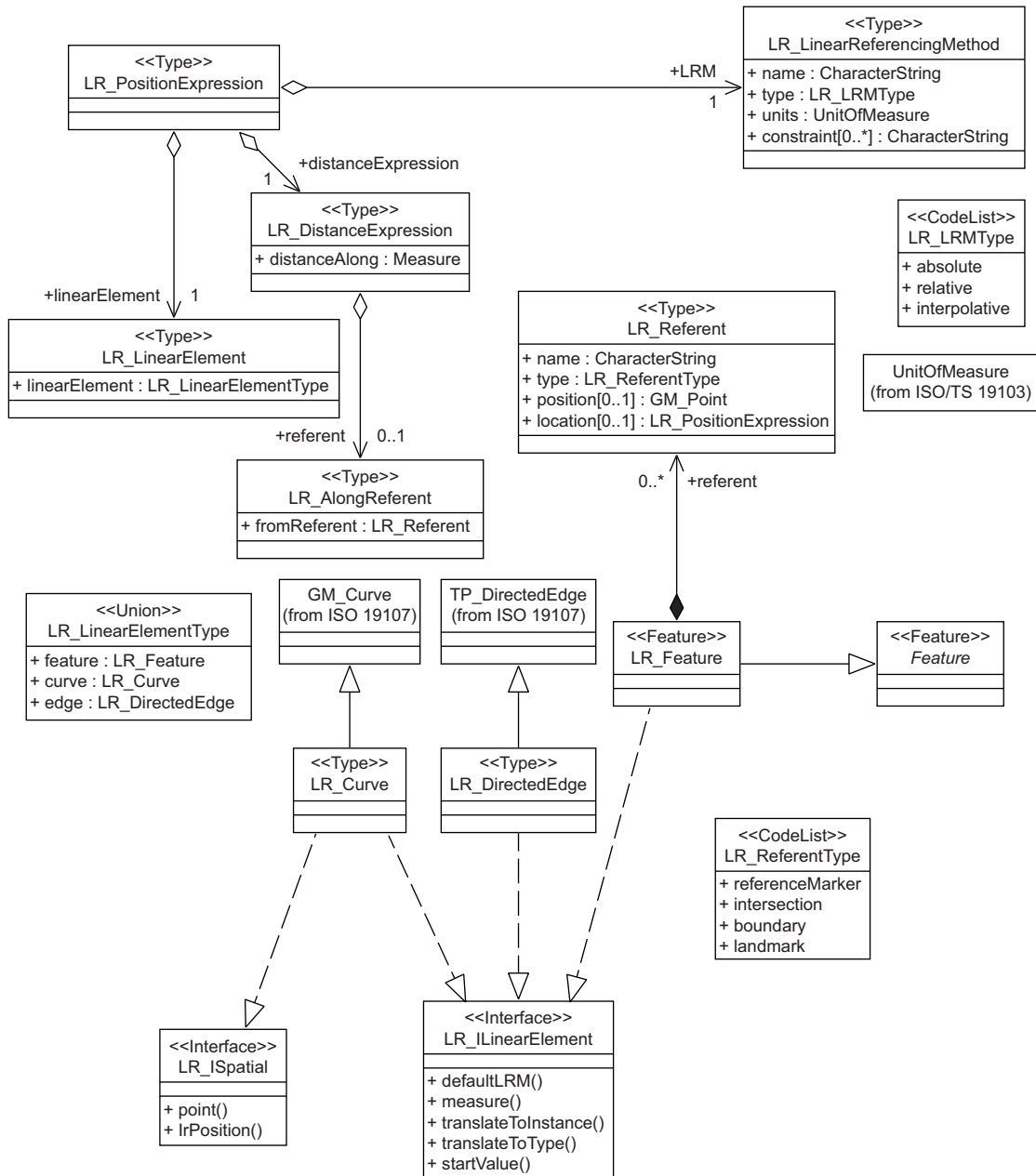

Figure 14 — Linear Referencing System classes

Figure 14 includes all of the classes in the Linear Referencing package. To aid understanding, it is presented incrementally in 6.2.2 – 6.2.15. The reader can also refer to Annex C, which shows which parts of Figure 14 apply to which Linear Referencing Methods in common use today.

6.2.2 LR_PositionExpression

6.2.2.1 Semantics

The type “LR_PositionExpression” is used to fully describe a linearly referenced location given by the linear element being measured, the method of measurement and a measure value specified with a distance expression. The UML for LR_PositionExpression is shown in Figure 15. In situations where the first two values (linear element and measurement method) are known or can be implied, it is sufficient to specify only a distance expression in order to describe the linearly referenced location.

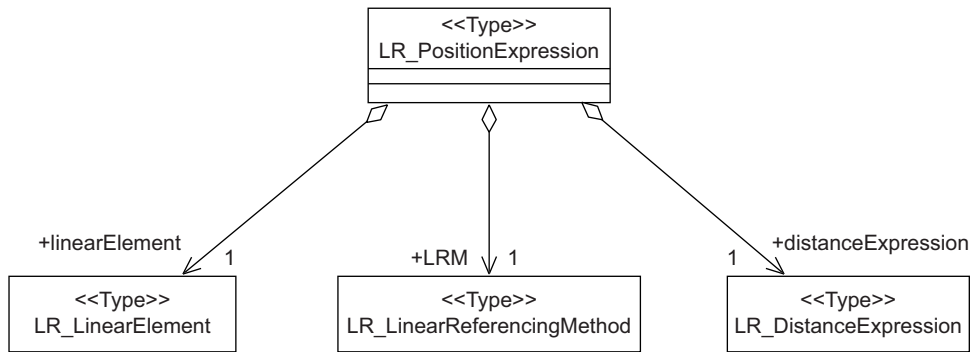

Figure 15 — Context diagram: LR_PositionExpression

6.2.2.2 Role: linearElement : LR_LinearElement

The role “linearElement” specifies the linear object being measured.

```
LR_PositionExpression :: linearElement : LR_LinearElement
```

6.2.2.3 Role: LRM : LR_LinearReferencingMethod

The role “LRM” specifies how the measurement is made.

```
LR_PositionExpression :: LRM : LR_LinearReferencingMethod
```

6.2.2.4 Role: distanceExpression : LR_DistanceExpression

The role “distanceExpression” specifies the measure value.

```
LR_PositionExpression :: distanceExpression : LR_DistanceExpression
```

6.2.3 LR_LinearElement

6.2.3.1 Semantics

The type “LR_LinearElement” specifies the underlying linear element upon which the measures in the Linear Referencing System are made. The UML for LR_LinearElement is shown in Figure 16.

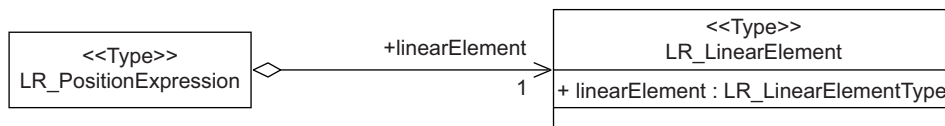

Figure 16 — Context diagram: LR_LinearElement

6.2.3.2 Attribute: linearElement : LR_LinearElementType

The attribute “linearElement” specifies the linear element along which measurements are made.

```
LR_LinearElement :: linearElement : LR_LinearElementType
```

6.2.4 LR_LinearElementType

6.2.4.1 Semantics

The union “LR_LinearElementType” provides a choice for specifying the underlying linear element upon which the measures in the Linear Referencing System are made. The UML for LR_LinearElementType is shown in Figure 17.

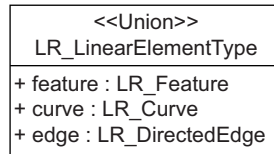

Figure 17 — Context diagram: LR_LinearElementType

The linear element being measured shall be one of the following types

- “feature” – an instance of type LR_Feature which is a Feature that realizes the LR_ILinearElement interface;
- “curve” – an instance of type LR_Curve which is a GM_Curve that realizes the LR_ILinearElement and LR_ISpatial interfaces;
- “edge” – an instance of type LR_DirectedEdge which is a TP_DirectedEdge that realizes the LR_ILinearElement interface.

6.2.5 LR_Feature

6.2.5.1 Semantics

The type “LR_Feature” includes any feature that can be linearly measured, that is, any feature that realizes the LR_ILinearElement interface. The abstract *Feature* class from which LR_Feature is subtyped is the root class for all features. An application schema is not required to have an explicit LR_Feature subtype. Instead, it can create LR_Feature instances by adding the LR_ILinearElement interface to existing application-specific feature classes, such as Road. The UML for LR_Feature is shown in Figure 18.

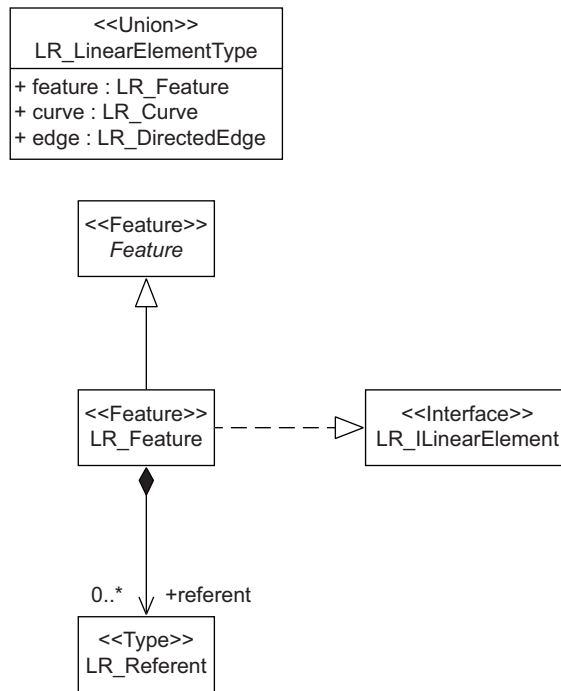

Figure 18 — Context diagram: LR_Feature

6.2.5.2 Role: referent[0..*] : LR_Referent

The optional association role “referent” aggregates the referents along this feature and considers them to be owned by the feature.

```
LR_Feature :: referent[0..*] : LR_Referent
```

6.2.6 LR_Curve

The type “LR_Curve” shall include any one-dimensional geometry of type GM_Curve as specified in ISO 19107, that can be linearly measured, that is, that realizes the LR_ILinearElement interface. The LR_Curve also realizes the ISpatial interface. This allows spatial positions to be projected onto the LR_Curve to determine a corresponding linearly referenced location along the curve and vice versa. The UML for LR_Curve is shown in Figure 19.

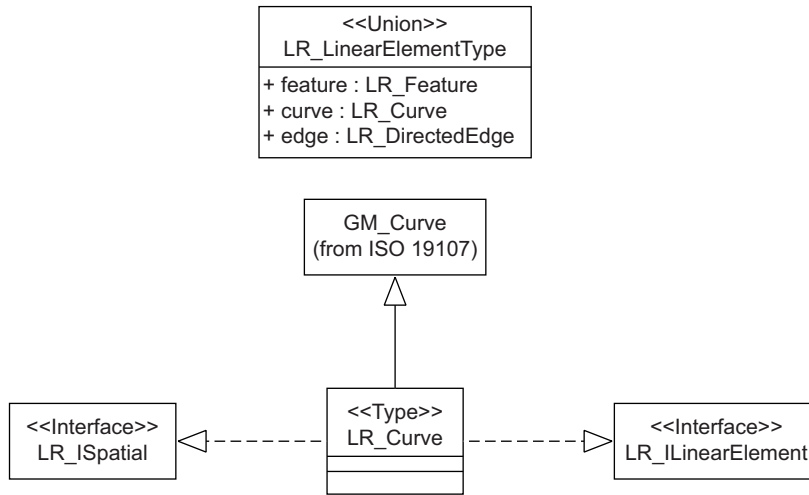

Figure 19 — Context diagram: LR_Curve

6.2.7 LR_DirectedEdge

The type “LR_DirectedEdge” includes any one-dimensional topology of type TP_DirectedEdge from ISO 19107 that can be linearly measured, that is, that realizes the LR_ILinearElement interface. Directed edges typically have one or more weights associated with them instead of having a length. Measuring along a directed edge, therefore, entails prorating a weight value. Consequently, the Linear Referencing Method of choice is typically of the interpolative type and unlikely to be of the relative type. The UML for LR_DirectedEdge is shown in Figure 20.

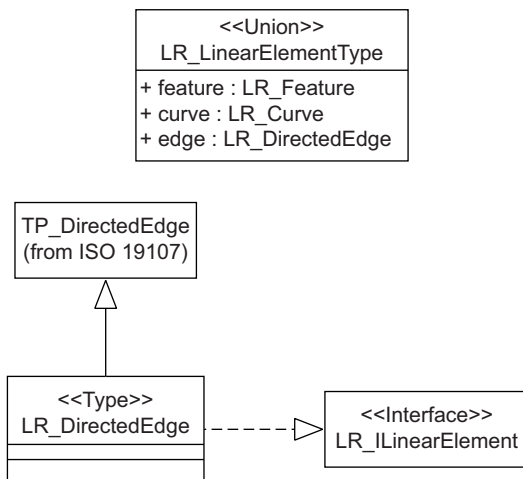

Figure 20 — Context diagram: LR_DirectedEdge

6.2.8 LR_ILinearElement

6.2.8.1 Semantics

The interface “LR_ILinearElement” is realized by all LR_LinearElements. It includes operations that return

- a) the default Linear Referencing Method of the LR_LinearElement;
- b) one of the measures (length or weight) of the LR_LinearElement;
- c) a distance expression that represents the translation of a linearly referenced location on this LR_LinearElement onto a specified target element using a specified Linear Referencing Method;
- d) one or more position expressions that represent the translation of a linearly referenced location on this LR_LinearElement onto the appropriate element instances of the specified target type, using a specified Linear Referencing Method;
- e) the measure value at the beginning of the linear element for the specified Linear Referencing Method.

The UML for LR_ILinearElement is shown in Figure 21.

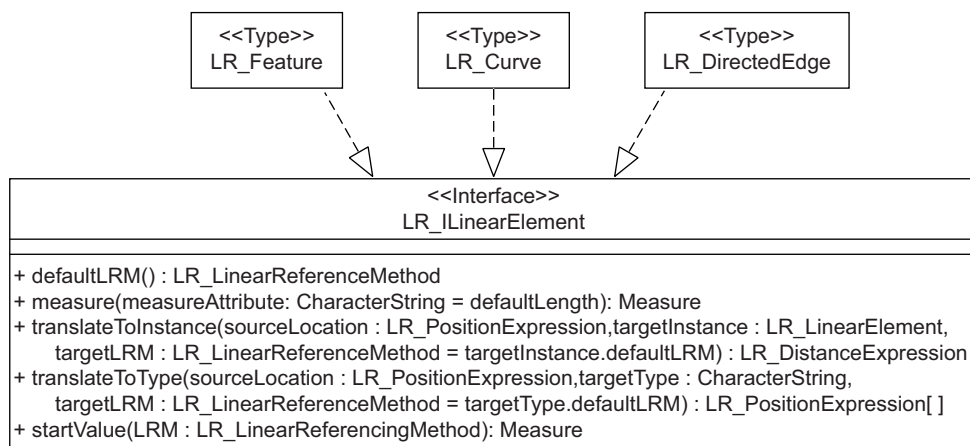

Figure 21 — Context diagram: LR_ILinearElement

6.2.8.2 Operation: defaultLRM

The operation “defaultLRM” returns the default Linear Referencing Method of the LR_Feature, LR_Curve, or LR_DirectedEdge type of LR_LinearElement. This is used for all measurements made along the LR_LinearElement unless specified otherwise in an LR_PositionExpression or otherwise explicitly overridden.

```

LR_ILinearElement ::
    defaultLRM() : LR_LinearReferencingMethod
  
```

6.2.8.3 Operation: measure

The operation “measure” returns the value of one of the measure attributes of the LR_Feature, LR_Curve, or LR_DirectedEdge type of LR_LinearElement. This is usually one of its length attributes or, in the case of “LRDirectedEdge”, one of its weight attributes. The default attribute name is “defaultLength”.

```

LR_ILinearElement ::
    measure(measureAttribute : CharacterString = defaultLength) : Measure
  
```

6.2.8.4 Operation: translateToInstance

The operation “translateToInstance” translates an LR_PositionExpression defined along the subject (source) LR_Feature, LR_Curve, or LR_DirectedEdge type of LR_LinearElement into an LR_DistanceExpression measured along a known, specified target LR_LinearElement using the target Linear Referencing Method. The target Linear Referencing Method defaults to the defaultLRM of the target instance, unless explicitly overridden with the “targetLRM” input parameter.

```
LR_ILinearElement ::
    translateToInstance(sourceLocation : LR_PositionExpression,
        targetInstance : LR_LinearElement, targetLRM :
        LR_LinearReferencingMethod = targetInstance.defaultLRM) :
        LR_DistanceExpression
```

6.2.8.5 Operation: translateToType

The operation “translateToType” translates an LR_PositionExpression defined along the subject (source) LR_Feature, LR_Curve, or LR_DirectedEdge type of LR_LinearElement into one or more LR_PositionExpressions measured along the appropriate instances of the element type specified, using the target Linear Referencing Method. The returned LR_PositionExpressions include the appropriate element instances as well as the resulting LR_DistanceExpressions. The target Linear Referencing Method defaults to the defaultLRM of the target type, unless explicitly overridden with the “targetLRM” input parameter. This operation is used instead of “translateToInstance” when the source has been mapped to a list of contiguous target instances and it is not known *a priori* on which instances the position will fall upon.

```
LR_ILinearElement ::
    translateToType(sourceLocation : LR_PositionExpression, targetType :
        CharacterString, targetLRM : LR_LinearReferencingMethod =
        targetType.defaultLRM) : LR_PositionExpression[]
```

6.2.8.6 Operation: startValue

The operation “startValue” returns the measure value at the start of the LR_Feature, LR_Curve, or LR_DirectedEdge type of LR_LinearElement for the specified Linear Referencing Method. This is usually 0 (zero).

```
LR_ILinearElement ::
    startValue(LRM : LinearReferencingMethod) : Measure
```

6.2.9 LR_ISpatial

6.2.9.1 Semantics

The interface “LR_ISpatial” is realized directly by spatial representations (LR_Curve) that also realize the ILinearElement interface. The ISpatial interface includes operations that return

- a) a spatial position of type GM_Point spatially equal to the specified linearly referenced location along the subject curve;
- b) an LR_DistanceExpression that specifies the linearly referenced location along the subject curve using the curve's default Linear Referencing Method and that is spatially equal to the specified spatial position.

The UML for LR_ISpatial is shown in Figure 22.

ISpatial is not realized by all LR_Features as they can have no or many spatial representations. In order to convert a spatial position into a linearly referenced location along an LR_Feature, it is necessary that the spatial position first be projected onto one of the LR_Curve geometries associated with the feature and then

the resultant LR_PositionExpression on the LR_Curve can be translated into an LR_PositionExpression on the feature.

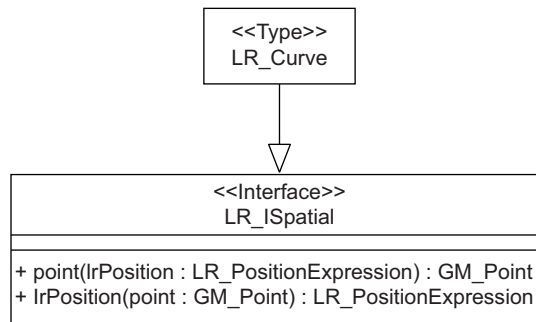

Figure 22 — Context diagram: LR_ISpatial

6.2.9.2 Operation: point

The operation “point” returns a GM_Point representing the spatial position spatially equal to a linearly referenced position specified by an LR_PositionExpression. The operation is called on the LR_Curve contained in the LR_PositionExpression.

```

LR_ISpatial ::
    point(lrPosition : LR_PositionExpression) : GM_Point
  
```

6.2.9.3 Operation: lrPosition

The operation “lrPosition” determines the measure of a point on the element of type LR_Curve closest to the given point using the default Linear Referencing Method of the LR_Curve. The returned position expression contains the LR_Curve instance, its defaultLRM and the resultant measure value. If the point is precisely on the LR_Curve instance, the returned position expression's distance expression will have no offset expression. If the point is equidistant to more than one LR_Curve location, the one closest to the start of the LR_Curve is selected.

```

LR_ISpatial ::
    lrPosition(point : GM_Point) : LR_PositionExpression
  
```

6.2.10 LR_LinearReferencingMethod

6.2.10.1 Semantics

The type “LR_LinearReferencingMethod” describes the manner in which measurements are made along (and optionally offset from) a linear element. Commonly used Linear Referencing Methods are described in Annex C. The UML for LR_LinearReferencingMethod is shown in Figure 23.

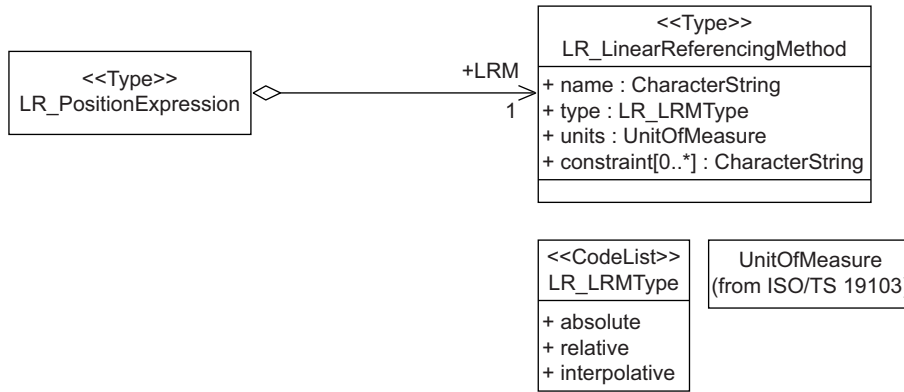

Figure 23 — Context diagram: LR_LinearReferencingMethod

6.2.10.2 Attribute: name : CharacterString

The attribute “name” gives the name of this Linear Referencing Method, such as “kilometre-point”. Names of commonly used Linear Referencing Methods are included in Annex C, along with recognized name aliases.

```
LR_LinearReferencingMethod :: name : CharacterString
```

6.2.10.3 Attribute: type : LR_LRMTType

The attribute “type” gives the type of this Linear Referencing Method.

```
LR_LinearReferencingMethod :: type : LR_LRMTType
```

6.2.10.4 Attribute: units : UnitOfMeasure

The attribute “units” specifies the units of measure used by this Linear Referencing Method for measures along the linear element being measured. The type UnitOfMeasure used shall be as described in ISO/TS 19103.

```
LR_LinearReferencingMethod :: units : UnitOfMeasure
```

6.2.10.5 Attribute: constraint[0..*] : CharacterString

The optional attribute “constraint” allows for the specification of constraints imposed by this Linear Referencing Method. For example, a Reference Post Linear Referencing Method may specify that referents be of type “reference marker”.

```
LR_LinearReferencingMethod ::
    constraint[0..*] : CharacterString
```

6.2.11 LR_LRMTType

The enumeration “LR_LRMTType” specifies the allowable types for the Linear Referencing Method. These include

- a) “absolute” – (e.g. milepoint, kilometre-point in Annex C) measurements are made from the start of the linear element being measured, in the direction of the linear element;
- 1) “relative” – (e.g. kilometre-post, milepost, reference post, county milepoint in Annex C) measurements are made from the specified “from referent” location, in the direction of the linear element unless overridden by a towards referent, in which case the direction is from the from referent towards the towards referent;
- b) “interpolative” – (e.g. percentage, normalized in Annex C) measurements are interpolated in accordance with the default length of the linear element.

The UML for LR_LRMTType is shown in Figure 24.

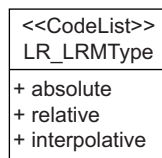

Figure 24 — Context diagram: LR_LRMTType

6.2.12 LR_DistanceExpression

6.2.12.1 Semantics

The type LR_DistanceExpression specifies the linear referenced measure value. This shall include the distance measured along the linear element. If the Linear Referencing Method LR_LRMTType is “relative”, the distance expression may also include an along referent to specify where the measuring begins. Otherwise, measuring begins at the start of the linear element. Measuring is in the direction of the linear element, unless a towards referent is provided (see 6.3). The UML for LR_DistanceExpression is shown in Figure 25.

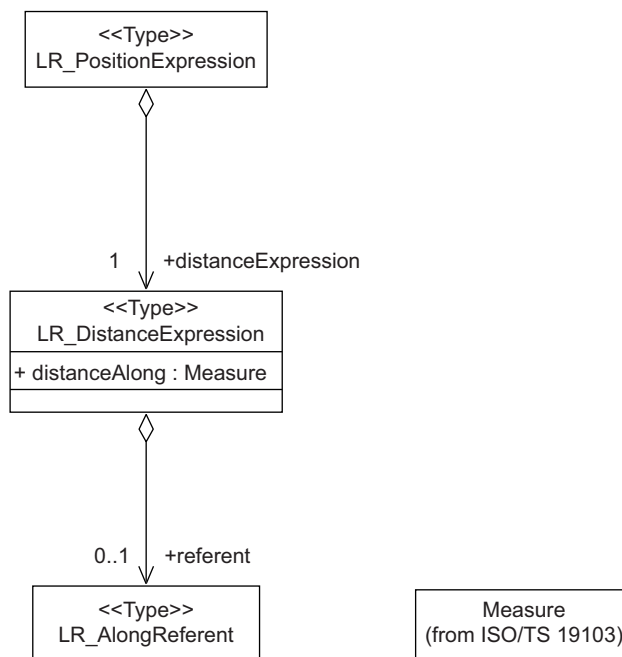

Figure 25 — Context diagram: LR_DistanceExpression

6.2.12.2 Attribute: distanceAlong : Measure

The attribute “distanceAlong” gives a measure (usually a distance) of this distance expression. If the Linear Referencing Method is of type “absolute”, the distance is measured from the start of the linear element. If “relative”, it is measured from the along referent’s “from referent”. If “interpolative”, it is based on the default length or weight of the linear element. The type Measure used shall be as described in ISO/TS 19103.

```
LR_DistanceExpression :: distanceAlong: Measure
```

6.2.12.3 Role: referent[0..1] : LR_AlongReferent

The optional association role “referent” gives the referent associated with the “distance along” of this distance expression. A referent is appropriate only if the type of the Linear Referencing Method is “relative”. If the referent is absent, then the position is measured from the start of the element.

```
LR_DistanceExpression :: referent[0..1] : LR_AlongReferent
```

6.2.13 LR_AlongReferent

6.2.13.1 Semantics

For “relative” type Linear Referencing Methods, the type “LR_AlongReferent” is used to specify the location along the LR_LinearElement at which to begin the measuring. The UML for LR_AlongReferent is shown in Figure 26.

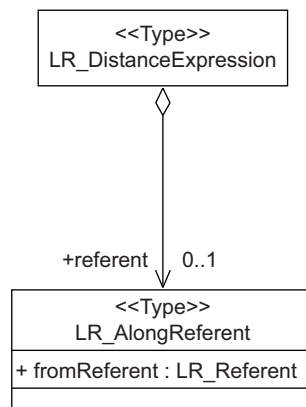

Figure 26 — Context diagram: LR_AlongReferent

6.2.13.2 Attribute: fromReferent : LR_Referent

The attribute “fromReferent” specifies where along the LR_LinearElement measuring begins for this distance expression when the Linear Referencing Method is of type “relative”.

```
LR_AlongReferent :: fromReferent : LR_Referent
```

6.2.14 LR_Referent

6.2.14.1 Semantics

For from and towards referents, the type “LR_Referent” is used to specify a known location along the LR_LinearElement. This can be a reference marker, an intersection, a jurisdictional boundary, or a landmark. At least one of the attributes “position” or “location” is usually specified, unless it can be implied. If both are given they shall refer to the same physical location.

Referents are owned by a single feature. For example, the reference markers along Interstate 95 are owned by the feature that represents Interstate 95. The referent representing the intersection with First Avenue along Washington Street is owned by Washington Street if it is used to specify relative linearly referenced locations along Washington Street. The location of this referent is most likely specified with a position expression along Washington Street. A different referent can represent the intersection with Washington Street along First Avenue. This referent is owned by First Avenue and is used to specify relative linearly referenced locations along First Avenue.

It is not necessary that the LR_Feature instance that owns an LR_Referent instance be the same LR_Feature instance that is the linear element for the LR_PositionExpression containing that LR_Referent instance. For example, if US Interstate Highway 95 is coincident with US Federal Route 1, it is possible to specify locations along Route 1 (the linear element in the position expression) using referents owned by Interstate 95 (reference post 18). In this case, the location of the referent itself most likely would have been made along Interstate 95 as the linear element since the referent is owned by Interstate 95.

The UML for LR_Referent is shown in Figure 27.

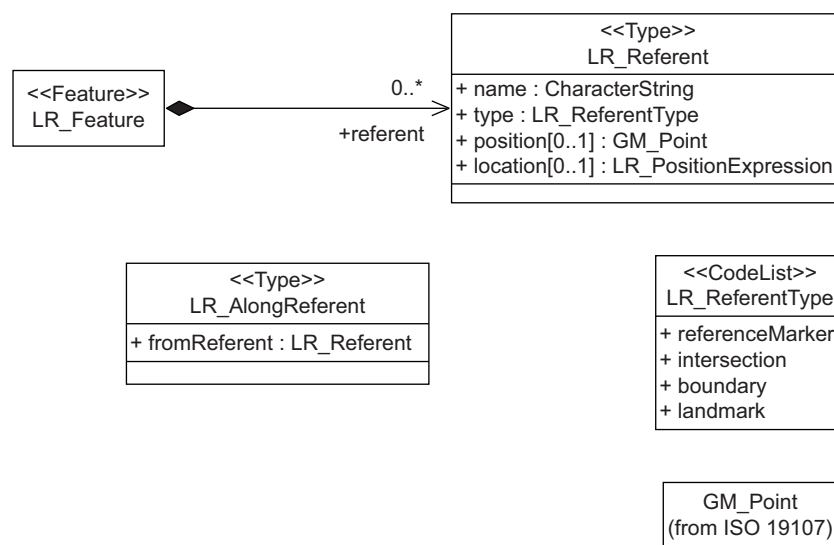

Figure 27 — Context diagram: LR_Referent

Referents of type reference marker are typically ordered. The ordering of reference markers is consistent with the order in which the reference markers are found in traversing the LR_Feature from beginning to end (i.e. in increasing order of distance from the first reference marker at the beginning of the feature). This can be achieved by specifying the LR_Referent location with a relative Linear Referencing Method, such that each marker (other than the first) is located a distance from the previous one.

6.2.14.2 Attribute: name : CharacterString

The attribute “name” is the identifier used for this referent.

```
LR_Referent :: name : CharacterString
```

6.2.14.3 Attribute: type : LR_ReferentType

The attribute “type” is the type of this referent.

```
LR_Referent :: type : LR_ReferentType
```

6.2.14.4 Attribute: position[0..1] : GM_Point

The optional attribute “position” is the spatial position of this referent, given in some coordinate system. The type GM_Point used shall be as described in ISO 19107.

```
LR_Referent :: position[0..1] : GM_Point
```

6.2.14.5 Attribute: location[0..1] : LR_PositionExpression

The optional attribute “location” is the location of this referent given as a linearly referenced location along the feature that owns the referent. The Linear Referencing Method contained within the position expression specifies how this measurement is made: it can be absolute from the start of the element, relative from the previous (or other) referent, or interpolative. It is not necessary that the Linear Referencing Method of the referent location be the same as the Linear Referencing Method of the position expression containing the distance expression that uses this referent. There shall be no offset expression; all referents shall lie on the linear feature.

```
LR_Referent :: location[0..1] : LR_PositionExpression
```

6.2.15 LR_ReferentType

6.2.15.1 Semantics

The type “LR_ReferentType” is used to describe the type of referent. Possible values include the following.

- a) referenceMarker: The referent is a reference marker typically located in the right of way of the road, rail or other transportation system. Usually reference markers are initially spaced at a uniform distance along the linear element being measured, though subsequent re-alignments can result in uneven spacing between the markers. Specifying their location with a relative Linear Referencing Method a distance from the preceding marker minimizes the impact of such changes.
- b) intersection: The referent is the location of an intersection specified by the referent name. The intersection location is typically taken as the location of the intersection of the reference lines of the streets comprising the intersection and is, therefore, not necessarily precise or deterministic. Physical markers may be installed to remedy this. The Linear Referencing System should include specific rules about how intersection locations are determined if this type of referent is permitted.
- c) boundary: The referent represents where an administrative or maintenance boundary crosses the linear element being measured. This is typically the first time the boundary crosses the linear element. If the boundary runs along the linear element, it would be the point at which they first become collinear. The Linear Referencing System should include specific rules about how boundaries are handled if this type of referent is permitted. If the linear element changes at the boundary as for a county route beginning at the county boundary, then the Linear Referencing method is more correctly categorized as absolute.
- d) landmark: The referent is the location of a physical landmark visible in the field.

Allowable types are typically dependent upon the Linear Referencing Method. The UML for LR_ReferentType is shown in Figure 28.

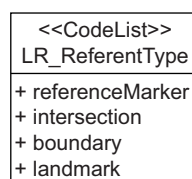

Figure 28 — Context diagram: LR_ReferentType

6.3 Package: Linear Referencing Towards Referent

6.3.1 Semantics

The package “Linear Referencing Towards Referent” supplies classes and types to the definition of “towards referents” for those Linear Referencing Methods that prescribe both “from referents” and “towards referents”. When a “towards referent” is part of a position expression, the distance expression “distance along” value is measured along the linear element, beginning at the location specified by the “from referent” in the direction towards the “towards referent”. The UML for Linear Referencing Towards Referent classes is shown in Figure 29. An application claiming conformance to this Linear Referencing Towards Referent package shall support all of the LRTR classes shown in Figure 29 and all of the LR classes shown in Figure 14 for the Linear Referencing System package on which this package is dependent.

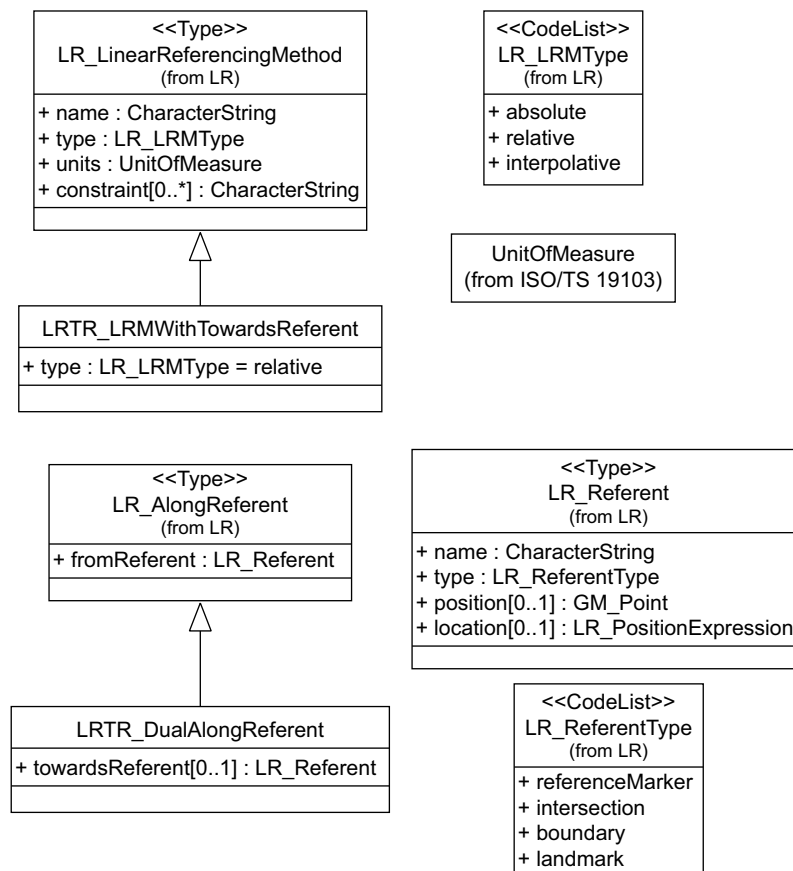

Figure 29 — Linear Referencing Towards Referent classes

6.3.2 LRTR_LRMWithTowardsReferent

6.3.2.1 Semantics

The type “LRTR_LRMWithTowardsReferent” extends LR_LinearReferencingMethod by adding a subtype of Linear Referencing Method that allows towards referents, such as the Cross Street Linear Referencing Method. The UML for LRTR_LRMWithTowardsReferent is shown in Figure 30.

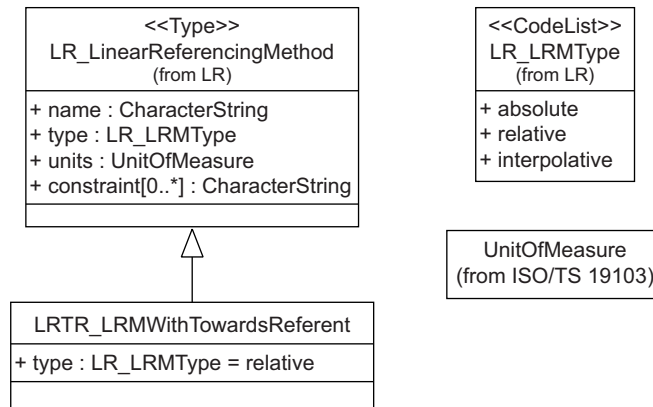

Figure 30 — Context diagram: LRTR_LRMWithTowardsReferent

6.3.2.2 Attribute: type : LR_LRMTType

The attribute “type” gives the type of this Linear Referencing Method. Since it supports towards referents, its type shall be “relative”.

```
LRTR_LRMWithTowardsReferent :: type : LR_LRMTType = relative
```

6.3.3 LRTR_DualAlongReferent

6.3.3.1 Semantics

The type “LRTR_DualAlongReferent” extends LR_AlongReferent by adding an optional towards referent. The UML for LRTR_DualAlongReferent is shown in Figure 31.

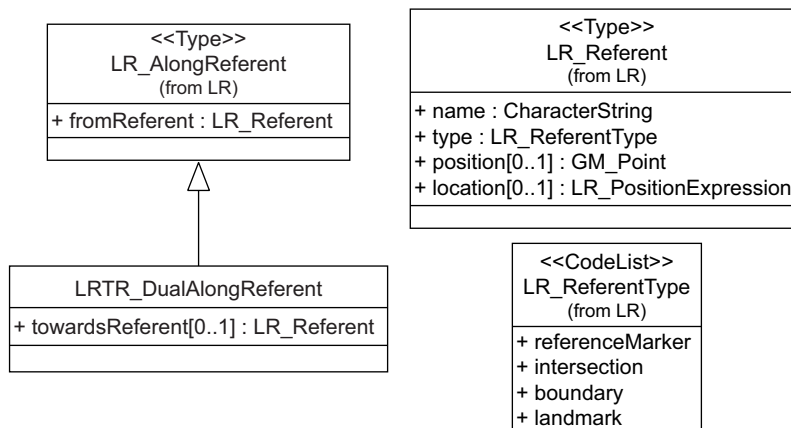

Figure 31 — Context diagram: LRTR_DualAlongReferent

6.3.3.2 Attribute: towardsReferent[0..1] : LR_Referent

The optional attribute “towardsReferent” specifies a second location along the LR_LinearElement to help disambiguate the direction in which the measurement is made for this distance expression. This overrides the directional sense of the LR_LinearElement, and can influence the offset direction if an offset is included. Towards referents are appropriate only if the Linear Referencing Method is of type LRTR_LRMWithTowardsReferent.

```
LRTR_DualAlongReferent :: towardsReferent[0..1] : LR_Referent
```

6.4 Package: Linear Referencing Offset

6.4.1 Semantics

The package “Linear Referencing Offset” supplies classes and types to the definition of lateral offsets. Lateral offsets extend the definition of a position expression to accommodate locations that do not lie directly on the linear element, but instead are located some distance horizontally or vertically (or both) from the linear element. The horizontal and vertical distances are measured along a perpendicular from the linear element or from an offset referent. The UML for Linear Referencing Offset classes is shown in Figure 32. An application claiming conformance to this Linear Referencing Offset package shall support all of the LRO classes shown in Figure 32 and all of the LR classes shown in Figure 14 for the Linear Referencing System package on which this package is dependent.

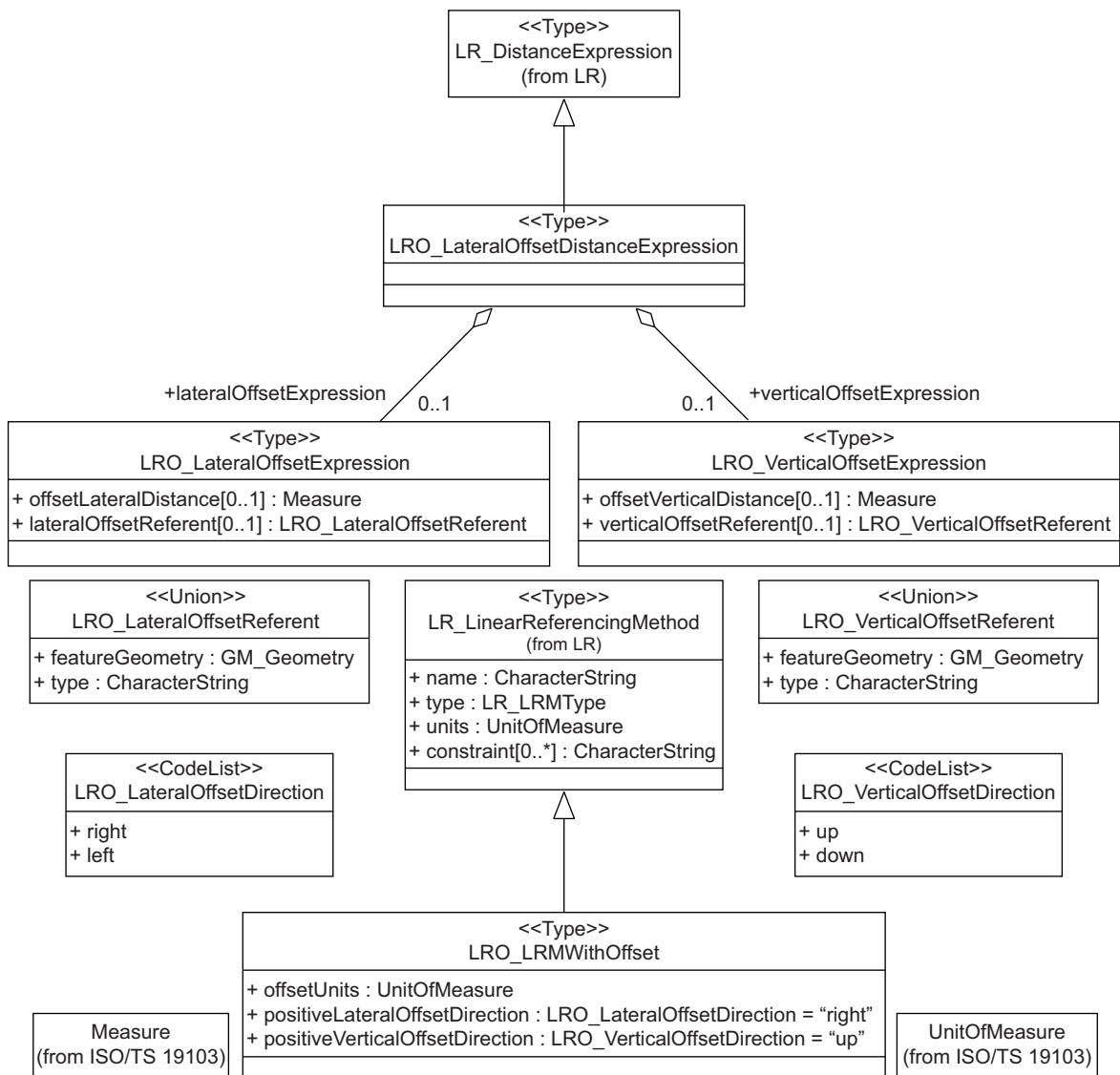

Figure 32 — Linear Referencing Offset classes

6.4.2 LRO_LRMWithOffset

6.4.2.1 Semantics

The type “LRO_LRMWithOffset” extends LR_LinearReferencingMethod by adding attributes relevant to Linear Referencing Methods that allow offsets. These include units of measure and positive directions for perpendicular lateral and vertical offsets. The UML for LRO_LRMWithOffset is shown in Figure 33.

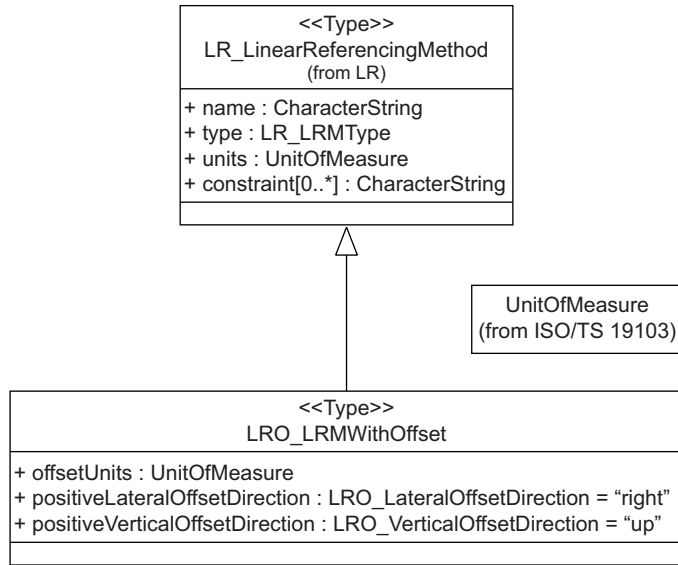

Figure 33 — Context diagram: LRO_LRMWithOffset

6.4.2.2 Attribute: offsetUnits : UnitOfMeasure

The attribute “offsetUnits” gives the units of measure used by this Linear Referencing Method for offset distances. The type UnitOfMeasure used shall be as described in ISO/TS 19103.

```
LRO_LRMWithOffset :: offsetUnits : UnitOfMeasure
```

6.4.2.3 Attribute: positiveLateralOffsetDirection : LRO_LateralOffsetDirection = “right”

The attribute “positiveLateralOffsetDirection” gives the direction used as positive for this Linear Reference Method for lateral measures perpendicular to the base element. The default value is right for positive, left for negative.

```
LRO_LRMWithOffset :: positiveLateralOffsetDirection :
    LRO_LateralOffsetDirection = "right"
```

6.4.2.4 Attribute: positiveVerticalOffsetDirection : LRO_VerticalOffsetDirection = “up”

The attribute “positiveVerticalOffsetDirection” gives the direction used as positive for this Linear Reference Method for vertical measures perpendicular to the base element. The default value is up for positive, down for negative.

```
LRO_LRMWithOffset :: positiveVerticalOffsetDirection :
    LRO_VerticalOffsetDirection = "up"
```

6.4.3 LRO_LateralOffsetDirection

The enumeration “LRO_LateralOffsetDirection” gives the options for positive lateral offset direction. The values are left and right. This lateral offset direction is as viewed from above the linear element facing in the direction of increasing measure. If “from” and “towards referents” have been specified, then the offset direction is as viewed from above the “from referent” facing in the direction of the “towards referent”. The UML for LRO_LateralOffsetDirection is shown in Figure 34.

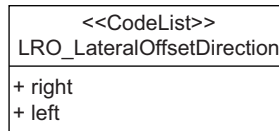

Figure 34 — Context diagram: LRO_LateralOffsetDirection

6.4.4 LRO_VerticalOffsetDirection

The enumeration “LRO_VerticalOffsetDirection” gives the options for positive vertical offset direction. The values are up and down. This vertical offset direction is as viewed from along the linear element facing in the direction of increasing measure. If “from” and “towards referents” have been specified, then the offset direction is as viewed from the “from referent” facing in the direction of the “towards referent”. The UML for LRO_VerticalOffsetDirection is shown in Figure 35.

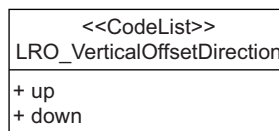

Figure 35 — Context diagram: LRO_VerticalOffsetDirection

6.4.5 LRO_LateralOffsetDistanceExpression

6.4.5.1 Semantics

The type LRO_LateralOffsetDistanceExpression extends LR_DistanceExpression, allowing the specification of lateral and vertical offsets. If either is provided, it shall include a distance measured from and perpendicular to the linear element or offset referent. The Linear Referencing Method shall be of type LRO_LRMWithOffset. The UML for LRO_LateralOffsetDistanceExpression is shown in Figure 36.

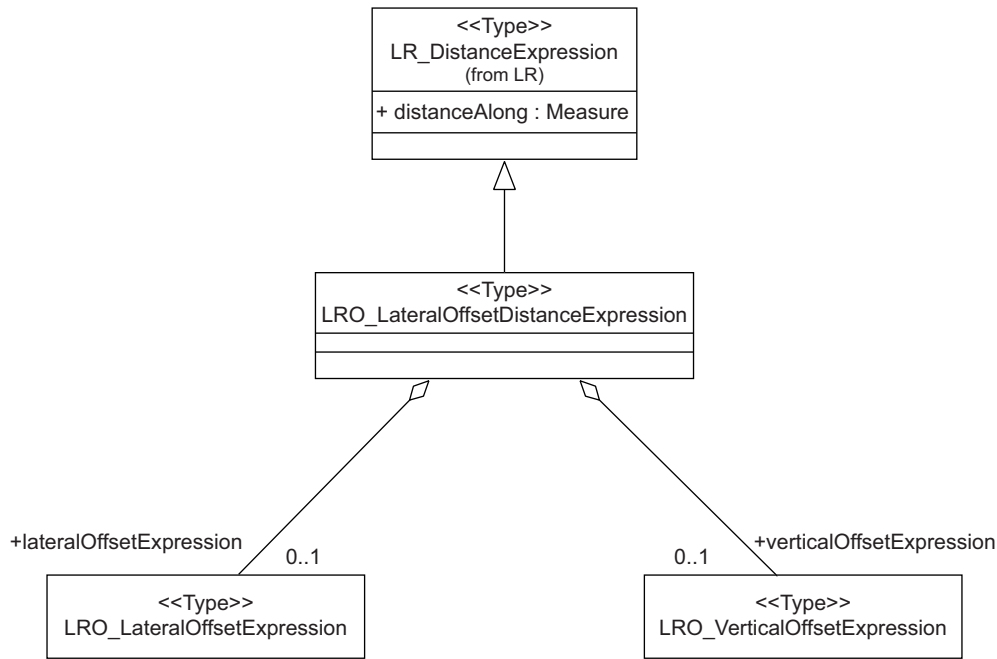

Figure 36 — Context diagram: LRO_LateralOffsetDistanceExpression

6.4.5.2 Role: lateralOffsetExpression[0..1] : LRO_LateralOffsetExpression

The optional association role “lateralOffsetExpression” gives the laterally offset distance of this distance expression. If the lateral offset expression is absent, then the position is not displaced laterally left or right of the LR_LinearElement. An offset expression is appropriate only if the Linear Referencing Method is of type LRO_LRMWithOffset.

```

LRO_LateralOffsetDistanceExpression :: lateralOffsetExpression[0..1] :
    LRO_LateralOffsetExpression
    
```

6.4.5.3 Role: verticalOffsetExpression[0..1] : LRO_VerticalOffsetExpression

The optional association role “verticalOffsetExpression” gives the vertically offset distance of this distance expression. If the vertical offset expression is absent, then the position is not displaced vertically above or below the LR_LinearElement. An offset expression is appropriate only if the Linear Referencing Method is of type LRO_LRMWithOffset.

```

LRO_LateralOffsetDistanceExpression :: verticalOffsetExpression[0..1] :
    LRO_VerticalOffsetExpression
    
```

6.4.6 LRO_LateralOffsetExpression

6.4.6.1 Semantics

The type “LRO_LateralOffsetExpression” is used to describe the lateral offset for a linearly referenced location. The UML for LRO_LateralOffsetExpression is shown in Figure 37.

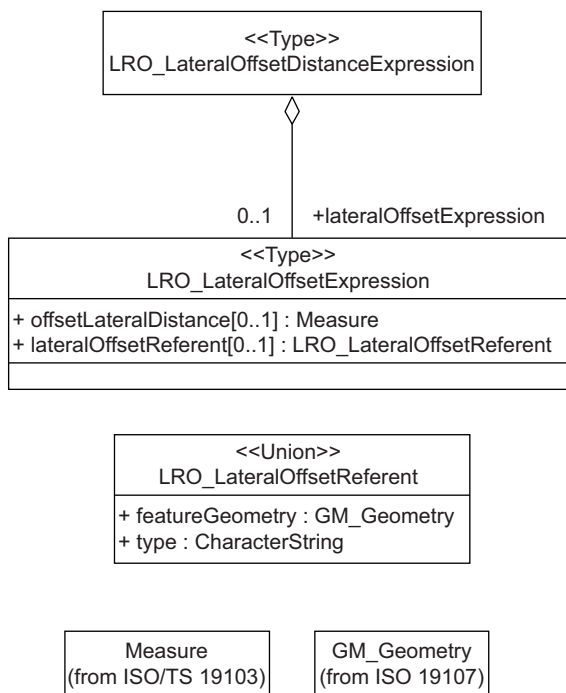

Figure 37 — Context diagram: LRO_LateralOffsetExpression

6.4.6.2 Attribute: offsetLateralDistance[0..1] : Measure

The optional attribute “offsetLateralDistance” is the measure of the lateral offset of the distance expression. This is the distance left or right of the lateral offset referent (or left or right of the linear element being measured if no lateral offset referent is specified) to the position being specified. A positive (+) value is measured in the direction specified by the positive lateral offset direction of the LRM. A missing value or a value of 0 (zero) shall be interpreted as the absence of a lateral displacement from the lateral offset referent (or the linear element being measured if no lateral offset referent is specified).

```
LRO_LateralOffsetExpression :: offsetLateralDistance[0..1] : Measure
```

6.4.6.3 Attribute: lateralOffsetReferent[0..1] : LRO_LateralOffsetReferent

The optional attribute “lateralOffsetReferent” indicates the base line for the lateral offset measure.

```
LRO_LateralOffsetExpression :: lateralOffsetReferent[0..1] :
    LRO_LateralOffsetReferent
```

6.4.7 LRO_LateralOffsetReferent

The union “LRO_LateralOffsetReferent” specifies whether the lateral offset referent is a geometry of a feature or a lateral offset referent type described as a character string. Having only a type of “back of curb”, for example, allows specifying a location as 5 ft behind the back of the curb. This aides in locating the position in the field without having to measure from the linear element. The type can be a conventional value, such as – L1 or RE from XSP (see C.5.2).

If the curb is represented as a Feature with a spatial representation, it is the distance of the curb from the linear element being measured that is determinate and, therefore, the exact spatial position of the position expression can be calculated. Because the Feature can have multiple spatial representations, the GM_Geometry, rather than the Feature, is specified.

The UML for LRO_LateralOffsetReferent is shown in Figure 38.

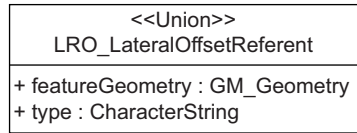

Figure 38 — Context diagram: LRO_LateralOffsetReferent

6.4.8 LRO_VerticalOffsetExpression

6.4.8.1 Semantics

The type “LRO_VerticalOffsetExpression” is used to describe the vertical offset for a linearly referenced location. The UML for LRO_VerticalOffsetExpression is shown in Figure 39.

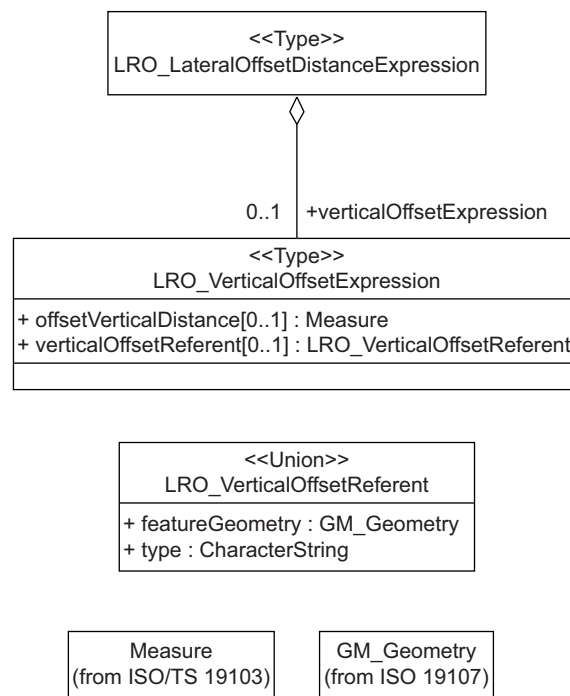

Figure 39 — Context diagram: LRO_VerticalOffsetExpression

6.4.8.2 Attribute: offsetVerticalDistance[0..1] : Measure

The optional attribute “offsetVerticalDistance” is the measure of the vertical offset of the distance expression. This is the distance above or below the vertical offset referent (or, if no vertical offset referent is specified, then above or below the lateral offset referent if one is specified; otherwise, above or below the linear element being measured) to the position being specified. A positive (+) value is measured in the direction specified by the positive vertical offset direction of the LRM. A missing value or a value of 0 (zero) shall be interpreted as the absence of a vertical displacement.

```
LRO_VerticalOffsetExpression :: offsetVerticalDistance[0..1] : Measure
```

6.4.8.3 Attribute: verticalOffsetReferent[0..1] : LRO_VerticalOffsetReferent

The optional attribute “verticalOffsetReferent” indicates the base line for the vertical offset measure.

```
LRO_VerticalOffsetExpression :: verticalOffsetReferent[0..1] :
    LRO_VerticalOffsetReferent
```

6.4.9 LRO_VerticalOffsetReferent

The union “LRO_VerticalOffsetReferent” specifies whether the vertical offset referent is a geometry of a feature or a vertical offset referent type described as a character string. Having only a type of “existing ground at lateral offset”, for example, allows specifying a location as 5 ft above the existing ground at the lateral offset (for example, back of the curb). This aides in locating the position in the field without having to measure from the linear element.

If the curb is represented as a Feature with a spatial representation, the height of the curb is determinate and, therefore, the exact spatial position of the position expression can be calculated. Because the Feature can have multiple spatial representations, the GM_Geometry, rather than the Feature, is specified.

The UML for LRO_VerticalOffsetReferent is shown in Figure 40.

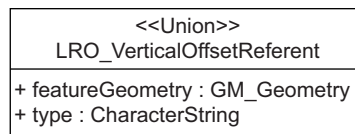

Figure 40 — Context diagram: LRO_VerticalOffsetReferent

6.5 Package: Linear Referencing Offset Vector

6.5.1 Semantics

The package “Linear Referencing Offset Vector” supplies classes and types to the definition of vector offsets. Vector offsets extend the definition of a position expression to accommodate locations that do not lie directly on the linear element, but instead are located some distance from the linear element specified by a vector. The UML for Linear Referencing Offset Vector classes is shown in Figure 41. An application claiming conformance to this Linear Referencing Offset Vector package shall support all of the LROV classes shown in Figure 41, all of the LR classes shown in Figure 14 for the Linear Referencing System package and all of the LRO classes shown in Figure 32 for the Linear Referencing Offset package on which this package is dependent.

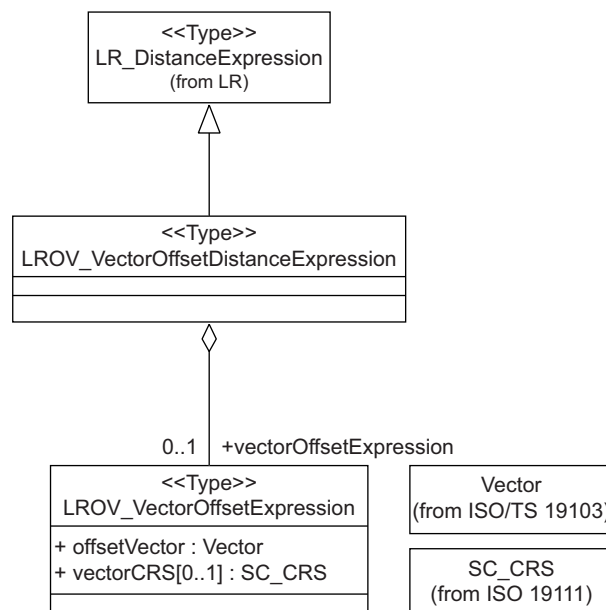

Figure 41 — Linear Referencing Offset Vector classes

6.5.2 LROV_VectorOffsetDistanceExpression

6.5.2.1 Semantics

The type LROV_VectorOffsetDistanceExpression extends LR_DistanceExpression, allowing the specification of vector offsets. If provided, it shall include a vector measured from the linear element. The Linear Referencing Method shall be of type LRO_LRMWithOffset. The UML for LROV_VectorOffsetDistanceExpression is shown in Figure 42.

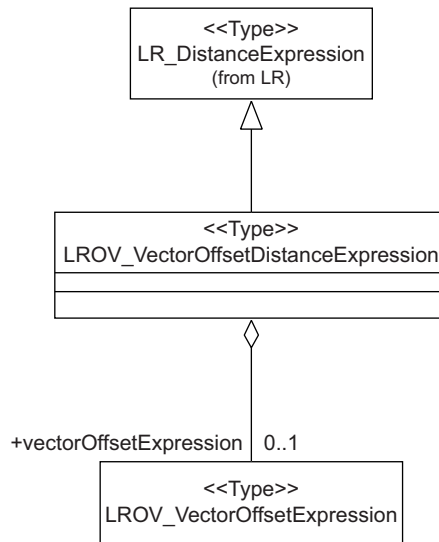

Figure 42 — Context diagram: LROV_VectorOffsetDistanceExpression

6.5.2.2 Role: vectorOffsetExpression[0..1] : LROV_VectorOffsetExpression

The optional association role “vectorOffsetExpression” gives the vector offset expression of this position expression. If the vector offset expression is absent, then the position is not displaced from the LR_LinearElement. An offset expression is appropriate only if the Linear Referencing Method is of type LRO_LRMWithOffset. A position expression shall not have both a lateral and a vector offset expression.

```

LROV_VectorOffsetDistanceExpression :: vectorOffsetExpression[0..1] :
    LROV_VectorOffsetExpression
    
```

6.5.3 LROV_VectorOffsetExpression

6.5.3.1 Semantics

The type “LROV_VectorOffsetExpression” is used to describe the vector offset for a linearly referenced location. The UML for LROV_VectorOffsetExpression is shown in Figure 43.

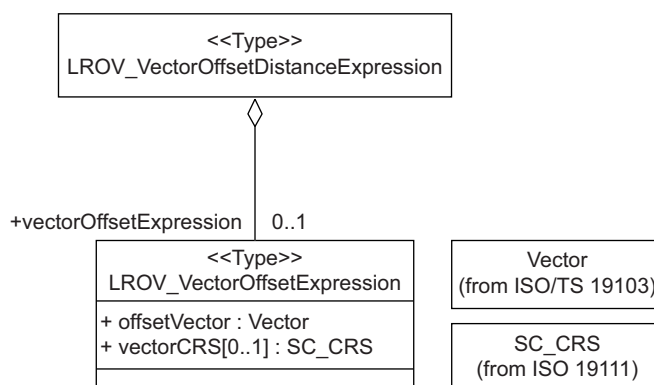

Figure 43 — Context diagram: `LROV_VectorOffsetExpression`

6.5.3.2 Attribute: `offsetVector` : `Vector`

The attribute “`offsetVector`” is the offset vector of the distance expression. This specifies the distance and bearing of the offset from the linear element being measured to the position being specified. A 0 (zero) length vector shall be interpreted as not having a vector displacement from the linear element being measured.

```
LROV_VectorOffsetExpression :: offsetVector : Vector
```

6.5.3.3 Attribute: `vectorCRS[0..1]` : `SC_CRIS`

The optional attribute “`vectorCRS`” is the offset vector Coordinate Reference System and shall be used as described in ISO 19111. If missing, the Coordinate Reference System of the offset vector shall be the same as that of the linear element.

```
LROV_VectorOffsetExpression :: vectorCRS[0..1] : SC_CRIS
```

6.6 Package: Linearly Located Event

6.6.1 Semantics

The package “Linearly Located Event” supplies classes and types to the definition of linearly located events. The UML for linearly located event classes is given in Figure 44. An application claiming conformance to this Linearly Located Event package shall support all of the LE classes shown in Figure 44 and all of the LR classes shown in Figure 14 for the Linear Referencing System package on which this package is dependent.

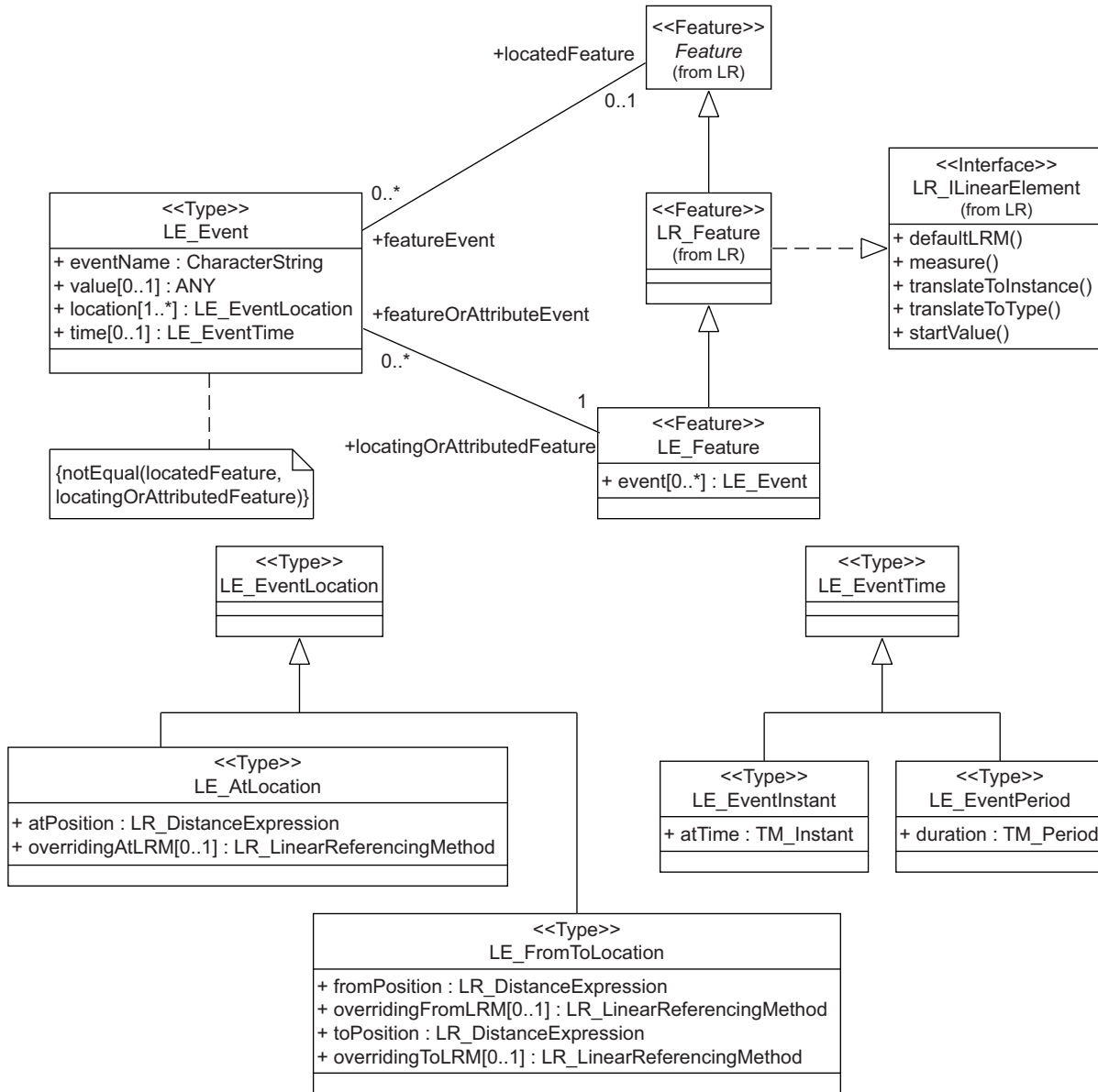

Figure 44 — Linearly Located Event classes

6.6.2 Linearly located event

6.6.2.1 Semantics

A linearly located event is an event that is located using a Linear Referencing System. It can reflect something that happens, like an automobile crash, or something that exists, like a roadway characteristic such as pavement type. Linearly located events are either feature events or attribute events. Feature events allow the location of a (located) feature along another (locating) feature. Attribute events allow the application of an attribute value for only a portion of a linear element, such as the asphalt pavement type can apply only to the first half of Route 1, after which it changes to concrete.

A feature event is used to linearly locate a feature that occurs at a spatial extent defined by linearly referenced locations along another feature and possibly further qualified as occurring at an instant in, or during a period of, time. The Event class contains the attributes required to specify the single position or contiguous spatial interval (with or without offsets) and, if appropriate, the single instance or period of time.

An attribute event is used to linearly locate an attribute value that applies at a spatial extent defined by linearly referenced locations along the attributed feature and possibly further qualified as applying at an instant in, or during a period of, time. The Event class contains the value of the attribute along with the attribute values required to specify the single position or contiguous spatial interval and, if appropriate, the single instance or period of time.

Recall that an LR_PositionExpression requires three parts to specify a linearly located position: a linear element along which to measure, a method of measuring (LRM), and the measured value. For feature events, the linear element is the locating feature. For attribute events, the linear element is the attributed feature. The LRM is the default LRM of the locating feature unless overridden by the overriding LRM of the event location. The measured value is the at, to, or from position of the linearly located event.

The UML for linearly located events is shown in Figure 44. A feature event example is provided in D.1. An attribute event example is provided in D.2.

6.6.3 LE_Feature

6.6.3.1 Semantics

The LE_Feature class is used to describe the locating or attributed feature. It is a subtype of the LR_Feature class from the Linear Referencing Package. As such, it realizes the LR_ILinearElement interface to enable measuring along its length. An application schema is not required to have an explicit LE_Feature subtype. Instead, it can create LE_Feature instances by adding the LR_ILinearElement interface and event attribute(s) to existing application-specific feature classes, such as Road. The UML for LE_Feature is shown in Figure 45.

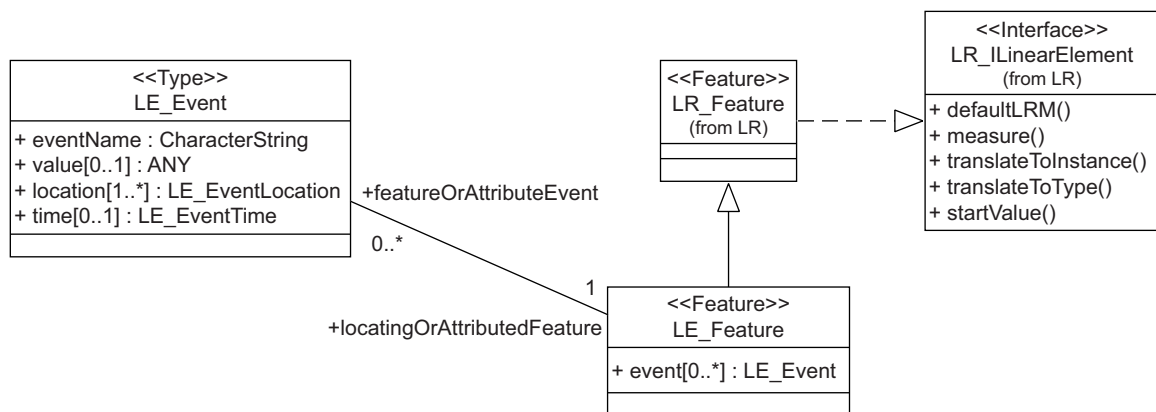

Figure 45 — Context diagram: LE_Feature

6.6.3.2 Role: featureOrAttributeEvent[0..*] : LE_Event

The optional role “featureOrAttributeEvent” specifies feature and attribute events located along the LE_Feature.

```
LE_Feature :: featureOrAttributeEvent[0..*] : LE_Event
```

6.6.4 LE_Event

6.6.4.1 Semantics

The LE_Event class is used to specify information about linearly located feature and attribute events. For attribute events, this information includes an event name, a value specifying an attribute value, the linear location along which the event applies, defined by linearly referenced locations along the locating or attributed feature and possibly further qualified as applying at an instant in, or during a period of, time. For feature

events, a located feature of type Feature is specified in place of the attribute value. The UML for LE_Event is shown in Figure 46.

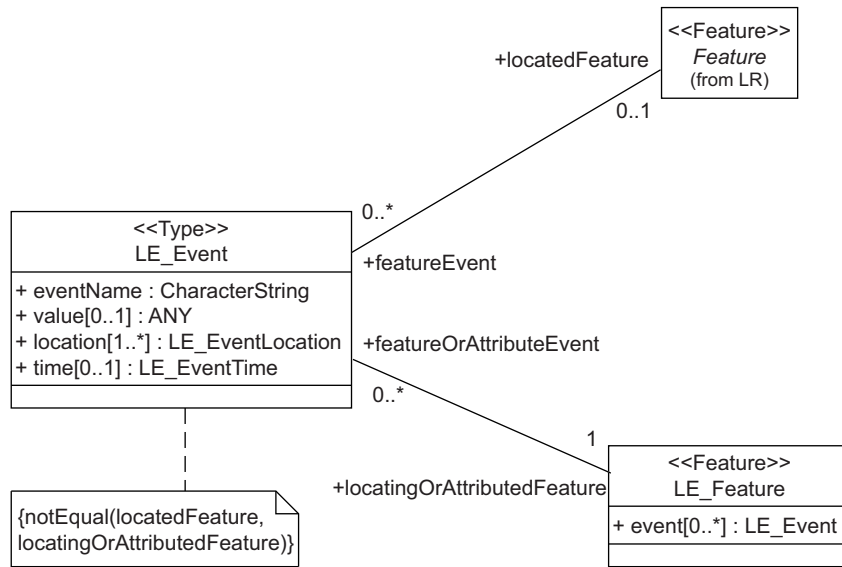

Figure 46 — Context diagram: LE_Event

6.6.4.2 Attribute: eventName : CharacterString

The attribute “eventName” specifies the name of the event.

```
LE_Event :: eventName : CharacterString
```

6.6.4.3 Attribute: value[0..1] : ANY

The optional attribute “value” specifies the value of the event being located. The data type of value is ANY. This allows the value to be any attribute value for attribute events. For attribute events, this value is mandatory. For feature events, no value is provided.

```
LE_Event :: value[0..1] : ANY
```

6.6.4.4 Attribute: location[1..*] : LE_EventLocation

The attribute “location” specifies the linearly referenced location for this event.

A single event instance occurs only in a single place. However, this single place may be described by both “at” and “from/To” locations. For example, a single city feature instance may have separate, scale-dependent “at” and “from/To” locations, even though these two locations represent the same place. Therefore, the cardinality of location is [1..*].

```
LE_Event :: location[1..*] : LE_EventLocation
```

6.6.4.5 Attribute: time[0..1] : LE_EventTime

The optional attribute “eventTime” specifies the time during which the event applies.

```
LE_Event :: time[0..1] : LE_EventTime
```

6.6.4.6 Role: locatedFeature[0..1] : Feature

The optional role “locatedFeature” specifies the feature being located by a feature event. For feature events, it is mandatory; for attribute events, it does not apply.

```
LE_Event :: locatedFeature[0..1] : Feature
```

6.6.5 LE_EventLocation

The type “LE_EventLocation” is used to specify the linearly referenced location of a linearly located event along a locating or attributed feature. The UML for LE_EventLocation is shown in Figure 47.

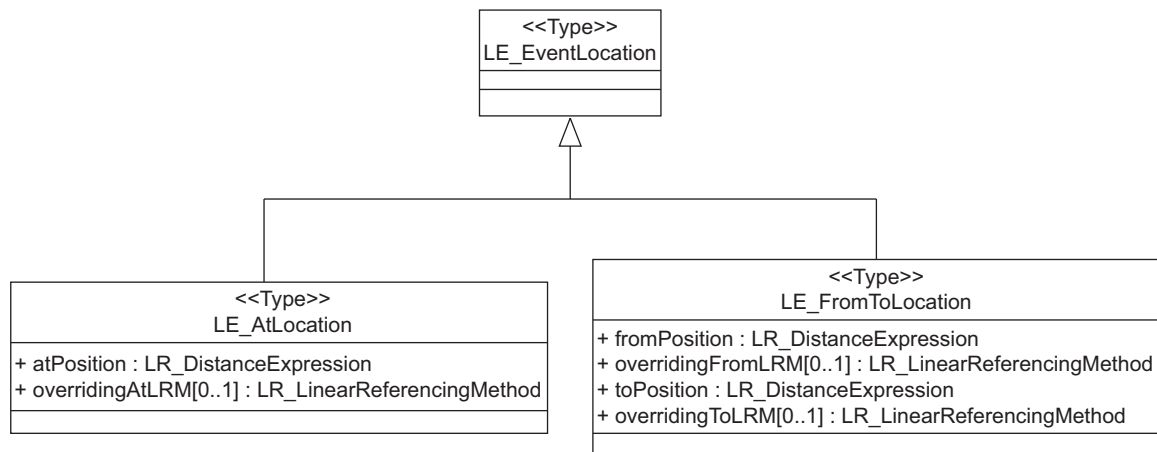

Figure 47 — Context diagram: LE_EventLocation

6.6.6 LE_AtLocation

6.6.6.1 Semantics

The type “LE_AtLocation” is used to specify a single position along the locating or attributed feature. The UML for LE_AtLocation is shown in Figure 47.

6.6.6.2 Attribute: atPosition : LR_DistanceExpression

The attribute “atPosition” specifies the linearly referenced location of the event at a single point along the locating or attributed feature. A linearly referenced location defined by an LR_PositionExpression includes the linear element being measured, a Linear Referencing Method to specify how it is measured and a distance expression to specify the measurement. For this attribute, the linear element is the locating or attributed feature being measured. The Linear Referencing Method is this feature's default Linear Referencing Method, unless overridden by the overridingLRM attribute of the event location. Therefore, it is sufficient to use only an LR_DistanceExpression to specify the “atPosition” since a distance expression specifies the measurement.

```
LE_AtLocation :: atPosition: LR_DistanceExpression
```

6.6.6.3 Attribute: overridingLRM[0..1] : LR_LinearReferencingMethod

The optional attribute “overridingLRM” specifies a Linear Referencing Method for this at location other than the default Linear Referencing Method of the locating or attributed feature being measured.

```
LE_AtLocation :: overridingLRM[0..1] : LR_LinearReferencingMethod
```

6.6.7 LE_FromToLocation

6.6.7.1 Semantics

The type “LE_FromToLocation” is used to specify a contiguous spatial interval along the locating or attributed feature. The UML for LE_FromToLocation is shown in Figure 47.

6.6.7.2 Attribute: fromPosition : LR_DistanceExpression

The attribute “fromPosition” specifies the starting linearly referenced location of the event as a single point along the locating or attributed feature. A linearly referenced location defined by an LR_PositionExpression includes the linear element being measured, a Linear Referencing Method to specify how it is measured and a distance expression to specify the measurement. For this attribute, the linear element is the locating or attributed feature being measured. The Linear Referencing Method is this feature's default Linear Referencing Method unless overridden by the overridingLRM attribute of the event location. Therefore, it is sufficient to use only an LR_DistanceExpression to specify the “fromPosition” since a distance expression specifies the measurement.

```
LE_FromToLocation :: fromPosition: LR_DistanceExpression
```

6.6.7.3 Attribute: toPosition : LR_DistanceExpression

The attribute “toPosition” specifies the ending linearly referenced location of the event as a single point along the locating or attributed feature. A linearly referenced location defined by an LR_PositionExpression includes the linear element being measured, a Linear Referencing Method to specify how it is measured and a distance expression to specify the measurement. For this attribute, the linear element is the locating or attributed feature being measured. The Linear Referencing Method is this feature's default Linear Referencing Method unless overridden by the overridingLRM attribute of the event location. Therefore, it is sufficient to use only an LR_DistanceExpression to specify the “toPosition” since a distance expression specifies the measurement.

```
LE_FromToLocation :: toPosition: LR_DistanceExpression
```

6.6.7.4 Attribute: overridingLRM[0..1] : LR_LinearReferencingMethod

The optional attribute “overridingLRM” specifies a Linear Referencing Method for this from/to location other than the default Linear Referencing Method of the locating or attributed feature being measured.

```
LE_FromToLocation :: overridingLRM[0..1] : LR_LinearReferencingMethod
```

6.6.8 LE_EventTime

The type “LE_EventTime” is used to specify the time during which the linearly located event applies. The UML for LE_EventTime is shown in Figure 48.

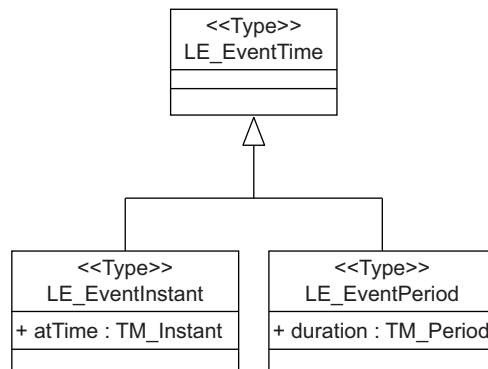

Figure 48 — Context diagram: LE_EventTime

6.6.9 LE_EventInstant

6.6.9.1 Semantics

The type “LE_EventInstant” is used to specify a linearly located event time which is a single instant in time. The UML for LE_EventInstant is shown in Figure 48.

6.6.9.2 Attribute: atTime : TM_Instant

The attribute “atTime” specifies the time at which the event applies as a single instant in valid time and shall be used as described in ISO 19108.

```
LE_EventInstant :: atTime: TM_Instant
```

6.6.10 LE_EventPeriod

6.6.10.1 Semantics

The type “LE_EventPeriod” is used to specify a linearly located event time which is a period of time. The UML for LE_PointPeriodAttributeEvent is shown in Figure 48.

6.6.10.2 Attribute: duration : TM_Period

The attribute “duration” specifies the time at which the event applies as a period of valid time and shall be used as described in ISO 19108.

```
LE_EventPeriod :: duration: TM_Period
```

6.7 Package: Linear Segmentation

6.7.1 Semantics

The package “Linear Segmentation” supplies classes and types to the definition of linear segments. The UML for Linear Segmentation classes is shown in Figure 49. An application claiming conformance to this Linear Segmentation package shall support all of the LS classes shown in Figure 49, all of the LR classes shown in Figure 14 for the Linear Referencing System package and all of the LE classes shown in Figure 44 for the Linearly Located Event package on which this package is dependent. Only segmentation based on event location (not event time) is supported by this edition of this International Standard. The event location shall be of type LE_FromToLocation.

.....

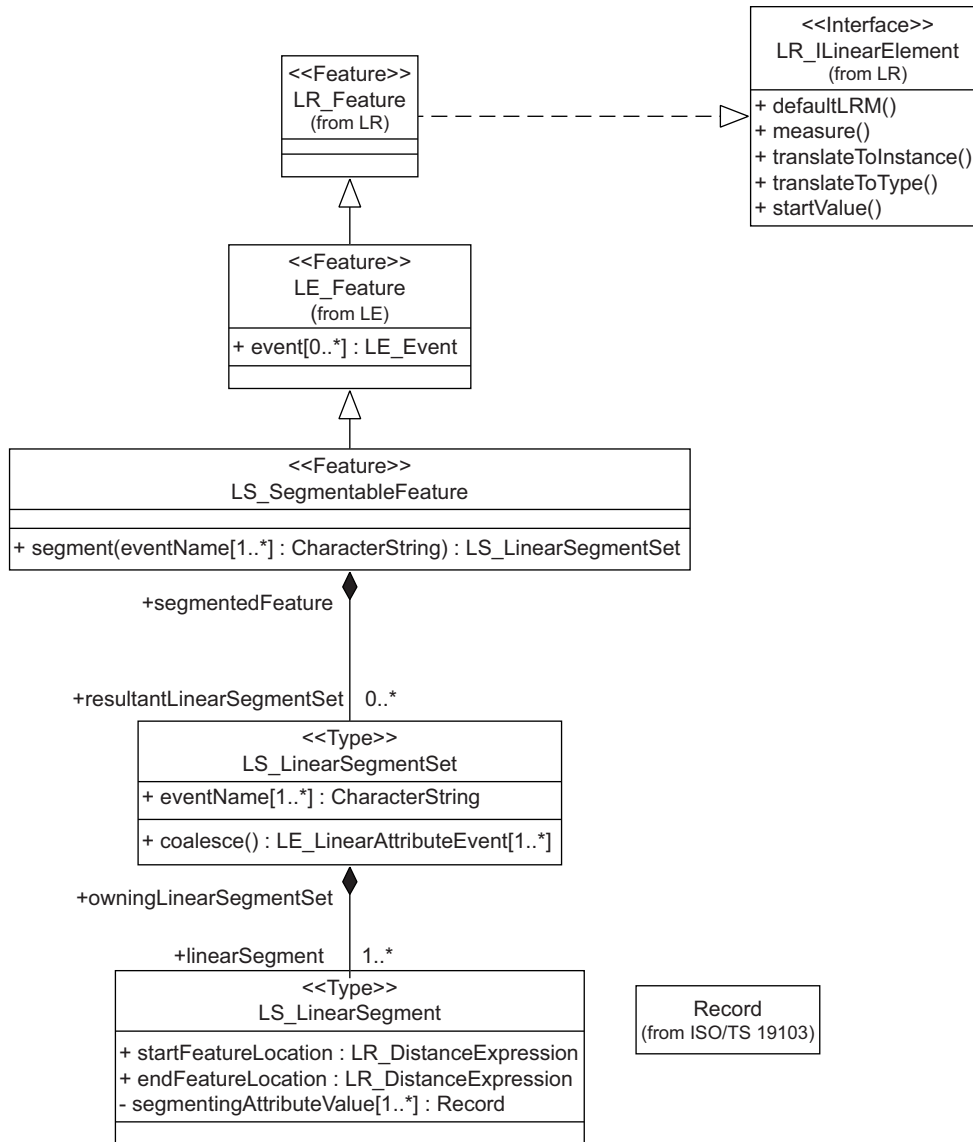

Figure 49 — Linear Segmentation classes

6.7.2 LS_SegmentableFeature

6.7.2.1 Semantics

The type “LS_SegmentableFeature” is extended from LE_Feature from the Linearly Located Event package with the segmentation operation and output. The UML for the LS_SegmentableFeature type is shown in Figure 50.

.....

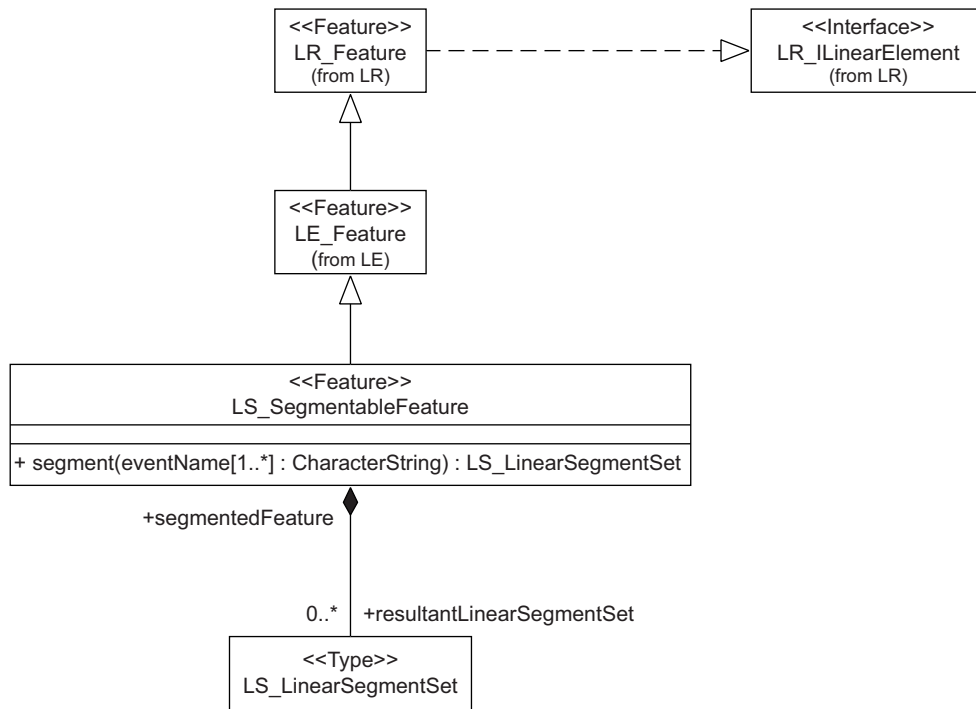

Figure 50 — Context diagram: `LS_SegmentableFeature`

6.7.2.2 Operation: `segment`

The operation “segment” returns the set of linear segments resulting from the intersection of all of the linear attribute events with the specified event names that exist along this feature. The `eventName` is the same as the `eventName` of the `LE_Event`.

```

LS_SegmentableFeature ::
    segment(eventName[1..*] : CharacterString) : LS_LinearSegmentSet
  
```

6.7.2.3 Role: `resultantLinearSegmentSet[0..*] : LS_LinearSegmentSet`

The association role “`resultantLinearSegmentSet`” aggregates the sets of linear segments that result from the `segment` operation. Each execution of the operation generates a new linear segment set.

```

LS_SegmentableFeature :: resultantLinearSegmentSet[0..*] :
    LS_LinearSegmentSet
  
```

6.7.3 `LS_LinearSegmentSet`

6.7.3.1 Semantics

The type “`LS_LinearSegmentSet`” defines the set of linear segments that results from a single execution of the `segment` operation on an `LS_SegmentableFeature`. The UML for the `LS_LinearSegmentSet` type is shown in Figure 51.

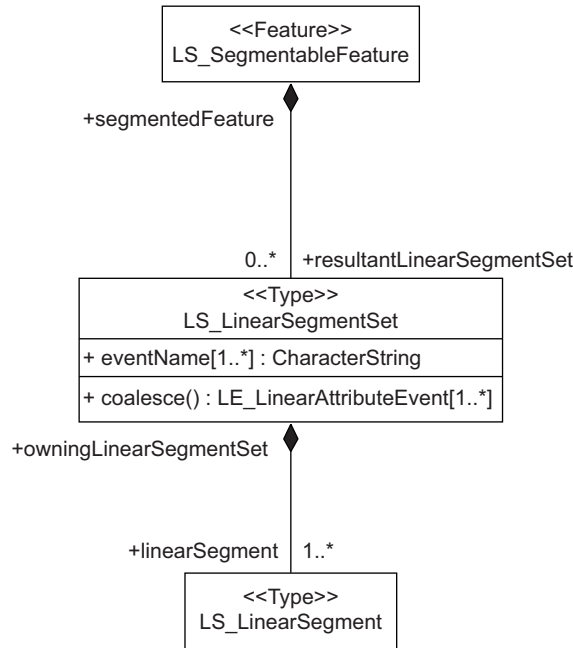

Figure 51 — Context diagram: LS_LinearSegmentSet

6.7.3.2 Attribute: eventName[1..*] : CharacterString

The attribute “eventName” specifies the name of the attribute event(s) that were used to generate this linear segment set. The eventName is the eventName of the LE_Event.

```
LS_LinearSegmentSet :: eventName[1..*] : CharacterString
```

6.7.3.3 Operation: coalesce

The operation “coalesce” returns a set of linearly located events along the segmented feature. The events are of type attribute event and represent the attribute values from the linear segments contained in the linear segment set.

```
LS_LinearSegmentSet ::
    coalesce() : LE_LinearAttributeEvent[1..*]
```

6.7.3.4 Role: segmentedFeature : LS_SegmentableFeature

The association role “segmentedFeature” specifies the linear feature that was segmented, resulting in this particular linear segment set.

```
LS_LinearSegmentSet :: segmentedFeature : LS_SegmentableFeature
```

6.7.3.5 Role: linearSegment[1..*] : LS_LinearSegment

The association role “linearSegment” aggregates the linear segments that result from a single segment operation.

```
LS_LinearSegmentSet :: linearSegment[1..*] : LS_LinearSegment
```

6.7.4 LS_LinearSegment

6.7.4.1 Semantics

The type “LS_LinearSegment” is used to specify the individual linear segments that result from the execution of the segment operation on an LE_Feature. The UML for the LS_LinearSegment type is shown in Figure 52.

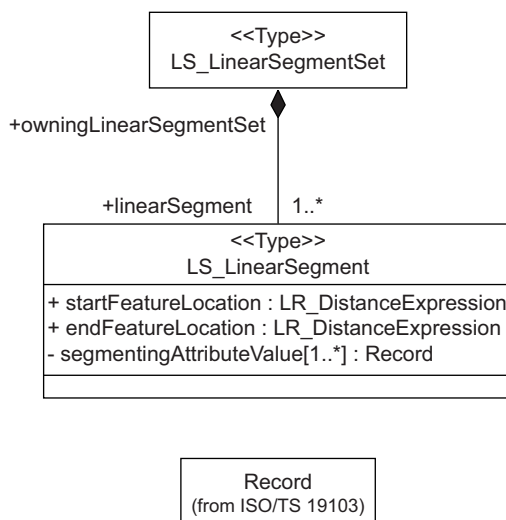

Figure 52 — Context diagram: LS_LinearSegment

6.7.4.2 Attribute: startFeatureLocation : LR_DistanceExpression

The attribute “startFeatureLocation” specifies the linearly referenced location along the segmented feature where the generated linear segment begins. A linearly referenced location defined by a LR_PositionExpression includes the linear element being measured, a Linear Referencing Method to specify how it is measured and a distance expression to specify the measurement. For this attribute, the linear element is the segmented feature. The Linear Referencing Method is this feature's default Linear Referencing Method. Therefore, it is sufficient to use only an LR_DistanceExpression to specify the “startFeatureLocation” since a distance expression specifies the measurement.

```
LS_LinearSegment :: startFeatureLocation : LR_DistanceExpression
```

6.7.4.3 Attribute: endFeatureLocation : LR_DistanceExpression

The attribute “endFeatureLocation” specifies the linearly referenced location along the segmented feature where the generated linear segment ends.

```
LS_LinearSegment :: endFeatureLocation : LR_DistanceExpression
```

6.7.4.4 Attribute: segmentingAttributeValue[1..*] : Record

The attribute “segmentingAttributeValue” specifies the value of an attribute of this linear segment using the type Record from ISO/TS 19103.

```
LS_LinearSegment : segmentingAttributeValue[1..*] : Record
```

6.7.4.5 Role: owningLinearSegmentSet : LS_LinearSegmentSet

The association role “owningLinearSegmentSet” specifies the linear segment set of which this linear segment is a member.

```
LS_LinearSegment :: owningLinearSegmentSet : LS_LinearSegmentSet
```

Annex A (normative)

Abstract test suite

A.1 Data types

A.1.1 Data types for Linear Referencing System

- a) Test purpose: Verify that an application schema or profile instantiates the classes in package Linear Referencing System.
- b) Test method: Inspect the documentation of the application schema or profile.
- c) Reference: 6.2
- d) Test type: Capability

A.1.2 Data types for Linear Referencing Towards Referent

A.1.2.1 Linear Referencing System

Pass test A.1.1.

A.1.2.2 Linear Referencing Towards Referent

- a) Test purpose: Verify that an application schema or profile instantiates the classes in package Linear Referencing Towards Referent.
- b) Test method: Inspect the documentation of the application schema or profile.
- c) Reference: 6.3
- d) Test type: Capability

A.1.3 Data types for Linear Referencing Offset

A.1.3.1 Linear Referencing System

Pass test A.1.1.

A.1.3.2 Linear Referencing Offset

- a) Test purpose: Verify that an application schema or profile instantiates the classes in package Linear Referencing Offset.
- b) Test method: Inspect the documentation of the application schema or profile.
- c) Reference: 6.4
- d) Test type: Capability

A.1.4 Data types for Linear Referencing Offset Vector

A.1.4.1 Linear Referencing System

Pass test A.1.1.

A.1.4.2 Linear Referencing Offset

Pass test A.1.3.2.

A.1.4.3 Linear Referencing Offset Vector

- a) Test purpose: Verify that an application schema or profile instantiates the classes in package Linear Referencing Offset Vector.
- b) Test method: Inspect the documentation of the application schema or profile.
- c) Reference: 6.5
- d) Test type: Capability

A.1.5 Data types for Linearly Located Event

A.1.5.1 Linear Referencing System

Pass test A.1.1.

A.1.5.2 Linearly Located Event

- a) Test purpose: Verify that an application schema or profile instantiates the classes in package Linearly Located Event.
- b) Test method: Inspect the documentation of the application schema or profile.
- c) Reference: 6.6
- d) Test type: Capability

A.1.6 Data types for Linear segmentation

A.1.6.1 Linear Referencing System

Pass test A.1.1.

A.1.6.2 Linearly Located Event

Pass test A.1.5.2.

A.1.6.3 Linear segmentation

- a) Test purpose: Verify that an application schema or profile instantiates the classes in package Linear Segmentation.
- b) Test method: Inspect the documentation of the application schema or profile.
- c) Reference: 6.7
- d) Test type: Capability

A.2 Operations

A.2.1 Operations for Linear Referencing System

- a) Test purpose: Verify that an application schema or profile supports the operations specified in the classes in package Linear Referencing System.
- b) Test method: Inspect the documentation of the application schema or profile.
- c) Reference: 6.2
- d) Test type: Capability

A.2.2 Operations for Linear Referencing Towards Referent

A.2.2.1 Linear Referencing System

Pass test A.2.1.

A.2.2.2 Linear Referencing Towards Referent

- a) Test purpose: Verify that an application schema or profile supports the operations specified in the classes in package Linear Referencing Towards Referent.
- b) Test method: Inspect the documentation of the application schema or profile.
- c) Reference: 6.3
- d) Test type: Capability

A.2.3 Operations for Linear Referencing Offset

A.2.3.1 Linear Referencing System

Pass test A.2.1.

A.2.3.2 Linear Referencing Offset

- a) Test purpose: Verify that an application schema or profile supports the operations specified in the classes in package Linear Referencing Offset.
- b) Test method: Inspect the documentation of the application schema or profile.
- c) Reference: 6.4
- d) Test type: Capability

A.2.4 Operations for Linear Referencing Offset Vector

A.2.4.1 Linear Referencing System

Pass test A.2.1.

A.2.4.2 Linear Referencing Offset

Pass test A.2.3.2.

A.2.4.3 Linear Referencing Offset Vector

- a) Test purpose: Verify that an application schema or profile supports the operations specified in the classes in package Linear Referencing Offset Vector.
- b) Test method: Inspect the documentation of the application schema or profile.
- c) Reference: 6.5
- d) Test type: Capability

A.2.5 Operations for Linearly Located Event

A.2.5.1 Linear Referencing System

Pass test A.2.1.

A.2.5.2 Linearly Located Event

- a) Test purpose: Verify that an application schema or profile supports the operations specified in the classes in package Linearly Located Event.
- b) Test method: Inspect the documentation of the application schema or profile.
- c) Reference: 6.6
- d) Test type: Capability

A.2.6 Operations for Linear segmentation

A.2.6.1 Linear Referencing System

Pass test A.2.1.

A.2.6.2 Linearly Located Event

Pass test A.2.5.2.

A.2.6.3 Linear segmentation

- a) Test purpose: Verify that an application schema or profile supports the operations specified in the classes in package Linear Segmentation.
- b) Test method: Inspect the documentation of the application schema or profile.
- c) Reference: 6.7
- d) Test type: Capability

Annex B (informative)

Generalized model for linear referencing

B.1 Introduction

The approach taken by this International Standard follows the Generalized Model for Linear Referencing developed by Bentley Systems, Inc. The model is based upon work done with the Minnesota Department of Transportation (Mn/DOT) in 1995 under the Location Data Modeling Effort^[5]. The model was first publicly presented at the 1999 GIS in Transportation (GIS-T) Conference in San Diego and the ACM GIS'99 Conference in Kansas City, Missouri. It has since been published in the American Society of Civil Engineering (ASCE) Journal of Computing in Civil Engineering (2001), Geoinformatica (2002)^[3], and the Transportation Research Board Transportation Research Record (2005). It was first implemented in the Mn/DOT Location Data Management system.

Bentley Systems, Inc. is a leading supplier of software products to the US Departments of Transportation (DOT). Most of these States have antiquated roadway inventory databases, each using its own linear referencing method. Other software systems in each state typically use different linear referencing methods based upon what is perceived to be the best method for each software system. One state alone had 47 different linear referencing methods. Faced with the prospect of having to develop individual software products for each of the States to support their disparate linear referencing methods, Bentley decided to first research the domain to determine what the underlying principles were. The fundamental concepts that were uncovered form the basis of the Generalized Model.

The US Transportation Research Board's National Cooperative Highway Research Program (NCHRP) Project 20-27(2) proposed a linear referencing data model^[4] in this same timeframe. It introduced the concept of a linear datum to which other information could be related and tied to real world locations. Their conceptual model separated information out into five levels and proposed various mappings between the five levels (see C.5.1 for a more detailed description). The Generalized Model simplifies the NCHRP model by abstracting out of each level the similar set of fundamental concepts.

In addition to the NCHRP model, Bentley studied other approaches at various DOTs. Not only did they find numerous linear referencing methods, but they uncovered a fundamental problem: there was no easy way to translate a location that used one method to a similar location using another method. In fact, there was not even clear consensus on the separation of what was being measured versus the method of measurement. It was virtually impossible to round trip (translate a location using method A to a location using method B and then back to method A, arriving at the initial location). Some methods included the type of object being measured (for example, route/reference) while others did not.

The following general principles were offered as the basis for the generalized approach.

- All objects along which measurements can be made can be generalized as linear elements.
- Linear Reference Methods can be classified and simplified if the measurement method is separated from the type of linear element being measured.
- The syntax and semantics of the measured distance is a function of the LRM selected.
- A generalized form of location expression can provide a context for the varying distance expressions.
- A generalized form of translation can be defined to convert between LRMs and linear elements.

B.2 Location expression

The first concept introduced by the Generalized Model is the notion of a location expression. A location expression defines a single position along something linear as a linearly referenced location. A linearly referenced location is defined relative to the linear object as opposed to spatial locations that are defined relative to the earth's surface. The location is determined by measuring along the linear object some distance from some known point on the object (possibly its beginning), based upon some measurement method. It is not possible to ascertain the corresponding location on the face of the earth from a location expression unless the spatial location of the linear object is known. This has not prohibited vast amounts of information from being stored, analysed and synthesized based on only its linearly referenced location.

The Generalized Model initially defined a location expression to consist of three distinct items: the linear object being measured, the measurement method, and the measured value along the linear object:

$$\lambda = (\mu, \epsilon, \delta)$$

where λ is a location expression comprised of a linear referencing method (μ), a linear element (ϵ), and a distance expression (δ) whose syntax and semantics are indicated by μ .

Subsequently, a fourth, optional parameter has been introduced: an additional measured value offset from the linear object.

This International Standard has adopted the Generalized Model concept of location expression but changed the name to position expression for consistency within ISO 19133.

B.3 Linear element

The first component of a location expression is the linear object being measured. This is called a linear element. According to the Generalized Model, a linear element is anything that has linear (1D) behaviour and can be measured. In terms of ISO 191 nm , this would include features as well as one-dimensional geometries and topologies.

All linear elements are treated in the same manner. This is an abstraction of the NCHRP model, which handles features (anchor sections and traversals) different from geometries (cartographic representations) and topologies (links). Of course, linear elements in the Generalized Model can have additional attributions: geometries can have geometry, links can have nodes, anchor section features can have anchor points and length, and traversal features can have names, route numbers, functional class, and so on as appropriate. But the fundamental essence of a linear element is captured in the interface it supports: it can be measured.

B.4 Linear referencing method

The linear referencing method prescribes how measurements are made, including where measuring begins, what units apply, whether offsets are allowed and, if so, their units. The method of measuring is purposely separated from the linear element being measured. This enables the same method to be used for different types of linear element.

Linear referencing methods fall into three categories: absolute, relative, and interpolative. For absolute methods, measurement begins at the start of the linear element. For a kilometre-point method, a measured value of 0,5 is measured one-half kilometre from the start of the linear element. For relative, measurement begins at the location of the referent supplied as part of the distance expression. For a kilometre reference post method, a measured value of 2 + 0,5 is measured one-half kilometre from reference post number 2. For interpolative, the measurement is prorated along the linear element based on its length. For a percentage method, a measured value of 50 (percent) is halfway along the linear element.

B.5 Distance expression

The distance expression provides the measured value. The components of the distance expression and how they apply is subject to the linear referencing method. The distance can be as simple as a single numeric value as with a kilometre-point method or more complicated with the specification of a from referent, a towards referent, and a measured value as with a cross-street method.

Though the measured value is of type Measure (it has units), the units shall be consistent with the linear referencing method. A measured value of 1,0 is treated as a mile with a milepoint method but as a kilometre with a kilometre-point method.

B.6 Offset expression

Though not discussed in the cited literature on the Generalized Model, offset expressions have been added. This allows for the specification of locations that do not fall directly on the linear element but instead are some distance and direction offset from the linear element.

As with measures along the linear element, absolute offsets are measured from the linear element and relative offsets are measured from some referent. The referent can be a feature such as a track segment or merely the name of a real-world object, like back of the sidewalk. In the former case, if the feature has a defined spatial geometry, it is possible to ascertain the spatial location that the location expression represents. Though this is not true for the latter case, it is still possible to find things in the real world from the location expression, such as a water valve that is 5 ft from the back of the sidewalk.

B.7 Translation

Because there is no single “best” linear referencing method for all purposes and systems, and because there is a significant amount of information existing in databases with disparate methods, it is necessary to be able to translate from one location expression to another. The location expressions may have different linear referencing methods as is the case for translating a relative kilometre reference post method value into an absolute kilometre-point value along the same route linear element. The location expressions can have different linear elements as is the case for translating from a street to a collinear route. The location expressions may differ in both linear element and method, as is the case for translating from a percentage method along an anchor section to a kilometre-point method along a route.

An essential consideration is that linear elements support translation of location expressions to corresponding location expressions on other linear elements. For example, it is possible to move from a geometry to an anchor section to a link to a traversal (street) to another traversal (collinear route). The translation method is always the same; it uses linear interpolation. NCHRP has a different translation method between each type of linear element.

Translations exhibit closure: you begin with a location expression and end up with another location expression. This is essential for translation chaining and Roundtripping.

Translations are also transitive. Translating from location expression A to location expression B and then to location expression C gives the same result as going directly from A to C. This is useful if there are no mappings available from A to C but there are mappings from A to B and B to C. In States where numerous linear referencing methods exist, it is useful to be able to translate each to and from a single canonical representation instead of creating mappings between each possible pair of methods/elements. A percentage method along a linear datum is useful in this context as the canonical form.

Annex C (informative)

Commonly used linear referencing methods and models

C.1 Introduction

Many different linear referencing methods (LRM) are in use today. Instead of supporting any one individual method, this International Standard is based on the Generalized Model for Linear Referencing^[3]. It is, therefore, intended to be generic enough to support many of the LRMs in use today.

This annex is intended to show how this International Standard can be used for some of the more common LRMs. These are categorized by LRM type: absolute, relative and interpolative.

The Generalized Model for linear referencing has been summarized in Annex B. Other models are included in this annex.

C.2 Absolute linear referencing methods

C.2.1 General

In accordance with absolute LRMs, measurements are made along the linear element from its start, in the direction of the linear element. Commonly used absolute LRMs include milepoint, true mileage, kilometre-point, kilopoint, chainage, hectometre-point, reverse milepoint, reverse kilometre-point and milepoint with lateral offsets expressed in feet.

C.2.2 Milepoint

Milepoint is perhaps the simplest and, together with its metric analogue kilometre-point LRM, represents the most common LRM. Measurements are made in decimal miles along the linear element from its start, in the direction of the linear element. This LRM may also be named true mileage.

The subset shown in Figure C.1 of the UML presented in Clause 6 is sufficient for specifying linearly referenced locations using the milepoint LRM.

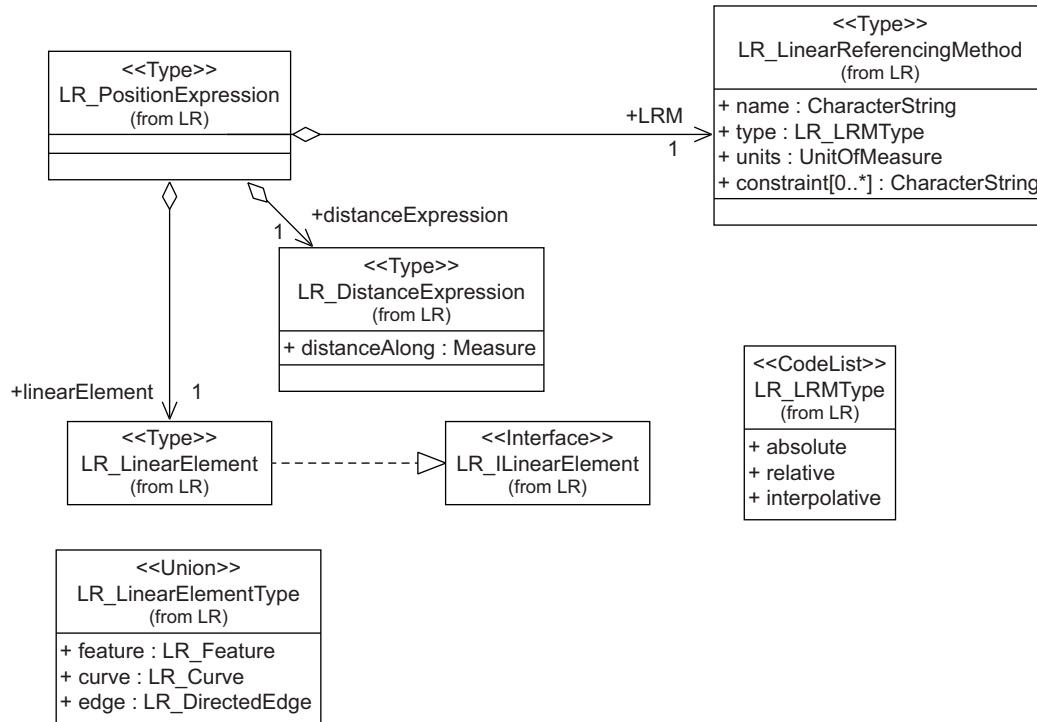

Figure C.1 — Linear referencing system classes for the milepoint LRM

The most common type of LR_LinearElement is feature, such as a road, route, track, rail, or pipeline.

LR_LinearReferencingMethod attributes are as follows:

- name: milepoint;
- type: absolute;
- units: mile;
- constraint: distance along shall be greater than or equal to 0,0 miles and less than the length in miles of the linear element.

The LR_DistanceExpression is merely a distance along value in miles to point A in Figure C.2. A value of 0 (zero) represents a location at the start of the linear element. A value equal to the length of the linear element represents a location at the end of the linear element. The length of the linear element can be determined by its measure() operation.

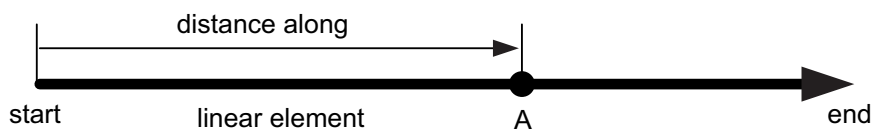

Figure C.2 — Linearly referenced location A with a milepoint LRM

C.2.3 True mileage

Alternative name for milepoint LRM.

C.2.4 Kilometre-point

The kilometre-point LRM is identical to the milepoint LRM except that the LRM unit is kilometre instead of mile and the LR_DistanceAlong distance along measured values are in kilometres. This LRM may also be named kilopoint.

C.2.5 Chainage

The chainage LRM is identical to the milepoint LRM except that the LRM unit is metre instead of mile. Though the original British definition of “chainage” might imply measuring in chains, “chainage” was adopted as a consensus term for this LRM by a team of European Road Authority representatives (including British) for ISO 14825 Geographic Data Files (GDF)^[9].

C.2.6 Hectometre-point

The hectometre-point LRM is identical to the milepoint LRM except that the LRM unit is hectometre (100 m) instead of mile and the LR_DistanceAlong distance along measured values are in hectometres.

C.2.7 Reverse milepoint and kilopoint

Reverse milepoint and kilopoint is similar to milepoint and kilopoint, respectively, except that measuring is done in a direction opposite of the direction of the linear element, that is, from the end of the linear element towards the start^[9].

C.2.8 Link offset

Many organizations establish a topological network of links and nodes and then specify linear locations along uniquely identified links as an absolute distance from the start of the link (the begin node location). This International Standard is very specific about separating the linear element (that which is being measured) from the Linear Referencing Method (how it is measured). Therefore, what is typically referred to as “link offset” is actually the application of an absolute LRM (milepoint, kilometre-point) to link linear elements.

In a topological network, links do not have length and cannot be measured. In order to use a milepoint or kilometre-point LRM then, an LR_Curve geometry is typically associated with each link. Though measurement is actually done along the curve, it is portrayed as being along the associated link. This International Standard also supports the notion of interpolative measurement along an LR_DirectedEdge, so a percentage or normalized LRM can be used to specify linear locations along a link.

C.2.9 Milepoint with lateral offsets in feet

The milepoint with lateral offsets in feet is an extension of the milepoint LRM. A location is first determined by measuring along the linear element a distance in miles specified by the LR_DistanceExpression's distance along value. Then, if an LRO_LateralOffsetExpression is specified, this location is adjusted in accordance with the LRO_LateralOffsetExpression's attribute values given in feet. The metric analogue is kilometre-point or hectometre-point with offsets in metres.

The subset shown in Figure C.3 of the UML presented in Clause 6 is sufficient for specifying linearly referenced locations using the milepoint with lateral offsets in feet LRM.

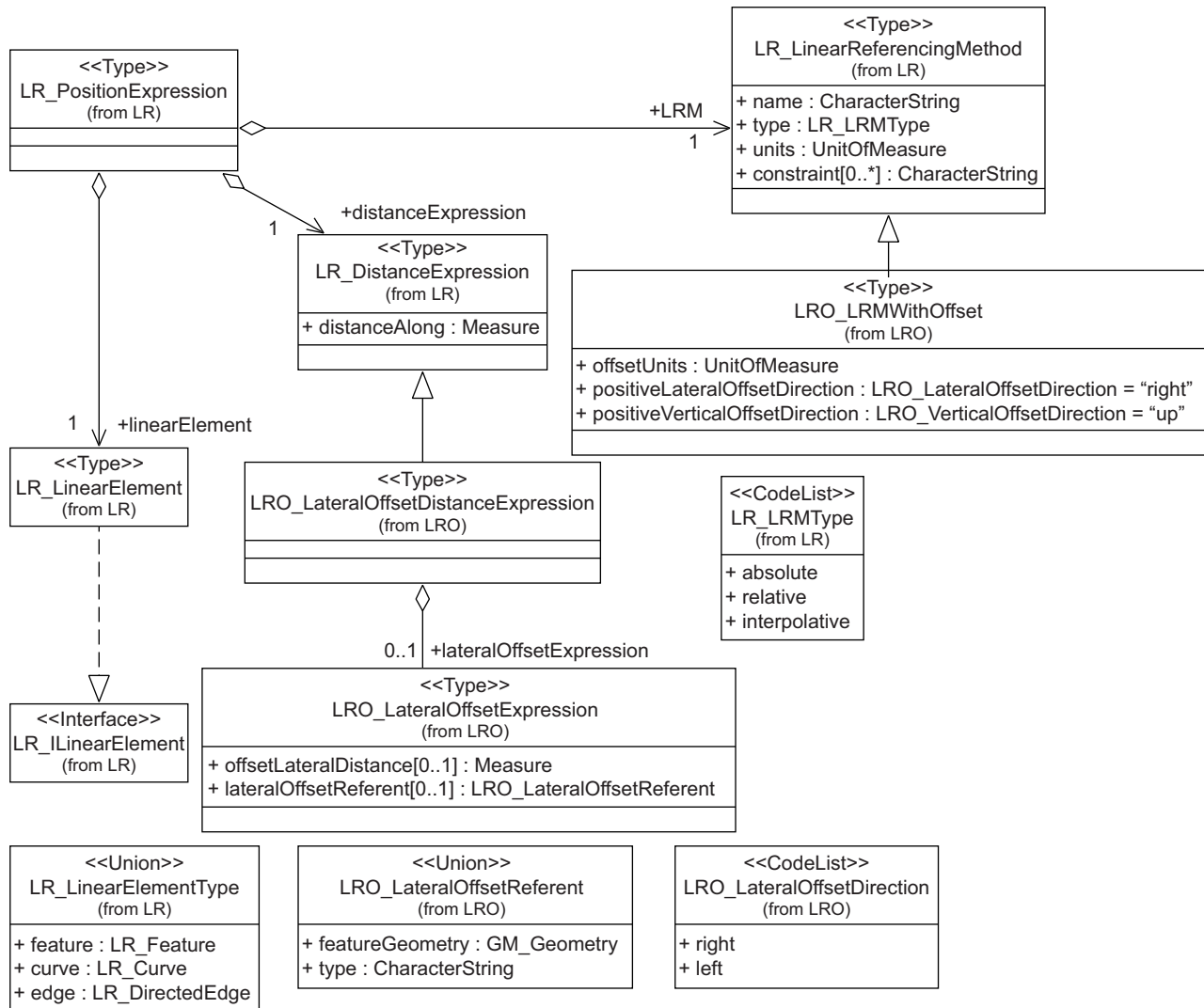

Figure C.3 — Linear referencing system classes for the milepoint with lateral offsets in feet LRM

The most common type of LR_LinearElement is feature, such as a road, route, track, rail, or pipeline.

LR_LinearReferencingMethod attributes are as follows:

- name: milepoint with lateral offsets in feet;
- type: absolute;
- units: mile;
- constraint: distance along shall be greater than or equal to 0,0 miles and less than the length in miles of the linear element;
- offset units: foot;
- positive lateral offset direction: right.

The LR_DistanceExpression specifies a distance along value in miles to point A in Figure C.2. A value of 0 (zero) represents a location at the start of the linear element. A value equal to the length of the linear element represents a location at the end of the linear element. The length of the linear element can be determined by its measure() operation.

The milepoint with lateral offsets in feet LRM allows for the optional addition of an `LRO_LateralOffsetExpression` for any `LR_PositionExpression`. If added, the `LRO_LateralOffsetExpression` is used to specify the lateral offset.

The `LRO_LateralOffsetExpression` offset horizontal distance is measured laterally in feet from the linear element location at point A to Point D in Figure C.4. For a positive distance value, measurement is to the right of the linear element. If negative, it is to the left.

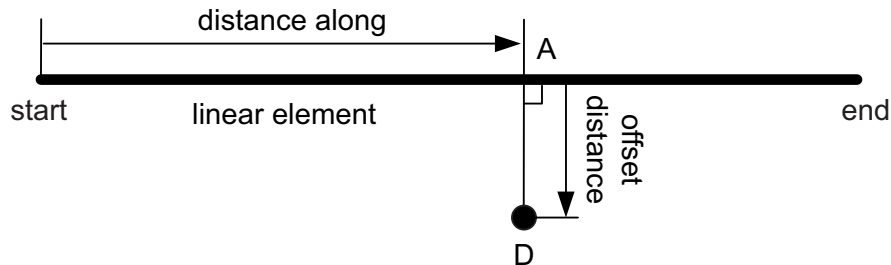

Figure C.4 — Linearly referenced location D with milepoint with lateral offset in feet LRM

If the `LRO_LateralOffsetExpression` includes an offset referent, the offset horizontal distance is instead measured laterally in feet from the offset referent from a point on the offset referent found at its intersection with a line drawn perpendicular to the linear element through point A. For a positive distance value, measurement is to the right of the offset referent to point E in Figure C.5. If negative, it is to the left of the offset referent.

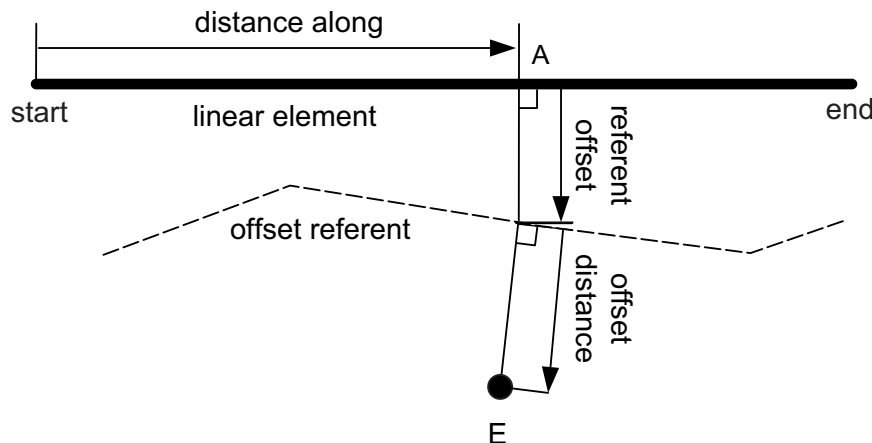

Figure C.5 — Linearly referenced location E with the milepoint with lateral offsets in feet LRM and an offset referent

C.3 Relative linear referencing methods

C.3.1 General

In accordance with relative LRMs, measurements are made along the linear element from a specified “from” referent location, usually in the direction of the linear element unless overridden by a “towards” referent, in which case the direction from the from referent towards the towards referent. Commonly used relative LRMs include milepost, its metric equivalent kilopost (also known as kilometre-post), reference post, county milepoint, cross street and control section.

C.3.2 Milepost

Milepost is perhaps the simplest relative type of LRM. Measurements are made in decimal miles along the linear element from the closest preceding milepost. Measuring is done in the direction of increasing mileposts, which is usually the direction of the linear element.

In some States in the US, a single set of mileposts is used for both carriageways of a divided highway. Mileposts are usually numbered in the north or east predominant direction of the highway. Even if separate linear elements are defined for each carriageway, the along measuring is always done in the direction of increasing mileposts, even though this is opposite the direction of the westbound and southbound carriageway linear elements.

Mileposts are 1 mile apart. Sometimes reconstruction of a part of a roadway can change its overall length. To maintain the milepost spacing of exactly 1 mile, it is necessary to relocate all posts within, as well as those beyond, the area of reconstruction. This is not always feasible or desirable, especially if the road is hundreds of miles in length and the reconstruction occurs near the beginning of the road. Many times the state will relocate only those mileposts within the reconstructed area, prorating the reconstructed distance between the number of mileposts affected. The consequence is that they are no longer 1 mile apart. This means that the LRM henceforth becomes a reference post LRM, requiring knowledge of the inter-post spacing (see C.3.5).

The subset shown in Figure C.6 of the UML presented in Clause 6 is sufficient for specifying linearly referenced locations using the milepost LRM.

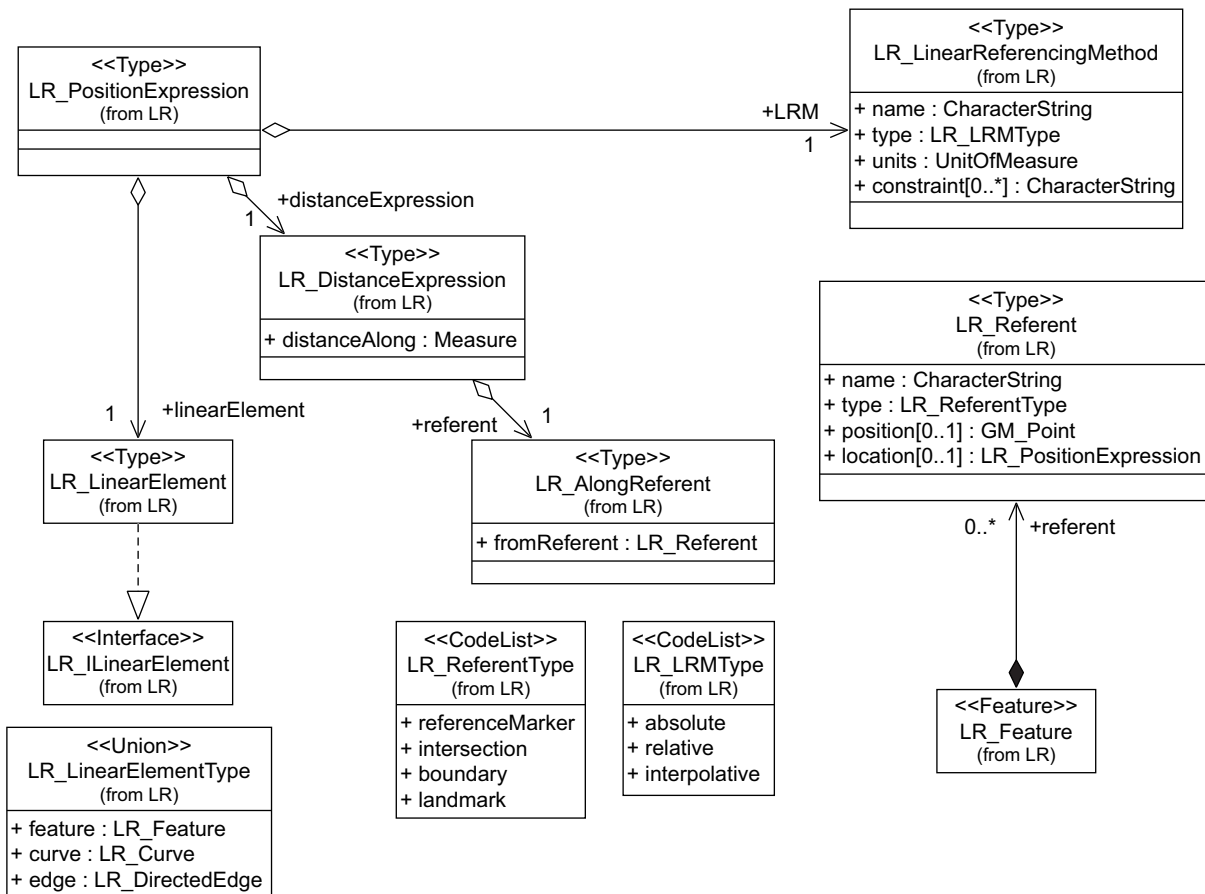

Figure C.6 — Linear referencing system classes for the milepost LRM

The most common type of LR_LinearElement is feature, such as a road, route, track, rail, or pipeline.

LR_LinearReferencingMethod attributes are as follows:

- name: milepost;
- type: relative;
- units: mile;
- constraint: distance along shall be greater than or equal to 0,0 miles and less than 1,0 miles.

The LR_DistanceExpression specifies a distance along value measured in decimal miles from a specified milepost (from referent) to point B in Figure C.7. A value of 0 (zero) represents a location at the referent location.

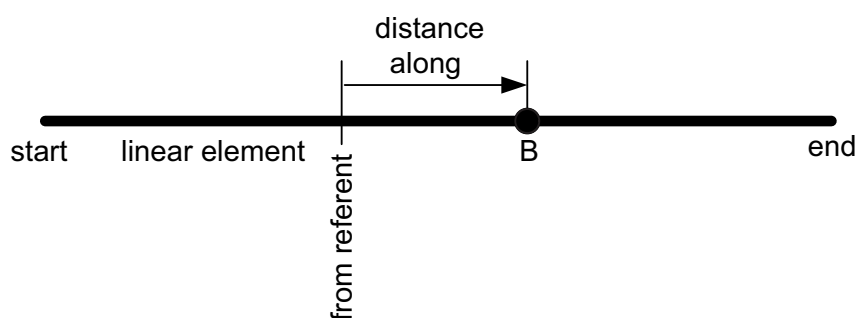

Figure C.7 — Linearly referenced location B with a milepost LRM

An LR_AlongReferent is required. It shall have a from referent of type LR_Referent, having the following attribute values:

- name: <the number of the milepost>;
- type: referenceMarker;
- position: <if specified (unlikely), the GM_Point at the milepost location>;
- location: <if specified, the milepost location>.

Mileposts are owned by an LR_Feature linear element. The milepost location, if specified, shall be specified using an LR_PositionExpression. The linear element of this LR_PositionExpression is the owning linear element. It is not necessary for the LRM of this LR_PositionExpression to be milepost. A milepost LRM allows locating the milepost a certain number of miles from the start of the linear element (for example, milepost 3 has a distance along equal to 3,0). Alternatively, a milepost LRM can be used to specify the location of the milepost relative to the previous one (here milepost 3 has a from referent of milepost 2 and a distance along of 1,0). Since all mileposts have a distance along of 1,0 from the previous milepost and since they are named by their mileage from the start of the linear element, it is not necessary to specify the location; it can be implied (milepost 3 is 3,0 miles from the start of the linear element that owns it).

C.3.3 Kilopost

The kilopost LRM is similar to the milepost LRM except that the LRM unit is kilometre instead of mile and the LR_DistanceAlong distance along measured values are in kilometres. Kiloposts are exactly 1 km apart. If not, it is actually a kilometre reference post LRM. Kilopost locations are specified by using a metric LRM such as kilopoint or kilopost, or are implicitly inferred by the kilopost name.

C.3.4 Kilometre-post

Alternative name for kilopost LRM.

C.3.5 Reference post

The reference post LRM is similar to the milepost LRM except that the reference posts are not necessarily exactly 1 mile apart. It is, therefore, necessary to explicitly specify the location (or possibly position) of each reference post. This can be done with a milepoint LRM, specifying their absolute distance along from the beginning of the owning LR_Feature. Alternatively, they can be located using a relative reference post LRM, locating each reference post a distance along from the previous reference post. Then, if reconstruction occurs, it is necessary to update the distances along only those reference posts in the reconstruction area that are moved.

The LR_LinearReferencingMethod constraint changes to “Distance along shall be greater than or equal to 0,0 miles and less than the distance to the next reference post”.

C.3.6 County milepoint

The county milepoint LRM allows the milepoint value to be reset to zero when a highway enters a new county. If the linear element along which locations are being linearly referenced is a single highway that traverses many counties, then this LRM is used. Linearly referenced locations are specified as a distance in miles from where the highway enters the county (the from referent).

If, however, the highway changes its identity when it enters the new county (for example, it becomes county Route 42) and locations are linearly referenced along Route 42, then Route 42 is the linear element and a simple milepoint (absolute) LRM is appropriate, since it already starts at zero at the county line.

The subset shown in Figure C.8 of the UML presented in Clause 6 is sufficient for specifying linearly referenced locations using the county milepoint LRM.

© ISO 2012 – All rights reserved

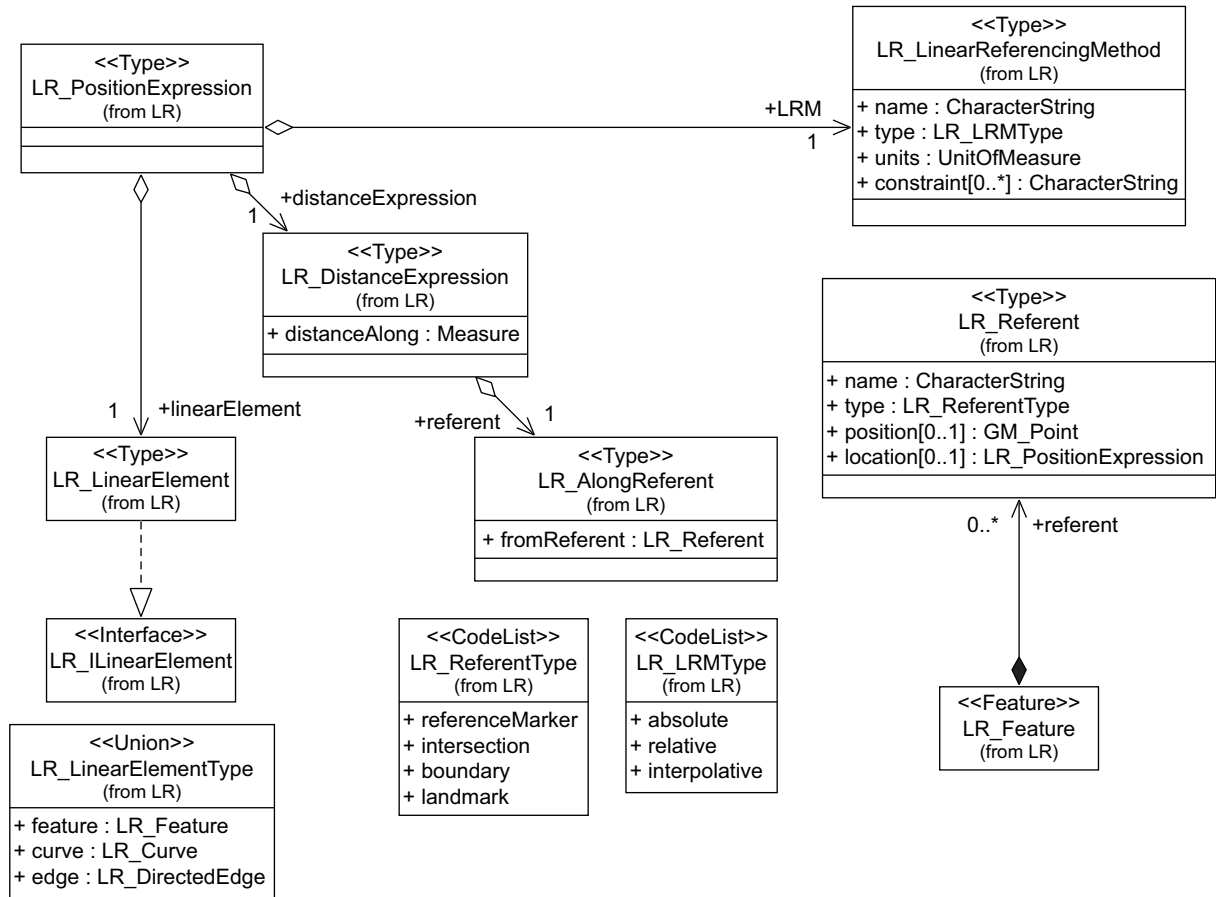

Figure C.8 — Linear referencing system classes for the county milepoint LRM

The most common type of LR_LinearElement is feature, such as a road.

LR_LinearReferencingMethod attributes are as follows:

- name: county milepoint;
- type: relative;
- units: mile;
- constraint: distance along shall be greater than or equal to 0,0 miles and less than the length in miles of the linear element inside the county boundary.

The LR_DistanceExpression specifies a distance along value measured in decimal miles from the intersection of the linear element with the county boundary (from referent) to point A in Figure C.9. A value of 0 (zero) represents a location at the county boundary (referent location).

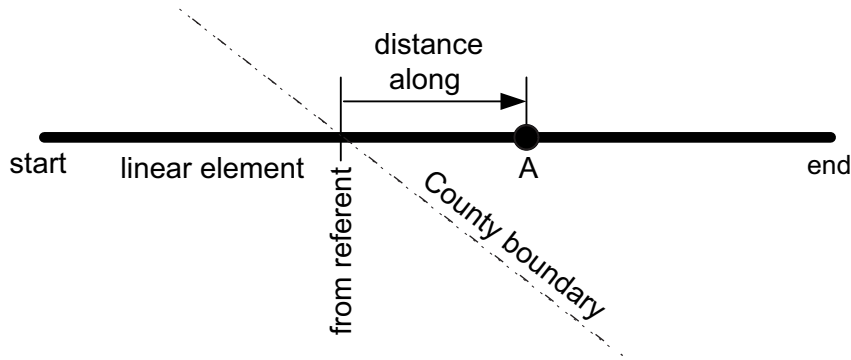

Figure C.9 — Linearly referenced location B with a county milepoint LRM

An LR_AlongReferent is required. It shall have a from referent of type LR_Referent, having the following attribute values:

- name: <the name of the county>;
- type: boundary;
- position: <if specified, the GM_Point at the intersection of the linear element and the county boundary>;
- location: <if specified, the LR_PositionExpression that specifies the location of the county boundary crossing the linear element>.

Boundary type referents are owned by an LR_Feature linear element because they apply only to that linear element; they specify where the particular boundary crosses the linear element. Most likely, both the linear element and county boundary are features having geometry. An LE_Event can be used to specify the linearly referenced location along the linear element (locating feature) where the county boundary (located feature) crosses. The point of intersection, expressed as an LR_PositionExpression, is the at position of the event.

C.3.7 Cross street

The cross street LRM allows the specification of a location at a distance along a linear element, measured in miles from the intersection of one street with the linear element in a direction towards the intersection of another street with the linear element.

The subset shown in Figure C.10 of the UML presented in Clause 6 is sufficient for specifying linearly referenced locations using the cross street LRM.

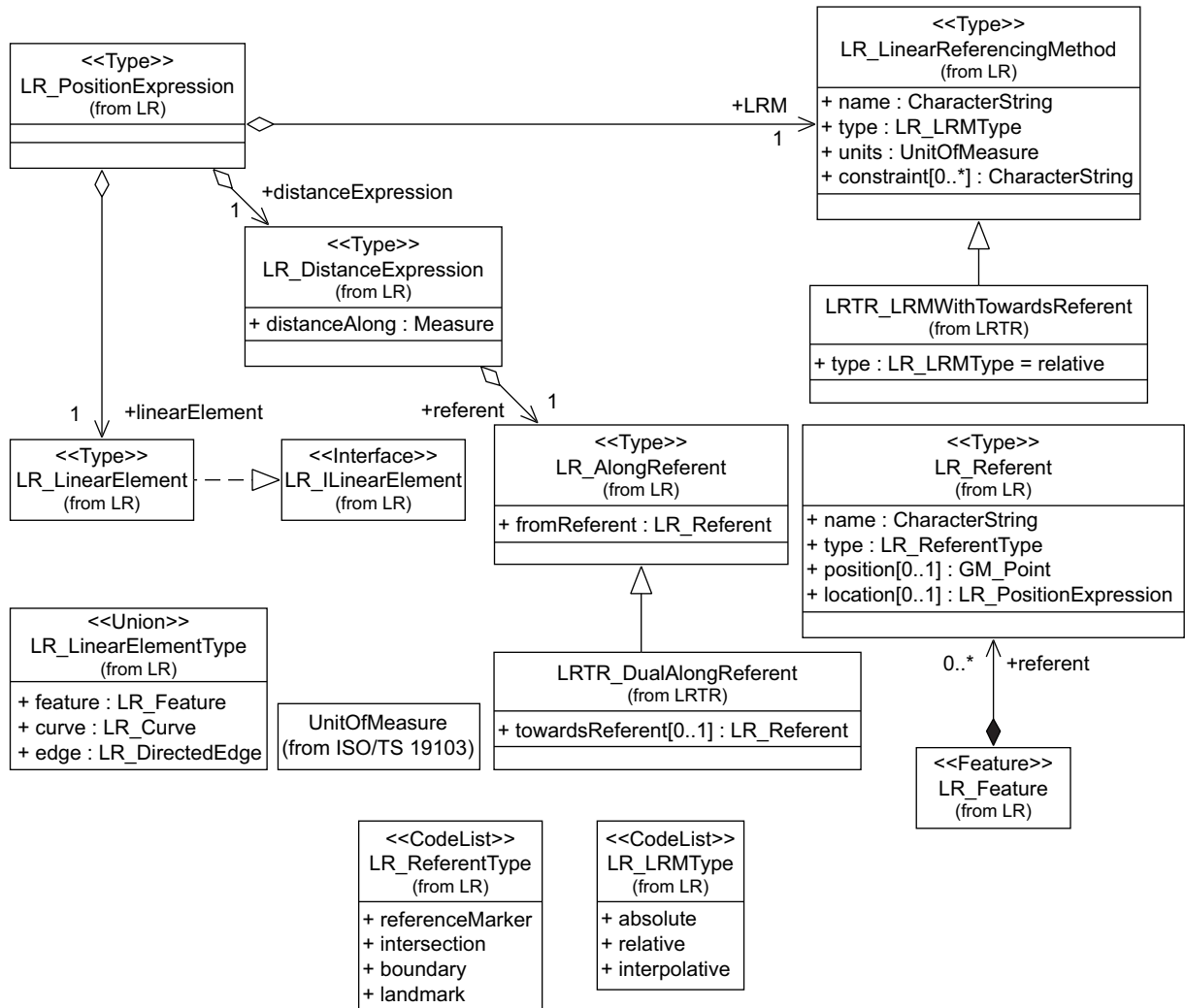

Figure C.10 — Linear referencing system classes for the cross street LRM

The most common type of LR_LinearElement is feature, such as a street.

LR_LinearReferencingMethod attributes are as follows:

- name: cross street;
- type: relative;
- units: mile;
- constraint: distance along shall be greater than or equal to 0,0 miles and less than the distance in miles along the linear element to the towards referent.

The LR_DistanceExpression specifies a distance along value measured in decimal miles from the intersection of the linear element, Lincoln St., with the first street, First Ave. (the from referent) towards the intersection with the second street, Second Ave. (the towards referent) specified by point A in Figure C.11.

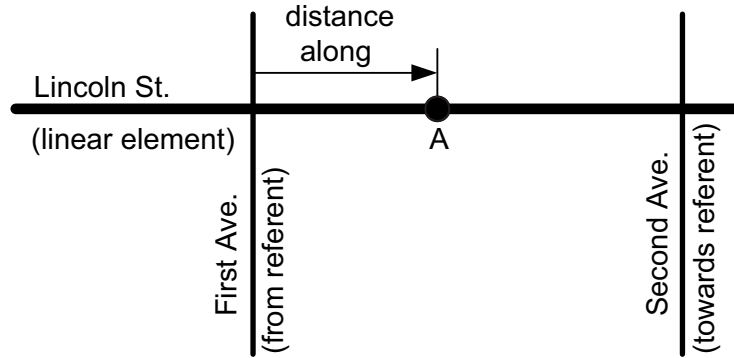

Figure C.11 — Linearly referenced location C with a cross street LRM

An LR_AlongReferent is required. It shall have a from referent of type LR_Referent, having the following attribute values:

- name: <the name of the first intersecting street>;
- type: intersection;
- position: <if specified, the GM_Point at the intersection of the linear element and the first street>;
- location: <if specified, the LR_PositionExpression that specifies the location of the first street crossing the linear element>.

An LRTR_TowardsReferent is also required. It shall have a towards referent of type LR_Referent, having the following attribute values:

- name: <the name of the second intersecting street>;
- type: intersection;
- position: <if specified, the GM_Point at the intersection of the linear element and the second street>;
- location: <if specified, the LR_PositionExpression that specifies the location of the second street crossing the linear element>.

Intersection type referents are owned by an LR_Feature linear element because they apply only to that linear element; they specify where a particular street crosses the linear element. Most likely, both the linear element and the first and second crossing streets are features having geometry. Two LE_Events can be used to specify the linearly referenced locations along the linear element (locating feature) where the first and second crossing streets (located features) cross the linear element. The points of intersection, expressed as LR_PositionExpressions, are the respective at positions of the events.

C.3.8 Control section

The Control Section LRM allows the measure value to be reset to zero when a highway enters a new Control Section. If the linear element along which locations are being linearly referenced is a single highway that traverses multiple control sections that are defined according to agency-specific business rules, then this LRM is used. Linearly referenced locations are specified as a distance in the specified measurement unit from where the highway enters the control section (the from referent or starting control section anchor point).

The philosophy behind the establishment of control sections is to distinguish between significant differences in road physical characteristics (for example, change from an undivided highway section to a divided highway section or vice versa) and/or to limit the length of a measured section of road in order to minimize accumulative measure value errors. Control section begin/end points (control section anchor points) may be

established either at topological nodes or at points where the linear element intersects a stable administrative boundary (for example, a county boundary).

The subset shown in Figure C.12 of the UML presented in Clause 6 is sufficient for specifying linearly referenced locations using the control section LRM:

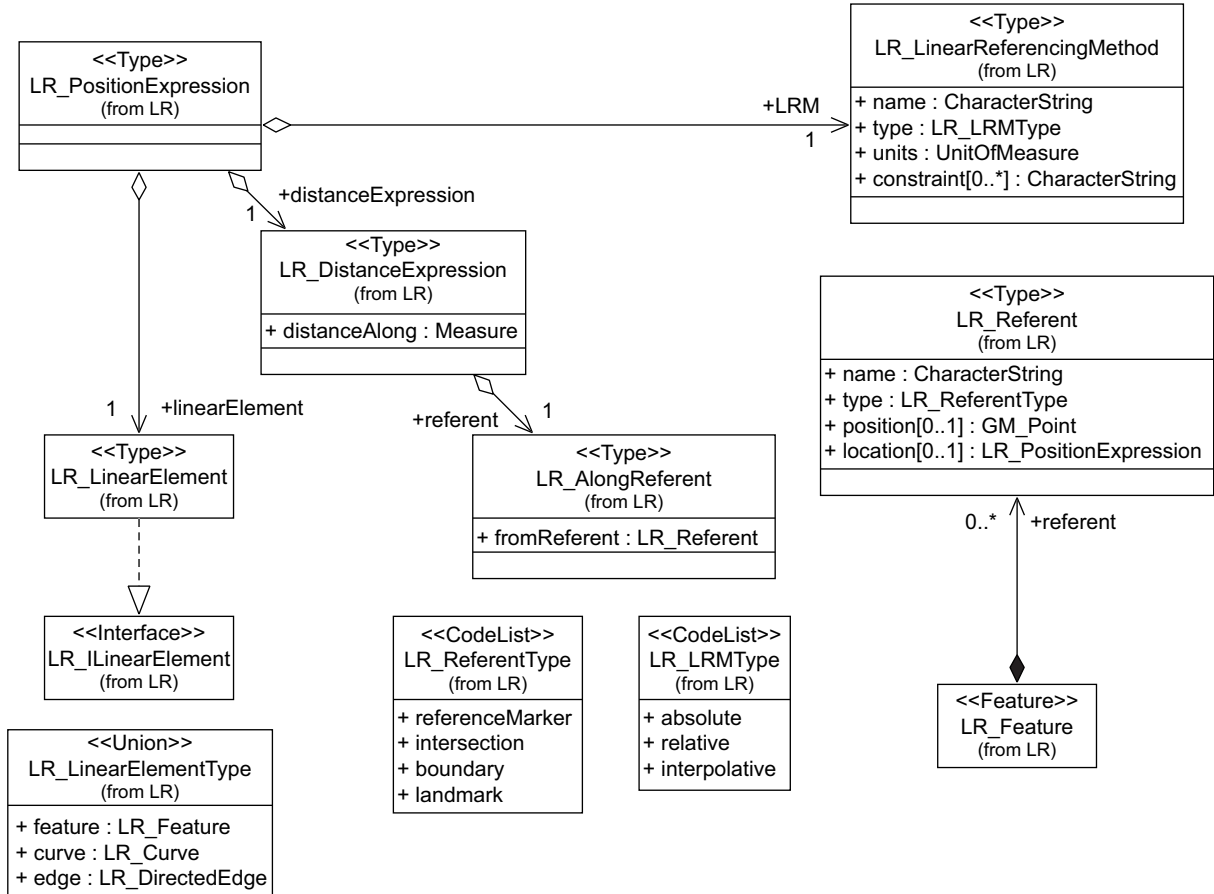

Figure C.12 — Linear referencing system classes for the control section LRM

The most common type of LR_LinearElement is feature, such as a section of road along a numbered highway or route.

LR_LinearReferencingMethod attributes are as follows:

- name: Control Section;
- type: relative;
- units: mile;
- constraint: distance along shall be greater than or equal to 0,0 in the defined measurement unit and less than the length of the portion of the linear element defined by the beginning and ending control section anchor points.

The LR_DistanceExpression specifies a distance along value measured in the defined measurement unit from the intersection of the linear element with the beginning control section anchor point (from referent) to point B in Figure C.13. A value of 0 (zero) represents a location at the beginning control section anchor point (referent location).

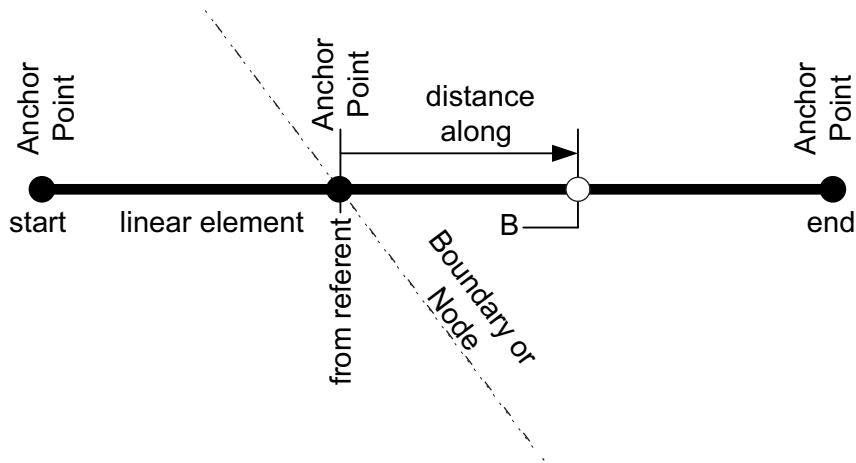

Figure C.13 — Linearly referenced location B with a control section LRM

An LR_AlongReferent is required. It shall have a from referent of type LR_Referent, having the following attribute values:

- name: <the identifier of the control section>;
- type: boundary or intersection;
- position: <if specified, the GM_Point at either a topological node (intersection of the linear element with another linear element) or the intersection of the linear element and the county boundary>;
- location: <if specified, the LR_PositionExpression that specifies the location of the boundary crossing the linear element>.

Boundary type referents are owned by an LR_Feature linear element because they apply only to that linear element; they specify where the particular boundary crosses the linear element. Most likely, both the linear element and boundary are features having geometry. An LE_Event can be used to specify the linearly referenced location along the linear element (locating feature) where the boundary (located feature) crosses. The point of intersection, expressed as an LR_PositionExpression, is the at position of the event.

NOTE An alternative approach is to make the control section a linear element. Then an absolute LRM (milepoint, kilometre-point) can be used to specify linear locations along the control sections, measured from the start of the control section.

C.4 Interpolative linear referencing methods

C.4.1 General

In accordance with interpolative LRMs, measurements are interpolated in accordance with the default length of the linear element. Commonly used interpolative LRMs include percentage and normalized. Interpolative LRMs are the only ones likely to be used for linear elements of type “edge”.

C.4.2 Percentage

Percentage is another commonly used LRM. Measurements are made along the linear element from its start and are expressed as the percentage that this is of the total length of the linear element.

The subset shown in Figure C.14 of the UML presented in Clause 6 is sufficient for specifying linearly referenced locations using the percentage LRM.

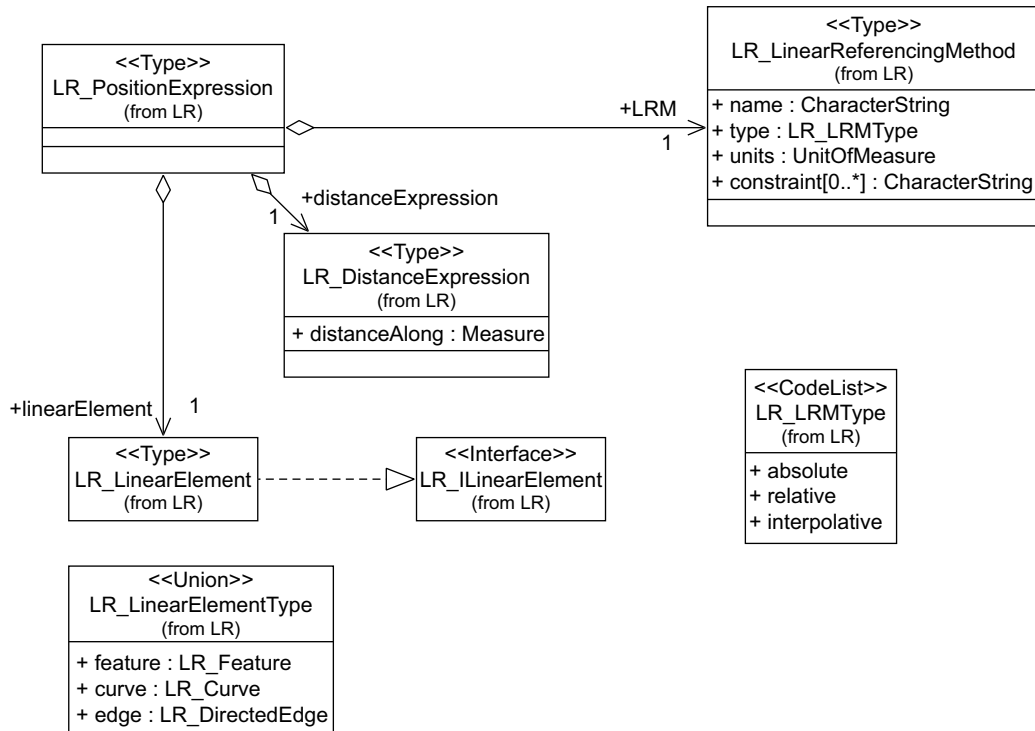

Figure C.14 — Linear referencing system classes for the percentage LRM

The most common type of LR_LinearElement is curve or edge.

LR_LinearReferencingMethod attributes are as follows:

- name: percentage;
- type: interpolative;
- units: percent.

The LR_DistanceExpression is merely a distance along value expressed as the percentage that the distance from the start of the linear element to point A in Figure C.15 is of the overall length of the linear element. A value of 0 (zero) represents a location at the start of the linear element. A value of 100 represents a location at the end of the linear element. The overall length of the linear element is returned by its measure() operation.

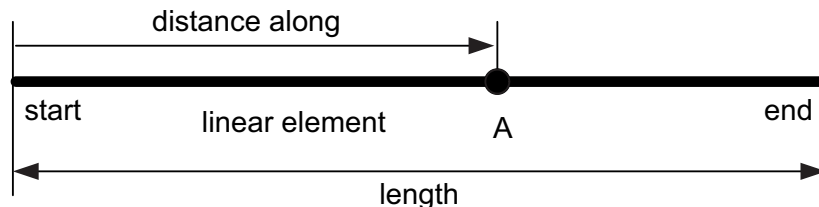

Figure C.15 — Linearly referenced location A with a percentage LRM

If the linear element is a directed edge, its measure() operation returns a weight value instead of a length, such as the total time required to traverse the edge. With a percentage LRM, an LR_DistanceExpression having a value of 0 (zero) represents a location at the start node of the edge and represents a weight of zero. The traversal time is zero since no part of the edge has been traversed. A value of 100 represents a location at the end node of the edge and represents a weight equal to the overall weight value assigned to the edge. The traversal time is then equal to the time required to traverse the entire edge. A value of 50 represents a “location” midway between the two nodes, or more correctly, half of the overall weight. In the traversal time

example, this is half of the time required to traverse the entire edge, since linear interpolation implies a uniform rate of traversal.

C.4.3 Normalized

The normalized LRM is identical to the percentage LRM except that the measured values range from 0 (zero) to 1 (one) instead of 0 to 100, where a measured value of 0 (zero) represents a location at the start of the linear element and 1 (one) represents a location at the end of the linear element.

C.5 Other linear referencing information

C.5.1 NCHRP 20-27(2) model

The US Transportation Research Board's National Cooperative Highway Research Program (NCHRP) Project 20-27(2) proposed a linear referencing data model^[4]. The conceptual data model separates information into five levels as shown in Figure C.16.

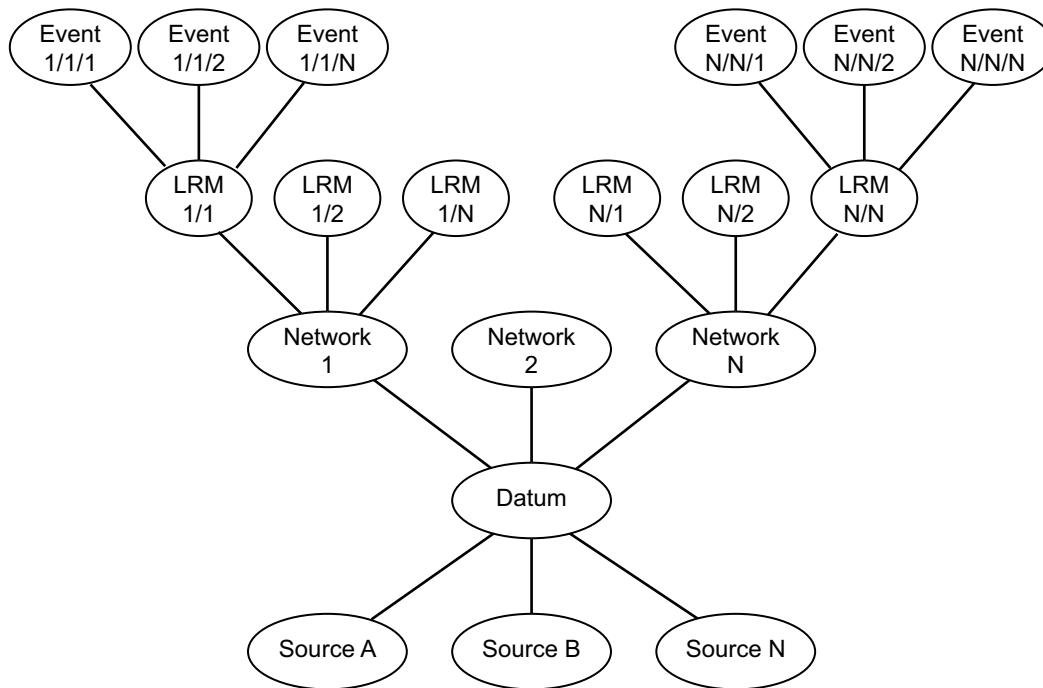

Figure C.16 — NCHRP 20-27(2) data model levels

The principal concept introduced was the linear datum. Comprised of anchor points and anchor sections, this datum connects linear referencing methods to cartographic representations and connects computer databases to the real world. An anchor point represents a geographic position in the real world that can be unambiguously located based on the description of the anchor point. Anchor sections represent the connection between anchor points. They themselves have no geometry; only a length attribute.

Cartographic representations are lines on a map or in a GIS that have geometry and spatial location. These appear as a level separate from the linear datum in the NCHRP model. Each anchor section can be mapped to an ordered list of connected lines. From and to positions specify where along the first line the anchor section begins and where along the last line the anchor section ends, respectively. Cartographic representations are shown as sources in Figure C.16. The model supports multiple graphic representations, for example, at different levels of precision.

Similarly, multiple networks can be defined, each comprised of a set of topologically connected links and nodes. Links and nodes are purely topological: they have no geometry or location. Each network is mapped to the datum by defining the position of each node along an anchor section. The network level provides the basis for analytical operations such as pathfinding and flow. This is the most controversial part of the model, as many have argued that this level should not be mandatory.

The Linear referencing method level accommodates the specification of linearly referenced locations. For each LRM, a set of traversals is defined. These are the only linear elements available for specifying positions. Traversal reference points can be specified along traversals. Traversals are tied into the rest of the model by specifying which (whole) network links are associated with each traversal.

Point and linear events are zero- and one-dimensional, respectively, “phenomena that occur along a traversal and are described in terms of their attributes in the extended database”. Their location shall be specified relative to a traversal reference point.

The mappings between the various levels are depicted in Figure C.17. Note that there is no single, consistent mapping strategy; the type of mapping [point to line, whole line to whole line(s), whole line to partial line(s)] depends on which levels are participating in the mapping.

LRM to network mappings are the most problematic. Though the purpose of the network level and, therefore, the determination of node locations, is for topological traversal, the requirement that LRM traversals be comprised of whole links necessitates the introduction of intermediate nodes to break links to support this. This is contrary to the usual network topological constraint that each node shall have either one or else three or more links associated with it. Furthermore, it introduces extraneous nodes for each LRM associated with the network. The value in allowing multiple networks is to enable support of simplified networks based on node reduction and this requirement is contrary to that notion.

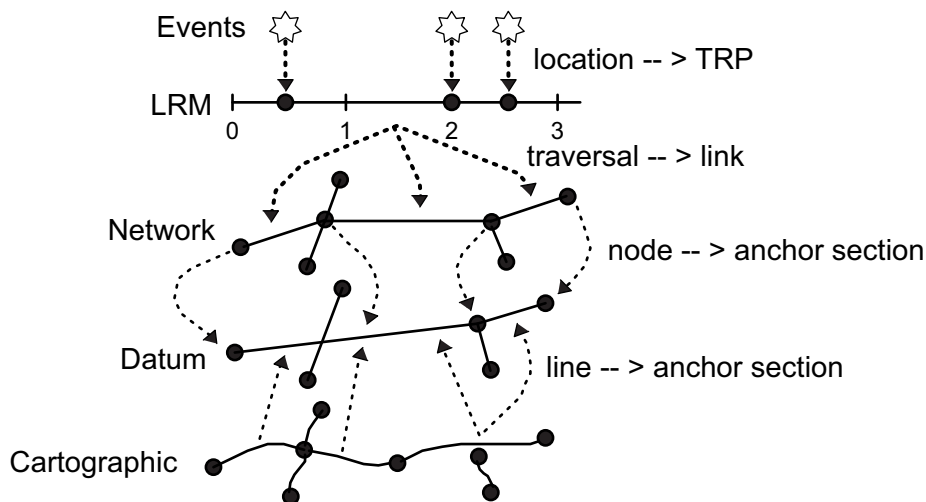

Figure C.17 — NCHRP 20-27(2) data model mappings

The Generalized Model for linear referencing used as the basis for this International Standard was developed as a simplification of the NCHRP 20-27(2) model. As can be seen in Figure C.18, four of the levels in the NCHRP model have (or should have) some common behaviour: they contain linear components that can be measured along. This led to the conceptualization of “linear element”.

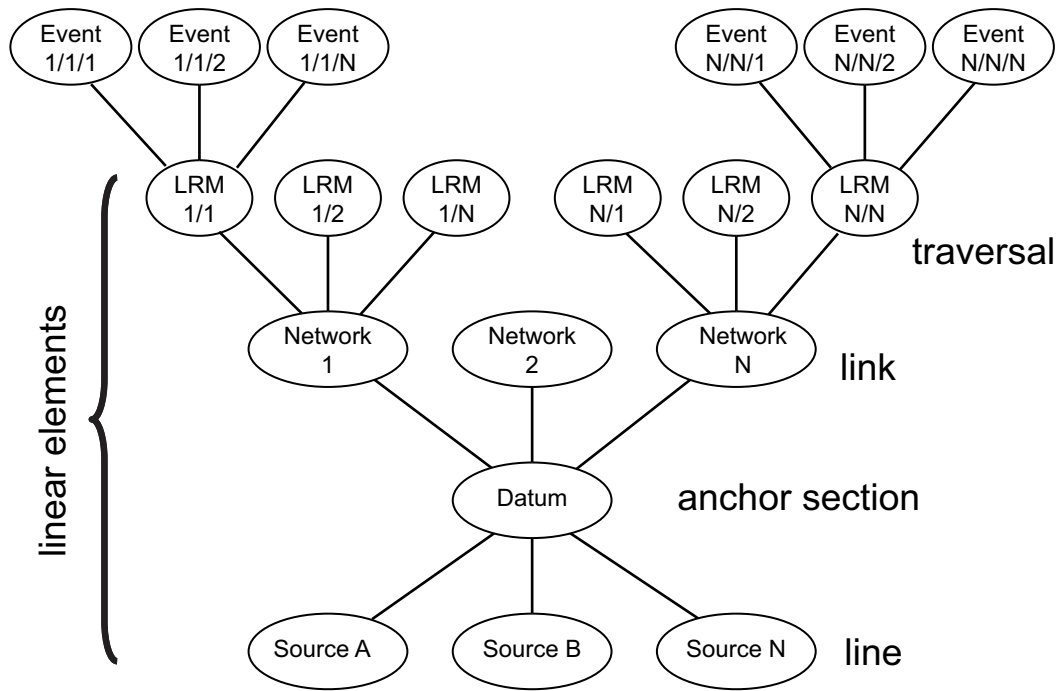

Figure C.18 — Generalizing the NCHRP 20-27(2) data model

By abstracting this behaviour, it is possible to collapse the NCHRP model into two levels: linear elements and linearly located events. In addition to simplifying the model, this has a profound effect on mappings. A single mapping transformation (τ_{1-N}), as shown in Figure C.19, can be specified between any of the levels enabling both closure and transitivity, which in turn enables round tripping and chaining.

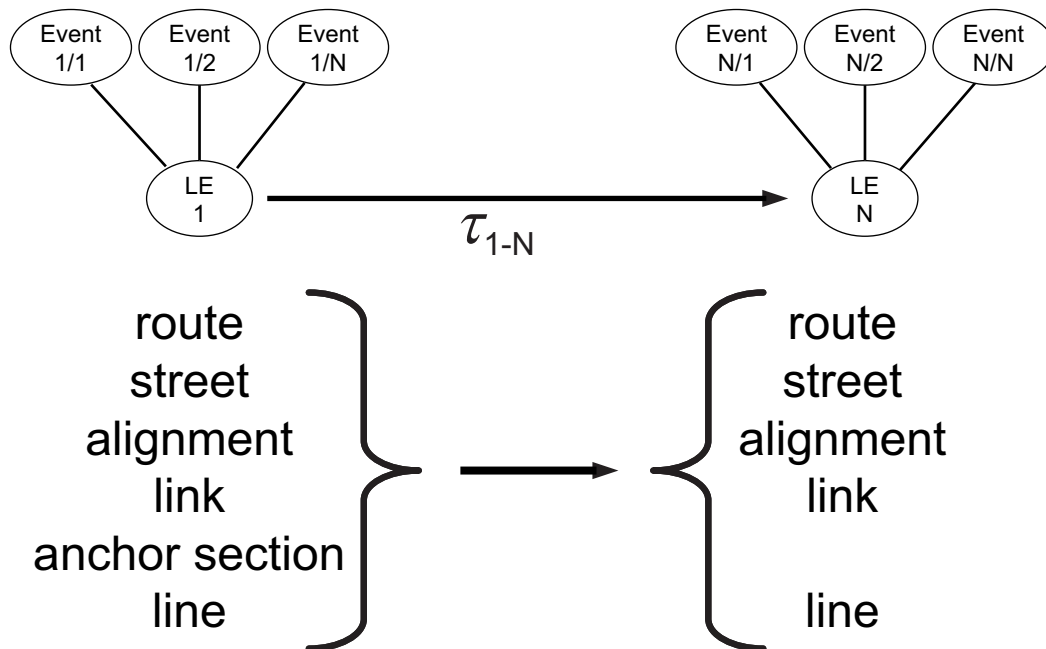

Figure C.19 — Single mapping transformation

This International Standard still enables support for all levels of the NCHRP model. Lines in the cartographic representation are linear elements of type LR_Curve. Anchor sections in the datum level and traversals in the LRM level are linear elements of type LR_Feature. Links in the network level are linear elements of type LR_DirectedEdge.

This International Standard enables support for NCHRP events. It extends the NCHRP notion of event to include temporality and to allow for absolute and interpolative specification of event locations in addition to relative location. Most significantly, the Generalized Model, and therefore this International Standard, allows for the location of events along any LR_Feature, including the linear datum anchor sections. This enables a single, consistent, non-redundant persistence of event information, viewable as if it were referenced to any traversal using any available LRM.

NCHRP assumes a single datum. The Generalized Model makes no such limitation; you can have more than one and still be able to translate between or transitively through them as required.

C.5.2 Cross-sectional positioning

For cross-sectional positioning (XSP), example cross-section positions are shown in Table C.1 with sample conventions shown in Table C.2^[10].

Table C.1 — Cross-section positions

Name of XSP	Abbreviation	Strip or line	Numbering convention
Left Boundary	LB	Line	—
Left Boundary Area	LA	Strip	—
Left Off Carriageway	L	Strip	1 to 9, right to left
Left Edge	LE	Line	—
Left Hard Shoulder	LH	Strip	—
Left Additional Nearside Lane	-L	Strip	1 to 9, right to left
Left Permanent Lane	CL	Strip	1 to 9, left to right
Left Additional Offside Lane	+L	Strip	1 to 9, left to right
Centre Line	CC	Line	—
Right Additional Offside Lane	+R	Strip	1 to 9, right to left
Right Permanent Lane	CR	Strip	1 to 9, right to left
Right Additional Nearside Lane	-R	Strip	1 to 9, left to right
Right Hard Shoulder	RH	Strip	—
Right Edge	RE	Line	—
Right Off Carriageway	R	Strip	1 to 9, left to right
Right Boundary Area	RA	Strip	—
Right Boundary	RB	Line	—

Table C.2 — XSP convention

Left Boundary	
Left Boundary Area	
	N
	↑
	2
Left Off Carriageway	1
Left Edge	
Left Hard Shoulder	
	N
	↑
	2
Left Additional Nearside Lane	1
Left Permanent Lane	1
	2
	↓
	N
Left Additional Offside Lane	1
	2
	↓
	N
Centre Line	
	N
	↑
	2
Right Additional Offside Lane	1
	N
	↑
	2
Right Permanent Lane	1
Right Additional Nearside Lane	1
	2
	↓
	N
Right Hard Shoulder	
Right Edge	
Right Off Carriageway	1
	2
	↓
	N
Right Boundary Area	
Right Boundary	

Annex D (informative)

Event and segmentation examples

D.1 Linearly located feature event example

Consider the feature event example in Figure D.1. In an application schema, two feature classes have been defined: Road and Wildlife Fence. Both Road and Wildlife Fence are features because they have attributes and a unique identifier. It is necessary that Roads be linearly measurable features, so Road realizes the LR_ILinearElement interface. Roads have attributes road name and centreline geometry. The geometry is of type GM_Curve. Wildlife Fences do not have a geometry attribute. They are linearly located along a road, so do not require the LR_ILinearElement interface. Wildlife Fences have an attribute of height.

An instance of Road, MainStreet, has a road name of “Main Street”. An instance of Wildlife Fence, aWildlifeFence, has a height of 6.

To linearly locate a Wildlife Fence feature along a Road feature, an LE_Event is required. LE_Events have an event name to identify them and a location to specify where along a linear feature they apply. If the event is used to specify an attribute value, then this value is required. Otherwise, it specifies the location of a located feature and this located feature shall be specified. LE_Events may also have a time during which they apply.

In the example, aWildlifeFence runs along the side of MainStreet. Therefore, an instance of LE_Event, aFeatureEvent, is used to specify where along MainStreet the Fence feature instance is located. The LE_Event instance is given an event name of “WildlifeFence”. It has MainStreet as its locating feature and aWildlifeFence as its located feature.

To specify where along the road the fence applies, an event location is required. Because the fence runs along the side of the road for some linear distance, both from and to positions are required. The LE_FromToLocation subtype of LE_EventLocation is, therefore, appropriate. Nothing is known about the time during which the fence exists, so event time is not applicable in this example.

To specify the linearly located positions of the start and end of the fence along the road, three items are required: what is being measured, how it is being measured, and the actual measured values. “What is being measured” is the road instance. “How it is measured” is specified by the default linear referencing method of the road; defaultLRM is a supported method as part of the LR_ILinearElement interface realized by all LR_LinearFeatures. Alternatively, an overriding linear referencing method can be specified as an LE_FromToLocation attribute value. The “actual measured values” are the LE_FromToLocation fromPosition and toPosition values. These are of type LR_DistanceExpression, which includes a distanceAlong measured value.

In this example, the default linear referencing method of Roads is kilometrepoint. The distance along values are 0 and 5 so the fence begins at the beginning of the road and continues for 5 km. If it is important to specify that the fence is located a certain distance to the right or left of the road, an LRO_LateralOffsetExpression is used.

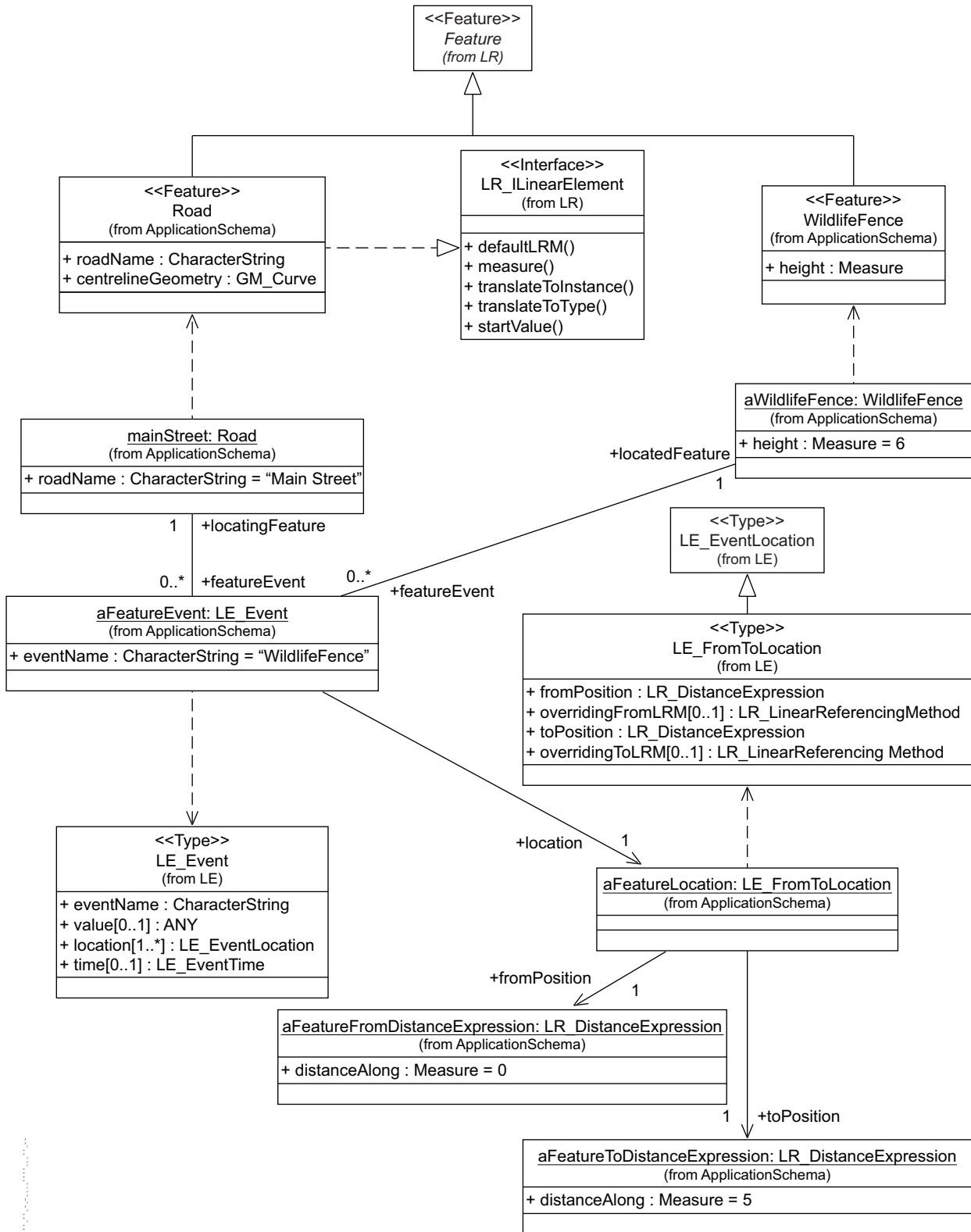

Figure D.1 — Feature event example

D.2 Linearly located attribute event example

Consider the attribute event example in Figure D.2. In an application schema, a feature class has been defined that is called Road. Road is a feature because it has attributes and a unique identifier. It is necessary that Roads be linearly measurable features, so Road realizes the LR_ILinearElement interface. Road has two attributes: road name and centreline geometry. Additionally, it is necessary to specify the speed limit of the road.

Road name is a traditional instance attribute; its value applies to the entire Road feature instance. The value of the speed limit may only apply for part of the length of the Road feature instance. It is, therefore, defined as an attribute event of type LE_Event. Each road can have zero or more speed limit values throughout its entire length, each of which is represented by a different linearly located event. Each occurrence of a speed limit value is augmented by fromPosition and toPosition to specify where along the attributed road feature the speed limit value applies. Notice that additional attributes are specified for each speed limit value to specify when the speed limit value is valid (for example, weekdays from 7 am until 6 pm) and for which type of vehicles. To accomplish this, a SpeedLimitEvent class is created as an application-schema-specific subtype of LE_Event.

In the example, the speed limit of Main Street is 55 km/h for its first 20 km. The time period during which this speed limit value applied to the roadway (for example, since January 1, 2005), is specified using the event time attribute.

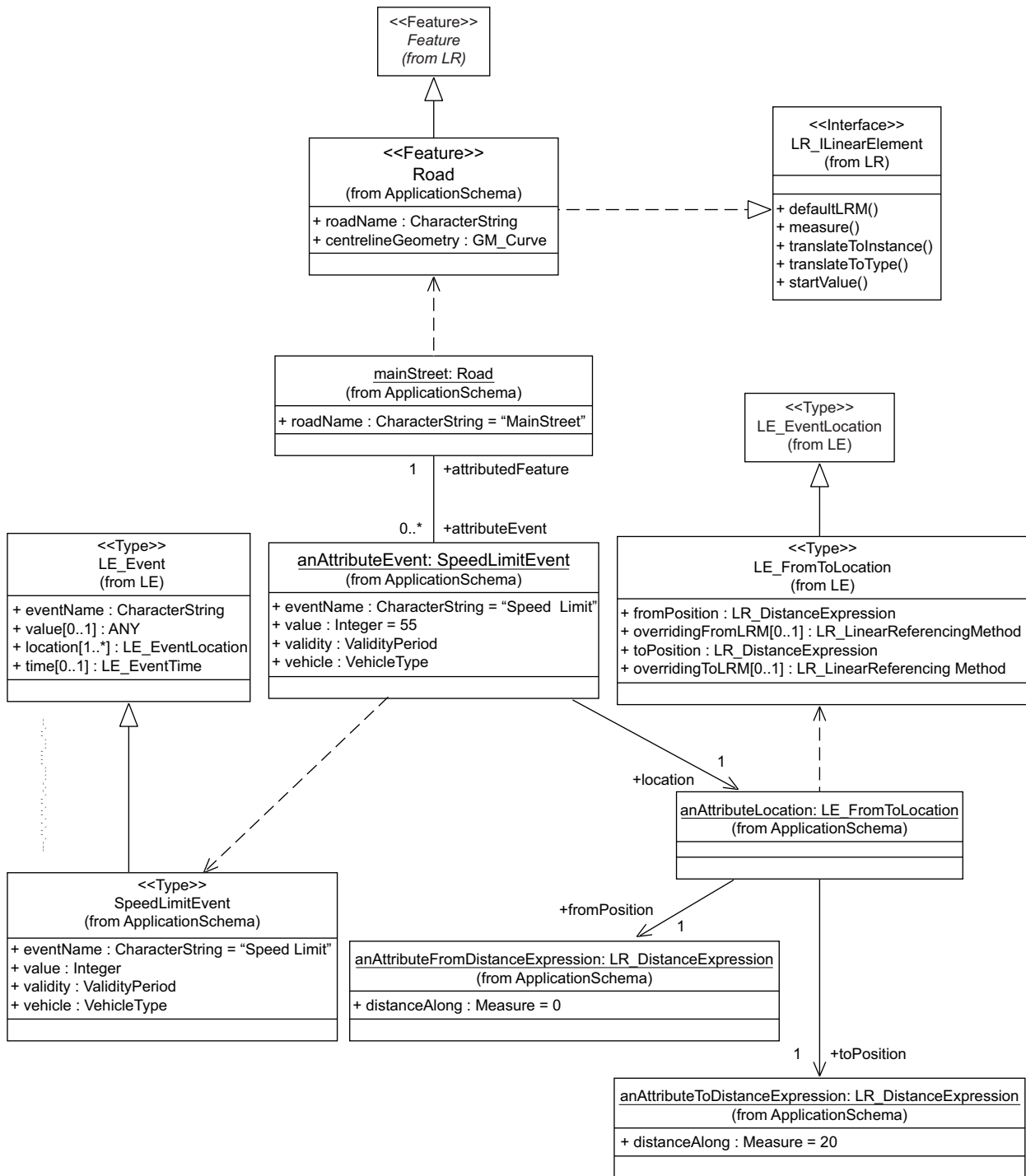

Figure D.2 — Attribute event example

D.3 Linear segmentation example

Consider the example in Figure D.3. The feature being segmented represents Route 66. It is 10 miles long. The first 4 miles have a pavement type of asphalt and the rest is concrete. The first 6 miles have a speed limit of 45 m/h and the remainder is 55 m/h.

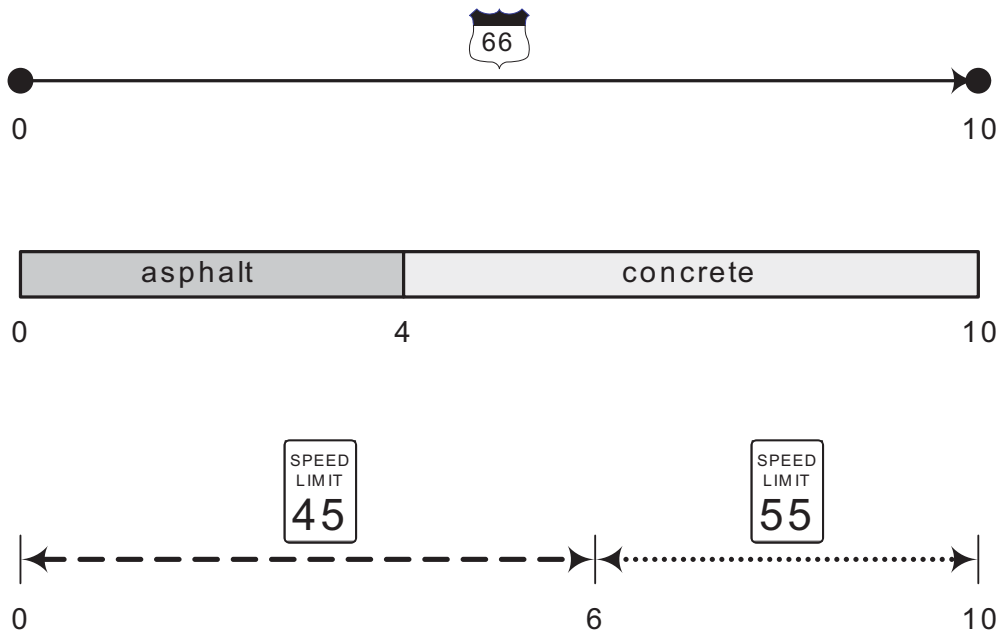

Figure D.3 — Segmentation example

This can be represented as four from/to attribute events:

from/to attribute event
 name = "pavement type"
 value = "asphalt"
 from position = 0
 to position = 4

from/to attribute event
 name = "pavement type"
 value = "concrete"
 from position = 4
 to position = 10

from/to attribute event
 name = "speed limit"
 value = 45
 from position = 0
 to position = 6

from/to attribute event
 name = "speed limit"
 value = 55
 from position = 6
 to position = 10

Segmenting Route 66 on pavement type results in a linear segment set with an event name equal to "pavement type". This set would contain two linear segments, as shown in Figure D.4.

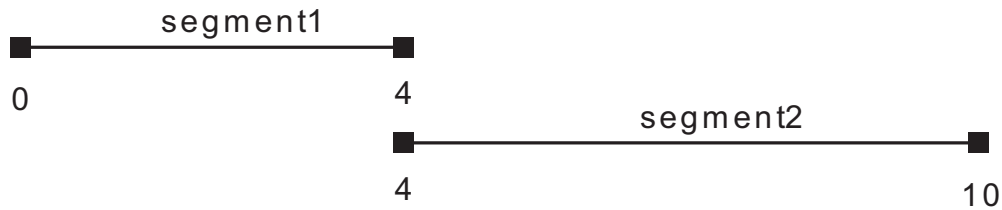

Figure D.4 — Linear segment set for pavement type

The two linear segments are

linear segment

start feature location = 0

end feature location = 4

attribute value

name = "pavement type"

value = "asphalt"

linear segment

start feature location = 4

end feature location = 10

attribute value

name = "pavement type"

value = "concrete"

Segmenting Route 66 on both pavement type and speed limit results in a linear segment set with event names equal to "pavement type" and "speed limit". This set contains three linear segments, as shown in Figure D.5.

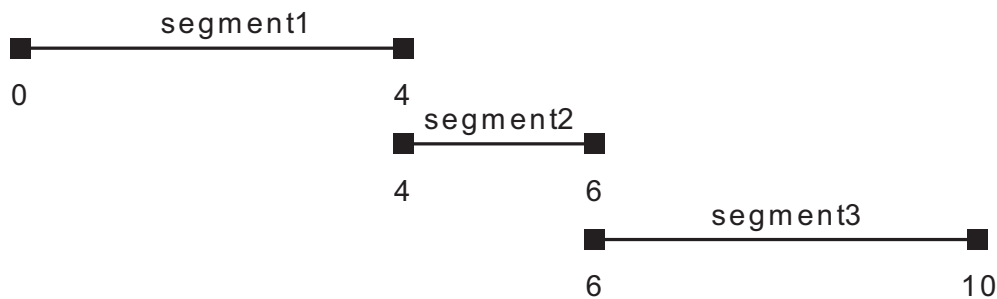

Figure D.5 — Linear segment set for pavement type and speed limit

The three linear segments are

linear segment

start feature location = 0

end feature location = 4

attribute value

name = "pavement type"

value = "asphalt"

attribute value

name = "speed limit"

value = 45

linear segment

start feature location = 4

end feature location = 6

attribute value

name = "pavement type"

value = "concrete"

attribute value

name = "speed limit"

value = 45

linear segment

start feature location = 6

end feature location = 10

attribute value

name = "pavement type"

value = "concrete"

attribute value

name = "speed limit"

value = 55

Bibliography

- [1] National Cooperative Highway Research Program (NCHRP), 1974, *Highway Location Reference Methods*, Synthesis of Highway Practice 21, National Academy of Sciences, Washington, DC
- [2] GUO, B. and EKURT, C., Towards Temporal Dynamic Segmentation, *Geoinformatica*, 8(3), 2004
- [3] SCARPONCINI, P., 2002, Generalized Model for Linear Referencing in Transportation, *Geoinformatica*, 6(1): pp. 35-55
- [4] VONDEROHE, A., CHOU, C., SUN, F. and ADAMS, T. *Results of a Workshop on A Generic Data Model for Linear Referencing Systems*, Proceedings Geographic Information Systems for Transportation Symposium (GIS-T), April 2-5, 1995, Sparks, Nevada, pp. 23-56
- [5] SCARPONCINI, P., 1995, *A Method for Determining a Standard Linear Referencing Scheme*, Proceedings Geographic Information Systems for Transportation Symposium (GIS-T), April 2-5, 1995, Sparks, Nevada, 1-22
- [6] ISO 19109, *Geographic information — Rules for application schema*
- [7] ISO 19123, *Geographic information — Schema for coverage geometry and functions*
- [8] ISO 19133:2005, *Geographic information — Location-based services — Tracking and navigation*
- [9] ISO 14825, *Intelligent transport systems — Geographic Data Files (GDF) — GDF5.0*
- [10] UK Highways Agency, *Area Management Memorandum no. 46/04*, internal published document used with the permission of the agency
- [11] ISO 19101:2002, *Geographic information — Reference model*
- [12] ISO 19112:2003, *Geographic information — Spatial referencing by geographic identifiers*
- [13] ISO 19118, *Geographic information — Encoding*
- [14] ISO 19141, *Geographic information — Schema for moving features*

© 2010 International Organization for Standardization

ICS 35.240.70

Price based on 86 pages