**Intelligent transport systems — Lane
change decision aid systems (LCDAS) —
Performance requirements and test
procedures**

*Systèmes intelligents de transport — Systèmes d'aide à la décision de
changement de voie — Exigences de performances et méthodes
d'essai*



Reference number
ISO 17387:2008(E)

© ISO 2008

PDF disclaimer

This PDF file may contain embedded typefaces. In accordance with Adobe's licensing policy, this file may be printed or viewed but shall not be edited unless the typefaces which are embedded are licensed to and installed on the computer performing the editing. In downloading this file, parties accept therein the responsibility of not infringing Adobe's licensing policy. The ISO Central Secretariat accepts no liability in this area.

Adobe is a trademark of Adobe Systems Incorporated.

Details of the software products used to create this PDF file can be found in the General Info relative to the file; the PDF-creation parameters were optimized for printing. Every care has been taken to ensure that the file is suitable for use by ISO member bodies. In the unlikely event that a problem relating to it is found, please inform the Central Secretariat at the address given below.



COPYRIGHT PROTECTED DOCUMENT

© ISO 2008

All rights reserved. Unless otherwise specified, no part of this publication may be reproduced or utilized in any form or by any means, electronic or mechanical, including photocopying and microfilm, without permission in writing from either ISO at the address below or ISO's member body in the country of the requester.

ISO copyright office
Case postale 56 • CH-1211 Geneva 20
Tel. + 41 22 749 01 11
Fax + 41 22 749 09 47
E-mail copyright@iso.org
Web www.iso.org

Published in Switzerland

Contents

Page

Foreword.....	iv
Introduction	v
1 Scope	1
2 Terms and definitions.....	1
3 Classification.....	4
3.1 Coverage zone classification	4
3.2 Target vehicle closing speed classification.....	5
4 Functional requirements	8
4.1 LCDAS state diagram	8
4.2 System performance	10
4.3 User interface	15
4.4 Operation with trailers.....	16
4.5 Self-test requirements	16
5 Test requirements.....	16
5.1 Test target vehicle	16
5.2 Environmental conditions.....	16
5.3 Blind spot warning test requirements	16
5.4 Closing vehicle warning test requirements	24
5.5 Lane change warning test requirements.....	29
Annex A (informative) Blind spot warning example cases	34
Bibliography	49

Foreword

ISO (the International Organization for Standardization) is a worldwide federation of national standards bodies (ISO member bodies). The work of preparing International Standards is normally carried out through ISO technical committees. Each member body interested in a subject for which a technical committee has been established has the right to be represented on that committee. International organizations, governmental and non-governmental, in liaison with ISO, also take part in the work. ISO collaborates closely with the International Electrotechnical Commission (IEC) on all matters of electrotechnical standardization.

International Standards are drafted in accordance with the rules given in the ISO/IEC Directives, Part 2.

The main task of technical committees is to prepare International Standards. Draft International Standards adopted by the technical committees are circulated to the member bodies for voting. Publication as an International Standard requires approval by at least 75 % of the member bodies casting a vote.

Attention is drawn to the possibility that some of the elements of this document may be the subject of patent rights. ISO shall not be held responsible for identifying any or all such patent rights.

ISO 17387 was prepared by Technical Committee ISO/TC 204, *Intelligent transport systems*.

Introduction

Lane Change Decision Aid Systems (LCDAS) warn the driver against collisions that may occur due to a lane change manoeuvre. LCDAS are intended to supplement the vehicle's interior and exterior rear-view mirrors, not eliminate the need for such mirrors. LCDAS are intended to detect vehicles to the rear and sides of the subject vehicle (see Figure 1). When the subject vehicle driver indicates the desire to make a lane change, the system evaluates the situation and warns the driver if a lane change is not recommended. LCDAS are not meant to encourage aggressive driving. The absence of a warning will not guarantee that the driver can safely make a lane change manoeuvre. The system will not take any automatic action to prevent possible collisions. Responsibility for the safe operation of the vehicle remains with the driver.

NOTE Many figures in this document show vehicles on roadways with lane markings. This is not meant to imply that lane marking recognition or lane detection is required for an LCDAS. The lane markings are drawn for reference only.

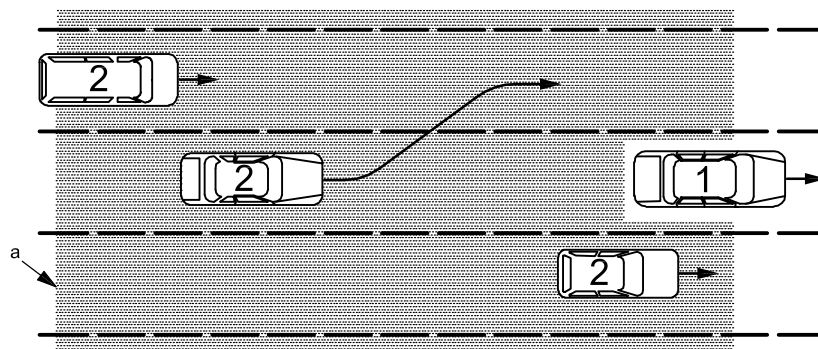

Key

- 1 subject vehicle
- 2 target vehicles

^a The shaded area illustrates the concept of one possible system. The actual requirements are given in Clause 4.

Figure 1 — LCDAS concept

Intelligent transport systems — Lane change decision aid systems (LCDAS) — Performance requirements and test procedures

1 Scope

This International Standard specifies system requirements and test methods for Lane Change Decision Aid Systems (LCDAS). LCDAS are fundamentally intended to warn the driver of the subject vehicle against potential collisions with vehicles to the side and/or to the rear of the subject vehicle, and moving in the same direction as the subject vehicle during lane change manoeuvres. This standardization addresses LCDAS for use on forward moving cars, vans and straight trucks in highway situations.

This standardization does not address LCDAS for use on motorcycles or articulated vehicles such as tractor/trailer combinations and articulated buses.

2 Terms and definitions

For the purpose of this document, the following terms and definitions apply.

NOTE The figures illustrating the coverage zone definitions show the zone concept only. The actual requirements are given in 4.2.

2.1

subject vehicle

vehicle equipped with the system in question and related to the topic of discussion

2.2

LCDAS target vehicle

any vehicle that is closing in on the subject vehicle from behind, or any vehicle that is located in one of the adjacent zones

NOTE An LCDAS target vehicle is referred to as “target vehicle” in this document.

2.3

coverage zone

entire area to be monitored by an LCDAS, a system’s coverage zone consisting of a specific subset of the following zones: left adjacent zone, right adjacent zone, left rear zone and right rear zone

NOTE A target vehicle located within the coverage zone will thus be detected by the system.

2.4

adjacent zones

zones to the left and right of the subject vehicle

See Figure 2.

NOTE The adjacent zones are intended to cover the lanes adjacent to the subject vehicle. However, the position and size of the adjacent zones are defined with respect to the subject vehicle, and are independent of any lane markings.

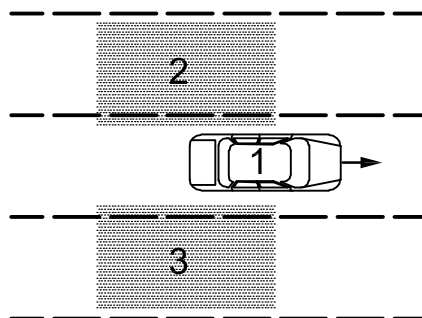

Key

- 1 subject vehicle
- 2 left adjacent zone
- 3 right adjacent zone

Figure 2 — Adjacent zones

2.5

rear zones

zones that are behind and to the sides of the subject vehicle

See Figure 3.

NOTE The rear zones are intended to cover the lanes adjacent to the subject vehicle. However, the position and size of the rear zones are defined with respect to the subject vehicle, and are independent of any lane markings.

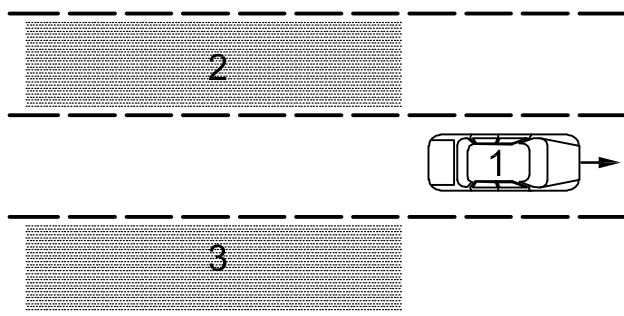

Key

- 1 subject vehicle
- 2 left rear zone
- 3 right rear zone

Figure 3 — Zones

2.6

lateral clearance

(of a target vehicle) lateral distance between the side of the subject vehicle and the near side of a target vehicle

See Figure 4.

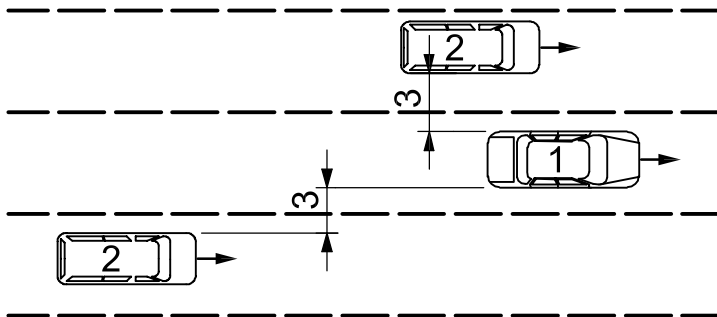

Key

- 1 subject vehicle
- 2 target vehicle
- 3 lateral clearance

Figure 4 — Lateral clearance

2.7

rear clearance

(of a target vehicle) distance between the rear of the subject vehicle and the front of the target vehicle as measured along a straight line, or optionally, as estimated along the target vehicle's estimated path

See Figures 5 a) to 5 d).

NOTE This definition applies to target vehicles in the rear zones only.

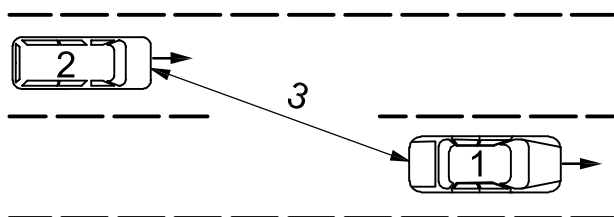

a) On a straight road measured along a straight line

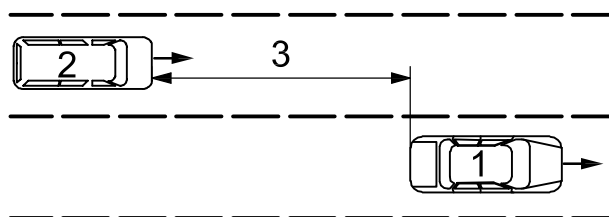

b) On a straight road estimated along target vehicle path

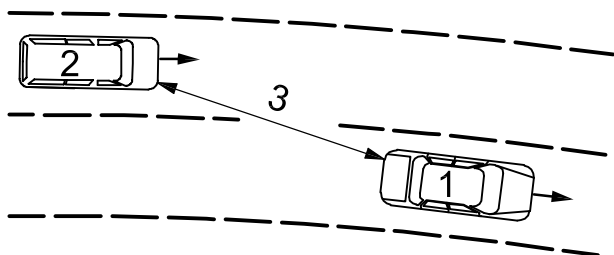

c) On a curved road measured along a straight line

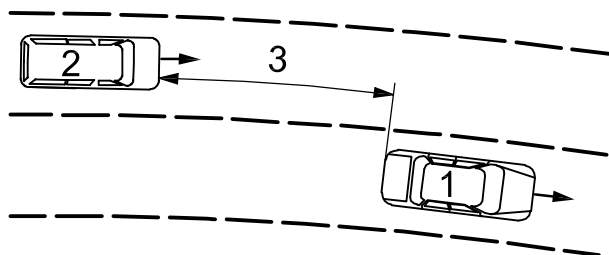

d) On a curved road estimated along target vehicle path

Key

- 1 subject vehicle
- 2 target vehicle
- 3 rear clearance

Figure 5 — Examples of rear clearance

2.8
closing speed

(of a target vehicle) difference between the target vehicle's speed and the subject vehicle's speed

NOTE This definition applies to target vehicles in the rear zones only. A positive closing speed indicates that the target vehicle is closing in on the subject vehicle from the rear.

2.9
time to collision

estimated time that it would take a target vehicle to collide with the subject vehicle if the subject vehicle were in the target vehicle's path and the target vehicle's current closing speed remained constant

NOTE Time to collision can be estimated by dividing a target vehicle's rear clearance by its closing speed. This definition applies to target vehicles in the rear zones only.

2.10
overtaking speed

(of the subject vehicle) difference between the subject vehicle's speed and the target vehicle's speed when the subject vehicle is overtaking the target vehicle

NOTE A positive overtaking speed indicates that the subject vehicle is moving faster than the target vehicle.

2.11
blind spot warning function

function that detects the presence of target vehicles in one or more of the adjacent zones and warns the subject vehicle driver in accordance with the requirements given in Clause 4

2.12
closing vehicle warning function

function that detects closing vehicles in one or more of the rear zones and warns the driver in accordance with the requirements given in Clause 4

2.13
lane change warning function

function that includes the blind spot warning function and the closing vehicle warning function

2.14
roadway radius of curvature

horizontal radius of curvature of the road on which the subject vehicle is travelling

3 Classification

3.1 Coverage zone classification

3.1.1 General

LCDAS are classified by the minimum required coverage as shown in Table 1; for example, a Type I system shall provide coverage of at least the left and right adjacent zones.

Table 1 — Coverage zone classification

Type	Left adjacent zone coverage	Right adjacent zone coverage	Left rear zone coverage	Right rear zone coverage	Function
I	X	X			Blind spot warning
II			X	X	Closing vehicle warning
III	X	X	X	X	Lane change warning

3.1.2 Type I systems

Type I systems provide the blind spot warning function only. These systems are intended to warn the subject vehicle driver of target vehicles in the adjacent zones. These systems are not required to provide warnings of target vehicles that are approaching the subject vehicle from the rear. The subject vehicle driver shall be made aware of the limitations of this type of system, at least in the owner's manual. In particular, the owner's manual shall include the following statement: "This system provides support only within a limited area beside the vehicle. The system may not provide adequate warning for vehicles approaching from the rear."

3.1.3 Type II systems

Type II systems provide the closing vehicle warning function only. These systems are intended to warn the subject vehicle driver of target vehicles that are approaching the subject vehicle from the rear. Because these systems are not required to provide warnings of target vehicles located adjacent to the subject vehicle, Type II systems are recommended for use on vehicles that have side mirrors with a horizontal field of view of at least 45° on both sides of the vehicle. If these systems are used on other vehicles, the owner's manual shall include the following statement: "The driver must turn and look into the adjacent area before attempting a lane change." The subject vehicle driver shall be made aware of the limitations of this type of system, at least in the owner's manual. In particular, the owner's manual shall include the following statement: "This system provides no support for the areas adjacent to the subject vehicle. This system may not provide adequate warning for very fast moving vehicles approaching from the rear."

3.1.4 Type III systems

Type III systems provide the blind spot warning function and the closing vehicle warning function. These systems are intended to warn the subject vehicle driver of target vehicles in the adjacent zones and target vehicles which are approaching the subject vehicle from the rear. The subject vehicle driver shall be made aware of the limitations of this type of system, at least in the owner's manual. In particular, the owner's manual shall include the following statement: "This system may not provide adequate warning for very fast moving vehicles approaching from the rear."

3.2 Target vehicle closing speed classification

3.2.1 General

LCDAS of Types II and III are classified by the maximum target vehicle closing speed and the minimum roadway radius of curvature as shown in Table 2. A system may belong to more than one of the types listed in Table 2. For example, a highly capable system may meet or exceed the minimum requirements defined individually for Types A, B and C.

Table 2 — Target vehicle closing speed classification

Type	Maximum target vehicle closing speed	Minimum roadway radius of curvature
	m/s	m
A	10	125
B	15	250
C	20	500

NOTE The maximum target vehicle closing speed has a direct effect on the required sensor range and/or acquisition time. A higher closing speed will require a longer sensor range and/or a shorter acquisition time in order to detect the target vehicle quickly enough to give the subject vehicle driver adequate warning. In addition, there is a relationship between the maximum target vehicle closing speed and the roadway radius of curvature. For a given curve radius and a typical subject vehicle speed, the closing speed of a target vehicle is limited by driving dynamics parameters.

3.2.2 Type A systems

Figure 6 shows the minimum required region of performance with regard to roadway radius of curvature and target vehicle closing speed for a Type A system. These systems may be capable of operating on curved roads with smaller radii. The subject vehicle driver shall be made aware of the limitations of the system, at least in the owner’s manual. In particular, the owner’s manual shall include the following statement: “This system may not provide adequate warning on curves tighter than X metres radius” where X is replaced by the tightest curve radius for which the system is designed but not more than 125 m.

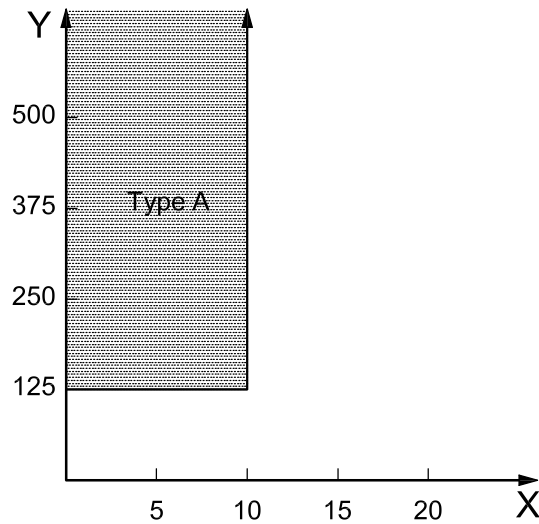

Key

- X target vehicle closing speed, m/s
- Y roadway radius of curvature, m

Figure 6 — Type A system minimum region of performance

3.2.3 Type B systems

Figure 7 shows the minimum required region of performance with regard to roadway radius of curvature and target vehicle closing speed for a Type B system. These systems may be capable of operating on curved roads with smaller radii. The subject vehicle driver shall be made aware of the limitations of the system, at least in the owner’s manual. In particular, the owner’s manual shall include the following statement: “This system may not provide adequate warning on curves tighter than X metres radius” where X is replaced by the tightest curve radius for which the system is designed but not more than 250 m.

.....

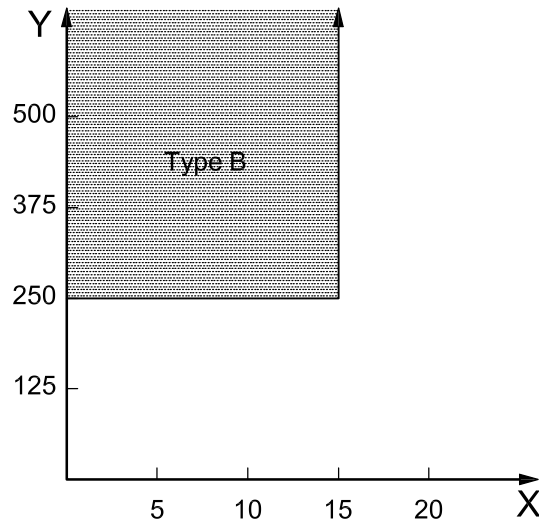
**Key**

- X target vehicle closing speed, m/s
 Y roadway radius of curvature, m

Figure 7 — Type B system minimum region of performance

3.2.4 Type C systems

Figure 8 shows the minimum required region of performance with regard to roadway radius of curvature and target vehicle closing speed for a Type C system. These systems may be capable of operating on curved roads with smaller radii. The subject vehicle driver shall be made aware of the limitations of the system, at least in the owner's manual. In particular, the owner's manual shall include the following statement: "This system may not provide adequate warning on curves tighter than X metres radius" where X is replaced by the tightest curve radius for which the system is designed but not more than 500 m.

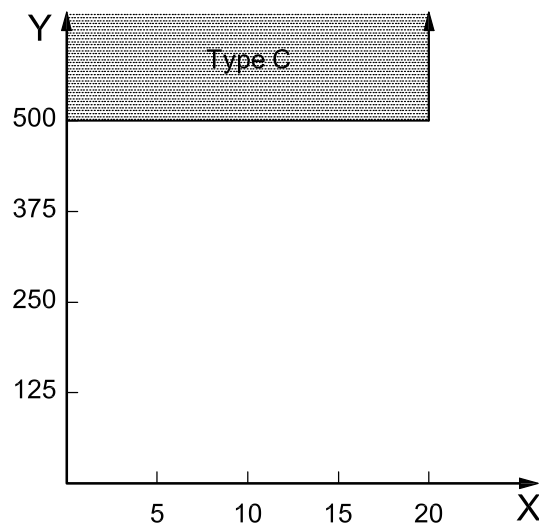
**Key**

- X target vehicle closing speed, m/s
 Y roadway radius of curvature, m

Figure 8 — Type C system minimum region of performance

4 Functional requirements

4.1 LCDAS state diagram

4.1.1 General

LCDAS shall at a minimum operate according to the state diagram in Figure 9.

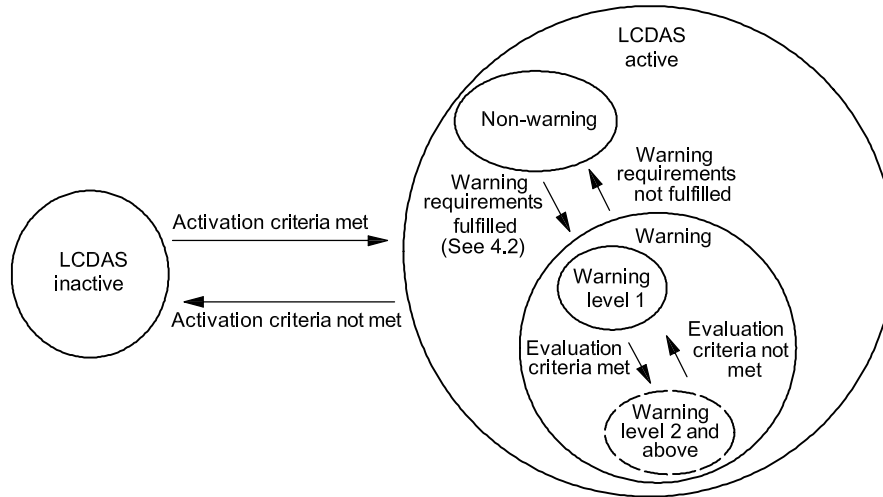

Figure 9 — LCDAS state diagram

4.1.2 LCDAS inactive state

In the LCDAS inactive state the system shall give no warnings to the driver. This state may be a power off state or a ready state. In a ready state the system may detect target vehicles, but shall not issue warnings because the activation criteria are not met.

4.1.3 Activation criteria

4.1.3.1 General

When activated, the LCDAS shall transition from the LCDAS inactive state to the LCDAS active state. Several activation criteria may be used at the same time. Potential activation criteria include but are not limited to the following.

4.1.3.2 Continuous activation

The system may be active continuously (whenever the subject vehicle's ignition is on).

4.1.3.3 Manual switch activation

The system may be activated manually, e.g. by a toggle switch, a tip switch or a menu-based user interface.

4.1.3.4 Turn signal activation

The system may be activated based on the subject vehicle turn signal status. For instance, if the left turn signal is on, the system may be activated on the left side of the subject vehicle, while remaining inactive on the right side of the subject vehicle.

4.1.3.5 Subject vehicle speed activation

The system may be activated based on the subject vehicle speed. If this is the case, then when the subject vehicle speed is greater than or equal to a certain threshold speed the system will transition to the LCDAS active state. The threshold speed shall be no more than 16,7 m/s (60 km/h).

4.1.4 LCDAS active state

4.1.4.1 General

In the LCDAS active state the system shall detect target vehicles.

4.1.4.2 Non-warning state

In the non-warning state the system is active, but the warning requirements are not fulfilled.

4.1.4.3 Warning state

4.1.4.3.1 General

In the warning state the system is active and the warning requirements are fulfilled.

4.1.4.3.2 Warning level 1 state

In the warning level 1 state the warning requirements are fulfilled but no evaluation criteria are met. The warning given to the driver in this state shall be a cautionary warning, which is less urgent than the warnings given in warning level 2 and any subsequent warning levels.

4.1.4.3.3 Evaluation criteria

4.1.4.3.3.1 General

Evaluation criteria are certain parameters that an LCDAS may monitor. Evaluation criteria should be useful in determining the driver's intention for changing the lane of travel. If one or more of these evaluation criteria are met, then the system may transition from the warning level 1 state to warning level 2 and above. Several evaluation criteria may be used at the same time. Potential evaluation criteria include but are not limited to the following.

4.1.4.3.3.2 Turn signal evaluation

The system may evaluate the subject vehicle turn signal status. For instance, if the left turn signal is on, the system may transition to warning level 2 or higher on the left side of the subject vehicle, while not affecting the right side of the subject vehicle.

4.1.4.3.3.3 Subject vehicle steering input evaluation

The system may evaluate the steering input by the subject vehicle driver. If, for instance, the system determines that the driver is initiating a lane change to the left, the system may transition to warning level 2 or higher on the left side of the subject vehicle, while not affecting the right side of the subject vehicle.

4.1.4.3.3.4 Subject vehicle lane position evaluation

The system may evaluate the subject vehicle's position and/or lateral motion within its lane. If, for instance, the system determines that the subject vehicle is moving toward or into the lane to the left, the system may transition to warning level 2 or higher on the left side of the subject vehicle, while not affecting the right side of the subject vehicle.

4.1.4.3.3.5 Lateral clearance evaluation

The system may evaluate the lateral clearance to a target vehicle. If the system has the ability to measure lateral clearance, then when the lateral clearance is less than a preset threshold value the system may transition to warning level 2 or higher.

4.1.4.3.4 Warning level 2 and above

Warning level 2 and above are optional states. In these states the warning requirements are fulfilled and one or more evaluation criteria are met. The warnings given to the driver in these states shall be imminent warnings that are more urgent than the warning given in the warning level 1 state.

4.2 System performance

4.2.1 General

The following lines, illustrated in Figure 10, are needed for the description of the blind spot warning requirements and the closing vehicle warning requirements. The designations right, left and behind refer to the driving direction of the subject vehicle. The lane markings in Figure 10 are shown for reference only. All dimensions are given with respect to the subject vehicle.

- Line A shall be parallel to the trailing edge of the subject vehicle and a distance of 30,0 meters behind it.
- Line B shall be parallel to the trailing edge of the subject vehicle and a distance of 3,0 meters behind it.
- Line C shall be parallel to the leading edge of the subject vehicle and located at the centre of the 95th percentile eyellipse.
- Line D shall be the extension in both directions of the leading edge of the subject vehicle.
- Line E shall be parallel to the centreline of the subject vehicle and located at the left outermost edge of the subject vehicle's body excluding the exterior mirror.
- Line F shall be parallel to the centreline of the subject vehicle and a distance of 0,5 meter to the left of the left outermost edge of the subject vehicle's body.
- Line G shall be parallel to the centreline of the subject vehicle and a distance of 3,0 meters to the left of the left outermost edge of the subject vehicle's body.
- Line H shall be parallel to the centreline of the subject vehicle and a distance of 6,0 meters to the left of the left outermost edge of the subject vehicle's body.
- Line J shall be parallel to the centreline of the subject vehicle and located at the right outermost edge of the subject vehicle's body excluding the exterior mirror.
- Line K shall be parallel to the centreline of the subject vehicle and a distance of 0,5 meter to the right of the right outermost edge of the subject vehicle's body.
- Line L shall be parallel to the centreline of the subject vehicle and a distance of 3,0 meters to the right of the right outermost edge of the subject vehicle's body.
- Line M shall be parallel to the centreline of the subject vehicle and a distance of 6,0 meters to the right of the right outermost edge of the subject vehicle's body.
- Line N shall be the extension in both directions of the trailing edge of the subject vehicle.
- Line O shall be parallel to the trailing edge of the subject vehicle and a distance of 10,0 meters behind it.

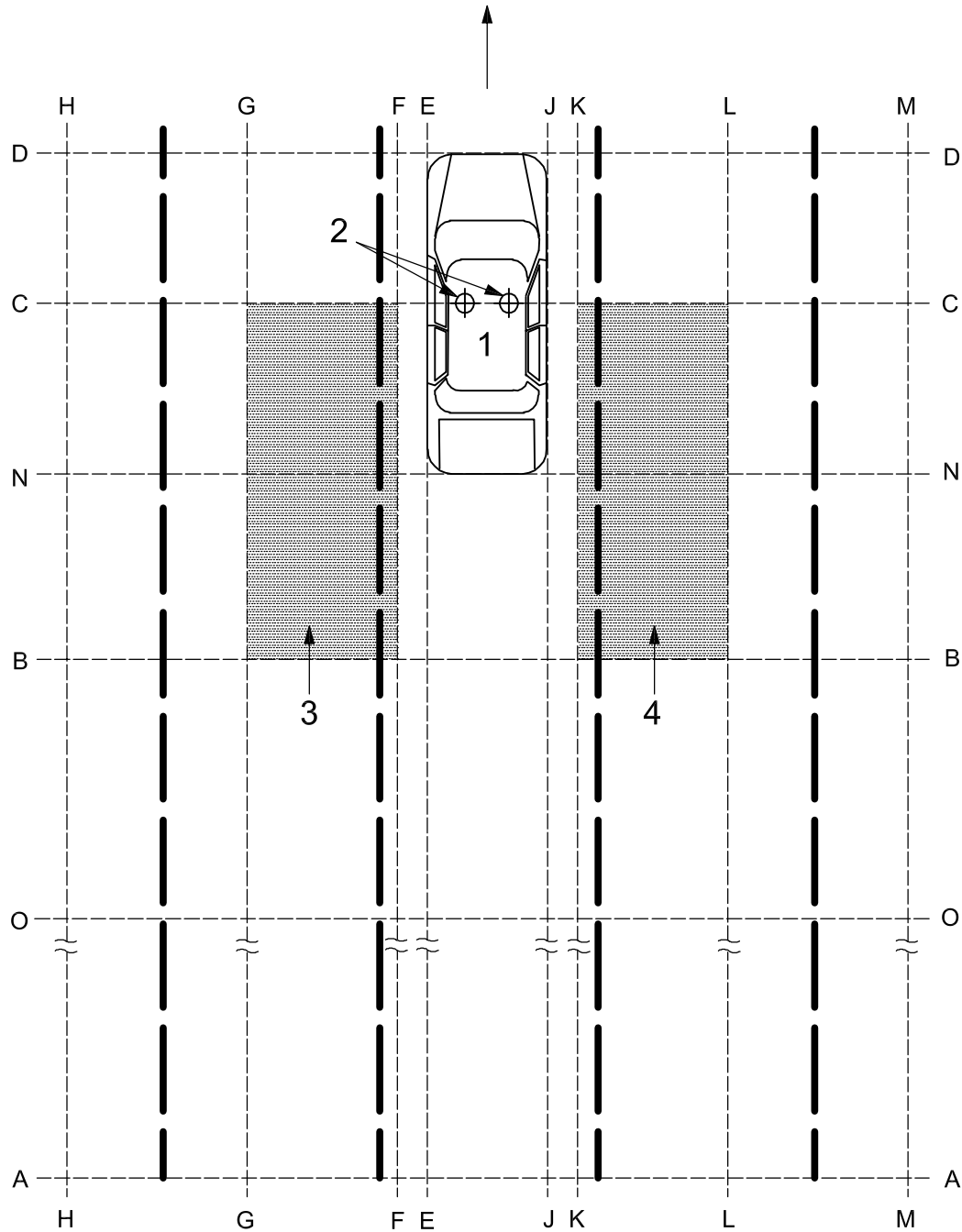

Key

- 1 subject vehicle
- 2 centre of the 95th percentile eyellipse
- 3 left adjacent zone
- 4 right adjacent zone

Figure 10 — Warning requirements diagram

4.2.2 Minimum detectable target vehicle

LCDAS shall be capable of detecting target vehicles that are at least the size of a highway-legal motorcycle with a rider.

4.2.3 Requirements for the blind spot warning function

4.2.3.1 Warning requirements for the blind spot warning function

4.2.3.1.1 General

The blind spot warning function shall provide coverage of the left and right adjacent zones. The lines illustrated in Figure 10 are needed for the description of the blind spot warning requirements.

NOTE The adjacent zone coverage is intended to supplement the mirror coverage of the subject vehicle.

4.2.3.1.2 Left side blind spot warning requirements

Referring to Figure 10, a left side blind spot warning shall be issued to the subject vehicle driver if a target vehicle satisfies all of the following conditions:

- any part of the target vehicle is forward of line B;
- the target vehicle is entirely behind line C;
- the target vehicle is entirely to the left of line F;
- any part of the target vehicle is to the right of line G.

If the zone defined by lines A, D, E and H does not contain target vehicles nor any parts thereof then a left side blind spot warning shall not be issued.

See Annex A for blind spot warning example cases.

4.2.3.1.3 Right side blind spot warning requirements

Referring to Figure 10, a right side blind spot warning shall be issued to the subject vehicle driver if a target vehicle satisfies all of the following conditions:

- any part of the target vehicle is forward of line B;
- the target vehicle is entirely behind line C;
- the target vehicle is entirely to the right of line K;
- any part of the target vehicle is to the left of line L.

If the zone defined by lines A, D, J and M does not contain target vehicles nor any parts thereof then a right side blind spot warning shall not be issued.

See Annex A for blind spot warning example cases.

4.2.3.2 Optional blind spot warning suppression

If the subject vehicle is overtaking the target vehicle and the target vehicle has entered the adjacent zone from the front, the blind spot warning may be suppressed for a period of no more than 2 s after the blind spot warning is first required.

.....

4.2.4 Requirements for the closing vehicle warning function

4.2.4.1 Warning requirements for the closing vehicle warning function

4.2.4.1.1 General

The closing vehicle warning function shall provide coverage of the left and right rear zones. The lines illustrated in Figure 10 are needed for the description of the warning requirements. For systems having the ability to estimate the geometry of the roadway, these lines may be defined to follow the curvature of the roadway.

4.2.4.1.2 Left side closing vehicle warning requirements

Referring to Figure 10, a left side closing vehicle warning shall be issued to the subject vehicle driver if a target vehicle satisfies all of the following conditions:

- the target vehicle is entirely behind line B;
- the target vehicle is entirely to the left of line F;
- any part of the target vehicle is to the right of line G;
- the target vehicle's estimated time to collision is less than or equal to the value given in Table 3.

Table 3 — Closing vehicle warning time to collision by target vehicle closing speed classification

Type	Maximum target vehicle closing speed for full performance	Time to collision
	m/s	s
A	10	2,5
B	15	3,0
C	20	3,5

For target vehicles in the left rear zone behind line A, a left side closing vehicle warning shall not be issued if all target vehicles have estimated times to collision of 7,5 s or more.

For target vehicles located on or forward of line A, a left side closing vehicle warning shall not be issued if either of the following conditions is true:

- the target vehicle is entirely forward of line N;
- no part of the target vehicle is located in the area between lines E and H.

4.2.4.1.3 Right side closing vehicle warning requirements

Referring to Figure 10, a right side closing vehicle warning shall be issued to the subject vehicle driver if a target vehicle satisfies all of the following conditions:

- the target vehicle is entirely behind line B;
- the target vehicle is entirely to the right of line K;
- any part of the target vehicle is to the left of line L;
- the target vehicle's estimated time to collision is less than or equal to the value given in Table 3.

For target vehicles in the right rear zone behind line A, a right side closing vehicle warning shall not be issued if all target vehicles have estimated times to collision of 7,5 s or more.

For target vehicles located on or forward of line A, a right side closing vehicle warning shall not be issued if either of the following conditions is true:

- the target vehicle is entirely forward of line N;
- no part of the target vehicle is located in the area between lines J and M.

4.2.4.1.4 Optional dual side closing vehicle warning

Referring to Figure 10, simultaneous closing vehicle warnings may be issued on both sides of the subject vehicle if a target vehicle satisfies all of the following conditions:

- a left side closing vehicle warning is not currently required (see 4.2.4.1.2);
- a right side closing vehicle warning is not currently required (see 4.2.4.1.3);
- any part of the target vehicle is between lines E and J;
- the target vehicle is entirely behind line O;
- the target vehicle’s estimated time to collision is less than or equal to the value given in Table 3.

4.2.4.2 Optional closing vehicle information

Visual information pertaining to one or more target vehicles (e.g. target vehicle location, closing speed, etc.) may be presented to the subject vehicle driver at any time provided that this information is clearly distinguishable from a warning indication.

4.2.5 Requirements for the lane change warning function

4.2.5.1 Warning requirements for the lane change warning function

The warning requirements for the lane change warning function consist of the combination of the warning requirements for the blind spot warning function and the warning requirements for the closing vehicle warning function. For a given situation, the blind spot warning requirements will give one of the following results: shall give warning, might give warning, shall not give warning. For the same situation, the closing vehicle warning requirements will also give one of the following results: shall give warning, might give warning, shall not give warning. Based on these two results, the lane change warning function shall give warnings according to Table 4.

Table 4 — Lane change warning requirements

	Shall give blind spot warning	Might give blind spot warning	Shall not give blind spot warning
Shall give closing vehicle warning	Shall give lane change warning	Shall give lane change warning	Shall give lane change warning
Might give closing vehicle warning	Shall give lane change warning	Might give lane change warning	Might give lane change warning
Shall not give closing vehicle warning	Shall give lane change warning	Might give lane change warning	Shall not give lane change warning

4.2.6 System response time

The overall system response time from the time at which a target satisfies the warning requirements to the time that the warning indication is activated shall be no more than 300 ms.

The overall system response time from the time at which a warning is no longer allowed to the time that the warning indication is deactivated shall be no more than 1 s.

4.3 User interface

4.3.1 LCDAS status indication

4.3.1.1 General

There are two possibilities of indicating the LCDAS status. The system shall use at least one of the following two possibilities: LCDAS driver selection indication or LCDAS active/inactive indication.

4.3.1.2 LCDAS driver selection indication

If the system can be manually activated and deactivated by the driver, then the driver's selection shall be indicated. This indication shall be visual. If the means to manually activate and deactivate the system is a switch, and the switch position is clearly understood by the driver, then the switch may be considered to be this indicator.

4.3.1.3 LCDAS active/inactive indication

The system shall indicate whether it is in the active or inactive state (see 4.1). This indication shall be visual.

4.3.2 LCDAS warning indication

4.3.2.1 General

A system warning shall indicate to the subject vehicle driver that a lane change manoeuvre will result in a threatening situation. Referring to 4.1, the LCDAS warning indication is active in the warning state.

4.3.2.2 LCDAS warning indication method

In the warning level 1 state (see 4.1) the system warning indication shall be visual only. In warning level 2 and above (see 4.1) the system warning indication may include visual, audible, and/or haptic warnings. It is recommended that warnings in some way indicate the side on which the target vehicle is present. It is recommended that visual warning indicators be placed in locations that will encourage mirror usage. Visual warnings should be clearly distinguishable from other visual information in the vehicle. If an audible warning is used, it should be clearly distinguishable from other audible signals in the vehicle. If a haptic warning is used, it should be clearly distinguishable from other haptic signals in the vehicle.

4.3.3 LCDAS failure indication

A failure indication shall indicate to the subject vehicle driver that the LCDAS self-test function (see 4.5) has detected a system malfunction.

The LCDAS failure indication shall be visual and/or audible, and shall clearly convey to the driver that there is a system malfunction.

4.4 Operation with trailers

The dimensions given in the LCDAS warning requirements are based upon the subject vehicle alone, without regard to any trailer that may be attached. If a trailer is attached to the subject vehicle the LCDAS shall operate according to one of the following options (ranked in order of preference).

- a) The system performs according to its normal capabilities.

NOTE The coverage provided by the system is not extended to account for the trailer.

- b) If the system is not able to perform according to its normal capabilities, then the system indicates to the driver that the system is unavailable or disabled.
- c) The system does not operate correctly; however, in this case the subject vehicle's owner's manual includes a notice stating that the system does not operate correctly while towing a trailer.

4.5 Self-test requirements

The system shall at a minimum provide the following self-test functions (at least after each system activation):

The system shall:

- check for proper function of the major electronic components;
- check for proper function of all sensor elements.

The system shall automatically execute the self-test functions listed above, and shall generate an LCDAS failure indication (see 4.3.3) whenever a fault condition is detected.

5 Test requirements

5.1 Test target vehicle

For each of the following tests, the test target vehicle shall be a motorcycle with a rider. The test target vehicle shall have the following dimensions. The length of the motorcycle shall be between 2,0 m and 2,5 m. The width of the motorcycle at its widest point (not including the side mirrors) shall be between 0,7 m and 0,9 m. The height of the motorcycle (not including the windscreen) shall be between 1,1 m and 1,5 m.

5.2 Environmental conditions

The test location shall be on a flat, dry asphalt or concrete surface. The ambient temperature during testing shall be within the range of $10\text{ °C} \pm 30\text{ °C}$. The horizontal visibility range shall be greater than 1 km.

5.3 Blind spot warning test requirements

5.3.1 General

Subclauses 5.3.2 and 5.3.3 describe the minimum test requirements for a blind spot warning system (LCDAS Type I).

5.3.2 Blind spot warning test measurement system

The test measurement system shall:

- be completely independent of the blind spot warning system being tested;
- be capable of measuring the longitudinal distance between the trailing edge of the subject vehicle and the leading edge of the test target vehicle, if the test target vehicle is to the rear of the subject vehicle;
- be capable of measuring the longitudinal distance between the leading edge of the subject vehicle and the trailing edge of the test target vehicle, if the test target vehicle is forward of the subject vehicle;
- be capable of measuring the lateral distance between the leftmost edge of the subject vehicle and the rightmost edge of the test target vehicle, if the test target vehicle is to the left of the subject vehicle;
- be capable of measuring the lateral distance between the rightmost edge of the subject vehicle and the leftmost edge of the test target vehicle, if the test target vehicle is to the right of the subject vehicle;
- be capable of measuring the time delay from the point at which the test target vehicle satisfies the warning conditions to the point at which a warning is issued;
- be capable of measuring the time delay from the point at which a warning is no longer allowed to the point at which the warning is terminated.

For all of the test procedures, the test measurement system shall be capable of the following accuracies.

- Distance measurement accuracy:
 - for distances less than 2 m the accuracy shall be 0,1 m or better;
 - for distances from 2 m to 10 m the accuracy shall be 5 % or better;
 - for distances greater than 10 m the accuracy shall be 0,5 m or better.
- Time measurement accuracy:
 - for times less than 200 ms the accuracy shall be 20 ms or better;
 - for times from 200 ms to 1 s the accuracy shall be 10 % or better;
 - for times greater than 1 s the accuracy shall be 100 ms or better.

5.3.3 Blind spot warning test procedures

5.3.3.1 General

During all of the following tests, all relevant activation criteria shall be met.

5.3.3.2 Target vehicle overtaking subject vehicle

The purpose of this test is to check that the blind spot warning system gives warnings when required as the target vehicle overtakes the subject vehicle. Referring to Figure 11 and the line definitions in 4.2, the test shall be conducted as follows.

On a straight, flat test course the subject vehicle shall be driven in a straight line at a minimum steady speed of 20 m/s. The test target vehicle shall be driven in a straight line as shown in Figure 11 so that its closing speed is between 1 m/s and 3 m/s. Both vehicles shall be driven such that the lateral distance between the outermost edge of the subject vehicle’s body (excluding the exterior mirror) and the centreline of the test target vehicle is 2,0 m to 3,0 m. To begin the test, the test target vehicle shall be completely behind line A.

As the test target vehicle approaches and overtakes the subject vehicle, the system shall meet the following test requirements.

- The system shall give no warnings while the test target vehicle is completely behind line A.
- After the test target vehicle crosses line A, the system shall initiate a warning on the correct side of the subject vehicle no later than the time at which the leading edge of the test target vehicle crosses line B plus the system response time given in 4.2.6.
- The system shall sustain the warning at least until the leading edge of the test target vehicle crosses line C.
- The system shall terminate the warning no later than after the time at which the trailing edge of the test target vehicle crosses line D plus the system response time given in section 4.2.6.

This test shall be repeated according to Table 5 for a total of twelve trials. During night time conditions, no illumination shall be provided other than the standard headlamps and tail lamps of the subject vehicle and test target vehicle. If it can be shown that the ambient light conditions have no effect on the system’s performance, then the tester may choose to perform either the daytime tests or the night time tests for a total of six trials.

Table 5 — Blind spot warning target overtaking subject test trials

	Day	Night
Test target to left of subject vehicle	3 trials	3 trials
Test target to right of subject vehicle	3 trials	3 trials

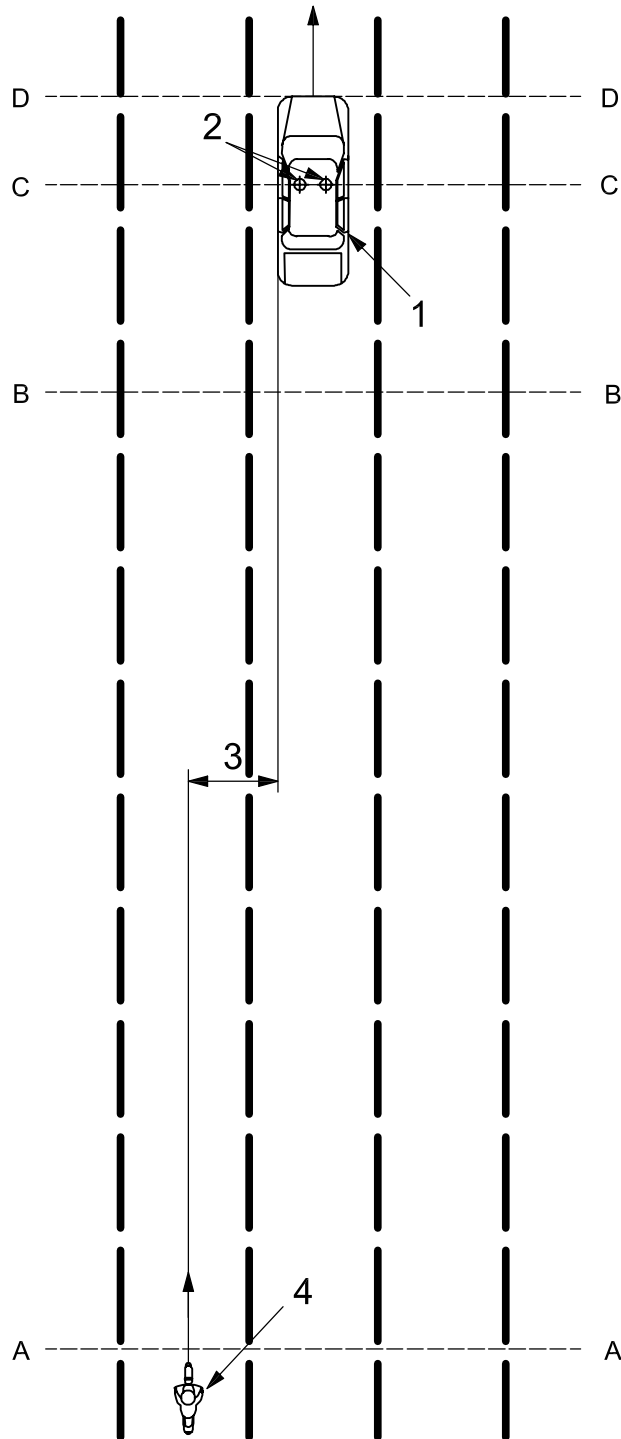

Key

- 1 subject vehicle
- 2 centre of the 95th percentile eyellipse
- 3 lateral distance
- 4 test target vehicle

Figure 11 — Target vehicle overtaking subject vehicle test

5.3.3.3 Subject vehicle overtaking target vehicle

The purpose of this test is to check that the blind spot warning system gives warnings when required as the subject vehicle overtakes the target vehicle. Referring to Figure 12 and the line definitions in 4.2, the test shall be conducted as follows.

On a straight, flat test course the test target vehicle shall be driven in a straight line at a minimum steady speed of 20 m/s. The subject vehicle shall be driven in a straight line as shown in Figure 12 so that its overtaking speed is between 1 m/s and 2 m/s. Both vehicles shall be driven such that the lateral distance between the outermost edge of the subject vehicle’s body (excluding the exterior mirror) and the centreline of the test target vehicle is 2,0 m to 3,0 m. To begin the test, the leading edge of the subject vehicle shall be behind the trailing edge of the test target vehicle.

As the subject vehicle approaches and overtakes the test target vehicle, the system shall meet the following test requirements.

- The system shall give no warnings whilst the test target vehicle is completely forward of line D.
- After the trailing edge of the test target vehicle crosses line D, the system shall initiate a warning on the correct side of the subject vehicle no later than after the time at which the leading edge of the test target vehicle crosses line C plus the system response time given in 4.2.6 plus the optional warning suppression time given in section 4.2.3.2.
- The system shall sustain the warning at least until the leading edge of the test target vehicle crosses line B.
- The system shall terminate the warning no later than after the time at which the leading edge of the test target vehicle crosses line A plus the system response time given in 4.2.6.

This test shall be repeated in accordance with Table 6 below for a total of twelve trials. During night time conditions, no illumination shall be provided other than the standard headlamps and tail lamps of the subject vehicle and test target vehicle. If it can be shown that the ambient light conditions have no effect on the system’s performance, then the tester may choose to perform either the daytime tests or the night time tests for a total of six trials.

Table 6 — Blind Spot Warning Subject Overtaking Target Test Trials

	Day	Night
Test target to left of subject vehicle	3 trials	3 trials
Test target to right of subject vehicle	3 trials	3 trials

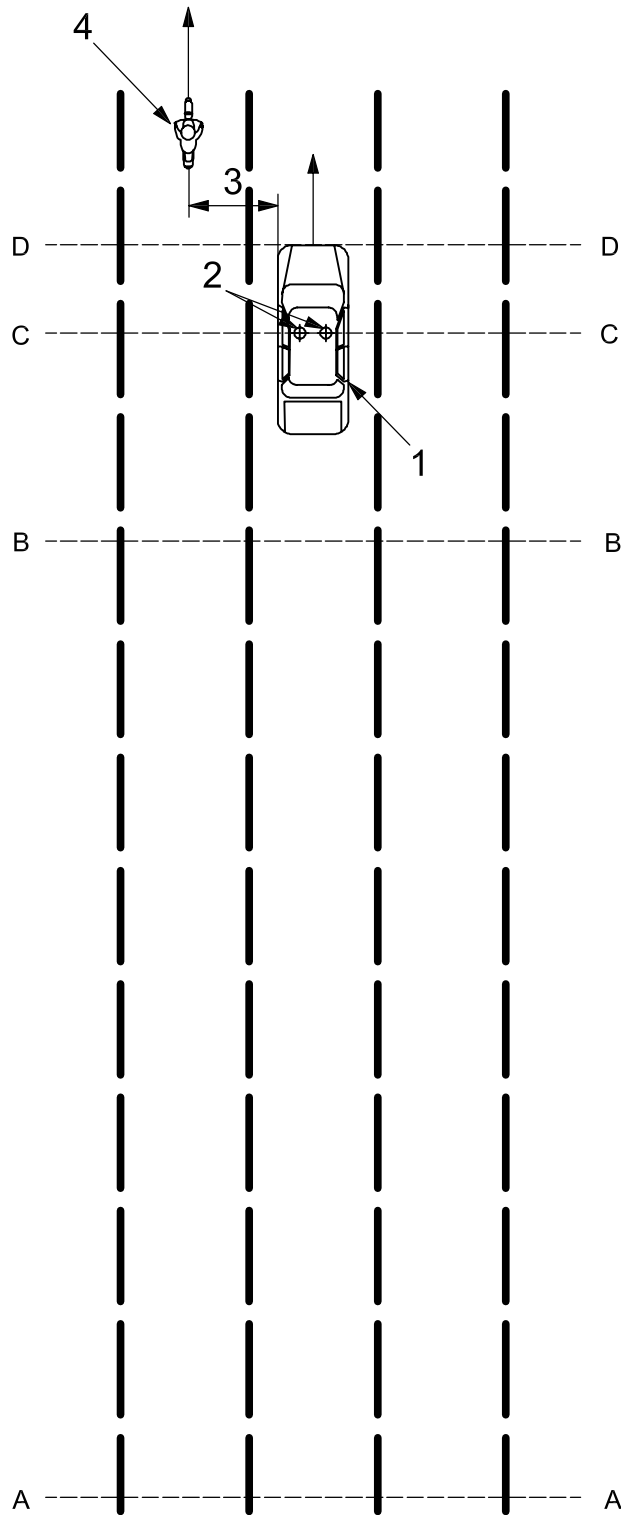

Key

- 1 subject vehicle
- 2 centre of the 95th percentile eyellipse
- 3 lateral distance
- 4 test target vehicle

Figure 12 — Subject vehicle overtaking target vehicle test

5.3.3.4 False Warning Test

The purpose of this test is to check that the blind spot warning system does not give warnings when the test target vehicle is in the lane beyond the adjacent lane. The sequence of tests described in 5.3.2.2 and 5.3.2.3 shall be repeated with the following modification. In each test trial the lateral distance between the outermost edge of the subject vehicle's body (excluding the exterior mirror) and the centreline of the test target vehicle shall be maintained at 6,5 m to 7,5 m. The system shall give no warnings during these test trials.

5.3.3.5 Target vehicle moving laterally

The purpose of this test is to check that the blind spot warning system gives warnings when required as the target vehicle moves laterally near the subject vehicle. Referring to Figure 13 and the line definitions in 4.2, the test shall be conducted as follows.

On a straight, flat test course the subject vehicle shall be driven in a straight line at a minimum steady speed of 20 m/s. The test target vehicle shall match the subject vehicle's speed such that the leading edge of the test target vehicle is positioned between line B and the subject vehicle throughout the test. To begin the test, the test target vehicle shall be completely to the left of line H. The test target vehicle shall move toward the right at a lateral speed of 0,25 m/s to 0,75 m/s until it is completely to the right of line M. Then the test target vehicle shall move toward the left at a lateral speed of 0,25 m/s to 0,75 m/s until it is completely to the left of line H.

As the test target vehicle moves from left to right, the system shall meet the following test requirements.

- The system shall give no warnings while the test target vehicle is completely to the left of line H.
- After the test target vehicle crosses line H, the system shall initiate a warning on the left side of the subject vehicle no later than the time at which the right edge of the test target vehicle crosses line G plus the system response time given in 4.2.6.
- The system shall sustain the warning at least until the right edge of the test target vehicle crosses line F.
- The system shall terminate the warning no later than the time at which the left edge of the test target vehicle crosses line E plus the system response time given in 4.2.6.
- The system shall give no warnings whilst the test vehicle is positioned completely between lines E and J.
- After the test target crosses line J, the system shall initiate a warning on the right side of the vehicle no later than the time at which the left edge of the test target vehicle crosses line K plus the system response time given in 4.2.6.
- The system shall sustain the warning at least until the left edge of the test target vehicle crosses line L.
- The system shall terminate the warning no later than the time at which the left edge of the test target vehicle crosses line M plus the system response time given in 4.2.6.

As the test target vehicle moves from right to left, the system shall meet the following test requirements.

- The system shall give no warnings while the test target vehicle is completely to the right of line M.
- After the test target vehicle crosses line M, the system shall initiate a warning on the right side of the subject vehicle no later than the time at which the left edge of the test target vehicle crosses line L plus the system response time given in 4.2.6.
- The system shall sustain the warning at least until the left edge of the test target vehicle crosses line K.
- The system shall terminate the warning no later than the time at which the right edge of the test target vehicle crosses line J plus the system response time given in 4.2.6.

- The system shall give no warnings whilst the test vehicle is positioned completely between lines E and J.
- After the test target crosses line E, the system shall initiate a warning on the left side of the vehicle no later than the time at which the right edge of the test target vehicle crosses line F plus the system response time given in 4.2.6.
- The system shall sustain the warning at least until the right edge of the test target vehicle crosses line G.
- The system shall terminate the warning no later than the time at which the right edge of the test target vehicle crosses line H plus the system response time given in 4.2.6.

This test shall be repeated in accordance with Table 7 for a total of six trials. During night time conditions, no illumination shall be provided other than the standard headlamps and tail lamps of the subject vehicle and test target vehicle. If it can be shown that the ambient light conditions have no effect on the system's performance, then the tester may choose to perform either the daytime tests or the night time tests for a total of three trials.

Table 7 — Blind spot warning target moving laterally test trials

Day	Night
3 Trials	3 Trials

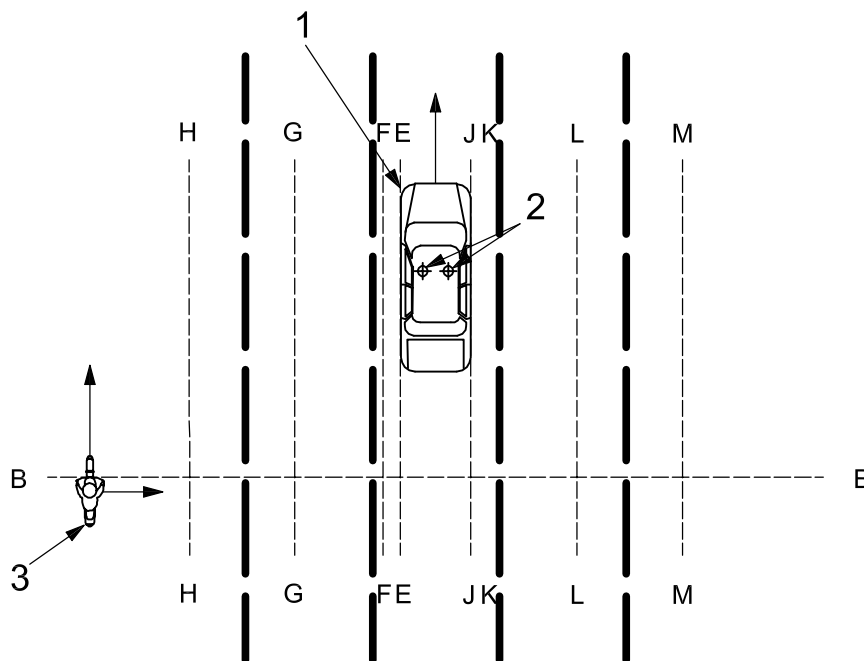

Key

- 1 subject vehicle
- 2 centre of the 95th percentile eyellipse
- 3 test target vehicle

Figure 13 — Target vehicle moving laterally test

5.4 Closing vehicle warning test requirements

5.4.1 General

Subclauses 5.4.2 and 5.4.3 describe the minimum test requirements for a closing vehicle warning system (LCDAS Type II).

5.4.2 Closing vehicle warning test measurement system

The test measurement system shall:

- be completely independent of the closing vehicle warning system being tested;
- be capable of measuring the longitudinal distance between the trailing edge of the subject vehicle and the leading edge of the test target vehicle, if the test target vehicle is to the rear of the subject vehicle;
- be capable of measuring the closing speed of the test target vehicle, if the test target vehicle is approaching the subject vehicle from the rear;
- be capable of measuring the lateral distance between the leftmost edge of the subject vehicle and the rightmost edge of the test target vehicle, if the test target vehicle is to the left of the subject vehicle;
- be capable of measuring the lateral distance between the rightmost edge of the subject vehicle and the leftmost edge of the test target vehicle, if the test target vehicle is to the right of the subject vehicle;
- be capable of measuring the time delay from the point at which the test target vehicle satisfies the warning conditions to the point at which a warning is issued;
- be capable of measuring the time delay from the point at which a warning is no longer allowed to the point at which the warning is terminated.

For all of the test procedures, the test measurement system shall be capable of the following accuracies.

- Distance measurement accuracy:
 - for distances less than 2 m the accuracy shall be 0,1 m or better;
 - for distances from 2 m to 10 m the accuracy shall be 5 % or better;
 - for distances greater than 10 m the accuracy shall be 0,5 m or better.
- Time measurement accuracy:
 - for times less than 200 ms the accuracy shall be 20 ms or better;
 - for times from 200 ms to 1 s the accuracy shall be 10 % or better;
 - for times greater than 1 s the accuracy shall be 100 ms or better.

5.4.3 Closing vehicle warning test procedures

5.4.3.1 General

During all of the following tests, all relevant activation criteria shall be met.

5.4.3.2 Target vehicle overtaking subject vehicle

The purpose of this test is to check that the closing vehicle warning system gives warnings when required as the target vehicle overtakes the subject vehicle. Referring to Figure 14 and the line definitions in 4.2, the test shall be conducted as follows.

On a flat test course the subject vehicle shall be driven at a steady speed within the range shown in Table 8. The test target vehicle shall be driven as shown in Figure 14 so that its closing speed is within the range shown in Table 8.

Table 8 — Closing vehicle warning target overtaking subject test speeds

Target vehicle closing speed classification	Radius of curvature class	Subject vehicle speed	Test target vehicle closing speed
	m	m/s	m/s
Type A	125	7 to 10	7 to 10
Type B	250	10 to 13	12 to 15
Type C	500	13 to 16	17 to 20

Both vehicles shall be driven such that the lateral distance between the outermost edge of the subject vehicle's body (excluding the exterior mirror) and the centreline of the test target vehicle is 2,0 m to 3,0 m. To begin the test, the test target vehicle shall be at least 150 m behind the subject vehicle.

As the test target vehicle approaches and overtakes the subject vehicle, the system shall meet the following test requirements.

- The system shall give no warnings while the test target vehicle's estimated time to collision is 7,5 s or more.
- The system shall initiate a warning on the correct side of the subject vehicle no later than 0,3 s after the test target vehicle's estimated time to collision has fallen to the value given in Table 3.
- The system shall sustain the warning at least until the leading edge of the test target vehicle crosses line B.
- The system shall terminate the warning no later than the time at which the trailing edge of the test target vehicle crosses line N plus the system response time given in 4.2.6.

This test shall be repeated in accordance with Table 9 for a total of twelve trials. For test trials on curves, the roadway radius of curvature shall be equal to the value given in Table 2 -0% $+20\%$. During night time conditions, no illumination shall be provided other than the standard headlamps and tail lamps of the subject vehicle and test target vehicle. If it can be shown that the ambient light conditions have no effect on the system's performance, then the tester may choose to perform either the daytime tests or the night time tests for a total of six trials.

Table 9 — Closing vehicle warning target overtaking subject test trials

	On straight road		On curve to the left		On curve to the right	
	Day	Night	Day	Night	Day	Night
Test target to left of subject vehicle		2 trials	2 trials		2 trials	
Test target to right of subject vehicle	2 trials			2 trials		2 trials

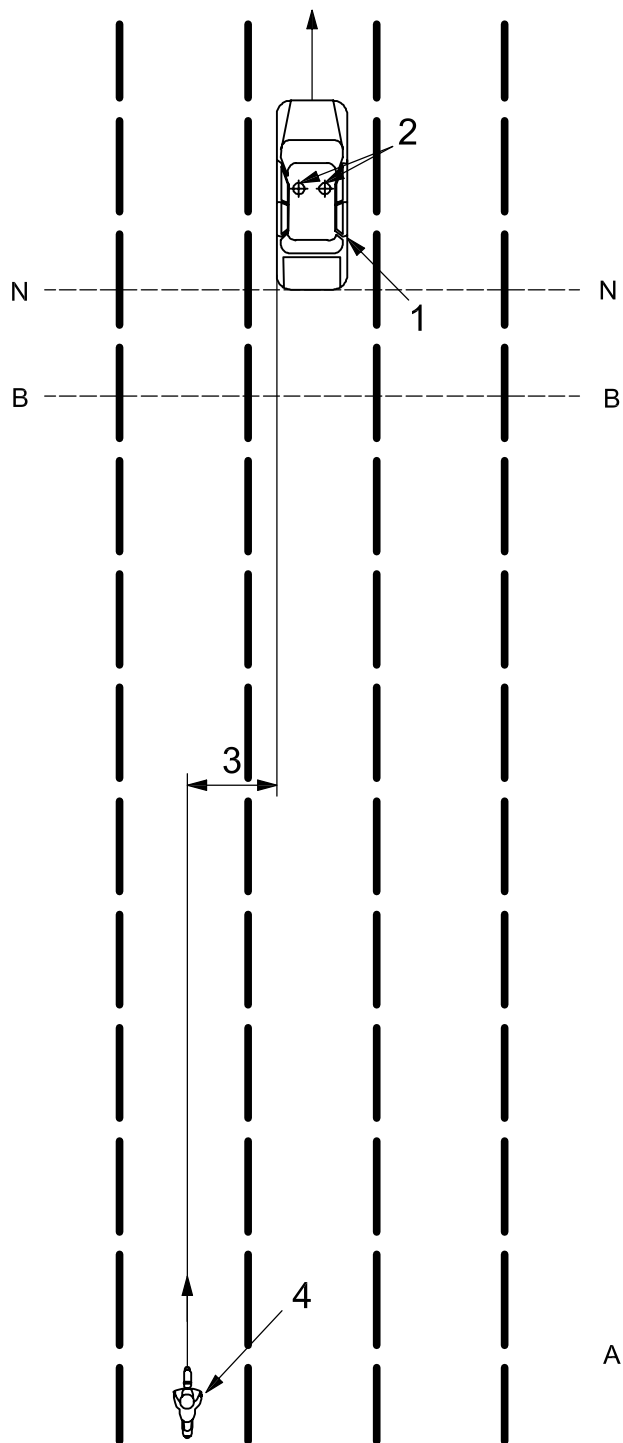

Key

- 1 subject vehicle
- 2 centre of the 95th percentile eyellipse
- 3 lateral distance
- 4 test target vehicle

Figure 14 — Target vehicle overtaking subject vehicle test

5.4.3.3 Subject vehicle overtaking target vehicle

The purpose of this test is to check that the closing vehicle warning system gives warnings only when allowed by the system requirements in situations when the subject vehicle overtakes a target vehicle. Referring to Figure 15 and the line definitions in 4.2, the test shall be conducted as follows.

On a flat test course the test target vehicle shall be driven at a steady speed within the range shown in Table 10. The subject vehicle shall be driven as shown in Figure 15 so that its overtaking speed is within the range shown in Table 10. Both vehicles shall be driven such that the lateral distance between the outermost edge of the subject vehicle's body (excluding the exterior mirror) and the centreline of the test target vehicle is 2,0 m to 3,0 m. To begin the test, the leading edge of the subject vehicle shall be behind the trailing edge of the test target vehicle.

Table 10 — Closing vehicle warning subject overtaking target test speeds

Target vehicle closing speed classification	Radius of curvature classm	Test target vehicle speed	Subject vehicle overtaking speed
	m	m/s	m/s
Type A	125	10 to 15	1 to 5
Type B	250	15 to 20	1 to 5
Type C	500	20 to 25	1 to 5

As the subject vehicle approaches and overtakes the test target vehicle, the system shall meet the following test requirements.

- The system shall give no warnings while the test target vehicle is completely forward of line N.
- After the trailing edge of the test target vehicle crosses line N, the system may initiate a warning on the correct side of the subject vehicle.
- If a warning was given, the system shall terminate the warning no later than the time at which the leading edge of the test target vehicle crosses line A plus the system response time given in 4.2.6.
- The system shall give no warnings while the test target vehicle is completely behind line A.

This test shall be repeated in accordance with Table 11 for a total of twelve trials. For test trials on curves, the roadway radius of curvature shall be equal to the value given in Table 2, -0% $+20\%$. During night time conditions, no illumination shall be provided other than the standard headlamps and tail lamps of the subject vehicle and test target vehicle. If it can be shown that the ambient light conditions have no effect on the system's performance, then the tester may choose to perform either the daytime tests or the night time tests for a total of six trials.

Table 11 — Closing vehicle warning subject overtaking target test trials

	On straight road		On curve to the left		On curve to the right	
	Day	Night	Day	Night	Day	Night
Test target to left of subject vehicle	2 trials			2 trials		2 trials
Test target to right of subject vehicle		2 trials	2 trials		2 trials	

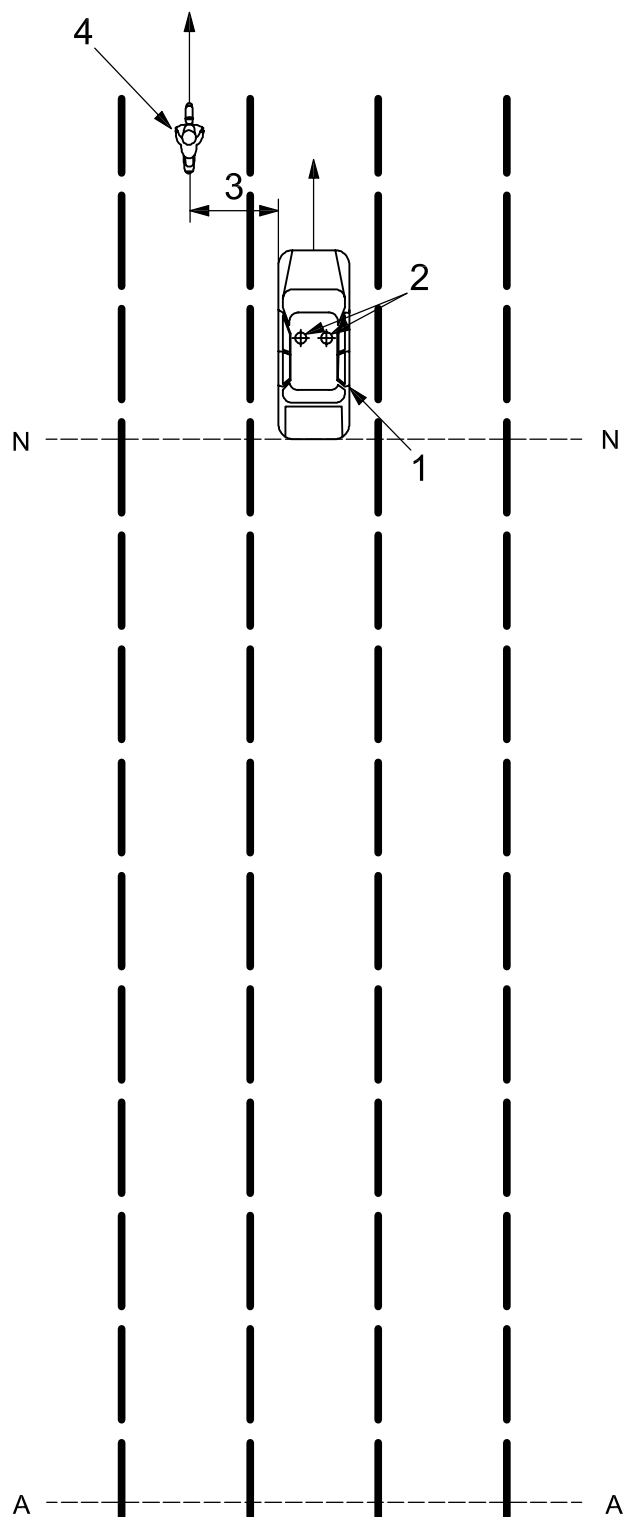

Key

- 1 subject vehicle
- 2 centre of the 95th percentile eyellipse
- 3 lateral distance
- 4 test target vehicle

Figure 15 — Subject vehicle overtaking target vehicle test

5.4.3.4 False warning test

The purpose of this test is to check that the closing vehicle warning system gives no warnings when the target vehicle is in the lane beyond the adjacent lane. The sequence of tests described in 5.4.3.2 and 5.4.3.3 shall be repeated with the following modification. In each test trial the lateral distance between the outermost edge of the subject vehicle's body (excluding the exterior mirror) and the centreline of the test target vehicle shall be maintained at 6,5 m to 7,5 m. The system shall give no warnings during these test trials.

5.5 Lane change warning test requirements

5.5.1 General

Subclauses 5.5.2 and 5.5.3 describe the minimum test requirements for a lane change warning system (LCDAS Type III).

5.5.2 Lane Change Warning Test Measurement System

The test measurement system shall:

- be completely independent of the lane change warning system being tested;
- be capable of measuring the longitudinal distance between the trailing edge of the subject vehicle and the leading edge of the test target vehicle, if the test target vehicle is to the rear of the subject vehicle;
- be capable of measuring the closing speed of the test target vehicle, if the test target vehicle is approaching the subject vehicle from the rear;
- be capable of measuring the longitudinal distance between the leading edge of the subject vehicle and the trailing edge of the test target vehicle, if the test target vehicle is forward of the subject vehicle;
- be capable of measuring the lateral distance between the leftmost edge of the subject vehicle and the rightmost edge of the test target vehicle, if the test target vehicle is to the left of the subject vehicle;
- be capable of measuring the lateral distance between the rightmost edge of the subject vehicle and the leftmost edge of the test target vehicle, if the test target vehicle is to the right of the subject vehicle;
- be capable of measuring the time delay from the point at which the test target vehicle satisfies the warning conditions to the point at which a warning is issued;
- be capable of measuring the time delay from the point at which a warning is no longer allowed to the point at which the warning is terminated.

For all of the test procedures, the test measurement system shall be capable of the following accuracies.

- Distance measurement accuracy:
 - for distances less than 2 m the accuracy shall be 0,1 m or better;
 - for distances from 2 m to 10 m the accuracy shall be 5 % or better;
 - for distances greater than 10 m the accuracy shall be 0,5 m or better.
- Time measurement accuracy:
 - for times less than 200 ms the accuracy shall be 20 ms or better;
 - for times from 200 ms to 1 s the accuracy shall be 10 % or better;
 - for times greater than 1 s the accuracy shall be 100 ms or better.

5.5.3 Lane change warning test procedures

5.5.3.1 General

During all of the following tests, all relevant activation criteria shall be met.

5.5.3.2 Target Vehicle Overtaking Subject Vehicle

The purpose of this test is to check that the lane change warning system gives warnings as required when the target vehicle overtakes the subject vehicle, and to check that there is a smooth transition between the closing vehicle warning function and the blind spot warning function. Referring to Figure 16 and the line definitions in 4.2, the test shall be conducted as follows.

On a flat test course the subject vehicle shall be driven at a steady speed within the range shown in Table 12. The test target vehicle shall be driven as shown in Figure 16 so that its closing speed is within the range shown in Table 12.

Table 12 — Lane change warning target overtaking subject test speeds

Target vehicle closing speed classification	Radius of curvature class m	Subject vehicle speed m/s	Test target vehicle closing speed m/s
Type A	125	7 to 10	7 to 10
Type B	250	10 to 13	12 to 15
Type C	500	13 to 16	17 to 20

Both vehicles shall be driven such that the lateral distance between the outermost edge of the subject vehicle's body (excluding the exterior mirror) and the centreline of the test target vehicle is 2,0 m to 3,0 m. To begin the test, the test target vehicle shall be at least 150 m behind the subject vehicle.

As the test target vehicle approaches and overtakes the subject vehicle, the system shall meet the following test requirements.

- The system shall give no warnings while the test target vehicle's estimated time to collision is 7,5 s or more.
- The system shall initiate a warning on the correct side of the subject vehicle no later than 0,3 s after the test target vehicle's estimated time to collision has fallen to the value given in Table 3.
- The system shall sustain the warning at least until the leading edge of the test target vehicle crosses line C.
- The system shall terminate the warning no later than the time at which the trailing edge of the test target vehicle crosses line D plus the system response time given in 4.2.6.

This test shall be repeated in accordance with Table 13 for a total of 12 trials. For test trials on curves, the roadway radius of curvature shall be equal to the value given in Table 2, -0 % +20 %. During night time conditions, no illumination shall be provided other than the standard headlamps and tail lamps of the subject vehicle and test target vehicle. If it can be shown that the ambient light conditions have no effect on the system's performance, then the tester may choose to perform either the daytime tests or the night time tests for a total of six trials.

Table 13 — Lane change warning target overtaking subject test trials

	On straight road		On curve to the left		On curve to the right	
	Day	Night	Day	Night	Day	Night
Test target to left of subject vehicle		2 trials	2 trials		2 trials	
Test target to right of subject vehicle	2 trials			2 trials		2 trials

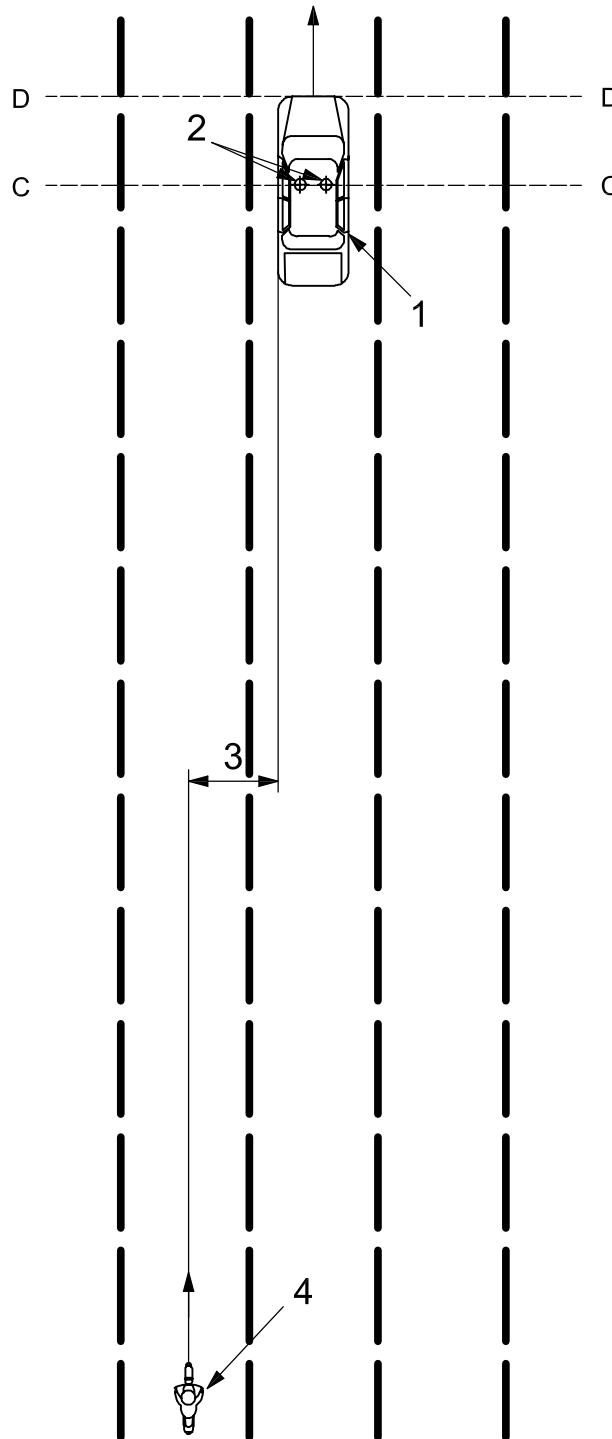

Key

- 1 subject vehicle
- 2 centre of the 95th percentile eyellipse
- 3 lateral distance
- 4 test target vehicle

Figure 16 — Target vehicle overtaking subject vehicle test

5.5.3.3 Subject vehicle overtaking target vehicle

The purpose of this test is to check that the lane change warning system gives warnings as required when the subject vehicle overtakes the target vehicle. This test shall be performed according to 5.3.3.3.

5.5.3.4 False warning test

The purpose of this test is to check that the lane change warning system gives no warnings when the target vehicle is in the lane beyond the adjacent lane. The sequence of tests described in 5.5.3.2 and 5.5.3.3 shall be repeated with the following modification. In each test trial the lateral distance between the outermost edge of the subject vehicle's body (excluding the exterior mirror) and the centreline of the test target vehicle shall be maintained at 6,5 m to 7,5 m. The system shall give no warnings during these test trials.

5.5.3.5 Target vehicle moving laterally

The purpose of this test is to check that the lane change warning system gives warnings when required as the target vehicle moves laterally near the subject vehicle. Referring to Figure 17 and the line definitions in 4.2, the test shall be conducted as follows.

On a straight, flat test course the subject vehicle shall be driven in a straight line at a minimum steady speed of 20 m/s. The test target vehicle shall match the subject vehicle's speed such that the leading edge of the test target vehicle is positioned between line B and the subject vehicle throughout the test. To begin the test, the test target vehicle shall be completely to the left of line H. The test target vehicle shall move toward the right at a lateral speed of 0,25 m/s to 0,75 m/s until it is completely to the right of line M. Then the test target vehicle shall move toward the left at a lateral speed of 0,25 m/s to 0,75 m/s until it is completely to the left of line H.

As the test target vehicle moves from left to right, the system shall meet the following test requirements.

- The system shall give no warnings while the test target vehicle is completely to the left of line H.
- After the test target vehicle crosses line H, the system shall initiate a warning on the left side of the subject vehicle no later than the time at which the right edge of the test target vehicle crosses line G plus the system response time given in 4.2.6.
- The system shall sustain the warning at least until the right edge of the test target vehicle crosses line F.
- The system shall terminate the warning no later than the time at which the left edge of the test target vehicle crosses line E plus the system response time given in 4.2.6.
- The system shall give no warnings while the test vehicle is positioned completely between lines E and J.
- After the test target crosses line J, the system shall initiate a warning on the right side of the vehicle no later than the time at which the left edge of the test target vehicle crosses line K plus the system response time given in 4.2.6.
- The system shall sustain the warning at least until the left edge of the test target vehicle crosses line L.
- The system shall terminate the warning no later than the time at which the left edge of the test target vehicle crosses line M plus the system response time given in 4.2.6.

As the test target vehicle moves from right to left, the system shall meet the following test requirements.

- The system shall give no warnings while the test target vehicle is completely to the right of line M.
- After the test target vehicle crosses line M, the system shall initiate a warning on the right side of the subject vehicle no later than the time at which the left edge of the test target vehicle crosses line L plus the system response time given in 4.2.6.

- The system shall sustain the warning at least until the left edge of the test target vehicle crosses line K.
- The system shall terminate the warning no later than the time at which the right edge of the test target vehicle crosses line J plus the system response time given in 4.2.6.
- The system shall give no warnings while the test vehicle is positioned completely between lines E and J.
- After the test target crosses line E, the system shall initiate a warning on the left side of the vehicle no later than the time at which the right edge of the test target vehicle crosses line F plus the system response time given in 4.2.6.
- The system shall sustain the warning at least until the right edge of the test target vehicle crosses line G.
- The system shall terminate the warning no later than the time at which the right edge of the test target vehicle crosses line H plus the system response time given in 4.2.6.

This test shall be repeated in accordance with Table 14 for a total of six trials. During night time conditions, no illumination shall be provided other than the standard headlamps and tail lamps of the subject vehicle and test target vehicle. If it can be shown that the ambient light conditions have no effect on the system's performance, then the tester may choose to perform either the daytime tests or the night time tests for a total of three trials.

Table 14 — Lane change warning target moving laterally test trials

Day	Night
3 Trials	3 Trials

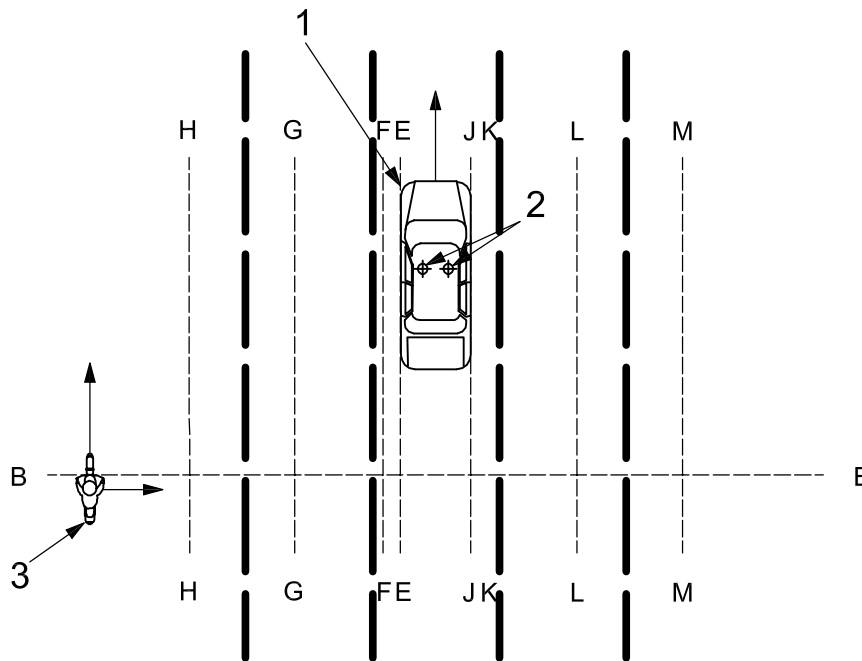

Key

- 1 subject vehicle
- 2 centre of the 95th percentile eyellipse
- 3 test target vehicle

Figure 17 — Target vehicle moving laterally test

Annex A (informative)

Blind spot warning example cases

The examples below are intended to clarify the blind spot warning requirements. These examples all involve a target vehicle to the left of the subject vehicle. Please bear in mind that the right side warning requirements are symmetric to the left side warning requirements.

Table A.1 — Blind Spot Warning Example Cases

<p>A.1 In this case, the blind spot warning function must not give a warning. The target vehicle is completely outside of the zone defined by lines A, D, E and H.</p>	 <p style="text-align: center;">Key</p> <ul style="list-style-type: none"> 1 subject vehicle 2 centre of the 95th percentile eyellipse 3 target vehicle <p style="text-align: center;">Figure A.1</p>
--	---

Table A.1 (continued)

A.2 In this case, the blind spot warning function **may give a warning**. The target vehicle is not completely outside of the zone defined by lines A, D, E and H.

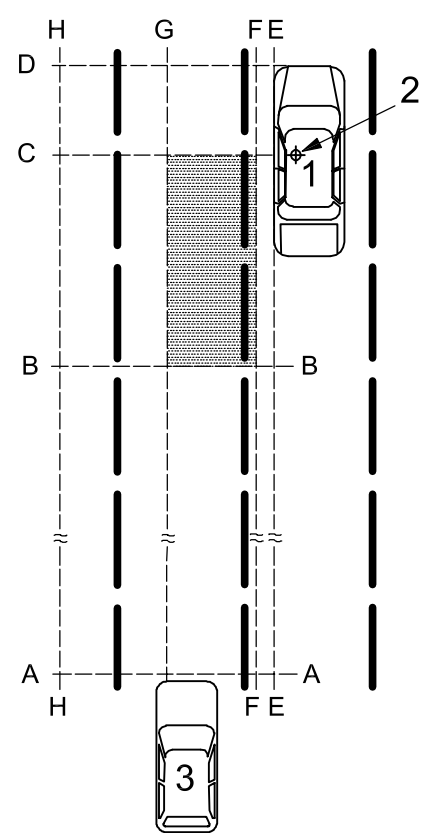
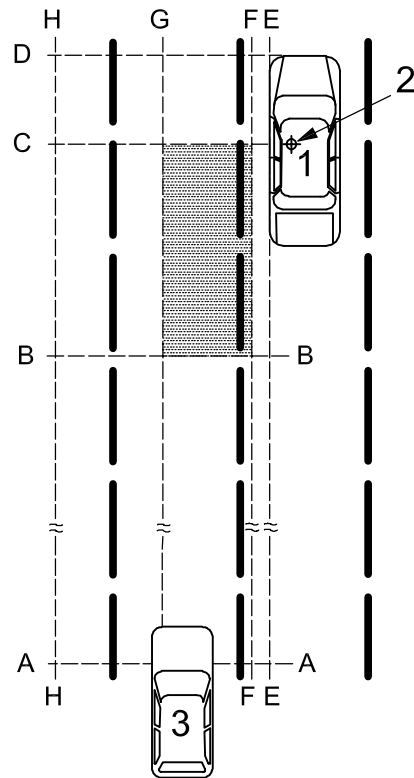

Key

- 1 subject vehicle
- 2 centre of the 95th percentile eyellipse
- 3 target vehicle

Figure A.2

Table A.1 (continued)

A.3 In this case, the blind spot warning function **may give a warning**. A warning is not required because no part of the target vehicle is forward of line B.

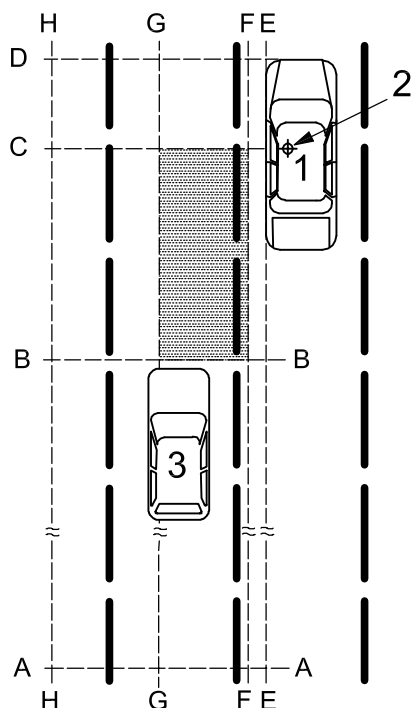

Key

- 1 subject vehicle
- 2 centre of the 95th percentile eyellipse
- 3 target vehicle

Figure A.3

Table A.1 (continued)

A.4 In this case, the blind spot warning function **must give a warning**. The front of the target vehicle is forward of line B.

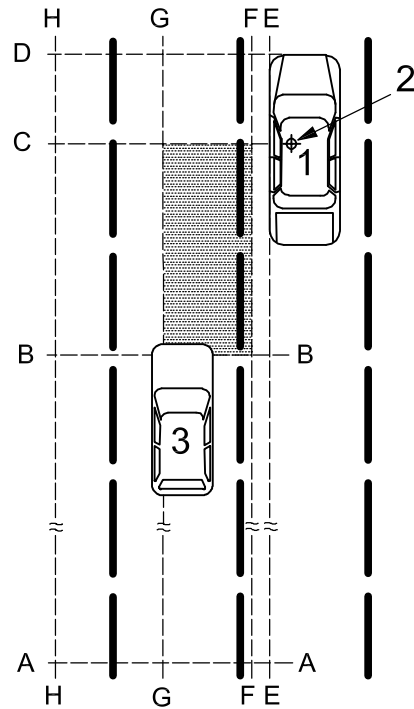

Key

- 1 subject vehicle
- 2 centre of the 95th percentile eyellipse
- 3 target vehicle

Figure A.4

Table A.1 (continued)

A.5 In this case, the blind spot warning function **must give a warning**. The target vehicle is entirely behind line C.

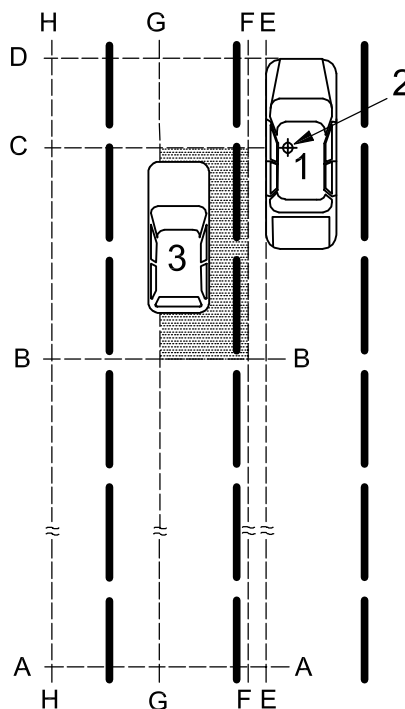

Key

- 1 subject vehicle
- 2 centre of the 95th percentile eyellipse
- 3 target vehicle

Figure A.5

Table A.1 (continued)

A.6 In this case, the blind spot warning function **may give a warning**. A warning is not required because the target vehicle is not entirely behind line C.

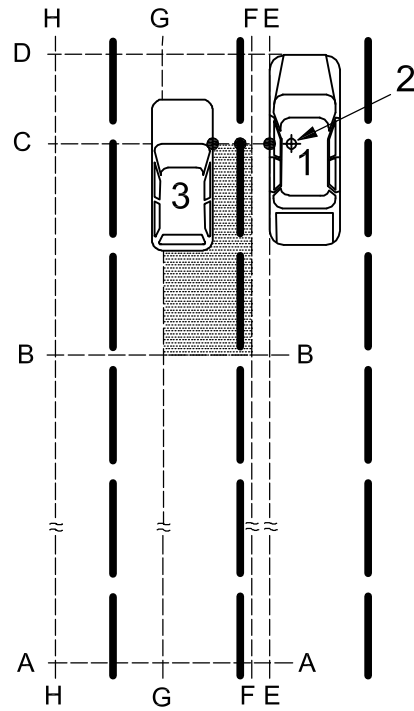

Key

- 1 subject vehicle
- 2 centre of the 95th percentile eyellipse
- 3 target vehicle

Figure A.6

Table A.1 (continued)

A.7 In this case, the blind spot warning function **may give a warning**. The target vehicle is not completely outside of the zone defined by lines A, D, E and H.

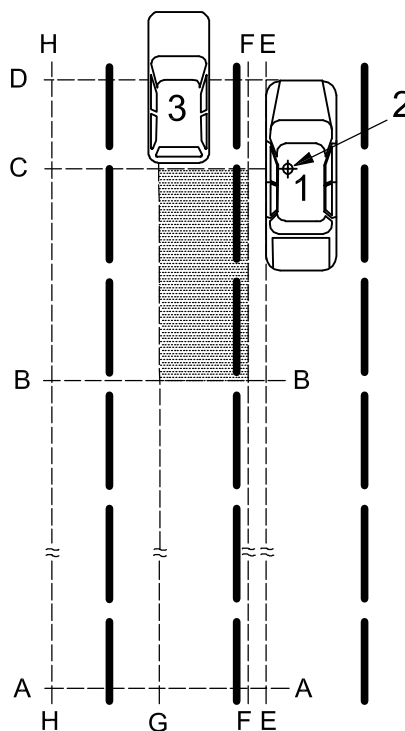

Key

- 1 subject vehicle
- 2 centre of the 95th percentile eyellipse
- 3 target vehicle

Figure A.7

Table A.1 (continued)

A.8 In this case, the blind spot warning function **must not give a warning**. The target vehicle is completely outside of the zone defined by lines A, D, E and H.

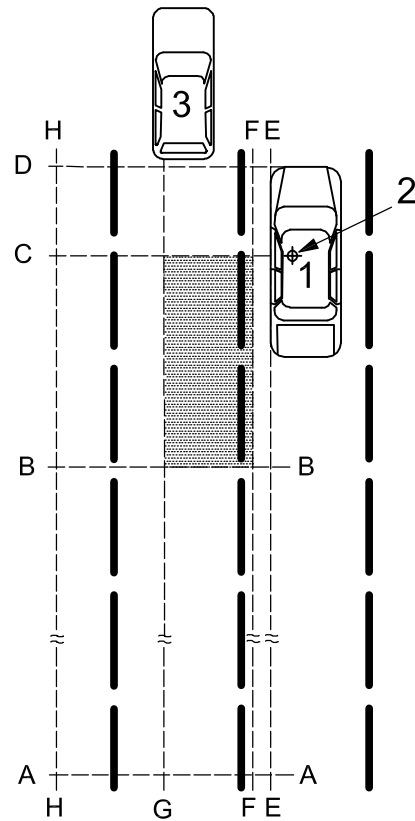

Key

- 1 subject vehicle
- 2 centre of the 95th percentile eyellipse
- 3 target vehicle

Figure A.8

Table A.1 (continued)

A.9 In this case, the blind spot warning function **must not give a warning**. The target vehicle is completely outside of the zone defined by lines A, D, E and H.

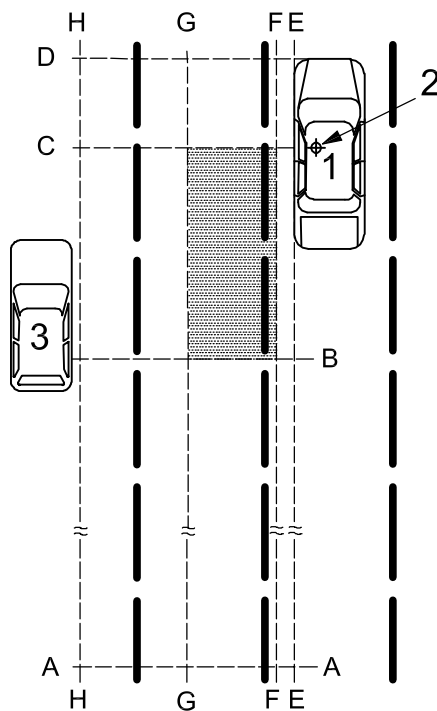

Key

- 1 subject vehicle
- 2 centre of the 95th percentile eyellipse
- 3 target vehicle

Figure A.9

Table A.1 (continued)

A.10 In this case, the blind spot warning function **may give a warning**. The target vehicle is not completely outside of the zone defined by lines A, D, E and H.

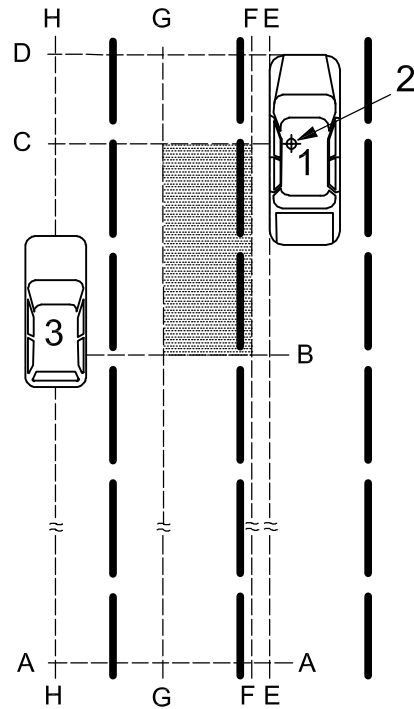

Key

- 1 subject vehicle
- 2 centre of the 95th percentile eyellipse
- 3 target vehicle

Figure A.10

Table A.1 (continued)

A.11 In this case, the blind spot warning function **may give a warning**. A warning is not required because no part of the target vehicle is to the right of line G.

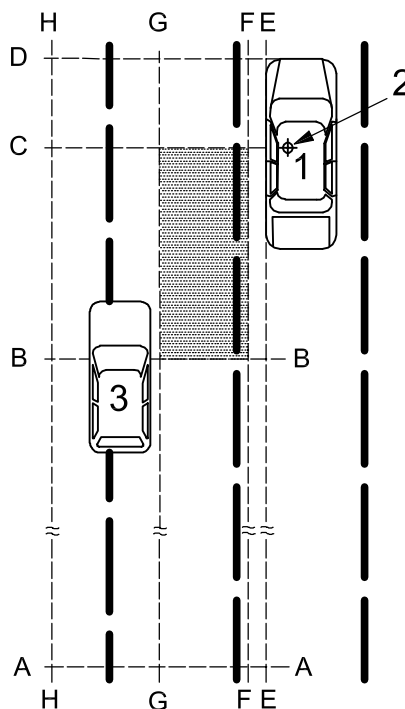

Key

- 1 subject vehicle
- 2 centre of the 95th percentile eyellipse
- 3 target vehicle

Figure A.11

Table A.1 (continued)

A.12 In this case, the blind spot warning function **must give a warning**. The right side of the target vehicle is to the right of line G.

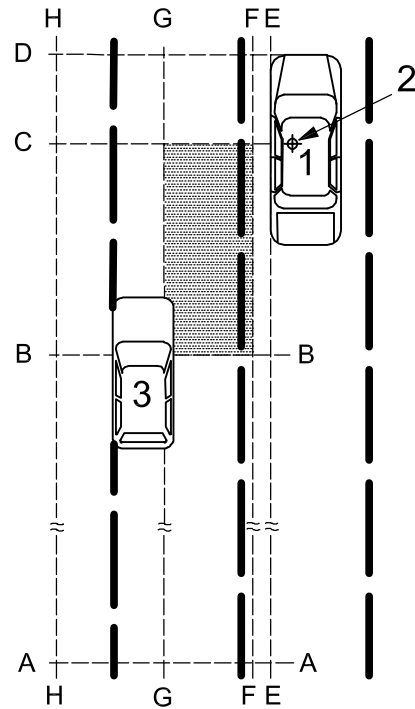

Key

- 1 subject vehicle
- 2 centre of the 95th percentile eyellipse
- 3 target vehicle

Figure A.12

Table A.1 (continued)

A.13 In this case, the blind spot warning function **must give a warning**. The target vehicle is entirely to the left of line F.

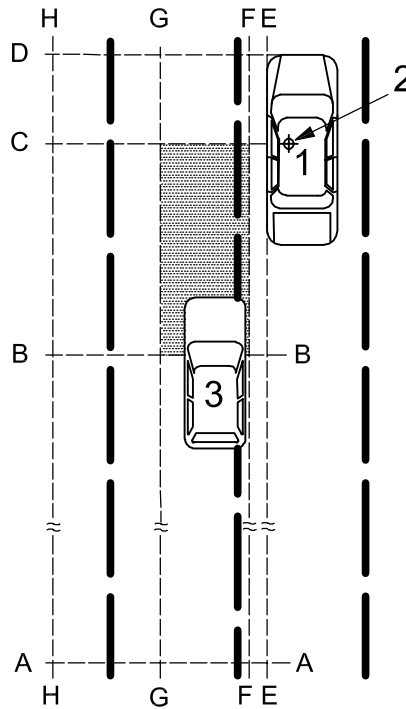

Key

- 1 subject vehicle
- 2 centre of the 95th percentile eyellipse
- 3 target vehicle

Figure A.13

Table A.1 (continued)

A.14 In this case, the blind spot warning function **may give a warning**. A warning is not required because the target vehicle is not entirely to the left of line F.

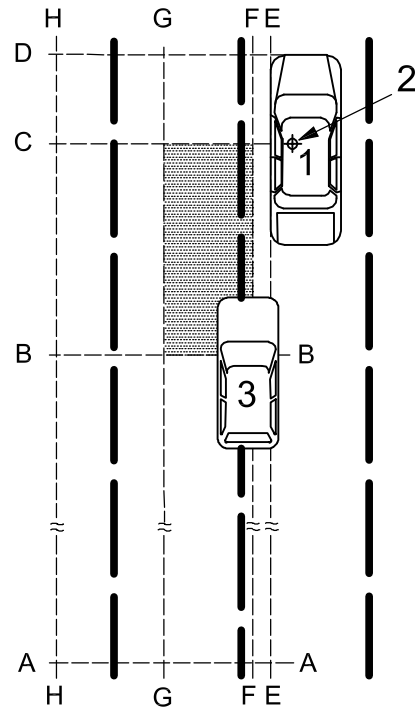

Key

- 1 subject vehicle
- 2 centre of the 95th percentile eyellipse
- 3 target vehicle

Figure A.14

Table A.1 (continued)

A.15 In this case, the blind spot warning function **must not give a warning**. The target vehicle is completely outside of the zone defined by lines A, D, E and H.

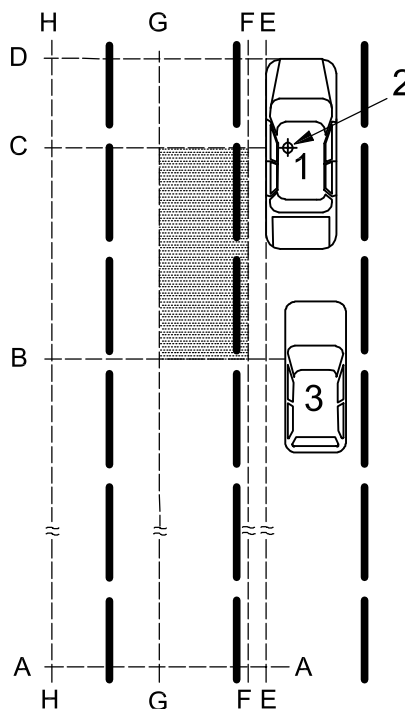

Key

- 1 subject vehicle
- 2 centre of the 95th percentile eyellipse
- 3 target vehicle

Figure A.15

Bibliography

- [1] ISO 1176, *Road vehicles — Masses — Vocabulary and codes*
- [2] ISO 2575, *Road Vehicles — Symbols for controls indicators and tell-tales*
- [3] ISO 15005, *Road vehicles — Ergonomic aspects of transport information and control systems — Dialogue management principles and compliance procedures*
- [4] ISO 15008, *Road vehicles — Ergonomic aspects of transport information and control systems — Specifications and compliance procedures for in-vehicle visual presentation*
- [5] ISO 15006, *Road vehicles — Ergonomic aspects of transport information and control systems — Specifications and compliance procedures for in-vehicle auditory presentation*
- [6] ISO 3833, *Road Vehicles — Types — Terms and definitions*
- [7] ISO 4513, *Road vehicles — Visibility — Method for establishment of eyellipses for driver's eye location*
- [8] ISO/TS 16951, *Road vehicles — Ergonomic aspects of transport information and control systems (TICS) — Procedures for determining priority of on-board messages presented to drivers*
- [9] ISO 15037-1, *Road vehicles — Vehicle dynamics test methods — Part 1: General conditions for passenger cars*
- [10] ISO 15037-2, *Road vehicles — Vehicle dynamics test methods — Part 2: General conditions for heavy vehicles and buses*

ICS 03.220.20; 35.240.60

Price based on 49 pages