

---

---

## Supply chain applications of RFID — Product packaging

*Applications de chaîne d'approvisionnements de RFID —  
Emballage de produit*



Reference number  
ISO 17366:2013(E)

© ISO 2013

.....



**COPYRIGHT PROTECTED DOCUMENT**

© ISO 2013

All rights reserved. Unless otherwise specified, no part of this publication may be reproduced or utilized otherwise in any form or by any means, electronic or mechanical, including photocopying, or posting on the internet or an intranet, without prior written permission. Permission can be requested from either ISO at the address below or ISO's member body in the country of the requester.

ISO copyright office  
Case postale 56 • CH-1211 Geneva 20  
Tel. + 41 22 749 01 11  
Fax + 41 22 749 09 47  
E-mail [copyright@iso.org](mailto:copyright@iso.org)  
Web [www.iso.org](http://www.iso.org)

Published in Switzerland

# Contents

	Page
<b>Foreword</b> .....	<b>v</b>
<b>Introduction</b> .....	<b>vi</b>
<b>1 Scope</b> .....	<b>1</b>
<b>2 Conformance and performance specifications</b> .....	<b>1</b>
<b>3 Normative references</b> .....	<b>1</b>
<b>4 Terms and definitions</b> .....	<b>2</b>
<b>5 Concepts</b> .....	<b>3</b>
5.1 Differentiation between this layer and the preceding layers.....	3
5.2 Returnable packaging item.....	5
5.3 Unique item identifier.....	5
5.4 Other identification requirements.....	8
<b>6 Differentiation within this layer</b> .....	<b>8</b>
6.1 Business processes.....	8
6.2 Lot/batch vs. serial number vs. product identification only.....	9
6.3 Consumer products vs. industrial/government.....	9
<b>7 Data content</b> .....	<b>9</b>
7.1 Introduction.....	9
7.2 System data elements.....	10
7.3 Tag structure.....	10
7.4 Protocol control (PC) bits.....	12
7.5 Data elements.....	13
7.6 Traceability.....	14
7.7 Unique item serialization.....	14
<b>8 Data security</b> .....	<b>14</b>
8.1 Confidentiality.....	14
8.2 Data integrity.....	14
8.3 Interrogator authentication.....	14
8.4 Non-repudiation/audit trail.....	14
8.5 Product authentication/anti-counterfeiting.....	14
<b>9 Identification of RFID labelled material</b> .....	<b>15</b>
<b>10 Backup in case of RF tag failure</b> .....	<b>15</b>
10.1 Human readable interpretation.....	15
10.2 Human readable translation.....	15
10.3 Data titles.....	15
10.4 Backup.....	15
<b>11 Tag operation</b> .....	<b>16</b>
11.1 Data protocol.....	16
11.2 Minimum performance requirements (range and rate).....	16
11.3 Environmental considerations.....	17
11.4 Tag orientation.....	18
11.5 Packaging material.....	18
11.6 Shock loads and abrasions.....	18
11.7 Tag lifetime.....	18
11.8 Minimum system reliability.....	18
11.9 Air interface.....	18
11.10 Memory requirements for application.....	18
11.11 Sensor interface, if applicable.....	18
11.12 Real time clock option.....	19
11.13 Safety and regulatory considerations.....	19
11.14 Non-observable data.....	19

11.15	Tag recyclability .....	19
11.16	Tag reusability .....	19
<b>12</b>	<b>Tag location and presentation .....</b>	<b>19</b>
12.1	Material on which the tag is mounted or inserted .....	20
12.2	Geometry of the package/tag environment .....	20
<b>13</b>	<b>Interrogator and reader requirements .....</b>	<b>20</b>
13.1	Safety and regulatory considerations .....	20
13.2	Data privacy .....	20
<b>14</b>	<b>Interoperability, compatibility and non-interference with other RF systems .....</b>	<b>20</b>
<b>Annex A (informative) Table of useful data elements for product life cycle management .....</b>		<b>21</b>
<b>Annex B (normative) Encoding .....</b>		<b>22</b>
<b>Bibliography .....</b>		<b>32</b>

.....

## Foreword

ISO (the International Organization for Standardization) is a worldwide federation of national standards bodies (ISO member bodies). The work of preparing International Standards is normally carried out through ISO technical committees. Each member body interested in a subject for which a technical committee has been established has the right to be represented on that committee. International organizations, governmental and non-governmental, in liaison with ISO, also take part in the work. ISO collaborates closely with the International Electrotechnical Commission (IEC) on all matters of electrotechnical standardization.

International Standards are drafted in accordance with the rules given in the ISO/IEC Directives, Part 2.

The main task of technical committees is to prepare International Standards. Draft International Standards adopted by the technical committees are circulated to the member bodies for voting. Publication as an International Standard requires approval by at least 75 % of the member bodies casting a vote.

Attention is drawn to the possibility that some of the elements of this document may be the subject of patent rights. ISO shall not be held responsible for identifying any or all such patent rights.

ISO 17366 was prepared by Technical Committee ISO/TC 122, *Packaging*.

This second edition cancels and replaces the first edition (ISO 17366:2009), which has been technically revised.

This International Standard has two annexes; [Annex A](#) provides informative information, and [Annex B](#) provides normative information.

## Introduction

The 'Supply chain' is a multi-level concept that covers all aspects of taking a product from raw materials to a final product including shipping to a final place of sale, use and maintenance, and potentially disposal. Each of these levels covers many aspects of dealing with products and the business process for each level is both unique and overlapping with other levels.

This International Standard has been created in order to ensure compatibility at the physical, command and data levels with the four other International Standards under the general title *Supply chain applications of RFID*. Where possible, this compatibility takes the form of interchangeability. Where interchangeability is not feasible, the International Standards within this suite are interoperable and non-interfering. The International Standards within the complete series of *Supply chain applications of RFID* include

- ISO 17363, *Supply chain applications of RFID — Freight containers*;
- ISO 17364, *Supply chain applications of RFID — Returnable transport items (RTIs) and returnable packaging items (RPIs)*;
- ISO 17365, *Supply chain applications of RFID — Transport units*;
- ISO 17366, *Supply chain applications of RFID — Product packaging*;
- ISO 17367, *Supply chain applications of RFID — Product tagging*.

These International Standards define the technical aspects and data hierarchy of information required in each layer of the supply chain. The air-interface and communications protocol standards supported within the *Supply chain applications of RFID* International Standards are ISO/IEC 18000; commands and messages are specified by ISO/IEC 15961 and ISO/IEC 15962; semantics are defined in ISO/IEC 15418; syntax is defined in ISO/IEC 15434.

Although not pertinent to this International Standard, the following work is considered valuable:

- ISO/IEC JTC 1, *Information technology, SC 31, Automatic identification and data capture techniques*, in the areas of air interface, data semantic and syntax construction and conformance standards, and
- ISO/TC 104, *Freight containers*, in the area of freight container security, including electronic seals (e-seals) (i.e. ISO 18185) and container identification

# Supply chain applications of RFID — Product packaging

## 1 Scope

This International Standard defines the basic features of RFID for use in the supply chain when applied to product packaging. In particular it

- provides specifications for the identification of the product packaging,
- makes recommendations about additional information on the RF tag,
- specifies the semantics and data syntax to be used,
- specifies the data protocol to be used to interface with business applications and the RFID system,
- specifies the minimum performance requirements,
- specifies the air interface standards between the RF interrogator and RF tag, and
- specifies the reuse and recyclability of the RF tag.

## 2 Conformance and performance specifications

All of the devices and equipment that claim conformance with this International Standard shall also conform to the appropriate sections and parameters specified in ISO/IEC 18046 for performance, and ISO/IEC 18047-6 (for ISO/IEC 18000-63, Type C) and ISO/IEC/TR 18047-3 (for the ASK interface of ISO/IEC 18000-3, Mode 3) for conformance.

## 3 Normative references

The following referenced documents are indispensable for the application of this document. For dated references, only the edition cited applies. For undated references, the latest edition of the referenced document (including any amendments) applies.

ISO 445, *Pallets for materials handling — Vocabulary*

ISO 830, *Freight containers — Vocabulary*

ISO 8601, *Data elements and interchange formats — Information interchange — Representation of dates and times*

ISO/IEC IEEE 8802-15-4, *Information technology — Telecommunications and information exchange between systems — Local and metropolitan area networks — Specific requirements Part 15.4: Wireless Medium Access Control (MAC) and Physical Layer (PHY) Specifications for Low-Rate Wireless Personal Area Networks (WPANs)*

ISO/IEC 15418, *Information technology — Automatic identification and data capture techniques — GS1 Application Identifiers and ASC MH10 Data Identifiers and maintenance*

ISO/IEC 15434, *Information technology — Automatic identification and data capture techniques — Syntax for high-capacity ADC media*

ISO/IEC 15459-4, *Information technology — Automatic identification and data capture techniques — Unique identification — Part 4: Individual products and product packages*

## ISO 17366:2013(E)

ISO/IEC 15961, *Information technology — Radio frequency identification (RFID) for item management — Data protocol: application interface*

ISO/IEC 15962, *Information technology — Radio frequency identification (RFID) for item management — Data protocol: data encoding rules and logical memory functions*

ISO/IEC 15963, *Information technology — Radio frequency identification for item management — Unique identification for RF tags*

ISO/IEC 16022, *Information technology — Automatic identification and data capture techniques — Data Matrix bar code symbology specification*

ISO 17364:2013, *Supply chain applications of RFID — Returnable transport items (RTIs) and Returnable packaging items (RPIs)*

ISO/IEC 18000-3, *Information technology — Radio frequency identification for item management — Part 3: Parameters for air interface communications at 13,56 MHz*

ISO/IEC 18000-63, *Information technology — Radio frequency identification for item management — Part 63: Parameters for air interface communications at 860 MHz to 960 MHz Type C*

ISO/IEC 18004, *Information technology — Automatic identification and data capture techniques — QR Code 2005 bar code symbology specification*

ISO/IEC 18046 (all parts), *Information technology — Radio frequency identification device performance test methods*

ISO/IEC/TR 18047-3, *Information technology — Radio frequency identification device conformance test methods — Part 3: Test methods for air interface communications at 13,56 MHz*

ISO/IEC 18047-6, *Information technology — Radio frequency identification device conformance test methods — Part 6: Test methods for air interface communications at 860 MHz to 960 MHz*

ISO/IEC 19762 (all parts), *Information technology — Automatic identification and data capture (AIDC) techniques — Harmonized vocabulary*

ISO 21067, *Packaging — Vocabulary*

ISO/IEC/IEEE 21451-7, *Information technology — Smart transducer interface for sensors and actuators — Part 7: Transducer to radio frequency identification (RFID) systems communication protocols and Transducer Electronic Data Sheet (TEDS) formats*

ISO/IEC/TR 24729-1, *Information technology — Radio frequency identification for item management — Implementation guidelines — Part 1: RFID-enabled labels and packaging supporting ISO/IEC 18000-6C*

ANS MH10.8.2, *Data Identifiers and Application Identifiers*

GS1 EPC Tag Data Standard, Version 1.6

GS1 General Specifications

ICNIRP Guidelines, *Guidelines for limiting exposure to time-varying electric, magnetic, and electromagnetic fields (up to 300 GHz)*

IEEE C95-1, *IEEE Standard for Safety Levels with Respect to Human Exposure to Radio Frequency Electromagnetic Fields, 3 kHz to 300 GHz*

## 4 Terms and definitions

For the purposes of this document, the terms and definitions given in ISO 445, ISO 830, ISO 17364, ISO/IEC 19762 (all parts), and ISO 21067 apply.



For the purposes of this document, hexadecimal characters are represented as 0xnn, where “nn” is the hexadecimal value.

## 5 Concepts

### 5.1 Differentiation between this layer and the preceding layers

[Figures 1](#) and [2](#) give a graphical representation of supply chain layers. They show a conceptual model of possible supply chain relationships, not a one-for-one representation of physical things. Although several layers in [Figure 2](#) have clear physical counterparts, some common supply chain physical items fit in several layers depending on the use case. For example, as shown in [Figure 2](#), a repetitively used pallet under constant ownership would be covered by ISO 17364 as an RTI; a pallet that is part of a consolidated unit load would be covered by ISO 17365 as a transport unit, and a pallet that is integral to a single item would be covered by this International Standard as product packaging.

The term “supply chain layers” is a multi-level concept that covers all aspects of taking a product from raw materials to a final product to shipping to a final place of sale, use, maintenance and potentially disposal and returned goods. Each of these levels covers many aspects of dealing with products and the business process for each level is both unique and overlapping with other levels.

The Item Level through Freight Container Level layers are addressed within the suite of standards for “supply chain applications of RFID” and are intended to enhance supply chain visibility. The Movement Vehicle Level is the purview of ISO/TC 204/WG 7.

The Product Packaging Level in [Figure 2](#), and specifically product packaging, (as defined in ISO 17364:2013, 4.2) is the subject of this International Standard.

Product packaging layer tags can be distinguished from following or preceding layer tags by use of a *group select* methodology contained in the RFID interrogator/reader. This group select function allows the interrogator and supporting automated information systems (AIS) to quickly identify Product Packaging Level tags.

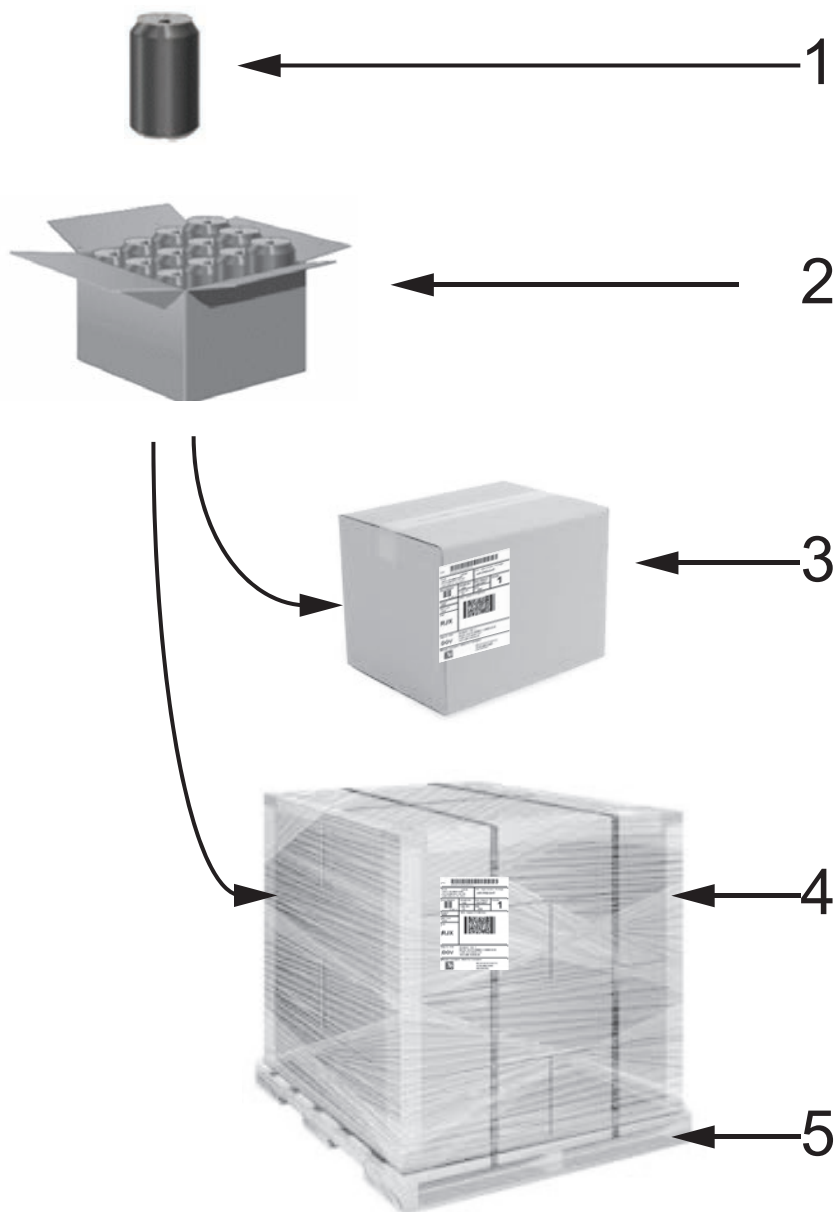

**Key**

- 1 primary packaging — consumer packaging — (*product*)
- 2 secondary packaging — outer packaging — (*product package*)
- 3 tertiary packaging — transport packaging — (*transport unit*)
- 4 tertiary packaging — unitized transport packaging — (*transport unit*)
- 5 pallet — (*returnable transport item — RTI*)

**Figure 1 — Packaging**

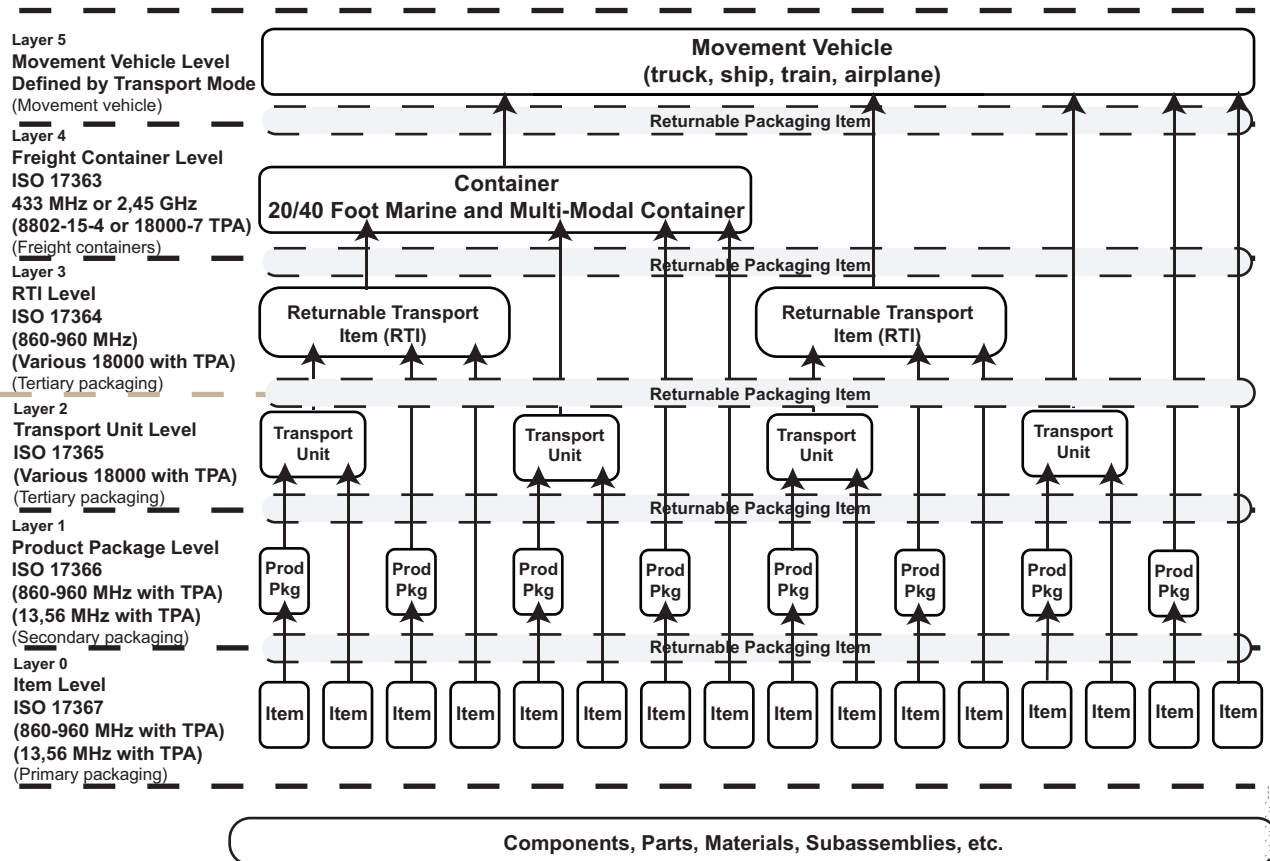

Figure 2 — Supply chain layers

## 5.2 Returnable packaging item

At all layers within the supply chain are materials that are shipped to a customer with full expectation that such devices will be returned to the supplier. These returnable packaging items (RPIs) are assets of value as well as potentially the physical product packaging. RPIs and their identification are well addressed in Annex A of ISO/IEC 17364:2013, and Annex A of ISO/IEC 17365:2013.

## 5.3 Unique item identifier

### 5.3.1 General

Unique product packaging identification is a process that assigns a unique data string to an individual package, or in this case to an RFID tag that is associated to the product package. The unique data string is called the unique product package identifier. Unique item identification of product packaging allows data collection and management at a granular level. The benefits of granular level data are evident in such areas as maintenance, warranties and enabling electronic transactions of record. This granularity is possible only if each tagged item has a unique item identifier.

Product package layer tagging can uniquely identify products, thus providing differentiation between like and unlike product packages. Product package layer tagging can also be used to identify product packages by differentiating unlike product packages but not differentiating between like product packages. This is used for commodities where individualization is impractical or undesirable.

The unique product packaging identifier described above shall be the unique identifier as described in ISO/IEC 15459-4. The unique item identifier (UII) provides granular discrimination between like items that are identified with RFID tags. The unique tag ID (as defined by ISO/IEC 15963) is a mechanism

## ISO 17366:2013(E)

to uniquely identify RFID tags and is not the unique product packaging identifier defined in this International Standard.

The minimum data elements required for unique identification are an enterprise identifier and a serial number that is unique within that enterprise identifier. Commonly, a part or model number is also required to achieve unique identification.

This International Standard uses the following identification mechanisms for unique product package identification:

- unique identifiers for supply chain items (ISO/IEC 15459-4);
- GS1 Serialized Global Trade Item Number (SGTIN).

### 5.3.2 International unique identification for items

The unique identifier of ISO/IEC 15459 provides identification schemes for various layers of the supply chain, from the Item Level (products) up to the RTI Level (returnable transport items). The unique identification of product packages shall use ISO/IEC 15459-4. Unique identification is provided contextually by three components:

- a) issuing agency code (IAC),
- b) company identification number (CIN),
- c) serial number (SN),

preceded by an AFI and Data Identifier (DI). The AFI code assignments table in ISO/IEC 15961-3, Data Constructs Register and shown below in [Table 1](#) permits identification of the supply chain layer, i.e. product = 0xA1, transport unit = 0xA2, returnable transport item = 0xA3, and product package = 0xA5.

The Data Identifier shall be “25S”. The ISO/IEC 15459 registration authority assigns the IAC. The CIN is assigned by the issuing agency. The company registered with the issuing agency assigns the serial number. The serial number shall be no longer than 20 alphanumeric characters.

**Table 1 — 1736x AFI Assignments**

AFI	Assigned organization or function
0xA1	ISO 17367 product tagging
0xA2	ISO 17365 transport unit
0xA3	ISO 17364 returnable transport item or returnable packaging items
0xA4	ISO 17367 product tagging, containing hazardous materials
0xA5	ISO 17366 product packaging
0xA6	ISO 17366 product packaging, containing hazardous materials
0xA7	ISO 17365 transport unit, containing hazardous materials
0xA8	ISO 17364 returnable transport item or returnable packaging item, containing hazardous materials
0xA9	ISO 17363 freight containers
0xAA	ISO 17363 freight containers, containing hazardous materials

EPC does not use AFIs; consequently, there are no AFIs used for RTIs employed in retail applications using EPC. AFI 0xA5 may be used for product packages intended solely for commodities other than consumer goods. [Annex B](#) provides an in-depth discussion of the ISO approach to encoding.

To define its class (in the ISO/IEC 15459 sense), the unique identifier shall have an associated class identifier, which is the Data Identifier “25S”. For the purposes of this International Standard, a unique identifier of product packages should be no longer than 35 alphanumeric characters, excluding the Data

Identifier (an3+an..35). See [Table 2](#). With the mutual agreement of the trading partners this length can be extended to 50 characters (an3+an..50).

**Table 2 — ISO UII element string**

Format of the license plate	
Data Identifier	IAC, company identification number (CIN), serial number
25S	N <sub>1</sub> N <sub>2</sub> N <sub>3</sub> N <sub>4</sub> N <sub>5</sub> N <sub>6</sub> N <sub>7</sub> N <sub>8</sub> N <sub>9</sub> N <sub>10</sub> N <sub>11</sub> N <sub>12</sub> N <sub>13</sub> N <sub>14</sub> N <sub>15</sub> N <sub>16</sub> N <sub>17</sub> . . . N <sub>35</sub>

### 5.3.3 Serialized global trade identification number (SGTIN)

The GS1 EPC serialized global trade identification number (SGTIN-96) is a unique item identifier (UII) capable of providing unique item identification of product packages.

**Table 3 — SGTIN-96 element string**

	Header	Filter Value	Partition	Company Prefix	Item Reference	Serial Number
Number of bits	8	3	3	20 to 40	24 to 4	38
Reference	0011 0000 <sup>a</sup>	—b	—b	999 999 to 999 999 999 999 <sup>c</sup>	9 999 999 to 9 <sup>c</sup>	274 877 906 943 <sup>d</sup>
NOTE Maximum decimal value range of Company Prefix and Item Reference fields vary according to the contents of the partition field.						
<sup>a</sup> Binary value.						
<sup>b</sup> Refer to GS1 EPC, Tag Data Standard, Version 1.6 for values.						
<sup>c</sup> Maximum decimal range.						
<sup>d</sup> Maximum decimal value.						

The SGTIN consists of the following information elements:

- a) The *Header*, which is defined in the *GS1 EPC Tag Data Standard, Version 1.6*. It is eight (8) bits long and for an SGTIN-96 is the value 0x30. While the remainder of the document describes an SGTIN-96 the *GS1 EPC Tag Data Standard* also describes a longer version.
- b) The *Filter Value*, which is defined in the *GS1 EPC Tag Data Standard Version 1.6*. It is three (3) bits long and identifies whether an EPC is for a retail trade item, a standard trade item grouping, or a single shipping/consumer trade item.
- c) The *Partition*, defined in the *GS1 EPC Tag Data Standard Version 1.6*. It is three (3) bits long, carries one of seven (7) values, and identifies where the subsequent *Company Prefix* and *Item Reference* numbers are divided.
- d) The *Company Prefix*, assigned by GS1 to an organization. The *Company Prefix* is the same as the *Company Prefix* digits within a GS1 GTIN decimal code. The combined *Company Prefix* and *Item Reference* are 44 bits long (13 decimal digits).
- e) The *Item Reference*, assigned by the “Company” entity to a particular product package. The combined *Company Prefix* and *Item Reference* are 44 bits long (13 decimal digits).
- f) The *Serial Number* assigned by the managing entity to an individual object. The EPC representation is only capable of representing a subset of *Serial Numbers* allowed in the *GS1 General Specifications*. Specifically, only those *Serial Numbers* consisting of one or more digits, with no leading zeros, are permitted. The length of the *Serial Number* is 38 bits.

## 5.4 Other identification requirements

This International Standard does not supersede or replace any applicable safety or regulatory marking or labelling requirements.

This International Standard is meant to satisfy the minimum product package identification requirements of numerous applications and industry groups. As such, its applicability is to a wide range of industries, each of which may have specific implementation guidelines for this International Standard. This International Standard is to be applied in addition to any other mandated labelling requirements.

## 6 Differentiation within this layer

### 6.1 Business processes

Business processes such as those described below are illustrative of the applications envisioned by this International Standard.

**Acquisition:** ordering, including the identification of relevant specifications and requirements, can be facilitated by referencing the item's original acquisition data using the RFID tag's unique ID as a database key.

**Shipping:** where items can have different configurations or capabilities, such as with computer software loads that differentiate items with otherwise identical form, fit and function, such items can be issued and shipped with the tag read providing assurance that the correct item was shipped. This level of non-intrusive tracking and tracing can serve as a front end to higher level in-transit visibility RFID applications detailed in the other standards of this series.

**Receiving:** non-intrusive collection of receipt data can shorten data collection times, in support of automated inventory management systems and provide an electronic *transaction of record* much earlier in the process. Earlier knowledge of on-hand inventory can reduce stock outs and the need for expedited premium transportation.

**Cross docking:** in addition to recording inbound receipts and outbound shipments, tagged items can be sorted. Many items will have exterior marking (tagging) that are used in lieu of reading the product tag.

**Work in process:** used to track individual components and the final assembly (bill of material) and to monitor any item through a fabrication or manufacturing process.

- **Maintenance:** related to work in progress and differentiated in that it covers functions prior to and subsequent to the actual work. This includes fault analysis, identification, preparation of packing and packaging.
- **Inventory control:** item level serialization yields a granularity of visibility that supports the management of individual items. This allows data collection, tracking and tracing of individual items and selection at point of issue.
- **Disposal:** identification of items that have recycling or other disposal requirements.
- **Picking and put-away:** selection of items from a package or transport unit prior to placement into shelf stock in a warehouse situation or other storage situation where a specific asset is desired or knowledge of the specific item selected is required for issue.
- **Pick and place:** selection of items from shelf stock in a warehouse situation or other storage situation where a specific asset is desired or knowledge of the specific item selected is required incident to the placement of the item into or onto another asset incident to a manufacturing or assembly process.
- **Sortation:** process that places individual items into groups based upon some selection criteria, often performed at speed.



- Identification: process that is an inherent part of each of the functions set out above. It allows the positive differentiation of an item consistent with the business process in use. Identification can be at the discrete item level for serialized products or by commodity for non-serialized products. Identification is often the underlying base process that enables the other uses of the tag.
- Network topology: can be used to identify discrete nodes or locations on a network.
- Configuration management: discrete identification of the individual component items that comprise a higher assembly. This component data can be tiered to cover each of the multiple levels of configuration (e.g. the circuit board inside the radio installed in the communications suite of an aircraft).

The multitude of different business processes circumscribed by the supply chain will employ distinctly different groupings of functions and processes outlined above. The reading, writing or erasing of data to/from a tag is intended to effect identification and data capture about the product and the process involved, and shall be integrated into business processes as required by the business process owner.

## 6.2 Lot/batch vs. serial number vs. product identification only

Just as different business processes have varying data requirements, different items will have varying identification requirements. Use of structured or intelligent serialization schemes include additional data such as part number or lot number in the serialization scheme and should be avoided whenever possible. This means ideally that the serialization is unique within the enterprise.

The lowest level of identification would be product ID only. Lot and batch type items shall be marked with the product ID of the item and the lot or batch of that item to which this particular item belongs. Serialized items shall be marked with a unique serial number in conformance with the appropriate part of ISO/IEC 15459, which details the differing methods of serialization that provide unique identification.

Medicines are typical of the type of item that is manufactured and managed at the lot level but sold and used at the item level. Thus, a particular dosage of medicine will require unique identification of that dose and the ability to reference that back to the original manufacturing lot. Looking up associated information on the information system may accomplish this reference.

## 6.3 Consumer products vs. industrial/government

Personal privacy considerations present a unique set of considerations for consumer products as opposed to products that remain exclusively in the industrial/government sectors. Consumer privacy regulations shall be considered in the design and operation of every consumer level product-packaging scenario. Encryption and data security are addressed in [Clause 8](#).

# 7 Data content

## 7.1 Introduction

Subclauses 7.2 to 7.7 describe the data content of RFID tags for the product package layer. They identify, amongst other things,

- the data elements that shall or may be present on the tag,
- the way in which the data elements are identified (semantics),
- the representation of data elements in tag memory, and
- the placement of data elements in the memory of the tag.

## 7.2 System data elements

### 7.2.1 Unique product package identification

The first data element on a compliant tag shall be the unique identification described in ISO/IEC 15459-4. The length and nature of this unique identification is defined in this data element. For an ISO/IEC 18000-63, Type C and ISO/IEC 18000-3, Mode 3 compliant tag, the “unique identification” data element is segregated from any additional (user data) by the memory architecture. The unique identification data element shall be stored in UII memory (Bank 01), with any additional data being stored in user memory (Bank 11). For the purposes of this International Standard, a unique identifier of product packages can be up to 35 alphanumeric characters in length, excluding the Data Identifier (an3+an..35).

With the mutual agreement of the trading partners this length can be extended to 50 characters (an3+an..50). [Annex B](#) provides an in depth analysis of encoding.

### 7.2.2 Data semantics

Tags that only encode the unique product identity should conform to ISO/IEC 15961. This data structure will conform to Annex C. Tags containing complex data structures or larger data sets shall include semantics that conform to ISO/IEC 15418 and [Annex B](#) of this International Standard.

### 7.2.3 Data syntax

Tags that encode identity only are considered to have no syntax. Tags containing complex data structures or larger data sets shall conform to [Annex B](#) of this International Standard.

### 7.2.4 Tag character set

Tags using Data Identifiers shall employ characters from the character set 0, 1, 2, 3, 4, 5, 6, 7, 8, 9, A, B, C, D, E, F, G, H, I, J, K, L, M, N, O, P, Q, R, S, T, U, V, W, X, Y, Z, [ \ ], ; , < , = , > , ? , @ , ( , ) , \* , + , - , . , / , <GS> , <RS> , <FS> , <US> , <EOT> , and Space, as shown in Table B.1.

## 7.3 Tag structure

### 7.3.1 Unique product package identifiers

Memory Bank “01” of a product package shall contain either an ISO/IEC defined AFI or an EPC GS1 defined EPC. The ISO/IEC 15961, AFI for product package is 0xA2, in bits 0x18 – 0x1F as described in [Tables 1](#) and [4](#). Support for ISO standards (including AFIs) is indicated when bit 0x17 is set to “1”. Alternatively, support for GS1 EPC coding is indicated when bit 0x17 is set to “0” as described in the GS1 EPC Tag Data Standard.

NOTE A 96-bit SGTIN is represented by EPC header 0x30.

### 7.3.2 Tag memory

[Figure 3](#) provides a graphical representation of tag memory.



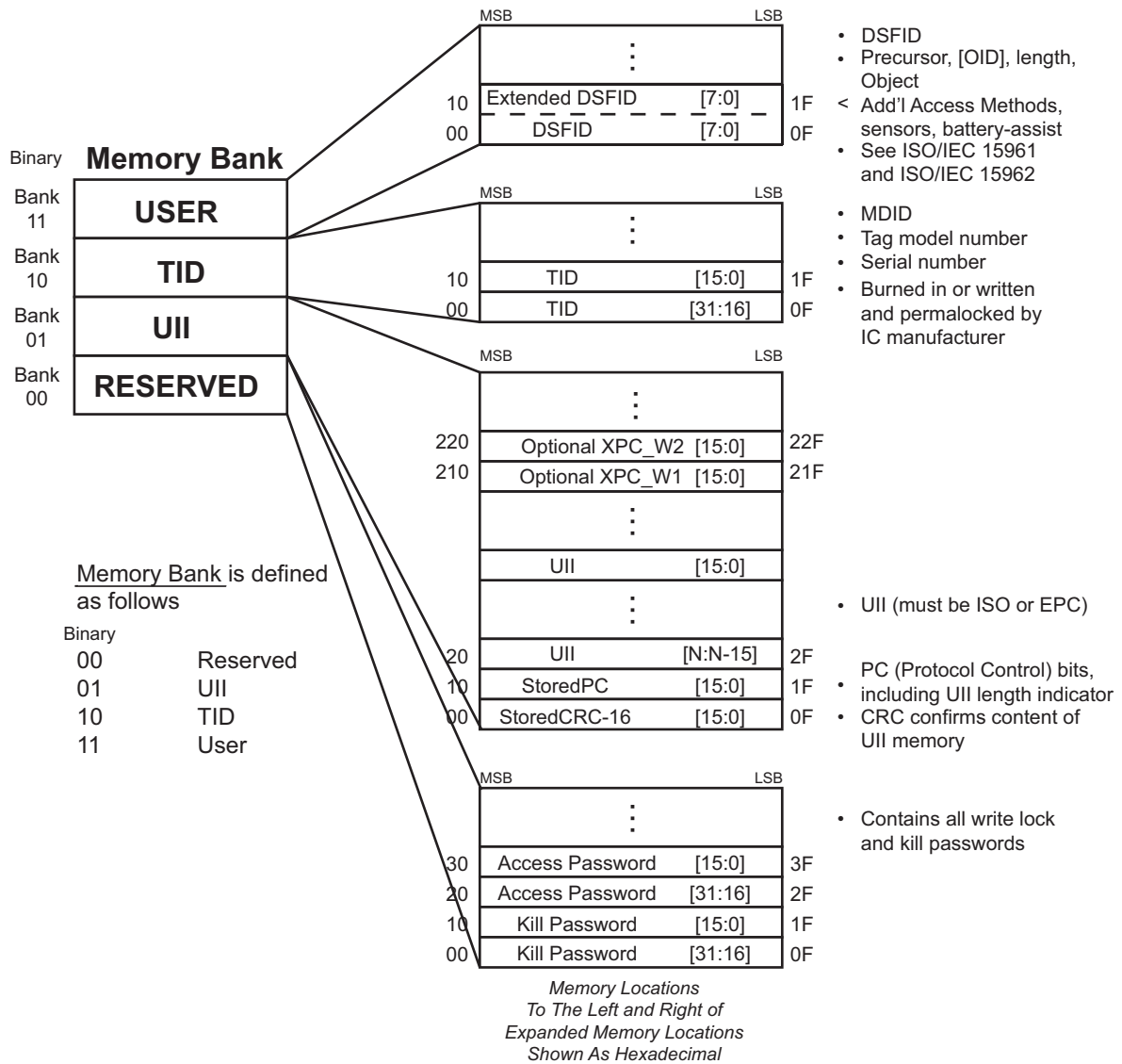

Figure 3 — Segmented memory map

### 7.3.3 Tag memory banks

Tag memory shall be logically separated into four distinct banks, each of which may comprise one or more memory words. A logical memory map is given in Figure 2. The memory banks are as follows.

- Reserved memory (MB00): shall contain the kill and access passwords. The kill password shall be stored at memory addresses 0x00 to 0x1F; the access password shall be stored at memory addresses 0x20 to 0x3F. If a tag does not implement the kill and/or access password(s), the tag shall act as though it had zero-valued password(s) that are permanently read/write locked, and the corresponding memory locations in reserved memory need not exist.
- UII memory (MB01): shall contain a CRC-16 at memory addresses 0x00 to 0x0F, Protocol-Control (PC) bits at memory addresses 0x10 to 0x1F, and a code, i.e. a UII, that identifies the object to which the tag is or will be attached beginning at address 0x20. The PC is subdivided (see Table 4 and Figure B.2). The CRC-16, PC, and UII shall be stored MSB first (the UII's MSB is stored in location 0x20).
- TID memory (MB10): shall contain an 8-bit ISO/IEC 15963 allocation class identifier at memory locations 0x00 to 0x07. TID memory shall contain sufficient identifying information above 0x07 for an Interrogator to uniquely identify the custom commands and/or optional features that a tag supports.

For EPC tags whose ISO/IEC 15963 allocation class identifier is 11100010<sub>2</sub>, this identifying information shall comprise a 12-bit tag mask-designer identifier at memory locations 0x08 to 0x13 and a 12-bit tag model number at memory locations 0x14 to 0x1F. Tags may contain tag- and vendor-specific data (for example, a tag serial number) in TID memory above 0x1F.

For ISO/IEC 15459-4 tags operating conformant to ISO/IEC 18000-63, Type C and whose ISO/IEC 15963 allocation class identifier is 11100000<sub>2</sub> (0xE0), this identifying information shall comprise an 8-bit IC manufacturer registration number at memory locations 0x08 to 0x0F and a 48-bit serial number allocated by the IC manufacturer from memory locations 0x10 to 0x3F.

For ISO/IEC 15459-4 tags operating conformant to ISO/IEC 18000-3, Mode 3 and whose ISO/IEC 15963 allocation class identifier is 11100000<sub>2</sub> (0xE0), this identifying information shall comprise an 8-bit IC manufacturer registration number at memory locations 0x08 to 0x0F and a 48-bit serial number allocated by the IC manufacturer from memory locations 0x10 to 0x3F.

For ISO/IEC 15459-4 tags operating conformant to ISO/IEC 18000-63, Type C or ISO/IEC 18000-3, Mode 3 and whose ISO/IEC 15963 allocation class identifier is 11100011<sub>2</sub> (0xE3), this identifying information shall comprise an 8-bit IC manufacturer registration number at memory locations 0x08 to 0x0F, a 16-bit user memory and size definition according to ISO/IEC 15963 from memory locations 0x10 to 0x1F, and a 48-bit serial number allocated by the IC manufacturer from memory locations 0x20 to 0x4F.

- d) User memory (MB11): allows user-specific data storage. The storage format described in ISO/IEC 15961 and ISO/IEC 15962 defines the memory organization. The presence of data in user memory in MB11 shall be indicated by the presence of a “1” in the 0x15 PC-bit. A zero in the 0x15 PC-bit shall indicate that there is no user memory at MB11 or that there is no data in MB11. Further information on MB11 can be found in [Annex B](#).

### 7.4 Protocol control (PC) bits

The PC bits contain physical-layer information that a tag backscatters with its UII during an inventory operation. There are 16 PC bits, stored in UII memory at addresses 0x10 to 0x1F, with bit values defined as follows:

- Bits 0x10 to 0x14: The length of the (PC + UII) that a tag backscatters, in words:
  - 0000<sub>2</sub>: one word (addresses 0x10 to 0x1F in UII memory).
  - 00001<sub>2</sub>: two words (addresses 0x10 to 0x2F in UII memory).
  - 00010<sub>2</sub>: three words (addresses 0x10 to 0x3F in UII memory).
  - 11111<sub>2</sub>: 32 words (addresses 0x10 to 0x20F in UII memory).
- Bit 0x15: User Memory; shall be set to “0” for tags without data in user memory (MB “11”) or tags without User Memory and shall be set to “1” for tags with data in user memory.
- Bit 0x16: Shall be set to “0” if there are no extended PC (XPC) bits or the XPC bits have a zero value and shall be set to “1” if the PC bits are extended by an additional 16 bits.

NOTE 1 If a tag implements XPC bits then PC bit 0x16 shall be the logical OR of the XPC bits contents. The tag computes this logical OR, and maps the result into PC bit 0x16, at power up. Readers can select on this bit, and tags will backscatter it.

NOTE 2 The XPC will be logically located at word 32 of UII memory. If a reader wants to select on the XPC bits, then it issues a Select command targeting this memory location.

- Bit 0x17: Shall be set to “0” if encoding an EPC and shall be set to “1” if encoding an ISO/IEC 15961, AFI in Bits 0x18 – 0x1F.
- Bits 0x18 – 0x1F: The Attribute bits whose default value is 00000000<sub>2</sub> and which may include an AFI as defined in ISO/IEC 15961 (when encoding the tag pursuant to ISO standards). The MSB of the

NSI is stored in memory location 0x18. Bit 0x1F has been designated within the GS1 EPC system to be used as an indicator that the product package contains Hazardous Materials.

The default (unprogrammed) PC value shall be 0x0000.

[Table 4](#) summarizes the content.

**Table 4 — Segmented memory: memory bank “01”**

Protocol Control bits run from 0x10 to 0x1F															
					0/1	0/1	0/1								
10	11	12	13	14	15	16	17	18	19	1A	1B	1C	1D	1E	1F
Length indicator				User memory		XPC bit	EPC/ISO bit = 1	ISO Application family identifier (AFI)							
Length indicator				User memory		XPC bit	EPC/ISO bit = 0	EPC Attribute bits							Haz Mat

## 7.5 Data elements

### 7.5.1 Unique product package identifier

The UII–Product package shall be present on all conformant product package tags. For non-retail tags, the unique product package identifier shall conform to ISO/IEC 15459-4 and shall be used as described in [5.3.2](#). For retail tags, the unique product package identifier shall conform to *GS1 EPC Tag Data Standard*, Version 1.6 for the SGTIN-96 and shall be used as described in [5.3.3](#).

### 7.5.2 Hazardous goods

RFID tags for product packaging that is classified as hazardous for storage, transportation or use shall contain a bit reference indicating that the item is hazardous. In addition, the tag, regulations and statutes may require a more detailed categorization of the hazard. The setting of this bit (“1”) directs the material handler to the included material safety data sheet. This additional categorization shall not be mandatory unless it provides an approved replacement for hazard data otherwise required by the requiring authority.

The specific hazardous goods code shall include the appropriate Data Identifier and qualifier. It shall be reflected in the user data memory. The presence of hazardous material for EPC product packages is indicated by bit “0x1F” of memory bank MB01 as defined in ISO/IEC 18000-63, Type C and ISO/IEC 18000-3, Mode 3. The presence of hazardous material for ISO product packages is indicated by the AFI “0xA5” in bits “0x18” to “0x1F” of memory bank MB01 as defined in ISO/IEC 18000-63, Type C and ISO/IEC 18000-3, Mode 3.

This International Standard does not supersede or replace any applicable safety or regulatory marking or labelling requirements. This International Standard is meant to satisfy the minimum product package identification requirements of numerous applications and industry groups. As such, its applicability is to a wide range of industries, each of which may have specific implementation guidelines for this International Standard. This International Standard is to be applied in addition to any other mandated labelling requirements.

### 7.5.3 Optional data

Dependent upon the tag type and capacity, optional data may be written to tags as required. Agreement between trading partners is not required. Optional data may be encrypted or otherwise secured at the discretion of the tag writer. Note that encrypted or secured data may not be readable by subsequent applications or users. Unless written in a read-only format or locked, optional data may be removed or changed by subsequent applications. Optional data shall be contained in an ISO/IEC 15434 envelope (syntax) and ISO/IEC 15418 semantics using ISO/IEC 15962. See [Annex B](#).

## 7.6 Traceability

Unique identification enables traceability. Traceability can relate to specific items yielding the ability to differentiate between like items and traceability can also relate to groups of like items differentiating them from unlike items.

Serialization schemes shall comply with ISO/IEC 15459-4.

Traceability of commodity items may be achieved by concatenating data elements representing the manufacturer, the part/model number and the lot or batch number assigned by the manufacturer.

## 7.7 Unique item serialization

Unique item identification shall be ensured by concatenating three elements of data: the Issuing Agency Code (IAC), an Enterprise Identifier (relating to the IAC), and a unique serialization as described in ISO/IEC 15459-4 using the rules of ISO/IEC 15459-3.

Product package RFID tag data formats shall utilize an AFI in bits 0x18 to 0x1F with bit 0x17 equal to "1". A listing of the valid AFIs can be found in [Table 1](#).

## 8 Data security

### 8.1 Confidentiality

Tag users desiring to have their tags read only by authorized users shall have the ability to secure/protect data written to a tag. The tag shall be capable of having secured/protected data written to it and read from it without interference from the tag design or structure. Use of this feature shall be at the discretion of the user. The type of security/protection to be utilized shall be commensurate with the degree of risk and vulnerability associated with the tag data, and shall be agreed upon between the enterprise writing to the tag and any/all authorized readers/users of the data.

### 8.2 Data integrity

Tags shall have the ability to prevent the alteration or erasure of data commonly known as *locking* data. This shall be at the discretion of the user. Locking of data shall be at the discretion of the user, except for Tag ID (MB10), which shall be locked by the manufacturer. A CRC-16 is required to enhance the integrity of the data. The location of the stored CRC-16 shall be as per the memory map in [Figure 2](#).

### 8.3 Interrogator authentication

A tag's data storage schemas for user memory and future data transfer protocols should provide for the user-enabled option to require authentication of the interrogator's authorization prior to reading the tag data.

### 8.4 Non-repudiation/audit trail

Tags shall be capable of supporting non-repudiation when programmed to provide non-forgable evidence that a specific action occurred.

### 8.5 Product authentication/anti-counterfeiting

RFID devices by themselves do not prevent counterfeiting; the serialization of product and a secure chain of custody can aid in anti-counterfeiting. MB10 shall be serialized and locked by the tag manufacturer. A locked serialized TID can aid in anti-counterfeiting.

## 9 Identification of RFID labelled material

RF tags and RF label inlays compliant with this International Standard shall include one or more of the internationally accepted RFID emblems. The accepted emblems given in [Figure 4](#) are examples of the RFID emblem and EPC seal as described in ISO/IEC 29160.



**Figure 4 — ISO and EPC RFID compliance emblems**

NOTE 1 The emblems above only represent the 860 – 960 MHz air interface for this application standard. Other air interface designations can be found in ISO/IEC 29160.

NOTE 2 These graphics can be scaled to the appropriate size and are available in either Dark on Light or Light on Dark.

## 10 Backup in case of RF tag failure

### 10.1 Human readable interpretation

Either human readable interpretation or human readable translation of Unique Item Identifiers is required.

ISO/IEC/TR 24729-1 shows how to encode within a 2D symbol everything that is in an RF tag. What is most likely needed, however, is to encode the same data in a 2D symbol and RF tag, so that a host computer receives the same information, regardless of media. This is accomplished by the means contained in [Annex B](#).

ISO standard two-dimensional symbols, e.g. Data Matrix ECC 200 or QR Code or with trading partner agreement PDF417, encoded in conformance with ISO/IEC 15434 and ISO/IEC 15418, should be considered as a primary backup to RF tags on products. An additional level of backup of human readable interpretation may be considered.

### 10.2 Human readable translation

HRI of either ISO or EPC tags shall be the upper case alphabetic and numeric representation of the encoded data as set forth in [Annex B](#).

Human readable translation of the data on the tag is selected data rather than complete data and may or may not contain data semantics. Human readable translation should be used when space constraints or privacy considerations do not permit the use of human readable interpretation.

### 10.3 Data titles

The use of data titles shall be as specified in ANS MH10.8.2 or the *GS1 General Specifications*.

### 10.4 Backup

Use of human readable information is strongly encouraged for data that is critical to the items use or sale and shall function as the first backup in the event that the RFID tag is unreadable/misleading for any reason. At the product package level trading partners shall agree upon a linear symbol such as Code

128 as described in ISO/IEC 15417 or U.P.C. as described in ISO/IEC 15420. Trading partners shall agree upon the two-dimensional symbol to be used such as Data Matrix, as described in ISO/IEC 16022 or QR Code, as described in ISO/IEC 18004.

If optically readable media is used, the respective International Standard shown in [Figure 5](#) shall be used.

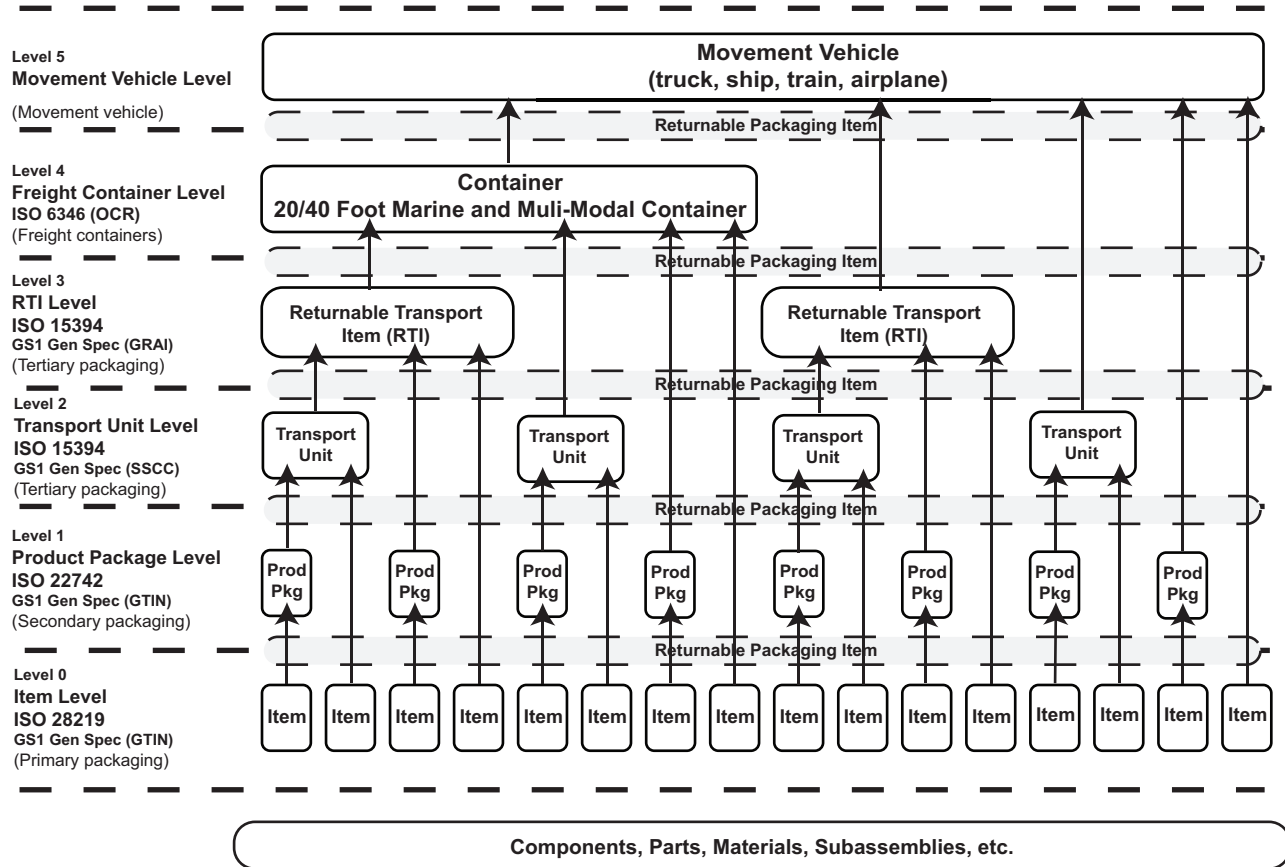

Figure 5 — Supply chain standards for bar codes and two-dimensional symbols

## 11 Tag operation

### 11.1 Data protocol

The data protocol for this International Standard shall support the requirements of [Annex B](#).

### 11.2 Minimum performance requirements (range and rate)

The performance for tags shall be measured in accordance with ISO/IEC 18046-3. Minimum performance requirements will vary for different functional applications of RFID. [Table 5](#) shows the typical performance requirements for passive tags to transfer tag data of up to 256 bits. These specifications also relate to the writing of the tag. Greater distances may be achieved in reading from RF tags than writing to RF tags.<sup>1)</sup> The performance for interrogator shall be measured in accordance with ISO/IEC 18046-2. The performance for systems shall be measured in accordance with ISO/IEC 18046-1.

1) In case regulatory restrictions provide less channels than there are interrogators in the environment, this performance can only be achieved by appropriate shielding of the interrogators against other interrogators.



Table 5 — Typical passive tag performance

Parameter	860 MHz to 960 MHz ISO/IEC 18000-63, Type C	13,56 MHz ISO/IEC 18000-3, Mode 3
How far? [Minimum supported read distance (in metres)]	3	0,7
How fast? [Minimum supported item speed when read (in kilometres per hour)]	16	16
How many? [Minimum supported effective measure of tag data transfer rate and ability to do anti-collision (in tags per second)]	200 <sup>a</sup> or 500 <sup>b</sup>	200
<sup>a</sup> This value corresponds to the 200 kHz bandwidth. <sup>b</sup> This value corresponds to the 500 kHz bandwidth.		

### 11.3 Environmental considerations

The operating environment will vary significantly by location. A description of various environmental factors associated with RFID can be found in ISO/IEC/TR 18001. Consideration will be given to the following general parameter set, as derived from the product packaging user community.

- The product package RFID tag must function properly in the temperature range from  $-40\text{ }^{\circ}\text{C}$  to  $+70\text{ }^{\circ}\text{C}$ . It must be able to endure for a specified period of time harsher conditions in the range  $-50\text{ }^{\circ}\text{C}$  to  $+85\text{ }^{\circ}\text{C}$ .
- Humidity 95 %.
- Warehouse construction, including racking.
- Transportation mode.
- Speed and direction of movement of tag relative to reader.
- Orientation of tag to reader (i.e. controlled or random).
- Read distance.
- Write distance (if applicable).
- Electro-magnetic interference from motors, fluorescent lights, other spectrum users.
- Electro-magnetic characteristics of the tagged item.
- Shape and size constraints on antenna, and any requirement to decouple antenna from tagged item.
- Form factor constraints in terms of size, shape, resistance to pressure, temperature, moisture, cleaning and contaminants (dust, oil [natural food, petroleum and synthetic], acids and alkalis).
- Method of attachment of form factor.
- Resistance of readers to heat, moisture, impact damage.
- Health and safety regulations.

A description of various environmental factors associated with RFID can also be found in ISO/IEC/TR 18001.

The performance of passive RFID (range and rate) can be adversely affected by the presence of metal and/or liquids in the container, transport unit or (packaged) product. Appropriate shielding can be used to reduce interference.

If the process requires read rates in excess of 200 tags/sec sequentially, parallel readings should be considered.

## 11.4 Tag orientation

It should be assumed that the handling operation is unable to predict the orientation of the individual (packed) products in higher levels of packaging and transport. This can hamper the effective use of the reading equipment on site and/or *en route*.

## 11.5 Packaging material

A wide range of materials (such as wood, metal, plastic, glass, paper and textile) is utilized in primary packaging and small and large product packages. Also, materials for coding and identification, as well as branding and the representation of legally required information, are used. These can interfere with the RFID equipment.

## 11.6 Shock loads and abrasions

Typically, the various product packages are subject to shock loads during the physical handling process. This can result in intentional or unintentional damage to the RFID tag. Placement and insertion of the tag should be done in such a way that damage due to shocks is minimized.

## 11.7 Tag lifetime

Tags attached to product packaging will be continuously used throughout the life of the product package. Product packaging RFID tags shall be capable of being continuously used throughout the life of the product package, without failure.

## 11.8 Minimum system reliability

Systems where tags are positioned, programmed and presented to reading equipment in accordance with the provisions of 11.3 and ISO/IEC 18046, shall have a minimum read reliability of 99,99 %, i.e. no more than one no-read event in 10 000 readings, and a read accuracy of 99,998 %, i.e. two undetected incorrect readings in 100 000 readings.

## 11.9 Air interface

Product packaging RFID tags shall operate in one of two frequency ranges and comply with the appropriate parts of ISO/IEC 18000. With agreement between trading partners, either ISO/IEC 18000-63, Type C or the ASK air interface of ISO/IEC 18000-3, Mode 3 may be used. It is recommended that tags supporting ISO/IEC 18000-63, Type C also be able to support ISO/IEC 18000-3, Mode 3.

## 11.10 Memory requirements for application

The memory requirements for product packaging RFID tags may be grouped into three basic categories: 96 bits, 256 bits, and greater than 256 bits. Industry surveys have yielded recommendations for RF chip manufacturers to provide for 2 Kbits and 4 Kbits. Use of alternative memory requirements shall not result in changes to the minimum and mandatory data elements of their format or tag data structure as otherwise specified in this International Standard. [Annex A](#) provides a listing of useful data fields for product life cycle management totalling 152 bytes (1 216 bits).

## 11.11 Sensor interface, if applicable

Sensors and batteries integrated into or onto a tag and their tag operations or management shall not interfere with the operation of the tag as required by this International Standard.

Sensor equipped Product Packaging RFID tags shall conform to ISO/IEC IEEE 21451-7 for the wired or wireless interface.

The 2,45 GHz O-QPSK option of ISO/IEC IEEE 8802-15-4 and ISO/IEC IEEE 21451-5 shall be used for the wireless interface between the tag/access point and the sensor.



### 11.12 Real time clock option

A real time clock shall be included with product packaging RFID tags that are sensor equipped and where the application requires a time stamp. The accuracy of the time compared to actual Coordinated Universal Time (UTC) shall be no worse than  $\pm$  five seconds per day. The representation of time shall be UTC (“Z” – Zulu) and formatted as described in ISO 8601, namely, yyyy-mm-ddThh:ssZ, for example 2012-01-01T14:55Z. When time is represented, the character “T” serves as the delimiter between “dd” and “hh”.

### 11.13 Safety and regulatory considerations

All tags, interrogators and antennas conforming to this International Standard shall meet the safety and regulatory requirements of the country where the technology is used. The use of passive or semi-passive (battery assisted) RFID tags shall also be restricted in hazardous environments, such as near or around explosives or flammable gasses, unless these devices have been certified as safe for such use by appropriate authorities.

All tags conforming to this International Standard shall meet national safety and regulatory requirements to include power, duty cycle and electromagnetic radiation.

### 11.14 Non-observable data

The nature of non-observable data is such that when individual data fields within a tag are protected by an interrogator command, the command may implement whatever protection measures are chosen, provided that the protection measures do nothing to impact, interfere with or deteriorate the operation of other tags in the supply chain.

### 11.15 Tag recyclability

All tags attached to or incorporated within the product packaging may be used to facilitate the recycling of the product, the packaging, and the tag itself. In this respect, it may also be feasible to reuse the tag after reprogramming, however without compromising the supply chain data structure. The exact implementation depends on cost of the tag and environmental implications of reuse/recycling. It will not be possible to use RF tags for recycling if the tags are “killed”.

The recyclability of product package tags described in this International Standard is dependent upon the component materials used in the individual tags. The tag manufacturer shall clearly mark product tags with recycling instructions or an appropriate logo to assist in the proper disposal of the tag. Guidelines for tag recyclability can be found in ISO/IEC/TR 24729-2.

### 11.16 Tag reusability

Technologically all RFID tags are theoretically reusable. Because of the unique identification aspects of product packaging, the permanent nature of the physical attachment of the tag, and the low cost of the tags themselves, product package level tags are generally not reusable for commercial retail items and commodity items.

High value and mission critical items may utilize higher functionality (read/write, larger memory, and possibly sensors) tags whose cost may justify their reuse. Tags intended for reuse shall clearly be marked with appropriate human readable characters or logos to enable identification, reclamation and return. Prior to reuse, reusable tags shall have their headers checked for data integrity and user memory cleared.

## 12 Tag location and presentation

Guidelines for tag location and presentation can be found in ISO/IEC/TR 24729-1.

## 12.1 Material on which the tag is mounted or inserted

The potential disturbance of metals and other reflective materials as well as liquids and other absorptive materials within the product packaging shall be considered in the design to minimize disturbance of the RF signal.

## 12.2 Geometry of the package/tag environment

RF tags should be affixed to the product package in such a way to minimize the disturbance of the RF signal. This pertains to both the product package and the products it is containing. See ISO/IEC/TR 24729-1.

## 13 Interrogator and reader requirements

### 13.1 Safety and regulatory considerations

All RFID tags and interrogators shall comply with IEEE C95-1 and ICNIRP Guidelines.

All interrogators and readers shall comply with the specific power, bandwidth and duty cycle requirements in addition to all of the local radio frequency regulations for the location in which they are used. In addition, all interrogators and readers intended for use in hazardous environments shall carry the appropriate specific information.

### 13.2 Data privacy

#### 13.2.1 Aggregated data

Security of aggregated data shall be the responsibility of the collector. Data collectors and data storage operators shall comply with all applicable personal privacy regulations and rules governing the collection, storage and dissemination of personal data. Personal data collected by or incident to the reading of an RFID tag shall be accorded the same protection and security as personal data collected by any other means.

#### 13.2.2 Company proprietary data

Security of product packaging data collected from or incident to the reading of a product packaging RFID tag is the responsibility of the company collecting the data. Companies wishing to restrict the collection of company proprietary data from product RFID tags shall utilize appropriate forms of data security. As security/protection of tag data can be compromised, use of RFID product packaging tags to carry sensitive, classified or proprietary data should be limited.

## 14 Interoperability, compatibility and non-interference with other RF systems

All RFID systems including tags, interrogators and readers shall operate on a strict non-interference basis with all other RF systems operating in the same spectrum. All RFID systems including tags, interrogators and readers claiming conformance with this International Standard shall be interoperable and compatible at the specific frequency designed.

## Annex A (informative)

### Table of useful data elements for product life cycle management

**Table A.1 — Useful data elements for product life cycle management**

Name	Classification	Item	Explanation	Bytes
TID	TID	TID	Tag Identification Number (ISO/IEC 15963)	(32 bits)
UII	UII	EPC	(SGTIN)	(96 bits)
	Product identification code assigned by manufacturers (ISO/IEC 15459-4)	Data Identifier	Serialized item number ("25S")	3+50
		Issuing Agency Code		
		Manufacturer code		
		Product code	Example: CF-L2M8WAXS	
		Serial number	Example: 3AKSB01019	
User memory	Internal code of manufacturers			30
	Hazardous material	Hazardous material flag	Hazardous material flag	1
		Products revision	Revision identification number of products	5
	Data for maintenance (This data is for maintenance person's use at consumer's office or home)	Maintenance contract date	Maintenance contract date between maintenance company and user (YYMMDD)	6
		Parts exchange flag	Flag that indicate some parts were exchanged for new parts	1
		Consumable supply flag	Consumable supply flag	1
		Supplies change date	Date consumable supplies put into service (YYMMDD)	6
		Durable hours	How many hours does supply be able to use	1
		Data for recycling (This data is used in a recycle phase and resale)	Recycle application date	Date that recycle application form was made (Date that user delivers recycle products to recycle company or carrier) YYMMDD
	Recycle application ID number		Number assigned to recycle product to identify each product.	11
	Product classification		Product classification flag (Classification example: Desktop PC, Laptop) This flag is used to pre-sort the products in recycle operation.	2
	Manufacturing date		Manufacturing date YYYYMMDD	8
	Durability period		Durable years from manufacturing date	2
	Resale date		Resale date of lease products (YYMMDD), Product no longer subject to manufacturer's guarantee.	6
	Resale dealer		Identification code of resale dealers	10
			Total	152 bytes

## Annex B (normative)

### Encoding

#### B.1 General

This International Standard recommends three possible forms of encoding for ISO/IEC 18000-63, Type C and ISO/IEC 18000-3, Mode 3 RF tags:

- an GS1 EPC compliant form for either or both the Unique Item Identifier (UII) in Memory Bank “01” and User Memory in Memory Bank “11”. The segmentation of Type C and Mode 3 tags is illustrated in [Figure B.1](#) below. EPC encoding is detailed in EPC TDS 1.6 and higher;
- a structure employing ISO/IEC 15962;
- a simplified structure, encoding an entire ISO/IEC 15434 message as a unit, employing a no directory, encoding six-bit defined in ISO/IEC 15962 as described in the remainder of this annex.

#### B.2 Basics

Each of these encoding forms can be unambiguously discerned from the other by the content of bits 0x17 through 0x1F of Memory Bank “01”, as illustrated in [Figure B.2](#), and bits 0x00 through 0x1F of Memory Bank “11”.

When ISO/IEC 15434 was created, it was intended to support all AIDC media, including RFID. As RFID developed, a completely different set of encoding schema was developed around a set of standards, ISO/IEC 15961 and ISO/IEC 15962.

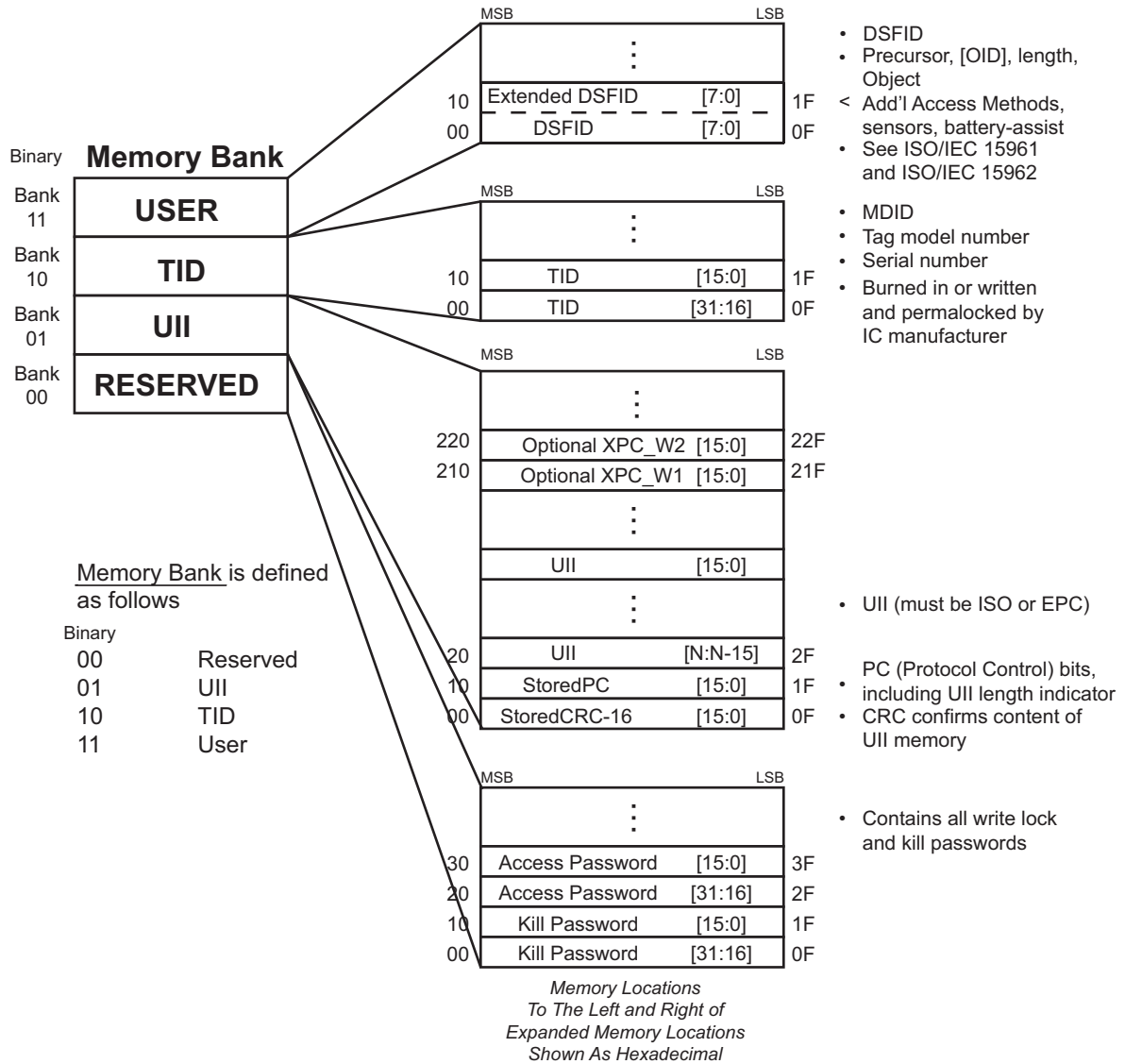

**Figure B.1 — Type C and Mode 3 Logical Memory Structure**

A key concept in this simplified encoding form, in both MB01 and MB11, is the use of a six-bit encoding as shown in Table B.1.

**Table B.1 — Six-bit encoding**

Space	100000	0	110000	@	000000	P	010000
<EOT>	100001	1	110001	A	000001	Q	010001
<Reserved>	100010	2	110010	B	000010	R	010010
<FS>	100011	3	110011	C	000011	S	010011
<US>	100100	4	110100	D	000100	T	010100
<Reserved>	100101	5	110101	E	000101	U	010101
<Reserved>	100110	6	110110	F	000110	V	010110
<Reserved>	100111	7	110111	G	000111	W	010111
(	101000	8	111000	H	001000	X	011000
)	101001	9	111001	I	001001	Y	011001
*	101010	:	111010	J	001010	Z	011010
+	101011	;	111011	K	001011	[	011011
,	101100	<	111100	L	001100	\	011100
-	101101	=	111101	M	001101	]	011101
.	101110	>	111110	N	001110	<GS>	011110
/	101111	?	111111	O	001111	<RS>	011111

NOTE Table B.1 is six-bit encoding created through the simple removal of the two high-order bits from the ISO 646-8-bit ASCII character set, save the shaded values. The shaded values are re-assigned, as provided, to minimize the bit count when using the ISO/IEC 15434 envelope.

The < Reserved > values in this table are not to be used without a re-issuance of this International Standard that reflects the defined values and functionality. An example would be a decision of the GS1 community to use this encoding and petitioning for the encoding of an ECI. Additionally, the presence of one or more of these characters might signal a different behaviour on the part of the decoder. While these < Reserved > values are not used in this iteration of this International Standard, they should not be used for any other purpose than defined by this International Standard.

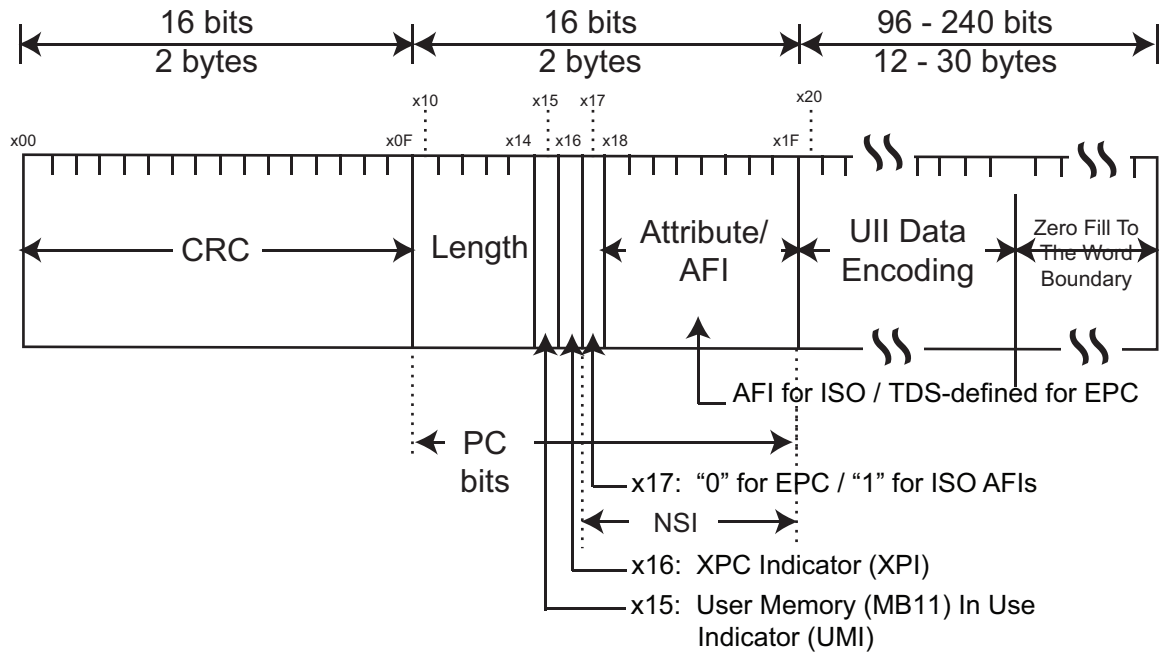

NOTE 1 User Memory (MB11) in Use Indicator (UMI).

NOTE 2 XPC Indicator.

NOTE 3 "0=Binary / 1=AFI+ISO/IEC 15459".

NOTE 4 AFI for ISO / TDS-defined for EPC / 29161 defined for ISO binary.

NOTE 5 Last bit of AFI for ISO / Haz Mat for EPC.

Figure B.2 — Type C and Mode 3 structure of Memory Bank "01"

### B.3 Encoding of Memory Bank "01" Unique Item Identifier

Bit 0x17 is the switch between ISO formats and EPC formats. When Bit 0x17 is set to a "0", the UII encoding is as per the GS1 EPC Tag Data Standard, Version 1.6. When Bit 0x17 is set to a "1", the UII encoding is as per ISO/IEC 15459 preceded by an ISO/IEC 15961, Application Family Identifier (AFI). The specific AFIs defined for the ISO 1736x series of International Standards are shown in [Table B.2](#).

Table B.2 — 1736x Application Family Identifiers (AFIs)

AFI	Assigned Organization or Function
0xA1	ISO 17367 product tagging
0xA2	ISO 17365 transport unit
0xA3	ISO 17364 returnable transport unit
0xA4	ISO 17367 product tagging, but for hazardous materials
0xA5	ISO 17366 product packaging
0xA6	ISO 17366 product packaging, but for hazardous materials
0xA7	ISO 17365 transport unit, but containing hazardous materials
0xA8	ISO 17364 returnable transport unit, but containing hazardous materials
0xA9	ISO 17363 freight containers
0xAA	ISO 17363 freight containers, but containing hazardous materials

For the purposes of illustration, encoding of a product is shown. Transport units would be identically encoded except for the AFI and the DI. A linear bar code symbol encoding the data providing unique item identification comprises the Data Identifier (DI), Issuing Agency Code (IAC), Company Identification (CIN), and Serial Number (SN). Such a unique item identification linear bar code would be represented in Code 128 as shown in [Figure B.3](#).

- DI = 25S
- IAC = UN (DUNS)
- CIN = 043325711
- SN = MH8031200000000001

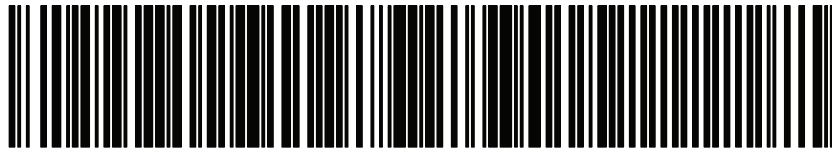

**Figure B.3 — Code 128 encoding “25SUN043325711MH8031200000000001”**

Adding the AFI to the structure for RFID purposes we have

- AFI = 0xA1
- DI = 25S
- IAC = UN (DUNS)
- CIN = 043325711
- SN = MH8031200000000001

Looking then at a completed data structure, using the encoding defined above and using DUNS as the Issuing Agency Code (IAC), we find that MB01, when encoding a Product, this data structure is 25SUN043325711MH8031200000000001 and is represented in MB01 as follows:

**Table B.3 — MB01 structure of AFI and UII (DUNS) Using Six-bit Encoding**

<b>AFI = 0xA1</b>			<b>2</b>	<b>5</b>	<b>S</b>	<b>U</b>	<b>N</b>	<b>0</b>	<b>4</b>	<b>3</b>	<b>3</b>	<b>2</b>	<b>5</b>	<b>7</b>	<b>1</b>
1010 0001			110010	110101	010011	010101	001110	110000	110100	110011	110011	110010	110101	110111	110001
<b>1</b>	<b>M</b>	<b>H</b>	<b>8</b>	<b>0</b>	<b>3</b>	<b>1</b>	<b>2</b>	<b>0</b>	<b>0</b>	<b>0</b>	<b>0</b>	<b>0</b>	<b>0</b>	<b>0</b>	<b>0</b>
110001	001101	001000	111000	110000	110011	110001	110010	110000	110000	110000	110000	110000	110000	110000	110000
<b>0</b>	<b>0</b>	<b>1</b>													
110000	110000	110001													

Alternatively, looking at a completed data structure using the encoding defined above, using ODETTE as the Issuing Agency Code (IAC), we find that MB01 when encoding a Product having an:

- AFI = 0xA1
- DI = 25S
- IAC = OD (ODETTE)
- CIN = CIN1

SN = 0000000RTIA1B2C3DOSN12345 (This example shows the SN composed of Object Type and Object Serial Number)



... we have an MB01 structure as shown in [Table B.4](#)

**Table B.4 — MB01 structure of AFI and UII (ODETTE) Using Six-bit Encoding**

AFI = 0xA1			2	5	S	O	D	C	I	N	1	0	0	0	0
1010 0001			110010	110101	010011	001111	000100	000011	001001	001110	110001	110000	110000	110000	110000
0	0	0	R	T	I	A	1	B	2	C	3	D	O	S	N
110000	110000	110000	010010	010100	001001	000001	110001	000010	110010	000011	110011	000100	001111	010011	001110
1	2	3	4	5											
110001	110010	110011	110100	110101											

In both cases, once the AFI is stripped from the message, the output of the RFID reader is identical to that of the linear bar code.

## B.4 Encoding of Memory Bank “11” User Memory

To indicate that data resides in MB11 (User Memory) bit 0x15 of MB01 is set to a “1”. Likewise, the presence of an AFI in MB01 cannot declare the format for MB11 because some users may choose to implement EPC encoding for MB01 and ISO encoding for MB11, in cases where MB01 is to be read by retailers and MB11 by industrial consumers. Further, it is preferable that there exists no confusion between the structures defined herein and those defined in ISO/IEC 15962. Consequently, MB11 must declare its access method and format.

### B.4.1 DSFID

Data encoding starts with the DSFID (Data Storage Format Identifier) that encodes the access method and Data-Format. When using direct ISO/IEC 15434 encoding, the DSFID is “0x03”. See [Figure B.4](#) for how this byte fits into the sequence of the first three encoded bytes.

#### B.4.1.1 Precursor byte

Data encoding continues with the Precursor and it encodes the extension bit in the most significant position, the compaction type (next three bits) and the ISO/IEC 15434 Format envelope (four least significant bits). For ISO/TC 122 applications the only permitted Precursor is byte “0 100 0110” or “0x46” (i.e. extension bit is a “0” in the case of no sensors or battery assist, a compaction type 4 which indicates use of the special 6-bit table defined in this annex and an ISO/IEC 15434 format envelope “06”). See [Figure B.4](#) for how this byte fits into the sequence of the first three encoded bytes.

#### B.4.1.2 Data byte-count indicator

Some air interface protocols allow for optimization in noisy environments by varying the number of bytes sent in each transmission. Therefore, it is useful to know at the beginning the number of bytes in tag memory that contain data. For many ISO/IEC 15434 DI data encoding applications, the number of bytes needed to encode the data will be a number less than 127 and therefore handled in one byte. For larger messages, two bytes are used where the first byte begins with “1” and the second byte begins with “0” as in ISO/IEC 15962:—, D.2. The number of bytes is encoded in the 14 remaining bits (e.g. 200 bytes is encoded as “10000001 01001000”).

For example, if a message contains 51 6-bit characters, it will be encoded in 39 bytes (i.e. the last bit of the last character is in the 39<sup>th</sup> byte and in this case there are six un-encoded bits which require padding). Therefore, the data byte-count indicator is “0x27”. See [Figure B.4](#) for how this byte fits into the sequence of the first three encoded bytes.

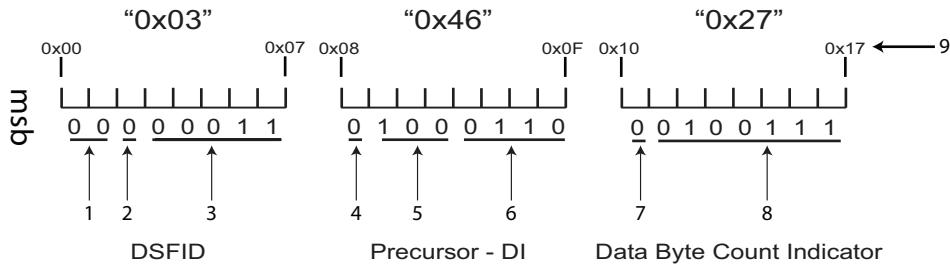

- NOTE 1 Access Method (#0 as listed in Table 7 of ISO/IEC 15962:—).
- NOTE 2 Extended Syntax – turns on additional byte of DSFID byte (turned off in this instance).
- NOTE 3 Data Format 03 (ISO/IEC 15434).
- NOTE 4 Extension Bit – not specified in this example.
- NOTE 5 Compaction bits (indicating 6-bit table).
- NOTE 6 Format Envelope (specifically DI “06”).
- NOTE 7 Byte Count Indicator switch (set to “0” to signify final byte of byte count).
- NOTE 8 Bit values for Byte Count Indicator (variable based on length of data).
- NOTE 9 Physical memory addresses (0x00, 0x07, 0x08, 0x0F, 0x10, and 0x17).
- NOTE 10 For the purpose of the above example battery-assist and sensors are shown as not present.

Figure B.4 — Type C and Mode 3 Structure of Memory Bank “11” 1<sup>st</sup> 24 bits

## B.5 Encoding and decoding

### B.5.1 Encode process

- Starting with a valid ISO/IEC 15434 DI message, strip “[ ] > RS 06 GS” from the front and “<RS> <EOT>” from the end.
- Convert every data character into its code value using Table B.1.
- When encoding multiple “06” Format Envelopes (e.g. to represent a message containing several “records” from the same data format in order to describe the subassemblies of a complex part) reduce each internal 15434 sequence “<RS> <06> <GS>” indicating a new “record” to a single <RS> character (encoded as “011111” from Table B.1).
- Encode an <EOT> pattern after the last encoded data character.
- Lay out the 6-bit characters as bits and then group them into 8-bit bytes.
- Add the first 2 or 4 bits of an <EOT> character (i.e. “10” or “1000”) or the entire <EOT> character (i.e. “100001” from the 6-bit character set) to fill un-encoded bits in the last byte, if any, as padding bits.
- Determine the byte number that contains the last bit of the <EOT> character, convert the decimal count into binary and encode explicitly as the data byte-count indicator.
- Encode the DSFID, Precursor, data byte-count indicator, data, <EOT> and padding bits (if any) into memory.

NOTE Because only one ISO/IEC 15434 message is allowed to be encoded in a single RFID data carrier, there is no need to encode a zero byte as a terminator after the last data byte.

## B.5.2 Decode process

1. Examine the DSFID and Precursor bytes and verify that they are equivalent to “0x03 0x46”.
2. Process the next 8 bits and convert the resulting data byte-count indicator to a decimal value to determine the number of bytes containing data.
3. Starting with the next bit, group the following bits into character bit-sets from the 6-bit code table and continue until the number of bytes containing data has been parsed.
4. Assign data characters according to Table B.1 and delete all complete and incomplete <EOT> characters from the end.
5. For any encoded <RS> character that is not immediately followed by “06” and a <GS> character, expand the <RS> to “RS 06 GS”.
6. Add “[ ] > RS 06 GS” to the beginning of the transmission and “RS EOT” at the end.
7. Transmit the entire ISO/IEC 15434 compliant message. Optionally, the receiver may wrap the ISO/IEC 15434 message in an OID format as a single data object. When using this option, the complete OID of the message is {1 0 15434 06}.

## B.6 Encoding and decoding example

### B.6.1 Translation and encoding procedure from ISO/IEC 15434 data to Access Method 0 Data Format 3

To prepare a typical DI input message in ISO/IEC 15434 format for encoding using ISO/IEC 15962 Access Method 0 Data-Format 3, the following steps are performed.

Verify that the input message is a valid ISO/IEC 15434 DI message.

The DSFID indicating Access Method 0 and Data Format 3 is encoded.

The leading message envelope characters “[ ] > RS 06 GS” and the trailing “RS EOT” are discarded.

The data is encoded into 6-bit codewords from Table B.1.

Add an <EOT> character.

Add part or all of an <EOT> to fill the last data byte, if necessary.

Encode the DSFID, Precursor, data byte-count indicator, data, <EOT> and padding into memory.

### B.6.2 Decoding and Translation procedure from Access Method 0 Data-Format 3 to ISO/IEC 15434 data

The system will see this information as ISO/IEC 15434-6-bit DI data by reading the DSFID byte.

The system discards the DSFID, Precursor and data byte-count indicator at the beginning.

The encoded bytes are parsed into 6-bit codes, discarding any pad bits and the encoded <EOT> character, and then into data according to Table B.1.

The system adds “[ ] > RS 06 GS” to the beginning of the transmission and “RS EOT” at the end.

The system transmits the entire ISO/IEC 15434 compliant message.

Optionally, the receiver may wrap the entire ISO/IEC 15434 message in an OID format as a single data object.

**B.6.3 Data encode and decode example**

The following example encodes ISO/IEC 15434 DI data in an application with a mandatory <EOT> requirement.

Starting data:

[]><RS>06<GS>25SUN043325711MH8031200000000001 <GS>1T110780<GS>Q21<GS>4LUS<RS><EOT>

The data on the tag from the above message is as follows (with DIs in bold font):

**25**SUN043325711MH8031200000000001 <GS> **1T**110780 <GS> **Q**21 <GS> **4L**US <EOT>

Where:

UII = **25**SUN043325711MH8031200000000001

LOT = **1T**110780

QTY = **Q**21

CoO = **4L**US

Data to bit conversion:

There are 51 6-bit characters (50 plus <EOT> ), which translates to 39 data-bytes. There is a need to fill six trailing bits for byte alignment so in this case an entire <EOT> character is encoded. See [Table B.5](#).

**Table B.5 — Type C and Mode 3 Structure of Memory Bank “11” 1st 16 bits**

DSFID = 0x03	Precursor = 0x46	Data byte count = 0x27	2	5	S	U	N	0	4	3	3	2	5
00000011	01000110	00100111	110010	110101	010011	010101	001110	110000	110100	110011	110011	110010	110101
<b>7</b>	<b>1</b>	<b>1</b>	<b>M</b>	<b>H</b>	<b>8</b>	<b>0</b>	<b>3</b>	<b>1</b>	<b>2</b>	<b>0</b>	<b>0</b>	<b>0</b>	<b>0</b>
110111	110001	110001	001101	001000	111000	110000	110011	110001	110010	110000	110000	110000	110000
<b>0</b>	<b>0</b>	<b>0</b>	<b>0</b>	<b>0</b>	<b>0</b>	<b>1</b>	<GS>	<b>1</b>	<b>T</b>	<b>1</b>	<b>1</b>	<b>0</b>	<b>7</b>
110000	110000	110000	110000	110000	110000	110001	011110	110001	010100	110001	110001	110000	110111
<b>8</b>	<b>0</b>	<GS>	<b>Q</b>	<b>2</b>	<b>1</b>	<GS>	<b>4</b>	<b>L</b>	<b>U</b>	<b>S</b>	<EOT>	<b>pad</b>	
111000	110000	011110	010001	110010	110001	011110	110100	001100	010101	010011	100001	100001	

**B.6.3.1 Complete contents of tag memory**

Using the Access Method 0 Format 3 encoding, including a DSFID, ISO/IEC 15434 Precursor byte, 39 bytes of data (compressing 51 6-bit characters including the <EOT> ), and six pad bits, the final tag encodation in hexadecimal is as follows.

03 46 27 CB 54 D5 3B 0D 33 CF 2D 77 C7 13 48 E3 0C F1 CB 0C 30 C3 0C 30 C3 0C 31 7B 15 31 C7 0D F8 C1 E4 72 C5 ED 0C 55 38 61

**B.6.3.2 Transmitted data**

The header characters and the “<RS> <EOT>” are reinserted into the message. The following data string is transmitted from the reader.

[]> R<sub>S</sub> 06 G<sub>S</sub> 25SUN043325711MH8031200000000001 G<sub>S</sub> 1T110780 G<sub>S</sub> Q21 G<sub>S</sub> 4LUS R<sub>S</sub> EOT

### B.6.3.3 Conclusion

When encoded in a 2D symbol, the output would be identical:

[ ]><RS>06<GS>25SUN043325711MH8031200000000001 <GS>1T110780<GS>Q21<GS>4LUS<RS><EOT>



**Figure B.5** — QR Code encoding the contents of MB01 and MB11 [ ]><RS>06<GS>25SUN043325711MH8031200000000001 <GS>1T110780<GS>Q21<GS>4LUS<RS><EOT>

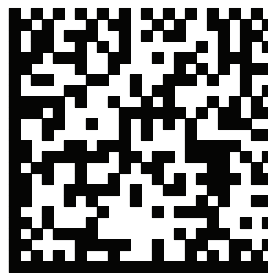

**Figure B.6** — DataMatrix encoding the contents of MB01 and MB11 [ ]><RS>06<GS>25SUN043325711MH8031200000000001 <GS>1T110780<GS>Q21<GS>4LUS<RS><EOT>

## Bibliography

- [1] ISO 3166-1, *Codes for the representation of names of countries and their subdivisions — Part 1: Country codes*
- [2] ISO 15394, *Packaging — Bar code and two-dimensional symbols for shipping, transport and receiving labels*
- [3] ISO/IEC 15417, *Information technology — Automatic identification and data capture techniques — Code 128 bar code symbology specification*
- [4] ISO/IEC 15420, *Information technology — Automatic identification and data capture techniques — EAN/UPC bar code symbology specification*
- [5] ISO/IEC 15459 (all parts), *Information technology — Automatic identification and data capture techniques — Unique identification*
- [6] ISO 17363, *Supply chain applications of RFID — Freight containers*
- [7] ISO 17364, *Supply chain applications of RFID — Returnable transport items (RTIs) and returnable packaging items (RPIs)*
- [8] ISO 17365:2013, *Supply chain applications of RFID — Transport units*
- [9] ISO 17367, *Supply chain applications of RFID — Product tagging*
- [10] ISO/IEC 18000 (all parts), *Information technology — Radio frequency identification for item management*
- [11] ISO 18185 (all parts), *Freight containers — Electronic seals*
- [12] ISO 22742, *Packaging — Linear bar code and two-dimensional symbols for product packaging*
- [13] ISO/IEC/TR 24729-2, *Information technology — Radio frequency identification for item management — Implementation guidelines — Part 2: Recycling and RFID tags*
- [14] ISO/IEC 29160, *Information technology — Radio frequency identification for item management — RFID Emblem*
- [15] AIM Global Standard for the use of the AIM RFID Emblem and index to identify RFID-enabled labels
- [16] EPC™, *Radio-Frequency Identity Protocols Class-1 Generation — 2 UHF RFID Protocol for Communications at 860 MHz — 960 MHz, Version 1.0.9*
- [17] GS1 EPC, *Tag Notification Brand Guidelines*
- [18] IEEE 1451.7, *Smart Transducer Interface for Sensors and Actuators — Transducers to Radio Frequency Identification (RFID) Systems Communication Protocols and Transducer Electronic Data Sheet Formats*
- [19] IEEE 1451.5, *Information technology — Smart Transducer Interface for Sensors and Actuators — Wireless Communication Protocols and Transducer Electronic Data Sheet (TEDS) Formats*

11/30/2013 22:41:16 MST

