

INTERNATIONAL
STANDARD

ISO
17233

IULTCS/IUP 29

Second edition
2017-02

**Leather — Physical and mechanical
tests — Determination of cold crack
temperature of surface coatings**

*Cuir — Essais physiques et mécaniques — Détermination de la
température de fissuration à froid des revêtements de surface*



Reference numbers
ISO 17233:2017(E)
IULTCS/IUP 29:2017(E)

© ISO 2017



COPYRIGHT PROTECTED DOCUMENT

© ISO 2017, Published in Switzerland

All rights reserved. Unless otherwise specified, no part of this publication may be reproduced or utilized otherwise in any form or by any means, electronic or mechanical, including photocopying, or posting on the internet or an intranet, without prior written permission. Permission can be requested from either ISO at the address below or ISO's member body in the country of the requester.

ISO copyright office
Ch. de Blandonnet 8 • CP 401
CH-1214 Vernier, Geneva, Switzerland
Tel. +41 22 749 01 11
Fax +41 22 749 09 47
copyright@iso.org
www.iso.org

Contents

	Page
Foreword	iv
1 Scope	1
2 Normative references	1
3 Terms and definitions	1
4 Principle	1
5 Apparatus and materials	1
6 Sampling and sample preparation	2
7 Procedure	3
8 Test report	4
Annex A (informative) Example for fixing test pieces with adhesive tape	5

Foreword

ISO (the International Organization for Standardization) is a worldwide federation of national standards bodies (ISO member bodies). The work of preparing International Standards is normally carried out through ISO technical committees. Each member body interested in a subject for which a technical committee has been established has the right to be represented on that committee. International organizations, governmental and non-governmental, in liaison with ISO, also take part in the work. ISO collaborates closely with the International Electrotechnical Commission (IEC) on all matters of electrotechnical standardization.

The procedures used to develop this document and those intended for its further maintenance are described in the ISO/IEC Directives, Part 1. In particular the different approval criteria needed for the different types of ISO documents should be noted. This document was drafted in accordance with the editorial rules of the ISO/IEC Directives, Part 2 (see www.iso.org/directives).

Attention is drawn to the possibility that some of the elements of this document may be the subject of patent rights. ISO shall not be held responsible for identifying any or all such patent rights. Details of any patent rights identified during the development of the document will be in the Introduction and/or on the ISO list of patent declarations received (see www.iso.org/patents).

Any trade name used in this document is information given for the convenience of users and does not constitute an endorsement.

For an explanation on the meaning of ISO specific terms and expressions related to conformity assessment, as well as information about ISO's adherence to the World Trade Organization (WTO) principles in the Technical Barriers to Trade (TBT) see the following URL: www.iso.org/iso/foreword.html.

ISO 17233 was prepared by the Physical Test Commission of the International Union of Leather Technologists and Chemists Societies (IUP Commission, IULTCS), in collaboration with the European Committee for Standardization (CEN) Technical Committee CEN/TC 289, *Leather*, the secretariat of which is held by UNI, in accordance with the Agreement on technical cooperation between ISO and CEN (Vienna Agreement).

It is based on IUP 29 originally published in *J. Soc. Leather Tech. Chem.*, **69**, p. 85, (1985) and declared an official method of the IULTCS in 1987. This updated version was published in *J. Soc. Leather Tech. Chem.*, **84**, p. 369, (2000) and reconfirmed as an official method in March 2001. The same principle is used but the text has been updated and includes the number of test pieces to be taken.

IULTCS, originally formed in 1897, is a world-wide organization of professional leather societies to further the advancement of leather science and technology. IULTCS has three Commissions, which are responsible for establishing international methods for the sampling and testing of leather. ISO recognizes IULTCS as an international standardizing body for the preparation of test methods for leather.

This second edition cancels and replaces the first edition (ISO 17233:2002), which has been technically revised with the following changes:

- the cooled chamber (5.1) and the hinged sample holder (5.3) have been specified more precisely;
- the number of test pieces has been changed to six for each temperature tested and a number of associated changes has been made;
- in addition to the fixing of samples with screws, it is now also possible to fix the samples with adhesive tape.

Leather — Physical and mechanical tests — Determination of cold crack temperature of surface coatings

1 Scope

This document specifies a method for determining the cold crack temperature of surface coatings applied to leather. It is applicable to all leathers which have a surface coating and which can be easily flexed.

2 Normative references

The following documents are referred to in the text in such a way that some or all of their content constitutes requirements of this document. For dated references, only the edition cited applies. For undated references, the latest edition of the referenced document (including any amendments) applies.

ISO 2418, *Leather — Chemical, physical and mechanical and fastness tests — Sampling location*

ISO 2419, *Leather — Physical and mechanical tests — Sample preparation and conditioning*

EN 15987, *Leather — Terminology — Key definitions for the leather trade*

3 Terms and definitions

For the purposes of this document, the terms and definitions given in EN 15987 apply.

ISO and IEC maintain terminological databases for use in standardization at the following addresses:

- IEC Electropedia: available at <http://www.electropedia.org/>
- ISO Online browsing platform: available at <http://www.iso.org/obp>

4 Principle

A strip of leather is held in a hinged apparatus in a cooled chamber at a given temperature. The hinged apparatus is closed rapidly causing the leather to be folded with the surface coating outwards. The leather is examined to determine if the surface coating has cracked.

5 Apparatus and materials

5.1 Cooled chamber, minimum internal height 500 mm and minimum internal width and depth 300 mm, fitted with a rack or other support and capable of maintaining temperatures between +5 °C and –30 °C and of controlling the temperature to ± 2 °C at any temperature within the range. The design of the chamber shall allow free circulation of air around the test piece and holder.

The cooled chamber should have the door on the top. If a cooled chamber with the door on the front is used, the chamber or sample holder (5.3) shall incorporate a mechanism to enable the sample holder (5.3) to be snapped shut without opening the front door.

5.2 Temperature measuring device, readable to 1 °C and operating between at least +5 °C and –30 °C.

5.3 Hinged sample holder, of the type and dimensions shown in [Figure 1](#) and capable of holding at least six test pieces without them touching each other. All fixings on the inside shall be flush with the inner surface so as not to present any obstruction when the sample holder is closed.

Sample holder for fixing the test pieces with an adhesive tape shall have suitable marks (auxiliary lines) for positioning the test pieces (see [Figure 1](#) and [Annex A](#)).

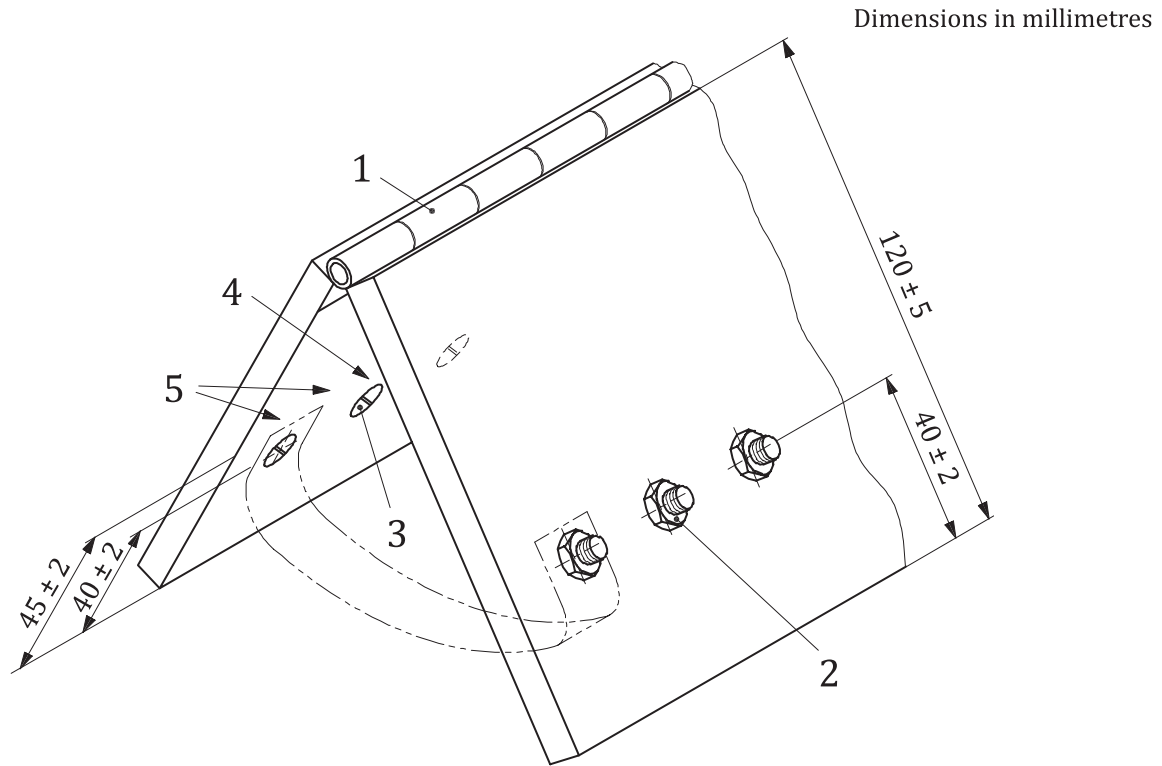

Key

- 1 hinge
- 2 securing nut
- 3 countersunk bolt
- 4 line parallel to the hinge for positioning of test pieces (for method with adhesive tape only)
- 5 auxiliary line for positioning of test pieces (for method with adhesive tape only)

Figure 1 — Hinged sample holder shown prior to snapping shut

5.4 Press knife, conforming to ISO 2419, capable of punching a rectangular test piece (90 ± 1) mm × (10 ± 1) mm.

5.5 Magnifier, with a magnification of 4 to 6 times.

5.6 Adhesive tape, suitable to fix leather down to -30 °C.

6 Sampling and sample preparation

6.1 Sample in accordance with ISO 2418.

6.2 Cut test pieces by applying the press knife ([5.4](#)) to the coated surface. For each temperature to be tested, cut six test pieces from each sample, three with the long edge of the press knife parallel to, and

three perpendicular to, the backbone. If the direction of the backbone is not known, then cut the two sets of three samples at right angles to each other.

If there is a requirement for more than two hides or skins to be tested in one batch, then only one test piece in each direction needs to be taken from each hide or skin, provided that the overall total is not less than three test pieces in each direction.

6.3 Cut a circular hole of diameter $(5,0 \pm 0,5)$ mm, with the centre of the hole $(6,0 \pm 0,5)$ mm from each end of the test piece (see [6.2](#)).

NOTE It is not necessary to cut holes in the test pieces if test pieces are fixed with an adhesive tape.

7 Procedure

7.1 Insert the six test pieces from the sample into the hinged sample holder ([5.3](#)) with the surface coating facing towards the open end of the sample holder. Test pieces from two different samples should not be tested together in the same hinged sample holder unless they are of similar thickness as thin test pieces will not be adequately flexed if tested with substantially thicker test pieces.

NOTE An example for fixing the test pieces with an adhesive tape is described in [Annex A](#).

7.2 Adjust the temperature of the cooled chamber to (5 ± 2) °C and then maintain this temperature for at least 30 min.

NOTE Some industry specifications require testing only at one specific temperature (see [7.7](#)), in which case, the cooled chamber is adjusted to the specified temperature.

7.3 Place the hinged sample holder ([5.3](#)) in the orientation shown in [Figure 1](#), with the hinge at the top and the two plates splayed wide to straighten the test pieces without putting them under tension or causing the adhesive tape, if used, to peel away from either plate, in the cooled chamber ([5.1](#)). Close the cooled chamber and leave for at least 60 min.

7.4 Open the cooled chamber and, while still in the chamber, immediately snap shut the hinged sample holder as rapidly as possible, applying a firm pressure. If a cooled chamber with a door on the front is used, do not open the door but activate the appropriate mechanism to snap the hinged sample holder shut while keeping the door closed.

7.5 Remove the sample holder from the cooled chamber and allow to return to room temperature. Examine the flexed arc of the test piece for the presence of cracks using the magnifier ([5.5](#)).

NOTE The cracks are normally linear but with thin surface coatings follow the underlying grain pattern of the leather.

7.6 If the surface coating of five or six test pieces is undamaged, replace the test pieces with a set of six fresh test pieces. Repeat [7.2](#) to [7.5](#) at a temperature of (0 ± 2) °C.

7.7 If the surface coating of five or six test pieces remains undamaged, repeat [7.2](#) to [7.6](#) at temperatures of (-5 ± 2) °C, (-10 ± 2) °C, (-15 ± 2) °C, (-20 ± 2) °C, (-25 ± 2) °C and (-30 ± 2) °C using a set of six fresh test pieces in each case, until the surface coating of at least two test pieces cracks.

7.8 Record the temperature at which the surface coating of at least two test pieces cracks. If the surface coating does not crack when tested at -30 °C, record a result of $<(-30 \pm 2)$ °C.

NOTE If the surface coating has fine cracks before testing (such as those due to dry milling), there is no clear end point as it is difficult to distinguish cracks produced in the test from those present already.

8 Test report

The test report shall include the following:

- a) a reference to this document, i.e. ISO 17233:2017;
- b) the highest temperature at which the surface coatings of at least two test pieces of the leather showed cracks;
- c) if the test is carried out only at one specified temperature, the number of test pieces that showed cracking and a description of the observed cracking for each single test piece;
- d) any deviation from the method specified in this document;
- e) full details for identification of the sample and any deviations from ISO 2418 with respect to sampling.

Annex A (informative)

Example for fixing test pieces with adhesive tape

A.1 An example for fixing the test pieces with an adhesive tape is described in nine steps as described in [A.2](#) to [A.10](#).

A.2 Step 1

Mark a line parallel to the hinge of the holder in a distance of 45 mm from the unhinged edge. See [Figure A.1](#).

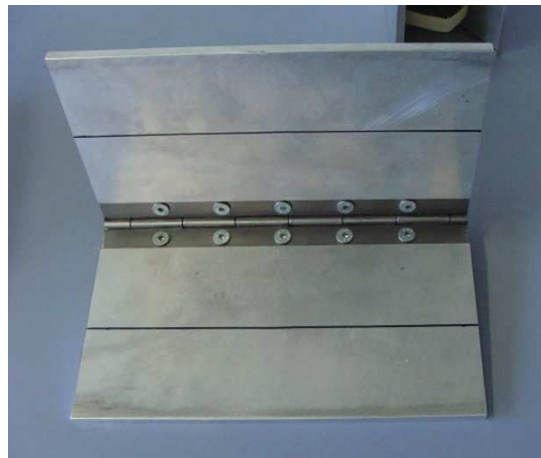

Figure A.1 — Step 1

A.3 Step 2

Mark auxiliary lines perpendicular to the hinge to help align the samples. See [Figure A.2](#).

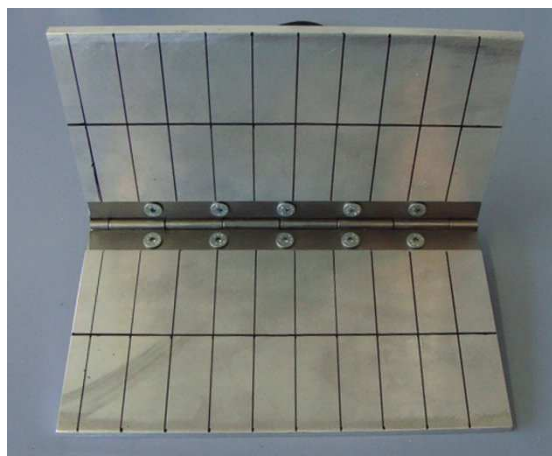

Figure A.2 — Step 2

A.4 Step 3

Align the samples parallel to one another at the edge of the holder with the test side down. The distance between the samples should be at least 15 mm. See [Figure A.3](#).

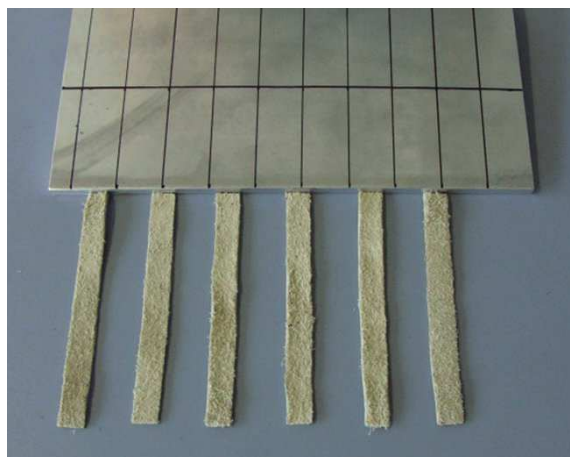
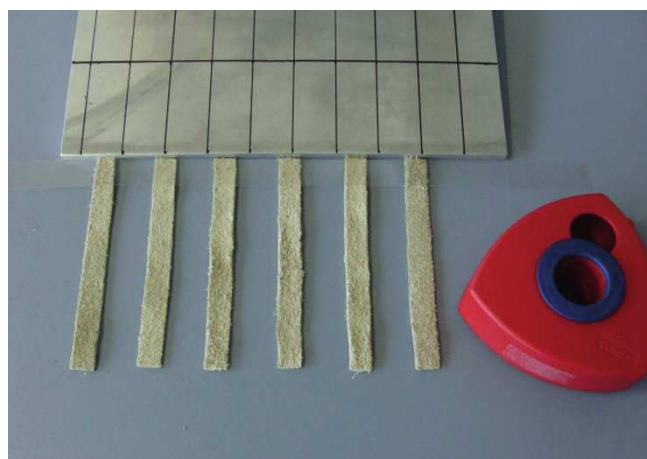

Figure A.3 — Step 3

A.5 Step 4

Fix a strip of adhesive tape on the sample at the point where they contact against the edge of the holder. The strip of adhesive tape should be longer than the holder [see [Figure A.4 a](#)]. Press the adhesive tape firmly on the sample [see [Figure A.4 b](#)].



a)

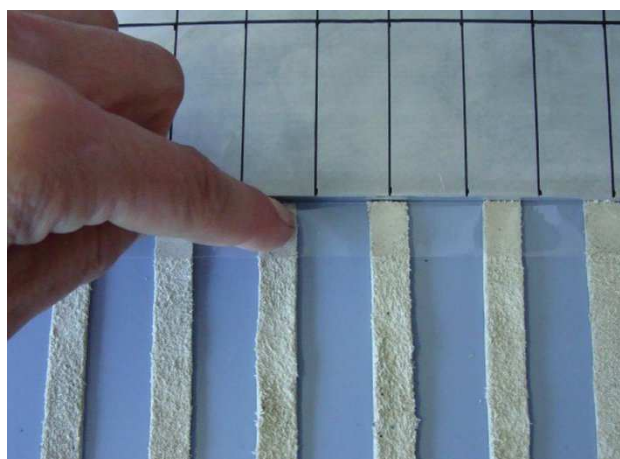

b)

Figure A.4 — Step 4

A.6 Step 5

Move the fixed samples to the marked line on the holder. Be careful to use the auxiliary line for alignment [see [Figure A.5 a](#))]. Fix the adhesive tape between the samples on the holder [see [Figure A.5 b](#))].

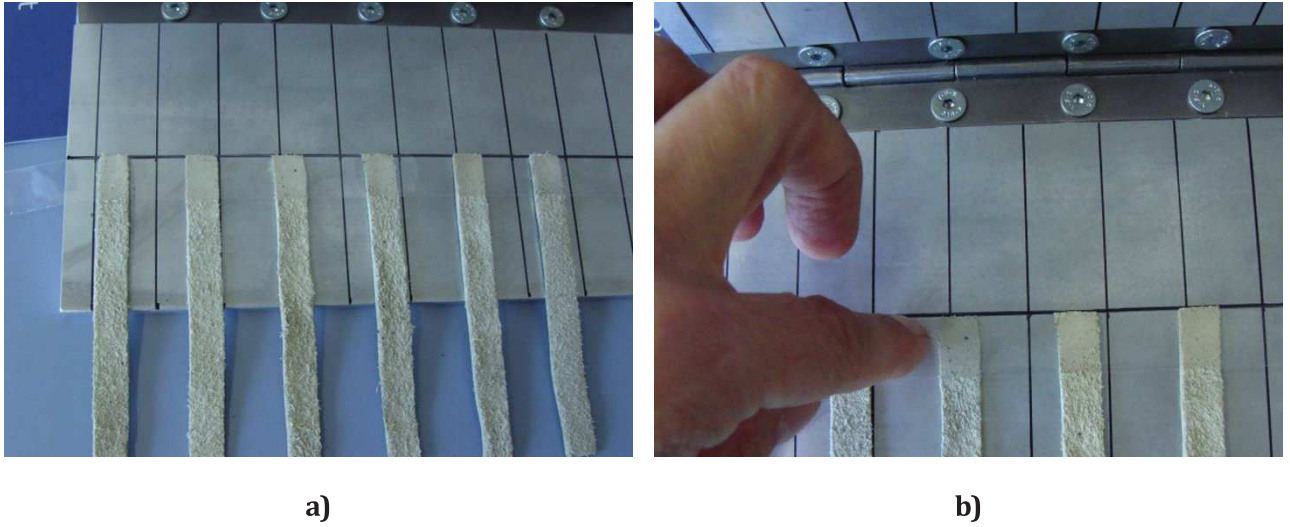

Figure A.5 — Step 5

A.7 Step 6

Fix the end of the adhesive tape strip on the holder back side. See [Figure A.6](#).

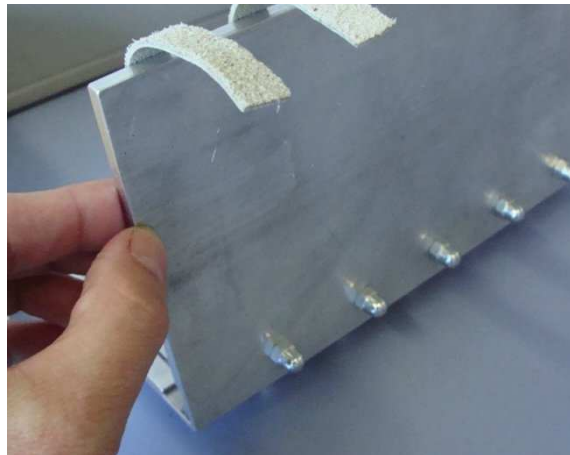

Figure A.6 — Step 6

A.8 Step 7

Fix another long adhesive tape strip along the opposite ends of the samples and press it firmly on the samples. See [Figure A.7](#).



Figure A.7 — Step 7

A.9 Step 8

Take the adhesive tape strip on both ends and move it to bend the samples in half. The both ends should cover each other as exactly as possible to make following tests comparable. Keep the adhesive tape strip slightly stretched [see [Figure A.8 a\)](#)]. Then close the holder without pressure [see [Figure A.8 b\)](#)].

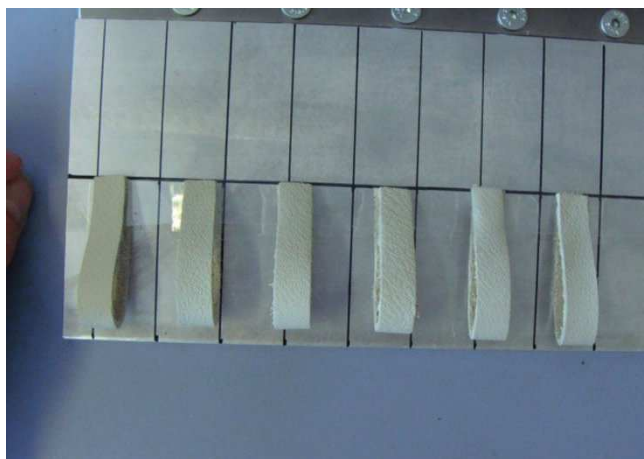

a)



b)

Figure A.8 — Step 8

A.10 Step 9

Turn the holder, fix the ends of the adhesive tape strip on the back side [see [Figure A.9 a\)](#)] and press the adhesive tape between the samples firmly to the holder [see [Figure A.9 b\)](#)].

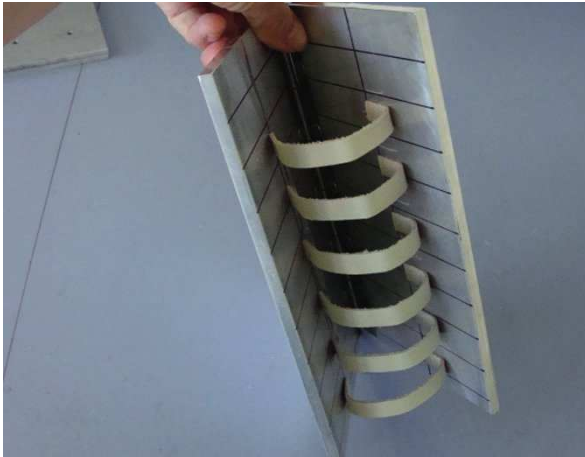

a)

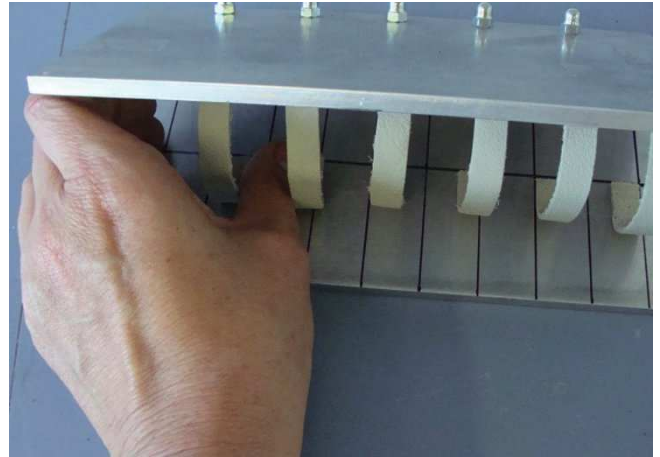

b)

Figure A.9 — Step 9

ISO 17233:2017(E)
IULTCS/IUP 29:2017(E)

ICS 59.140.30

Price based on 9 pages

© ISO 2017 – All rights reserved