

First edition
2013-02-15

**Photography — Digital still cameras —
Measuring shooting time lag, shutter
release time lag, shooting rate, and
start-up time**

*Photographie — Caméras numériques — Décalage dans le temps
du mesurage de la prise, décalage dans le temps de l'ouverture de
l'objectif, cadence de prise et temps de démarrage*



Reference number
ISO 15781:2013(E)

© ISO 2013



COPYRIGHT PROTECTED DOCUMENT

© ISO 2013

All rights reserved. Unless otherwise specified, no part of this publication may be reproduced or utilized otherwise in any form or by any means, electronic or mechanical, including photocopying, or posting on the internet or an intranet, without prior written permission. Permission can be requested from either ISO at the address below or ISO's member body in the country of the requester.

ISO copyright office
Case postale 56 • CH-1211 Geneva 20
Tel. + 41 22 749 01 11
Fax + 41 22 749 09 47
E-mail copyright@iso.org
Web www.iso.org

Published in Switzerland

Contents

	Page
Foreword	iv
Introduction	v
1 Scope	1
2 Normative references	1
3 Terms and definitions	1
4 Test conditions	2
4.1 Illumination of the test scene	2
4.2 The chart and positioning of the digital still camera	3
4.3 Battery status	4
4.4 Memory card	4
4.5 Flash	4
5 Measurements	4
5.1 Definition of measurement	4
5.2 Measurement method	6
6 Reporting the results	9
Annex A (informative) Test results of methods to start the timing device	10
Annex B (informative) Timing device	12
Annex C (informative) Measurement by internal method	16
Annex D (informative) Examples of reporting the result	23
Bibliography	25

Foreword

ISO (the International Organization for Standardization) is a worldwide federation of national standards bodies (ISO member bodies). The work of preparing International Standards is normally carried out through ISO technical committees. Each member body interested in a subject for which a technical committee has been established has the right to be represented on that committee. International organizations, governmental and non-governmental, in liaison with ISO, also take part in the work. ISO collaborates closely with the International Electrotechnical Commission (IEC) on all matters of electrotechnical standardization.

International Standards are drafted in accordance with the rules given in the ISO/IEC Directives, Part 2.

The main task of technical committees is to prepare International Standards. Draft International Standards adopted by the technical committees are circulated to the member bodies for voting. Publication as an International Standard requires approval by at least 75 % of the member bodies casting a vote.

Attention is drawn to the possibility that some of the elements of this document may be the subject of patent rights. ISO shall not be held responsible for identifying any or all such patent rights.

ISO 15781 was prepared by Technical Committee ISO/TC 42, *Photography*.

Introduction

Taking pictures of a moving target was nearly impossible in the early days of digital photography. After pressing the exposure button it took a significant amount of time to capture the image and the chance to preserve the desired moment was gone.

Part of the time between pressing the exposure button and the exposed picture is needed to focus, another part is needed to adjust the exposure, etc. This unwelcome but unavoidable period of time is called **shooting time lag**. This is often mixed with the term **shutter release time lag**, which is also defined in this International Standard. Optimized systems are nowadays able to decrease these time lags.

Capturing the different stages of a fast moving object is sometimes very important especially in areas like sports or people photography. This high **shooting rate** requires a fast image processing within the digital still camera that can be measured according to the method described in this International Standard.

When a photographer decides to capture an image of a changing scene, if his or her digital still camera takes a long time to be ready to shoot once it is turned on, the opportunity to capture the image is lost. This time named **start-up time** is therefore another important value, which can be determined using this International Standard.

Photography — Digital still cameras — Measuring shooting time lag, shutter release time lag, shooting rate, and start-up time

1 Scope

This International Standard specifies how to measure and report the shooting time lag, shutter release time lag, shooting rate and start-up time for digital still cameras, including camera modules in phones and tablet computers. It includes a method that uses control signals inside the digital still camera and a method that determines the timing values without requiring access to the inside of the digital still camera.

Depending on the method used to start the timing device, there may be a time lag between the activation of the timing device and the closure of the exposure switch of the digital still camera.

This International Standard does not address the measurement of auto focus accuracy and speed at low light conditions.

For digital still cameras that continuously shoot images into the buffer, the exposure button only acts as a selector of an image that was taken before the exposure button was pressed. The methods to measure shutter time lag and shooting time lag do not address this case and cannot be used for this type of digital still camera.

2 Normative references

The following referenced documents are indispensable for the application of this document. For dated references, only the edition cited applies. For undated references, the latest edition of the referenced document (including any amendments) applies.

ISO 7589, *Photography — Illuminants for sensitometry — Specifications for daylight, incandescent tungsten and printer*

3 Terms and definitions

For the purposes of this document, the following terms and definitions apply.

3.1

digital still camera

device which incorporates an image sensor and produces a digital signal representing a still picture

Note 1 to entry: A digital still camera is typically a portable, hand-held device. The digital signal is usually recorded on a removable memory, such as a solid-state memory card or magnetic disk.

Note 2 to entry: This term is also defined in ISO 12231, ISO 12232, ISO 15739 and ISO 17321-1.

3.2

shooting time lag

time between pressing the exposure button (firmly depressing the shutter button to the maximum extent without introducing a discontinuity) on a digital still camera or a module built into a mobile device and the beginning of the exposure

Note 1 to entry: This period of time includes all measurements and adjustments (e.g. auto focus and exposure control) a digital still camera needs to make prior to the beginning of the exposure.

Note 2 to entry: When the exposure button of a digital still camera is pressed it performs a number of time-consuming measurements and adjustments, e.g. determination of the exposure and focus adjustment. The time needed for these procedures is part of the shooting time lag.

3.3 shutter release time lag

time duration to the time of starting the exposure from the time of fully pressing down the shutter button after having stabilized the focus operation due to half pressing of the shutter, in case of digital still cameras that distinguish between the half pressing and the fully pressing

Note 1 to entry: Instead of shutter release time lag, the terms shutter lag and release lag are used in some publications.

3.4 start-up time

time between switching a digital still camera on and the moment the camera has reached a standby state ready to shoot

Note 1 to entry: It excludes the initialization of a memory card.

3.5 shooting rate

reciprocal of the time between the beginning of the exposure of an image until the beginning of the exposure of the next image

3.6 standby state

state achieved following the power-up process, in which a digital still camera is powered on and ready to capture an image

Note 1 to entry: If the digital still camera uses an electronic viewfinder, a preview image is normally displayed during the standby state.

3.7 pre-capture point

position of a user control of a digital still camera which activates pre-capture processes, such as auto-focus and exposure calculation

Note 1 to entry: The pre-capture point is typically reached by pressing an exposure button roughly halfway down.

3.8 capture point

position of a user control of a digital still camera which activates the image capture operation

Note 1 to entry: The capture point is typically reached by fully depressing the exposure button.

4 Test conditions

4.1 Illumination of the test scene

The illumination level of the shooting area including the test chart should be even and above 500 lx and below 5 000 lx. The test scene shall be illuminated in a way that avoids specular reflection (see [Figure 1](#)). This can be achieved by using a geometry typical for reproduction photography, which means positioning the light sources in approximately a 45° angle to the surface of the chart. The illumination level of the area shall be reported together with the measurements.

Timing measurements shall be performed under daylight conditions or a tungsten lamp. Procedures for determining whether the illumination used for OECF measurements is an acceptable match to the daylight illuminant shall be conducted in accordance with ISO 7589.

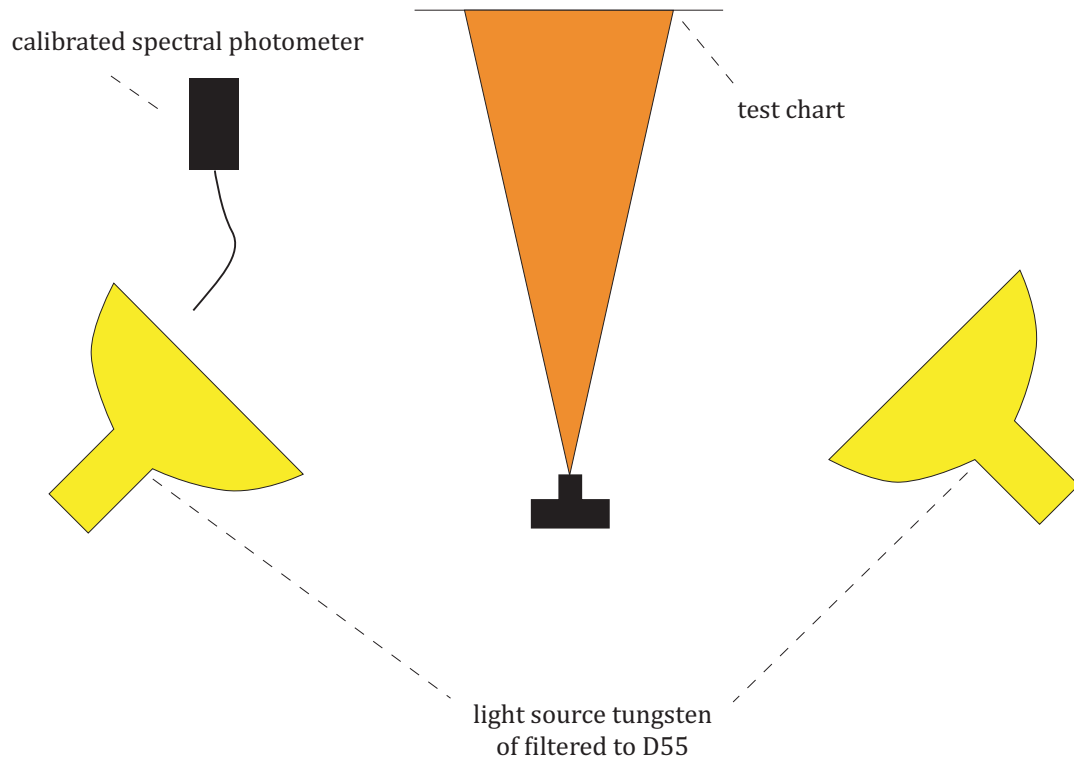

Figure 1 — Principle for illuminating the target

4.2 The chart and positioning of the digital still camera

The digital still camera shall be mounted on a solid stand (e.g. heavy tripod) perpendicular to and facing the surface of the chart (see [Figure 2](#)).

As for a test chart, the chart shall allow the digital still camera to focus easily and allow an easy determination whether the captured image is correctly focused. Examples include a black-and-white checker board or the three-line chart shown in informative [Annex B](#). If the above condition is met, a typical image assessment chart may be used. Also, the ISO 12233 resolution chart may be placed in the chart area to determine whether the captured images are in focus.

The height of the chart shall be 80 (± 10) cm and the distance to the chart shall be adjusted in a way that the height of the image is in accord with the chart height.

The surround areas should be filled with a reflective area of 18 % neutral grey. Prior to the measurement, the digital still camera shall be checked to see if it correctly focuses on the chart. If not, the correct focus shall be obtained by changing the chart or the illumination condition. If different setup conditions are required when the focal length of the lens is extremely long or short, these setup conditions shall be reported together with the measurement results.

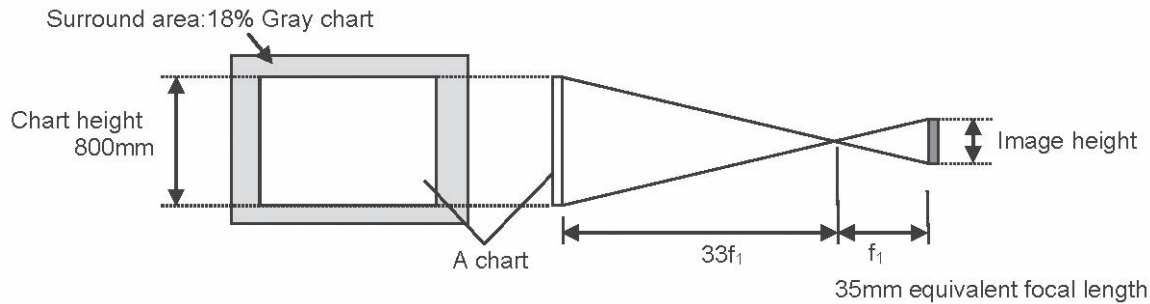

Figure 2 — Chart and positioning

4.3 Battery status

A secondary battery should always be fully charged and a primary battery should always be a new one prior to performing the measurements in order to avoid inconsistent measurements caused by varying power supply. For cameras that support an AC power supply, the AC power supply should be used.

4.4 Memory card

For digital still cameras that support connection to an external memory card, a card with a sufficient capacity that does not interfere with the test shall be used. The card shall be initialized and formatted in the camera. After formatting the card, it shall remain in the digital still camera.

If the digital still camera only has the internal memory, all images should be deleted by initializing the memory prior to the measurement.

4.5 Flash

If the flash is used to perform the measurements, it shall be reported together with the results.

5 Measurements

5.1 Definition of measurement

5.1.1 General

This International Standard defines two measurement methods. The first method is the “external measurement” method, which can be performed without disassembling the digital camera. The second method is the “internal measurement” method, which requires the camera body to be partially disassembled, in order to perform measurements using electrical signals inside the camera body. The first method is the preferred method for measurements made by users of digital cameras. The second method is the preferred method for measurements made by digital camera manufacturers.

NOTE 1 [Figures 3, 4, and 5](#) show the periods of time to be measured.

NOTE 2 “Procedure related to the pre-capture point” means the procedure by which the digital still camera measures the light intensity and distance, determines the exposure, and adjusts the focus when the pre-capture point switch of the digital still camera is pressed.

NOTE 3 “Procedure related to the capture point” means the procedure by which the digital still camera processes the image captures and preparation of the image storage when the capture point switch of the camera is pressed.

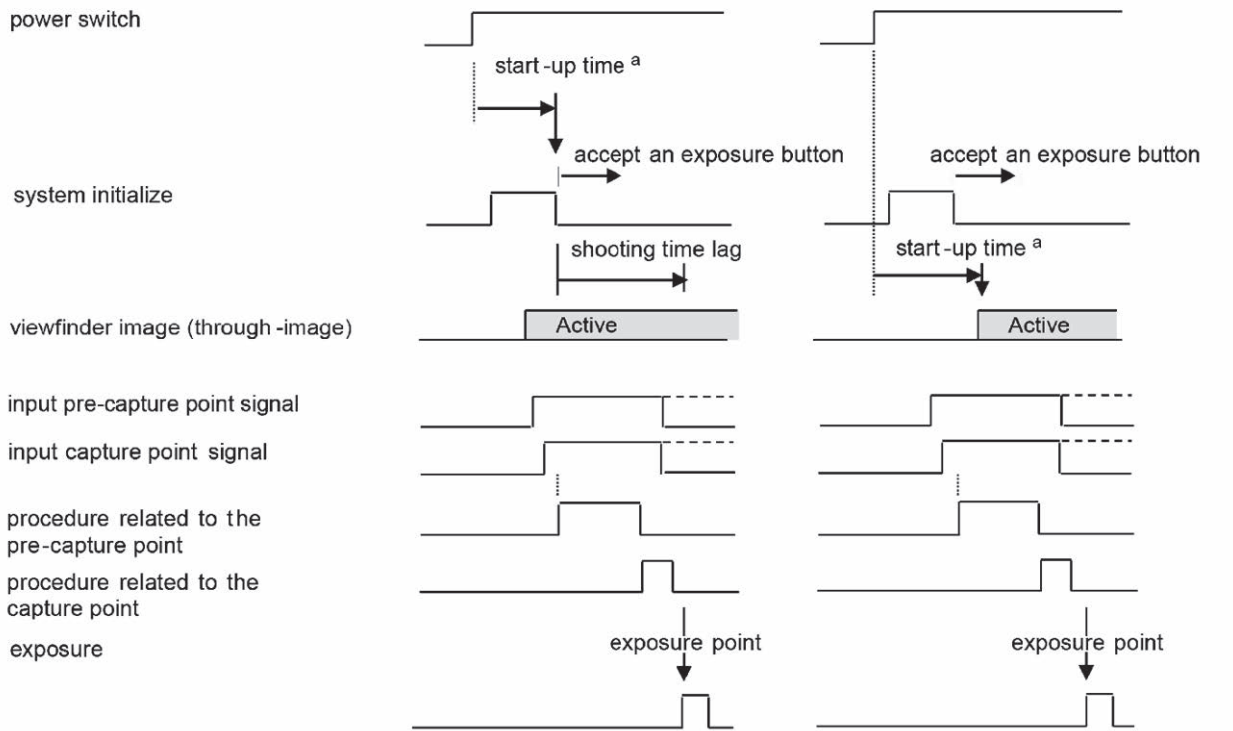

In the case where the time until pre-exposure point can be accepted is longer than the time until the viewfinder image (through-image) is displayed.

In the case where the time until the viewfinder image (through-image) is displayed is longer than the time until pre-exposure point can be accepted.

^a The time between switching the power on and the moment the viewfinder image (through-image) is displayed, or the time between switching the power on and the moment pre-capture point can be accepted, whichever is longer.

Figure 3 — Measurement period for start-up time

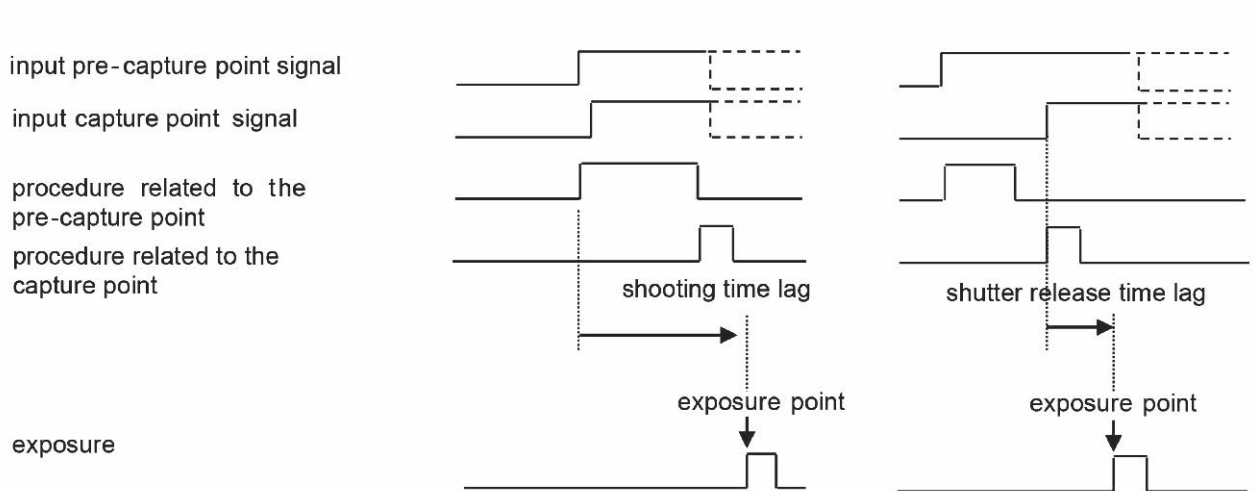

Figure 4 — Measurement period for shooting time lag and shutter release time lag

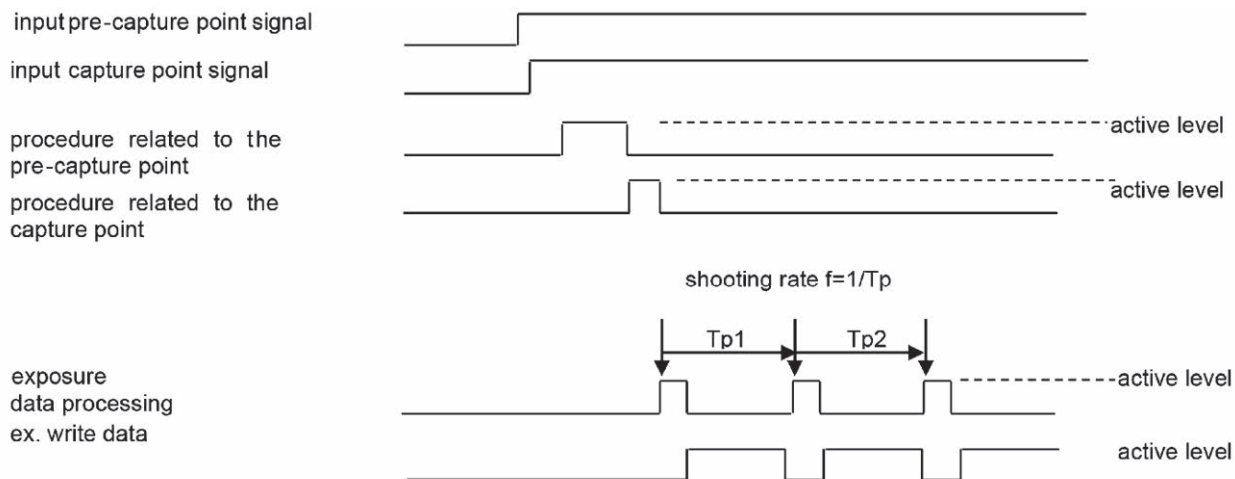

Figure 5 — Measurement period for shooting rate

5.1.2 External measurement

The external method of measurement is performed without disassembling the camera with the advantage that the measurement can be performed on the product level. Specifically, for instance, the measurement can be performed shooting a timing device that can determine a time interval from captured images. An example of this method is shown in informative [Annex B](#).

When using the external measurement the acceptable level of the time lag between pressing the exposure button and activating the timing device is application dependent and needs to be considered prior to performing a test and the estimated error caused by this time lag shall be reported together with the results (see [Annex B](#)). A test was performed using different approaches and the results are shown in informative [Annex A](#).

5.1.3 Internal measurement

Internal measurement is a method which directly measures a time interval between input signals and device control signals and involves disassembling the camera. This allows the operational timing to be surely obtained and has the advantage that the measurement can be performed accurately and stably. However, camera manufacturers usually use this method because it is very difficult for parties other than camera manufacturers to disassemble the camera and select and measure the device control signals. An example of this method is shown in informative [Annex C](#).

5.2 Measurement method

5.2.1 Start-up time

The digital still camera shall be switched on and set to record mode. Every setting that requires additional time when switching the camera on (e.g. playing an intro sound) shall be tuned off, and the camera shall be focused on the timing device before it is switched off again. Start the measurement when the power switch is turned on again. The measurement value shall be an average of at least 10 measurements.

The digital still camera shall not be disconnected from the power supply until the test is finished. The measurement results and conditions shall be reported according to the description in [Clause 6](#).

For camera modules in mobile devices the starting point for turning the camera function on is the phone mode or regular operation mode of the device. If it is necessary to enter one or multiple menus to start the camera module, this time shall be integrated in the reported start-up time.

When using the external measurement, the timing device shall electronically be connected to the power switch or the power supply of the camera, if possible. The accuracy of the timing device for measuring the start-up time shall be at least 0,1 s (the sampling shall be 0,01 s). If the timing device is started manually all measured values < 0,5 s shall be reported as 0,5 s and the fact of the manual activation shall be reported together with the result. When the power switch is turned on, the timing device shall be started. A picture of the chart (object) shall be taken immediately after the shutter release becomes active after turning the camera on.

If the shooting images can only be checked through an optical viewfinder, or if the initial setting of the product is “image display device off” in a digital still camera that consists of both an optical viewfinder and an image display unit, the time elapsed from operating the power switch until the beginning of the exposure of the first image, minus the shooting time lag determined from the second image, shall be called the start-up time.

$$T_S = T_0 - T_{SL} \quad (1)$$

where

T_S is start-up time;

T_0 is time elapsed from operating the switch until the beginning of the exposure of the first image;

T_{SL} is shooting time lag.

However, in the case where the shooting image cannot be checked through an optical viewfinder, or if the initial setting of the product is “image display device on” in the camera with both optical viewfinder and image display unit, the time between switching the power on and the moment the viewfinder image (through-image) is displayed shall be measured.

When using the internal measurement, suppliers as shown in informative [Annex C](#) shall directly observe appropriate signals, and the time defined in [5.1.1](#) shall be measured.

5.2.2 Shooting time lag

Prior to each measurement of the shooting time lag, the digital still camera shall be turned to face a distant object and shall focus on this object. The elapsed time between turning the camera on the stand and pressing the exposure button shall be less than 3 s.

The distant object shall be located at a distance of at least 100 times the focal length of the camera lens, or 5 m, whichever is greater.

For products that allow manually focusing to infinity, this option may be used. The focus point can also be set to infinity using a collimator.

The shooting time lag, T_{SL} , shall be measured by turning the digital still camera to face the chart and by fully pressing the exposure button with continuous auto focus turned off. In the case of the external measurement, the time between starting the timing device and the first illuminated time indicator in the correct focused image is the shooting time lag. If the image is clearly out of focus it shall not be used to measure the shooting time lag because in this case the camera may trade the focus accuracy for higher speed (shutter priority) and the image of the timing device is blurred and unable to show the correct timing. For cameras that do not deliver sharp images when pressing the exposure button fully, the digital still camera shall be allowed to focus by first pressing the exposure button halfway down; immediately after the camera indicates that it is in focus, the exposure button shall be fully pressed. The timing device shall be started when the exposure button is pressed halfway down and the fact that the digital still camera did not focus correctly without this manual adjustment shall be reported together with the results.

In the case of the internal measurement, appropriate signals shall be directly observed as shown in informative [Annex C](#), and the time period defined in [5.1.1](#) shall be measured.

The reported shooting time lag shall be an average of at least 10 measurements shot in a row right after the previous image has been stored to the storage media and without switching the camera off.

If the measured time is significantly shorter or longer for the first of the 10 images, the measurement shall be repeated. If the same results occur, values for the first and the following exposures shall be reported separately.

The measurement results and conditions shall be reported according to the description in [Clause 6](#).

5.2.3 Shutter release time lag

The shutter release time lag shall be measured using the same requirements for the shooting time lag except that the timing device shall be started after the digital still camera is facing the chart (object) and is in focus. The measurement results and conditions shall be reported according to the description in [Clause 6](#).

5.2.4 Shooting rate

The shooting rate should be measured with the camera set to the highest pixel count available in the camera and the highest image quality (e.g. lowest JPEG compression) available. However, any other setting may be used and the setting shall be reported along with the measurement results. The camera shall be positioned as described in [4.2](#) and correctly focused on the target. To achieve the highest frequency possible, the digital still camera shall be set to burst mode (if it exists), and the exposure time shall be 1/100 of a second or less (if adjustable). If the camera does not allow setting mode and exposure time, the measurement shall be performed using the default setting.

A set of the images should be taken with the camera by keeping the exposure button pressed until the shooting rate slows significantly down. The reciprocal of the time elapsed from the beginning of the exposure for one image and the beginning of the exposure of the next image is the value of the shooting rate. If the shooting rate changes significantly during the test, the number of exposures possible at the used mode shall be reported along with the value of the shooting rate.

NOTE Digital still cameras often shoot several images at a constant frequency at the beginning of capturing a series of images. In case the buffer memory fills up because the camera is not able to process and transfer the images to the storage medium fast enough, the frequency decreases after the memory is full. This is the point where the camera noticeably slows down.

The shooting rate shall be reported as the mean value for all images taken until the camera begins to slow down.

$$f = \frac{n-1}{(t_n - t_1)} = \frac{1}{T_p} \quad (2)$$

where

f is image frequency;

n is the number of the last image before the camera begins to slow down;

t is the time from the start until the beginning of the exposure for a specific image;

T_p is the arithmetic mean of the measured value for n intervals from the beginning of the exposure for one image until the beginning of the exposure for the next image.

The measurement results and conditions shall be reported according to the description in [Clause 6](#).

6 Reporting the results

The results of the timing values described in this International Standard depend on several camera settings as well as surrounding conditions. Therefore, these camera settings and surrounding conditions shall be managed enough during the measurement and they shall be reported with the results. In some cases, however, simpler presentation without complete description on the camera settings or the surrounding conditions may be used. An example is specification notes in a catalogue for the end users.

The results of measurements should be reported with at least two significant digits. When the shooting time lag and start-up time is less than one second, the shutter release time lag is less than 10 ms or the shooting rate is less than one image per second, the results may be reported with one significant digit.

A complete report of the results shall contain all the necessary information in order to reproduce the measurement. In particular, the following shall be recorded:

- measurement method used;
- identification of the measured product, e.g. product type, serial number, firmware version, information on the used lens;
- identification of the used memory card, e.g. card specifications, memory size;
- any special environmental conditions in which the test was performed, e.g. illumination of the test scene, subject distance, special setup conditions;
- any specific conditions necessary to enable the test to be performed, e.g. power supply;
- any operating states of the camera necessary to enable the test to be performed, e.g. number of recorded pixels, image quality, capture mode (e.g. portrait, sports), focal length, focus mode (e.g. high speed), flash usage.

An example of a test report with information to report and associated values are given in informative [Annex D](#).

Annex A (informative)

Test results of methods to start the timing device

To find out about the time lag between the actuation of the timing device and the closure of the exposure switch (activated by the exposure button) of the digital still camera, an experiment has been performed using several real cameras (see [Figure A.1](#)).

A modified version of the timing device mentioned in B.2 has been used. This version used one input for the micro switch to start the device and a second input that was connected to the exposure button of the sample camera as a stop signal. This way the time lag between the two signals could be measured.

A positive value in [Table A.1](#) means that the micro switch was actuated before the camera exposure switch. A negative value means that the force needed for the micro switch was higher than that needed for the camera, which leads to the case that the camera was actuated before the micro switch.

Table A.1 — Measured times lags between actuation of the micro switch and the camera exposure switch

Activating force needed for micro switch	Camera 1 index finger	Camera 1 electromagnetic finger	Camera 2 index finger	Camera 2 electromagnetic finger	Camera 3 index finger	Camera 3 electromagnetic finger
1,2	8	0,8	27	1,5	8	1
1,6	3	0,35	35	1,1	17	1,4
1,8	-3	1,25	21	1,7	3	2
3	-9	0,75	-2,5	1	-22	-2,5
4,2	-25	-11	-30	-27	-25	-7

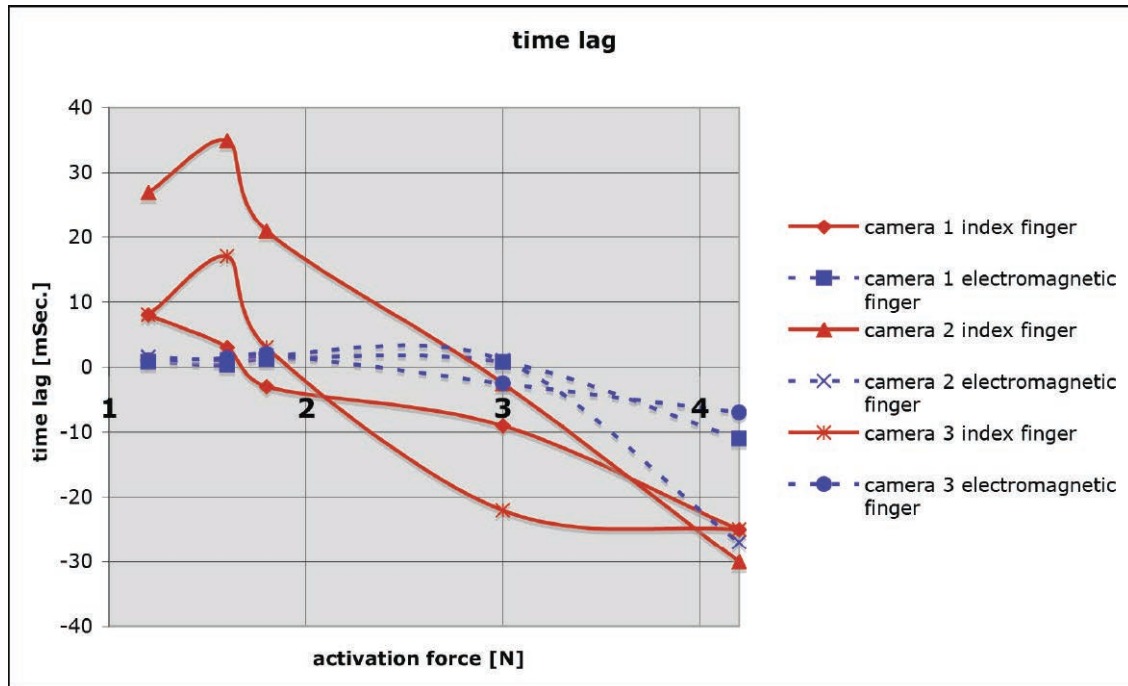

NOTE Solid lines show the results from the index finger and the dashed lines the results from the electromagnetic finger.

Figure A.1 — Time lag

The experiment shows that for using the index finger it is important to select a micro switch that has about the same activating force as the camera exposure button if a time lag smaller than 10 ms is needed. Using an average switch, the time lag is typically within the area of 30 ms. Therefore the assigned accuracy of the measurement using the index finger to actuate a micro switch is ± 30 ms.

For the “electromagnetic finger” the results show that as long as the force needed to actuate the micro switch is smaller than that needed to actuate the camera exposure button, the time lag is within ± 2 ms. Only if the force needed to actuate the micro switch is much higher than that for the exposure button the time lag is significantly higher. Therefore the assigned accuracy for the measurement using the electromagnetic finger is ± 2 ms.

Annex B (informative)

Timing device

B.1 Actuation of the timing device

This International Standard notes three different ways to actuate the timing device that is needed to perform the described measurements. Each way has been evaluated (see informative [Annex A](#) for details) and, based on the results, been given a related accuracy. The term accuracy in this case describes the time lag between the actuation of the timing device and the closure of the exposure switch of the camera. This time lag is a deviation of the measured result versus the real timing value that is supposed to be measured.

Index finger: starting the timing device using a micro switch that is activated by the tester’s index finger (see [Figure B.1](#)). Although a carefully selected switch in combination with an experienced tester may lead to higher accuracies the assigned accuracy is $\pm 0,03$ s. The typical activating force for a camera exposure button is between 1,0 and 3,0 N. If a micro switch is used to activate the timing device it should have about the same activating force. There are various switches with a defined activation force commercially available.



a) Digital still camera

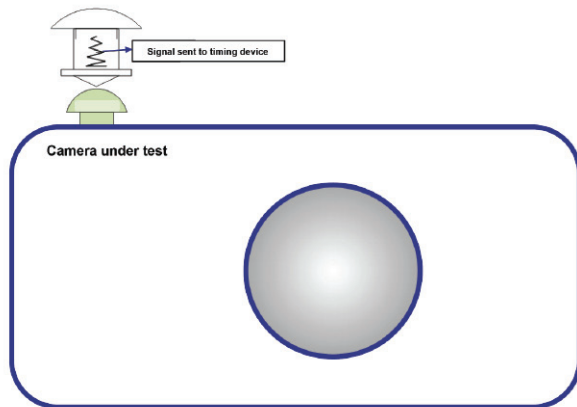

b) US proposal for substitution of image

Figure B.1 — Digital still camera with a micro switch mounted on the exposure button using an adhesive tape

Electronic finger: the timing device is activated using an “electromagnetic finger” that either actuates a micro switch on top of the exposure button of the camera or the switch that activates the finger also starts the timing device. This construction has an assigned accuracy of 0,002 s and the manufacturer of the device makes sure that it meets this requirement.

An even more accurate alternative to the electronic finger shown in [Figure B.2](#) is the use of an actuator with a calibrated position. The calibration requires a few shots but once that is done the method results in almost no timing difference between actuation and exposure switch.



NOTE An electronic finger provides a higher accuracy compared to manual pressing of the exposure button with a mounted micro switch.

Figure B.2 — Electronic finger

Direct electronic connection to the exposure switch: the highest level of accuracy reaches the direct electronic connection of the timing device with the exposure switch of the camera. The timing device is started at the same time the camera's exposure switch is closed. Typically this method requires partially disassembling the camera and modifying the exposure switch and is therefore not applicable to all kinds of tests although if applicable it should be the first choice.

The way the timing device was activated should be reported together with the results (see Clause 6).

B.2 The timing device

The device used to measure the time should have an accuracy of at least 1 ms and be capable of measuring times up to 10 s or more.

It is possible to use digital clocks if the display is fast enough to show at least a 1/100 of a second.

NOTE 1 The problem with using a digital clock is that the display always stays at the same location, which means that numbers lay on top of each other, for example 0,01, 0,02, 0,03 ... seconds. Therefore, the beginning of an exposure cannot be clearly identified if the exposure time is longer than the required accuracy



Figure B.3 — Sample device for a LED panel

The frequency of the LEDs is selectable and each LED is illuminated for a defined period of time. With longer exposure times, one or more LEDs will be illuminated in the image (see [Figure B.3](#)).

NOTE 2 The same thing may be possible using a software solution and displaying a “virtual LED panel”. In this case care has to be taken for the image frequency of the monitor. Many LCD monitors are not set to refresh rates high enough or suffer from a long response time. In that case the “digital LEDs” are not displayed fast enough to lead to reliable results. In addition the timing circuit on the computer board has to be checked for its accuracy. It may require a calibration prior to the measurement. The program may not show the same speed when another software is running on the same computer, which also requires resources of that computer. Another uncertainty is how to trigger the virtual LED panel. There may be variable delays between when the trigger signal is sent to the computer and when the computer begins updating the “virtual LED panel”. A software solution needs to address these problems otherwise it should not be used for measurements related to this International Standard.

B.3 Timing device position for focal plane shutter and rolling shutter

This subclause describes the positions of the chart and timing device when the exposure timing of the sample camera that has a focal plane shutter or a rolling shutter differs depending on the image location. If the camera has a rolling shutter only this chart layout is intended to be used for cameras with a readout speed for an entire frame faster than 1/10 of a second.

The timing devices are positioned in two diagonal corners, and shorter time duration between the measurement start time (power switch, pre-capture point, and capture point) and the measurement end time (exposure start) is adopted as measured value. Alternatively, measurement is performed with the timing device positioned in one of diagonal corners of the shooting image, then with the timing device positioned in other diagonal corner. The shorter time duration between measurement start time (power switch, pre-capture point, and capture point) and measurement end time (exposure start) is adopted as measured value.

Prior to the measurement, it should be ensured that the timing device (such as LED) is exposed appropriately. The shutter speed and positions may be changed if necessary.

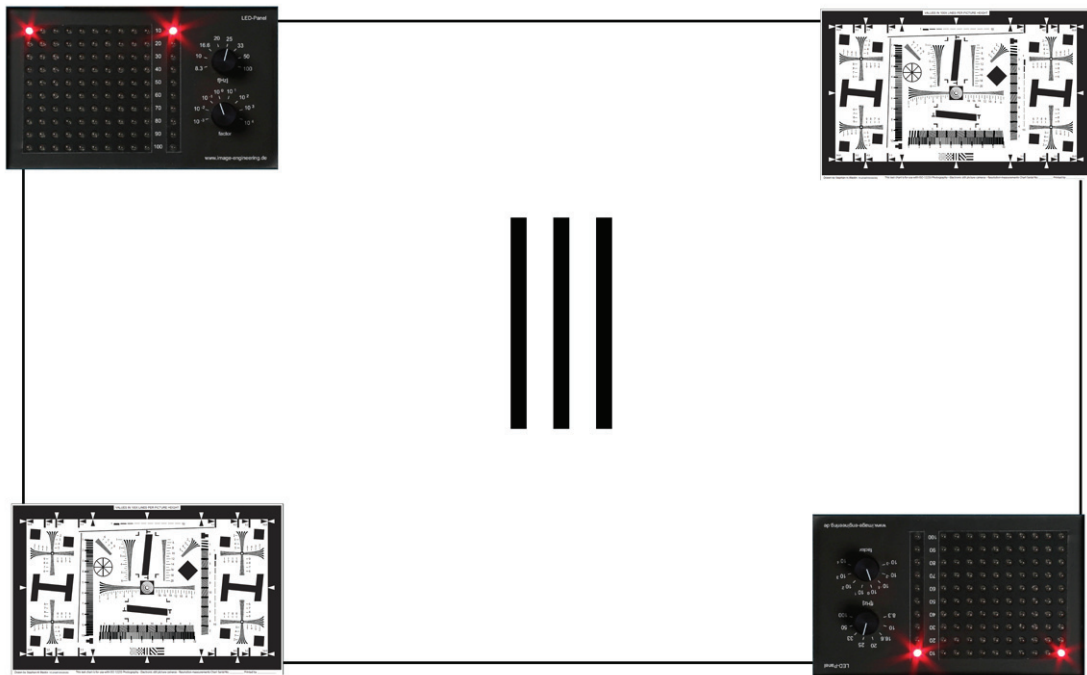

Figure B.4 — Example of positioning charts and timing devices

An ISO 12233 chart with a height of 20cm is positioned in the diagonal corners of the three-line chart with a height of 80cm. Furthermore, the timing devices are positioned in the other diagonal corners. The two timing devices need to be synchronized and the accuracy of the synchronization should be smaller than 1 ms (see [Figure B.4](#)).

NOTE By intention the timing device in the lower right corner is turned 180° to ensure that the starting LED is as close to the image corner as possible and captures the beginning of the exposure.

Annex C (informative)

Measurement by internal method

C.1 General

This annex describes examples for measuring each time lag using control signals inside the digital still camera. A typical digital still camera consists of components as shown in [Figure C.1](#). The time lag can be measured by measuring the differences among each control signal during the time between the moment the input signal becomes active and the moment the exposure starts, using a timing measurement device such as an oscilloscope.

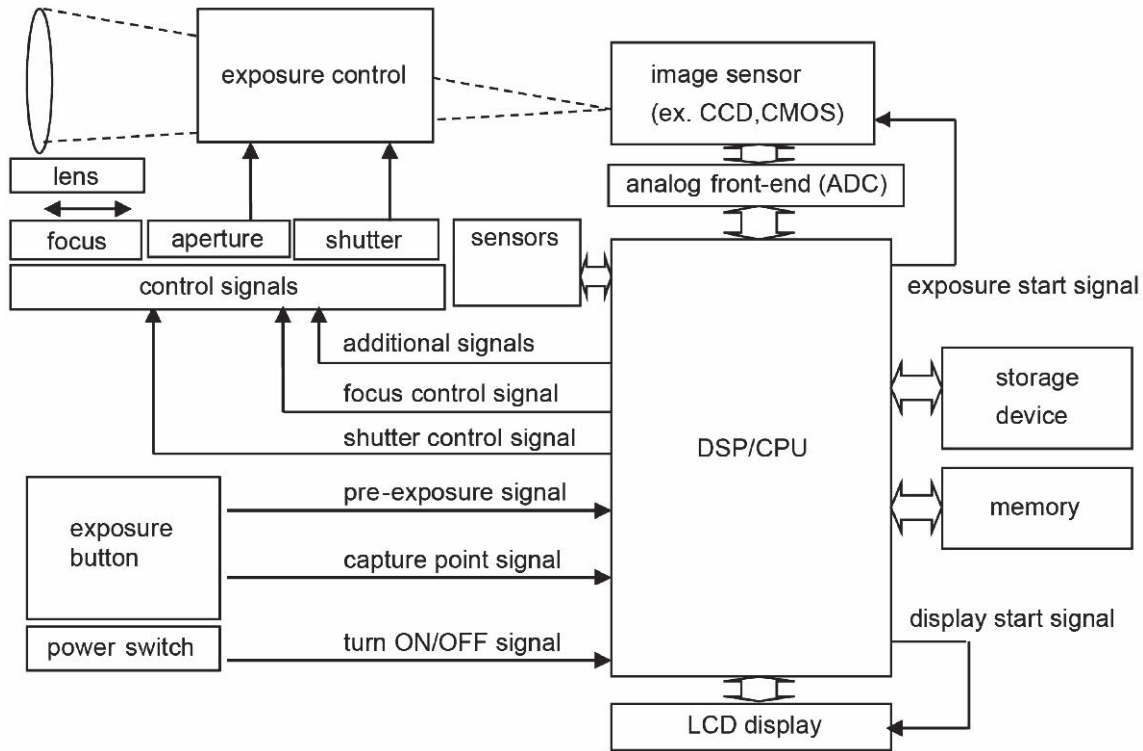

Figure C.1 — Block diagram of a standard digital still camera

C.2 Start point (measurement start point)

The power switch input signal may be used for the camera power-on signal in the start-up time measurement (see “power switch” in [Figure C.1](#)).

As for the exposure button signals in the shooting time lag and the shutter release time lag, the exposure button is typically provided with two operating points, the half pressing (pre-capture point) and the fully pressing (capture point). The capture point is the exposure start point. The signal of pre-capture point may be used in the shooting time lag measurement and the signal of capture point may be used in the shutter release time lag measurement.

C.3 Exposure point (exposure start point)

C.3.1 General

Some digital still cameras have no mechanism to block light for exposure control. Such products control the exposure start by electrically controlling the image sensor. Even products that have a mechanical shutter use the above control method. Each time lag is able to be measured with these products by observing the exposure start signal for the image sensor to identify the exposure start point, as shown in C.3.2. The method of determining the exposure starting point in case a mechanical shutter controls an exposure start is described in C.3.3.

Whether the focus is achieved or not can be determined by observing signals such as the focus control signal.

C.3.2 Exposure start point of image sensor shutter

For the exposure start point, the signal (exposure start signal) to reset the electric charge of the image sensor may be used. [Figures C.2](#) and [C.3](#) show measurement points.

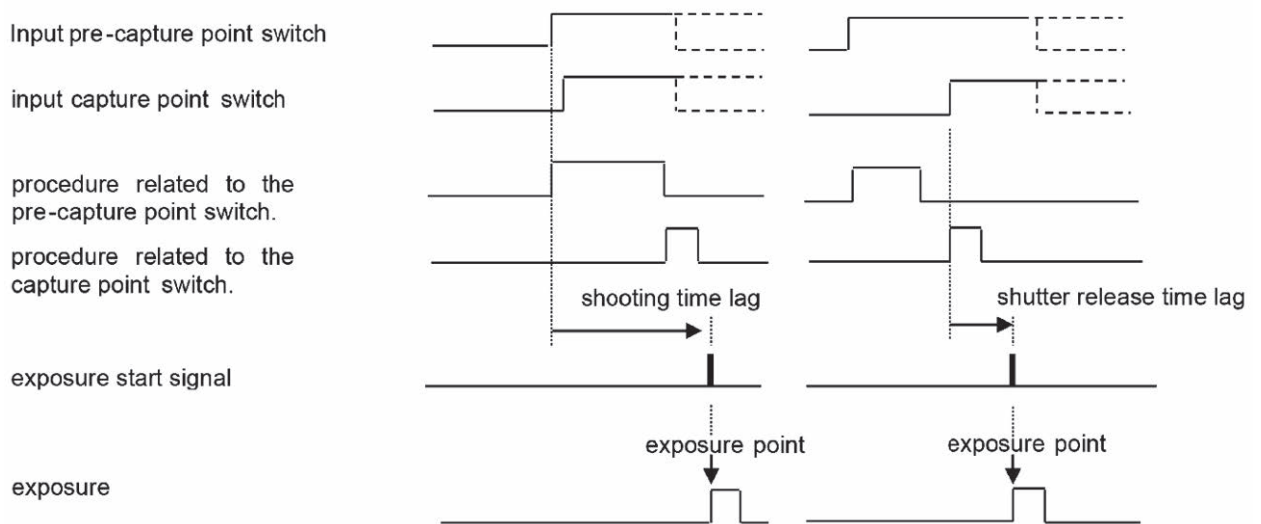

Figure C.2 — Measurement point of shooting time lag and shutter release time lag

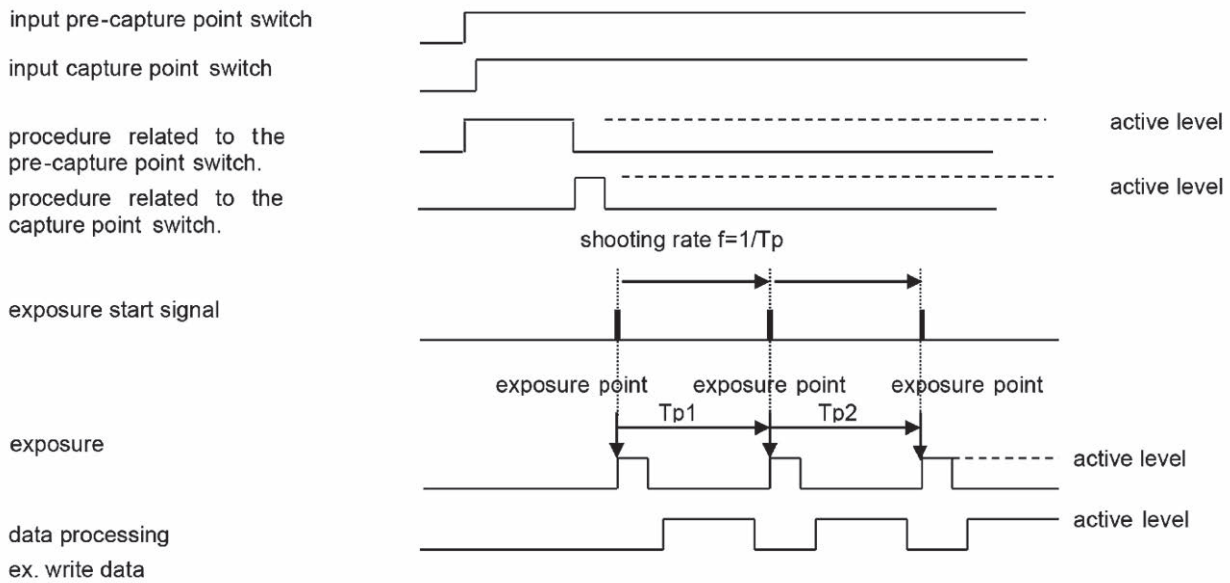

Figure C.3 — Measurement point of shooting rate

C.3.3 Exposure start point of mechanical shutter

Care has to be taken to determine the exposure start point (exposure point) for products in which the exposure start is controlled by the mechanical shutter. Generally, time lag occurs between the time when the shutter control signal is sent out and the moment when the shutter is actually opened to start the exposure.

There is a highly accurate measurement method to measure the exposure start point (exposure point), which obtains the exposure state of an actual exposure frame by observing the movement of the mechanical shutter with a high-speed camera.

NOTE It may also be possible to trigger an LED device as described in informative [Annex B](#) with the appropriate signal and use the target described in that annex.

When using the shutter control signal, the delay time before the opening of the mechanical shutter is first measured using the above method. Then the delay time is added to the measured time before the output of the shutter control signal to obtain the exposure start point.

[Figures C.4, C.5](#) and [C.6](#) show measurement points of shooting time lag, shutter release time lag, and shooting rate, respectively.

Also in the case of the mechanical shutter, the start-up time can be obtained by measuring the time between turning on the power switch and the moment the system initialize is completed.

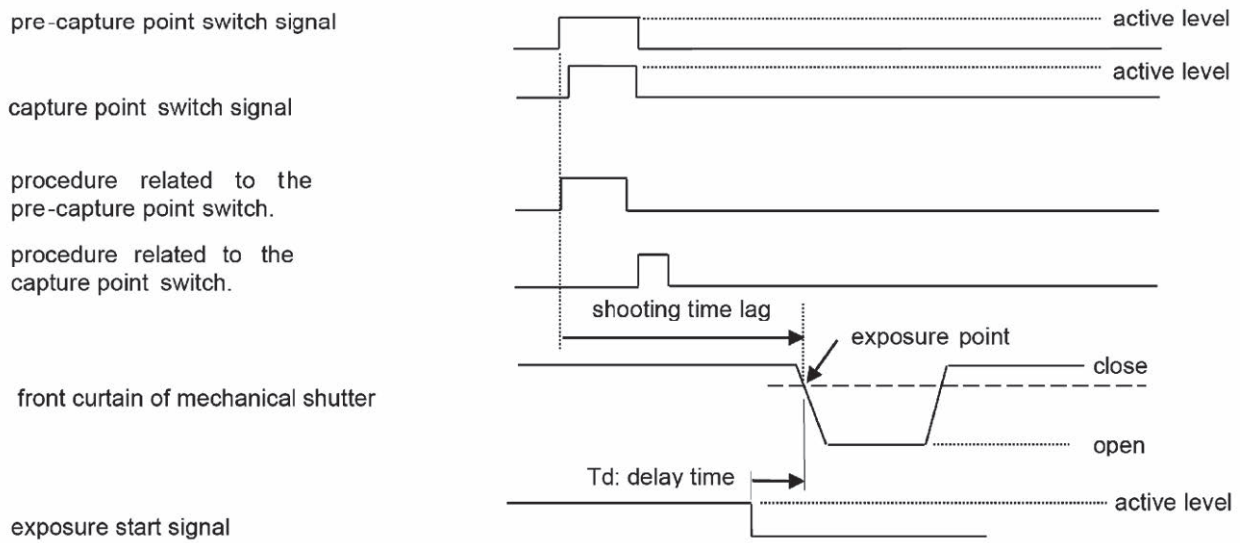

Figure C.4 — Measurement point of shooting time lag (mechanical shutter)

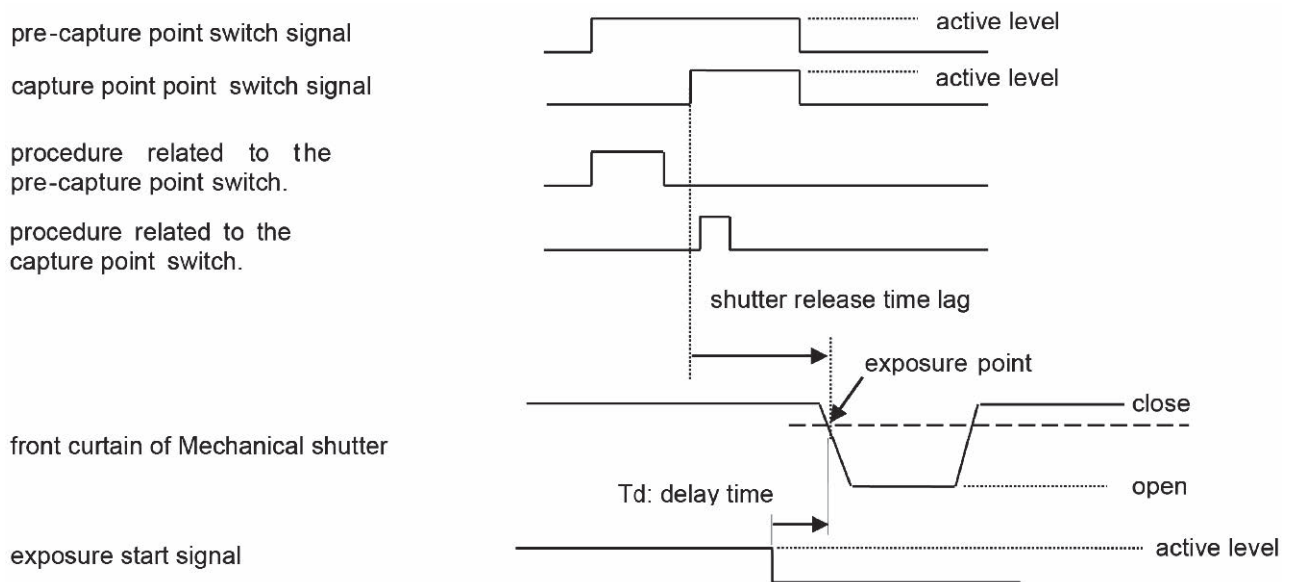

Figure C.5 — Measurement point of shutter release time lag (mechanical shutter)

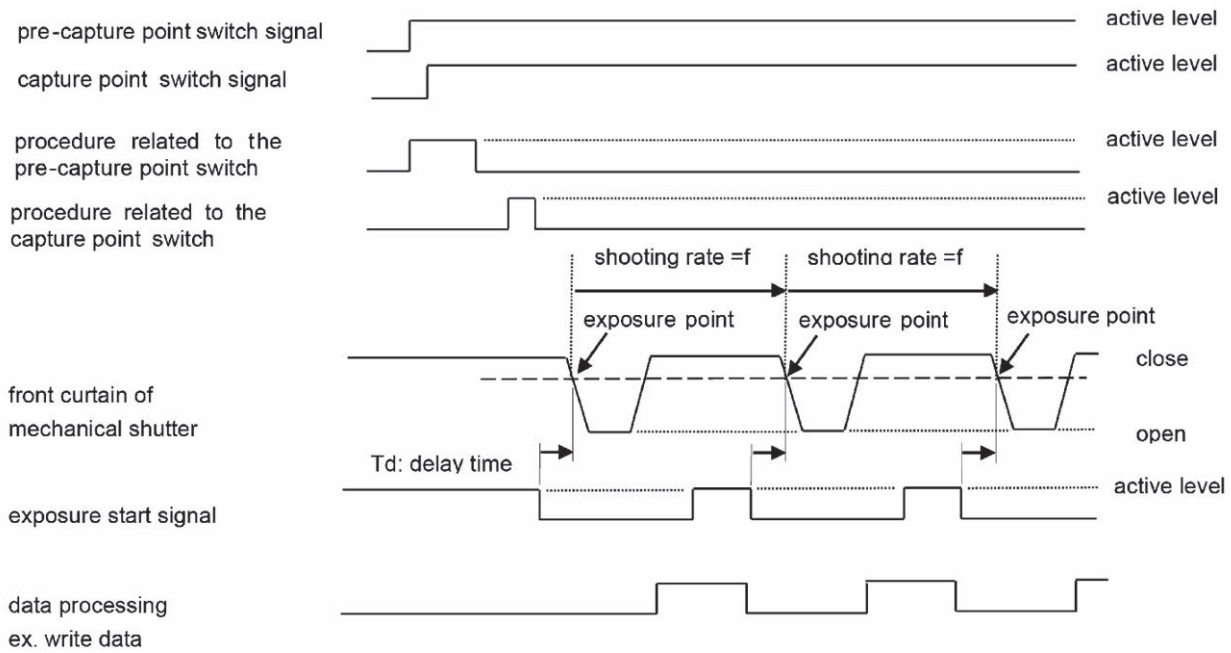

Figure C.6 — Measurement point of shooting rate (mechanical shutter)

C.4 Identifying standby state (measuring start-up time)

C.4.1 General

Care has to be taken to determine the standby state in cameras with the image display device such as LCD to check the shooting image (viewfinder image) or in products with no optical viewfinder. This is because viewfinder image has to be checked before shooting.

If the shooting images can only be checked through an optical viewfinder, or if the initial setting of the product is image display device off in the camera with both an optical viewfinder and image display unit, only the time between switching the power on and the moment pre-capture is accepted may be measured.

However, if the shooting image cannot be checked through an optical viewfinder, or if the initial setting of the product is image display device on in the camera with both optical viewfinder and image display unit, the time between switching the power on and the moment pre-capture is accepted and the time between switching the power on and the moment the viewfinder image (through-image) is displayed should both be measured.

C.4.2 Measuring the time until pre-capture is accepted

The point when the system initialization is completed can be regarded as the above point because it is generally equal to the point when pre-capture is accepted. [Figure C.7](#) shows the measurement points.

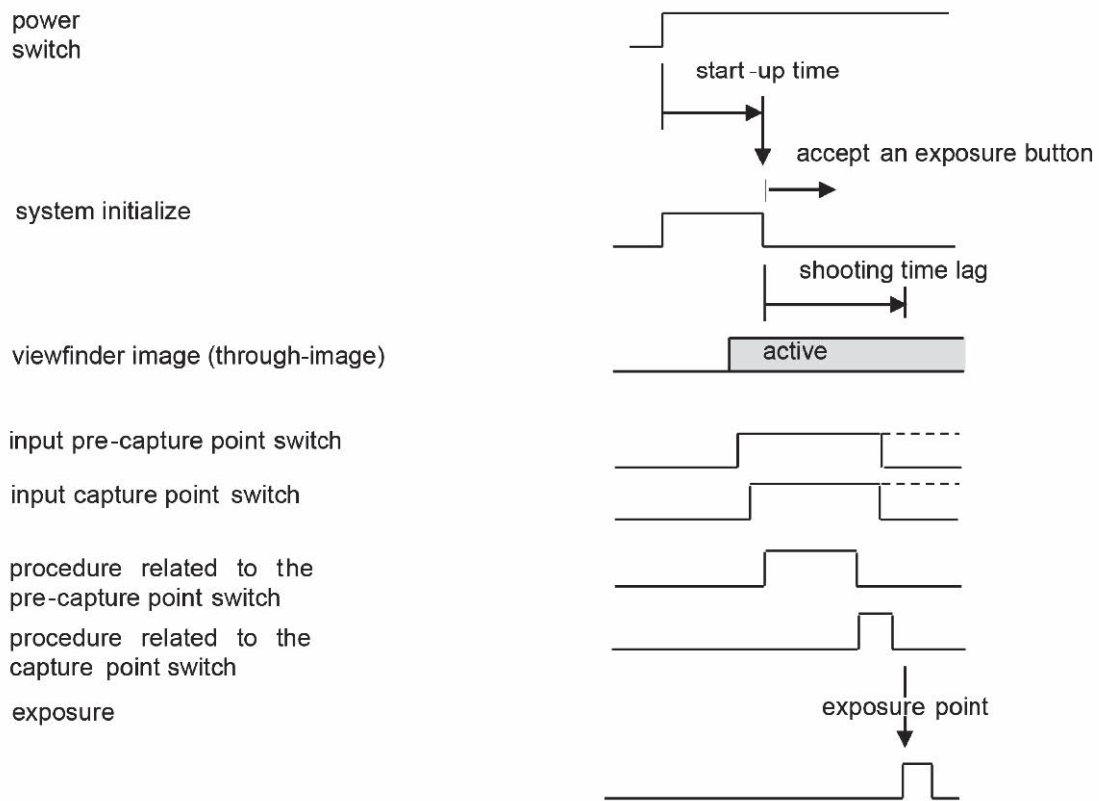

When the time until pre-capture can be accepted is longer than the time until the viewfinder image (through image) is displayed

Figure C.7 — Measurement point of start-up time

C.4.3 Measuring the time until the viewfinder image (through-image) is displayed

For the point where the viewfinder image (through-image) is displayed, the signal to display the image picked up by the image sensor to the display unit may be used. [Figure C.8](#) shows the measurement points.

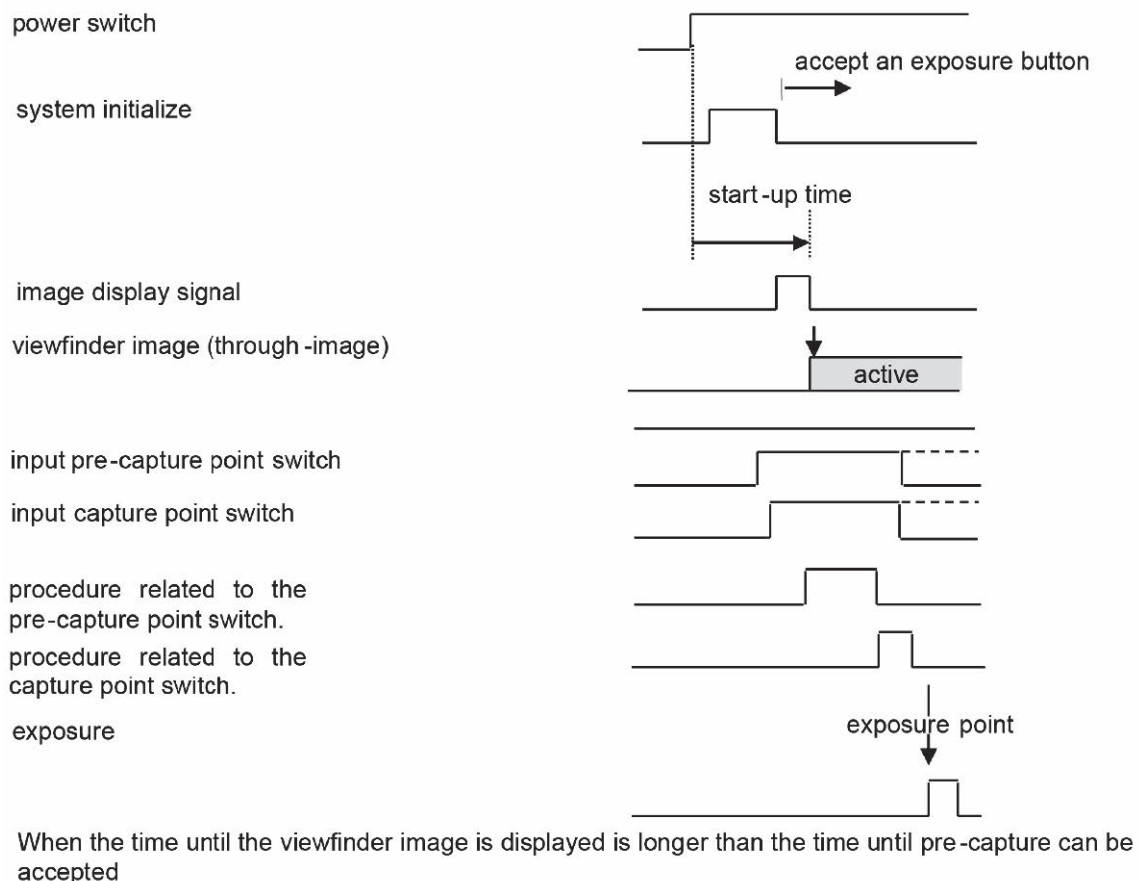

Figure C.8 — Measurement point of start-up time

Annex D (informative)

Examples of reporting the result

D.1 Report examples

This annex describes examples for the statement of test reports. [Table D.1](#) gives examples of information for common conditions. [Tables D.2, D.3, D.4](#) and [D.5](#) give examples of reports for each measurement.

Table D.1 — Example of information for common conditions

Camera	XYZ
Serial number	1234567
Firmware version	Version 1.00
Lens	1:2,8 60 mm
Memory card type ^a	XY ultra fast 70×
Memory card size ^a	4 GB
Number of recorded pixels ^a	3 000 × 2 000 pixel
Illumination of the test scene ^a	2 000 lx
Power supply	Lithium ion battery
Measurement method	External (electromagnetic finger)
^a Omissible if described in each measured item.	

Table D.2 — Example of report for shooting time lag

Capture mode (e.g. portrait, sports)	Factory setting
Shooting distance	1,32 m
Focal length	Wide or 40mm
Focus mode	High speed of mode
Different result for first image	No
Memory type	XY ultra fast 70×
Memory size	4 GB
Number of recorded pixels	3 000 × 2 000 pixel
Illumination of the test scene	2 000 lx
Measurement method	External
Shooting time lag	0,6 s

Table D.3 — Example of report for shutter release time lag

Capture mode (e.g. portrait, sports)	Factory setting
Shooting distance	1,98 m
Focal length	60mm
Measurement method	Internal
Shutter release time lag	0,015s or 15ms

Table D.4 — Example of report for start-up time

Capture mode (e.g. portrait, sports)	Factory setting
Memory type	Internal memory
Memory size	4 GB
Flash	OFF
Illumination of the test scene	2 000 lx
Power supply	Lithium ion battery
Measurement method	Internal
Measurement point	Time until pre-capture can be accepted
Start-up time	1,3 s

Table D.5 — Example of report for shooting rate

Capture mode (e.g. portrait, sports)	Sports burst mode
Memory type	XY ultra fast 70×
Memory size	4 GB
Number of recorded pixels	3 000 × 2 000 pixel
Quality	JPEG lowest compression
Number of images at highest speed	Until card full
Illumination of the test scene	2 000 lx
Measurement method	External
Shooting rate	4,4 images per second

Bibliography

- [1] ISO 12231, *Photography — Electronic still picture imaging — Vocabulary*
- [2] ISO 12232, *Photography — Digital still cameras — Determination of exposure index, ISO speed ratings, standard output sensitivity, and recommended exposure index*
- [3] ISO 12233, *Photography — Electronic still picture imaging — Resolution and spatial frequency responses*
- [4] ISO 15739, *Photography — Electronic still-picture imaging — Noise measurements*
- [5] ISO 17321-1, *Graphic technology and photography — Colour characterisation of digital still cameras (DSCs) — Part 1: Stimuli, metrology and test procedures*
- [6] ANSI PH2-7:1986, *American National Standard for Photography — Photographic Exposure Guide*
- [7] DIN 19017, *Exposure value and correction factor; definition, reference base*

