**Building acoustics — Estimation of
acoustic performance of buildings from
the performance of elements —**

**Part 1:
Airborne sound insulation between
rooms**

*Acoustique du bâtiment — Calcul de la performance acoustique des
bâtiments à partir de la performance des éléments —*

Partie 1: Isolement acoustique aux bruits aériens entre des locaux



Reference number
ISO 15712-1:2005(E)

© ISO 2005

PDF disclaimer

This PDF file may contain embedded typefaces. In accordance with Adobe's licensing policy, this file may be printed or viewed but shall not be edited unless the typefaces which are embedded are licensed to and installed on the computer performing the editing. In downloading this file, parties accept therein the responsibility of not infringing Adobe's licensing policy. The ISO Central Secretariat accepts no liability in this area.

Adobe is a trademark of Adobe Systems Incorporated.

Details of the software products used to create this PDF file can be found in the General Info relative to the file; the PDF-creation parameters were optimized for printing. Every care has been taken to ensure that the file is suitable for use by ISO member bodies. In the unlikely event that a problem relating to it is found, please inform the Central Secretariat at the address given below.

© ISO 2005

All rights reserved. Unless otherwise specified, no part of this publication may be reproduced or utilized in any form or by any means, electronic or mechanical, including photocopying and microfilm, without permission in writing from either ISO at the address below or ISO's member body in the country of the requester.

ISO copyright office
Case postale 56 • CH-1211 Geneva 20
Tel. + 41 22 749 01 11
Fax + 41 22 749 09 47
E-mail copyright@iso.org
Web www.iso.org

Published in Switzerland

Contents

Foreword.....	v
1 Scope	1
2 Normative references	1
3 Relevant quantities	2
3.1 Quantities to express building performance	2
3.1.1 Apparent sound reduction index R'	2
3.1.2 Standardized level difference D_{nT}	2
3.1.3 Normalized level difference D_n	3
3.1.4 Relation between quantities	3
3.2 Quantities to express element performance	3
3.2.1 Sound reduction index R	3
3.2.2 Sound reduction index improvement ΔR	3
3.2.3 Element normalized level difference $D_{n,e}$	4
3.2.4 Normalized level difference for indirect airborne transmission $D_{n,s}$	4
3.2.5 Flanking normalized level difference $D_{n,f}$	4
3.2.6 Vibration reduction index K_{ij}	5
3.2.7 Other element data	5
3.3 Other terms and quantities	6
3.3.1 Direct transmission	6
3.3.2 Indirect transmission	6
3.3.3 Indirect airborne transmission	6
3.3.4 Indirect structure-borne transmission (flanking transmission)	6
3.3.5 Direction-averaged junction velocity level difference $\overline{D_{v,ij}}$	6
3.3.6 Flanking sound reduction index R_{ij}	6
4 Calculation models	7
4.1 General principles	7
4.2 Detailed model for structure-borne transmission	9
4.2.1 Input data	9
4.2.2 Transfer of input data to in-situ values	10
4.2.3 Determination of direct and flanking transmission in-situ	12
4.2.4 Interpretation for several types of elements	13
4.2.5 Limitations	16
4.3 Detailed model for airborne transmission	16
4.3.1 Determination from measured direct transmission for small elements	16
4.3.2 Determination from measured total indirect transmission	17
4.3.3 Determination from measured transmission for the separate elements of a system	17
4.4 Simplified model for structure-borne transmission	17
4.4.1 Calculation procedure	17
4.4.2 Input data	19
4.4.3 Limitations	20
5 Accuracy	20
Annex A (normative) Symbols	21
Annex B (informative) Sound reduction index for monolithic elements	25
B.1 Sound reduction index in frequency bands	25
B.2 Weighted sound reduction index	28
Annex C (informative) Structural reverberation time	31

Annex D (informative) Sound reduction index improvement of additional layers	34
D.1 Sound reduction index improvement of layers	34
D.1.1 Direct transmission, ΔR	34
D.1.2 Flanking transmission	34
D.2 Weighted sound reduction index improvement of layers	36
Annex E (informative) Vibration reduction index for junctions	38
E.1 Determination methods	38
E.2 Empirical data	38
E.3 Limiting values	39
Annex F (informative) Determination of indirect transmission	47
F.1 Laboratory measurement of total indirect transmission	47
F.1.1 Indirect airborne transmission	48
F.1.2 Flanking transmission	49
F.2 Determination of indirect airborne transmission from known transmission for the separate elements of a system	49
F.2.1 Hall or corridor	49
F.2.2 Ventilation system	50
Annex G (informative) Laboratory weighted sound reduction index including field simulated flanking transmission ('Prüfstand mit bauähnlicher Flankenübertragung', DIN 52210)	51
Annex H (informative) Calculation examples	53
H.1 Situation	53
H.2 Detailed model	54
H.2.1 Results	54
H.2.2 Detailed steps for separating element, floor and inner wall	54
H.2.3 Structural reverberation time partition wall at 500 Hz octave :.....	56
H.3 Simplified model	57
Bibliography	59

Foreword

ISO (the International Organization for Standardization) is a worldwide federation of national standards bodies (ISO member bodies). The work of preparing International Standards is normally carried out through ISO technical committees. Each member body interested in a subject for which a technical committee has been established has the right to be represented on that committee. International organizations, governmental and non-governmental, in liaison with ISO, also take part in the work. ISO collaborates closely with the International Electrotechnical Commission (IEC) on all matters of electrotechnical standardization.

International Standards are drafted in accordance with the rules given in the ISO/IEC Directives, Part 2.

The main task of technical committees is to prepare International Standards. Draft International Standards adopted by the technical committees are circulated to the member bodies for voting. Publication as an International Standard requires approval by at least 75 % of the member bodies casting a vote.

Attention is drawn to the possibility that some of the elements of this document may be the subject of patent rights. ISO shall not be held responsible for identifying any or all such patent rights.

ISO 15712-1 was prepared by CEN/TC 126, *Acoustic properties of building products and of buildings* (as EN 12354-1:2000), and was adopted without modification by Technical Committee ISO/TC 43, *Acoustics*, Subcommittee SC 2, *Building acoustics*.

Throughout the text of this document, read "...this European Standard..." to mean "...this International Standard...".

© ISO 2015

Building acoustics — Estimation of acoustic performance of buildings from the performance of elements —

Part 1: Airborne sound insulation between rooms

1 Scope

This document describes calculation models designed to estimate the airborne sound insulation between rooms in buildings, primarily using measured data which characterize direct or indirect flanking transmission by the participating building elements and theoretically derived methods of sound propagation in structural elements.

A detailed model is described for calculation in frequency bands ; the single number rating can be determined from the calculation results. A simplified model with a restricted field of application is deduced from this, calculating directly the single number rating, using the single number ratings of the elements.

This document describes the principles of the calculation scheme, lists the relevant quantities and defines its applications and restrictions. It is intended for acoustical experts and provides the framework for the development of application documents and tools for other users in the field of building construction, taking into account local circumstances.

The calculation models described use the most general approach for engineering purposes, with a clear link to measurable quantities that specify the performance of building elements. The known limitations of these calculation models are described in this document. Users should, however, be aware that other calculation models also exist, each with their own applicability and restrictions.

The models are based on experience with predictions for dwellings ; they could also be used for other types of buildings provided the construction systems and dimensions of elements are not too different from those in dwellings.

2 Normative references

This European Standard incorporates by dated or undated reference, provisions from other publications. These normative references are cited at the appropriate places in the text and the publications are listed hereafter. For dated references, subsequent amendments to or revisions of any of these publications apply to this European Standard only when incorporated in it by amendment or revision. For undated references the latest edition of the publication referred to applies.

EN 20140-10, *Acoustics - Measurement of sound insulation in buildings and of building elements - Part 10 : Laboratory measurement of airborne sound insulation of small building elements (ISO 140-10:1991).*

EN ISO 140-1, *Acoustics - Measurement of sound insulation in buildings and of building elements – Part 1 : Requirements for laboratory test facilities with suppressed flanking transmission (ISO 140-1:1997).*

EN ISO 140-3, *Acoustics - Measurement of sound insulation in buildings and of building elements – Part 3 : Laboratory measurements of airborne sound insulation of building elements (ISO 140-3:1995).*

EN ISO 140-4, *Acoustics - Measurement of sound insulation in buildings and of building elements - Part 4 : Field measurements of airborne sound insulation between rooms (ISO 140-4:1998).*

EN ISO 717-1, *Acoustics - Rating of sound insulation in buildings and of building elements - Part 1 : Airborne sound insulation (ISO 717-1:1996).*

prEN ISO 10848-1, *Acoustics - Laboratory measurement of the flanking transmission of airborne and impact noise between adjoining rooms – Part 1 : Frame document (ISO/DIS 10848-1:1998).*

3 Relevant quantities

3.1 Quantities to express building performance

The sound insulation between rooms in accordance with EN ISO 140-4 can be expressed in terms of several related quantities. These quantities are determined in frequency bands (one-third octave bands or octave bands) from which the single number rating for the building performance can be obtained in accordance with EN ISO 717-1, for instance R'_w , $D_{nT,w}$ or $(D_{nT,w} + C)$.

3.1.1 Apparent sound reduction index R'

Minus ten times the common logarithm of the ratio of the total sound power W_{tot} transmitted into the receiving room to the sound power W_1 which is incident on a separating element. This ratio is denoted by τ' .

$$R' = -10 \lg \tau' \quad \text{dB} \quad (1)$$

where

$$\tau' = W_{tot} / W_1$$

In general the total sound power transmitted into the receiving room consists of the power radiated by the separating element, the flanking elements and other components.

The index R' it is normally determined from measurements according to :

$$R' = L_1 - L_2 + 10 \lg \frac{S_s}{A} \quad \text{dB} \quad (2)$$

where

L_1 is the average sound pressure level in the source room, in decibels ;

L_2 is the average sound pressure level in the receiving room, in decibels ;

A is the equivalent sound absorption area in the receiving room, in square metres ;

S_s is the area of the separating element, in square metres.

3.1.2 Standardized level difference D_{nT}

The difference in the space and time average sound pressure levels produced in two rooms by one or more sound sources in one of them, corresponding to a reference value of the reverberation time in the receiving room.

$$D_{nT} = L_1 - L_2 + 10 \lg \frac{T}{T_0} \quad \text{dB} \quad (3)$$

where

T is the reverberation time in the receiving room, in seconds ;

T_0 is the reference reverberation time ; for dwellings given as 0,5 s.

3.1.3 Normalized level difference D_n

The difference in the space and time average sound pressure levels produced in two rooms by one or more sound sources in one of them, corresponding to the reference equivalent sound absorption area in the receiving room.

$$D_n = L_1 - L_2 - 10 \lg \frac{A}{A_o} \quad \text{dB} \quad (4)$$

where

A_o is the reference absorption area given as 10 m^2 .

3.1.4 Relation between quantities

The level differences are related to the apparent sound reduction index as follows :

$$D_n = R' + 10 \lg \frac{A_o}{S_s} = R' + 10 \lg \frac{10}{S_s} \quad \text{dB} \quad (5 \text{ a})$$

$$D_{nT} = R' + 10 \lg \frac{0,16 V}{T_o S_s} = R' + 10 \lg \frac{0,32 V}{S_s} \quad \text{dB} \quad (5 \text{ b})$$

where

V is the volume of the receiving room, in cubic metres.

It is sufficient to estimate one of these quantities in order to deduce the other ones. In this document the apparent sound reduction index R' is chosen as the prime quantity to be estimated.

3.2 Quantities to express element performance

The quantities expressing the performance of the elements are used as part of the input data to estimate building performance. These quantities are determined in one-third octave bands and can also be expressed in octave bands. In relevant cases a single number rating for the element performance can be obtained from this, in accordance with EN ISO 717-1, for instance $R_w(C; C_{tr})$.

3.2.1 Sound reduction index R

Ten times the common logarithm of the ratio of the sound power W_1 incident on a test specimen to the sound power W_2 transmitted through the specimen :

$$R = 10 \lg \frac{W_1}{W_2} \quad \text{dB} \quad (6)$$

This quantity is to be determined in accordance with EN ISO 140-3.

3.2.2 Sound reduction index improvement ΔR

The difference in sound reduction index between a basic structural element with an additional layer (e.g. a resilient wall skin, a suspended ceiling, a floating floor) and the basic structural element without this layer.

Annex D gives information on the determination and the use of this quantity.

3.2.3 Element normalized level difference $D_{n,e}$

The difference in the space and time average sound pressure level produced in two rooms by a source in one, where sound transmission is only due to a small building element (e.g. transfer air devices, electrical cable ducts, transit sealing systems). $D_{n,e}$ is normalized to the reference equivalent sound absorption area (A_0) in the receiving room ; $A_0 = 10 \text{ m}^2$.

$$D_{n,e} = L_1 - L_2 - 10 \lg \frac{A}{A_0} \quad \text{dB} \quad (7)$$

where

A is the equivalent sound absorption area in the receiving room, in square metres.

This quantity is to be determined in accordance with EN 20140-10.

3.2.4 Normalized level difference for indirect airborne transmission $D_{n,s}$

The difference in the space and time average sound pressure level produced in two rooms by a source in one of them. Transmission is only considered to occur through a specified path between the rooms (e.g. ventilation systems, corridors). $D_{n,s}$ is normalized to the reference equivalent sound absorption area (A_0) in the receiving room ; $A_0 = 10 \text{ m}^2$.

$$D_{n,s} = L_1 - L_2 - 10 \lg \frac{A}{A_0} \quad \text{dB} \quad (8)$$

The subscript s indicates the type of transmission system considered.

This quantity is to be determined with a measurement method which is comparable to EN 20140-10.

NOTE Dedicated measurement methods for specific systems should be prepared by CEN/TC 126 or CEN/TC 211 (see annex F).

3.2.5 Flanking normalized level difference $D_{n,f}$

The difference in the space and time average sound pressure level produced in two rooms by a source in one of them. Transmission is only considered to occur through a specified flanking path between the rooms (e.g. suspended ceiling, access floor, façade). $D_{n,f}$ is normalized to the reference equivalent sound absorption area (A_0) in the receiving room ; $A_0 = 10 \text{ m}^2$.

$$D_{n,f} = L_1 - L_2 - 10 \lg \frac{A}{A_0} \quad \text{dB} \quad (9)$$

This quantity is to be determined according to prEN ISO 10848-1.

NOTE For suspended ceilings EN 20140-9 is available, where the subscript 'c' is used instead of the more general 'f'. For access floors a standard is in preparation : prEN ISO 140-11 (see annex F).

3.2.6 Vibration reduction index K_{ij}

This quantity is related to the vibrational power transmission over a junction between structural elements, normalized in order to make it an invariant quantity. It is determined by normalizing the direction-averaged velocity level difference over the junction, to the junction length and the equivalent sound absorption length, if relevant, of both elements in accordance with the following equation :

$$K_{ij} = \frac{D_{v,ij} + D_{v,ji}}{2} + 10 \lg \frac{l_{ij}}{\sqrt{a_i a_j}} \quad \text{dB} \quad (10)$$

where

$D_{v,ij}$ is the velocity level difference between element i and j, when element i is excited, in decibels ;

$D_{v,ji}$ is the velocity level difference between element j and i, when element j is excited, in decibels ;

l_{ij} is the common length of the junction between element i and j, in metres ;

a_i is the equivalent absorption length of element i, in metres ;

a_j is the equivalent absorption length of element j, in metres.

The equivalent absorption length is given by :

$$a = \frac{2,2\pi^2 S}{c_o T_s} \sqrt{\frac{f_{\text{ref}}}{f}} \quad (11)$$

where

T_s is the structural reverberation time of the element i or j, in seconds ;

S is the area of element i or j, in square metres ;

f is the centre band frequency, in Hertz ;

f_{ref} is the reference frequency; $f_{\text{ref}} = 1\,000$ Hz ;

c_o is the speed of sound in air, in metres per second.

NOTE 1 The equivalent absorption length is the length of a fictional totally absorbing edge of an element if its critical frequency is assumed to be 1 000 Hz, giving the same loss as the total losses of the element in a given situation.

The quantity K_{ij} is to be determined in accordance with prEN ISO 10848-1.

NOTE 2 For the time being values for this quantity can be taken from annex E or be deduced from available data on the junction velocity level difference according to annex E.

3.2.7 Other element data

For the calculations additional information on the element can be necessary, e.g. :

- mass per unit area m' , in kilograms per square metre ;
- type of element ;
- material ;
- type of junction.

3.3 Other terms and quantities

3.3.1 Direct transmission

Transmission due only to sound incident on a separating element and directly radiated from it (structure-borne) or transmitted through parts of it (airborne) such as slits, air moving devices or louvres.

3.3.2 Indirect transmission

Transmission of sound from a source room to a receiving room, through transmission paths other than the direct transmission path. It can be divided into airborne transmission and structure-borne transmission. The latter is called flanking transmission.

3.3.3 Indirect airborne transmission

Indirect transmission of sound energy via an airborne transmission path mainly, e.g. ventilation systems, suspended ceilings and corridors

3.3.4 Indirect structure-borne transmission (flanking transmission)

Transmission of sound energy from a source room to a receiving room via structural (vibrational) paths in the construction mainly, e.g. walls, floors, ceilings.

3.3.5 Direction-averaged junction velocity level difference $\overline{D_{v,ij}}$

The average of the junction velocity level difference from element i to j and element j to i :

$$\overline{D_{v,ij}} = \frac{D_{v,ij} + D_{v,ji}}{2} \text{ dB} \quad (12)$$

3.3.6 Flanking sound reduction index R_{ij}

Minus ten times the common logarithm of the flanking transmission factor τ_{ij} , which is the ratio of the sound power W_{ij} radiated from a flanking construction j in the receiving room due to incident sound on construction i in the source room to the sound power W_1 which is incident on a reference area in the source room. The area of the separating element is chosen as the reference area.

$$R_{ij} = -10 \lg \tau_{ij} \text{ dB} \quad (13)$$

where

$$\tau_{ij} = W_{ij} / W_1$$

NOTE The area of the separating element is chosen as the reference since then the contribution of each transmission path to the total transmission is directly indicated, which is not the case with other choices.

4 Calculation models

4.1 General principles

The sound power in the receiving room is due to sound radiated by the separating structural elements and the flanking structural elements in that room and by the relevant direct and indirect airborne sound transmission. The total transmission factor can be divided into transmission factors, related to each element in the receiving room and the elements and systems involved in the direct and indirect airborne transmission :

$$R' = -10 \lg \tau' \quad \text{dB} \quad (14)$$

$$\tau' = \tau_d + \sum_{f=1}^n \tau_f + \sum_{e=1}^m \tau_e + \sum_{s=1}^k \tau_s$$

where the indices d, f, e and s refer to the different contributions to the sound transmission illustrated in Figure 1 and where

- τ' is the sound power ratio of total radiated sound power in the receiving room relative to incident sound power on the common part of the separating element ;
- τ_d is the sound power ratio of radiated sound power by the common part of the separating element relative to incident sound power on the common part of the separating element. It includes the paths Dd and Fd shown in Figure 2 ;
- τ_f is the sound power ratio of radiated sound power by a flanking element f in the receiving room relative to incident sound power on the common part of the separating element. It includes paths Ff and Df shown in Figure 2 ;
- τ_e is the sound power ratio of radiated sound power in the receiving room by an element in the separating element due to direct airborne transmission of incident sound on this element, relative to incident sound power on the common part of the separating element ;
- τ_s is the sound power ratio of radiated sound power in the receiving room by a system s due to indirect airborne transmission of incident sound on this transmission system, relative to incident sound power on the common part of the separating element ;
- n is the number of flanking elements ; normally $n = 4$, but it can be smaller or larger ;
- m is the number of elements with direct airborne transmission ;
- k is the number of systems with indirect airborne transmission.

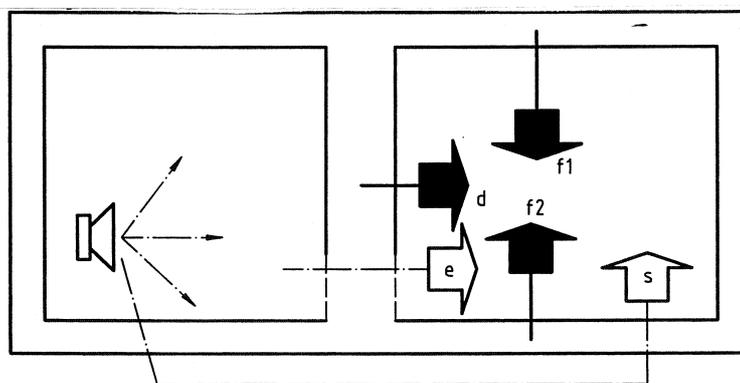

Figure 1 — Illustration of the different contributions to the total sound transmission to a room : d - radiated directly from the separating element, f1 and f2 – radiated from flanking elements, e – radiated from components mounted in the separating element, s – indirect transmission

The sound radiated by a structural element can be considered to be the sum of structure-borne sound transmission through several paths. Each path can be identified by the element i on which the sound is incident in the source room and the radiating element j in the receiving room. The paths for a flanking element and the separating element are shown in Figure 2, where in the source room the elements i are designated by F for the flanking element and D for the separating element and in the receiving room the elements j are designated by f for a flanking element and d for the separating element.

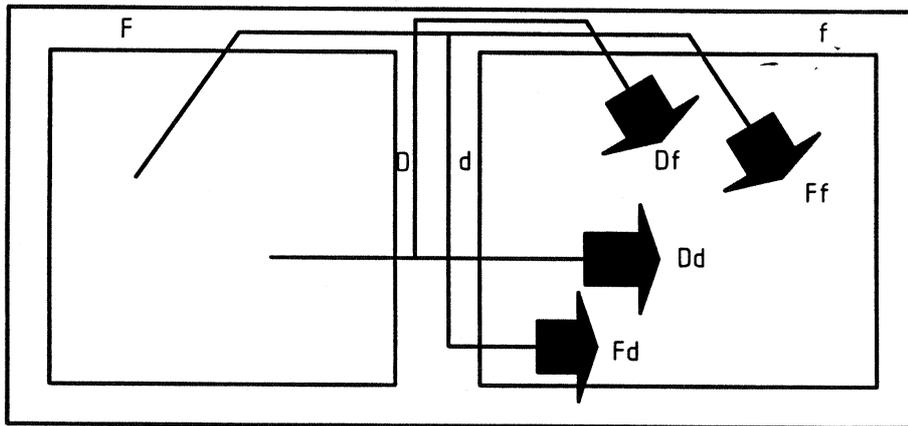

Figure 2 — Definition of sound transmission paths ij between two rooms

The main assumptions with this approach are that the transmission paths described can be considered to be independent and that the sound and vibrational fields behave statistically. Within these restrictions this approach is quite general, in principle allowing for various types of structural elements, i.e. monolithic elements, cavity walls, lightweight double leaf walls, and different positioning of the two rooms. However, the available possibilities to describe the transmission by each path imposes restrictions in this respect. The model presented is therefore restricted to adjacent rooms, while the type of elements is mainly restricted by the available information on the vibration reduction index to monolithic and lightweight double elements. Some indications are given in 4.2.4 for the application to other double elements such as cavity walls.

The transmission factor for the separating element consists of contributions from the direct transmission and n flanking transmission paths.

$$\tau_d = \tau_{Dd} + \sum_{F=1}^n \tau_{Fd} \tag{15}$$

The transmission factor for each of the flanking elements f in the receiving room consists of contributions from 2 flanking transmission paths.

$$\tau_f = \tau_{Df} + \tau_{Ff} \tag{16}$$

The transmission factors for these structure-borne transmission paths are related to the sound reduction index for direct transmission (R_{Dd}) and the flanking sound reduction index (R_{ij}) as follows :

$$\tau_{Dd} = 10^{-R_{Dd}/10} \tag{17}$$

$$\tau_{ij} = 10^{-R_{ij}/10}$$

The transmission factors for the direct and indirect airborne transmission are related to the element normalized level difference ($D_{n,e}$) and the normalized level difference for indirect airborne transmission ($D_{n,s}$) as follows :

$$\tau_e = \frac{A_o}{S_s} 10^{-D_{n,e}/10}$$

$$\tau_s = \frac{A_o}{S_s} 10^{-D_{n,s}/10}$$
(18)

where

S_s is the area of the separating element, in square metres ;

A_o is the reference equivalent sound absorption area, in square metres.

The detailed model calculates the building performance in frequency bands, based on acoustic data for the building elements in frequency bands (one-third octave bands or octave bands). As a minimum the calculation has to be performed for octave bands from 125 Hz to 2 000 Hz or for one-third octave bands from 100 Hz to 3 150 Hz. From these results the single number rating for the building performance can be deduced in accordance with EN ISO 717-1.

NOTE The calculations can be extended to higher or lower frequencies if element data are available for these frequencies. However, especially for the lower frequencies no information is available at this time on the accuracy of calculations for these extended frequency regions.

The detailed model deals with both the structure-borne transmission and the direct and indirect airborne transmission. Since these transmission paths can be considered as independent they are treated separately. The calculation of the structure-borne transmission is described in section 4.2. The direct and indirect airborne transmission is described in section 4.3.

The simplified model calculates the building performance as a single number rating, based on the single number ratings of the performance of the elements involved. The simplified model considers only the structure-borne transmission and is described in section 4.4.

4.2 Detailed model for structure-borne transmission

4.2.1 Input data

The transmission for each of the paths can be determined from :

- sound reduction index of separating element : R_s ;
- sound reduction index for element i in source room : R_i ;
- sound reduction index for element j in receiving room : R_j ;
- sound reduction index improvement by additional layers for separating element in the source room and/or in the receiving room : $\Delta R_D, \Delta R_d$;
- sound reduction index improvement by additional layers for element i in the source room and/or element j in the receiving room : $\Delta R_i, \Delta R_j$;
- structural reverberation time for an element in the laboratory : $T_{s,lab}$;
- vibration reduction index for each transmission path from element i to element j : K_{ij} ;
- area of separating element : S_s ;

ISO 15712-1:2005(E)

- area of element i in source room : S_i ;
- area of element j in receiving room : S_j ;
- common coupling length between element i and element j as measured from surface to surface : l_{ij} ;

NOTE If D_{nT} or D_n is calculated, the area of the separating element serves as an arbitrary reference and could be taken as 10 m^2 throughout the calculations.

The acoustic data on the elements involved should be taken primarily from standardized laboratory measurements. However, they may also be deduced in other ways, using theoretical calculations, empirical estimations or measurement results from field situations. Information on this is given in some annexes. The sources of the data used, shall be clearly stated.

Information on the sound reduction index for homogeneous elements is given in annex B.

Information on the structural reverberation time for homogeneous elements is given in annex C.

Information on the sound reduction index improvement and flanking sound reduction index improvement is given in annex D.

Information on the vibration reduction index for common junctions is given in annex E.

4.2.2 Transfer of input data to in-situ values

Acoustic data for the elements (structural elements, additional layers and junctions) have to be converted into in-situ values before the actual determination of the sound transmission.

For the **separating element** and each of the **flanking elements** the in-situ value of the sound reduction index R_{situ} follows from :

$$R_{\text{situ}} = R - 10 \lg \frac{T_{\text{s,situ}}}{T_{\text{s,lab}}} \quad \text{dB} \quad (19)$$

where

$T_{\text{s,situ}}$ is the structural reverberation time of the element in the actual field situation, in seconds ;

$T_{\text{s,lab}}$ is the structural reverberation time of the element in the laboratory, in seconds.

For direct transmission R shall include the forced transmission as included in laboratory measurements.

For each flanking transmission path the sound reduction index R of the involved elements (including the separating element) should relate to the resonant transmission only. It is correct to apply the laboratory sound reduction index above the critical frequency. Below the critical frequency this can be considered a reasonable estimation which errs on the low side, due to non-resonant transmission. If the values of the sound reduction index are based on calculations from material properties, it is best to consider only resonant transmission over the whole frequency range of interest.

For the following building elements the structural reverberation time $T_{\text{s,situ}}$ shall be taken as being equal to $T_{\text{s,lab}}$ which leads to a correction term of 0 dB :

- lightweight, double leaf elements, such as timber framed or metal framed stud walls ;
- elements with an internal loss factor greater than 0,03 ;
- elements which are much lighter than the surrounding structural elements (by a factor of at least three) ;
- elements which are not firmly connected to the surrounding structural elements.

Otherwise the structural reverberation time, both for the laboratory and for the actual field situation, is to be taken into account; see annex C.

NOTE 1 As a first approximation the correction terms for all types of elements can be taken as 0 dB.

For the **additional layers** the laboratory value can be used as an approximation for the in-situ value of the improvement ΔR_{situ} :

$$\Delta R_{\text{situ}} = \Delta R \quad \text{dB} \quad (20)$$

For each flanking transmission path the sound reduction index improvement ΔR of the involved elements (including the separating element) should relate to the resonant transmission only. However, measurement methods to determine this are not readily available and there is some evidence, to indicate that the improvement for direct transmission is also reasonable, as an estimate for the improvement for flanking transmission too; see annex D.

For the **junctions** the in-situ transmission is characterized by the direction-averaged junction velocity level difference $\overline{D_{v,ij,\text{situ}}}$. This follows from the vibration reduction index :

$$\overline{D_{v,ij,\text{situ}}} = K_{ij} - 10 \lg \frac{l_{ij}}{\sqrt{a_{i,\text{situ}} a_{j,\text{situ}}}} \text{ dB} ; \overline{D_{v,ij,\text{situ}}} \geq 0 \quad \text{dB} \quad (21)$$

with

$$a_{i,\text{situ}} = \frac{2,2\pi^2 S_i}{c_0 T_{s,i,\text{situ}}} \sqrt{\frac{f_{\text{ref}}}{f}} \quad (22)$$

$$a_{j,\text{situ}} = \frac{2,2\pi^2 S_j}{c_0 T_{s,j,\text{situ}}} \sqrt{\frac{f_{\text{ref}}}{f}}$$

where

- $a_{i,\text{situ}}$ is the equivalent absorption length of element i in the actual field situation, in metres ;
- $a_{j,\text{situ}}$ is the equivalent absorption length of element j in the actual field situation, in metres ;
- f is the centre band frequency, in Hertz ;
- f_{ref} is the reference frequency ; $f_{\text{ref}} = 1\,000$ Hz ;
- c_0 is the speed of sound in air, in metres per second ;
- l_{ij} is the coupling length of the common junction between elements i and j, in metres ;
- S_i is the area of element i, in square metres ;
- S_j is the area of element j, in square metres ;
- $T_{s,i,\text{situ}}$ is the structural reverberation time of element i in the actual field situation, in seconds ;
- $T_{s,j,\text{situ}}$ is the structural reverberation time of element j in the actual field situation, in seconds.

For the following building elements the equivalent absorption length a_{situ} is taken as numerically equal to the area of the element, so $a_{i,\text{situ}} = S_i/l_0$ and/or $a_{j,\text{situ}} = S_j/l_0$, where the reference length $l_0 = 1 \text{ m}$:

- lightweight, double leaf elements, such as timber framed or metal framed stud walls ;
- elements with an internal loss factor greater than 0,03 ;
- elements which are much lighter than the surrounding structural elements (by a factor of at least three) ;
- elements which are not firmly connected to the surrounding structural elements.

Otherwise the structural reverberation time for the actual field situation has to be taken into account ; see annex C.

NOTE 2 As a first approximation the equivalent absorption length can be taken as $a_{i,\text{situ}} = S_i/l_0$ and $a_{j,\text{situ}} = S_j/l_0$ for all types of elements with $l_0 = 1 \text{ m}$. If in that case the vibration reduction index has a lower value than a minimum value $K_{ij,\text{min}}$, that minimum value is to be used. The minimum value is given by (ij = Ff, Fd or Df) :

$$k_{ij,\text{min}} = 10 \lg \left[l_{ij} l_0 \left(\frac{1}{S_i} + \frac{1}{S_j} \right) \right] \text{ dB} \quad (23)$$

4.2.3 Determination of direct and flanking transmission in-situ

The sound reduction index for direct transmission is determined from the adjusted input value for the separating element according to the following :

$$R_{\text{Dd}} = R_{s,\text{situ}} + \Delta R_{\text{D},\text{situ}} + \Delta R_{\text{d},\text{situ}} \text{ dB} \quad (24)$$

The flanking sound reduction index is determined from the adjusted input values according to the following, with ij = Ff, Fd and Df :

$$R_{ij} = \frac{R_{i,\text{situ}}}{2} + \Delta R_{i,\text{situ}} + \frac{R_{j,\text{situ}}}{2} + \Delta R_{j,\text{situ}} + \overline{D_{v,ij,\text{situ}}} + 10 \lg \frac{S_s}{\sqrt{S_i S_j}} \text{ dB} \quad (25 \text{ a})$$

NOTE 1 If as a first approximation the terms with the structural reverberation time are taken as 0 dB and the equivalent absorption lengths are taken as $a_{i,\text{situ}} = S_i/l_0$ and $a_{j,\text{situ}} = S_j/l_0$ for all types of elements, equation (25 a) can be written as :

$$R_{ij} = \frac{R_i}{2} + \Delta R_i + \frac{R_j}{2} + \Delta R_j + K_{ij} + 10 \lg \frac{S_s}{l_0 l_{ij}} \text{ dB} \quad (25 \text{ b})$$

NOTE 2 Equation (25 a)) is identical to the following equation :

$$R_{ij} = R_{i,\text{situ}} + \Delta R_{i,\text{situ}} + \Delta R_{j,\text{situ}} + D_{v,ij,\text{situ}} + 10 \lg \frac{S_s}{S_j} + 10 \lg \frac{\sigma_{i,\text{situ}}}{\sigma_{j,\text{situ}}} \text{ dB} \quad (25 \text{ c})$$

However, since the junction velocity level difference is not an invariant quantity and the radiation factors are often not known, this relation is less suited for predictions. It could be used in existing field situations to estimate flanking transmission if appropriate data (measured or estimated) on the junction velocity level difference $D_{v,ij}$ and the radiation factors σ_i and σ_j for that field situation are available.

NOTE 3 For certain building situations (combinations of lightweight elements or combinations of lightweight elements and massive elements, e.g with suspended ceilings or lightweight facades) the flanking transmission is dominated by path Ff (the contributions of path Df and Fd being negligible). Often that transmission also includes or is even dominated by indirect airborne transmission paths. In that case it is feasible to characterize the flanking transmission for this construction as a whole by laboratory measurements, expressed as $D_{n,F}$, from which the flanking sound reduction index R_{FF} can be deduced ; see annex F.

The sound transmission by the separating element and by the flanking elements can be calculated in accordance with equations (15) and (16), applying the equations (17), (19) to (25) inclusive. The total sound transmission (apparent sound reduction index) can be calculated with equation (14), using the results of section 4.3 if applicable.

4.2.4 Interpretation for several types of elements

— For flanking elements constructed of several parts the sound reduction index of the larger part directly connected to the separating element should be taken into account. If complete discontinuities occur in the element, such as doors or heavy cross elements, the parts behind these discontinuities can be neglected.

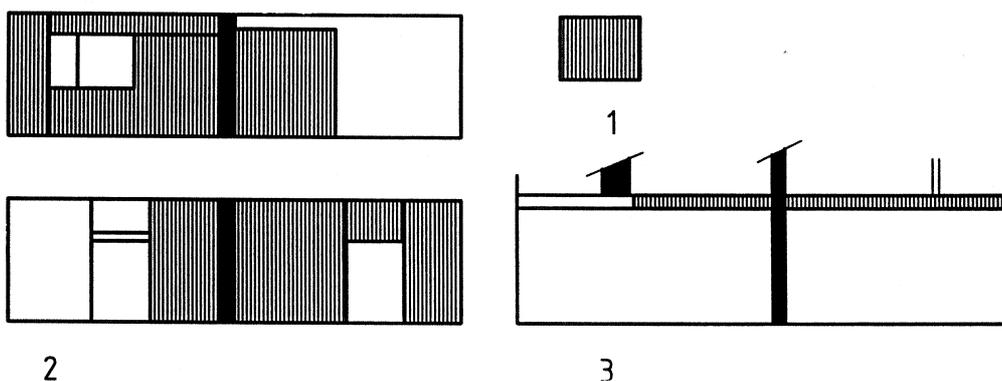

Legend

- 1 Structure to consider
- 2 Side views
- 3 Vertical cross section

Figure 3

— If a flanking construction consists of more types of elements, each directly connected to the separating element, each of these types has to be considered as a separate flanking element (in the illustration the flanking element f consists of the two types a and b).

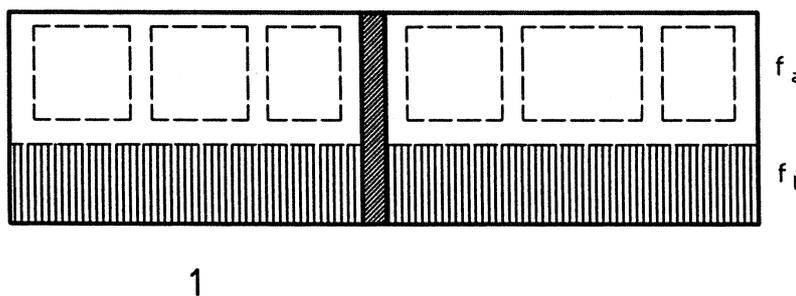

Legend

- 1 Side view

Figure 4

— For flanking elements not in a single plane, i.e. with bends or other shapes, the total area can be used, unless the angles at the discontinuities are large such as those with 90-degree corners ; in such cases an effective total area can be used, taking into account the vibration level difference at the discontinuity.

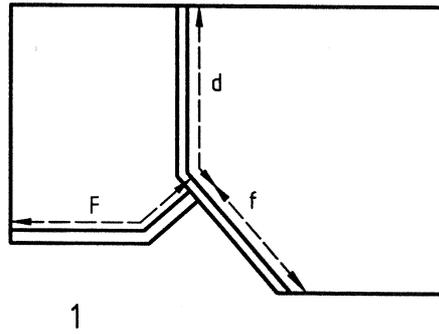

Legend

1 Horizontal cross section

Figure 5

— With additional layers such, as wall linings or floating floors, the sound reduction index and junction transmission index relates to the basic structural element, the effect of the additional layer being taken into account separately by ΔR .

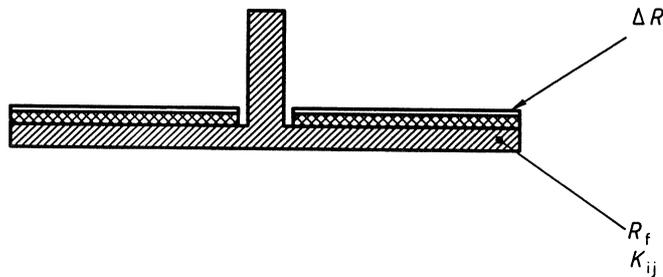

Figure 6

— With additional external layers, such as lightweight external lining, which have negligible influence on the behaviour of the basic structural element, the calculation should concern only the basic inner element. The effect of the external lining or construction may be neglected or otherwise be taken into account through the vibration reduction index.

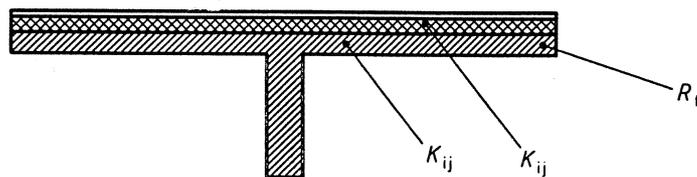

Figure 7

— With cavity flanking elements the calculation should concern primarily the inner element with the effect of the external element taken into account through the vibration reduction index. This index can be based on measurements in similar situations or be estimated by considering the various transmission paths contributing to the vibration reduction index.

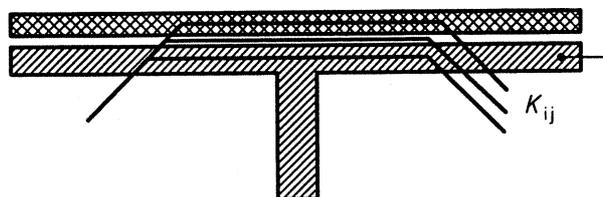

Figure 8

- With cavity walls as a separating element the sound reduction index should include the effect of the transmission from one leaf to the other via the connections around the perimeter of the element, if any.

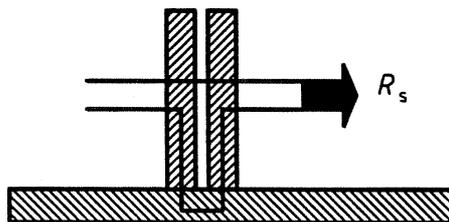

Figure 9

- With split-level (i.e. stepped) or horizontally displaced (i.e. staggered) rooms the continuation of the separating construction should be treated as a flanking element, often the dominant one.

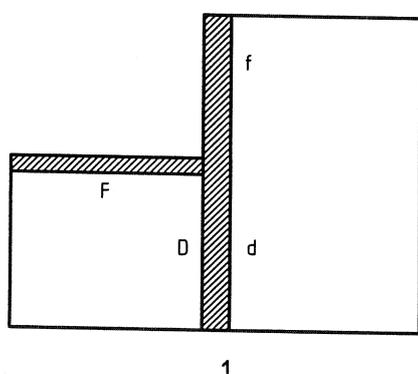

Figure 10

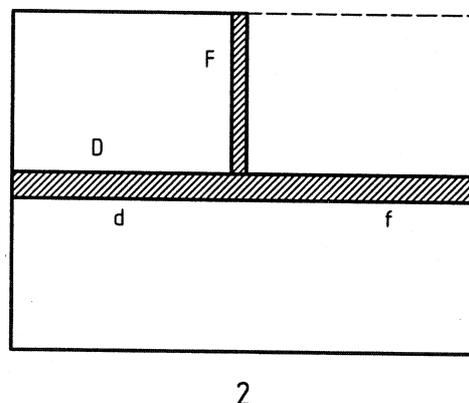

Figure 11

Legend

1 Horizontal cross section

Legend

2 Vertical cross section

- In the case of lightweight internal walls and large floor slabs between load-bearing walls, the transmission is determined by the vibrations of the total floor area. In the limiting case of very light walls it is preferred to estimate the direct and flanking transmission by the floor as a whole by :

$$R_{Dd+Df} = R_s - 10 \lg(T_{s,tot}/T_{s,lab}) - 10 \lg(S_{rec}/S_{tot}),$$

where

S_{rec} is the total floor area in the receiving room and the subscript 'tot' refers to the total floor between the load-bearing walls. This corresponds to applying the model for the relevant flanking path with $D_{v,ij,situ} = 0$ dB.

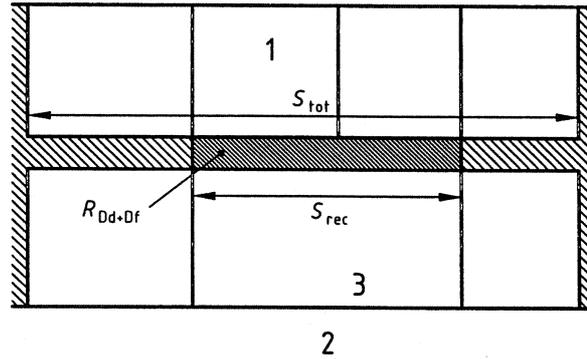

Legend

- 1 Source room
- 2 Vertical cross section
- 3 Receiving room

Figure 12

4.2.5 Limitations

- The model can be used only for combinations of elements for which the vibration reduction index is known or can be estimated from known values ;
- The model is only applicable for basic structural elements which have approximately the same radiation characteristics for both sides ;
- With very large floors, floors with columns and lightweight internal walls, the floor of a room can no longer be considered as an independent element, so the incorporation according to the model can only be considered a rough estimate ;
- The contribution of secondary transmission paths involving more than one junction is neglected. This is partly compensated by the values for the vibration reduction index as far as these are based on field measurements, but could cause an underestimation of flanking transmission with homogeneous elements in other cases. These secondary transmission paths may become important when additional layers are applied to a large part of the elements ;
- The model only describes the transmission between adjacent rooms.

4.3 Detailed model for airborne transmission

4.3.1 Determination from measured direct transmission for small elements

The contribution can be directly determined from the element normalized level difference of the elements considered, $D_{n,e}$, through equations (18) and (14). In principle the element as applied should be identical to the element for which data are available, so $D_{n,e,situ} = D_{n,e}$.

NOTE However, for some types of elements, like slits or transfer air devices, it may be feasible to extrapolate the acoustic behavior of an element as applied in situ, from the element data on an equivalent element with for instance a different length. In that case $D_{n,e,situ}$ could be deduced from $D_{n,e}$ by taking into account the different dimensions in an appropriate way.

4.3.2 Determination from measured total indirect transmission

No standardized methods of measurement are currently available to characterize the indirect airborne transmission $D_{n,s}$ for transmission systems as a whole. While it is desirable to develop such methods for certain transmission systems such as domestic ventilation systems, for many other indirect transmission systems it may be preferable to base predictions on data for the separate elements of such systems (see 4.3.3).

For flanking constructions, the transmission is generally a combination of both airborne and structure-borne transmission. However, the only standardized measurement method currently available to determine flanking normalized level difference ($D_{n,f}$) is for suspended ceilings, where the indirect airborne transmission path is usually dominant and therefore its use in a prediction method is feasible ; see annex F.

No standardized method is currently available for other types of flanking constructions with dominant indirect structure-borne transmission (see annex F).

4.3.3 Determination from measured transmission for the separate elements of a system

No calculation scheme is currently available to determine the normalized level difference $D_{n,s}$ from knowledge and acoustical data on the elements involved in the transmission, i.e. ventilation ducts, silencers, suspended ceilings, corridor/hall, doors and doorgaps. Some proposals do however exist, which could form the basis for further development of such schemes. For some situations information is given in annex F.

4.4 Simplified model for structure-borne transmission

4.4.1 Calculation procedure

The simplified version of the calculation model predicts the weighted apparent sound reduction index on the bases of the weighted sound reduction indices of the elements involved. It concerns the weighting in accordance with EN ISO 717-1. The model is given for the weighted sound reduction index, R_w , but can also be applied to the single number rating with the spectrum adaptation term, i.e. $R_w + C$. The resulting estimate of the building performance is given in the same type of single number rating as is used for the building elements, i.e. R'_w or $(R'_w + C)$.

NOTE 1 For convenience the sums with the spectrum adaptation term can be denoted by one symbol, for instance $R'_w + C = R'_A$ and $D_{nT,w} + C = D_{nT,A}$.

NOTE 2 The energetic summation involved in the model is exact for R'_A and a reasonable approximation for R'_w .

The application of the simplified model is restricted to direct and flanking transmission with primarily homogeneous elements. The influence of the structural damping of elements is taken into account in an average way, neglecting the specifics of the situation. Each flanking element should be essentially the same on the source and receiving side. If the values for the vibration reduction index depend on frequency, the value at 500 Hz may be taken as a good approximation, but the result can then be less accurate.

For the simplified model the prediction equations (13), (14), (15) and (16) are re-written and the weighted apparent sound reduction index between two rooms is determined from :

$$R'_w = -10 \lg \left[10^{-R_{Dd,w}/10} + \sum_{F=f=1}^n 10^{-R_{Ff,w}/10} + \sum_{f=1}^n 10^{-R_{Df,w}/10} + \sum_{F=f=1}^n 10^{-R_{Fd,w}/10} \right] \text{ dB} \quad (26)$$

where

$R_{Dd,w}$ is the weighted sound reduction index for direct transmission, in decibels ;

$R_{Ff,w}$ is the weighted flanking sound reduction index for the transmission path Ff, in decibels ;

$R_{Df,w}$ is the weighted flanking sound reduction index for the transmission path Df, in decibels ;

$R_{Fd,w}$ is the weighted flanking sound reduction index for the transmission path Fd, in decibels ;

n is the number of flanking elements in a room ; normally $n = 4$, but it can be smaller or larger depending on the design and construction of the considered situation (see 4.2.4).

NOTE 3 For certain building situations (combinations of lightweight elements or combinations of lightweight elements and massive elements, e.g with suspended ceilings or lightweight facades) the flanking transmission is dominated by path Ff and the last two terms in (26) can be neglected for that flanking element.

NOTE 4 The contribution by one flanking element to the total flanking transmission can be evaluated by adding the corresponding transmission via the paths Ff and Df ; the contribution of flanking transmission to the radiation by the separating element can be evaluated by adding the transmission via the paths Fd for all flanking elements.

For each transmission path the weighted sound reduction index is predicted from the input data on the elements and junctions (see 4.4.2).

The weighted sound reduction index for direct transmission is determined from the input value for the separating element according to the following :

$$R_{Dd,w} = R_{s,w} + \Delta R_{Dd,w} \quad \text{dB} \quad (27)$$

where

$R_{s,w}$ is the weighted sound reduction index of the separating element, in decibels ;

$\Delta R_{Dd,w}$ is the total weighted sound reduction index improvement by additional lining on the source and/or receiving side of the separating element, in decibels.

The weighted flanking sound reduction indices are determined from the input values according to the following :

$$\begin{aligned} R_{Ff,w} &= \frac{R_{F,w} + R_{f,w}}{2} + \Delta R_{Ff,w} + K_{Ff} + 10 \lg \frac{S_s}{l_o l_f} \quad \text{dB} \\ R_{Fd,w} &= \frac{R_{F,w} + R_{s,w}}{2} + \Delta R_{Fd,w} + K_{Fd} + 10 \lg \frac{S_s}{l_o l_f} \quad \text{dB} \\ R_{Df,w} &= \frac{R_{s,w} + R_{f,w}}{2} + \Delta R_{Df,w} + K_{Df} + 10 \lg \frac{S_s}{l_o l_f} \quad \text{dB} \end{aligned} \quad (28a)$$

where

$R_{F,w}$ is the weighted sound reduction index of the flanking element F in the source room, in decibels ;

$R_{f,w}$ is the weighted sound reduction index of the flanking element f in the receiving room, in decibels ;

$\Delta R_{Ff,w}$ is the total weighted sound reduction index improvement by additional lining on the source and/or receiving side of the flanking element, in decibels ;

$\Delta R_{Fd,w}$ is the total weighted sound reduction index improvement by additional lining on the flanking element at the source side and/or separating element at the receiving side, in decibels ;

$\Delta R_{Df,w}$ is the total weighted sound reduction index improvement by additional lining on the separating element at the source side and/or flanking element at the receiving side, in decibels ;

K_{Ff} is the vibration reduction index for transmission path Ff, in decibels ;

K_{Fd} is the vibration reduction index for transmission path Fd, in decibels ;

K_{Df} is the vibration reduction index for transmission path Df, in decibels ;

S_s is the area of the separating element, in square metres ;

l_f is the common coupling length of the junction between separating element and the flanking elements F and f, in metres ;

l_o is the reference coupling length ; $l_o = 1$ m.

NOTE 5 According to equation (25c)) it follows for homogeneous building elements with a radiation factor of 1 that the weighted flanking sound reduction index can be expressed as ($ij = Ff, Fd$ or Df) :

$$R_{ij,w} = R_{i,w} + \Delta R_{ij,w} + D_{v,ij,situ} + 10 \lg \frac{S_s}{S_j} \quad \text{dB} \quad (28b))$$

However, since the junction velocity level difference is not an invariant quantity this relation is less suited for predictions. It could be used in existing field situations to estimate flanking transmission, if appropriate, measured or estimated, data on the junction velocity level different $D_{v,ij}$ for that field situation is available.

NOTE 6 For certain flanking constructions, like suspended ceilings, lightweight facades or walls, the transmission is dominated by path Ff, so the contributions of path Df and Fd can be neglected. If that transmission is characterized by the weighted flanking normalized level difference $D_{n,f,w}$ the following holds (see also annex F) :

$$R_{Ff,w} = D_{n,f,w} + 10 \lg \frac{l_{lab}}{l_f} + 10 \lg \frac{S_s}{A_o} \quad \text{dB} \quad (28c))$$

For suspended ceilings this quantity is denoted as $D_{n,c,w}$ and $l_{lab} = 4,5$ m.

This is only applicable if the dimensions considered are similar to those applied in the laboratory.

4.4.2 Input data

Acoustic data on the elements involved should be taken primarily from standardized laboratory measurements. However, they may also be deduced in other ways, using theoretical calculations, empirical estimations or measurement results from field situations. Information on this is given in some annexes. The sources of data used, shall be clearly stated.

The input data consist of the following :

- the weighted sound reduction index of the elements : $R_{s,w}$, $R_{F,w}$, $R_{f,w}$;
- Information on this for homogeneous elements is given in annex B ;
- the vibration reduction index for each junction and path : K_{Ff} ; K_{Fd} ; K_{Df} ;

Information on this for common junctions is given in annex E. If the values are frequency dependent the value at 500 Hz is to be used in this simplified model. If the value is lower than a minimum value $K_{ij,min}$, that minimum value is to be taken. The minimum value is given by ($ij = Ff, Fd$ or Df) :

$$K_{ij,min} = 10 \lg \left[l_f l_o \left(\frac{1}{S_i} + \frac{1}{S_j} \right) \right] \quad \text{dB} \quad (29)$$

If a flanking element has insignificant or no structural contact with the separating element, K_{Ff} is to be taken equal to this minimum value, while the transmission paths Fd and Df are to be neglected (i.e. by setting the K_{ij} values very high) ;

- the total weighted sound reduction index improvement for the separating element : $\Delta R_{Dd,w}$;

This value follows either directly from available results for the appropriate combination or is deduced from results for each of the layers involved separately :

$$\begin{aligned} \text{one layer : } \Delta R_{Dd,w} &= \Delta R_{D,w} \text{ or } \Delta R_{d,w} \text{ dB} \\ \text{two layers : } \Delta R_{Dd,w} &= \Delta R_{D,w} + \frac{\Delta R_{d,w}}{2} \text{ or } = \Delta R_{d,w} + \frac{\Delta R_{D,w}}{2} \text{ dB} \end{aligned} \quad (30)$$

In the case of two linings half the value is taken for the lining with the lower value ;

— the total weighted sound reduction index improvement for each flanking path : $\Delta R_{Ff,w}$; $\Delta R_{Fd,w}$; $\Delta R_{Df,w}$;

These values follow either directly from available results for the appropriate combination or are deduced from results for each of the layers involved separately ($ij = Ff, Fd$ or Df) :

$$\begin{aligned} \text{one layer : } \Delta R_{ij,w} &= \Delta R_{i,w} \text{ or } \Delta R_{j,w} \text{ dB} \\ \text{two layers : } \Delta R_{ij,w} &= \Delta R_{i,w} + \frac{\Delta R_{j,w}}{2} \text{ or } = \Delta R_{j,w} + \frac{\Delta R_{i,w}}{2} \text{ dB} \end{aligned} \quad (31)$$

In the case of two linings half the value is taken for the lining with the lower value.

Information on the weighted sound reduction index improvement is given in annex D.

4.4.3 Limitations

- the limitations for the detailed model also apply for the simplified model ;
- the simplified model applies mainly to dwellings where the dimensions of the elements are similar to those in the test facility. Deviations from this may result in less accurate results ;
- the simplified model assumes elements for which the sound reduction index has a similar frequency dependence ; with elements which have a clearly deviating frequency behaviour, as for instance double, lightweight elements, the accuracy may be less.

5 Accuracy

The calculation models predict the measured performance of buildings, assuming good workmanship and high measurement accuracy. The accuracy of the prediction by the models presented depends on many factors : the accuracy of the input data, the fitting of the situation to the model, the type of elements and junctions involved, the geometry of the situation and the workmanship. It is therefore not possible to specify the accuracy of the predictions in general for all types of situations and applications. Data on the accuracy will have to be gathered in future by comparing the results of the model with a variety of field situations. However, some indications can be given.

The main experience in the application of similar models has been so far with buildings where the basic structural elements are homogeneous, i.e. brick walls, concrete, gypsum blocks etc. In those situations the prediction of the single number rating by the detailed model is on average correct (no bias error) with a standard deviation of 1,5 dB to 2,5 dB (the lower value if all aspects are taken into account, the larger to complex situations and when neglecting the structural reverberation time).

Predictions with the simplified model show a standard deviation of about 2 dB, with a tendency to over-estimate the insulation slightly.

In applying the predictions it is advisable to vary the input data, especially in complicated situations and with atypical elements with questionable input data. The resulting variation in the results gives an impression of the expected accuracy for these situations, assuming similar workmanship.

Annex A (normative)

Symbols

Symbol	Physical quantity	Unit
a	equivalent absorption length of a structural element	[m]
a_{situ}	equivalent absorption length of a structural element in the actual field situation	[m]
A	equivalent sound absorption area in the receiving room	[m ²]
A_o	reference equivalent sound absorption area ; for dwellings given as 10 m ²	[m ²]
A_h	equivalent sound absorption area of a hall	[m ²]
c_B	bending wave speed	[m/s]
c_L	longitudinal wave speed	[m/s]
C_α	correction term for absorption above suspended ceiling	[dB]
$C_{\text{doorpos.}}$	correction term to take into account the relative position of the doors in a hall	[dB]
C	spectrum adaptation term 1 according to EN ISO 717-1	[dB]
C_{tr}	spectrum adaptation term 2 according to EN ISO 717-1	[dB]
c_o	speed of sound in air (= 340 m/s)	[m/s]
D_{nT}	standardized sound level difference	[dB]
$D_{\text{n,e}}$	element normalized level difference of small building elements	[dB]
$D_{\text{n,s}}$	normalized sound level difference for indirect transmission through a system s	[dB]
$D_{\text{n,f}}$	flanking normalized level difference	[dB]
$D_{\text{n,c}}$	$D_{\text{n,f}}$ for a suspended ceiling	[dB]
$D_{\text{v,ij}}$	junction velocity level difference between excited element i and receiving element j	[dB]
$\overline{D_{\text{v,ij,situ}}}$	direction-averaged junction velocity level difference between elements i and j in the actual field situation	[dB]
d	depth of cavity of additional linings	[m]
E_1	Young's modulus of a flexible interlayer	[N/m ²]
f	frequency	[Hz]
f_c	critical frequency	[Hz]
$f_{c,\text{eff}}$	effective critical frequency, taking into account longitudinal and shear waves	[Hz]
f_{ref}	reference frequency (= 1 000 Hz)	[Hz]
f_1	characteristic frequency for the effect of flexible inter layers at junctions	[Hz]
f_p	plateau frequency for the sound reduction index	[Hz]
f_K	frequency to express the frequency dependence of the vibration reduction index (= 500 Hz)	[Hz]
f_o	mass-spring resonance frequency	[Hz]

"continued"

Symbols (continued)

Symbol	Physical quantity	Unit
G_1	Shear modulus of a flexible interlayer	[N/m ²]
h_{pl}	free height of the plenum above the ceiling	[m]
h_{lab}	laboratory value, as reference, for h_{pl} (= 0,7 m)	[m]
i, j	indices for an element ; for a transmission path ij , i indicates an element in the source room (= F,D) and j an element in the receiving room (= f, d)	[-]
k	index for a border of an element	[-]
k_o	wave number in air ($k_o = 2 \pi f / c_o$)	[rad/m]
K_{ij}	vibration reduction index for each transmission path ij over a junction	[dB]
$K_{ij,min}$	minimum value for K_{ij} in the actual field situation	[dB]
L_1	average sound pressure level in the source room	[dB re 20 μ Pa]
L_2	average sound pressure level in the receiving room	[dB re 20 μ Pa]
L_k	length of border k of a total floor plate between load-bearing walls	[m]
l_{ij}	common coupling length between element i and element j	[m]
l_f	common coupling length between flanking element f and separating element	[m]
l_{lab}	laboratory value, as reference, for l_{ij}	[m]
l_k	length of border k of an element	[m]
l_o	reference length (= 1 m)	[m]
m'	mass per unit area of an element	[kg/m ²]
m'_o	reference mass per unit area (= 1 kg/m ²)	[kg/m ²]
M	$\lg (m'_{\perp i} / m'_i)$	[-]
n	number of flanking elements in a room	[-]
R	sound reduction index of an element	[dB]
R_{situ}	sound reduction index of an element in the actual field situation	[dB]
R'	apparent sound reduction index	[dB]
R_{ij}	flanking sound reduction index	[dB]
R_s	sound reduction index of separating element	[dB]
R_i	sound reduction index for element i in source room	[dB]
$R_{i,situ}$	sound reduction index of element i in the actual field situation	[dB]
R_j	sound reduction index for element j in receiving room	[dB]
$R_{j,situ}$	sound reduction index of element j in the actual field situation	[dB]
ΔR_s	sound reduction index improvement by additional layers for separating element	[dB]
ΔR_D	sound reduction index improvement by additional layers for separating element in the source room	[dB]
ΔR_d	sound reduction index improvement by additional layers for separating element in the receiving room	[dB]

"continued"

Symbols (continued)

Symbol	Physical quantity	Unit
ΔR_i	sound reduction index improvement by additional layers for element i	[dB]
ΔR_j	sound reduction index improvement by additional layers for element j	[dB]
R_{hs}	sound reduction index of the wall between a hall and the source room	[dB]
R_{hr}	sound reduction index of the wall between the hall and the receiving room	[dB]
R_w	weighted sound reduction index according to EN ISO 717-1	[dB]
$R_{s,w}$	weighted sound reduction index of the separating element	[dB]
$R_{F,w}$	weighted sound reduction index of the flanking element F in the source room	[dB]
$R_{f,w}$	weighted sound reduction index of the flanking element f in the receiving room	[dB]
$\Delta R_{Dd,w}$	total weighted sound reduction index improvement by additional lining on the source and/or receiving side of the separating element	[dB]
$\Delta R_{Ff,w}$	total weighted sound reduction index improvement by additional lining on the source and/or receiving side of the flanking element	[dB]
$\Delta R_{Fd,w}$	total weighted sound reduction index improvement by additional lining on the flanking element at the source side and/or separating element at the receiving side	[dB]
$\Delta R_{Df,w}$	total weighted sound reduction index improvement by additional lining on the separating element at the source side and/or flanking element at the receiving side	[dB]
S_{rec}	area of the part of a floor, seen from the receiving room	[m ²]
S_{tot}	total area of a floor field between load bearing structural elements	[m ²]
S_{hs}, S_{hr}	area of the wall between the hall and the source room and receiving room, respectively	[m ²]
S_{cs}, S_{cr}	the area of the ceiling in the source room and receiving room, respectively	[m ²]
S_{lab}	laboratory value, as reference, for S_{cs} and S_{cr} (= 20 m ²)	[m ²]
S_s	area of separating element	[m ²]
S_i, S_j	area of an element in the source room (i) and receiving room (j), respectively	[m ²]
t	thickness of a structural element	[m]
t_a	thickness of an absorbing lining	[m]
t_l	thickness of a flexible interlayer	[m]
T	reverberation time in the receiving room	[s]
T_o	reference reverberation time ; for dwellings given as 0,5 s	[s]
T_s	structural reverberation time of a (homogeneous) element	[s]
$T_{s,lab}$	laboratory structural reverberation time for each (homogeneous) element	[s]
$T_{s,situ}$	structural reverberation time in the actual field situation	[s]
V	the volume of the receiving room	[m ³]
v_i^2	average square velocity over element i (free waves)	[(m/s) ²]
v_j^2	average square velocity over element j (free waves)	[(m/s) ²]
W_{tot}	total radiated sound power into receiving room	[W]

"continued"

Symbols (concluded)

Symbol	Physical quantity	Unit
W_{ij}	radiated sound power by element j due to incident sound on element i	[W]
W_1	sound power incident on a test specimen in the source room	[W]
W_2	sound power radiated from a test specimen into the receiving room due to incident sound on that specimen in the source room	[W]
w	index to indicate weighted sound reduction indices according to EN ISO 717-1	[-]
α_k	absorption coefficient for bending wave field at border k of an element	[-]
γ_{ij}	power transmission factor for bending wave field at a junction between element i and j	[-]
Δ_1	reduction of vibration reduction index by a flexible layer	[dB]
η_{tot}	total loss factor	[-]
$\eta_{tot,lab}$	total loss factor in the laboratory situation	[-]
η_{int}	internal loss factor	[-]
ρ	density	[kg/m ³]
ρ_o	density of air	[kg/m ³]
σ	radiation factor for free bending waves	[-]
σ_f	radiation factor for forced waves	[-]
τ	transmission factor (sound power ratio)	[-]
τ_{ij}	flanking transmission factor	[-]
τ'	sound power ratio of total radiated sound power in the receiving room relative to incident sound power on the common part of the separating element	[-]
τ_d	sound power ratio of radiated sound power by the common part of the separating element relative to incident sound power on the common part of the separating element. It includes the path Dd and paths Fd	[-]
τ_f	sound power ratio of radiated sound power by a flanking construction f in the receiving room relative to incident sound power on the common part of the separating element. It includes paths Ff and Df	[-]
τ_s	sound power ratio of radiated sound power in receiving room by indirect airborne transmission system s due to incident sound power on this transmission system, relative to incident sound power on the common part of the separating element	[-]
τ_e	sound power ratio of radiated sound power in the receiving room by an element in the separating element due to direct airborne sound transmission of incident sound on this element, relative to incident sound power on the common part of the separating element	[-]

Annex B (informative)

Sound reduction index for monolithic elements

B.1 Sound reduction index in frequency bands

For common monolithic structural elements the laboratory sound reduction, R , can be calculated accurately (see literature). In such cases the contribution of forced transmission can be neglected for flanking paths. The total loss factor as influenced by the laboratory is important and has to be taken into account in accordance with the specifications given in EN ISO 140-1 (see annex C).

The following equations can be used, based on [10] (see bibliography) :

$$R = -10 \lg \tau$$

$$\tau = \left(\frac{2\rho_0 c_0}{2\pi f m'} \right)^2 \frac{\pi f_c \sigma^2}{2f \eta_{\text{tot}}} \quad f > f_c$$

$$\tau = \left(\frac{2\rho_0 c_0}{2\pi f m'} \right)^2 \frac{\pi \sigma^2}{2\eta_{\text{tot}}} \quad f \approx f_c \quad (\text{B.1})$$

$$\tau = \left(\frac{2\rho_0 c_0}{2\pi f m'} \right)^2 \left(2\sigma_f + \frac{(l_1 + l_2)^2}{l_1^2 + l_2^2} \sqrt{\frac{f_c}{f}} \frac{\sigma^2}{\eta_{\text{tot}}} \right) \quad f < f_c$$

where

- τ is the transmission factor ;
- m' is the mass per unit area, in kilograms per square metre ;
- f is the frequency in Hertz ;
- f_c is the critical frequency ($= c_0^2 / (1,8 c_{L1})$), in Hertz ;
- η_{tot} is the total loss factor (for the laboratory situation see annex C) ;
- σ is the radiation factor for free bending waves ;
- σ_f is the radiation factor for forced transmission ;
- l_1, l_2 are the lengths of the borders of the (rectangular) element, in metres.

The total loss factor for the laboratory situation is calculated according to annex C.

The radiation factor for forced waves is based on [16] (see bibliography), and with l_1 greater than l_2 calculated from :

$$\sigma_f = 0,5 \left[\ln(k_o \sqrt{l_1 l_2}) - \Lambda \right]; \sigma_f \leq 2 \quad (\text{B.2})$$

$$\Lambda = -0,964 - \left(0,5 + \frac{l_2}{\pi l_1}\right) \ln \frac{l_2}{l_1} + \frac{5 l_2}{2 \pi l_1} - \frac{1}{4 \pi l_1 l_2 k_o^2}$$

where

k_o is the wave number, in radian per metre ; $k_o = 2 \pi f / c_o$.

The radiation factor for free waves is based on [13] (see bibliography) and calculated from :

$$\sigma_1 = \frac{1}{\sqrt{1 - f_c / f}} \quad \sigma_2 = 4 l_1 l_2 \left(\frac{f}{c_o}\right)^2 \quad \sigma_3 = \sqrt{\frac{2 \pi f (l_1 + l_2)}{16 c_o}} \quad (\text{B.3a})$$

$$f_{11} = \frac{c_o^2}{4 f_c} \left(\frac{1}{l_1^2} + \frac{1}{l_2^2} \right)$$

if $f_{11} \leq f_c / 2$ then :

$$f \geq f_c : \sigma = \sigma_1$$

$$f < f_c : \sigma = \frac{2(l_1 + l_2)}{l_1 l_2} \frac{c_o}{f_c} \delta_1 + \delta_2$$

$$\delta_1 = \left(\frac{\left((1 - \lambda^2) \ln \frac{1 + \lambda}{1 - \lambda} + 2 \lambda \right)}{4 \pi^2 (1 - \lambda^2)^{1,5}} \right) \text{ with } \lambda = \sqrt{\frac{f}{f_c}} \quad (\text{B.3.b})$$

$$f > f_c / 2 : \quad \delta_2 = 0 \text{ else } \quad \delta_2 = \frac{8 c_o^2 (1 - 2 \lambda^2)}{f_c^2 \pi^4 l_1 l_2 \lambda \sqrt{1 - \lambda^2}}$$

$$f < f_{11} < f_c / 2 \text{ and } \sigma > \sigma_2 : \sigma = \sigma_2$$

$$\sigma \leq 2,0$$

If $f_{11} > f_c / 2$ then :

$$f < f_c \text{ and } \sigma_2 < \sigma_3 : \sigma = \sigma_2$$

$$f > f_c \text{ and } \sigma_1 < \sigma_3 : \sigma = \sigma_1 \quad (\text{B.3 c})$$

$$\text{else : } \quad \sigma = \sigma_3$$

$$\sigma \leq 2,0$$

These equations are valid for a plate surrounded by an infinite baffle, often relevant for the laboratory situation. However, in buildings a structural element is often surrounded by orthogonal elements which will increase the radiation efficiency well below the critical frequency by a factor of 2 (edge modes) to 4 (corner modes).

For the radiation factors alternative equations are available from more recent literature (see bibliography [18]).

Above the critical frequency this frequency is replaced in the calculation by an effective critical frequency, to take into account other wave types relevant for thick walls and/or higher frequencies (see bibliography [5], [12]), according to :

$$f_{c,\text{eff}} = f_c \left(4,05 \frac{tf}{c_L} + \sqrt{1 + \left(4,05 \frac{tf}{c_L} \right)^2} \right) \quad f < f_p$$

$$f_{c,\text{eff}} = 2f_c \left(\frac{f}{f_p} \right)^3 \quad \text{with } f_p = \frac{c_L}{5,5t} \quad f \geq f_p \quad (\text{B.4})$$

where

t is the thickness of the element, in metres ;

c_L is the longitudinal velocity of the material, in metres per second.

Based on calculations according to this model, some examples of the sound reduction index in octave bands for monolithic elements are given in table B.2 for a laboratory situation in accordance with annex C. The calculations are performed at single frequencies at one-third octave distance and the results averaged over a band-width of one octave in order to assure a smooth transmission between the three frequency ranges of equation (B.1). The material properties are given in Table B.1, together with the generic material names for which they are indicative.

Table B.1 — Typical material properties

Material	Density ρ (kg/m ³)	Longitudinal Velocity c_L (m/s)	Internal loss factor η_{int} (-)
Concrete	2 300	3 500	0,006
Calcium-silicate	1 750	2 600	0,015
Lightweight concrete	1 300	1 700	0,015
Autoclaved aerated concrete	650	1 400	0,010

Tableau B.2 — Calculated sound reduction index in octave bands for some monolithic structures (examples)

Construction	Mass kg/m ²	Sound reduction index (dB) in octave bands (Hz)							$R_w (C ; C_{tr})$
		63	125	250	500	1 k	2 k	4 k	
120 mm concrete	276	35	34	36	46	54	62	69	49 (-2 ; -6)
260 mm concrete	598	43	42	51	59	67	74	75	61 (-1 ; -7)
110 mm Ca-Si blocks	193	34	34	33	39	49	58	65	44 (-1 ; -4)
240 mm Ca-Si blocks	420	38	38	46	54	62	68	68	56 (-1 ; -6)
120 mm lightweight conc.	156	33	36	34	35	44	53	56	42 (-1 ; -3)
300 mm lightweight conc.	390	37	37	42	51	58	58	58	54 (-2 ; -6)
100 mm autocl.aer. conc.	65	26	30	31	27	32	41	45	32 (0 ; -1)
200 mm autocl.aer. conc.	130	30	30	29	34	43	46	46	39 (-1 ; -3)

B.2 Weighted sound reduction index

Based on calculations according to the model given in Figure B.1 information is given on the weighted sound reduction index R_w for monolithic structural elements in Figure B.1, as function of the mass per unit area for some common materials (see Table B.2). The single number ratings are calculated from the octave band values according to EN ISO 717-1.

These data can be used to provide a reasonably safe estimate, in cases where no measured data are available. It is applicable to homogeneous single-leaf elements constructed from clay bricks, concrete, calcium-silicate blocks, gypsum blocks, autoclaved aerated concrete and various types of lightweight concrete. Mortar and firmly attached plaster can be included in the determination of the surface mass. Structural elements with holes cannot be considered as homogeneous, unless the dimensions of the holes are small and the volume of holes is less than 15 % of the gross volume.

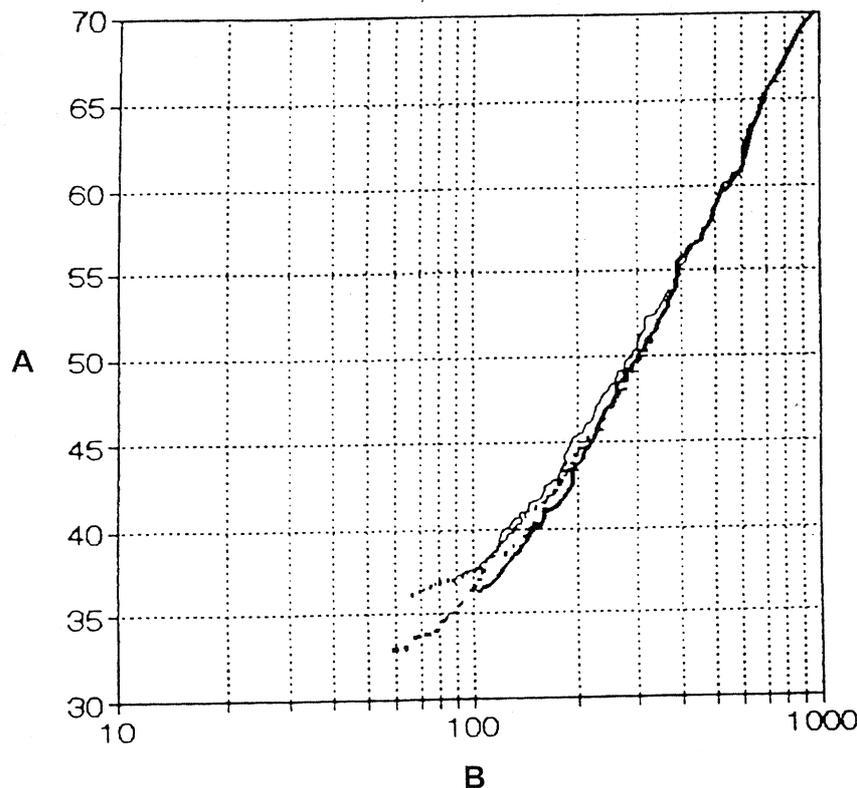

Legend

- A Weighted sound reduction index R_w (dB)
 B Surface mass m' (kg/m^2)
 1 — Concrete
 2 — Calcium – Silicate
 3 Lightweight concrete
 4 ---- Autoclaved aerated concrete

For $m' > 150 \text{ kg}/\text{m}^2$ the data in the figure can as a safe average be represented by :

$$R_w = 37,5 \lg(m'/m'_0) - 42 \text{ dB} \quad (\text{B.5})$$

For the corresponding spectrum adaptation terms the following holds :

C is about constant : -1 till -2 dB for the higher masses,

$$C_{tr} = 16 - 9 \lg(m'/m'_0) \text{ dB, limited by } -7 \leq C_{tr} \leq -1 \text{ dB.} \quad (\text{B.6})$$

Figure B.1 —Weighted sound reduction index for some common monolithic structural elements according to Table B.2

A comparison with measurement results gathered in different laboratories over the last thirty years show that the measured results lie in a range around the given lines from - 4 dB till + 8 dB. This relatively large spread is due to several factors, some related to specific product properties but some to the laboratory facilities and measurement methods applied. It is to be expected that measurement results according to the new version of EN ISO 140 will show about half this spread. These facts are reflected in the different empirical 'mass-law' relations which have been and are being used within Europe, examples of which are given in Figure B.2.

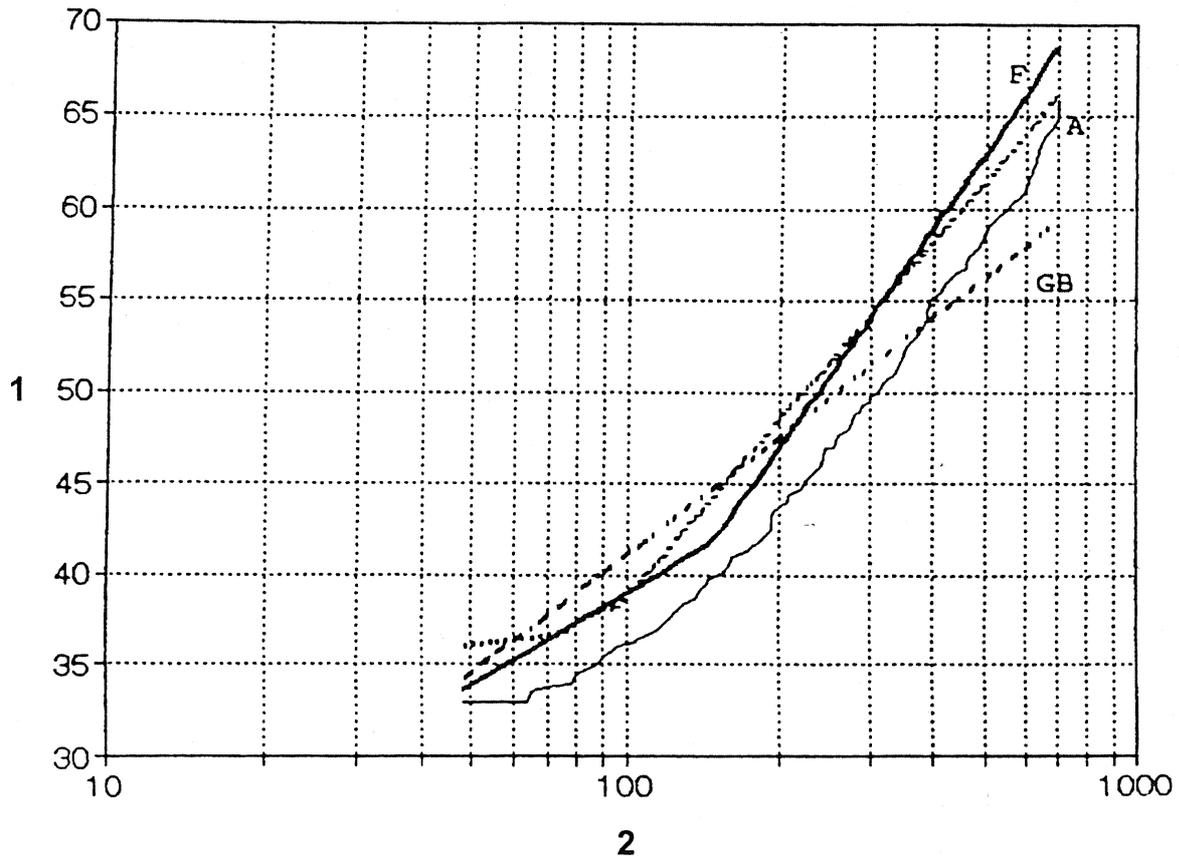

Legend

- 1 Weighted sound reduction index R_w (dB)
- 2 Surface mass m' (kg/m^2)

The data in this figure can be represented by the following expressions :

$$\begin{aligned}
 \text{A,} \quad & m' \geq 100 \text{ kg}/\text{m}^2 : R_w = 32,4 \lg(m'/m'_o) - 26,0 \text{ dB} \\
 \text{F,} \quad & m' \geq 150 \text{ kg}/\text{m}^2 : R_w = 40,0 \lg(m'/m'_o) - 45,0 ; C = -1 \text{ dB} \\
 \text{GB} \quad & m' \geq 50 \text{ kg}/\text{m}^2 : R_w = 21,65 \lg(m'/m'_o) - 2,3 \pm 1 \text{ dB}
 \end{aligned}
 \tag{B.7}$$

Figure B.2 — Existing empirical relations for the weighted sound reduction index of homogeneous structural elements (A, F, GB) ; the minimum values from Figure B.1 are given for comparison

Annex C (informative)

Structural reverberation time

The reverberation time of a structural element T_s can be evaluated from the total loss factor, which follows from the internal losses, the losses due to radiation and the losses at the perimeter of the element :

$$T_s = \frac{2,2}{f \eta_{\text{tot}}}$$

$$\eta_{\text{tot}} = \eta_{\text{int}} + \frac{2 \rho_o c_o \sigma}{2 \pi f m'} + \frac{c_o}{\pi^2 S \sqrt{f f_c}} \sum_{k=1}^4 l_k \alpha_k \quad (\text{C.1})$$

where

- η_{tot} is the total loss factor ;
- f is the centre band frequency, in Hertz ;
- η_{int} is the internal loss factor of the material ;
- m' is the mass per unit area, in kilograms per square metre ;
- σ is the radiation factor for free bending waves ;
- f_c is the critical frequency ($= c_o^2 / (1,8 c_L t)$), in Hertz ;
- S is the area of the element, in square metres ;
- α_k is the absorption coefficient for bending waves at the perimeter k ;
- l_k is the length of the junction at the perimeter k, in metre ;
- c_o is the speed of sound in air, in metres per second ; $c_o = 340$ m/s ;
- ρ_o is the density of air, in kilogram per cubic metres.

For calculations in one-third octave bands the frequency can be taken as the centre frequency of the band considered. For calculations in octave bands the best estimate is obtained by using the centre frequency of the lower one-third octave band within the octave band considered.

The internal loss factor for common homogeneous building materials is roughly 0,01. The radiation losses can normally be neglected. The absorption coefficients depend on the situation and the structural elements connected at the perimeter.

Field situation

The absorption coefficient at a perimeter will vary between 0,05 and 0,5 in field situations.

This absorption coefficient α_k for a structure i can be deduced from the vibration reduction index (K_{ij}) at the junction between the considered element i and the element j connected to it.

$$\alpha_k = \sum_{j=1}^3 \sqrt{\frac{f_{c,j}}{f_{ref}}} 10^{-K_{ij}/10} \tag{C.2}$$

where

f_c is the critical frequency, in Hertz ;

f_{ref} is the reference frequency, in Hertz ; $f_{ref} = 1\ 000$ Hz ;

j indicates the elements which are connected to the considered element i at border k .

If the area considered is part of a larger structural element and the junctions are formed by light elements, the actual structural reverberation time can be influenced or dominated by the behaviour of the larger structural element as a whole due to the back flow of vibrational energy.

This effect can be incorporated by maximizing the sum-term in equation (C.1) for a sub-area S of a large structural element to :

$$\sum_{k=1}^4 l_k \alpha_k \leq \sum_{k=1}^4 L_k \alpha_k \tag{C.3}$$

where

L_k is the length of junction k of the total floor slab, in metres ;

α_k is the absorption coefficient of junction k of the total floor slab.

By this approach an effective structural reverberation time is calculated which is not the actual structural reverberation time, but yields the correct results for the in-situ sound reduction index. The actual structural reverberation time is larger by a factor S_{tot}/S .

Laboratory situation

For measurements in the laboratory in accordance with EN ISO 140-3 the average absorption coefficient, as specified in EN ISO 140-1, is about 0,15 for heavy constructions (around 400 kg/m²). This can be represented by a heavy frame of 600 mm concrete around the test opening. For that situation α_k can be calculated according to :

$$\alpha_k = \alpha (1 - 0,9999 \alpha)$$

$$\alpha = \frac{1}{3} \left[\frac{2 \sqrt{\chi \psi} (1 + \chi) (1 + \psi)}{\chi (1 + \psi)^2 + 2\psi (1 + \chi^2)} \right]^2 \tag{C.4}$$

$$\chi = \sqrt{\frac{31,1}{f_c}} \quad \psi = 44,3 \frac{f_c}{m'}$$

This is based on a one dimensional theory (see bibliography [2]), empirically adjusted for diffuse fields. Based on this the total loss factor for the laboratory situation can be estimated as :

$$\eta_{\text{tot,lab}} \approx \eta_{\text{int}} + \frac{m'}{485\sqrt{f}} \quad (\text{C.5})$$

This equation holds for structural elements with a surface mass below $m' = 800 \text{ kg/m}^2$; η_{int} can normally be taken as 0,01.

NOTE For a specific laboratory the values can be calculated as for the field situation, making use of the appropriate values for the vibration reduction index at the borders of the test opening.

Annex D (informative)

Sound reduction index improvement of additional layers

D.1 Sound reduction index improvement of layers

The improvement in sound reduction by a layer, such as a resiliently mounted wall lining, floating floor or suspended ceiling, is in principle different for flanking transmission and direct transmission and depends additionally on the type of basic structural elements it is applied to. It should therefore be determined by measurements in a laboratory, both for direct and flanking transmission, with the same basic structural element as is applied in the field situation considered.

For the time being there is no standardized measurement method available, nor accurate possibilities to derive the effect for flanking transmission from the one for direct transmission or to correct results for changes in the basic structural element. Some information is given in this annex for a realistic and practical approach.

D.1.1 Direct transmission, ΔR

- Determine the improvement by a layer as the difference in sound reduction index, measured in accordance with EN ISO 140-3, between a basic structural element with the lining and the basic element alone. To get at least comparable results, use as a standardized basic structural element a homogeneous, plastered element with a mass of $(250 \pm 50) \text{ kg/m}^2$. Care should be taken that the sound reduction index for the basic element alone is not affected by any indirect airborne transmission through leaks in the element and around the perimeter. Other basic structural elements can be used in addition ;
- Apply the laboratory results for the standardized basic structural element in the calculations for direct transmission, unless results for a more appropriate basic element are available.

NOTE The improvement decreases generally with an increase in the surface mass of the basic structural element, mainly due to direct or indirect (at the perimeter) coupling between the layer and the basic structural element. The result for the standardized basic structural element will therefore be correct or on the safe side for structural elements with a surface mass not much larger than that of the standardized basic structural element.

The results can be expressed in a single number rating ΔR_w by applying EN ISO 717-1 to the results for the basic structural element with and without the tested lining and taking the difference.

Some typical examples of the improvement by additional layers are given in Table D.1.

D.1.2 Flanking transmission

- The improvement can be determined by measurements in the field or special laboratory facilities, where it can be assured that transmission occurs only by a flanking path (i.e. path Ff). This can be realized by special constructions and/or by applying very efficient wall linings and floor coverings to prevent all other transmission paths. The sound reduction index improvement is obtained from the measurement of the sound transmission with and without the lining to be tested, applied to one of the structural elements involved in the flanking transmission path considered. To get results at least comparable as with direct transmission, it is recommended to use as the basic structural element a homogeneous, plastered element with a mass of $(250 \pm 50) \text{ kg/m}^2$. Care should be taken that the sound reduction index for the basic structural element alone is not affected by any indirect airborne transmission through leaks in the element and around the perimeter. Other basic structural elements can be used in addition ;

- Apply the results for the standardized basic structural element in the calculations for flanking transmission, unless results for a more appropriate basic element are available ;
- As a reasonable estimate the sound reduction index improvement for flanking transmission can be taken as equal to the improvement for direct transmission ;

NOTE The improvement for flanking transmission can deviate from that for direct transmission. At low frequencies, that is below the critical frequency of the lining and below the frequency where coupling effects occur, this is due to the different excitation involved, while at higher frequencies this is mainly caused by the effect of leakages in the basic structural element for the measurements without linings.

The results can be expressed in a single number rating ΔR_w by applying EN ISO 717-1 to the results for the basic structural element with and without the tested lining and taking the difference.

Some typical examples of the sound reduction index improvement for flanking transmission by additional layers to a flanking wall are given in Table D.2.

Table D.1 - Sound reduction index improvement ΔR of additional layers (examples)

Construction additional layer	ΔR [dB] in octave bands [Hz]						ΔR_w [dB]
	63	125	250	500	1 k	2 k	
Basic wall 100 mm gypsum blocks, 80 kg/m² :							
12,5 mm plaster board ; 44 mm cavity with 25 mm mineral wool ; no studs	0	2	14	23	24	19	18
12,5 mm plaster board ; 73 mm cavity with 50 mm mineral wool ; wooden studs	2	8	15	23	25	21	21
12,5 mm plaster board ; 60 mm cavity with 50 mm mineral wool ; metal studs, isolated from wall	2	8	15	24	25	20	21
Basic wall 175 mm plastered porous concrete, 135 kg/m² :							
12,5 mm plaster board ; 40 mm mineral wool ; metal studs ^{*)}	3	12	14	15	17	15	15
35 mm porous concrete ; 50 mm mineral wool ; no studs ^{*)}	3	11	14	16	14	13	14
Basic wall 100 mm Calcium-Silicate blocks, 180 kg/m² :							
2 mm × 12,5 mm gypsum board ; 20 mm foam ; no studs	2	5	19	30	41	42	23
Basic wall 300 mm plastered hollow blocks, 240 kg/m² :							
15 mm cement plaster ; 30 mm mineral wool ; no studs ^{*)}	0	- 4	5	9	11	15	7
15 mm cement plaster ; 50 mm mineral wool ; no studs ^{*)}	0	- 5	5	8	10	14	6
*) Same construction as in Table D.2.							

Table D.2 - Sound reduction index improvement ΔR for flanking transmission of additional layers on a flanking wall (examples) ; same constructions as indicated in Table D.1 with^(*)

Construction additional layer	ΔR [dB] in octave bands [Hz]						ΔR_w [dB]
	63	125	250	500	1 k	2 k	
Basic wall 175 mm plastered porous concrete, 135 kg/m² :							
12,5 mm plaster board ; 40 mm mineral wool ; metal studs	0	6	12	14	14	14	13
35 mm porous concrete ; 50 mm mineral wool ; no studs	0	5	8	13	11	13	12
Basic wall 300 mm plastered hollow blocks, 240 kg/m² :							
15 mm cement plaster ; 30 mm mineral wool ; no studs	0	- 3	5	10	12	13	6
15 mm cement plaster ; 50 mm mineral wool ; no studs	0	- 3	6	10	12	15	5

D.2 Weighted sound reduction index improvement of layers

If additional layers (wall linings, floating floors or suspended ceilings) are fixed to a homogeneous basic structural element (separating element or flanking element) the airborne sound insulation can be improved or reduced depending on the resonance frequency f_o of the system.

For elements where the insulation layer is fixed directly to the basic construction (without studs or battens) the resonance frequency f_o is calculated by :

$$f_o = 160 \sqrt{s' \left(\frac{1}{m'_1} + \frac{1}{m'_2} \right)} \tag{D.1}$$

where

s' is the dynamic stiffness of the insulation layer according to EN 29052-1 "Acoustics – Determination of dynamic stiffness – Part 1 : Materials used under floating floors in dwellings", in Meganewtons per cubic metre ;

m'_1 is the mass per unit area of the basic structural element, in kilograms per square metre ;

m'_2 is the mass per unit area of the additional layer, in kilograms per square metre.

For additional layers built with metal or wooden studs or battens not directly connected to the basic structural element, where the cavity is filled with a porous insulation layer with an air resistivity $r \geq 5$ kPa s/m² according to EN 29053 "Acoustics – Materials for acoustical applications – Determination of airflow resistance", the resonance frequency f_o is calculated by :

$$f_o = 160 \sqrt{\frac{0,111}{d} \left(\frac{1}{m'_1} + \frac{1}{m'_2} \right)} \tag{D.2}$$

where

d is the depth of the cavity, in metres.

For basic structural elements with a weighted sound reduction index in the range of $20 \text{ dB} \leq R_w \leq 60 \text{ dB}$, the resulting weighted sound reduction index improvement as a result of an additional layer can be estimated from the resonance frequency f_0 (rounded to the nearest integer value), according to table D.3. For resonance frequencies lower than 200 Hz the value also depends upon the weighted sound reduction index of the basic structural element ; this is illustrated in figure D.1.

Table D.3 - Weighted sound reduction index improvement by a lining, depending on the resonance frequency

Resonance frequency f_0 of the lining in Hz	ΔR_w in dB
≤ 80	$35 - R_w/2$
100	$32 - R_w/2$
125	$30 - R_w/2$
160	$28 - R_w/2$
200	- 1
250	- 3
315	- 5
400	- 7
500	- 9
630 – 1 600	- 10
> 1 600	- 5

NOTE 1 For resonance frequencies below 200 Hz, the minimum value of ΔR_w is 0 dB.

NOTE 2 Values for intermediate resonance frequencies can be deduced by linear interpolation over the logarithm of the frequency.

NOTE 3 R_w denotes the weighted sound reduction index of the bare wall or floor in dB.

Legend

- A Weighted sound reduction index improvement ΔR_w (dB)
 B Weighted sound reduction index of the bare wall or floor (dB)

Figure D.1 - Weighted sound reduction index improvement by an additional layer with resonance frequency below 200 Hz, as function of R_w for the bare structural element

Annex E (informative)

Vibration reduction index for junctions

E.1 Determination methods

The vibration reduction index K_{ij} at junctions is defined by equation (10) in relation to the velocity level difference over a junction in both directions, taking into account, where relevant, the structural reverberation time of the elements involved.

It can therefore be deduced from measurements of the vibration level difference $D_{v,ij}$ and $D_{v,ji}$ over a junction. In general this relates to the not excited side of structural element i ('outside') and the radiating side of structural element j ('inside'); for substantially homogeneous constructions the side of the construction is irrelevant, but not so for double leaf constructions.

In principle the structural reverberation time is to be determined for both elements involved. However, for lightweight, double elements like timber frame or metal-stud walls, timber floor constructions and other elements with a high internal loss factor (greater than 0,03), the structural reverberation time need not be measured and the equivalent absorption length should be taken numerically equal to the area of the element.

NOTE A standardized measurement method to determine this quantity will be given in document prEN ISO 10848-1. It is probably feasible to apply the standardized measurement method also in field situations to deduce this quantity to characterise a junction.

For homogeneous elements the vibration reduction index can be expressed in the structure-borne power transmission factor γ_{ij} for the transmission over the junction of elements i and j :

$$K_{ij} = -10 \lg \gamma_{ij} + 5 \lg \frac{f_{c,j}}{f_{ref}} = -10 \lg \gamma_{ji} + 5 \lg \frac{f_{c,i}}{f_{ref}} \quad \text{dB} \quad (\text{E.1})$$

where

f_c is the critical frequency, in Hertz ;

f_{ref} is reference frequency, in Hertz ; $f_{ref} = 1\,000$ Hz.

For these types of elements the vibration reduction index could also be deduced from measured or calculated values of the power transmission factor.

E.2 Empirical data

For common types of junctions data on K_{ij} are given in this annex, depending on the mass per unit area of the elements connected at the junction, denoted as m_1 and m_2 . Data are only available for junctions where the elements at either side of the junction in the same plane have the same mass. The relations for K_{ij} are given as function of the quantity M defined as :

$$M = \lg \frac{m'_{\perp i}}{m'_i} \quad (\text{E.2})$$

where

m'_i is the mass per unit area of the element i in the transmission path ij , in kilograms per square metre ;

$m'_{\perp i}$ is the mass per unit area of the other, perpendicular, element making up the junction, in kilograms per square metre.

NOTE 1 The choice of the mass ratio for M is actually arbitrary for transmission around the corner; since the vibration reduction index is the reciprocal of the result for transmission around the corner is the same for $M = \lg m_1/m_2$ or $M = \lg m_2/m_1$.

These data are deduced from generalized data on the junction velocity level differences as available from literature. The other terms in equation (10) are estimated on the basis that the vibration reduction index should be such that for all structural elements and field situations the estimated junction velocity level difference should on average be correct. This resulted generally in values for K_{ij} which are 5 dB lower than the corresponding direction-averaged junction velocity level difference. If other relevant data are available on the junction velocity level difference, the same approach could be used to deduce values for the vibration reduction index K_{ij} for application of the model.

For the time being there are insufficient data available to deduce values directly according to the given relation (10).

The transmission is in general only slightly dependent on frequency, at least in the frequency range from 125 Hz to 2 000 Hz. Where possible an indication is given of the frequency dependency in this range ; the frequency to be applied is the centre frequency of the one-third octave band or octave band considered. Outside this range the frequency effect can be larger, especially with lightweight constructions.

It is indicated in which cases the equivalent absorption length of the structural elements should be taken as numerically equal to area of these elements.

For flexible interlayers the improvement by the interlayer over the rigid junction is characterized by a frequency f_1 , which depends on the shear modulus G and thickness t_1 of the interlayer and the density, ρ_1 and ρ_2 , of the elements connected. This frequency varies as $(G/t_1 \sqrt{\rho_1 \rho_2})^{1,5}$. The given estimate in (E.5) is a global estimate for some typical junctions, characterised by E_1/t_1 of about 100 MN/m³, where E_1 is the modulus of elasticity ($G_1 \approx 0,3 E_1$) and t_1 the thickness of the layer.

NOTE 2 Work is in progress which could make it possible to improve these relations, making them more generally applicable for various kinds of inter layers.

The measured data show a typical spread around the given lines of ± 3 dB, increasing to ± 5 dB for junctions with lightweight elements ; in some cases the deviation can be much larger due to variations in junction details and in workmanship.

E.3 Limiting values

If a flanking element has insignificant or no structural contacts with the separating element only K_{Ff} is relevant ; K_{Fd} and K_{Df} can be given high values in order to make those transmission paths negligible. In the case of a homogeneous flanking element the minimum value for the vibration reduction index is $K_{Ff} = 5 \lg f_c - 15,0$ dB ; with double leaf lightweight elements $K_{Ff} \approx 0$ dB is a reasonable minimum value in these cases. As a lower limit the value of K_{ij} chosen should result in $\overline{D_{v,ij,situ}} = 0$ dB.

Rigid cross-junction

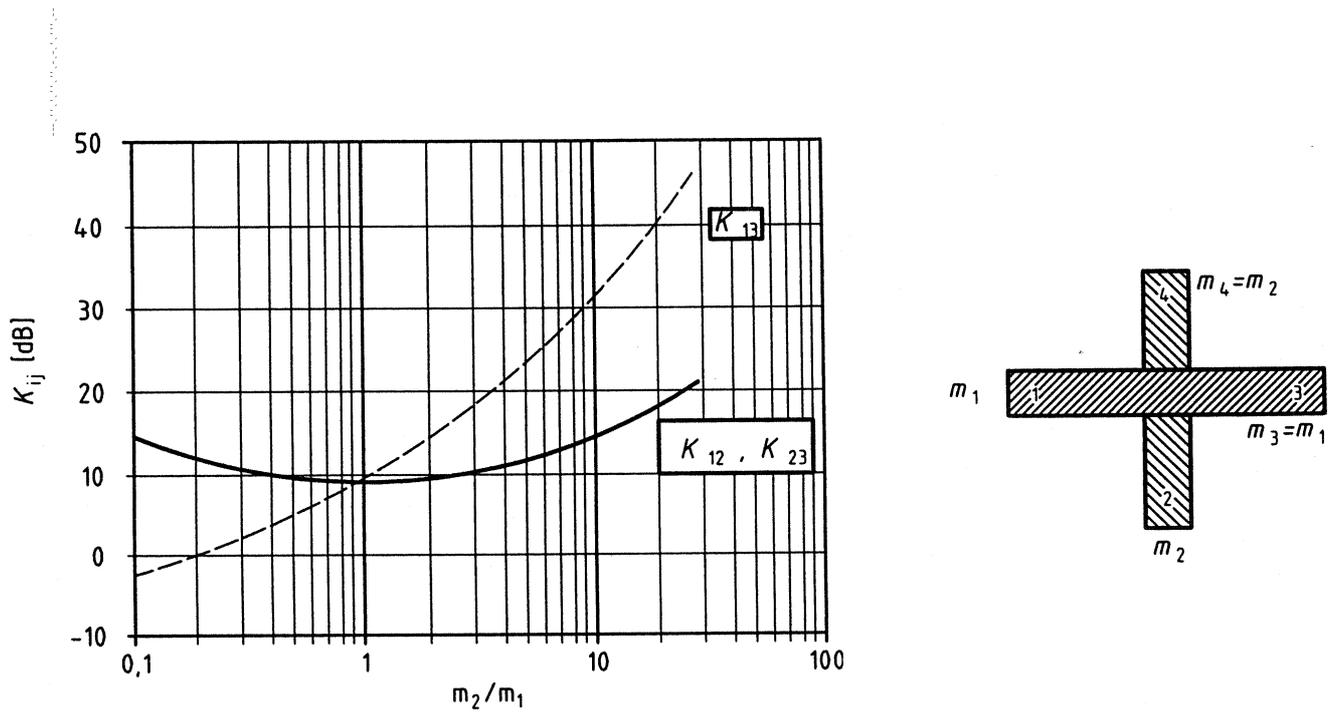

$$K_{13} = 8,7 + 17,1 M + 5,7 M^2 \text{ dB ; } 0 \text{ dB / octave}$$

$$K_{12} = 8,7 + 5,7 M^2 (= K_{23}) \text{ dB ; } 0 \text{ dB / octave}$$

(E.3)

Figure E.1

Examples

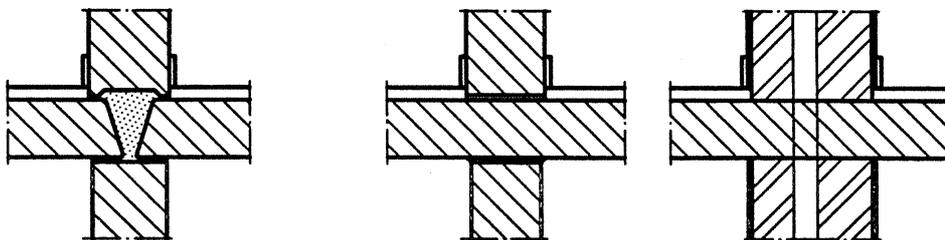
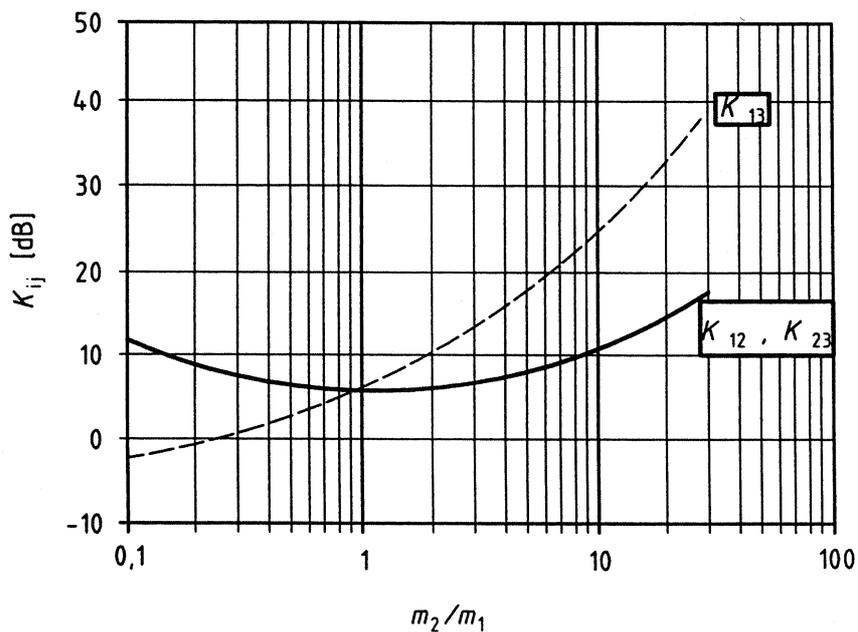

Figure E.2

Rigid T-junction



$$K_{13} = 5,7 + 14,1 M + 5,7M^2 \text{ dB ; } 0 \text{ dB / octave}$$

$$K_{12} = 5,7 + 5,7 M^2 (= K_{23}) \text{ dB ; } 0 \text{ dB / octave}$$

(E.4)

Figure E.3

Examples

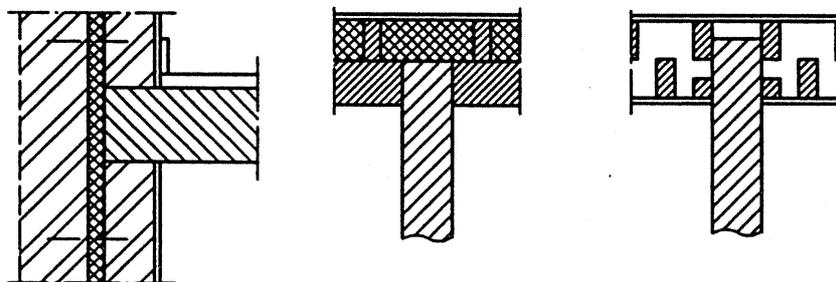
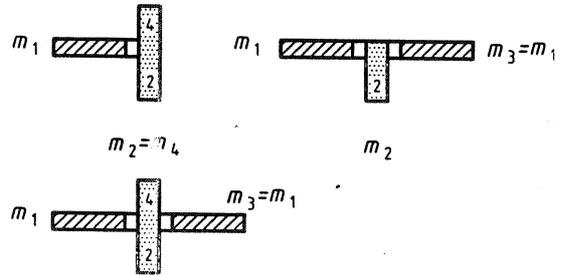
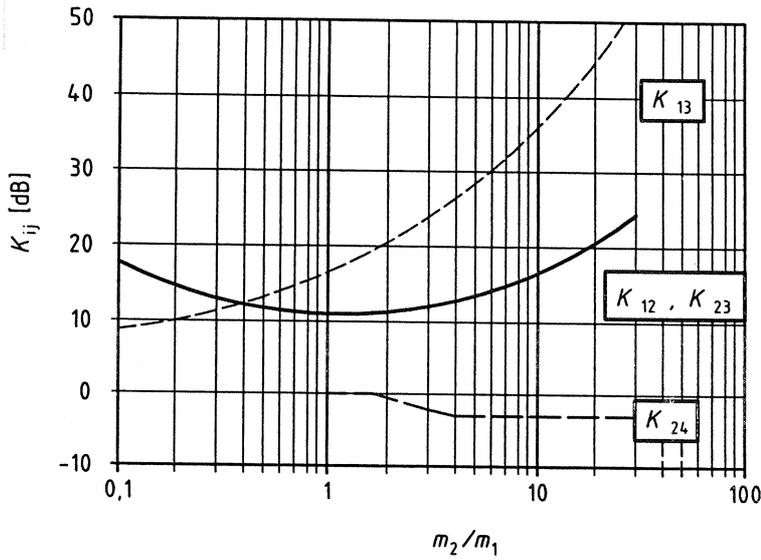

Figure E.4

Wall junction with flexible interlayers



$$K_{13} = 5,7 + 14,1M + 5,7M^2 + 2 \Delta_1 \text{ dB}$$

$$K_{24} = 3,7 + 14,1M + 5,7M^2 \text{ dB}; 0 \leq K_{24} \leq -4 \text{ dB}; 0 \text{ dB / octave}$$

$$K_{12} = 5,7 + 5,7M^2 + \Delta_1 \text{ dB} \quad (= K_{23})$$

(E.5)

$$\Delta_1 = 10 \lg \frac{f}{f_1} \text{ dB for } f > f_1$$

$$f_1 = 125 \text{ Hz if } \frac{E_1}{t_1} \approx 100 \text{ MN/m}^3; \text{ see text}$$

Figure E.5

Examples

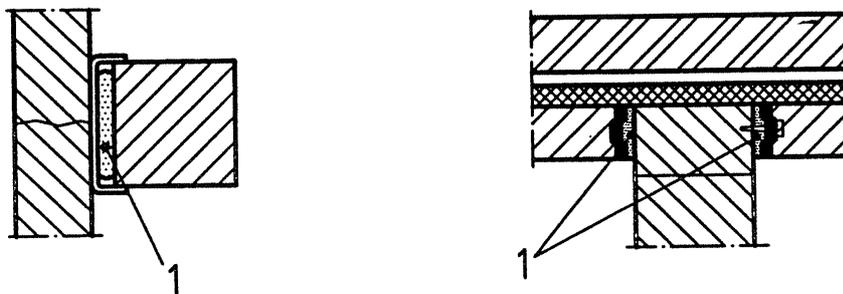

Legend

1 Elastic

Figure E.6

Lightweight façade junction

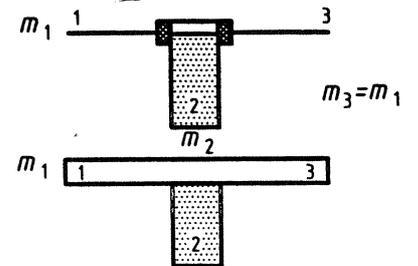
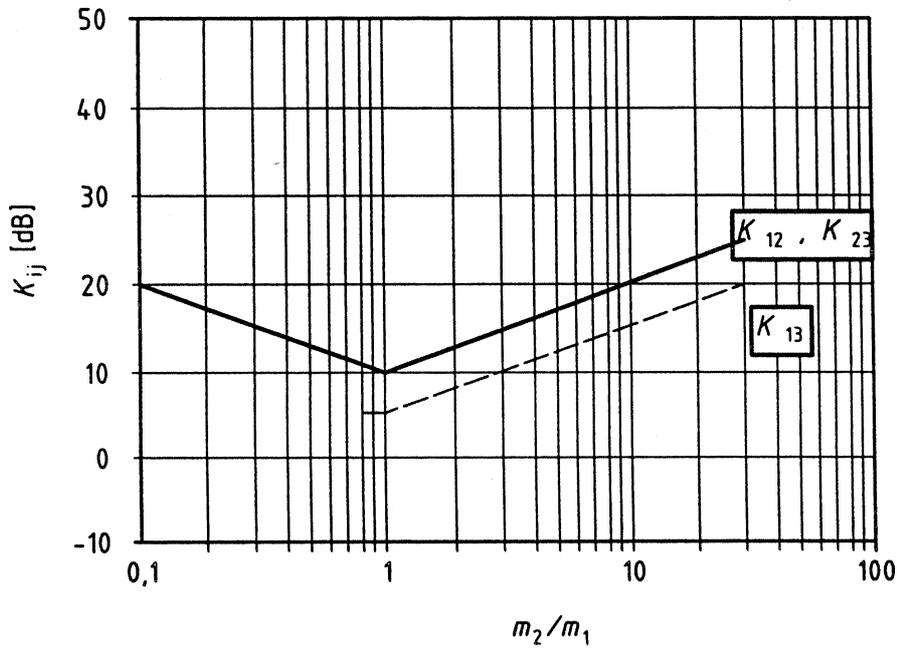

$K_{13} = 5 + 10 M$ dB and minimum 5 dB ; 0 dB / octave

$K_{12} = 10 + 10 |M| (= K_{23})$ dB ; 0 dB / octave (E.6)

$a_{\text{facade,situ}} = S_{\text{facade}} / I_0$

Figure E.7

Examples

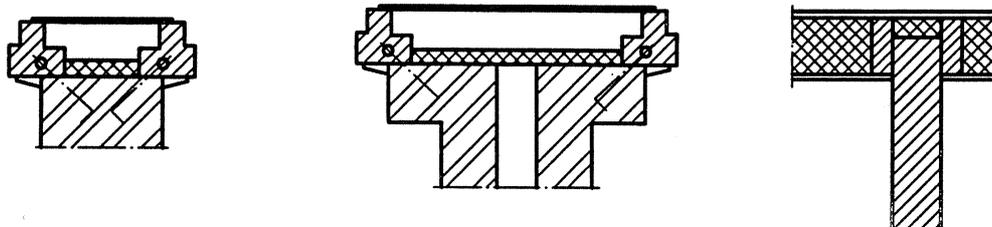
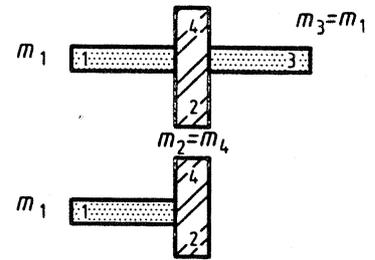
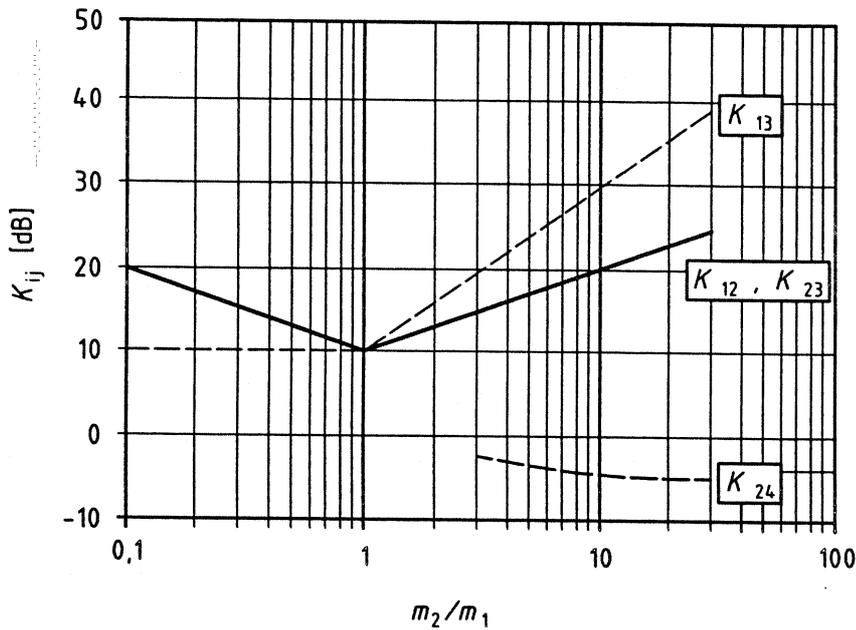

Figure E.8

Junction of lightweight double leaf wall and homogeneous elements



$$K_{13} = 10 + 20 M - 3,3 \lg \frac{f}{f_k} \text{ dB and minimum 10 dB}$$

$$K_{24} = 3,0 - 14,1 M + 5,7 M^2 \text{ dB ; } \frac{m_2}{m_1} > 3 ; 0 \text{ dB / octave} \tag{E.7}$$

$$K_{12} = 10 + 10 |M| + 3,3 \lg \frac{f}{f_k} \text{ dB (= } K_{23} \text{)}$$

$$f_k = 500 \text{ Hz } \quad a_{\text{lightweight wall, situ}} = S_{\text{lightweight wall}} / l_0$$

Figure E.9

Examples

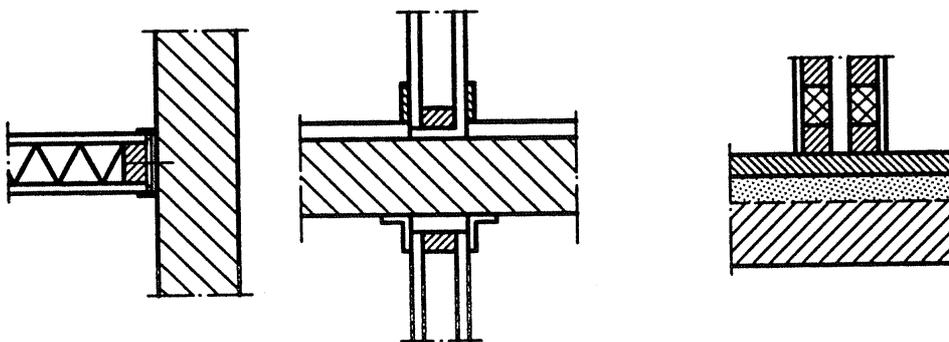
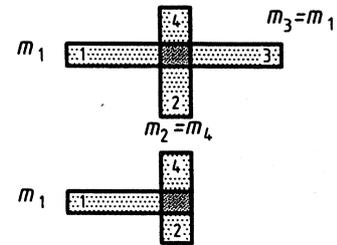
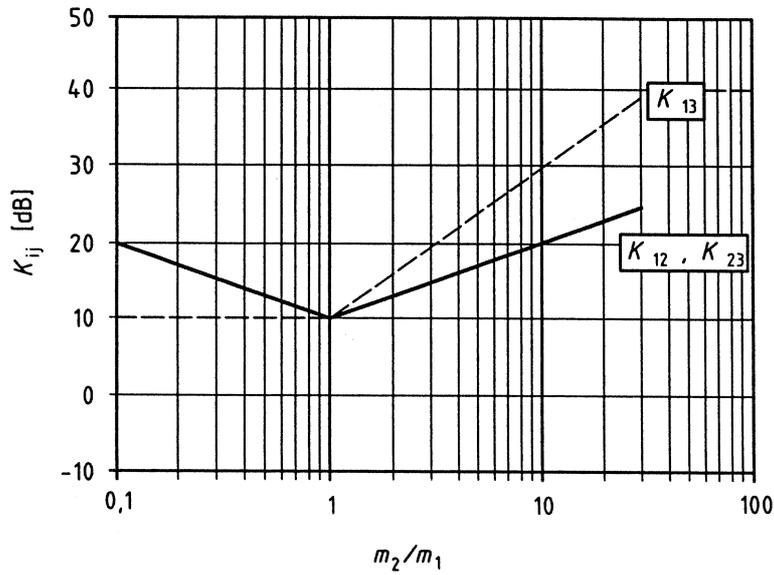

Figure E.10

Junction of lightweight coupled double leaf walls



$$K_{13} = 10 + 20 M - 3,3 \lg \frac{f}{f_k} \text{ dB and minimum 10 dB}$$

$$K_{12} = 10 + 10 |M| - 3,3 \lg \frac{f}{f_k} \text{ dB } (= K_{23})$$

(E.8)

$$f_k = 500 \text{ Hz } a_{\text{situ}} = S/l_0$$

Figure E.11

Examples

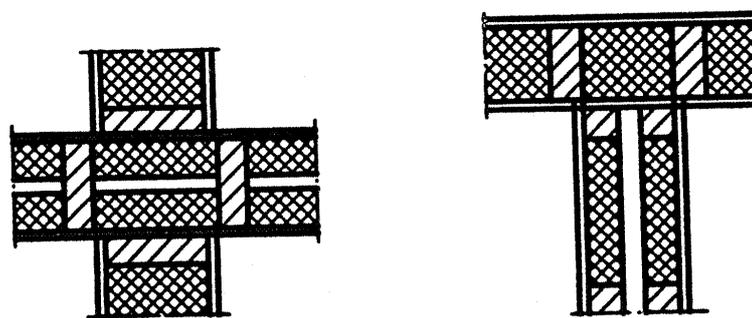
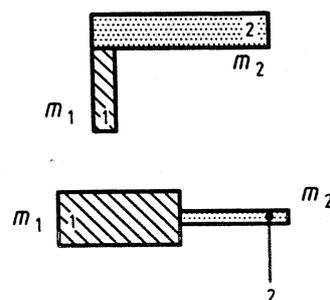
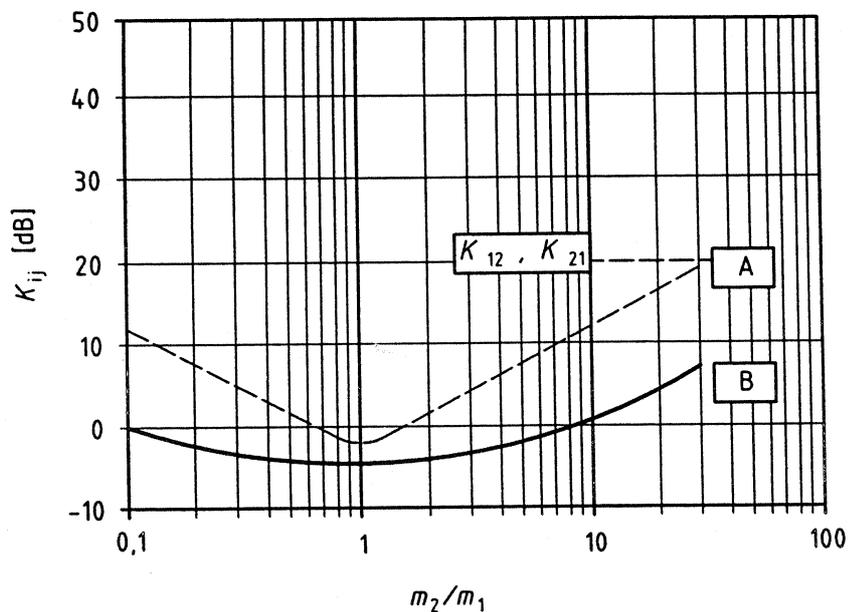

Figure E.12

Corner or thickness change



A Corner :

$$K_{12} = 15 |M| - 3 \text{ dB and minimum } -2 \text{ dB } (= K_{21}) ; 0 \text{ dB / octave}$$

B Change :

$$K_{12} = 5 M^2 - 5 \text{ dB } (= K_{21}) ; 0 \text{ dB / octave}$$

(E.9)

Figure E.13

Annex F (informative)

Determination of indirect transmission

F.1 Laboratory measurement of total indirect transmission

Under the restriction that the transmission connected with a flanking structural element is dominated by the path Ff it is feasible to characterize this transmission by laboratory measurements. This will often be the case with flanking constructions like lightweight elements, suspended ceilings, access floors. In these cases the transmission can be primarily structure-borne, primarily airborne or a combination of both. To express the results from such measurements it would be desirable to use an invariant quantity, that is a quantity which is independent of the measurement situation. From such a quantity the behaviour in the field could be extrapolated. However, such a quantity cannot be given in general, it is at most feasible to deduce such a quantity if the main transmission mechanism is known, i.e. primarily structure-borne or primarily airborne.

For the time being therefore the laboratory measurement of indirect transmission has the primary objective of intercomparison of different products in a standardized measurement situation. The measurement results are for that purpose expressed sufficiently as a flanking normalized level difference $D_{n,f}$, related to the specified laboratory situation.

$$D_{n,f} = L_1 - L_2 - 10 \lg \frac{A}{A_0} \text{ dB} ; A_0 = 10 \text{ m}^2 \quad (\text{F.1})$$

where

- L_1 is the average sound pressure level in the source room, in decibels ;
- L_2 is the average sound pressure level in the receiving room due only to sound transmitted by the considered flanking construction, in decibels ;
- A is the equivalent sound absorption area in the receiving room, in square metres; reference value $A_0 = 10 \text{ m}^2$.

For suspended ceilings this is measured in accordance with EN 20 140-10, the quantity there being denoted as $D_{n,c}$, and for access floors according to prEN ISO 140-11 "Laboratory measurements of the reduction of transmitted impact noise by floor coverings on a lightweight floor". For other flanking constructions, measurement methods are specified in prEN ISO 10848-1.

In the next sections a possible approach will be given for the use of this quantity in predictions, separately for airborne and structure-borne (flanking) transmission.

F.1.1 Indirect airborne transmission

In the case of mainly airborne transmission the following relation can be used to determine the normalized level difference $D_{n,s}$ in a field situation from the product information $D_{n,f}$ (see figure F.1).

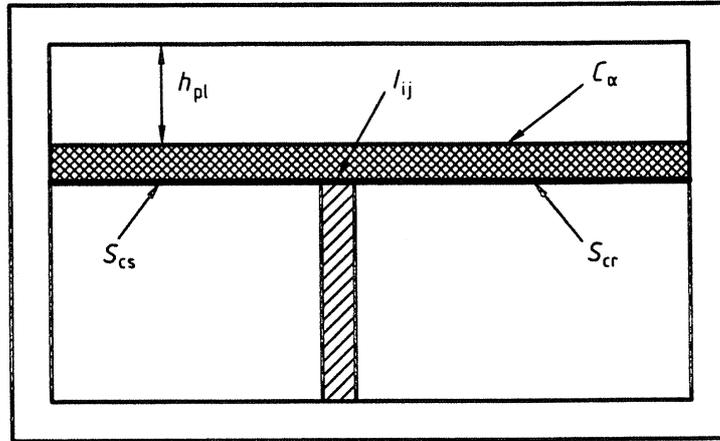

Figure F.1 - Illustration of the relevant quantities for the prediction of indirect airborne transmission

$$D_{n,s} = D_{n,f} + 10 \lg \frac{h_{pl} l_{ij}}{h_{lab} l_{lab}} + 10 \lg \frac{S_{cs,lab} S_{cr,lab}}{S_{cs} S_{cr}} + C_{\alpha} \quad \text{dB} \quad (F.2)$$

with

— no absorbing lining :

$$C_{\alpha} = 0 \text{ dB}$$

— absorbing lining :

$$C_{\alpha} = 0 \text{ dB} \quad f \leq 0,015 \frac{c_o}{t_a} \quad (F.3)$$

$$C_{\alpha} = 10 \lg \sqrt{\frac{S_{cs} S_{cr}}{S_{cs,lab} S_{cr,lab}} \frac{h_{lab}}{h_{pl}}} \text{ dB} \quad 0,015 \frac{c_o}{t_a} < f < \frac{0,3 c_o}{\min(h_{lab}, h_{pl})}$$

$$C_{\alpha} = 10 \lg \sqrt{\frac{S_{cs} S_{cr}}{S_{cs,lab} S_{cr,lab}} \frac{h_{lab}^2}{h_{pl}^2}} \text{ dB} \quad f \geq \frac{0,3 c_o}{\min(h_{lab}, h_{pl})}$$

where

S_{cs}, S_{cr} is the area of the ceiling in the source room and receiving room, respectively, in square metres ; in the laboratory, as reference, with the index 'lab', which for the ISO-laboratory can be taken as $S_{cs,lab} = S_{cr,lab} = 20 \text{ m}^2$;

h_{pl} is the free height of the plenum above the ceiling, in metres ; in the laboratory, as reference, this is h_{lab} , which for the ISO-laboratory can be taken as $h_{lab} = 0,7 \text{ m}$.

t_a is the thickness of the absorbing lining in the plenum, in metres ;

c_o is the sound speed in air, in metres per second ; $c_o = 340$ m/s.

NOTE 1 For the use of this, and future improved, relations, it actually would be necessary to perform additional measurements in the laboratory, to established that indeed the indirect airborne transmission is dominant and to establish a more accurate discriminant for the absorption in the plenum.

NOTE 2 The flanking normalized level difference will normally relate to the complete flanking construction, including the indirect airborne transmission through auxiliaries such as air inlets and light fixtures. However, in this case it could be constructed from separate data on the indirect transmission for the ceiling as such and the auxiliaries as such.

F.1.2 Flanking transmission

In case of mainly structure-borne transmission the following relation can be used to determine the flanking sound reduction index R_{FF} in a field situation from the product information $D_{n,f}$.

$$R_{FF} = D_{n,f} + 10 \lg \frac{S_s l_{lab}}{A_o l_{FF}} + 10 \lg \frac{T_{s,F,lab}}{T_{s,F}} + 10 \lg \frac{T_{s,f,lab}}{T_{s,f}} \quad \text{dB} \quad (F.4)$$

The last terms with the structural reverberation time are neglected if the construction concerned has a high internal loss factor such as sandwich walls, lightweight double leaf walls.

NOTE For the use of this, and future improved relations, it would be necessary for some types of construction to perform additional laboratory measurements, to establish that the structure-borne transmission is indeed dominant.

F.2 Determination of indirect airborne transmission from known transmission for the separate elements of a system

F.2.1 Hall or corridor

The normalized level difference $D_{n,s}$ for transmission via halls or corridors can be estimated from equation (F.5) if diffuse sound fields in the rooms and the hall can be assumed, see Figure F.2.

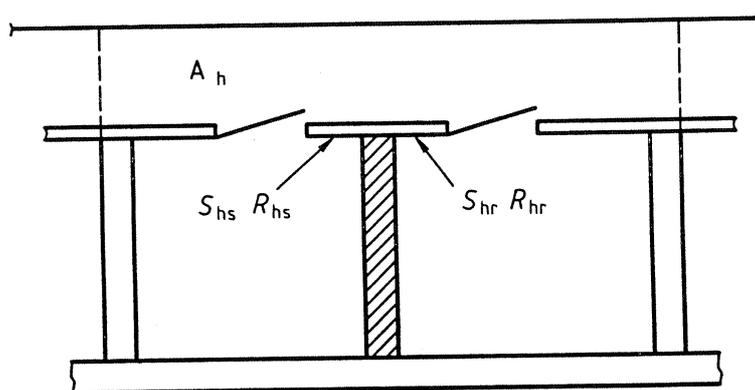

Figure F.2 - Illustration of two rooms along a corridor with relevant quantities

$$D_{n,s} = D_{n,h} = R_{hs} + R_{hr} + 10 \lg \frac{A_h A_o}{S_{hs} S_{hr}} + C_{doorposition} \quad \text{dB} \quad (F.5)$$

where

R_{hs} is the sound reduction index of the wall between the hall and the source room, in decibels ;

R_{hr} is the sound reduction index of the wall between the hall and the receiving room, in decibels ;

- S_{hs} is the area of the wall between the hall and the source room, in square metres ;
- S_{hr} is the area of the wall between the hall and the receiving room, in square metres ;
- A_h is the equivalent sound absorption area of the hall, in square metres ;
- $C_{doorposition}$ is a correction term to take into account the effect of the orientation of the doors to each other.

NOTE The value for this correction term can be estimated to be between - 2 dB for doors at 90° to each other and less than 1 m apart to 0 dB for greater distances and/or parallel positions.

The sound reduction index of the walls, R_h , follows from the sound reduction indices of the different composing elements R_{hi} , such as the wall itself, doors and windows including seals. Normally the sound reduction to the hall is dominated by the doors in those walls and the quality of the seals.

For halls the absorption is normally dominated by the area of the opening to the stairways ; for (long) corridors the parts of the corridor beyond the rooms under consideration can be taken into account as absorption by the open cross section of the corridor.

F.2.2 Ventilation system

The normalized level difference $D_{n,s}$ for transmission via ventilation systems could be estimated from the transmission loss through the elements involved, such as bends, grids, silencers and area changes. This is directly related to the estimation of the sound levels due to installation.

50

Annex G (informative)

Laboratory weighted sound reduction index including field simulated flanking transmission ('Prüfstand mit bauähnlicher Flankenübertragung', DIN 52210)

In Germany the prediction of the performance in the field in accordance with DIN 4109 is based on product information about the separating element, denoted as R'_w , which is determined in a special laboratory facility in which the flanking transmission is simulated as it occurs on average in the field for a given type of building construction. This annex gives information about the way to deduce this quantity R'_w from the weighted sound reduction index R_w of the element in accordance with EN ISO 140-3, and vice versa. This allows a transition period to apply German standards on the basis of product information in accordance with EN ISO 140-3 and European standards on the basis of product information in accordance with DIN 4109:1989.

The conversion from R_w to R'_w is done by :

$$R'_w = -10 \lg \left(10^{-R_w/10} + 10^{-(R_{Ff,w} + \delta)/10} \right) \text{ dB} \quad (\text{G.1})$$

The conversion from R'_w to R_w is done by :

$$\text{if } R'_w \leq R_{Ff,w} - 2 \text{ dB} : R_w = -10 \lg \left(10^{-R'_w/10} - 10^{-(R_{Ff,w} + \delta)/10} \right) \text{ dB} \quad (\text{G.2})$$

$$\text{if } R'_w > R_{Ff,w} - 2 \text{ dB} : R_w = R'_w + 4 \text{ dB}$$

where

- R'_w is the weighted apparent sound reduction index with field-a-like flanking transmission, in decibels ;
- R_w is the weighted sound reduction index without flanking transmission, in decibels ;
- $R_{Ff,w}$ is the weighted flanking sound reduction index of the laboratory, as tested with a lightweight double leaf separating element according to DIN 52210, in decibels ;
- δ is the increase of the weighted flanking sound reduction index of the laboratory facility due to a heavy test object, in decibels.

For the conversion from R_w to R'_w (see equation G.1) the value for $R_{Ff,w}$ is to be taken as $R_{Ff,w} = 55$ dB.

For the conversion from R'_w to R_w (see equation G.2) $R_{Ff,w}$ is the measured value from the test facility in which R'_w has been obtained ; if measured data are not available this can be taken also as $R_{Ff,w} = 55$ dB.

Provided an ideal T-junction (i.e. rigid connection) between test object and test facility and assuming dominant flanking transmission by path Ff, δ can be estimated by :

$$\begin{aligned} \frac{m'_f}{m'_t} < 2,1 : & \quad \delta = 3,0 \text{ dB} \\ 2,1 \leq \frac{m'_f}{m'_t} \leq 3 : & \quad \delta = 9,0 - 18,8 \lg \frac{m'_f}{m'_t} \text{ dB} \\ \frac{m'_f}{m'_t} > 3 : & \quad \delta = 0,0 \text{ dB} \end{aligned} \tag{G.3}$$

where

m'_t is the mass per unit area of the test object, in kilograms per square metre ;

m'_f is the averaged mass per unit area of the flanking elements of the test facility, in kilograms per square metre.

For the conversion from R_w to R'_w the value for m'_f is to be taken as $m'_f = 450 \text{ kg/m}^2$.

For the conversion from R'_w to R_w the averaged mass per unit area m'_f is the actual value for the test facility in which R'_w has been obtained.

If no rigid connection exists between test object and test facility, take $\delta = 0 \text{ dB}$.

In practice $\delta = 0 \text{ dB}$ is an approximation which yields a conversion for both lightweight and heavy separating elements with a precision within the limits of EN 20140-2:1993 "Acoustics - Measurement of sound insulation in buildings and of building elements - Part 2 : Determination, verification and application of precision data (ISO 140-2:1991)" (annex B).

Annex H (informative)

Calculation examples

H.1 Situation

Rooms next to each other, volumes both 50 m^3 and dimensions in metre ; see figure H.1.

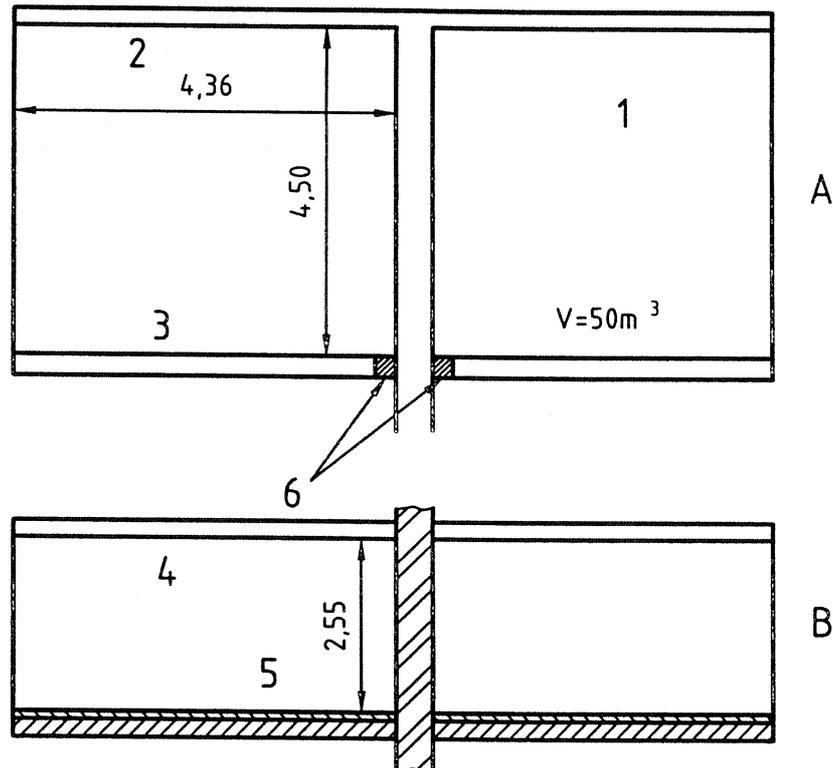

Key

- A Ground plan
- B Sectional view

Separating element :

- 1 wall $4,50 \text{ m} \times 2,55 \text{ m} = 11,5 \text{ m}^2$; 200 mm concrete, 460 kg/m^2 .

Flanking elements (identical on both sides) :

- 2 Façade : $4,36 \text{ m} \times 2,55 \text{ m} = 11,1 \text{ m}^2$; rigid T junction ;
100 mm calcium-silicate blocks, 175 kg/m^2 .
- 3 Internal wall : $4,36 \text{ m} \times 2,55 \text{ m} = 11,1 \text{ m}^2$; cross junction with elastic layer ;
70 mm gypsum blocks, 67 kg/m^2 .
- 4 Ceiling : $4,36 \text{ m} \times 4,50 \text{ m} = 19,6 \text{ m}^2$; rigid cross junction ;
100 mm concrete, 230 kg/m^2 .
- 5 Floor : $4,36 \text{ m} \times 4,50 \text{ m} = 19,6 \text{ m}^2$; rigid cross junction ;
100 mm concrete / 30 mm finish, 287 kg/m^2 .
- 6 flexible connection

Figure H.1

H.2 Detailed model

H.2.1 Results

The resulting direct and flanking sound reduction indices are given per element, per path and total, in octave bands and as weighted values ; values are rounded to the nearest dB. The details of the calculation are illustrated for the values underlined in paragraph H.2.2 and H.2.3.

Frequency :		125 Hz	250 Hz	500 Hz	1 kHz	2 kHz	4 kHz	R_w (dB)
R wall	R_d	39	46	54	62	70	74	57
	R_{Dd}	40	49	57	65	72	76	59
	R_{F1d}	51	56	64	73	80	86	68
	R_{F2d}	50	55	63	71	79	85	67
	R_{F3d}	52	54	61	70	78	85	66
	R_{F4d}	50	56	62	73	84	93	67
R floor	R_{f1}	48	51	60	68	76	82	63
	R_{Df}	51	56	64	73	80	86	68
	R_{Ff}	51	52	61	70	78	85	65
R ceiling	R_{f2}	48	50	58	67	75	82	62
	R_{Df}	50	55	63	71	79	85	67
	R_{Ff}	52	51	60	69	77	85	64
R façade	R_{f3}	51	50	56	66	74	82	61
	R_{Df}	52	54	61	70	78	85	66
	R_{Ff}	56	52	57	67	76	85	63
R internal wall	R_{f4}	49	54	59	71	83	93	64
	R_{Df}	50	56	62	73	84	93	67
	R_{Ff}	55	57	62	75	90	105	68
Total		37	42	50	59	67	73	54

$R'_w(C ; C_{tr}) = 54(-2 ; -6)$ dB, so for instance $R'_w + C (= R'_A) = 54 - 2 = 52$ dB(A).

H.2.2 Detailed steps for separating element, floor and inner wall

As an example the calculations are worked out for the separating element, the floor and the internal wall ; for calculations of the structural reverberation time for the 500 Hz octave band (bold), see H.2.3.

H.2.2.1 Transfer of input data of elements to in situ values :

Partition wall, $m = 460$ kg/m², $f_c = 94$ Hz, $S = 11,5$ m²

Frequency		125	250	500	1 k	2 k	4 k	Hz
Input :	R_s (see annex B)	38,0	46,9	55,1	62,9	70,0	74,4	dB
Calculated :	$10 \lg (T_{s,situ}/T_{s,lab})$	-2,1	-1,9	-1,8	-1,7	-1,6	-1,5	dB
Result :	$R_{s,situ}$ (see equation (19))	40,1	48,8	56,9	64,6	71,6	75,9	dB

Floor, $m = 287 \text{ kg/m}^2$, $f_c = 173 \text{ Hz}$, $S = 19,6 \text{ m}^2$, $l_{ij} = 4,5 \text{ m}$

Frequency		125	250	500	1 k	2 k	4 k	Hz
Input :	R_f (see annex B)	35,5	35,9	45,1	53,7	61,5	68,1	dB
Calculated :	$10 \lg (T_{s,situ}/T_{slab})$	-1,5	-1,4	-1,4	-1,3	-1,2	-1,0	dB
Result :	$R_{f,situ}$ (see equation (19))	37,0	37,3	46,5	55,0	62,7	69,1	dB

Internal wall, $m = 67 \text{ kg/m}^2$, $f_c = 391 \text{ Hz}$, $S = 11,1 \text{ m}^2$, $l_{ij} = 2,55 \text{ m}$

Frequency		125	250	500	1 k	2 k	4 k	Hz
Input :	R_f (see annex B)	31,8	28,5	25,7	33,3	42,3	50,4	dB
Calculated :	$10 \lg (T_{s,situ}/T_{slab})$	-2,4	-1,8	-0,8	-0,9	-0,8	-0,7	dB
Result :	$R_{f,situ}$ (see equation (19))	34,2	30,3	26,5	34,2	43,1	51,1	dB

H.2.2.2 Transfer of input data of junctions to in situ values :

Floor, $l_{FF} = 4,50 \text{ m}$, $S_F = S_f = 19,6 \text{ m}^2$, $S_s = 11,5 \text{ m}^2$.

Annex E, equation (E.3) with $m'_s/m'_f = 460/287$: $K_{Ff} = 12,4 \text{ dB}$; $K_{Df} = 8,9 \text{ dB}$; $K_{Fd} = 8,9 \text{ dB}$.

Frequency		125	250	500	1 k	2 k	4 k	Hz
Partition :	a_{situ} (see equation (22))	14,7	14,5	14,3	14,7	15,3	16,2	dB
Floor :	a_{situ} (see equation (22))	12,2	13,4	13,5	14,2	15,4	17,1	dB
Equation (21) : $D_{v,Ff} = 12,4 - 10 \lg 4,5/13,5 = 17,2 \text{ dB}$								
(500 Hz) $D_{v,Df} = 8,9 - 10 \lg 4,5/\sqrt{14,3} \sqrt{13,5} = 13,8 \text{ dB}$								
$D_{v,Fd} = 8,9 - 10 \lg 4,5/\sqrt{14,3} \sqrt{13,5} = 13,8 \text{ dB}$								

Internal wall : $l_{FF} = 2,55 \text{ m}$, $S_F = S_f = 11,1 \text{ m}^2$, $S_s = 11,5 \text{ m}^2$.

Annex E, equation (E.5) with $m'_s/m'_f = 460/67$: $K_{Ff} = 33,5 \text{ dB}$; $K_{Df} = 15,7 \text{ dB}$; $K_{Fd} = 15,7 \text{ dB}$.

Frequency		125	250	500	1 k	2 k	4 k	Hz
Partition :	a_{situ} (see equation (22))	14,7	14,5	14,3	14,7	15,3	16,2	dB
Int. wall :	a_{situ} (see equation (22))	2,2	2,4	4,1	3,6	3,9	4,6	dB
Equation (21) : $D_{v,Ff} = 33,5 - 10 \lg 2,55/4,1 = 35,6 \text{ dB}$								
(500 Hz) $D_{v,Df} = 15,7 - 10 \lg 2,55/\sqrt{14,3} \sqrt{4,1} = 20,5 \text{ dB}$								
$D_{v,Fd} = 15,7 - 10 \lg 2,55/\sqrt{14,3} \sqrt{4,1} = 20,5 \text{ dB}$								

H.2.2.3 Determination of direct and flanking sound transmission ; equations 24, 25 ; 500 Hz :

Partition :	direct	$R_{Dd} = 56,9$
	floor	$R_{Fd} = 46,4/2 + 56,9/2 + 13,8 - 1,2 = 64,2$ dB
	Internal wall	$R_{Fd} = 26,6/2 + 56,9/2 + 20,5 + 0,1 = 62,3$ dB
Floor :		$R_{Ff} = 46,4/2 + 46,4/2 + 17,2 - 2,3 = 61,3$ dB
		$R_{Df} = 46,4/2 + 56,9/2 + 13,8 - 1,2 = 64,2$ dB
Internal wall :		$R_{Ff} = 26,6/2 + 26,6/2 + 35,6 + 0,2 = 62,4$ dB
		$R_{Df} = 26,6/2 + 56,9/2 + 20,5 + 0,1 = 62,3$ dB

The rounded values are given in the table with results in H.2 (bold).

H.2.3 Structural reverberation time partition wall at 500 Hz octave :

Calculations for this octave band with $f = 400$ Hz (lower one-third octave band).

Laboratory

With $m' = 460$ kg and $f_c = 94$ Hz ; equation (C4) gives : $\alpha_k = 0,191$.

With $\eta_{int} = 0,006$; $\sigma = 1,1$; $S_{lab} = 10$ m² and $\Sigma l_k = 12,8$ m, equation (C.1) gives : $\eta_{tot} = 0,051$, thus.

$T_{s,lab} = 0,108$ s (the estimation according to equation (C.5) would give $T_{s,lab} = 0,103$ s).

Field ; borders with :

- floor : $K_{ij} = 5,4 ; 8,9$ and $8,9$ dB (see equation (E.3)) ;
thus equation (C.2) gives $\alpha = 0,195$;
- ceiling $K_{ij} = 4,1 ; 9,2$ and $9,2$ dB (see equation (E.3)) ;
thus equation (C.2) gives $\alpha = 0,223$;
- façade : $K_{ij} = 6,7$ and $6,7$ dB (see equation (E.3)) ;
thus equation (C.2) gives $\alpha = 0,214$;
- internal wall : $K_{ij} = - 4,0 ; 15,7$ and $15,7$ dB (see equation (E.5), 500 Hz) ;
thus equation (C.2) gives $\alpha = 0,800$.

This results in (see equation (C.1)) : $\eta_{tot} = 0,076$ and $T_{s,situ} = 0,072$ s.

So the terms for the sound reduction index and the junction transmission are :

- partition : $10 \lg T_{s,situ} / T_{s,lab} = 10 \lg 0,072 / 0,108 = - 1,8$ dB ;

$a_{situ} = 14,3$ m.

Following the same procedure it also follows that :

- floor : $a_{\text{situ}} = 13,5 \text{ m}$;
- internal wall : $a_{\text{situ}} = 4,1 \text{ m}$.

H.3 Simplified model

The simplified model is applied to the same situation.

INPUT DATA :	ELEMENTS	JUNCTIONS				
		m' (kg/m ²)	R_w (dB) Annex B	m'_s/m'_t	K_{Ff} (dB)	K_{Fd} (dB)
					Annex E	
Wall (s)	460	57				
Floor (F = f = 1)	287	49	1,61	12,4	8,9	8,9
Ceiling (F = f = 2)	230	46	2,00	14,4	9,2	9,2
Façade (F = f = 3)	175	42	2,63	12,6	6,7	6,7
Internal wall (F = f = 4)	67	33	6,97	33,5	15,7	15,7

RESULTS : (equations (27), (28))

Wall :

$$R_{Dd} = 57,0 \text{ dB}$$

$$R_{1d} = 49/2 + 57/2 + 8,9 + 4,1 = 66,0 \text{ dB}$$

$$R_{2d} = 46/2 + 57/2 + 9,2 + 4,1 = 64,8 \text{ dB}$$

$$R_{3d} = 42/2 + 57/2 + 6,7 + 6,5 = 62,7 \text{ dB}$$

$$R_{4d} = 33/2 + 57/2 + 15,7 + 6,5 = 67,2 \text{ dB}$$

Floor :

$$R_{D1} = 49/2 + 57/2 + 8,9 + 4,1 = 66,0 \text{ dB}$$

$$R_{11} = 49 + 12,4 + 4,1 = 65,5 \text{ dB}$$

Ceiling :

$$R_{D2} = 46/2 + 57/2 + 9,2 + 4,1 = 64,8 \text{ dB}$$

$$R_{22} = 46 + 14,4 + 4,1 = 64,5 \text{ dB}$$

Façade :

$$R_{D3} = 42/2 + 57/2 + 6,7 + 6,5 = 62,7 \text{ dB}$$

$$R_{33} = 42 + 12,6 + 6,5 = 61,1 \text{ dB}$$

Internal wall :

$$R_{D4} = 33/2 + 57/2 + 15,7 + 6,5 = 67,2 \text{ dB}$$

$$R_{44} = 33 + 33,5 + 6,5 = 73,0 \text{ dB}$$

Total (equation (26)) $R'_w = 52,2 \approx 52 \text{ dB}$ (C ca. -1 dB)

(equation (5 b)) $D_{nT,w} = 52,2 + 10 \lg [50/(3 \times 11,5)] = 52,2 + 1,6 = 53,8 \approx 54 \text{ dB}$

As a **second example** a floating floor is added, both in the source and receiving room. The sound reduction index improvement is given as $\Delta R_w = 14 \text{ dB}$.

ISO 15712-1:2005(E)

This affects the transmission paths Ff, Fd and Df for the floor (equation (31)) :

$$\Delta R_{22w} = 14 + (0,5 \times 14) = 21 \text{ dB} ; \Delta R_{2dw} = 14 \text{ dB and } \Delta R_{D2w} = 14 \text{ dB}$$

So for the separating wall and the floor the following transmissions change :

$$\text{Wall} \quad R_{1d} = 66,0 + 14 = 80,0 \text{ dB}$$

$$\text{Floor} \quad R_{D2} = 66,0 + 14 = 80,0 \text{ dB}$$

$$R_{22} = 65,5 + 21 = 86,5 \text{ dB}$$

And the total result becomes :

$$R'_w = 52,7 \approx 53 \text{ dB (C ca. } -1 \text{ dB)}$$

$$D_{nT,w} = 52,7 + 1,6 = 54,3 \approx 54 \text{ dB}$$

.....

Bibliography

- [1] Cremer, L., "Theorie der Schalldämmung dünner Wände bei schrägem Einfall", Akust. Zeitschrift 7 (1942), 81-104.
- [2] Cremer, L., M. Heckl, E.E. Ungar, Structure borne sound, Springer-Verlag, Berlin, New York, 2nd edition, 1988.
- [3] DIN 4109 - Schallschutz im Hochbau ; Anforderungen und Nachweise, DIN Berlin, 1989.
- [4] Gerretsen, E., "Calculation of sound transmission between dwellings by partitions and flanking structures", Applied Acoustics 12 (1979), 413-433.
- [5] Gerretsen, E., "Calculation of airborne and impact sound insulation between dwellings", Applied Acoustics 19 (1986), 245-264.
- [6] Gösele, K., "Untersuchungen zur Schall-längsleitung in Bauten", Berichte aus der Bauforschung, Heft 56 (1968), 25-35.
- [7] Guide Qualitel, Association Qualitel, Paris, 1989.
- [8] Heckl, M., "Die Schalldämmung von homogenen Einfachwänden endlicher Fläche", Acustica 20 (1968), 98-108.
- [9] Homb, A. e.a., "Lydisolerende konstruksjoner", NBI, 1983.
- [10] Josse, R. and J. Lamure, "Transmission du son par une paroi simple", Acustica 14 (1964), 266-280.
- [11] Ljunggren, S. "Airborne sound insulation of thin walls", JASA 89 (1991), 2324-2337.
- [12] Ljunggren, S., "Airborne sound insulation of thick walls", JASA 89 (1991), 2338-2345.
- [13] Maidanik, G., "Response of ribbed panels to reverberant acoustic fields", JASA 34 (1962), 809-826.
- [14] Mechel, F.P., "Schall-Längsdämmung von Unterdecken", WKSB, Zeitschrift für Wärme-Kälte-, Schall- und Brandschutz, special issue, August 1980, 16-29.
- [15] ÖNORM B 8115, Schallschutz und Raumakustik im Hochbau, ON, Wien, 1992.
- [16] Sewell, E.C., "Transmission of reverberant sound through a single-leaf partition surrounded by an infinite rigid baffle", Journal of Sound and Vibration 12 (1970), 21-32.
- [17] Gerretsen, E., "European developments in prediction models for building acoustics", Acta Acustica 2 (1994), 205-214.
- [18] Novak, R. A., "Radiation from partially excited plates", Acta Acustica 3 (1995), 561-567.
- [19] DIN 52210 - Bauakustische Prüfungen ; Luft- und Trittschalldämmung, DIN Berlin, 1989.

www.iso.org/iso/iso_catalogue

ICS 91.120.20

Price based on 59 pages