

First edition
2003-12-01

Corrected version
2004-09-15

**Rolling bearings — Thermal speed
rating — Calculation and coefficients**

*Roulements — Vitesse de référence thermique — Calculs et facteurs
de correction*



Reference number
ISO 15312:2003(E)

© ISO 2003

PDF disclaimer

This PDF file may contain embedded typefaces. In accordance with Adobe's licensing policy, this file may be printed or viewed but shall not be edited unless the typefaces which are embedded are licensed to and installed on the computer performing the editing. In downloading this file, parties accept therein the responsibility of not infringing Adobe's licensing policy. The ISO Central Secretariat accepts no liability in this area.

Adobe is a trademark of Adobe Systems Incorporated.

Details of the software products used to create this PDF file can be found in the General Info relative to the file; the PDF-creation parameters were optimized for printing. Every care has been taken to ensure that the file is suitable for use by ISO member bodies. In the unlikely event that a problem relating to it is found, please inform the Central Secretariat at the address given below.

© ISO 2003

All rights reserved. Unless otherwise specified, no part of this publication may be reproduced or utilized in any form or by any means, electronic or mechanical, including photocopying and microfilm, without permission in writing from either ISO at the address below or ISO's member body in the country of the requester.

ISO copyright office
Case postale 56 • CH-1211 Geneva 20
Tel. + 41 22 749 01 11
Fax + 41 22 749 09 47
E-mail copyright@iso.org
Web www.iso.org

Published in Switzerland

Contents

Page

Foreword	iv
1 Scope.....	1
2 Normative references	1
3 Terms and definitions.....	2
4 Symbols and units	3
5 Reference conditions.....	4
5.1 General	4
5.2 Reference conditions determining the frictional heat generation	4
5.3 Reference conditions determining the heat emission	5
6 Calculation of the thermal speed rating	7
7 Explanatory notes	8
Annex A (informative) Coefficients f_{0r} and f_{1r}	9
Annex B (informative) Thermal speed rating for rolling bearings with grease lubrication	11
Bibliography	12

Foreword

ISO (the International Organization for Standardization) is a worldwide federation of national standards bodies (ISO member bodies). The work of preparing International Standards is normally carried out through ISO technical committees. Each member body interested in a subject for which a technical committee has been established has the right to be represented on that committee. International organizations, governmental and non-governmental, in liaison with ISO, also take part in the work. ISO collaborates closely with the International Electrotechnical Commission (IEC) on all matters of electrotechnical standardization.

International Standards are drafted in accordance with the rules given in the ISO/IEC Directives, Part 2.

The main task of technical committees is to prepare International Standards. Draft International Standards adopted by the technical committees are circulated to the member bodies for voting. Publication as an International Standard requires approval by at least 75 % of the member bodies casting a vote.

Attention is drawn to the possibility that some of the elements of this document may be the subject of patent rights. ISO shall not be held responsible for identifying any or all such patent rights.

ISO 15312 was prepared by Technical Committee ISO/TC 4, *Rolling bearings*, Subcommittee SC 8, *Load ratings and life*.

In this corrected version of ISO 15312:2003, the status of both Annex A and Annex B has been changed from normative to informative.

Rolling bearings — Thermal speed rating — Calculation and coefficients

1 Scope

This International Standard defines the thermal speed rating for oil bath lubricated rolling bearings and defines calculation principles for the determination of this parameter. The parameter determined in accordance with this International Standard applies to rolling bearings of the given series and sizes of standard design or of a design that, from a frictional point of view, can be related to a standard design bearing.

In most cases of standard assembly, the permissible temperature determines the maximum operating speed. Heating of the assembly is then generated by the bearing.

Thrust ball bearings are excluded from this International Standard as kinematic effects do not allow the thermal speed rating defined in this International Standard to be applied.

NOTE 1 In Annex A mean values for the coefficients f_{0r} and f_{1r} are given — f_{0r} for calculating viscous losses of oil bath lubricated bearings and f_{1r} for calculating frictional losses of bearings.

NOTE 2 In Annex B the reference conditions for grease lubrication are defined. The reference conditions are chosen such that the thermal speed rating for grease lubrication is identical to that for oil bath lubrication.

2 Normative references

The following referenced documents are indispensable for the application of this document. For dated references, only the edition cited applies. For undated references, the latest edition of the referenced document (including any amendments) applies.

ISO 76:1987, *Rolling bearings — Static load ratings*

ISO 1132-1:2000, *Rolling bearings — Tolerances — Part 1: Terms and definitions*

ISO 5593:1997, *Rolling bearings — Vocabulary*

ISO 5753:1991, *Rolling bearings — Radial internal clearance*

ISO 15241:2001, *Rolling bearings — Symbols for quantities*

3 Terms and definitions

For the purposes of this document the terms and definitions given in ISO 1132-1, ISO 5593 and the following apply.

3.1

thermal speed rating

inner ring or shaft washer rotational speed at which equilibrium is reached between the heat generated by the friction in the bearing and the heat flow emitted through the bearing seating (shaft and housing) under the reference conditions

NOTE 1 The thermal speed rating is one among various criteria which permit comparison of the different rolling bearing types and sizes with regard to their suitability for operation at high speed.

NOTE 2 Mechanical and kinematic criteria which could lead to further speed limitations are not taken into account by the thermal speed rating.

3.2

reference conditions

conditions for the thermal speed rating related to

- a) the mean temperature of the stationary outer ring or housing washer of the bearing, i.e. the reference temperature, and the mean environmental temperature, i.e. the reference ambient temperature;
- b) the factors determining the friction losses in the bearing, such as:
 - the magnitude and direction of the bearing load;
 - the method of lubrication, type of lubricant, its kinematic viscosity and quantity;
 - other general reference conditions;
- c) the heat flow emitted from the rolling bearing defined as the product of the "heat emitting reference surface area of the rolling bearing" and the "reference heat flow density specific to the rolling bearing".

NOTE The heat emission under the reference conditions is based on empirical values and represents the heat emission of the real bearing arrangement. It is, however, independent of the real design of the bearing arrangement.

3.3

heat emitting reference surface area

sum of the contact areas, between inner ring (shaft washer) and shaft and between outer ring (housing washer) and housing, through which the heat flow is emitted

3.4

reference load

bearing load, determined by the reference conditions, which causes the load-dependent frictional moment

3.5

reference heat flow

heat flow, emitted by thermal conduction through the heat emitting reference surface, and caused by frictional resistance, when the bearing is operating under the reference conditions

3.6

reference heat flow density

reference heat flow divided by the heat emitting reference surface area

3.7

reference ambient temperature

mean environmental temperature of the bearing arrangement under the reference conditions

3.8

reference temperature

mean temperature of the stationary outer ring or housing washer of the bearing under the reference conditions

4 Symbols and units

For the purposes of this document, the symbols given in ISO 15241 and the following apply.

Table 1 — Symbols and units

Symbol	Term	Unit
A_r	Heat emitting reference surface area	mm ²
B	Width of rolling bearing	mm
C_{0a}	Basic static axial load rating in accordance with ISO 76	N
C_{0r}	Basic static radial load rating in accordance with ISO 76	N
d	Bearing bore diameter	mm
d_m	Mean diameter of rolling bearing $d_m = 0,5 \times (D + d)$	mm
d_1	Outside diameter of the inner ring of thrust spherical roller bearing	mm
D	Bearing outside diameter	mm
D_1	Inside diameter of the outer ring of thrust spherical roller bearing	mm
f_{0r}	Coefficient for the load-independent frictional moment for the reference conditions	1
f_{1r}	Coefficient for the load-dependent frictional moment for the reference conditions	1
M_0	Load-independent frictional moment	N·mm
M_{0r}	Load-independent frictional moment under the reference conditions at the thermal speed rating, $n_{\theta r}$	N·mm
M_1	Load-dependent frictional moment	N·mm
M_{1r}	Load-dependent frictional moment under the reference conditions at the thermal speed rating, $n_{\theta r}$	N·mm
$n_{\theta r}$	Thermal speed rating	min ⁻¹
N_r	Bearing power loss under the reference conditions at the thermal speed rating, $n_{\theta r}$	W
P_{1r}	Reference load	N
q_r	Reference heat flow density	W/mm ²
T	Total width of tapered roller bearing	mm
α	Contact angle	°
θ_{Ar}	Reference ambient temperature	°C
θ_r	Reference temperature	°C
ν_r	Kinematic viscosity of the lubricant under the reference conditions (at the reference temperature, θ_r , of the rolling bearing)	mm ² /s
Φ_r	Reference heat flow	W

5 Reference conditions

5.1 General

The reference conditions in this International Standard are mainly based on the operating conditions of the most frequently used bearing types and sizes.

5.2 Reference conditions determining the frictional heat generation

5.2.1 Reference temperatures

Reference temperature of the bearing on the stationary outer ring or housing washer: $\theta_r = 70$ °C.

Reference temperature of the bearing environment: $\theta_{Ar} = 20$ °C.

5.2.2 Reference load

5.2.2.1 Radial bearings with contact angle $0^\circ \leq \alpha \leq 45^\circ$ 5 % of the basic static radial load rating C_{0r} as pure radial load. $P_{1r} = 0,05 \times C_{0r}$

In the case of a single-row angular contact bearing, the reference load refers to the radial component of that load which causes a purely radial displacement of the bearing rings in relation to each other.

5.2.2.2 Thrust roller bearings with contact angle $45^\circ < \alpha \leq 90^\circ$ 2 % of the basic static axial load rating C_{0a} as centrally acting axial load. $P_{1r} = 0,02 \times C_{0a}$

5.2.3 Lubrication

5.2.3.1 Lubricant

A mineral oil without EP additives having the following kinematic viscosity, ν_r , at $\theta_r = 70$ °C:

a) Radial bearings $\nu_r = 12$ mm²/s (ISO VG 32)

b) Thrust roller bearings $\nu_r = 24$ mm²/s (ISO VG 68)

5.2.3.2 Method of lubrication

Oil bath lubrication with an oil level up to the centre of the rolling element in the lowest position.

5.2.4 Other reference conditions

5.2.4.1 Bearing characteristics

size range	standard type bearings up to and including a bore diameter of 1 000 mm
internal clearance	complying with group "N" as specified in ISO 5753:1991
seals	not provided with contacting seals
double row radial bearings and double direction thrust bearings	presumed to be symmetrical
rolling bearings where the rolling elements operate directly on the shaft or in the housing	presumed that the running surface of the shaft or housing is equivalent in all respects to the raceway of the bearing ring or washer which it replaces

5.2.4.2 Arrangement of the bearing

bearing rotational axis	horizontal
-------------------------	------------

NOTE For thrust cylindrical roller and needle roller bearings care should be taken to supply oil to the upper rolling elements.

outer ring or housing washer	stationary
------------------------------	------------

angular contact bearing setting	zero operating clearance
---------------------------------	--------------------------

5.3 Reference conditions determining the heat emission**5.3.1 Heat emitting reference surface area**

The following surface areas are defined as the heat emitting reference surface area A_r .

- a) For radial bearings with the exception of tapered roller bearings, see Figure 1.

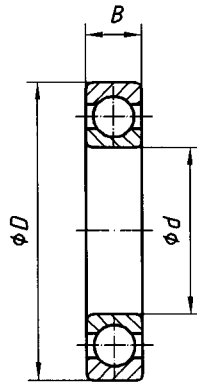

$$A_r = \pi \times B (D + d) \quad (1)$$

Figure 1

- b) For tapered roller bearings, see Figure 2.

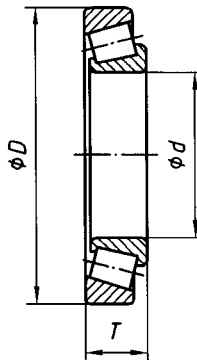

$$A_r = \pi \times T (d + D) \quad (2)$$

NOTE The total width of the bearing has been used instead of the individual ring widths to give results that align more correctly with empirical data.

Figure 2

c) For thrust cylindrical roller bearings and thrust needle roller bearings, see Figure 3.

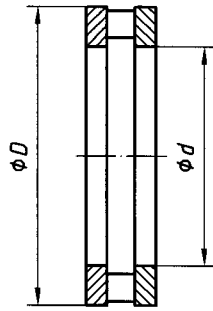

$$A_r = 0,5 \times \pi (D^2 - d^2) \quad (3)$$

Figure 3

d) For thrust spherical roller bearings, see Figure 4.

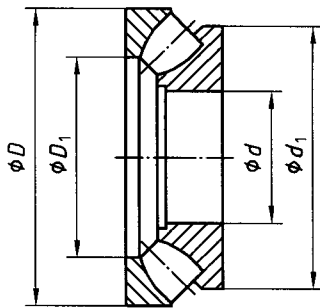

$$A_r = 0,25 \times \pi (D^2 + d^2 - D_1^2 - d_1^2) \quad (4)$$

Figure 4

5.3.2 Reference heat flow density

The reference heat flow density, q_r , is defined as:

$$q_r = \frac{\Phi_r}{A_r} \quad (5)$$

For normal applications the following values for the heat flow density q_r may be assumed, when the temperature difference $\theta_r - \theta_{Ar}$ equals 50 °C:

Radial bearings (see Figure 5, curve 1)

— for $A_r \leq 50\,000 \text{ mm}^2$

$$q_r = 0,016 \text{ W/mm}^2$$

— for $A_r > 50\,000 \text{ mm}^2$

$$q_r = 0,016 \times \left(\frac{A_r}{50\,000} \right)^{-0,34} \text{ W/mm}^2$$

Thrust bearings (see Figure 5, curve 2)

— for $A_r \leq 50\,000 \text{ mm}^2$

$$q_r = 0,020 \text{ W/mm}^2$$

— for $A_r > 50\,000 \text{ mm}^2$

$$q_r = 0,020 \times \left(\frac{A_r}{50\,000} \right)^{-0,16} \text{ W/mm}^2$$

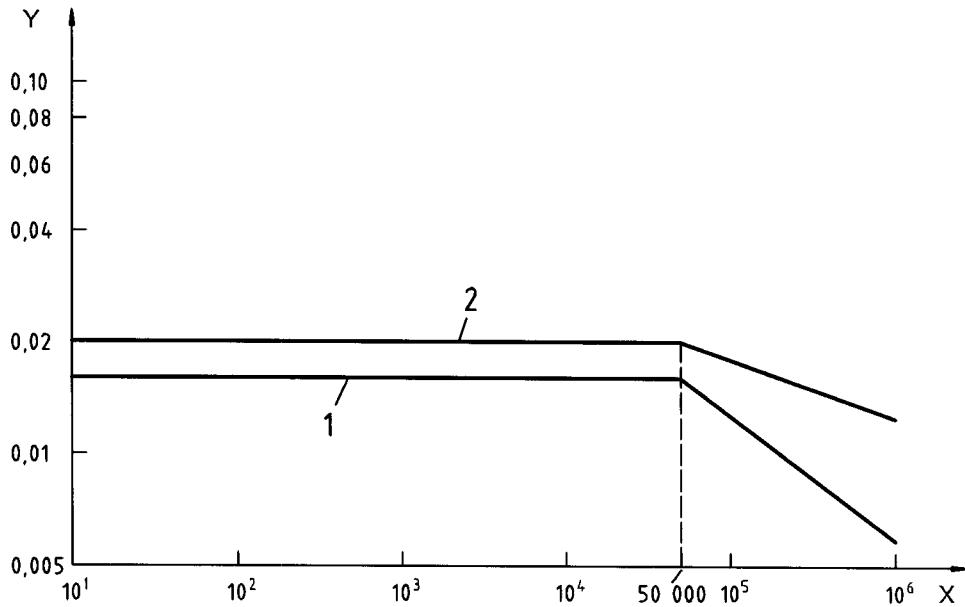

Key

- 1 radial bearings
- 2 thrust bearings
- X Heat emitting reference surface, A_r , mm²
- Y Reference heat flow density, q_r , W/mm²

Figure 5

6 Calculation of the thermal speed rating

The calculation of the thermal speed rating is based on the energy balance in the rolling bearing system under the reference conditions. The frictional heat generated in the bearing under the reference conditions and at the thermal speed rating equals the heat flow emitted from the bearing:

$$N_r = \Phi_r \tag{6}$$

The frictional heat of a bearing running at the thermal speed rating under the reference conditions is calculated as follows:

$$N_r = \frac{\pi \times n_{\theta r}}{30 \times 10^3} (M_{0r} + M_{1r}) \tag{7}$$

$$= \frac{\pi \times n_{\theta r}}{30 \times 10^3} [10^{-7} \times f_{0r} (v_r \times n_{\theta r})^{2/3} \times d_m^3 + f_{1r} \times P_{1r} \times d_m]$$

$$M_{0r} = [10^{-7} \times f_{0r} (v_r \times n_{\theta r})^{2/3} \times d_m^3] \tag{8}$$

$$M_{1r} = f_{1r} \times P_{1r} \times d_m \tag{9}$$

The heat flow emitted from the rolling bearing under the reference conditions is calculated from the reference heat flow density, q_r , and the heat emitting reference surface area, A_r :

$$\Phi_r = q_r \times A_r \tag{10}$$

With equation (7) for the frictional heat generated and equation (10) for the heat flow emitted, the equation for the determination of the thermal speed rating $n_{\theta r}$ is given as:

$$\frac{\pi \times n_{\theta r}}{30 \times 10^3} [10^{-7} \times f_{0r} (v_r \times n_{\theta r})^{2/3} \times d_m^3 + f_{1r} \times P_r \times d_m] = \times q_r \times A_r \quad (11)$$

The thermal speed rating $n_{\theta r}$ is determined from equation (11) by iteration.

7 Explanatory notes

The maximum permissible speed for a bearing can be limited by various criteria, such as the permissible temperature (the most frequently found limiting criterion), ensuring satisfactory lubrication when taking account of centrifugal forces, avoiding fracture of any bearing component, the rolling kinematics, vibrations, noise generation, the running speed of the sealing lips, etc.

In this International Standard, the bearing temperature is used as the limiting criterion to rate the speed capability of the bearing.

The speed capability is expressed as the thermal speed rating. It is calculated for uniform reference conditions. The thermal speed rating may differ appreciably from the speeds so far published by bearing manufacturers in their catalogues as the reference conditions selected for this International Standard may be different.

Friction in the bearing is transformed into heat, so that the bearing temperature increases until an equilibrium is reached between the heat generated and the heat emitted.

The load-independent frictional moment, M_0 , takes account of the viscous friction in the bearing and depends on the rolling bearing type, size (mean rolling bearing diameter), speed and lubrication conditions. These conditions include the method of lubrication, the type of lubricant, its kinematic viscosity and quantity.

The load-dependent frictional moment, M_1 , takes account of the mechanical friction and depends on the rolling bearing type, size (mean rolling bearing diameter) and the magnitude and direction of the load.

The actual heat flow density may differ from the assumed values in this International Standard, depending on varying frictional resistance in relation to heat flow emission capacity; e.g., housing design, environmental conditions and bearing friction have a great influence on the heat flow density.

Annex A
(informative)

Coefficients f_{0r} and f_{1r}

Table A.1 contains values of coefficients f_{0r} and f_{1r} for use in the calculation of the thermal speed rating $n_{\theta r}$ from equation (11) for different bearing types without contacting seals.

They are the result of extensive experimental investigations as well as the analysis of empirical values from literature.

Although the values for f_{0r} and f_{1r} naturally scatter, a mean value without tolerances is given in Table A.1, which makes it possible to calculate uniform thermal speed ratings.

The coefficients f_{0r} and f_{1r} are dependent on the bearing type.

The dimension series referred to in Table A.1 are those defined in ISO 15 and ISO 104.

Table A.1 — Coefficients f_{0r} and f_{1r}















Bearing type	Dimension series	f_{0r}	f_{1r}	Bearing type	Dimension series	f_{0r}	f_{1r}	
Single-row deep groove ball bearings 	18	1,7	0,000 10	Four-point contact ball bearings 	02	2	0,000 37	
	28	1,7	0,000 10		03	3	0,000 37	
	38	1,7	0,000 10					
		19	1,7	0,000 15	Single-row cylindrical roller bearings with cage  	10	2	0,000 20
		39	1,7	0,000 15		02	2	0,000 30
		00	1,7	0,000 15		22	3	0,000 40
		10	1,7	0,000 15		03	2	0,000 35
		02	2	0,000 20		23	4	0,000 40
		03	2,3	0,000 20		04	2	0,000 40
		04	2,3	0,000 20				
Self-aligning ball bearings 	02	2,5	0,000 08	Single-row angular contact ball bearings $22^\circ < \alpha \leq 45^\circ$ 		18	5	0,000 55
	22	3	0,000 08		29	6	0,000 55	
	03	3,5	0,000 08		30	7	0,000 55	
	23	4	0,000 08		22	8	0,000 55	
Single-row angular contact ball bearings $22^\circ < \alpha \leq 45^\circ$ 	02	2	0,000 25	Single-row cylindrical roller bearings full complement 	23	12	0,000 55	
	03	3	0,000 35					

Table A.1 (continued)

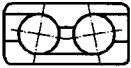
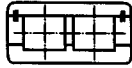
Bearing type	Dimension series	f_{0r}	f_{1r}	Bearing type	Dimension series	f_{0r}	f_{1r}	
Double-row or paired single-row angular contact ball bearings 	32	5	0,000 35	Double-row cylindrical roller bearings full complement 	48	9	0,000 55	
	33	7	0,000 35		49	11	0,000 55	
					50	13	0,000 55	
Needle roller bearings 	48	5	0,000 50	Thrust cylindrical roller bearings 	11	3	0,001 50	
	49	5,5	0,000 50		12	4	0,001 50	
	69	10	0,000 50					
Spherical roller bearings 	39	4,5	0,000 17	Thrust needle roller bearings 	a	5	0,001 50	
	30	4,5	0,000 17					
	40	6,5	0,000 27					
	31	5,5	0,000 27	Thrust spherical roller bearings 	92	3,7	0,000 30	
	41	7	0,000 49		93	4,5	0,000 40	
	22	4	0,000 19		94	5	0,000 50	
	32	6	0,000 36					
Tapered roller bearings 	03	3	0,000 40	Thrust spherical roller bearings modified design (optimised internal construction) 	92	2,5	0,000 23	
	30	3	0,000 40		93	3	0,000 30	
	29	3	0,000 40		94	3,3	0,000 33	
	20	3	0,000 40					
	22	4,5	0,000 40					
	23	4,5	0,000 40					
	13	4,5	0,000 40					
	31	4,5	0,000 40					
32	4,5	0,000 40						

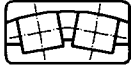
^a Dimension series for thrust needle roller bearings according to ISO 3031.

Annex B (informative)

Thermal speed rating for rolling bearings with grease lubrication

B.1 General

The thermal speed rating for grease lubrication is calculated in the same way as for oil bath lubrication.

For grease lubricated bearings the load-independent frictional moment, M_{0r} , is not constant within the operating time. Therefore, the reference temperature $\theta_r = 70\text{ °C}$ is defined as the temperature obtained after 10 h to 20 h of operation, when the thermal speed rating will equal the rating for oil bath lubrication if the reference conditions given in B.2 and B.3 are realized.

B.2 Lubrication requirements

For grease lubrication the following reference conditions are assumed:

Grease type	Lithium soap grease with a mineral base oil. The kinematic viscosity of the base oil is 100 mm ² /s to 200 mm ² /s at 40 °C (e.g. ISO VG 150).
Grease quantity	The bearings are lubricated with a grease quantity of approximately 30 % of the free volume in the bearing.

B.3 Coefficients f_{0r} and f_{1r}

The same f_{0r} coefficient values as for oil bath lubrication can be assumed after 10 h to 20 h of operation. Immediately after regreasing, an f_{0r} coefficient of twice the oil bath lubrication value may be assumed. At the end of a long operating period, just before relubrication, the value of f_{0r} may decrease to 25 % of the oil bath lubrication value, but then the risk of starvation has to be considered.

The values for coefficient f_{1r} for grease lubrication are the same as for oil bath lubrication.

Bibliography

- [1] ISO 15:1998, *Rolling bearings — Radial bearings — Boundary dimensions, general plan*
- [2] ISO 104:2002, *Rolling bearings — Thrust bearings — Boundary dimensions, general plan*
- [3] ISO 3031:2000, *Rolling bearings — Thrust needle roller and cage assemblies, thrust washers — Boundary dimensions and tolerances*
- [4] PALMGREN, A., *Ball and Roller Bearing Engineering*, 3rd ed., Burbank, Philadelphia, 1959

ICS 21.100.20

Price based on 12 pages