**Road vehicles — Communication
between vehicle and external equipment
for emissions-related diagnostics —**

**Part 5:
Emissions-related diagnostic services**

*Véhicules routiers — Communications entre un véhicule et un
équipement externe pour le diagnostic relatif aux émissions —*

Partie 5: Services de diagnostic relatif aux émissions





COPYRIGHT PROTECTED DOCUMENT

© ISO 2011

All rights reserved. Unless otherwise specified, no part of this publication may be reproduced or utilized in any form or by any means, electronic or mechanical, including photocopying and microfilm, without permission in writing from either ISO at the address below or ISO's member body in the country of the requester.

ISO copyright office
Case postale 56 • CH-1211 Geneva 20
Tel. + 41 22 749 01 11
Fax + 41 22 749 09 47
E-mail copyright@iso.org
Web www.iso.org

Published in Switzerland

Contents

Page

Foreword	iv
Introduction.....	v
1 Scope	1
2 Normative references	2
3 Terms, definitions and abbreviated terms	3
3.1 Terms and definitions	3
3.2 Abbreviated terms	5
4 Conventions	6
5 Document overview	6
6 Technical requirements	6
6.1 General requirements	6
6.2 Diagnostic service requirements	7
6.3 Diagnostic message format	34
6.4 Byte Order Convention	38
6.5 Allowance for expansion and enhanced diagnostic services	38
6.6 Definition of PIDs for services 0x01 and 0x02	39
6.7 Format of data to be displayed	39
7 Diagnostic service definition for ISO 9141-2, ISO 14230-4, and SAE J1850	39
7.1 Service 0x01 — Request current powertrain diagnostic data	39
7.2 Service 0x02 — Request powertrain freeze frame data	44
7.3 Service 0x03 — Request emission-related diagnostic trouble codes	48
7.4 Service 0x04 — Clear/Reset emission-related diagnostic information	53
7.5 Service 0x05 — Request oxygen sensor monitoring test results	55
7.6 Service 0x06 — Request On-board monitoring test results for Specific monitored systems	60
7.7 Service 0x07 — Request emission-related diagnostic trouble codes detected during current or last completed driving cycle	65
7.8 Service 0x08 — Request control of on-board system, test or component	66
7.9 Service 0x09 — Request vehicle information	69
8 Diagnostic service definition for ISO 15765-4	83
8.1 Service 0x01 — Request current powertrain diagnostic data	83
8.2 Service 0x02 — Request powertrain freeze frame data	89
8.3 Service 0x03 — Request emission-related diagnostic trouble codes	95
8.4 Service 0x04 — Clear/Reset emission-related diagnostic information	98
8.5 Service 0x05 — Request oxygen sensor monitoring test results	100
8.6 Service 0x06 — Request on-board monitoring test results for specific monitored systems ...	100
8.7 Service 0x07 — Request emission-related diagnostic trouble codes detected during current or last completed driving cycle	110
8.8 Service 0x08 — Request control of on-board system, test or component	111
8.9 Service 0x09 — Request vehicle information	115
8.10 Service 0x0A — Request emission-related diagnostic trouble codes with permanent status	127
Bibliography	129

Foreword

ISO (the International Organization for Standardization) is a worldwide federation of national standards bodies (ISO member bodies). The work of preparing International Standards is normally carried out through ISO technical committees. Each member body interested in a subject for which a technical committee has been established has the right to be represented on that committee. International organizations, governmental and non-governmental, in liaison with ISO, also take part in the work. ISO collaborates closely with the International Electrotechnical Commission (IEC) on all matters of electrotechnical standardization.

International Standards are drafted in accordance with the rules given in the ISO/IEC Directives, Part 2.

The main task of technical committees is to prepare International Standards. Draft International Standards adopted by the technical committees are circulated to the member bodies for voting. Publication as an International Standard requires approval by at least 75 % of the member bodies casting a vote.

Attention is drawn to the possibility that some of the elements of this document may be the subject of patent rights. ISO shall not be held responsible for identifying any or all such patent rights.

ISO 15031-5 was prepared by Technical Committee ISO/TC 22, *Road vehicles*, Subcommittee SC 3, *Electrical and electronic equipment*.

This second edition cancels and replaces the first edition (ISO 15031-5:2006), which has been technically revised.

This part of ISO 15031 is technically equivalent to SAE J1979:2010, with the addition of new capabilities required by revised regulations from the California Air Resources Board and revised regulations from the European Commission.

ISO 15031 consists of the following parts, under the general title *Road vehicles — Communication between vehicle and external equipment for emissions-related diagnostics*:

- *Part 1: General information and use case definition*
- *Part 2: Guidance on terms, definitions, abbreviations and acronyms*
- *Part 3: Diagnostic connector and related electrical circuits, specification and use*
- *Part 4: External test equipment*
- *Part 5: Emissions-related diagnostic services*
- *Part 6: Diagnostic trouble code definitions*
- *Part 7: Data link security*

Introduction

0.1 Overview

ISO 15031 consists of a number of parts which, taken together, provide a coherent self-consistent set of specifications to facilitate emissions-related diagnostics. ISO 15031-1 provides an introduction to the series of International Standards. Parts 2 through 7 are based on SAE recommended practices. This part of ISO 15031 is based on SAE J1979.

This document set includes the communication between the vehicle's On-Board Diagnostic (OBD) systems and test equipment implemented across vehicles within the scope of the legislated emissions-related OBD.

To achieve this, it is based on the Open Systems Interconnection (OSI) Basic Reference Model in accordance with ISO/IEC 7498-1 and ISO/IEC 10731, which structures communication systems into seven layers. When mapped on this model, the services specified by ISO 15031 are broken into the following layers in accordance with Table 1:

- diagnostic services (layer 7), specified in
 - this part of ISO 15031,
 - ISO 27145-3 (WWH-OBD),
- presentation layer (layer 6), specified in
 - ISO 15031-2, SAE J1930-DA,
 - this part of ISO 15031, SAE J1979-DA,
 - ISO 15031-6, SAE J2012-DA,
 - ISO 27145-2, SAE J2012-DA,
- session layer services (layer 5), specified in
 - ISO 14229-2 support ISO 15765-4 DoCAN and ISO 14230-4 DoK-Line protocols,
 - ISO 14229-2 is not applicable to the SAE J1850 and ISO 9141-2 protocols,
- transport layer services (layer 4), specified in
 - ISO 15765-2,
 - SAE J1850 defined in this part of ISO 15031,
 - ISO 9141-2 defined in this part of ISO 15031,
 - ISO 14230-4, defined in this part of ISO 15031,

ISO 15031-5:2011(E)

- network layer services (layer 3), specified in:
 - ISO 15765-2,
 - SAE J1850 defined in this part of ISO 15031,
 - ISO 9141-2 defined in this part of ISO 15031,
 - ISO 14230-4 defined in this part of ISO 15031,
- data link layer (layer 2), specified in:
 - ISO 15765-4, ISO 11898-1, and ISO 11898-2,
 - SAE J1850,
 - ISO 9141-2,
 - ISO 14230-2,
- physical layer (layer 1), specified in:
 - ISO 15765-4, ISO 11898-1, and ISO 11898-2,
 - SAE J1850,
 - ISO 9141-2,
 - ISO 14230-1.

Table 1 — Legislated emissions-related OBD/WWH¹⁾-OBD diagnostic specifications applicable to the OSI layers

Applicability	OSI 7 layers	Emissions-related OBD communication requirements		Emissions-related WWH-OBD communication requirements		
Seven layer according to ISO/IEC 7498-1 and ISO/IEC 10731	Application (layer 7)	ISO 15031-5		ISO 27145-3		
	Presentation (layer 6)	ISO 15031-2, ISO 15031-5, ISO 15031-6		ISO 27145-2		
		SAE J1930-DA/SAE J1979-DA/SAE J2012-DA		SAE J2012-DA		
	Session (layer 5)	ISO 14229-2	Not Applicable		ISO 14229-2	
	Transport (layer 4)	ISO 15765-2	ISO 15031-5			ISO 14230-4
	Network (layer 3)		ISO 15765-4	SAE J1850	ISO 9141-2	
	Data link (layer 2)	ISO 11898-1 ISO 11898-2				
Physical (layer 1)						

1) World-Wide Harmonized.

0.2 SAE document reference concept

ISO 15031 references several SAE documents which contain all terms, data and DTC (diagnostic trouble code) definitions. This is illustrated in Figure 1.

Additional information on the content of the referenced documents is given below:

- SAE J1930: the document is concerned with a procedure for naming objects and systems and with the set of words from which names are built. It references SAE J1930-DA which contains all standardized naming objects, terms and abbreviations.
- SAE J1979: the document is concerned with the definition of emissions-related diagnostic services (diagnostic test modes). It references SAE J1979-DA which contains all standardized data items such as PIDs, Test IDs, Monitor IDs and INFOTYPE IDs.
- SAE J2012: the document is concerned with the procedure for defining emissions-related DTCs. It references SAE J2012-DA which contains all standardized data items such as DTCs and FTBs (failure type bytes).

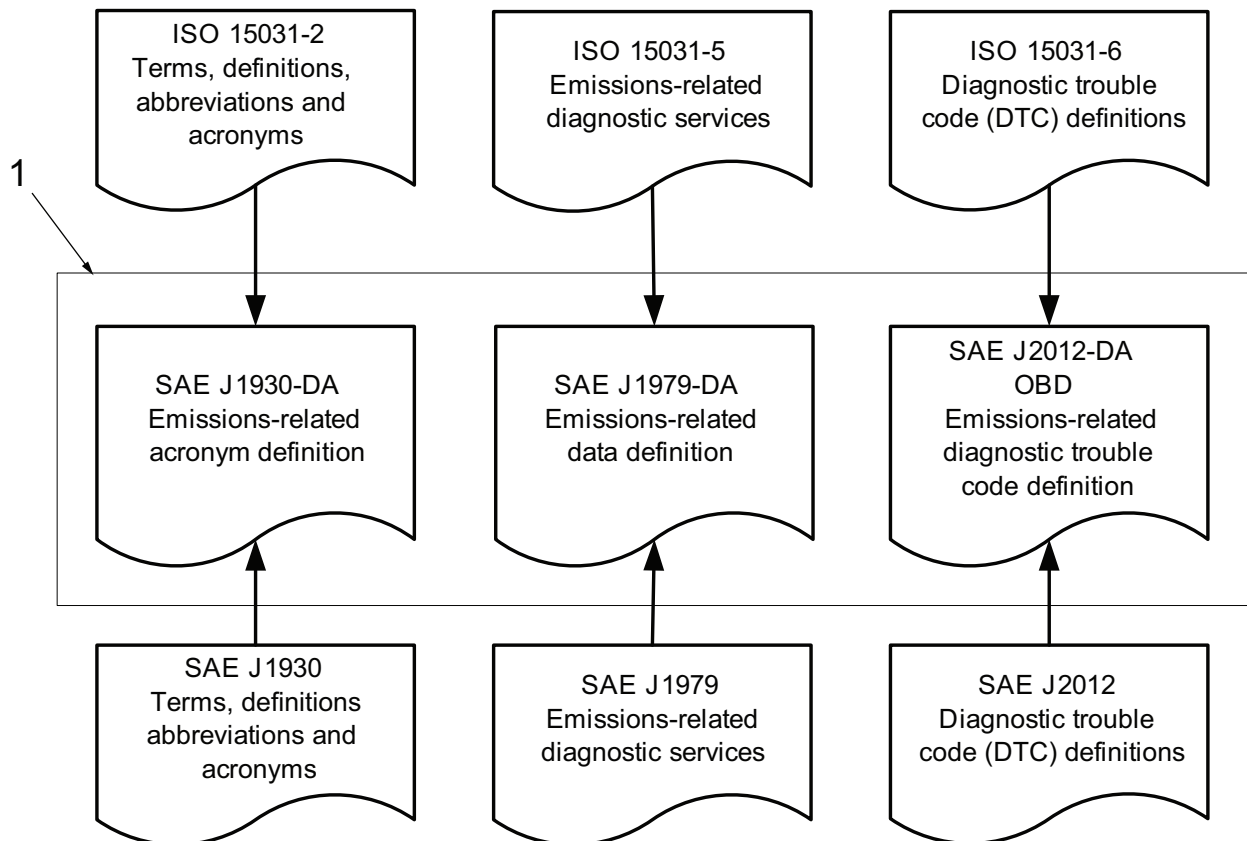

Key

1 SAE Digital Annexes

Figure 1 — SAE Digital Annex document reference

OBD regulations require passenger cars, and light, medium and heavy duty trucks, to support a minimum set of diagnostic information to external (off-board) “generic” test equipment.

ISO 15031-5:2011(E)

0.3 SAE J1979-DA (OBD) Digital Annex

This part of ISO 15031 references SAE J1979-DA. SAE J1979-DA is concerned with the definition of:

- Parameter Identifiers (PIDs),
- Test Identifiers (TIDs),
- OBD Monitor Identifiers (OBDMIDs),
- Unit and Scaling Identifiers (UASIDs), and
- INFOTYPEs (INFOTYPEs).

0.4 SAE Digital Annex revision procedure

New emissions-related regulatory requirements drive new in-vehicle technology to lower emissions. New technology related OBD monitor data and DTCs need to be standardized to support the external (off-board) “generic” test equipment. All relevant information is proposed by the automotive industry represented by members of the appropriate SAE task force.

The revision request form and instructions for updating the registers to this part of ISO 15031 can be obtained on the Registration Authority's website at:

<http://www.sae.org/servlets/works/committeeHome.do?comtID=TEVDS14>

The column titled “Resources” shows a document with the title: J1979-DA_Revision_Request_Form.doc. Double click on the name and you will be asked to download the document with the file name:

SAE_J1979-DA_Revision_Request_Form.doc

Fill out the revision request form with your request.

Please send an e-mail with the completed revision request form as an attachment to:

SAE Headquarters
755 West Big Beaver Road
Suite 1600
Troy, MI 48084-4093, USA
Fax: +1 (248) 273-2494
Email: saej1979@sae.org

Road vehicles — Communication between vehicle and external equipment for emissions-related diagnostics —

Part 5: Emissions-related diagnostic services

1 Scope

This part of ISO 15031 is intended to satisfy the data reporting requirements of On-Board Diagnostic (OBD) regulations in the United States and Europe, and any other region that may adopt similar requirements in the future. This part of ISO 15031 specifies:

- a) message formats for request and response messages,
- b) timing requirements between request messages from external test equipment and response messages from vehicles, and between those messages and subsequent request messages,
- c) behaviour of both the vehicle and external test equipment if data is not available,
- d) a set of diagnostic services, with corresponding content of request and response messages, to satisfy OBD regulations.

This part of ISO 15031 includes capabilities required to satisfy OBD requirements for multiple regions, model years, engine types, and vehicle types. Those regulations are not yet final for some regions, and are expected to change in the future. This part of ISO 15031 makes no attempt to interpret the regulations and does not include applicability of the included diagnostic services and data parameters for various vehicle applications. The user of this part of ISO 15031 is responsible for verifying the applicability of each clause of this part of ISO 15031 for a specific vehicle, engine, model year and region.

This part of ISO 15031 specifies diagnostic services and functionally addressed request/response messages required to be supported by motor vehicles and external test equipment for diagnostic purposes which pertain to motor vehicle emission-related data. Any external test equipment meeting the requirements of ISO 15031-4 use these messages to retrieve emissions-related information from the vehicle.

Each clause in this part of ISO 15031 which specifies additional details to existing sections of ISO 9141-2, ISO 14230-4, SAE J1850, and ISO 15765-4 supersede those specifications.

This part of ISO 15031 references SAE J1979-DA (Digital Annex), which includes all definitions of PIDs, OBDMIDs, TIDs and INFOTYPES.

This part of ISO 15031 provides the mechanism to satisfy the requirements included in the country-specific regulations and not all capabilities included in this part of ISO 15031 are required by the country-specific regulations. This part of ISO 15031 is not considered a final authority for interpretation of the regulations. Therefore readers should determine the applicability of capabilities defined in this part of ISO 15031 for their own specific needs.

2 Normative references

The following referenced documents are indispensable for the application of this document. For dated references, only the edition cited applies. For undated references, the latest edition of the referenced document (including any amendments) applies.

ISO/IEC 7498-1, *Information technology — Open Systems Interconnection — Basic Reference Model: The Basic Model*

ISO/IEC 10731, *Information technology — Open Systems Interconnection — Basic Reference Model — Conventions for the definition of OSI services*

ISO 9141-2:1994, *Road vehicles — Diagnostic systems — Part 2: CARB requirements for interchange of digital information*

ISO 14229-2²⁾, *Road vehicles — Unified diagnostic services (UDS) — Part 2: Session layer services*

ISO 14230-2, *Road vehicles — Diagnostic systems — Keyword Protocol 2000 — Part 2: Data link layer*

ISO 14230-4:2000, *Road vehicles — Diagnostic systems — Keyword Protocol 2000 — Part 4: Requirements for emission-related systems*

ISO 15765-2, *Road vehicles — Diagnostics on Controller Area Networks (CAN) — Part 2: Network layer services*

ISO 15765-4, *Road vehicles — Diagnostics on Controller Area Networks (CAN) — Part 4: Requirements for emissions-related systems*

ISO 15031-1, *Road vehicles — Communication between vehicle and external equipment for emissions-related diagnostics — Part 1: General information and use case definition*

ISO 15031-2, *Road vehicles — Communication between vehicle and external equipment for emissions-related diagnostics — Part 2: Guidance on terms, definitions, abbreviations, and acronyms*

ISO 15031-3, *Road vehicles — Communication between vehicle and external equipment for emissions-related diagnostics — Part 3: Diagnostic connector and related electrical circuits, specification and use*

ISO 15031-4, *Road vehicles — Communication between vehicle and external equipment for emissions-related diagnostics — Part 4: External test equipment*

ISO 15031-6, *Road vehicles — Communication between vehicle and external equipment for emissions-related diagnostics — Part 6: Diagnostic trouble code definitions*

SAE J1930-DA, *Digital Annex of Electrical/Electronic Systems Diagnostic Terms, Definitions, Abbreviations, and Acronyms*

SAE J1979-DA, *Digital Annex of E/E Diagnostic Test Modes*

SAE J2012-DA, *Digital Annex of Diagnostic Trouble Code Definitions and Failure Type Byte Definitions*

2) To be published.

3 Terms, definitions and abbreviated terms

3.1 Terms and definitions

For the purposes of this document, the terms and definitions given in ISO 14229-2, ISO 14230-2, ISO 15031-2 and ISO 15765-2 and the following apply.

3.1.1

absolute throttle position sensor

value intended to represent the throttle opening

NOTE For systems where the output is proportional to the input voltage, this value is the percent of maximum input signal. For systems where the output is inversely proportional to the input voltage, this value is 100 % minus the percent of maximum input signal. Throttle position at idle usually indicates greater than 0 %, and throttle position at wide open throttle usually indicates less than 100 %.

3.1.2

bank

specific group of cylinders sharing a common control sensor

NOTE 1 Bank 1 always contains cylinder number 1 and bank 2 the opposite bank.

NOTE 2 If there is only one bank, the DTCs for bank #1 DTCs are used, and the word bank may be omitted. With a single "bank" system utilizing multiple sensors, bank #1 DTCs are used identifying the sensors as #1, #2, and #3 in order as they move further away from the cylinder.

3.1.3

base fuel schedule

fuel calibration schedule programmed into the Powertrain Control Module or PROM when manufactured or when updated by an off-board source, prior to any learned on-board correction

3.1.4

calculated load value

(spark ignition vehicles) typically an indication of the current airflow divided by peak airflow at wide open throttle as a function of rpm, where airflow is corrected for altitude and ambient temperature

NOTE 1 Both spark ignition and compression ignition vehicles can use an alternate definition that substitutes engine torque in place of airflow in the calculation.

NOTE 2 This definition provides a number (without unit) and provides the service technician with an indication of the percent engine capacity that is being used.

3.1.5

client

function that is part of the tester and that makes use of the diagnostic services

NOTE A tester normally makes use of other functions such as database management, specific interpretation, and man-machine interface.

3.1.6

continuous monitoring

sampling at a rate no fewer than two samples per second

NOTE If, for control purposes, a computer input is sampled less frequently, the signal of the component may instead be evaluated each time sampling occurs.

**3.1.7
convention
Cvt**

column integrated in each message table which marks each parameter included

NOTE The following conventions are used: C = Conditional: the parameter marked "C" in a request/response message is present only under a condition specified in the bottom row of the message table. M = Mandatory: the parameter marked "M" in a request/response message table is always present. U = User (optional): the parameter marked "U" in a request/response message table is supplied depending on dynamic usage by the manufacturer. The convention recommends a mnemonic, which might be used for implementation. In no case is the specified mnemonic ever a mandatory requirement for any implementation.

**3.1.8
electronic control unit
ECU**

generic term for any electronic control unit

**3.1.9
emissions-related DTC**

DTC which is set when a malfunction causes vehicle emissions to exceed legislated emission thresholds or is otherwise required to be set as specified by on-board diagnostics legislation (e.g. disables another part of the diagnostic system)

NOTE Normally, the malfunction indicator (MI) is illuminated at the same time as the emissions-related DTC is set. The determination of which DTCs are emissions-related is made by the vehicle manufacturer for each vehicle, as specified by on-board diagnostic legislation.

**3.1.10
fuel trim
FT**

feedback adjustments to the base fuel schedule

NOTE Short-term fuel trim refers to dynamic or instantaneous adjustments. Long-term fuel trim refers to much more gradual adjustments to the fuel calibration schedule than short-term trim adjustments. These long-term adjustments compensate for vehicle differences and gradual changes that occur over time.

**3.1.11
negative numbers**

signed binary, the most significant bit (MSB) of the binary number used to indicate positive (0) / negative (1)

NOTE 1 2s complement: negative numbers are represented by complementing the binary number and then adding 1.

EXAMPLE - 0,99 = 8001 hex = 1000 0000 0000 0001 binary
 0 = 0x0000 = 0000 0000 0000 0000 binary
 + 0,99 = 0x7FFF = 0111 1111 1111 1111 binary

NOTE 2 (- 0,99) + (+ 0,99) = 0.

**3.1.12
number**

expressed by this symbol "#"

**3.1.13
P2, P3 timing parameter**

application timing parameters for the ECU(s) and the external test equipment

3.1.14**P2_{CAN_min} timing parameter**

CAN application timing parameter with the minimum value for the ECU(s) and the external test equipment to start the response message

3.1.15**P2_{CAN_max} timing parameter**

CAN application timing parameter with the maximum value for the ECU(s) and the external test equipment to indicate a response message

3.1.16**P2_{reload} timing parameter**

CAN application timing parameter with the maximum value (P2_{CAN_max}) for external test equipment only

3.1.17**server**

function that is part of an ECU that provides the diagnostic services

NOTE This part of ISO 15031 differentiates between the server, i.e. the function, and the electronic control unit so that it remains independent from the implementation.

3.1.18**service**

information exchange initiated by a client (external test equipment) in order to require diagnostic information from a server (ECU) and/or to modify its behavior for diagnostic purposes

NOTE This is also the equivalent of test mode or mode.

3.2 Abbreviated terms

.con	confirmation
.ind	indication
.req	request
CRC	cyclic redundancy check
CVN	calibration verification number
DTC	diagnostic trouble code
ECM	engine control module
ERR	error detection byte
EWMA	exponential weighted moving average
FF	first frame
ISR	interrupt service routine
LSB	least significant bit
MI	malfunction indicator
MIL	malfunction indicator light
MSB	most significant bit
N_PDU	network protocol data unit
N/A	not applicable
NRC	negative response code
NVRAM	non-volatile memory
OBDMID OBD	monitor identifier

ISO 15031-5:2011(E)

PID	parameter identifier
PCI	protocol control information
RSP	in-frame response
SF	single frame
SOM	start of message
T_AE	virtual transport interface address extension
T_Data []	virtual transport interface data field
T_Mtype	virtual transport interface message type
T_Length	virtual transport interface length information
T_PDU	virtual transport interface protocol data unit
T_Result	virtual transport interface result
T_SA	virtual transport interface source address
T_TA	virtual transport interface target address
T_TAtype	virtual transport interface target address type
TCM	transmission control module
TID	test identifier
UASID	unit and scaling identifier
VIN	vehicle identification number

4 Conventions

ISO 15031 is based on the conventions specified in the OSI Service Conventions (ISO/IEC 10731) as they apply for diagnostic services.

5 Document overview

Figure 2 illustrates the emissions-related OBD in ISO 15765-4, SAE J1850, ISO 9141-2, and ISO 14230-4. The protocol initialization identifies whether ISO 15765-4 DoCAN or SAE J1850 or ISO 14230-4 DoK-Line or ISO 9141-2 is the data link layer supported by the vehicle. ISO 15031 references the standards as an applicable data link for emissions-related OBD.

This part of ISO 15031 specifies the applicable emissions-related diagnostic services. It specifies the data record structures and references SAE J1930-DA, SAE J1979-DA and SAE J2012-DA which include all emissions-related OBD data definitions.

6 Technical requirements

6.1 General requirements

The requirements specified in this clause are necessary to ensure proper operation of both the external test equipment and the vehicle during diagnostic procedures. External test equipment, when using the messages specified, shall not affect normal operation of the emission control system.

IMPORTANT — New emissions-related vehicle technology required the definition of new PIDs and INFOTYPES. The data parameter set for several new definitions exceed the specified limit of message length for ISO 9141-2, ISO 14230-4 and SAE J1850 protocols. It is the vehicle manufacturer's

responsibility to implement the ISO 15765-4 DoCAN protocol in order to achieve legislative compliance of the emissions-related OBD systems in the vehicle.

6.2 Diagnostic service requirements

6.2.1 Multiple responses to a single data request

The request messages are functional messages, which means that the external test equipment will request data without knowledge of which ECU(s) on the vehicle will respond. In some vehicles, multiple ECUs may respond with the information requested. Any external test equipment requesting information shall therefore have provisions for receiving multiple responses.

IMPORTANT — All emissions-related OBD ECUs, which at least support one of the services defined in this part of ISO 15031, shall support service 0x01 and PID 0x00. Service 0x01 with PID 0x00 is defined as the universal “initialization/keep alive/ping” message for all emissions-related OBD ECUs.

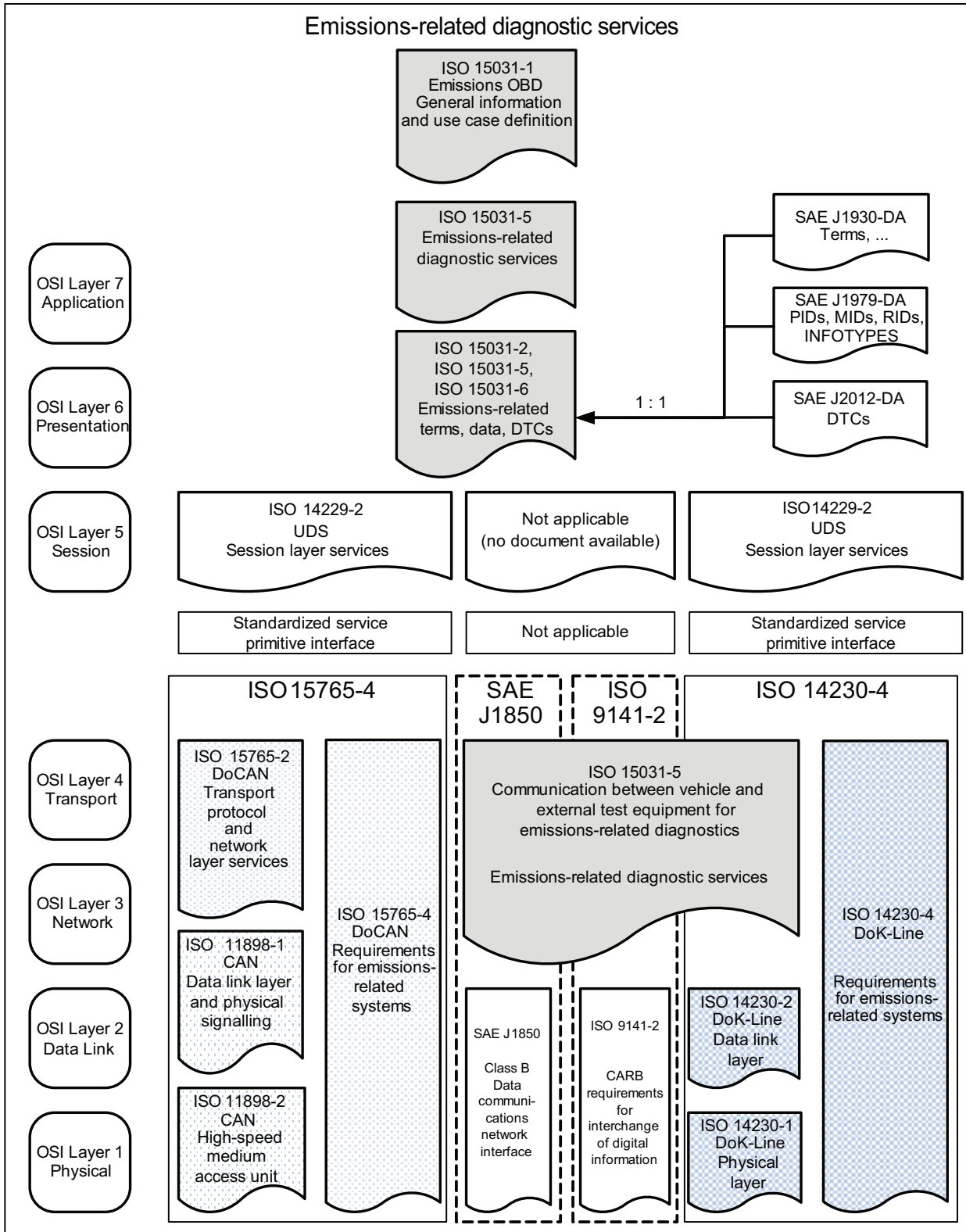

Figure 2 — Emissions-related OBD in ISO 15765-4, SAE J1850, ISO 9141-2, and ISO 14230-4 according to OSI model

6.2.2 Application timing parameter definition

6.2.2.1 Overview

The definition of P2 and P3 is included in this clause. A subscript is added to each timing parameter to identify the protocol:

- P2_{K-line}, P3_{K-line}: P2, P3 for ISO 9141-2 and ISO 14230-4 protocols
- P2_{J1850}: P2 for SAE J1850 protocol
- P2_{CAN}: P2 for ISO 15765-4 protocol

IMPORTANT — The vehicle manufacturer is responsible for specifying a shorter P2 timing window than specified in this part of ISO 15031 for each emission-related server/ECU in the vehicle in order to make sure that network topology delays of the vehicle architecture are considered.

6.2.2.2 Definition for ISO 9141-2

For ISO 9141-2 interfaces, data link layer response time requirements (P1, P4) are specified in ISO 9141-2.

Table 2 specifies the application timing parameter values for P2 and P3.

Table 2 — Definition of ISO 9141-2 application timing parameter values

Parameter	Minimum value ms	Maximum value ms	Description
P2 _{K-line} Key Bytes: 0x08 0x08	25	50	Time between external test equipment request message and the transmission of the ECU(s) response message(s). Each OBD ECU shall start sending its response message within P2 _{K-line} after the request message has been correctly received. Subsequent response messages shall also be transmitted within P2 _{K-line} of the previous response message for multiple message responses.
P2 _{K-line} Key Bytes: 0x94 0x94	0	50	Time between external test equipment request message and the transmission of the ECU response message(s). The OBD ECU shall start sending its response message within P2 _{K-line} after the request message has been correctly received. Subsequent response messages shall also be transmitted within P2 _{K-line} of the previous response message for multiple message responses.
P3 _{K-line}	55	5000	Time between the end of an ECU(s) successful transmission of response message(s) and start of new external test equipment request message. The external test equipment may send a new request message if all response messages related to the previously sent request message have been received and if P3 _{K-line} minimum time has expired. ECU implementation guideline: TX (transmit) and RX (receive) lines are connected. Each transmitted byte is read back by the receiver in the ECU. Upon the reception of a received byte, e.g. last byte of a request message (checksum) from the tester, the ECU shall reset the P3 timer value to zero. If the ECU supports the request message, it will start transmitting the response message within the P2 timing window. Each transmitted byte will cause the P3 timer value to be reset. If the ECU does not support the request and does not send a response message, then in a single OBD ECU system the P3 is started after the last byte received of the request message. In a multiple OBD ECU system a response message by one or more ECUs shall cause the P3 timer value to be reset in all ECUs including any ECU not supporting the request message.

6.2.2.3 Definition for ISO 14230-4

For ISO 14230-4 interfaces, data link layer response time requirements are specified in ISO 14230-4.

Table 3 specifies the application timing parameter values for P2 and P3.

Table 3 — Definitions of ISO 14230-4 application timing parameter values

Parameter	Minimum value ms	Maximum value ms	Description
P2 _{K-line}	25	50	Time between external test equipment request message and the transmission of the ECU(s) response message(s). Each OBD ECU shall start sending its response message within P2 _{K-line} after the request message has been correctly received. Subsequent response messages shall also be transmitted within P2 _{K-line} of the previous response message for multiple message responses.
P3 _{K-line}	55	5000	Time between the end of an ECU(s) successful transmission of response message(s) and start of new external test equipment request message. The external test equipment may send a new request message if all response messages related to the previously sent request message have been received and if P3 _{K-line} minimum time has expired. ECU implementation guideline: TX (transmit) and RX (receive) line are connected. Each transmitted byte is read back by the receiver in the ECU. Upon the reception of a received byte, e.g. last byte of a request message (checksum) from the tester, the ECU shall reset the P3 timer value to zero. If the ECU supports the request message, it will start transmitting the response message within the P2 timing window. Each transmitted byte will cause the P3 timer value to be reset. If the ECU does not support the request and does not send a response message, then in a single OBD ECU system, the P3 is started with the last byte received of the request message. In a multiple OBD ECU system, a response message by any one or more ECUs shall cause the P3 timer value to be reset in all ECUs including any ECU not supporting the request message.

6.2.2.4 Data link layer interface adaptation

6.2.2.4.1 General information

This part of ISO 15031 makes use of the data link layer services defined in ISO 14230-2 for the transmission and reception of diagnostic messages. This section defines the mapping of the virtual data link PDU (T_PDU) in ISO 14229-2 onto the K-Line data link layer PDU (DL_PDU) in ISO 14230-2.

NOTE The data link layer services are used to perform the application layer and diagnostic session management timing.

6.2.2.4.2 Mapping of data link independent service primitives onto K-Line data link dependent service primitives

Table 4 specifies the mapping interface between the ISO 14230-2 DoK-Line Part 2: Data link layer services and the ISO 14229-2 UDS Part 2.

Table 4 — Mapping of T_PDU service primitives onto DL_PDU service primitives

transport/network layer service primitives (data link independent according to ISO 14229-2)	DoK-Line data link layer service primitives (data link dependent according to ISO 14230-2)
T_Data.indication	DL_Data.indication
T_DataSOM.indication	DL_DataFB.indication
T_Data.confirm	DL_Data.confirm
T_Data.request	DL_Data.request

6.2.2.4.3 Mapping of T_PDU onto DL_PDU for message transmission

The parameters of the application layer protocol data unit defined to request the transmission of a diagnostic service request/response are mapped in accordance with Table 5 onto the parameters of the data link layer protocol data unit for the transmission of a message in the client/server.

Table 5 — Mapping of T_PDU parameter onto DL_PDU parameter

T_PDU parameter (data link independent according to ISO 14229-2)	DL_PDU parameter (DoK-Line data link dependent according to ISO 14230-2)
T_Mtype	N/A (always set to "diagnostics")
T_SA	DL_SA
T_TA	DL_TA
T_TAtype	DL_TAtype
T_AE	N/A
T_Data []	<MessageData>
T_Length	<Length>
T_Result	<DL_Result>

6.2.2.5 Implementation guidance example for ISO 9141-2 and ISO 14230-4 protocols

This subclause provides an implementation example for client/external test equipment and server/ECU. It is assumed that the client (external test equipment) communicates to a vehicle with two (2) emission-related OBD servers (ECUs). The client requests a CVN, which is only supported by server #1 (ECU#1) with two (2) response messages. Server #2 (ECU#2) is not flash programmable. Figure 3 graphically depicts the timing handling in the client and two (2) servers for a functionally addressed request message. A description following Figure 3 references the points marked in the figure.

From a server point of view, there is no difference in the timing handling compared to a physically addressed request message. The server shall reset the $P3_{K\text{-line}}$ timer value on each received byte regardless of whether the byte is part of a request message or a response message from any other server or an echo from its transmit line. There are several methods in which a server can implement the timing handling. The implementation of timing parameters is not part of this part of ISO 15031 but has an important system supplier responsibility. Some general server timing parameter implementation guidelines are described in this subclause. The server time stamps each receiver interrupt event and restarts/resets the $P3_{K\text{-line_server}}$ timer or timing value, e.g. ISR time stamps received byte, and processing of the received information is performed outside the ISR. For simplification of the diagram, Figure 3 only shows a $P3_{K\text{-line_server}}$ restart after the reception of the first byte and last byte (checksum) of a received message. The $P3_{K\text{-line_server}}$ restart is required on each received byte. The received message can be either a request message from the client or a response message from any other server connected and initialized by the 0x33 address. If the server has received a complete message, it compares the target address with the 0x33 address.

Figure 3 shows the client and two (2) initialized servers connected via K-line (either ISO 9141-2 or ISO 14230-4 protocol). The relevant events for the client and both servers are marked and described.

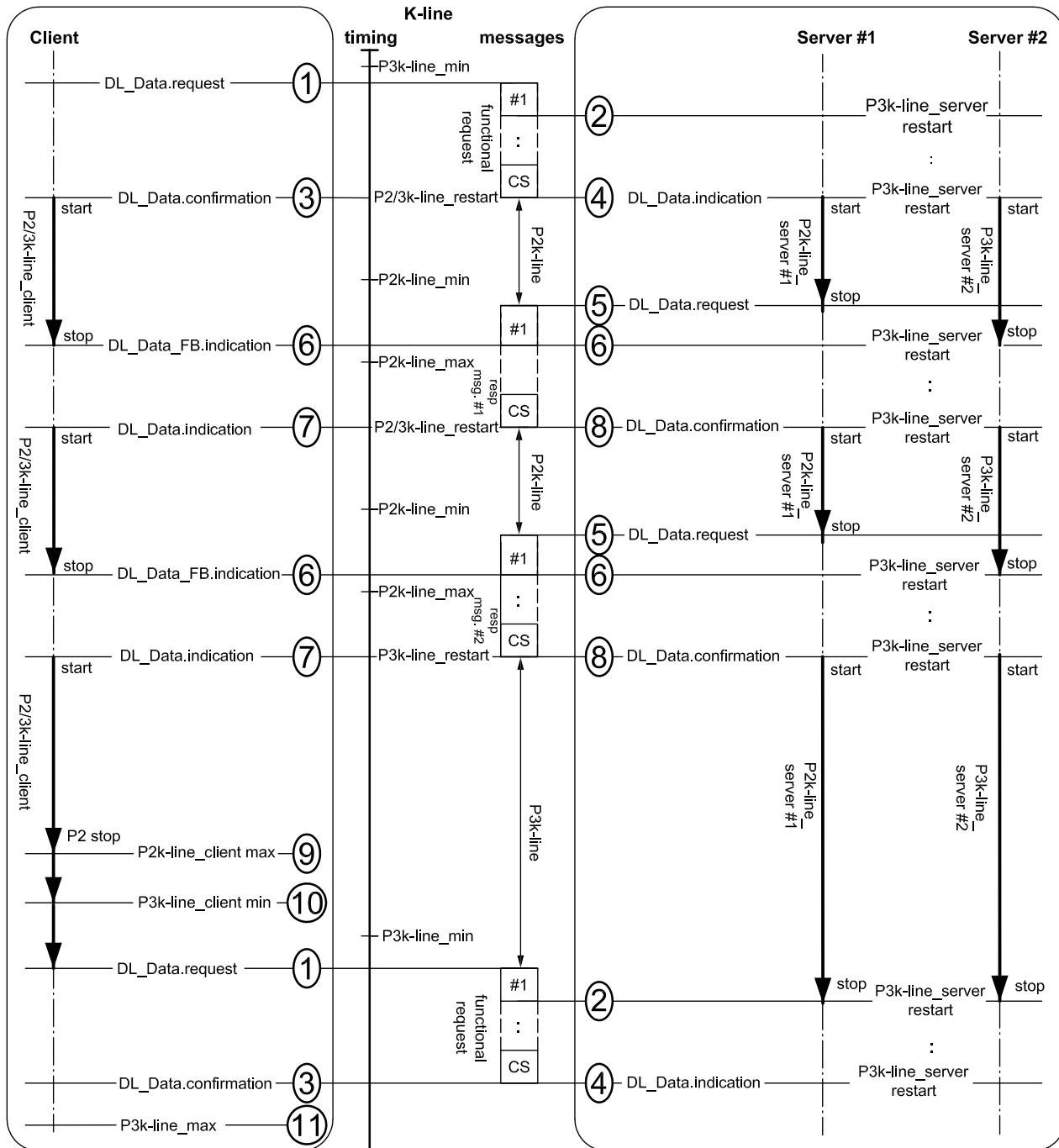

- 1 The diagnostic application of the client starts the transmission of a functionally addressed request message by issuing a T_Data.request to its data link layer. The data link layer transmits the request message to the servers.
- 2 Both servers and the client receive a byte of a message via a receive interrupt by the UART. The ISR (interrupt service routine) either restarts the P2_{K-line}/P3_{K-line} timers or time stamps the received byte.
- 3 The completion of the request message is indicated in the client with T_Data.confirmation. When receiving the T_Data.confirmation, the client starts its P2_{K-line} and P3_{K-line} timer, using the default reload values P2_{K-line_max} and P3_{K-line_max}.
- 4 If the last message byte is received, each server checks whether the received message includes a target address which matches the 0x33 address. If the result is a match (server #1 and #2), then the completion of the request message is indicated in the servers via T_Data.indication and each server determines whether it supports the request and has a message available to respond with. If a server determines that the address in the received message is different from 0x33, or if the address is a match but no response needs to be sent (server #2), the P2 timer is stopped. Since the P3_{K-line} timer has already been restarted, no further action is required. If a response message is available and has to be sent (server #1, but not server #2), then the transmission of the response message shall be started after P2_{K-line_min} timing is expired.
- 5 Server #1 starts the response message by indicating a T_Data.request from the application to the data link layer and at the same time stops its P2_{K-line} timer.

- 6 Both servers and the client receive a byte of a message via a receive interrupt by the UART. The ISR (interrupt service routine) restarts the $P2_{K\text{-line}}$ / $P3_{K\text{-line}}$ timers or time stamps the received byte and the client issues a $T_Data_FB.indication$ to the application layer.
- 7 The completion of the response message is indicated in the client with $T_Data.indication$. When receiving the $T_Data.indication$, the client starts its $P2_{K\text{-line}}$ and $P3_{K\text{-line}}$ timer, using the default reload values $P2_{K\text{-line_max}}$ and $P3_{K\text{-line_max}}$.
- 8 Both servers have received the last byte of a message via a receive interrupt by the UART. The ISR (interrupt service routine) either resets the $P2_{K\text{-line}}$ / $P3_{K\text{-line}}$ timers or time stamps the received byte. The completion of the response message (e.g. length and checksum check) is indicated in server #1 via $T_Data.confirmation$. If server #1 does not want to send further response messages, it stops its $P2$ timer. In server #2 the message is received and the $P3_{K\text{-line}}$ timer is restarted, but no $T_Data.indication$ is forwarded to the application because the target address does not match the 0x33 (target address of this message is the tester address 0xF1).
- 9 The client application detects a $P2_{K\text{-line_max}}$ timeout, which indicates that all response messages from all servers are received.
- 10 The client application indicates that $P3_{K\text{-line_min}}$ is reached and that the $P3_{K\text{-line}}$ timing window is now open to send a new request message (see 1).
- 11 $P3_{K\text{-line_max}}$ timeout indicates that the client is required to start a new initialization prior to sending a new request message.

Figure 3 — ISO 9141-2 and ISO 14230-4 protocol client and server timing behaviour

6.2.2.6 Definition for SAE J1850

For SAE J1850 network interfaces, the on-board systems shall respond to a request within $P2_{J1850}$ of a request or a previous response message. With multiple response messages possible from a single request message, this allows as much time as is necessary for all ECUs to access the data link and transmit their response message(s). If there is no response message within this time period, the external test equipment can either assume no response message will be received, or if a response message has already been received, that no more response messages will be received. The application timing parameter value $P2_{J1850}$ is specified in Table 6.

Table 6 — Definition of SAE J1850 application timing parameter values

Parameter	Minimum value ms	Maximum value ms	Description
$P2_{J1850}$	0	100	Time between external test equipment request message and the successful transmission of the ECU(s) response message(s). Each OBD ECU shall attempt to send its response message (or at least the first of multiple response messages) within $P2_{J1850}$ after the request message has been correctly received. Subsequent response messages shall also be transmitted within $P2_{J1850}$ of the previous response message for multiple message responses.

6.2.2.7 Definition for ISO 15765-4

For CAN bus systems based on ISO 15765-4, the (all) responding ECU(s) of the on-board system shall start the response message to a request message within P2_{CAN}. Table 7 specifies the application timing parameter values for P2.

Table 7 — Definition of ISO 15765-4 application timing parameter values

Parameter	Minimum value P2 _{CAN_min} ms	Maximum value P2 _{CAN_max} ms	Description
P2 _{CAN}	0	50	<p>This is a system-wide parameter related to diagnostic response times. Each server (ECU) is required to respond to a request between P2_{CAN_min} and P2_{CAN_max}.</p> <p>A client (tester) shall wait for at least P2_{CAN_max} for the single-frame (SF) or first-frame (FF) of a response.</p> <p>P2_{CAN} is the time until the first indication of a multiple-frame response message (FirstFrame). The client shall not process the response until the complete message (last ConsecutiveFrame) has been received.</p> <p>For clients (testers) which also support UDSONCAN for enhanced diagnostics, a P2_{reload} mechanism is required. Upon receiving the SF or FF, the client (tester) shall reload its P2_{CAN} timer with a value of at least P2_{CAN_max} and restart the timer. Once the client's (tester's) P2_{CAN} timer expires without receiving a SF or FF, the client (tester) may assume no more responses are forthcoming.</p>
P2* _{CAN}	0	5000	<p>Time between the successful reception of a negative response message with NRC 0x78 and the next response message (positive or negative message).</p> <p>See Table 11 for which service a negative response message with NRC 0x78 shall not be used as a response message.</p>

NOTE The network layer timing parameters for the multiple-frame response are not shown. Network layer timing requirements for legislated diagnostic messages are specified in ISO 15765-4.

6.2.2.8 Transport/Network layer interface adaptation

6.2.2.8.1 General information

This part of ISO 15031 makes use of the network layer services defined in ISO 15765-2 for the transmission and reception of diagnostic messages. This section defines the mapping of the virtual data link PDU (T_PDU) onto the independent transport/network layer protocol data units of the CAN data link specific network layer (N_PDU).

NOTE The transport/network layer services are used to perform the application layer and diagnostic session management timing.

6.2.2.8.2 Mapping of data link independent service primitives onto CAN data link dependent service primitives

Table 8 specifies the mapping interface between the ISO 15765-2 DoCAN Part 2 and the ISO 14229-2 UDS Part 2.

Table 8 — Mapping of T_PDU service primitives onto N_PDU service primitives

transport/network layer service primitives (data link independent according to ISO 14229-2)	DoCAN network layer service primitives (data link dependent according to ISO 15765-2)
T_Data.indication	N_USData.indication
T_DataSOM.indication	N_USDataFF.indication
T_Data.confirm	N_USData.confirm
T_Data.request	N_USData.request

6.2.2.8.3 Mapping of T_PDU onto N_PDU for message transmission

The parameters of the application layer protocol data unit defined to request the transmission of a diagnostic service request/response are mapped in accordance with Table 9 onto the parameters of the network layer protocol data unit for the transmission of a message in the client/server.

The network layer confirmation of the successful transmission of the message (N_USData.con) is forwarded to the application, because it is needed in the application for starting those actions, which shall be executed immediately after the transmission of the request/response message (ECUReset, BaudrateChange, etc.).

Table 9 — Mapping of T_PDU parameter onto N_PDU parameter

T_PDU parameter (data link independent according to ISO 14229-2)	N_PDU parameter (CAN data link dependent according to ISO 15765-2)
T_Mtype	N_Mtype
T_SA	N_SA
T_TA	N_TA
T_TAtype	N_TAtype
T_AE	N_AE
T_Data []	<MessageData>
T_Length	<Length>
T_Result	<N_Result>

6.2.2.9 Implementation guidance example for ISO 15765-4 protocol

6.2.2.9.1 Functional OBD communication during default session

Figure 4 graphically depicts the timing handling in the client and three servers for a functionally addressed request message during the default session. A description following Figure 4 references the points marked in the figure.

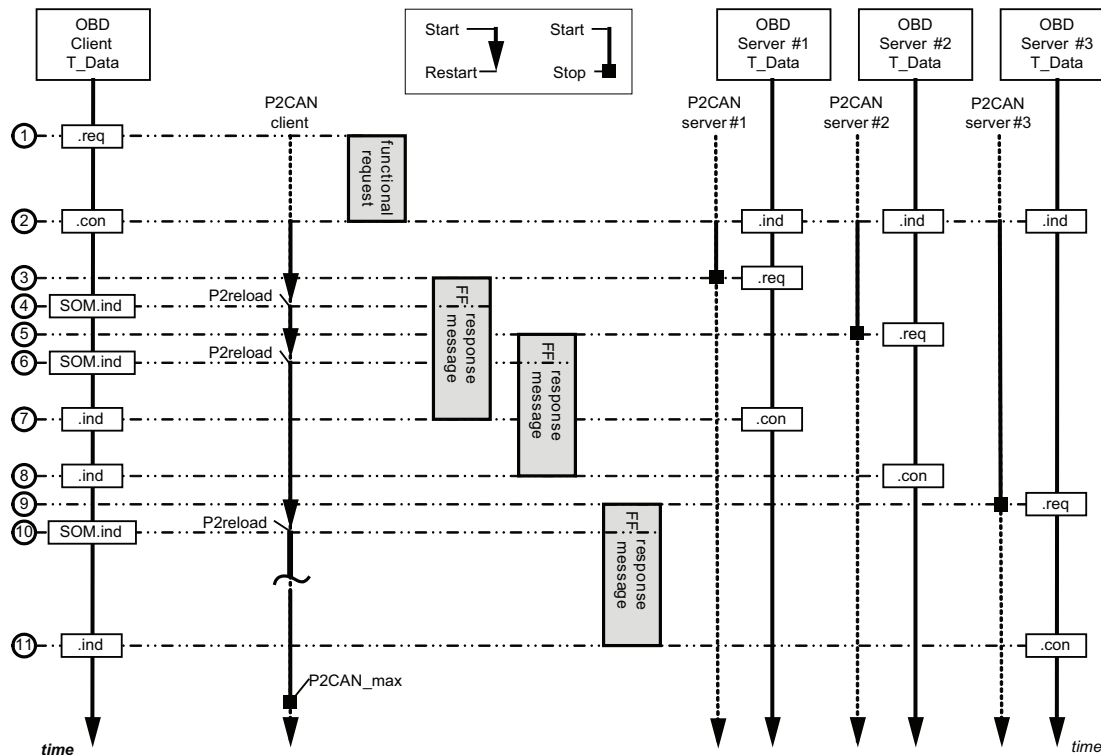

- 1 **Client T_Data.req:** diagnostic application issues functionally addressed request message to network layer.
- 2 **All server T_Data.ind:** network layer issues to diagnostic application the reception of a request message. All servers start the $P2_{CAN}$ timer using the value of $P2_{CAN} = P2_{CAN_max}$.
Client T_Data.con: network layer issues to diagnostic application the confirmation of the completion of the request message. Client starts its $P2_{CAN_Client}$ timer using the default reload value $P2_{CAN} = P2_{CAN_max}$.
- 3 **Server #1 T_Data.req:** diagnostic application has prepared the response message and issues a T_Data.req to network layer within $P2_{CAN}$. The response message can be a multi-frame or single-frame response message.
- 4 **Client T_DataSOM.ind:** network layer issues to diagnostic application the reception of a StartOfMessage which is initiated by the reception of a FirstFrame indication on CAN (see ISO 15765-2). Reload $P2_{CAN}$ with $P2_{CAN_max}$ value.
- 5 **Server #2 T_Data.req:** diagnostic application has prepared the response message and issues a T_Data.req to network layer within $P2_{CAN}$. The response message can be a multi-frame or single-frame response message.
- 6 **Client T_DataSOM.ind:** network layer issues to diagnostic application the reception of a StartOfMessage which is initiated by the reception of a FirstFrame indication on CAN (see ISO 15765-2). Reload $P2_{CAN}$ with $P2_{CAN_max}$ value.
- 7 **Server #1 T_Data.con:** network layer issues to diagnostic application the completion of the response message.
Client T_Data.ind: network layer issues to diagnostic application the completion of the response message.
- 8 **Server #2 T_Data.con:** network layer issues to diagnostic application the completion of the response message.
Client T_Data.ind: network layer issues to diagnostic application the completion of the response message.
- 9 **Server #3 T_Data.req:** diagnostic application has prepared the response message and issues a T_Data.req to network layer within $P2_{CAN}$. The response message can be a multi-frame or single-frame response message.
- 10 **Client T_DataSOM.ind:** network layer issues to diagnostic application the reception of a StartOfMessage which is initiated by the reception of a FirstFrame indication on CAN (see ISO 15765-2). Reload $P2_{CAN}$ with $P2_{CAN_max}$ value.
- 11 **Server #2 T_Data.con:** network layer issues to diagnostic application the completion of the response message.
Client T_Data.ind: network layer issues to diagnostic application the completion of the response message.

Figure 4 — Functional OBD communication — Default response timing

6.2.2.9.2 Functional OBD communication with enhanced response timing

Figure 5 illustrates the timing handling in the client and three (3) servers for a functionally addressed request message during the default session, where one server requests an enhanced response timing via a negative response message including a negative response code (NRC) 0x78. A description following Figure 5 references the points marked in the figure.

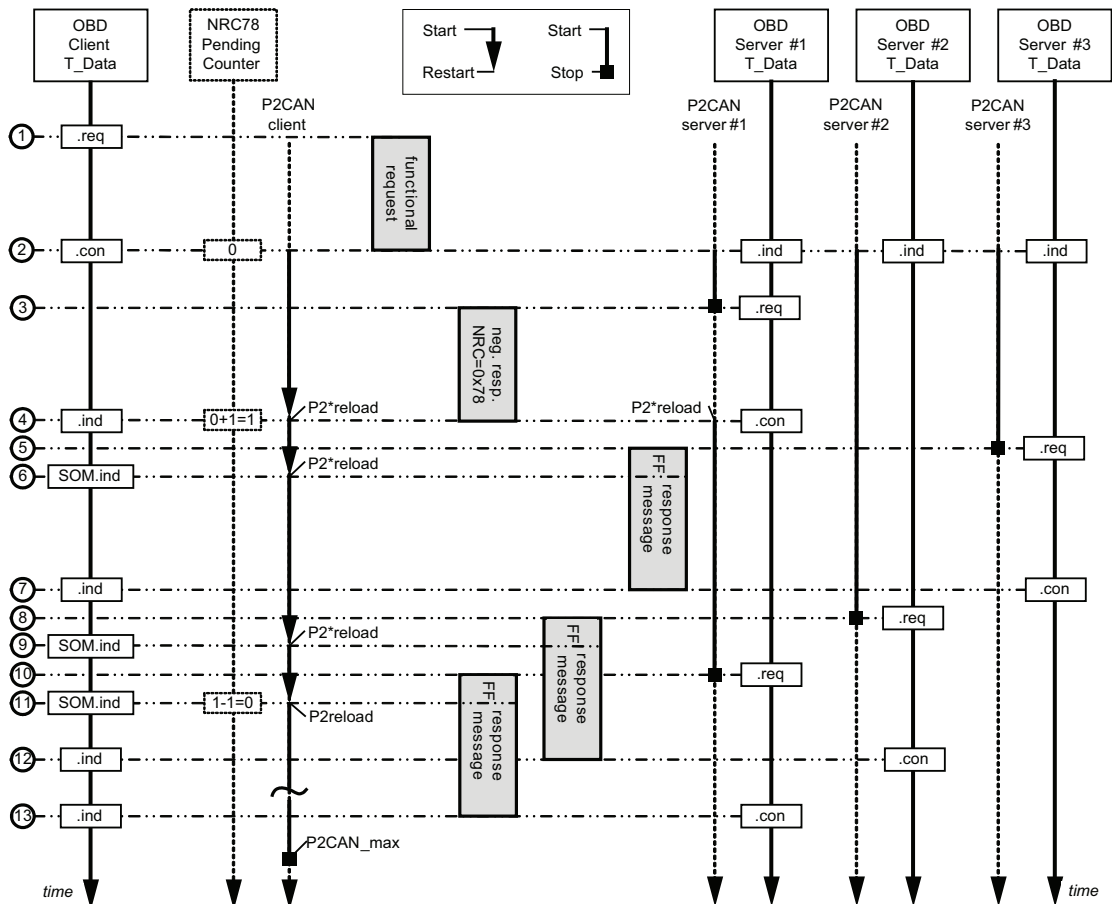

- 1 **Client T_Data.req:** diagnostic application issues functionally addressed request message to network layer.
- 2 **All server T_Data.ind:** network layer issues to diagnostic application the reception of a request message. All servers start the $P2_{CAN}$ timer using the value of $P2_{CAN} = P2_{CAN_max}$.
Client T_Data.con: network layer issues to diagnostic application the confirmation of the completion of the request message. Client starts its $P2_{CAN}$ timer using the default reload value $P2_{CAN} = P2_{CAN_max}$. **NRCPendingCounter** = 0.
- 3 **Server #1 T_Data.req:** diagnostic application does not have the positive response message ready and issues negative response message with NRC = 0x78 by a T_Data.req to the network layer within $P2_{CAN}$.
- 4 **Server #1 T_Data.con:** network layer issues to diagnostic application the completion of the response message.
Client T_Data.ind: network layer issues to diagnostic application the reception of a message. Since the received response message is a negative response message with NRC = 0x78 the **NRCPendingCounter** is incremented by 1 ($0+1=1$). Reload $P2_{CAN}$ with $P2^*_{CAN_max}$ value. Server#1 reloads $P2_{CAN}$ with $P2^*_{CAN_max}$ value.
- 5 **Server #3 T_Data.req:** diagnostic application has prepared the response message and issues a T_Data.req to network layer within $P2_{CAN}$.
- 6 **Client T_DataSOM.ind:** network layer issues to diagnostic application the reception of a StartOfMessage which is initiated by the reception of a FirstFrame indication on CAN (see ISO 15765-2). Reload $P2_{CAN}$ with $P2^*_{CAN_max}$ Value.
- 7 **Server #3 T_Data.con:** network layer issues to diagnostic application the completion of the response message.
Client T_Data.ind: network layer issues to diagnostic application the completion of the response message.
- 8 **Server #2 T_Data.req:** diagnostic application has prepared the response message and issues a T_Data.req to network layer within $P2_{CAN}$.
- 9 **Client T_DataSOM.ind:** network layer issues to diagnostic application the reception of a StartOfMessage which is initiated by the reception of a FirstFrame indication on CAN (see ISO 15765-2). Client reloads $P2_{CAN}$ with $P2^*_{CAN_max}$ value.

- 10 **Server #1 T_Data.req:** diagnostic application has prepared the response message and issues a T_Data.req to network layer within P2_{CAN}.
- 11 **Client T_DataSOM.ind:** network layer issues to diagnostic application the reception of a StartOfMessage which is initiated by the reception of a FirstFrame indication on CAN (see ISO 15765-2). Since the received response message is a positive response message the **NRCPendingCounter** is decremented by 1 (1-1=0). Client reloads P2_{CAN} with P2_{CAN_max} value.
- 12 **Server #2 T_Data.con:** network layer issues to diagnostic application the completion of the response message.
Client T_Data.ind: network layer issues to diagnostic application the completion of the response message.
- 13 **Server #1 T_Data.con:** network layer issues to diagnostic application the completion of the response message.
Client T_Data.ind: network layer issues to diagnostic application the completion of the response message.

Figure 5 — Functional OBD communication — Enhanced response timing

6.2.3 Minimum time between requests from external test equipment

6.2.3.1 ISO 9141-2, ISO 14230-4 — Minimum time between requests from external test equipment

For ISO 9141-2 (K-line) interfaces, the required times between request messages are specified in ISO 9141-2.

For ISO 14230-4 (K-line) interfaces, the required times between request messages are specified in ISO 14230-4. Figure 6 shows an example of a request message followed by four (4) response messages and another request message.

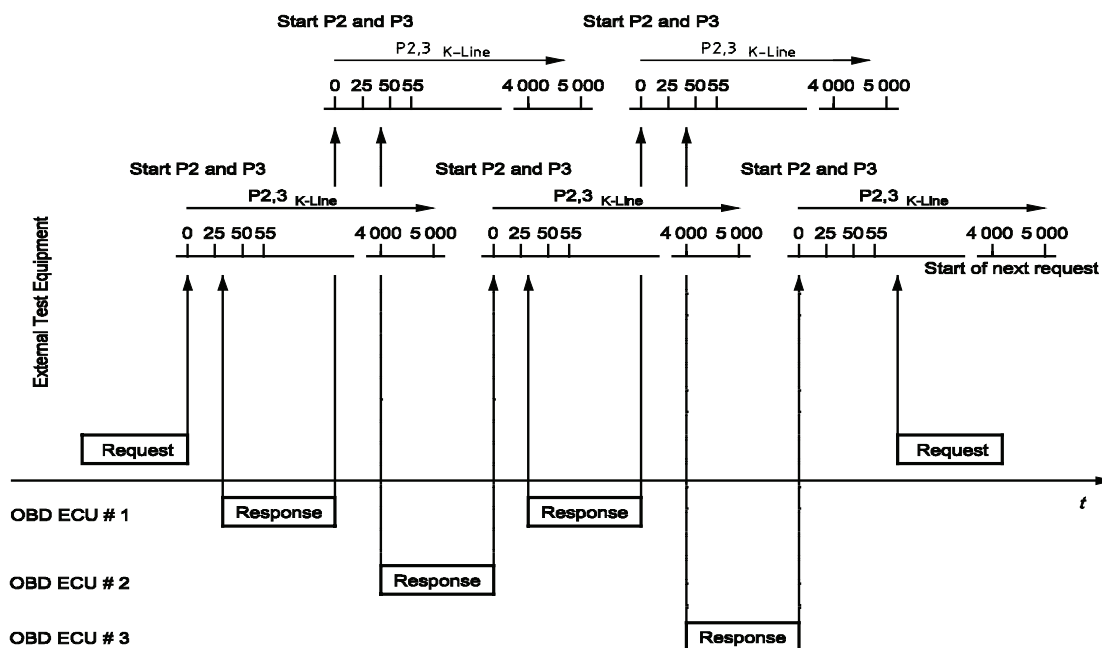

Figure 6 — ISO 9141-2 (Key bytes: 0x08 0x08) and ISO 14230-4 application timing parameter overview

6.2.3.2 SAE J1850 — Minimum time between requests from external test equipment

For SAE J1850 network interfaces, an external test equipment shall always wait for a response message from the previous request, or “no response” time-out before sending another request message. If the number of response messages is known and all response messages have been received, then the external test equipment is permitted to send the next request message immediately. If the number of response messages is not known, then the external test equipment shall wait at least P2_{J1850} maximum time.

Figure 7 illustrates an example of a request message followed by four (4) response messages and another request message.

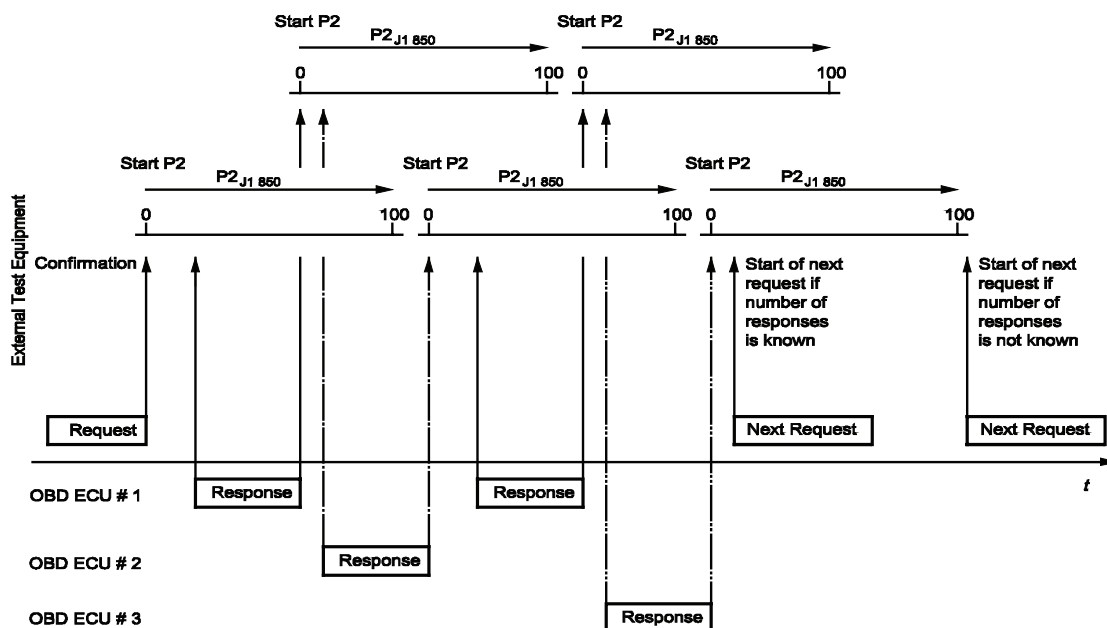

Figure 7 — SAE J1850 application timing parameter overview

6.2.3.3 ISO 15765-4 — Minimum time between requests from external test equipment

For ISO 15765-4 network interfaces, the external test equipment may send a new request message immediately after it has determined that all responses related to the previously sent request message have been received. If the external test equipment does not know whether it has received all response messages, (e.g. after sending the initial OBD request message: Service 0x01, PID 0x00), it shall wait (P2_{CAN_max}) after the last request. The timer P2_{CAN} of the external test equipment starts with the confirmation of a successful transmission of the request message.

Figure 8 illustrates an example of a request message followed by three (3) single-frame response messages and another request message.

IMPORTANT — The P2_{CAN_reload} is performed by the client to identify whether more emissions-related OBD ECUs will send a response message. The P2_{CAN_reload} is not defined to check whether the entire response message is sent within P2_{CAN_max} timing.

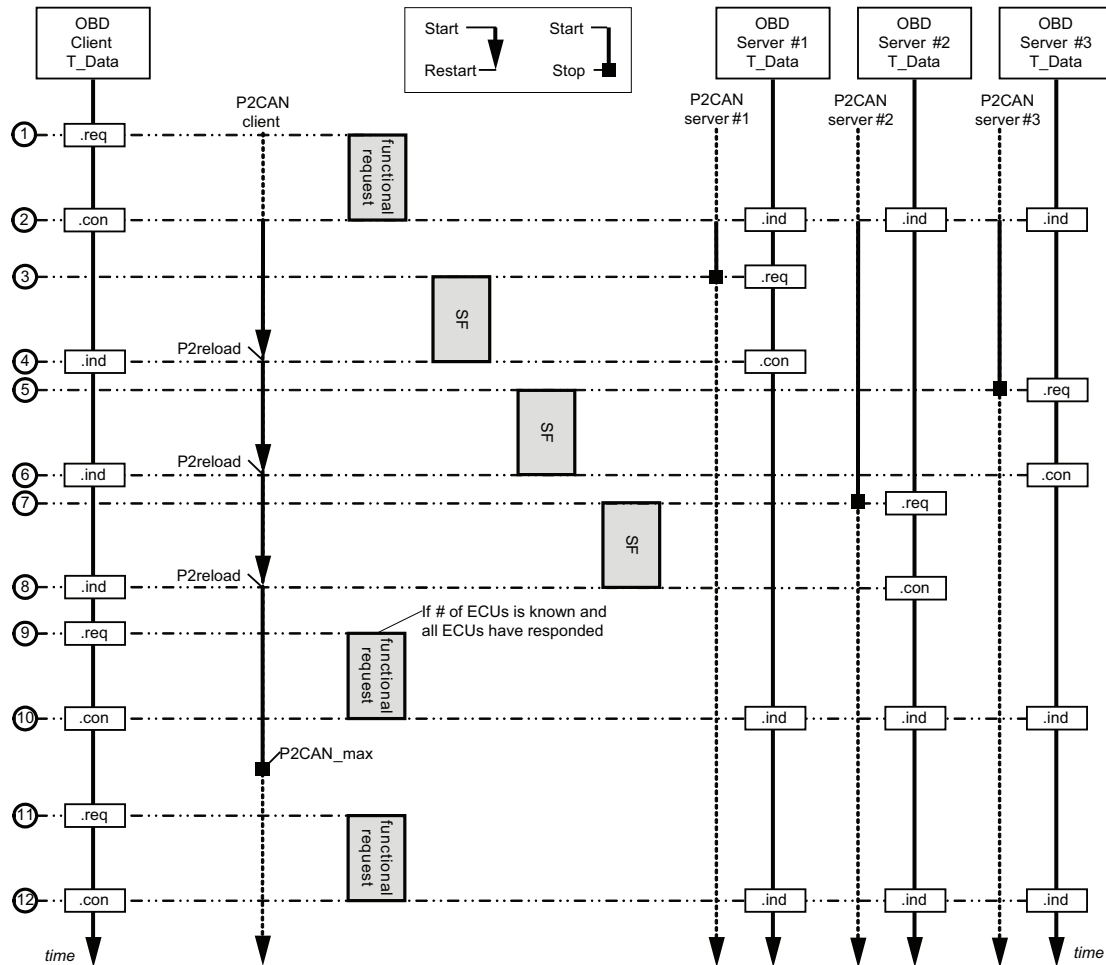

- 1 **Client T_Data.req:** diagnostic application issues functionally addressed request message to network layer.
- 2 **All server T_Data.ind:** network layer issues to diagnostic application the reception of a request message. All servers start the $P2_{CAN}$ timer using the value of $P2_{CAN} = P2_{CAN_max}$.
Client T_Data.con: network layer issues to diagnostic application the confirmation of the completion of the request message. Client starts its $P2_{CAN}$ timer using the default reload value $P2_{CAN} = P2_{CAN_max}$.
- 3 **Server #1 T_Data.req:** diagnostic application has prepared the response message and issues a T_Data.req to network layer within $P2_{CAN}$. The response message is a single-frame message.
- 4 **Server #1 T_Data.con:** network layer issues to diagnostic application the completion of the response message.
Client T_Data.ind: network layer issues to diagnostic application the completion of the response message. Client reloads $P2_{CAN}$ with $P2_{CAN_max}$ value.
- 5 **Server #3 T_Data.req:** diagnostic application has prepared the response message and issues a T_Data.req to network layer within $P2_{CAN}$. The response message is a single-frame message.
- 6 **Server #3 T_Data.con:** network layer issues to diagnostic application the completion of the response message.
Client T_Data.ind: network layer issues to diagnostic application the completion of the response message. Client reloads $P2_{CAN}$ with $P2_{CAN_max}$ value.
- 7 **Server #2 T_Data.req:** diagnostic application has prepared the response message and issues a T_Data.req to network layer within $P2_{CAN}$. The response message is a single-frame message.
- 8 **Server #2 T_Data.con:** network layer issues to diagnostic application the completion of the response message.
Client T_Data.ind: network layer issues to diagnostic application the completion of the response message. Client reloads $P2_{CAN}$ with $P2_{CAN_max}$ value.
- 9 **Client T_Data.req:** diagnostic application issues functionally addressed request message to network layer. The client knows the number of ECUs which shall have responded to the previous request. Since all response messages have been received, the client is already allowed to issue a new functional request message.
- 10 **All server T_Data.ind:** network layer issues to diagnostic application the reception of a request message. All servers start the $P2_{CAN}$ timer using the value of $P2_{CAN} = P2_{CAN_max}$.
Client T_Data.con: network layer issues to diagnostic application the confirmation of the completion of the request message. Client starts its $P2_{CAN}$ timer using the default reload value $P2_{CAN} = P2_{CAN_max}$ (not shown in figure).

- 11 **Client T_Data.req:** diagnostic application issues functionally addressed request message to network layer. The client does not know the number of ECUs which shall have responded to the previous request. Therefore the client shall wait until $P2_{CAN} = P2_{CAN_max}$ before it issues a new functional request message.
- 12 **All server T_Data.ind:** network layer issues to diagnostic application the reception of a request message. All servers start the $P2_{CAN}$ timer using the value of $P2_{CAN} = P2_{CAN_max}$ (not shown in figure).
Client T_Data.con: network layer issues to diagnostic application the confirmation of the completion of the request message. Client starts its $P2_{CAN}$ timer using the default reload value $P2_{CAN} = P2_{CAN_max}$ (not shown in figure).

Figure 8 — ISO 15765-4 application timing parameter (single-frame response messages) overview

Figure 9 illustrates an example of a request message followed by one (1) multiple-frame response message and two (2) single frames and another request message. The next request message can be sent immediately by the external test equipment after completion of all response messages in case the transmission of the response messages takes longer than $P2_{CAN_max}$, even if the external test equipment does not know the number of responding ECUs.

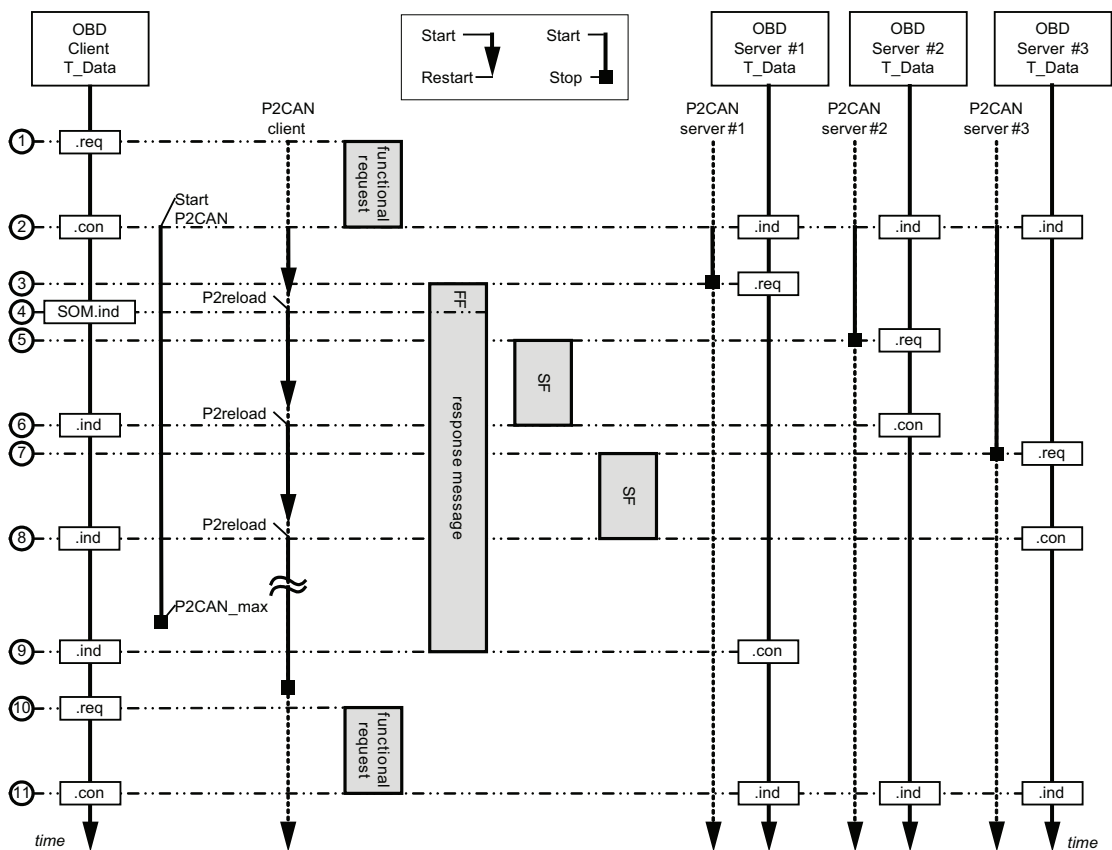

- 1 **Client T_Data.req:** diagnostic application issues functionally addressed request message to network layer.
- 2 **All server T_Data.ind:** network layer issues to diagnostic application the reception of a request message. All servers start the $P2_{CAN}$ timer using the value of $P2_{CAN} = P2_{CAN_max}$.
Client T_Data.con: network layer issues to diagnostic application the confirmation of the completion of the request message. Client starts its $P2_{CAN}$ timer using the default reload value $P2_{CAN} = P2_{CAN_max}$.
- 3 **Server #1 T_Data.req:** diagnostic application has prepared the response message and issues a T_Data.req to network layer within $P2_{CAN}$.
- 4 **Client T_DataSOM.ind:** network layer issues to diagnostic application the reception of a StartOfMessage which is initiated by the reception of a FirstFrame indication on CAN (see ISO 15765-2). Client reloads $P2_{CAN}$ with $P2_{CAN_max}$ value.
- 5 **Server #2 T_Data.req:** diagnostic application has prepared the response message and issues a T_Data.req to network layer within $P2_{CAN}$. The response message is a single-frame message.
- 6 **Server #2 T_Data.con:** network layer issues to diagnostic application the completion of the response message.
Client T_Data.ind: network layer issues to diagnostic application the completion of the response message. Client reloads $P2_{CAN}$ with $P2_{CAN_max}$ value.

- 7 **Server #3 T_Data.req:** diagnostic application has prepared the response message and issues a T_Data.req to network layer within P2CAN. The response message is a single-frame message.
- 8 **Server #3 T_Data.con:** network layer issues to diagnostic application the completion of the response message.
Client T_Data.ind: network layer issues to diagnostic application the completion of the response message. Client reloads P2CAN with P2CAN_max value.
- 9 **Server #1 T_Data.con:** network layer issues to diagnostic application the completion of the response message.
Client T_Data.ind: network layer issues to diagnostic application the completion of the response message.
- 10 **Client T_Data.req:** diagnostic application issues functionally addressed request message to network layer. The client does not know the number of ECUs which shall have responded to the previous request. Therefore the client shall wait until P2CAN = P2CAN_max before it issues a new functional request message.
- 11 **All server T_Data.ind:** network layer issues to diagnostic application the reception of a request message. All servers start the P2CAN timer using the value of P2CAN = P2CAN_max.
Client T_Data.con: network layer issues to diagnostic application the confirmation of the completion of the request message. Client starts its P2CAN timer using the default reload value P2CAN = P2CAN_max.

Figure 9 — ISO 15765-4 functional OBDonCAN communication — Multiple-frame response not finished within P2CAN

Figure 10 illustrates an example of a request message followed by one (1) multiple-frame response message and two (2) single frames, (completion within P2CAN_max) and another request message. The next request message can be sent immediately by the external test equipment after completion of all response messages if the external test equipment knows the number of responding ECUs. If not, it needs to wait with the next request message to send until P2CAN_max is expired.

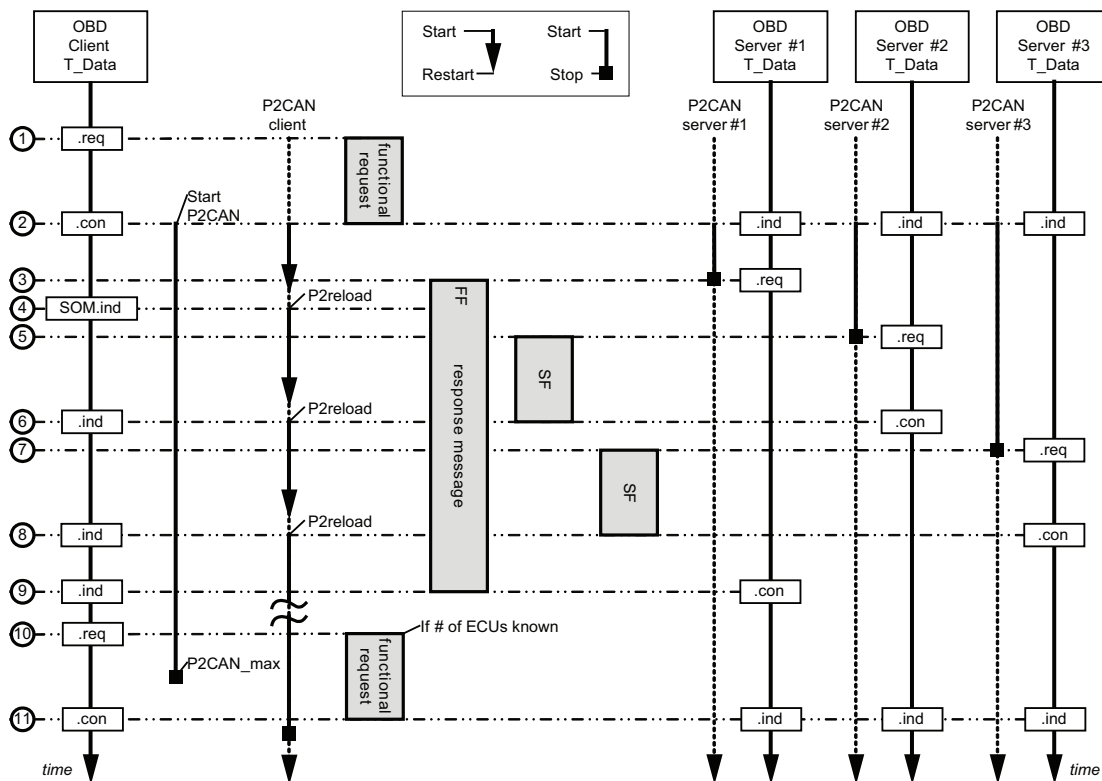

- 1 **Client T_Data.req:** diagnostic application issues functionally addressed request message to network layer.
- 2 **All server T_Data.ind:** network layer issues to diagnostic application the reception of a request message. All servers start the P2CAN timer using the value of P2CAN = P2CAN_max.
Client T_Data.con: network layer issues to diagnostic application the confirmation of the completion of the request message. Client starts its P2CAN timer using the default reload value P2CAN = P2CAN_max.
- 3 **Server #1 T_Data.req:** diagnostic application has prepared the response message and issues a T_Data.req to network layer within P2CAN.
- 4 **Client T_DataSOM.ind:** network layer issues to diagnostic application the reception of a StartOfMessage which is initiated by the reception of a FirstFrame indication on CAN (see ISO 15765-2). Client reloads P2CAN with P2CAN_max value.

- 5 **Server #2 T_Data.req:** diagnostic application has prepared the response message and issues a T_Data.req to network layer within P2_{CAN}. The response message is a single-frame message.
- 6 **Server #2 T_Data.con:** network layer issues to diagnostic application the completion of the response message.
Client T_Data.ind: network layer issues to diagnostic application the completion of the response message. Client reloads P2_{CAN} with P2_{CAN_max} value.
- 7 **Server #3 T_Data.req:** diagnostic application has prepared the response message and issues a T_Data.req to network layer within P2_{CAN}. The response message is a single-frame message.
- 8 **Server #3 T_Data.con:** network layer issues to diagnostic application the completion of the response message.
Client T_Data.ind: network layer issues to diagnostic application the completion of the response message. Client reloads P2_{CAN} with P2_{CAN_max} value.
- 9 **Server #1 T_Data.con:** network layer issues to diagnostic application the completion of the response message.
Client T_Data.ind: network layer issues to diagnostic application the completion of the response message.
- 10 **Client T_Data.req:** diagnostic application issues functionally addressed request message to network layer. The client knows the number of ECUs which shall have responded to the previous request. Therefore the client is not required to wait until the time window has reached P2_{CAN_max} before it issues a new functional request message.
- 11 **All server T_Data.ind:** network layer issues to diagnostic application the reception of a request message. All servers start the P2_{CAN} timer using the value of P2_{CAN} = P2_{CAN_max}.
Client T_Data.con: network layer issues to diagnostic application the confirmation of the completion of the request message. Client starts its P2_{CAN} timer using the default reload value P2_{CAN} = P2_{CAN_max}.

Figure 10 — ISO 15765-4 functional OBDonCAN communication — Multiple-frame response finished within P2_{CAN}

NOTE The network layer timing parameters for the multiple-frame response are not shown. Network layer timing requirements for legislated diagnostic messages are specified in ISO 15765-4.

6.2.3.4 ECU behaviour to a request for supported/non-supported OBD information

Figure 11 illustrates an example of a typical vehicle OBD configuration.

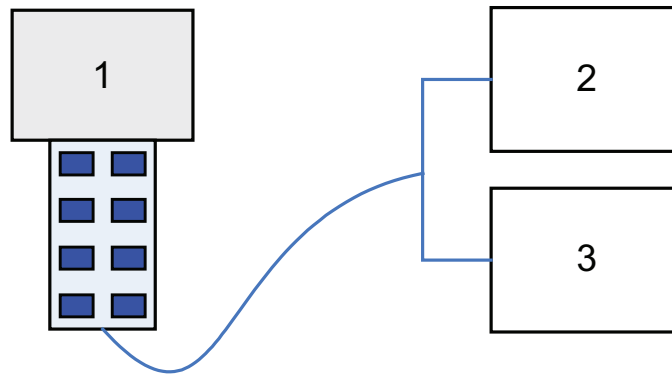

Key

- 1 external test equipment
- 2 ECM (engine control module)
- 3 TCM (transmission control module)

Figure 11 — Example of external test equipment connected to two (2) OBD ECUs

A service shall only be implemented by an ECU if supported with data (e.g. PID/OBD Monitor ID/Test ID/INFOTYPE supported), except for Service 0x01 and PID 0x00 which shall be supported by all emissions-related ECUs.

Typically, the ECM supports OBD Monitor IDs, which the TCM does not support. In case the external test equipment requests the status of such OBD Monitor ID supported by the ECM, the ECM sends a positive response message and the TCM does not send a response message (no negative response message

allowed). The external test equipment knows that the TCM will not send a positive response message based on the OBD Monitor ID supported information retrieved prior to the latter request.

This shall be implemented to enhance the overall diagnostic communication performance between the external test equipment and the vehicle ECUs (see 6.2.3.3).

6.2.4 Data not available

6.2.4.1 ISO 9141-2, ISO 14230-4, and SAE J1850 — Data not available

There are two conditions for which data is considered not available. One condition is that the service is not supported, and the other is that the service is supported but data is currently not available.

For SAE J1850 and ISO 9141-2 interfaces, there will be no reject message to a functional request message if the request is not supported by the ECU. This prevents response messages from all ECUs that do not support a service or a specific data value.

For ISO 14230-4 interfaces, there will be a response message to every request message either positive (with data) or negative. In order to avoid unnecessary communication, the ECU(s) which does (do) not support a functionally requested PID, TID, or INFOTYPE is permitted not to send a negative response message because another ECU will send a positive response message. Format and possible codes of negative responses are specified in 6.3.4.

Some services are supported by a vehicle, but data may not always be available when requested. For Services 0x05 and 0x06, if the test has not been run since test results were cleared, or for Service 0x02 if freeze frame data has not been stored, or for Service 0x09 if the engine is running, valid data will not be available. For these conditions, the manufacturer has the option either to not respond or to respond with data that is invalid (ISO 9141-2 and SAE J1850 only). The functional description for these services discusses the method to determine if the data is valid.

6.2.4.2 ISO 15765-4 — Data not available

There are four (4) conditions for which data is considered not available:

- a) **Request message is not supported:** The ECU(s) which does (do) not support the functional request message shall not send any response message.
- b) **Request message is supported but data is not supported:** The ECU(s) which does (do) support the functional request message but does (do) not support the requested data (e.g. PID, OBD Monitor ID, TID, or INFOTYPE) is (are) not allowed to send a negative response message because another ECU will send a positive response message. If the external test equipment sends a message including multiple PIDs and each emission-related ECU does not support all requested PIDs, then each ECU shall send a positive response message including the supported PID(s) and data values and shall not send a negative response message. If an ECU does not support any of the PIDs requested, it is not allowed to send a negative response message.
- c) **Request message is supported but data is currently not available:** The ECU(s) which does (do) support the functional request message but does (do) not currently have the requested data available shall respond with a negative response message with response code 0x22 - ConditionsNotCorrect (negative response message format is specified in 6.3.3). For Services 0x01, 0x02, 0x03, 0x06, 0x07 and 0x0A the use of a negative response message including response code 0x22 is not permitted. For Services 0x04, 0x08 and 0x09 the use of a negative response message including negative response code (NRC) 0x22/0x78 is allowed only during conditions specified by OBD regulations.
- d) **Request message is supported but data is not available within P2 timing:** The behaviour of the ECU(s) and the external test equipment is specified in 6.2.4.3.

6.2.4.3 Data not available within P2 timing

6.2.4.3.1 Overview

The following subclauses specify the request/response message handling for each protocol if the data is not available within the P2 timing in the ECU(s). The description in the sub-section only applies to Service 0x09, INFOTYPE 0x06 Calibration Verification Numbers.

6.2.4.3.2 ISO 9141-2 — Data not available within P2 timing

If an ECU(s) supports the functional request message but does not have the requested data available within P2 timing, then a retry message handling routine shall be performed as follows:

- a) If the response message is not received within $P2_{K-Line}$, the external test equipment shall stop retrying the request message after one (1) minute from the original request.
- b) The retry message shall be sent at least every four (4) seconds (between 55 ms and 4 000 ms). The retry message keeps the bus alive and prevents the external test equipment from having to re-initialize the bus ($P3_{K-Line}$ time out).
- c) The ECUs, which either have already sent a positive response message or have not sent a positive response message, shall not restart the requested internal routine again.
- d) The external test equipment shall record if all ECUs have sent the expected number of response messages.
- e) After successful completion of all response messages, the external test equipment shall send a request message which is “not equal” to the “Repeated Request” message.

Additional description is included in the functional description of the corresponding service.

Figure 12 illustrates the ISO 9141-2 (Key Bytes: 0x08 0x08) data not available within P2 timing handling overview.

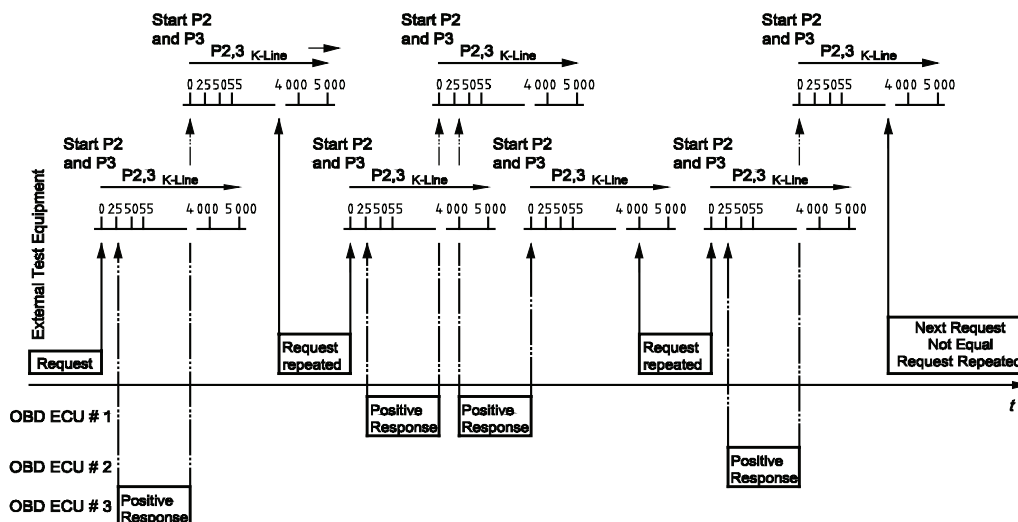

Figure 12 — ISO 9141-2 (Key bytes: 0x08 0x08) data not available within P2 timing handling overview

For the ISO 9141-2 protocol, the response message timing $P2_{K-Line}$ shall be in accordance with Table 2. The $P2_{K-line_min}$ application timing parameter value depends on the Key bytes as listed:

- Key bytes:0x08 0x08: $P2_{K-line_min} = 25$ ms
- Key bytes:0x94 0x94: $P2_{K-line_min} = 0$ ms

6.2.4.3.3 ISO 14230-4 — Data not available within P2 timing

If an ECU(s) supports the functional request message but does not have the requested data available within P2 timing, handling shall be performed as follows:

- a) The ECU(s) shall respond with a negative response message with response code 0x78 - RequestCorrectlyReceived-ResponsePending within P2 timing.
- b) ECUs which require more time than $P2_{K-Line}$ to perform the requested action shall repeat the negative response message with response code 0x78 prior to expiration of $P2_{K-Line}$ until the positive response message is available.
- c) After all positive response messages have been received or a time out $P2_{K-Line_max}$ has occurred, the external test equipment shall wait until $P3_{K-Line_min}$ is reached to send a new request message.

Figure 13 illustrates the ISO 14230-4 negative response code RC=0x78 handling overview.

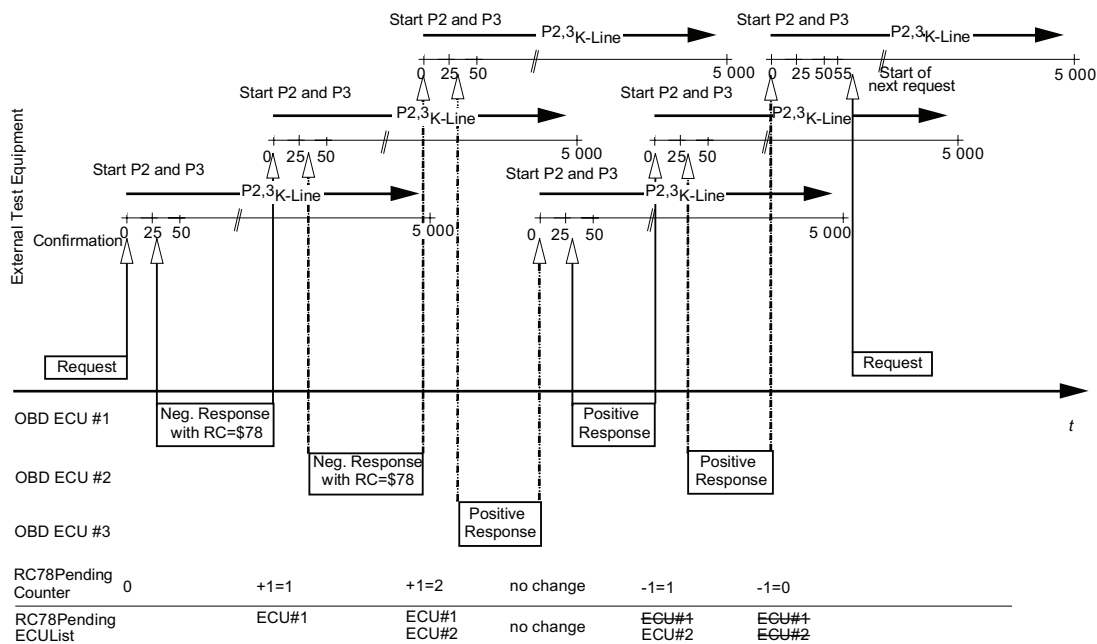

Figure 13 — ISO 14230-4 — Negative response code RC=0x78 handling overview

6.2.4.3.4 SAE J1850 — Data not available within P2 timing

If an ECU(s) supports the functional request message but does not have the requested data available within P2 timing, then a retry message handling routine shall be performed as follows:

- If the response message is not received within $P2_{J1850}$, the external test equipment shall wait thirty (30 ± 1) seconds and then retry the request message.
- The retry message shall be stopped after one (1) minute from the original request.
- The external test equipment shall record if all ECUs have sent the expected number of response messages.

An additional description is included in the functional description of the corresponding service.

Figure 14 illustrates the SAE J1850 data not available within P2 timing handling overview.

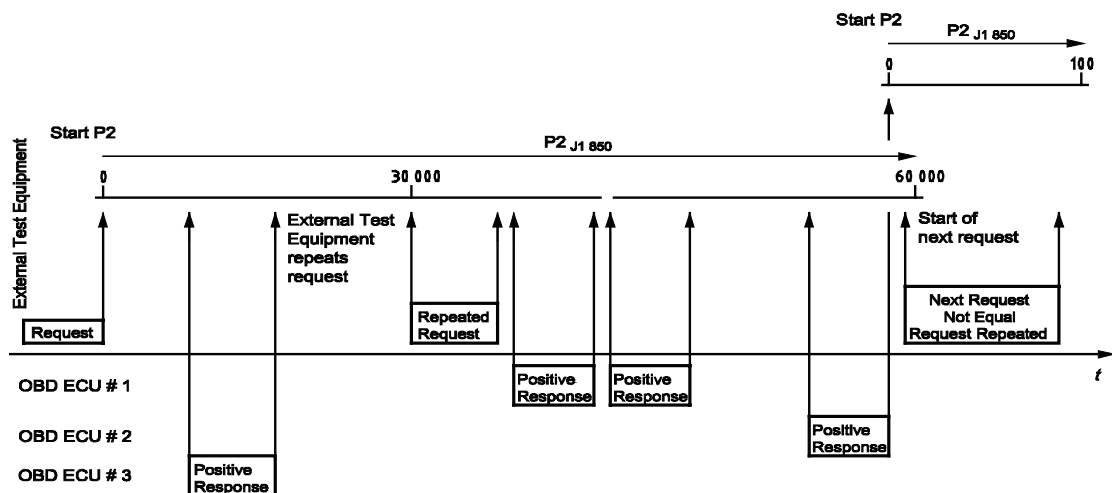

Figure 14 — SAE J1850 — Data not available within P2 timing handling overview

6.2.4.3.5 Data not available test conditions for protocols: ISO 9141-2, ISO 14230-4 and SAE J1850

There are two conditions for which data is considered not available:

- Service is not supported.
- Service is supported but data is not available at the time that the request is made.

Table 10 indicates the proper server/ECU response for each protocol as detailed in 6.2.4.1.

Table 10 — Proper response from server/ECU with ISO 9141-2, ISO 14230-4 and SAE J1850 protocol

#	Condition	ISO 9141-2	SAE J1850	ISO 14230-4
a)	Service 0x01 not supported	All ECUs must respond to Service 0x01 PID 0x00 if Service 0x01 is supported. If Service 0x01 is not supported, no response is allowed	All ECUs must respond to Service 0x01 PID 0x00 if Service 0x01 is supported. If Service 0x01 is not supported, no response is allowed	All ECUs must respond to Service 0x01 PID 0x00 if Service 0x01 is supported. If Service 0x01 is not supported, ECU can either not respond or send a negative response (0x7F, 0x01, 0x11)
b)	Service 0x01 unsupported PID requested	No response preferred, positive response is allowed	No response preferred, positive response is allowed	ECU can either not respond or send a negative response (0x7F, 0x01, 0x12)
c)	Service 0x01 supported PID requested	Respond within P2 timing	Respond within P2 timing	Respond within P2 timing
d)	Service 0x02 not supported	The ECU shall not respond	The ECU shall not respond	ECU can either not respond or send a negative response (0x7F 0x02, 0x11)
e)	Service 0x02 supported PID requested, no Freeze Frame stored	PID 0x02 indicates 0x0000, but if PIDs are requested, ECU can either not respond or send invalid data, except if supported PIDs (0x00, 0x20, ...) have been requested. Then the ECU shall send a response with the supported PID and data bytes	PID 0x02 indicates 0x0000, but if PIDs are requested, ECU can either not respond or send invalid data, except if supported PIDs (0x00, 0x20, ...) have been requested. Then the ECU shall send a response with the supported PID and data bytes	PID 0x02 indicates 0x0000, but if PIDs are requested, ECU can either not respond or send a negative response (0x7F, 0x02, 0x12), except if supported PIDs (0x00, 0x20, ...) have been requested. Then the ECU shall send a response with the supported PID and data bytes
f)	Service 0x02 unsupported PID requested, no Freeze Frame stored	No response preferred, positive response is allowed	No response preferred, positive response is allowed	ECU can either not respond or send a negative response (0x7F 0x02, 0x12)
g)	Service 0x02 supported PID requested, Freeze Frame stored	Respond within P2 timing	Respond within P2 timing	Respond within P2 timing
h)	Service 0x02 unsupported PID requested, Freeze Frame stored	No response preferred, positive response is allowed	No response preferred, positive response is allowed	ECU can either not respond or send a negative response (0x7F 0x02, 0x12)
i)	Service 0x03/0x07 not supported	The ECU shall not respond	The ECU shall not respond	ECU can either not respond or send a negative response (0x7F 0x03/0x07, 0x11)
j)	Service 0x03/0x07 supported, no DTCs stored	No response preferred, positive response indicating no DTCs is allowed	No response preferred, positive response indicating no DTCs is allowed	Positive response indicating no DTCs is required
k)	Service 0x03/0x07 supported, DTCs stored	Positive response is required	Positive response is required	Positive response is required
l)	Service 0x04 not supported	The ECU shall not respond	The ECU shall not respond	ECU can either not respond or send a negative response (0x7F 0x04, 0x11)
m)	Service 0x04 supported, conditions not correct	The ECU shall not respond	The ECU shall not respond	Negative response is required (0x7F, 0x04, 0x22)
n)	Service 0x04 supported, conditions correct	Positive response is required	Positive response is required	Positive response is required
o)	Service 0x05/0x06 not supported	The ECU shall not respond	The ECU shall not respond	ECU can either not respond or send a negative response (0x7F 0x05/0x06, 0x11)

Table 10 (continued)

#	Condition	ISO 9141-2	SAE J1850	ISO 14230-4
p)	Service 0x05/0x06 supported TID requested, no stored data available	If TIDs are requested, ECU can either not respond or send invalid data	If TIDs are requested, ECU can either not respond or send invalid data	If TIDs are requested, ECU can either not respond or send invalid data or send negative response (0x7F, 0x05/0x06, 0x12)
q)	Service 0x05/0x06 unsupported TID requested, no stored data available	No response preferred, positive response is allowed	No response preferred, positive response is allowed	ECU can either not respond or send a negative response (0x7F, 0x05/0x06, 0x12)
r)	Service 0x05/0x06 supported TID requested, stored data available	Respond within P2 timing	Respond within P2 timing	Respond within P2 timing
s)	Service 0x05/0x06 unsupported TID requested, stored data available	No response preferred, positive response is allowed	No response preferred, positive response is allowed	ECU can either not respond or send a negative response (0x7F, 0x05/0x06, 0x12)
t)	Service 0x08 not supported	The ECU shall not respond	The ECU shall not respond	ECU can either not respond or send a negative response (0x7F, 0x08, 0x11)
u)	Service 0x08 supported TID requested, conditions correct	Respond within P2 timing	Respond within P2 timing	Respond within P2 timing
v)	Service 0x08 supported TID requested, conditions not correct	The ECU shall not respond or may respond with a manufacturer-specified value as DATA A, which corresponds to the reason the test cannot be run	The ECU shall not respond or may respond with a manufacturer-specified value as DATA A, which corresponds to the reason the test cannot be run	Negative response is required (0x7F, 0x08, 0x22) or may respond with a manufacturer-specified value as DATA A which corresponds to the reason the test cannot be run
w)	Service 0x08 unsupported TID requested	No response preferred, positive response is allowed	No response preferred, positive response is allowed	ECU can either not respond or send a negative response (0x7F, 0x08, 0x12)
x)	Service 0x09 not supported	The ECU shall not respond	The ECU shall not respond	ECU can either not respond or send a negative response (0x7F, 0x09, 0x11)
y)	Service 0x09 supported INFOTYPE requested, data available (VIN, CVN, CALID)	Respond within P2 timing	Respond within P2 timing	Respond within P2 timing
z)	Service 0x09 supported INFOTYPE requested, data not available, conditions correct (CVN)	Respond within 1 minute; do not restart CVN calculation. Test tool sends retry message every 0,055 to 4,0 seconds	Respond within 1 minute; do not restart CVN calculation. Test tool sends retry message after 30 seconds	One or multiple negative response message(s) (0x7F, 0x09, 0x78) required within P2 _{max} (25 – 50 ms) until positive response is sent
aa)	Service 0x09 supported INFOTYPE requested, data not available, conditions not correct (CVN), prior to 2005 MY only	The ECU shall not respond	The ECU shall not respond	Negative response is required (0x7F, 0x09, 0x22)
bb)	Service 0x09 unsupported INFOTYPE requested	No response preferred, positive response is allowed	No response preferred, positive response is allowed	ECU can either not respond or send a negative response (0x7F, 0x09, 0x12)
cc)	Service 0x00 or 0x0A through 0x0F	The ECU shall not respond	The ECU shall not respond	ECU can either not respond or send a negative response (0x7F, 0x0X, 0x11)

6.2.4.3.6 ISO 15765-4 — Data not available within P2 timing

The ECU(s) which does (do) support the functional request message but does (do) not have the requested data available within P2 timing shall perform the following handling:

- a) The ECU(s) shall respond with a negative response message with negative response code (NRC) 0x78 - RequestCorrectlyReceived-ResponsePending within P2 timing (not allowed for Service 0x01, 0x02, 0x03, 0x06, 0x07 and 0x0A requests).
- b) After correct reception of the negative response message with negative response code (NRC) 0x78, the $P2_{CAN_max}$ parameter timing value shall be set to $P2^*_{CAN_max}$ (5 000 ms) by the external test equipment and the ECU which has sent the negative response message.
- c) If another ECU also sends a negative response message with response code 0x78, the $P2_{CAN_max}$ timing parameter value shall be reloaded to $P2^*_{CAN_max}$.
- d) ECUs which require more than $P2^*_{CAN_max}$ to perform the requested action shall repeat the negative response message with negative response code (NRC) 0x78 prior to expiration of $P2^*_{CAN_max}$ until correct reception of the positive response message.
- e) After all positive response messages have been received or time out, $P2^*_{CAN_max}$ has occurred, the $P2_{CAN_max}$ timing parameter shall be reset to the values specified in Table 7.

The vehicle manufacturer is responsible to ensure that the network architecture of the vehicle does not cause timing delays that exceed $P2_{CAN_max}$ timing when responding to Services 0x01, 0x02, 0x03, 0x06, 0x07 and 0x0A requests because a negative response message with response code 0x78 shall not be allowed.

Figure 15 illustrates the negative response message handling with response code 0x78 for the ISO 15765-4 interface.

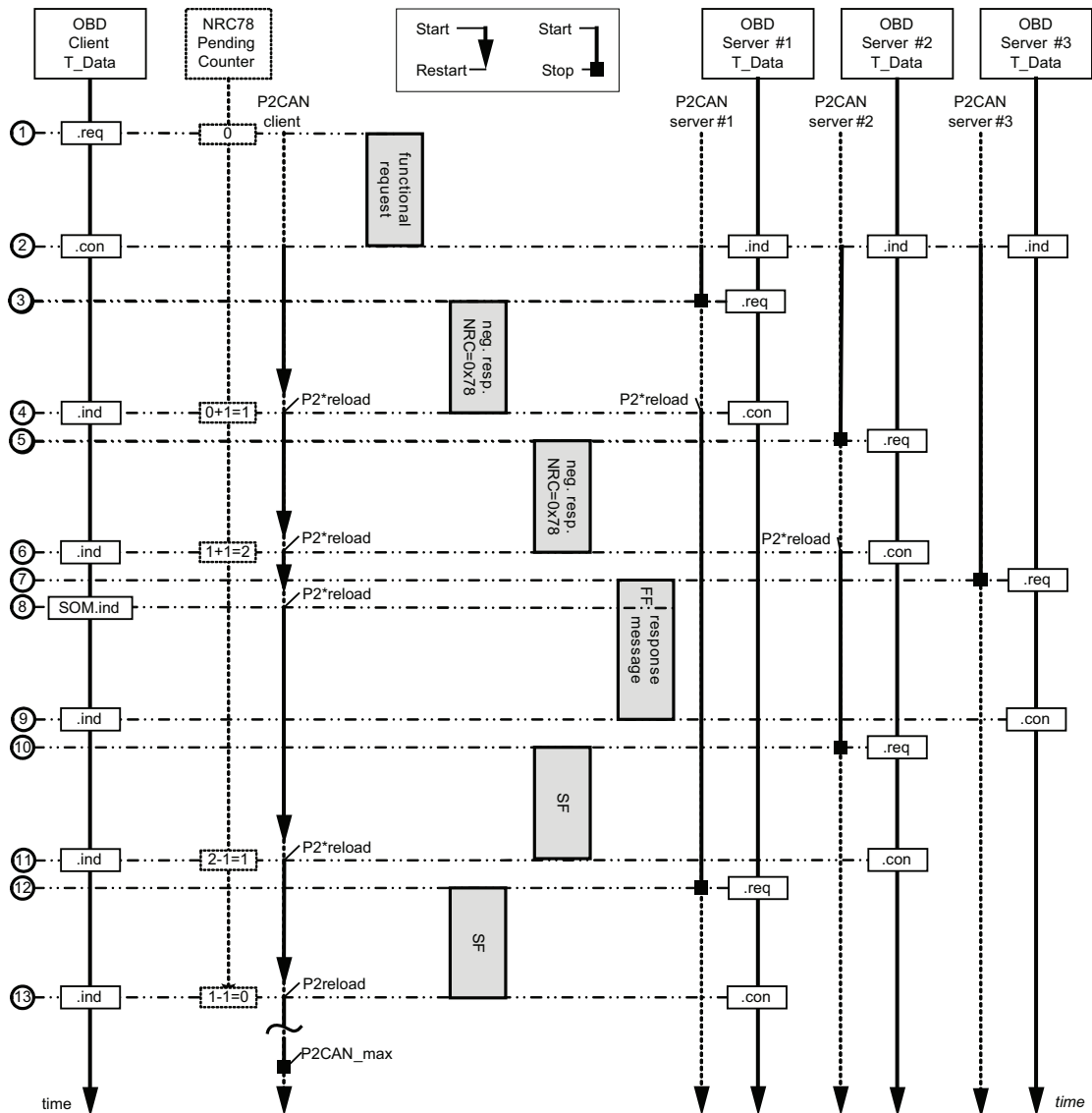

- 1 **Client T_Data.req:** diagnostic application issues functionally addressed request message to network layer.
- 2 **All server T_Data.ind:** network layer issues to diagnostic application the reception of a request message. All servers start the $P2_{CAN}$ timer using the value of $P2_{CAN} = P2_{CAN_max}$.
Client T_Data.con: network layer issues to diagnostic application the confirmation of the completion of the request message. **NRCPendingCounter** = 0. Client starts its $P2_{CAN}$ timer using the default reload value $P2_{CAN} = P2_{CAN_max}$.
- 3 **Server #1 T_Data.req:** diagnostic application does not have the positive response message ready and issues negative response message with **NRC** = 0x78 by a T_Data.req to the network layer within $P2_{CAN}$.
- 4 **Client T_Data.ind:** network layer issues to diagnostic application the reception of a message. Since the received response message is a negative response message with **NRC** = 0x78, the **NRCPendingCounter** is incremented by 1 (**0+1=1**). Client reloads $P2_{CAN}$ with $P2^*_{CAN_max}$ value.
Server #1 T_Data.con: network layer issues to diagnostic application the completion of the response message.
- 5 **Server #2 T_Data.req:** diagnostic application does not have the positive response message ready and issues negative response message with **NRC** = 0x78 by a T_Data.req to the network layer within $P2_{CAN}$.
- 6 **Client T_Data.ind:** network layer issues to diagnostic application the reception of a message. Since the received response message is a negative response message with **NRC** = 0x78 the **NRCPendingCounter** is incremented by 1 (**1+1=2**). Client reloads $P2_{CAN}$ with $P2^*_{CAN_max}$ value.
Server #2 T_Data.con: network layer issues to diagnostic application the completion of the response message.
- 7 **Server #3 T_Data.req:** diagnostic application has prepared the response message and issues a T_Data.req to network layer within $P2_{CAN}$.
- 8 **Client T_DataSOM.ind:** network layer issues to diagnostic application the reception of a StartOfMessage which is initiated by the reception of a FirstFrame indication on CAN (see ISO 15765-2). Client reloads $P2_{CAN}$ with $P2^*_{CAN_max}$ value.
- 9 **Server #3 T_Data.con:** network layer issues to diagnostic application the completion of the response message.
Client T_Data.ind: network layer issues to diagnostic application the completion of the response message.

- 10 **Server #2 T_Data.req:** diagnostic application has prepared the response message and issues a T_Data.req to network layer within P2_{CAN}. The response message is a single-frame message.
- 11 **Server #2 T_Data.con:** network layer issues to diagnostic application the completion of the response message.
Client T_Data.ind: network layer issues to diagnostic application the completion of the response message. Since the received response message is a positive response message the **NRCPendingCounter** is decremented by 1 (2-1=1). Client reloads P2_{CAN} with P2*_{CAN_max} value.
- 12 **Server #1 T_Data.req:** diagnostic application has prepared the response message and issues a T_Data.req to network layer within P2_{CAN}. The response message is a single-frame message.
- 13 **Server #1 T_Data.con:** network layer issues to diagnostic application the completion of the response message.
Client T_Data.ind: network layer issues to diagnostic application the completion of the response message. Since the received response message is a positive response message the **NRCPendingCounter** is decremented by 1 (1-1=0). Client reloads P2_{CAN} with P2_{CAN_max} value.

Figure 15 — ISO 15765-4 — Negative response code RC=0x78 handling overview

6.2.4.3.7 Data not available — Test conditions for protocol: ISO 15765-4 Diagnostic communication over CAN

There are four conditions for which data is considered not available:

- Service is not supported.
- Service is supported but data is not supported.
- Service is supported but data is not available at the time that the request is made.
- Service is supported but data is not available within P2 timing.

Table 11 indicates the proper server/ECU response as detailed in 6.2.4.2.

Table 11 — Proper response from server/ECU for ISO 15765-4 protocol

#	Condition	ISO 15765-4
a)	Service 0x01 not supported	All emissions-related ECUs shall respond to Service 0x01 PID 0x00 if Service 0x01 is supported. If Service 0x01 is not supported, no response is allowed.
b)	Service 0x01 unsupported PID requested	The emissions-related ECU shall not respond.
c)	Service 0x01 supported PID requested	Respond within P2 timing (no negative response message with response code 0x78 allowed).
d)	Service 0x02 not supported	The ECU shall not respond.
e)	Service 0x02 supported PID, frame xx requested, no Freeze Frame stored	1) The ECU shall respond to PID 0x02 frame xx within P2 timing; PID 0x02 frame xx shall indicate 0x0000. 2) The ECU shall respond with supported PIDs for frame xx (0x00, 0x20, ...) within P2 timing. 3) If PIDs other than support PIDs or PID 0x02 are requested, the ECU shall not respond.
f)	Service 0x02 unsupported PID, frame xx requested, no Freeze Frame stored	PID 0x02 frame xx indicates 0x0000, but if any other PIDs are requested, ECU shall not respond.
g)	Service 0x02 supported PID, frame xx requested, Freeze Frame stored	1) The ECU shall respond to PID 0x02 frame xx within P2 timing. 2) The ECU shall respond with supported PIDs for frame xx (0x00, 0x20 ...) within P2 timing and shall respond to PIDs frame xx indicated as supported within P2 timing.

Table 11 (continued)

#	Condition	ISO 15765-4
h)	Service 0x02 unsupported PID, frame xx requested, Freeze Frame stored	The ECU shall not respond.
i)	Service 0x03/0x07/0x0A not supported	The ECU shall not respond.
j)	Service 0x03/0x07/0x0A supported, no DTCs stored	Positive response indicating no DTCs is required.
k)	Service 0x03/0x07/0x0A supported, DTCs stored	Positive response including the stored DTCs is required.
l)	Service 0x04 not supported	The ECU shall not respond.
m)	Service 0x04 supported, conditions not correct	Negative response is required (0x7F, 0x04, 0x22).
n)	Service 0x04 supported, conditions correct	Positive response message required. Negative response message(s) (0x7F, 0x04, 0x78) allowed until positive response message available.
o)	Service 0x06 not supported	The ECU shall not respond.
p)	Service 0x06 supported OBDMID requested, no stored data available	Positive response required, test values, min and max limits must be set to 0x00.
q)	Service 0x06 unsupported OBDMID requested, no stored data available	The ECU shall not respond.
r)	Service 0x06 supported OBDMID requested, stored data available	Respond within P2 timing.
s)	Service 0x06 unsupported OBDMID requested, stored data available	The ECU shall not respond.
t)	Service 0x08 not supported	The ECU shall not respond.
u)	Service 0x08 supported TID requested, conditions correct	Respond within P2 timing.
v)	Service 0x08 supported TID requested, conditions not correct	Negative response required (0x7F, 0x08, 0x22).
w)	Service 0x08 unsupported TID requested	The ECU shall not respond.
x)	Service 0x09 not supported	The ECU shall not respond.
y)	Service 0x09 supported INFOTYPE requested, data available (VIN, CVN, CALID)	Respond within P2 timing.
z)	Service 0x09 supported INFOTYPE requested, data not available, conditions correct (CVN)	Initial negative response message (0x7F 0x09, 0x78) required within P2 _{max} (50 ms) and consecutive negative response message(s) (0x7F, 0x09, 0x78) is (are) required within P2 _{max} (5.0 seconds) until positive response is sent.
aa)	Service 0x09 supported INFOTYPE requested, data not available, conditions not correct (CVN), prior to 2005 MY only	Negative response required (0x7F, 0x09, 0x22).
bb)	Service 0x09 unsupported INFOTYPE requested	The ECU shall not respond.
cc)	Service 0x00 or 0x0B through 0x0F	The ECU shall not respond.

6.2.5 Maximum values

If the data value exceeds the maximum value possible to be sent, the on-board system shall send the maximum value possible (0xFF or 0xFFFF). The external test equipment shall display the maximum value or an indication of data too high. This is not normally critical for real-time diagnostics, but, for example, in the case of a misfire at high vehicle speed with resulting freeze frame data stored, this will be very valuable diagnostic information.

6.2.6 Invalid signals

In distributed network architectures, certain OBD devices may be hardwired to other ECUs or may be independent OBD mechatronic devices, e.g. smart sensor/actuator connected through a network from another ECU (both referred to as remote OBD devices). When remote OBD devices are not hardwired to the OBD ECU and the data is not received over the data bus from the specific remote OBD device, this may occur for two reasons; either the remote ECU is not functioning and sending any data, or the OBD device that is hardwired to the remote ECU has failed and the remote ECU is sending a message with invalid data for the OBD remote device. In either one of these cases, the primary OBD ECU shall report Service 0x01 and Service 0x02 data parameters as the minimum or maximum value to indicate that the signal has not been received. A PID which includes this invalid data (no signal) shall either be reported with a minimum value (0x00 or 0x0000) or maximum value (0xFF or 0xFFFF), e.g. PID 0x0D "Vehicle Speed Sensor" = 0xFF = 255 km/h, PID 0x2F "Fuel Level Input" = 0x00 = 0,0 %. The reported value shall be determined by the manufacturer based on system design and network architecture to represent the least likely value to be expected under normal conditions.

6.3 Diagnostic message format

6.3.1 Addressing method

Functional addressing shall be used for all request messages because the external test equipment does not know which system on the vehicle has the information that is needed.

6.3.2 Maximum message length

6.3.2.1 ISO 9141-2, ISO 14230-4, SAE J1850 — Maximum message length

The maximum message length for request and response messages is limited to seven (7) data bytes.

For SAE J1850 and ISO 9141-2 interfaces, each unique diagnostic message specified in this part of ISO 15031 is a fixed length, although not all messages are the same length. For Services 0x01 and 0x02, message length is determined by parameter identification (PID). Several PIDs, e.g. 0x06 - 0x09, require reading of PIDs 0x13 and/or 0x1D to determine whether a data byte B is included in the response message. For Service 0x05, message length is determined by Test ID. For other services, the message length is determined by the service. This enables the external test equipment to check for proper message length, and to recognize the end of the message without waiting for possible additional data bytes. For ISO 14230-4 interfaces, the message length is always determined by the length information included in the first byte of the header.

6.3.2.2 ISO 15765-4 — Maximum message length

The maximum message length is specified in ISO 15765-2. For request messages, the message length is limited to seven (7) data bytes.

6.3.3 Request/Response message format

6.3.3.1 ISO 9141-2, ISO 14230-4, SAE 1850, ISO 15765-4 — Request message format

Table 12 specifies the request message format.

Table 12 — Request message format for ISO 9141-2, ISO 14230-4, SAE J1850, ISO 15765-4

Data Byte	Parameter Name	Cvt	Hex Value	Mnemonic
#1	Request Service Identifier	M	xx	SIDRQ
#2	service-specific data byte#1	U	xx	—
#3	service-specific data byte#2	U	xx	—
#4	service-specific data byte#3	U	xx	—
#5	service-specific data byte#4	U	xx	—
#6	service-specific data byte#5	U	xx	—
#7	service-specific data byte#6	U	xx	—

The message format defined for some services for the ISO 15765-4 protocol allows for an optional number of data bytes in the request message sent by the external test equipment. If these are included in the request message, support of those optional data bytes becomes mandatory for the server/ECU.

6.3.3.2 ISO 9141-2, ISO 14230-4, SAE J1850 — Positive response message format

Table 13 specifies the positive response message format.

Table 13 — Positive response message format for ISO 9141-2, ISO 14230-4, SAE J1850

Data Byte	Parameter Name	Cvt	Hex Value	Mnemonic
#1	Positive Response Service Identifier	M	xx	SIDPR
#2	service-specific data byte#1	U	xx	—
#3	service-specific data byte#2	U	xx	—
#4	service-specific data byte#3	U	xx	—
#5	service-specific data byte#4	U	xx	—
#6	service-specific data byte#5	U	xx	—
#7	service-specific data byte#6	U	xx	—

6.3.3.3 ISO 15765-4 — Positive response message format

Table 14 specifies the positive response message format.

Table 14 — Positive response message format for ISO 15765-4

Data Byte	Parameter Name	Cvt	Hex Value	Mnemonic
#1	Positive Response Service Identifier	M	xx	SIDPR
#2	service-specific data byte#1	U	xx	—
#3	service-specific data byte#2	U	xx	—
#4	service-specific data byte#3	U	xx	—
:	:	:	:	:
#n-2	service-specific data byte#m-2	U	xx	—
#n-1	service-specific data byte#m-1	U	xx	—
#n	service-specific data byte#m	U	xx	—

n: this value depends on the response message length
m: this value depends on the response message length - 1

6.3.3.4 ISO 14230-4, ISO 15765-4 — Negative response message format

This subclause includes additions, exceptions, and/or restrictions for ISO 14230-4 and ISO 15765-4.

Table 15 specifies the negative response message format.

Table 15 — Negative response message format for ISO 14230-4, ISO 15765-4

Data Byte	Parameter Name	Cvt	Hex Value	Mnemonic
#1	Negative Response Service Identifier	M	0x7F	SIDNR
#2	Request Service Identifier	M	xx	SIDRQ
#3	Response Code	M	xx	RC_

6.3.4 Response code parameter definition

Response codes shall be implemented in an ECU that supports a service(s) not having valid data available at the time of a request or which cannot respond with valid data available within P2_{K-Line} and P2_{CAN} timing.

Table 16 defines negative response codes.

Table 16 — Negative response code (NRC) definition

Supported by ISO Protocol	Hex Value	Definition of Response Code	Mnemonic
14230-4	0x10	generalReject This response code indicates that the service is rejected but the server (ECU) does not specify the reason of the rejection.	GR
14230-4	0x11	serviceNotSupported This response code indicates that the requested action will not be taken because the server (ECU) does not support the requested service.	SNS
14230-4	0x12	subFunctionNotSupported-InvalidFormat This response code indicates that the requested action will not be taken because the server (ECU) does not support the arguments of the request message or the format of the argument bytes do not match the prescribed format for the specified service.	SFNSIF
14230-4 15765-4	0x21	busy-RepeatRequest This response code indicates that the server (ECU) is temporarily too busy to perform the requested operation. For ISO 15765-4 protocol, the client (external test equipment) shall behave as defined in ISO 15765-4. In a multi-client (more than one external test equipment, e.g. telematic client) environment the diagnostic request message of one client might be blocked temporarily by a negative response message with response code 0x21 while another client finishes a diagnostic task. Therefore this negative response code (NRC) is only allowed to be used during the initialization sequence of the protocol. NOTE If the server (ECU) is able to perform the diagnostic task but needs additional time to finish the task and prepares the response message, the negative response message with response code 0x78 are used instead of 0x21.	BRR
14230-4 15765-4	0x22	conditionsNotCorrectOrRequestSequenceError This response code indicates that the requested action will not be taken because the server (ECU) prerequisite conditions are not met. This request may also occur when sequence-sensitive requests are issued in the wrong order.	CNCORSE
14230-4 15765-4	0x78	requestCorrectlyReceived-ResponsePending This response code indicates that the request message was received correctly, and that any parameters in the request message were valid, but the action to be performed may not be completed yet. This response code can be used to indicate that the request message was properly received and does not need to be re-transmitted, but the server (ECU) is not yet ready to receive another request. The negative response message with this response code may be repeated by the ECU(s) within P2 _{K-Line} = P2 _{CAN} = P2* _{max} until the positive response message with the requested data is available.	RRCR-RP

6.3.5 Header byte definition of ISO 9141-2, ISO 14230-4, and SAE J1850

The first three (3) bytes of all diagnostic messages are the header bytes.

For SAE J1850 and ISO 9141-2 interfaces, the value of the first header byte is dependant on the bit rate of the data link and the type of message (see SAE J1850 and ISO 9141-2). The second header byte has a value that depends on the type of message, either a request or a response.

For ISO 14230-4 interfaces, the value of the first header byte indicates the addressing mode (physical/functional) and the length of the data field. The second header byte is the address of the receiver of the message. The third header byte for all interfaces is the physical address of the sender of the message. The external test equipment has the address 0xF1. Other service tools shall use addresses in the range from 0xF0 to 0xFD. The response to all request messages will be independent of the address of the external test equipment requesting the information. Vehicle manufacturers shall not use the header bytes defined in this part of ISO 15031 for any purpose other than emissions-related diagnostic messages. When they are used, they shall conform to this specification.

Table 17 defines the diagnostic message format for ISO 9141-2, ISO 14230-4, and SAE J1850 protocols.

Table 17 — Diagnostic message format for ISO 9141-2, ISO 14230-4, SAE J1850

Header Bytes (Hex)			Data Bytes							ERR	RESP
Priority/Type	Target Address (hex)	Source Address (hex)	#1	#2	#3	#4	#5	#6	#7		
Diagnostic Request at 10,4 kbit/s: SAE J1850 and ISO 9141-2											
0x68	0x6A	0xF1	Maximum 7 data bytes							Yes	No
Diagnostic Response at 10,4 kbit/s: SAE J1850 and ISO 9141-2											
0x48	0x6B	ECU addr	Maximum 7 data bytes							Yes	No
Diagnostic Request at 10,4 kbit/s (ISO 14230-4)											
11LL LLLLb	0x33	0xF1	Maximum 7 data bytes							Yes	No
Diagnostic Response at 10,4 kbit/s (ISO 14230-4)											
10LL LLLLb	0xF1	ECU addr	Maximum 7 data bytes							Yes	No
Diagnostic Request at 41,6 kbit/s (SAE J1850)											
0x61	0x6A	0xF1	Maximum 7 data bytes							Yes	Yes
Diagnostic Response at 41,6 kbit/s (SAE J1850)											
0x41	0x6B	ECU addr	Maximum 7 data bytes							Yes	Yes

NOTE LL LLLL = Length of data bytes; RESP = In-frame response; ERR = Error Detection.

6.3.6 Header byte definition of ISO 15765-4

Each CAN frame is identified by a CAN Identifier. The size of the identifier is either 11 bit or 29 bit. The CAN identifier shall always be followed by an eight (8) byte CAN frame data field [see ISO 15765-4; section "Data length code (DLC)"]. Depending on the message type, up to three (3) bytes (FlowControl) are used for the PCI (Protocol Control Information) prior to the Service Identifier (only included in single frame or first frame) and data bytes of the message.

Table 18 defines the diagnostic message format for ISO 15765-4 protocol.

Table 18 — Diagnostic message format for ISO 15765-4

Header Bytes	CAN frame data field							
CAN Identifier (11 or 29 bit)	#1	#2	#3	#4	#5	#6	#7	#8

6.3.7 Data bytes definition of ISO 9141-2, ISO 14230-4, SAE J1850, and ISO 15765-4

For the ISO 9141-2, ISO 14230-4, and the SAE J1850 protocol, the first data byte following the header is the diagnostic service identifier, and the remaining data bytes vary depending on the specific diagnostic service. For the ISO 15765-4 protocol, the first data byte following the CAN Identifier in a single frame and first frame is the PCI (Protocol Control Information, number of bytes varies, depending on frame type), then diagnostic service identifier, and the remaining data bytes vary depending on the specific diagnostic service.

6.3.8 Non-data bytes included in diagnostic messages with SAE J1850

All diagnostic messages use a cyclic redundancy check (CRC) as in SAE J1850 as the error detection byte (ERR). In-frame response (RSP) is specified as optional in SAE J1850. For messages specified in this part of ISO 15031, the RSP byte is required in all request and response messages at 41,6 kbit/s, and is not allowed for messages at 10,4 kbit/s. The in-frame response byte shall be the node address of the device transmitting the RSP. SAE J1850 specifies additional message elements that may be included in diagnostic messages. Use of these message elements is beyond the scope of this part of ISO 15031, but needs to be considered when specifying total diagnostic messages.

6.3.9 Non-data bytes included in diagnostic messages with ISO 9141-2 and ISO 14230-4

Messages will include a checksum, specified in ISO 9141-2 and ISO 14230-4, after the data bytes as the error detection byte (ERR). There is no provision for an in-frame response.

In the bit position convention, some data byte values include descriptions that are based on bit positions within the byte. The convention used is that the most significant bit (MSB) is referred to as “bit 7”, and the least significant bit (LSB) is referred to as “bit 0,” as shown in Figure 16.

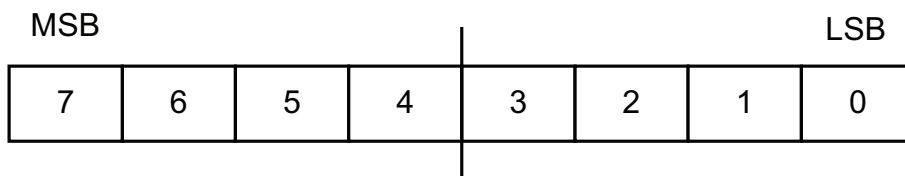

Figure 16 — Bit position within a data byte

6.4 Byte order convention

When reporting data larger than one byte, the Most Significant Byte (or high byte) is reported as first data byte followed by the next most significant bytes. The Least Significant Byte (or low byte) is reported as the last data byte. This convention is shown in numerous examples throughout this part of ISO 15031.

6.5 Allowance for expansion and enhanced diagnostic services

This part of ISO 15031 allows for the addition of diagnostic services both as industry standards and manufacturer-specific services. The diagnostic services 0x00 through 0x0F are ISO/SAE reserved.

6.6 Definition of PIDs for services 0x01 and 0x02

All PIDs are defined in SAE J1979-DA.

IMPORTANT — Several new PIDs have been defined in SAE J1979-DA based on new emissions-related vehicle technology. The data size of those PIDs exceeds the maximum message length of the non-CAN protocols (SAE J1850, ISO 9141-2, ISO 14230-4). Those PIDs are not supported by the non-CAN protocols.

6.7 Format of data to be displayed

Table 19 indicates the type of data and minimum requirements for the display format.

Table 19 — Format of data to be displayed

Data	Services	Display Format
Device ID – source address of response	All	ISO 9141-2: Hexadecimal (0x00 to 0xFF) ISO 14230-4: Hexadecimal (0x00 to 0xFF) SAE J1850: Hexadecimal (0x00 to 0xFF) ISO 15765-4: Hexadecimal (11 bit or 29 bit CAN Identifier)
Parameter ID (PID)	0x01 & 0x02	Hexadecimal (0x00 to 0xFF) description (see SAE J1979-DA)
Frame number	0x02	Decimal (0 to 255)
Data values	0x01 & 0x02	See SAE J1979-DA
Diagnostic trouble codes	0x03, 0x07, & 0x0A	“P”, “B”, “C” or “U”, plus 4 hexadecimal characters and/or DTC definition (see SAE J2012-DA)
Test ID	0x05, 0x06, & 0x08	Hexadecimal (0x00 to 0xFF)
Test value and test limits	0x05	Engineering units for Test IDs less than 0x80 (see SAE J1979-DA) – Decimal (0 to 255) for Test IDs greater than 0x80
Test value and test limits	0x06	Decimal (0 to 65535)
Component ID	0x06	Hexadecimal (0x00 to 0x7F)
Optional data bytes	0x08	4 bytes, each decimal (0 to 255) (see SAE J1979-DA)
Vehicle information type	0x09	Hexadecimal (0x00 to 0x7F) (see SAE J1979-DA)
Vehicle information data	0x09	ASCII for information types 0x02, 0x04, and 0x0A; Hexadecimal for information type 0x06; Decimal for information type 0x08 and 0x0B (see SAE J1979-DA)

NOTE ISO 15031-4/SAE J1978 specifies further guidelines and examples on displaying Service 0x01 through 0x09 data.

7 Diagnostic service definition for ISO 9141-2, ISO 14230-4, and SAE J1850

7.1 Service 0x01 — Request current powertrain diagnostic data

7.1.1 Functional description

The purpose of this service is to allow access to current emission-related data values, including analogue inputs and outputs, digital inputs and outputs, and system status information. The request for information includes a parameter identification (PID) value that indicates to the on-board system the specific information requested. PID specifications, scaling information, and display formats are included in SAE J1979-DA.

The ECU(s) shall respond to this message by transmitting the requested data value last determined by the system. All data values returned for sensor readings will be actual readings, not default or substitute values used by the system because of a fault with that sensor.

Not all PIDs are applicable or supported by all systems. PID 0x00 is a bit-encoded PID that indicates, for each ECU, which PIDs that ECU supports. PID 0x00 shall be supported by all ECUs that respond to a Service 0x01 request, because the external test equipment that conforms to SAE J1978 uses the presence of a response message by the vehicle to this request message to determine which protocol is supported for diagnostic communications. SAE J1979-DA defines how to encode supported PIDs.

IMPORTANT — All emissions-related OBD ECUs which at least support one of the services defined in this part of ISO 15031 shall support Service 0x01 and PID 0x00. Service 0x01 with PID 0x00 is defined as the universal “initialization/keep alive/ping” message for all emissions-related OBD ECUs.

7.1.2 Message data bytes

7.1.2.1 Request current powertrain diagnostic data request message definition (read-supported PIDs)

Table 20 — Request current powertrain diagnostic data request message (read-supported PIDs)

Data Byte	Parameter Name	Cvt	Hex Value	Mnemonic
#1	Request current powertrain diagnostic data request SID	M	0x01	SIDRQ
#2	PID (see SAE J1979-DA)	M	xx	PID

7.1.2.2 Request current powertrain diagnostic data response message definition (report supported PIDs)

Table 21 — Request current powertrain diagnostic data response message (report supported PIDs)

Data Byte	Parameter Name	Cvt	Hex Value	Mnemonic
#1	Request current powertrain diagnostic data response SID	M	0x41	SIDPR
#2	data record of supported PID = [supported PID data A, data B, data C, data D]	M	xx	PIDREC_ PID
#3		M	xx	DATA_A
#4		M	xx	DATA_B
#5		M	xx	DATA_C
#6		M	xx	DATA_D

7.1.2.3 Request current powertrain diagnostic data request message definition (read PID value)

Table 22 — Request current powertrain diagnostic data request message (read PID value)

Data Byte	Parameter Name	Cvt	Hex Value	Mnemonic
#1	Request current powertrain diagnostic data request SID	M	01	SIDRQ
#2	PID (see SAE J1979-DA)	M/C ^a	xx	PID

^a C = Conditional — PID value is one of the supported PIDs of previous response message.

7.1.2.4 Request current powertrain diagnostic data response message definition (report PID value)

Table 23 — Request current powertrain diagnostic data response message (report PID value)

Data Byte	Parameter Name	Cvt	Hex Value	Mnemonic
#1	Request current powertrain diagnostic data response SID	M	0x41	SIDPR
#2	data record of 1 st supported PID = [PID data A, data B, data C, data D]	M	xx	PIDREC_ PID
#3		M	xx	DATA_A
#4		C ^a	xx	DATA_B
#5		C	xx	DATA_C
#6		C	xx	DATA_D
^a C = Conditional — data B - D depend on selected PID value.				

The PID, which is included in the request message, may be supported by all emission-related ECUs, which shall comply with this specification. Therefore, multiple response messages are sent by the vehicle ECUs.

7.1.3 Parameter definition

7.1.3.1 PIDs supported

SAE J1979-DA specifies the interpretation of the data record of supported PIDs.

7.1.3.2 PID and data byte descriptions

SAE J1979-DA specifies standardized emission-related parameters.

7.1.4 Message example

The example below shows how the “Request current powertrain diagnostic data” service shall be implemented.

7.1.4.1 Step #1: Request supported PIDs from vehicle

The external test equipment requests supported PIDs (PID = 0x00, 0x20) from the vehicle. Refer to SAE J1979-DA to interpret the data bytes in the response messages.

Table 24 — Request current powertrain diagnostic data request message

Message Direction:	External test equipment → All ECUs		
Message Type:	Request		
Data Byte	Description (all values are in hexadecimal)	Byte Value	Mnemonic
#1	Request current powertrain diagnostic data request SID	0x01	SIDRQ
#2	PID used to determine PID support for PIDs 0x01 - 0x20	0x00	PID

Table 25 — Request current powertrain diagnostic data response message

Message Direction:		ECU#1 → External test equipment	
Message Type:		Response	
Data Byte	Description (all values are in hexadecimal)	Byte Value	Mnemonic
#1	Request current powertrain diagnostic data response SID	0x41	SIDPR
#2	PID requested	0x00	PID
#3	Data byte A, representing support for PIDs 0x01, 0x03 – 0x08	10111111b = 0xBF	DATA_A
#4	Data byte B, representing support for PIDs 0x09, 0x0B – 0x10	10111111b = 0xBF	DATA_B
#5	Data byte C, representing support for PIDs 0x11, 0x13, 0x15	10101000b = 0xA8	DATA_C
#6	Data byte D, representing support for PIDs 0x19, 0x1C, 0x20	10010001b = 0x91	DATA_D

Table 26 — Request current powertrain diagnostic data response message

Message Direction:		ECU#2 → External test equipment	
Message Type:		Response	
Data Byte	Description (all values are in hexadecimal)	Byte Value	Mnemonic
#1	Request current powertrain diagnostic data response SID	0x41	SIDPR
#2	PID requested	0x00	PID
#3	Data byte A, representing support for PID 0x01	10000000b = 0x80	DATA_A
#4	Data byte B, representing support for PID 0x0D	00001000b = 0x08	DATA_B
#5	Data byte C, representing no support for PIDs 0x11 – 0x18	00000000b = 0x00	DATA_C
#6	Data byte D, representing no support for PIDs 0x19 – 0x20	00000000b = 0x00	DATA_D

Table 27 — Request current powertrain diagnostic data request message

Message Direction:		External test equipment → All ECUs	
Message Type:		Request	
Data Byte	Description (all values are in hexadecimal)	Byte Value	Mnemonic
#1	Request current powertrain diagnostic data request SID	0x01	SIDRQ
#2	PID requested	0x20	PID

Table 28 — Request current powertrain diagnostic data response message

Message Direction:		ECU#1 → External test equipment	
Message Type:		Response	
Data Byte	Description (all values are in hexadecimal)	Byte Value	Mnemonic
#1	Request current powertrain diagnostic data response SID	0x41	SIDPR
#2	PID requested	0x20	PID
#3	Data byte A, representing support for PID 0x21	10000000b = 0x80	DATA_A
#4	Data byte B, representing no support for PIDs 0x29 – 0x30	00000000b = 0x00	DATA_B
#5	Data byte C, representing no support for PIDs 0x31 – 0x38	00000000b = 0x00	DATA_C
#6	Data byte D, representing no support for PIDs 0x39 – 0x40	00000000b = 0x00	DATA_D

NOTE ECU#2 does not send a response message because it indicated with the previous response message that it does not support PID 0x20.

Now the external test equipment creates an internal list of supported PIDs for each ECU. The ECU#1 (ECM) supports the following PIDs: 0x01, 0x03 – 0x09, 0x0B – 0x11, 0x13, 0x15, 0x19, 0x1C, 0x20, 0x21. The ECU#2 (TCM) supports the PIDs 0x01 and 0x0D.

7.1.4.2 Step #2: Request PID from vehicle

The external test equipment requests the following PID from the vehicle:

- PID 0x01: Number of emission-related powertrain DTCs and MIL status, PID is supported by ECU#1 (ECM) and ECU#2 (TCM)

Table 29 — Request current powertrain diagnostic data request message

Message Direction:		External test equipment → All ECUs	
Message Type:		Request	
Data Byte	Description (all values are in hexadecimal)	Byte Value	Mnemonic
#1	Request current powertrain diagnostic data request SID	0x01	SIDRQ
#2	PID: Number of emission-related powertrain DTCs and MIL status	0x01	PID

Table 30 — Request current powertrain diagnostic data response message

Message Direction:		ECU#1 → External test equipment	
Message Type:		Response	
Data Byte	Description (all values are in hexadecimal)	Byte Value	Mnemonic
#1	Request current powertrain diagnostic data response SID	0x41	SIDPR
#2	PID: Number of emission-related powertrain DTCs and MIL status	0x01	PID
#3	MIL: ON; Number of emission-related powertrain DTCs: 0x01	0x81	DATA_A
#4	Misfire -, Fuel system -, Comprehensive monitoring	0x07	DATA_B
#5	Catalyst -, Heated catalyst -, ..., monitoring supported	0xEF	DATA_C
#6	Catalyst -, Heated catalyst -, ..., monitoring test complete/not complete	0x63	DATA_D

Table 31 — Request current powertrain diagnostic data response message

Message Direction:		ECU#2 → External test equipment	
Message Type:		Response	
Data Byte	Description (all values are in hexadecimal)	Byte Value	Mnemonic
#1	Request current powertrain diagnostic data response SID	0x41	SIDPR
#2	PID: Number of emission-related powertrain DTCs and MIL status	0x01	PID
#3	MIL: OFF; Number of emission-related powertrain DTCs: 0x01	0x01	DATA_A
#4	Comprehensive monitoring: supported, test complete	0x04	DATA_B
#5	Catalyst -, Heated catalyst -, ..., monitoring supported	0x00	DATA_C
#6	Catalyst -, Heated catalyst -, ..., monitoring test complete/not complete	0x00	DATA_D

The ECU#1 (ECM) reports MIL commanded on, one stored DTC, all monitors as supported, catalyst, heated catalyst, oxygen sensor and oxygen sensor heater as not completed, and all other monitors as completed.

The ECU#2 (TCM) reports MIL commanded off, one stored DTC, comprehensive components monitor as supported and complete, and all other monitors as not supported.

The external test equipment requests the following PID from the vehicle:

- PID 0x19: Bank 2 - Sensor 2, PID is supported by ECU#1 (ECM).

Table 32 — Request current powertrain diagnostic data request message

Message Direction:		External test equipment → All ECUs	
Message Type:		Request	
Data Byte	Description (all values are in hexadecimal)	Byte Value	Mnemonic
#1	Request current powertrain diagnostic data request SID	0x01	SIDRQ
#2	PID: Oxygen Sensor Output Voltage (B2 - S2) Short Term Fuel Trim (B2 - S2)	0x19	PID

Table 33 — Request current powertrain diagnostic data response message

Message Direction:		ECU#1 → External test equipment	
Message Type:		Response	
Data Byte	Description (all values are in hexadecimal)	Byte Value	Mnemonic
#1	Request current powertrain diagnostic data response SID	0x41	SIDPR
#2	PID: Oxygen Sensor Output Voltage (B2 - S2) Short Term Fuel Trim (B2 - S2)	0x19	PID
#3	Oxygen Sensor Output Voltage (B2 - S2): 0,8 Volt	0xA0	DATA_A
#4	Short Term Fuel Trim (B2 - S2): 93,7 %	0x78	DATA_B

NOTE ECU#2 does not support PID 0x19 and therefore does not send a response message.

7.2 Service 0x02 — Request powertrain freeze frame data

7.2.1 Functional description

The purpose of this service is to allow access to emission-related data values in a freeze frame. This allows expansion to meet manufacturer-specific requirements not necessarily related to the required freeze frame, and not necessarily containing the same data values as the required freeze frame. The request message includes a parameter identification (PID) value that indicates to the on-board system the specific information requested. PID specifications, scaling information and display formats for the freeze frame are included in SAE J1979-DA.

The ECU(s) shall respond to this message by transmitting the requested data value stored by the system. All data values returned for sensor readings will be actual stored readings, not default or substitute values used by the system because of a fault with that sensor.

Not all PIDs are applicable or supported by all systems. PID 0x00 is a bit-encoded PID that indicates, for each ECU, which PIDs that ECU supports. Therefore, PID 0x00 shall be supported by all ECUs that respond to a

Service 0x02 request as specified, even if the ECU does not have a freeze frame stored at the time of the request.

SAE J1979-DA defines how to encode supported PIDs.

PID 0x02 indicates the DTC that caused the freeze frame data to be stored. If freeze frame data is not stored in the ECU, the system shall report 0x00 0x00 as the DTC. Any data reported when the stored DTC is 0x00 0x00 may not be valid.

The frame number byte shall indicate 0x00 for the mandated freeze frame data. Manufacturers may optionally save additional freeze frames and use this service to obtain that data by specifying the freeze frame number in the request message. If a manufacturer uses these additional freeze frames, they will be stored under conditions specified by the manufacturer, and contain data specified by the manufacturer.

7.2.2 Message data bytes

7.2.2.1 Request powertrain freeze frame data request message definition (read-supported PIDs)

Table 34 — Request powertrain freeze frame data request message (read-supported PIDs)

Data Byte	Parameter Name	Cvt	Hex Value	Mnemonic
#1	Request powertrain freeze frame data request SID	M	0x02	SIDRQ
#2	PID (see SAE J1979-DA)	M	xx	PID
#3	frame #	M	xx	FRNO

7.2.2.2 Request powertrain freeze frame data response message definition (report supported PIDs)

Table 35 — Request powertrain freeze frame data response message (report supported PIDs)

Data Byte	Parameter Name	Cvt	Hex Value	Mnemonic
#1	Request powertrain freeze frame data response SID	M	0x42	SIDPR
#2	PID	M	xx	PID
#3	frame #	M	xx	FRNO
#4	data record of supported PIDs = [Data A: supported PIDs, Data B: supported PIDs, Data C: supported PIDs, Data D: supported PIDs]	M	xx	DATAREC_ DATA_A
#5		M	xx	DATA_B
#6		M	xx	DATA_C
#7		M	xx	DATA_D

7.2.2.3 Request powertrain freeze frame data request message definition (read freeze frame PID value)

Table 36 — Request powertrain freeze frame data request message (read freeze frame PID value)

Data Byte	Parameter Name	Cvt	Hex Value	Mnemonic
#1	Request current powertrain diagnostic data request SID	M	0x02	SIDRQ
#2	PID (see SAE J1979-DA)	M/C ^a	xx	PID
#3	frame #	M	xx	FRNO

^a C = Conditional. PID value shall be one of the supported PIDs of previous response message.

7.2.2.4 Request powertrain freeze frame data response message definition (report freeze frame PID value)

Table 37 — Request powertrain freeze frame data response message (report freeze frame PID value)

Data Byte	Parameter Name	Cvt	Hex Value	Mnemonic
#1	Request powertrain freeze frame data response SID	M	0x42	SIDPR
#2	PID	M	xx	PID
#3	frame #	M	xx	FRNO
#4	data record = [Data A, Data B, Data C, Data D]	M	xx	DATA_REC_ DATA_A
#5		C ^a	xx	DATA_B
#6		C	xx	DATA_C
#7		C	xx	DATA_D

^a C = Conditional. Data B - D depend on selected PID value.

7.2.3 Parameter definition

7.2.3.1 PIDs supported

SAE J1979-DA specifies the interpretation of the data record of supported PIDs.

7.2.3.2 PID and data byte descriptions

SAE J1979-DA specifies standardized emission-related parameters.

7.2.3.3 Frame # description

The frame number identifies the freeze frame, which includes emission-related data values in case an emission-related DTC is detected by the ECU.

7.2.4 Message example

7.2.4.1 General

The example below shows how the “Request powertrain freeze frame data” service shall be implemented.

7.2.4.2 Step #1: Request Supported Powertrain Freeze Frame PIDs from Vehicle

The external test equipment requests all supported powertrain freeze frame PIDs of freeze frame 0x00 from the vehicle. Refer to the example of Service 0x01 on how to request supported PIDs.

As a result of the supported PID request, the external test equipment creates an internal list of supported PIDs for each ECU. ECU#1 (ECM) supports the following PIDs: 0x02 – 0x09, 0x0B – 0x0E. ECU#2 (TCM) does not support any PIDs for this service.

7.2.4.3 Step #2: Request PID 0x02 “DTC which Caused Freeze Frame to be Stored” from Vehicle

7.2.4.3.1 Case #1: Freeze Frame data are stored in ECU#1

Now the external test equipment requests PID 0x02 of freeze frame 0x00 from the vehicle. Since the ECU#2 (TCM) does not store a freeze frame data record, only the ECU#1 (ECM) will send a response message.

In this example, the freeze frame data are stored based on a DTC P0130 occurrence. The parameter value of PID 0x02 “DTC that caused required freeze frame data storage” is set to the DTC P0130.

Table 38 — Request powertrain freeze frame data request message

Message Direction:		External test equipment → All ECUs	
Message Type:		Request	
Data Byte	Description (all values are in hexadecimal)	Byte Value	Mnemonic
#1	Request powertrain freeze frame data request SID	0x02	SIDRQ
#2	PID: DTC that caused required freeze frame data storage	0x02	PID
#3	Frame #	0x00	FRNO

Table 39 — Request powertrain freeze frame data response message

Message Direction:		ECU#1 → External test equipment	
Message Type:		Response	
Data Byte	Description (all values are in hexadecimal)	Byte Value	Mnemonic
#1	Request powertrain freeze frame data response SID	0x42	SIDPR
#2	PID: DTC that caused required freeze frame data storage	0x02	PID
#3	Frame #: 00	0x00	FRNO
#4	DTC High Byte of P0130	0x01	DATA_A
#5	DTC Low Byte of P0130	0x30	DATA_B

7.2.4.3.2 Case #2: No freeze frame data are stored in any ECU

If no freeze frame data are stored, then the ECU(s) which support this service but do not have any freeze frame stored shall send a response message with the parameter values of DATA_A and DATA_B of PID 0x02 “DTC that caused required freeze frame data storage” set to 0x0000.

Table 40 — Request powertrain freeze frame data request message

Message Direction:		External test equipment → All ECUs	
Message Type:		Request	
Data Byte	Description (all values are in hexadecimal)	Byte Value	Mnemonic
#1	Request powertrain freeze frame data request SID	0x02	SIDRQ
#2	PID: DTC that caused required freeze frame data storage	0x02	PID
#3	Frame #: 00	0x00	FRNO

Table 41 — Request powertrain freeze frame data response message
(Service 0x02, PID 0x02, Frame # 0x00)

Message Direction:		ECU#1 → External test equipment	
Message Type:		Response	
Data Byte	Description (all values are in hexadecimal)	Byte Value	Mnemonic
#1	Request powertrain freeze frame data response SID	0x42	SIDPR
#2	PID: DTC that caused required freeze frame data storage	0x02	PID
#3	Frame #: 00	0x00	FRNO
#4	DTC High Byte: zero value indicates that no freeze frame is stored	0x00	DATA_A
#5	DTC Low Byte: zero value indicates that no freeze frame is stored	0x00	DATA_B

NOTE The DTC value reported is 0x00 0x00, therefore no valid freeze frame data are stored for supported PIDs.

7.3 Service 0x03 — Request emission-related diagnostic trouble codes

7.3.1 Functional description

The purpose of this service is to enable the external test equipment to obtain “confirmed” emission-related DTCs. This shall be a two-step process for the external test equipment:

- Step 1: Send a Service 0x01, PID 0x01 request to get the number of emission-related DTCs from all ECUs that have this available. Each ECU that has a DTC(s) stored will respond with a message that includes the number of stored codes to be reported. If an ECU that is capable of storing emission-related DTCs does not have stored DTCs, then that ECU shall respond with a message indicating zero (0) DTCs are stored.
- Step 2: Send a Service 0x03 request for all emission-related DTCs. Each ECU that has DTCs will respond with one or more messages, each containing up to three (3) DTCs. If no emission-related DTCs are stored in the ECU, then the ECU may not respond to this request.

If additional DTCs are set between the time that the number of DTCs is reported by an ECU, and the DTCs are reported by an ECU, then the number of DTCs reported could exceed the number expected by the external test equipment. In this case, the external test equipment shall repeat this cycle until the number of DTCs reported equals the number expected based on the Service 0x01, PID 0x01 response.

DTCs are transmitted in two (2) bytes of information for each DTC. The first two (2) bits (high order) of the first (1) byte for each DTC indicate whether the DTC is a Powertrain, Chassis, Body, or Network DTC (refer to SAE J2012 for additional interpretation of this structure). The second two (2) bits shall indicate the first (1) digit of the DTC (0 through 3). The second (2) nibble of the first (1) byte and the entire second (2) byte are the next three (3) hexadecimal characters of the actual DTC reported hexadecimal. A powertrain DTC transmitted as 0x0143 shall be displayed as P0143 (see Figure 17).

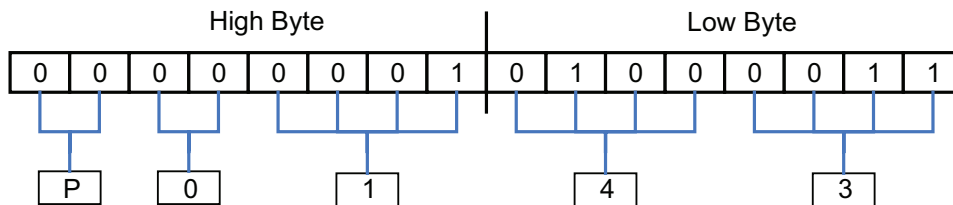

Figure 17 — Diagnostic trouble code encoding example DTC P0143

If fewer than three (3) DTCs are reported, the response message used to report DTCs shall have their unused bytes set to zero (0) to maintain the required fixed message length for all messages. If there are no DTCs to report, a response message is allowed, but not required for SAE J1850 and ISO 9141-2 interfaces. For ISO 14230-4 interfaces, the ECU will respond with a report containing no DTCs (DTC#1, DTC#2, and DTC#3 shall be all set to 0x00).

7.3.2 Message data bytes

7.3.2.1 Request current powertrain diagnostic data request message definition (PID 0x01)

Table 42 — Request current powertrain diagnostic data request message (PID 0x01)

Data Byte	Parameter Name	Cvt	Hex Value	Mnemonic
#1	Request current powertrain diagnostic data request SID	M	0x01	SIDRQ
#2	PID {Number of emission-related DTCs and MIL status}	M	0x01	PID

7.3.2.2 Request current powertrain diagnostic data response message definition (PID 0x01)

Table 43 — Request current powertrain diagnostic data response message (PID 0x01)

Data Byte	Parameter Name	Cvt	Hex Value	Mnemonic
#1	Request current powertrain diagnostic data response SID	M	0x41	SIDPR
#2	PID {Number of emission-related DTCs and MIL status}	M	0x01	PID
#3	data record = [Data A, Data B, Data C, Data D]	M	xx	DATA_REC_ DATA_A
#4		M	xx	DATA_B
#5		M	xx	DATA_C
#6		M	xx	DATA_D

7.3.2.3 Request emission-related DTC request message definition

Table 44 — Request emission-related DTC request message

Data Byte	Parameter Name	Cvt	Hex Value	Mnemonic
#1	Request emission-related DTC request SID	M	0x03	SIDRQ

7.3.2.4 Request emission-related DTC response message definition

Table 45 — Request emission-related DTC response message

Data Byte	Parameter Name	Cvt	Hex Value	Mnemonic
#1	Request emission-related DTC response SID	M	0x43	SIDPR
#2	DTC#1 (High Byte)	M/C ^a	xx	DTC1HI
#3	DTC#1 (Low Byte)	M/C	xx	DTC1LO
#4	DTC#2 (High Byte)	M/C	xx	DTC2HI
#5	DTC#2 (Low Byte)	M/C	xx	DTC2LO
#6	DTC#3 (High Byte)	M/C	xx	DTC3HI
#7	DTC#3 (Low Byte)	M/C	xx	DTC3LO

^a C = Conditional. DTC#1, DTC#2, and DTC#3 are always present. If no valid DTC number is included the DTC values shall contain 0x00.

7.3.3 Parameter definition

This service does not support any parameters.

7.3.4 Message example

The example below shows how the “Request emission-related DTCs” service shall be implemented. The external test equipment requests emission-related DTCs from the vehicle. The vehicle supports the ISO 14230-4 protocol. The ECU#1 (ECM) has six (6) DTCs stored, the ECU#2 (TCM) has one (1) DTC stored, and the ECU#3 (ABS/Traction Control) has no DTC stored.

- ECU#1 (ECM): P0143, P0196, P0234, P02CD, P0357, P0A24
- ECU#2 (TCM): P0443
- ECU#3 (ABS/Traction Control): no DTC stored (response message is optional for ISO 9141-2 and SAE J1850)

The external test equipment requests the following PID from the vehicle:

- PID 0x01: Number of emission-related DTCs and MIL status, PID is supported by ECU#1 (ECM), ECU#2 (TCM), and ECU#3 (ABS/Traction Control)

Table 46 — Request current powertrain diagnostic data request message

Message Direction:		External test equipment → All ECUs	
Message Type:		Request	
Data Byte	Description (all values are in hexadecimal)	Byte Value	Mnemonic
#1	Request current powertrain diagnostic data request SID	0x01	SIDRQ
#2	PID: Number of emission-related DTCs and MIL status	0x01	PID

Table 47 — Request current powertrain diagnostic data response message

Message Direction:		ECU#1 → External test equipment	
Message Type:		Response	
Data Byte	Description (all values are in hexadecimal)	Byte Value	Mnemonic
#1	Request current powertrain diagnostic data response SID	0x41	SIDPR
#2	PID: Number of emission-related DTCs and MIL status	0x01	PID
#3	MIL: ON; Number of emission-related DTCs: 0x06	0x86	DATA_A
#4	Misfire -, Fuel system -, Comprehensive monitoring	0x33	DATA_B
#5	Catalyst -, Heated catalyst -, ..., monitoring supported	0xFF	DATA_C
#6	Catalyst -, Heated catalyst -, ..., monitoring test complete/not complete	0x63	DATA_D

Table 48 — Request current powertrain diagnostic data response message

Message Direction:		ECU#2 → External test equipment	
Message Type:		Response	
Data Byte	Description (all values are in hexadecimal)	Byte Value	Mnemonic
#1	Request current powertrain diagnostic data response SID	0x41	SIDPR
#2	PID: Number of emission-related DTCs and MIL status	0x01	PID
#3	MIL: OFF; Number of emission-related DTCs: 0x01	0x01	DATA_A
#4	Comprehensive monitoring: supported, test complete	0x44	DATA_B
#5	Catalyst -, Heated catalyst -, ..., monitoring supported	0x00	DATA_C
#6	Catalyst -, Heated catalyst -, ..., monitoring test complete/not complete	0x00	DATA_D

Table 49 — Request current powertrain diagnostic data response message

Message Direction:		ECU#3 → External test equipment	
Message Type:		Response	
Data Byte	Description (all values are in hexadecimal)	Byte Value	Mnemonic
#1	Request current powertrain diagnostic data response SID	0x41	SIDPR
#2	PID: Number of emission-related DTCs and MIL status	0x01	PID
#3	MIL: OFF; Number of emission-related DTCs: 0x00	0x00	DATA_A
#4	Comprehensive monitoring: supported, test complete	0x00	DATA_B
#5	Catalyst -, Heated catalyst -, ..., monitoring supported	0x00	DATA_C
#6	Catalyst -, Heated catalyst -, ..., monitoring test complete/not complete	0x00	DATA_D

The external test equipment requests emission-related DTCs because ECU#1 has six (6) DTCs stored, ECU#2 has one (1) DTC stored, and ECU#3 has no (0) DTC stored.

Table 50 — Request emission-related diagnostic trouble codes request message

Message Direction:		External test equipment → All ECUs	
Message Type:		Request	
Data Byte	Description (all values are in hexadecimal)	Byte Value	Mnemonic
#1	Request emission-related DTC request SID	0x03	SIDRQ

Table 51 — Request emission-related diagnostic trouble codes response message

Message Direction:		ECU#1 → External test equipment	
Message Type:		Response	
Data Byte	Description (all values are in hexadecimal)	Byte Value	Mnemonic
#1	Request emission-related DTC response SID	0x43	SIDPR
#2	DTC#1 High Byte of P0143	0x01	DTC1HI
#3	DTC#1 Low Byte of P0143	0x43	DTC1LO
#4	DTC#2 High Byte of P0196	0x01	DTC2HI
#5	DTC#2 Low Byte of P0196	0x96	DTC2LO
#6	DTC#3 High Byte of P0234	0x02	DTC3HI
#7	DTC#3 Low Byte of P0234	0x34	DTC3LO

Table 52 — Request emission-related diagnostic trouble codes response message

Message Direction:		ECU#2 → External test equipment	
Message Type:		Response	
Data Byte	Description (all values are in hexadecimal)	Byte Value	Mnemonic
#1	Request emission-related DTC response SID	0x43	SIDPR
#2	DTC#1 High Byte of P0443	0x04	DTC1HI
#3	DTC#1 Low Byte of P0443	0x43	DTC1LO
#4	DTC#2 High Byte: 0x00	0x00	DTC2HI
#5	DTC#2 Low Byte: 0x00	0x00	DTC2LO
#6	DTC#3 High Byte: 0x00	0x00	DTC3HI
#7	DTC#3 Low Byte: 0x00	0x00	DTC3LO

Table 53 — Request emission-related diagnostic trouble codes response message

Message Direction:		ECU#1 → External test equipment	
Message Type:		Response	
Data Byte	Description (all values are in hexadecimal)	Byte Value	Mnemonic
#1	Request emission-related DTC response SID	0x43	SIDPR
#2	DTC#1 High Byte of P02CD	0x02	DTC1HI
#3	DTC#1 Low Byte of P02CD	0xCD	DTC1LO
#4	DTC#2 High Byte of P0357	0x03	DTC2HI
#5	DTC#2 Low Byte of P0357	0x57	DTC2LO
#6	DTC#3 High Byte of P0A24	0x0A	DTC3HI
#7	DTC#3 Low Byte of P0A24	0x24	DTC3LO

Table 54 — Request emission-related diagnostic trouble codes response message

Message Direction:		ECU#3 → External test equipment	
Message Type:		Response	
Data Byte	Description (all values are in hexadecimal)	Byte Value	Mnemonic
#1	Request emission-related DTC response SID	0x43	SIDPR
#2	DTC#1 High Byte: 00	0x00	DTC1HI
#3	DTC#1 Low Byte: 00	0x00	DTC1LO
#4	DTC#2 High Byte: 00	0x00	DTC2HI
#5	DTC#2 Low Byte: 00	0x00	DTC2LO
#6	DTC#3 High Byte: 00	0x00	DTC3HI
#7	DTC#3 Low Byte: 00	0x00	DTC3LO

NOTE For ISO 9141-2 and SAE J1850 protocols, the ECU#3 response message is optional because there is no DTC stored. If ISO 14230-4 protocol is supported by the vehicle, ECU#3 shall send a positive response message with no DTCs.

7.4 Service 0x04 — Clear/Reset emission-related diagnostic information

7.4.1 Functional description

The purpose of this service is to provide a means for the external test equipment to command ECUs to clear all emission-related diagnostic information. This includes:

- MIL and number of diagnostic trouble codes (can be read with Service 0x01, PID 0x01)
- clear the I/M (Inspection/Maintenance) readiness bits (can be read with Service 0x01, PID 0x01)
- confirmed diagnostic trouble codes (can be read with Service 0x03)
- pending diagnostic trouble codes (can be read with Service 0x07)
- diagnostic trouble code for freeze frame data (can be read with Service 0x02, PID 0x02)
- freeze frame data (can be read with Service 0x02)
- oxygen sensor test data (can be read with Service 0x05)
- status of system monitoring tests (can be read with Service 0x01, PID 0x41)
- on-board monitoring test results (can be read with Service 0x06)
- distance traveled while MIL is activated (can be read with Service 0x01, PID 0x21)
- number of warm-ups since DTCs cleared (can be read with Service 0x01, PID 0x30)
- distance traveled since DTCs cleared (can be read with Service 0x01, PID 0x31)
- engine run time while MIL is activated (can be read with Service 0x01, PID 0x4D)
- engine run time since DTCs cleared (can be read with Service 0x01, PID 0x4E)

Other manufacturer-specific “clearing/resetting” actions may also occur in response to this request message. For safety and/or technical design reasons, some ECUs may not respond to this service under all conditions. All ECUs shall respond to this service request with the ignition ON and with the engine not running. ECUs that cannot perform this operation under other conditions, such as with the engine running, will ignore the request with SAE J1850 and ISO 9141-2 interfaces, or will send a negative response message with ISO 14230-4 interfaces, as described in ISO 14230-4.

7.4.2 Message data bytes

7.4.2.1 Clear/Reset emission-related diagnostic information request message definition

Table 55 — Clear/Reset emission-related diagnostic information request message

Data Byte	Parameter Name	Cvt	Hex Value	Mnemonic
#1	Clear/reset emission-related diagnostic information request SID	M	04	SIDRQ

7.4.2.2 Clear/Reset emission-related diagnostic information response message definition

Table 56 — Clear/Reset emission-related diagnostic information response message

Data Byte	Parameter Name	Cvt	Hex Value	Mnemonic
#1	Clear/reset emission-related diagnostic information response SID	M	44	SIDPR

7.4.3 Parameter definition

This service does not support any parameters.

7.4.4 Message example

This example is based on the example of Service 0x03 as described in 7.3.4. The external test equipment commands the vehicle to clear/reset emission-related diagnostic information with the engine running. The ECU#1 (ECM) and ECU#2 (TCM) will send a response message to confirm that all emission-related diagnostic information is cleared. For ISO 9141-2 and SAE J1850 protocols, ECU#3 (ABS/Traction Control) will not send a response message because the conditions to perform the requested action are not met. For ISO 14230-4 protocol, ECU#3 will send a negative response message with response code 0x22 - conditionsNotCorrect. In such case the external test equipment shall post a message with “Stop engine and turn ON ignition” and then repeat the Service 0x04 command and check for response messages from all emission-related ECUs installed in the vehicle.

Table 57 — Clear/Reset emission-related diagnostic information request message

Message Direction:		External test equipment → All ECUs		
Message Type:		Request		
Data Byte	Description (all values are in hexadecimal)	Byte Value	Mnemonic	
#1	Clear/reset emission-related diagnostic information request SID	0x04	SIDRQ	

Table 58 — Clear/Reset emission-related diagnostic information response message

Message Direction:		ECU#1 → External test equipment		
Message Type:		Response		
Data Byte	Description (all values are in hexadecimal)	Byte Value	Mnemonic	
#1	Clear/reset emission-related diagnostic information response SID	0x44	SIDPR	

Table 59 — Clear/Reset emission-related diagnostic information response message

Message Direction:		ECU#2 → External test equipment		
Message Type:		Response		
Data Byte	Description (all values are in hexadecimal)	Byte Value	Mnemonic	
#1	Clear/reset emission-related diagnostic information response SID	0x44	SIDPR	

Table 60 — Negative response message

Message Direction:		ECU#3 → External test equipment	
Message Type:		Response	
Data Byte	Description (all values are in hexadecimal)	Byte Value	Mnemonic
#1	Negative Response Service Identifier	0x7F	SIDNR
#2	Clear/reset emission-related diagnostic information request SID	0x04	SIDRQ
#3	Negative Response Code: conditionsNotCorrect	0x22	NR_CNC

For ISO 14230-4 protocol, the conditions of ECU#3 to Clear/reset emissions-related diagnostic information is not met. Therefore, ECU#3 sends a negative response message with response code “conditionsNotCorrect”. The external test equipment shall repeat the request after the conditions of the vehicle have changed by the user. Now, all ECUs shall send a positive response message to the external test equipment to confirm successful operation of the Clear/reset emission-related diagnostic information service.

7.5 Service 0x05 — Request oxygen sensor monitoring test results

7.5.1 Functional description

The purpose of this service is to allow access to the on-board oxygen sensor monitoring test results. The same information may be obtained by the use of Service 0x06.

The request message for test results includes a Test ID value that indicates the information requested. Test value definitions, scaling information, and display formats are included in SAE J1979-DA.

Many methods may be used to calculate test results for this service by different manufacturers. If data values are to be reported using these messages that are different from those specified, ranges of test values have been assigned that can be used which have standard units of measure. The external test equipment can convert these values and display them in the standard units.

The ECU shall respond to this message by transmitting the requested test data last determined by the system. The latest test results are to be retained, even over multiple ignition OFF cycles, until replaced by more recent test results. Test results are requested by Test ID.

Not all test values are applicable or supported by all vehicles. An optional feature of this service is for the ECU to indicate which Test IDs are supported. Test ID 0x00 is a bit-encoded value that indicates support for Test IDs from 0x01 to 0x20. Test ID 0x20 indicates support for Test IDs 0x21 through 0x40, etc. This is the same concept as used for PID support in Services 0x01 and 0x02 as specified in SAE J1979-DA. If Test ID 0x00 is not supported, then the ECU does not use this feature to indicate Test ID support.

7.5.2 Message data bytes

7.5.2.1 Request oxygen sensor monitoring test results request message definition (read-supported TIDs)

Table 61 — Request oxygen sensor monitoring test results request message (read-supported TIDs)

Data Byte	Parameter Name	Cvt	Hex Value	Mnemonic
#1	Request oxygen sensor monitoring test results request SID	M	0x05	SIDRQ
#2	Test ID (see SAE J1979-DA)	M	xx	TID
#3	O2 Sensor #	M	xx	O2SNO

Table 62 — Request oxygen sensor monitoring test results response message (report supported TIDs)

Data Byte	Parameter Name	Cvt	Hex Value	Mnemonic
#1	Request oxygen sensor monitoring test results response SID	M	0x45	SIDPR
#2	Test ID	M	xx	TID
#3	O2 Sensor #	M	xx	O2SNO
#4	data record of supported Test IDs = [Data A: supported Test IDs, Data B: supported Test IDs, Data C: supported Test IDs, Data D: supported Test IDs]	M	xx	DATA_A
#5		M	xx	DATA_B
#6		M	xx	DATA_C
#7		M	xx	DATA_D

7.5.2.2 Request oxygen sensor monitoring test results request message definition (read TID values)

Table 63 — Request oxygen sensor monitoring test results request message (read TID values)

Data Byte	Parameter Name	Cvt	Hex Value	Mnemonic
#1	Request oxygen sensor monitoring test results request SID	M	0x05	SIDRQ
#2	Test ID	M	xx	TID
#3	O2 Sensor #	M	xx	O2SNO

7.5.2.3 Request oxygen sensor monitoring test results response message definition (report TID values)

Table 64 — Request oxygen sensor monitoring test results response message (report TID values)

Data Byte	Parameter Name	Cvt	Hex Value	Mnemonic
#1	Request oxygen sensor monitoring test results response SID	M	0x45	SIDPR
#2	TEST ID	M	xx	TID
#3	O2 Sensor #	M	xx	O2SNO
#4	data record of Test ID = [Test Value Minimum Limit Maximum Limit]	M	xx	TESTVAL
#5		C ^a	xx	MINLIMIT
#6		C	xx	MAXLIMIT

^a C = Conditional. If the supported Test ID is a constant (0x01 – 0x04), the parameters Minimum and Maximum Limit shall not be included.

7.5.3 Parameter definition

7.5.3.1 Test IDs supported

The Test IDs supported is the same concept as used for PID support in Services 0x01 and 0x02 as specified in SAE J1979-DA.

7.5.3.2 Test ID and data byte descriptions

SAE J1979-DA specifies standardized and vehicle manufacturer specific Test ID ranges.

7.5.3.3 Oxygen sensor location definition

The oxygen sensor location value used in the request message shall indicate the oxygen sensor location as defined by PID 0x13 or 0x1D as specified in SAE J1979-DA.

Table 65 — Oxygen sensor location description

Oxygen sensor location (one, and only one bit can be set to a 1)		
Bit	Sensor location ^a	Alternative sensor location ^b
0	Bank 1 - Sensor 1	Bank 1 - Sensor 1
1	Bank 1 - Sensor 2	Bank 1 - Sensor 2
2	Bank 1 - Sensor 3	Bank 2 - Sensor 1
3	Bank 1 - Sensor 4	Bank 2 - Sensor 2
4	Bank 2 - Sensor 1	Bank 3 - Sensor 1
5	Bank 2 - Sensor 2	Bank 3 - Sensor 2
6	Bank 2 - Sensor 3	Bank 4 - Sensor 1
7	Bank 2 - Sensor 4	Bank 4 - Sensor 2

^a If Service 0x01 PID 0x13 supported.

^b If Service 0x01 PID 0x1D supported.

7.5.3.4 Test result description

Table 66 — Test result description

Hex	# of bytes	Description
0x00 – 0xFF	1	The Test result parameter includes either a constant or a calculated value depending on the Test ID.

7.5.3.5 Minimum and maximum test limit description

The minimum and maximum test limit description shown in Table 67 defines the test limit value which is either a minimum or a maximum value to which the test results are compared. The test limit is a one-byte unsigned numeric value (0 - 255).

Table 67 — Minimum and maximum test limit description

Test Limit	# of bytes	Description
Minimum	1	The minimum test limit (only for calculated test result) is the minimum value to which the test result is compared.
Maximum	1	The maximum test limit (only for calculated test result) is the maximum value to which the test result is compared.

For results of latest mandated on-board oxygen sensor monitoring test, see Figure 18.

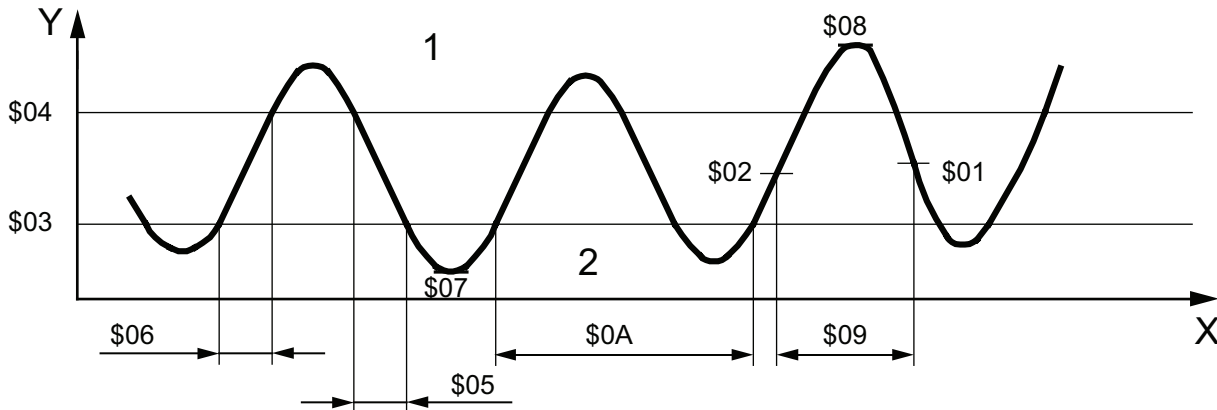

Key
 1 rich
 2 lean

Figure 18 — Test ID value example

7.5.4 Message example

The example below shows how the “Request oxygen sensor monitoring test results” service shall be implemented.

7.5.4.1 Step #1: Request oxygen sensor monitoring test results (request for supported Test IDs) from vehicle

The external test equipment requests all supported Test IDs from the vehicle. Refer to the example of Service 0x01 for how to request supported PIDs (same concept is used for supported TIDs). PID 0x13 is supported by ECU#1. This is important information for the external test equipment in order to identify the correct O2 Sensor location.

As a result of the supported TID request, the external test equipment creates an internal list of supported TIDs for each ECU: The ECU#1 (ECM) supports Test IDs 0x01 - 0x06, 0x70, 0x71 and 0x81. The ECU#2 (TCM) does not support any Test IDs.

7.5.4.2 Step #2: Request oxygen sensor monitoring test results from vehicle

The external test equipment sends two (2) “Request oxygen sensor monitoring test results” request messages to the vehicle. The two (2) request messages include the following Test IDs:

- 1st request message: Test IDs 0x01
- 2nd request message: Test IDs 0x05

NOTE In general, the external test equipment should read the test status of Service 0x01 PID 0x01 prior to execution Service 0x05 with Test ID 0x01 and 0x05 to verify whether the tests are supported and completed. The test values reported may be invalid if the test is not completed.

Table 68 — Request oxygen sensor monitoring test results request message

Message Direction:		External test equipment → All ECUs	
Message Type:		Request	
Data Byte	Description (all values are in hexadecimal)	Byte Value	Mnemonic
#1	Request oxygen sensor monitoring test results request SID	0x05	SIDRQ
#2	TID: Rich to lean sensor threshold voltage (constant)	0x01	TID
#3	O2 Sensor #: Bank 1 - Sensor 1	0x01	O2SNO

Table 69 — Request oxygen sensor monitoring test results response message

Message Direction:		ECU#1 → External test equipment	
Message Type:		Response	
Data Byte	Description (all values are in hexadecimal)	Byte Value	Mnemonic
#1	Request oxygen sensor monitoring test results response SID	0x45	SIDPR
#2	TID: Rich to lean sensor threshold voltage (constant)	0x01	TID
#3	O2 Sensor #: Bank 1 - Sensor 1	0x01	O2SNO
#4	Test Limit: 450 mV	0x5A	TESTVAL

NOTE ECU#2 does not support any Test IDs and therefore does not send a response message.

Table 70 — Request oxygen sensor monitoring test results request message

Message Direction:		External test equipment → All ECUs	
Message Type:		Request	
Data Byte	Description (all values are in hexadecimal)	Byte Value	Mnemonic
#1	Request oxygen sensor monitoring test results request SID	0x05	SIDRQ
#2	TID: Rich to lean sensor switch time (calculated)	0x05	TID
#3	O2 Sensor #: Bank 1 - Sensor 1	0x01	O2SNO

Table 71 — Request oxygen sensor monitoring test results response message

Message Direction:		ECU#1 → External test equipment	
Message Type:		Response	
Data Byte	Description (all values are in hexadecimal)	Byte Value	Mnemonic
#1	Request oxygen sensor monitoring test results response SID	0x45	SIDPR
#2	TID: Rich to lean sensor switch time (calculated)	0x05	TID
#3	O2 Sensor #: Bank 1 - Sensor 1	0x01	O2SNO
#4	Test Limit: 72 ms (milliseconds)	0x12	TESTVAL
#5	Minimum Limit: 0 ms	0x00	MINLIMIT
#6	Maximum Limit: 100 ms	0x19	MAXLIMIT

7.6 Service 0x06 — Request On-board monitoring test results for Specific monitored systems

7.6.1 Functional description

The purpose of this service is to allow access to the results of On-Board Diagnostic monitoring tests for specific components/systems. Examples are catalyst monitoring and the evaporative system monitoring.

The vehicle manufacturer is responsible for assigning Test IDs and Component IDs for tests of different systems and components. The latest valid test results are to be retained, even over multiple ignition OFF cycles, until replaced by more recent test results. Test results are requested by Test ID. Test results are reported only for supported combinations of test limit type and component ID, and are reported as positive (unsigned) values. Only one test limit is included in a response message, but that limit could be either a minimum or a maximum limit. If both a minimum and maximum test limit are to be reported, then two (2) response messages will be transmitted, in any order. The most significant bit (MSB) of the “test limit type/component ID” byte will be used to indicate the test limit type.

A feature of this service is for the ECU to indicate which Test IDs are supported. Test ID 0x00 is a bit-encoded value that indicates support for Test IDs from 0x01 to 0x20. Test ID 0x20 indicates support for Test IDs 0x21 through 0x40, etc. This is the same concept as used for PID support in Services 0x01 and 0x02 as specified in SAE J1979-DA.

This service can be used as an alternative to Service 0x05 to report oxygen sensor test results.

A unique method must be utilized for displaying data for monitors that have multiple tests. Many OBD monitors have multiple tests that are done in either a serial or parallel manner. If a monitor uses multiple Test ID/Component ID combinations that may not all complete at the same time, the following method shall be used to update the stored test results at the time of monitor completion.

After the monitor completes, update all Test ID/Component ID combinations (or “test results”) that were utilized by the monitor with appropriate passing or failing results. If a test result (or “Test ID/Component ID”) was not utilized during this monitoring event, set the Test Values and Minimum and Maximum Test Limits to their initial values (test not completed). Test results from the previously completed monitoring events shall not be mixed with test results from the current completed monitoring event.

In some cases, test results (or “Test ID/Component ID combinations”) will be displayed as being incomplete even though the monitor (as indicated by PID 0x41) was successfully completed and either passed or failed. In other cases, some Test IDs will show passing results while others will show failing results after the monitor (as indicated by PID 0x41) was successfully completed and failed. Note that OBD-II regulations prohibit a passing monitor from showing any failing test results. If an initial serial test indicates a failure and a subsequent re-test of the system indicates a passing result, the test that was utilized to make the passing determination should be displayed, while the failing test that was utilized to make the initial determination should be reset to its initial values (test not completed).

As an example of a serial monitor, an evaporative system monitor can fail for a large evaporative system leak and never continue to test for small leaks or very small leaks. In this case, the Component ID for the large leak would show a failing result, while the small leak test and the very small leak test would show incomplete. As an example of the parallel monitor, a purge valve flow monitor can pass by having a large rich lambda shift, a large lean lambda shift or a large engine rpm increase. If the purge valve is activated and a large rich lambda shift occurs, the Component ID for the rich lambda shift would show a passing result while the other two Component IDs would show incomplete. Since some Component IDs for a completed monitor will show incomplete, PID 0x41 must be used to determine monitor completion status.

7.6.2 Message data bytes

7.6.2.1 Request On-board monitoring test results for specific monitored systems request message definition (read-supported TIDs)

Table 72 — Request on-board monitoring test results for specific monitored systems request message (read-supported TIDs)

Data Byte	Parameter Name	Cvt	Hex Value	Mnemonic
#1	Request on-board monitoring test results for specific monitored systems request SID	M	0x06	SIDRQ
#2	Test ID (see SAE J1979-DA)	M	xx	TID

7.6.2.2 Request On-board monitoring test results for specific monitored systems response message definition (report supported TIDs)

Table 73 — Request on-board monitoring test results for specific monitored systems response message (report supported TIDs)

Data Byte	Parameter Name	Cvt	Hex Value	Mnemonic
#1	Request on-board monitoring test results for specific monitored systems response SID	M	0x46	SIDPR
#2	Test ID	M	xx	TID
#3	Filler Byte	M	0xFF	FB
#4	data record of supported Test IDs = [Data A: supported Test IDs, Data B: supported Test IDs, Data C: supported Test IDs, Data D: supported Test IDs]	M	xx	DATAREC_ DATA_A
#5		M	xx	DATA_B
#6		M	xx	DATA_C
#7		M	xx	DATA_D

7.6.2.3 Request On-board monitoring test results for Specific monitored systems request message definition (read test results)

Table 74 — Request on-board monitoring test results for specific monitored systems request message (read test results)

Data Byte	Parameter Name	Cvt	Hex Value	Mnemonic
#1	Request on-board monitoring test results for specific monitored systems request SID	M	0x06	SIDRQ
#2	Test ID (request test results)	M	xx	TID

7.6.2.4 Request on-board monitoring test results for Specific monitored systems response message definition (report test results)

Table 75 — Request on-board monitoring test results for specific monitored systems response message (report test results)

Data Byte	Parameter Name	Cvt	Hex Value	Mnemonic
#1	Request on-board monitoring test results for specific monitored systems response SID	M	0x46	SIDPR
#2	Test ID (report test results)	M	xx	TID
#3	Test Limit Type & Component ID	M	xx	TLTCID
#4	data record of Test ID = [M	xx	TIDREC_
#5	Test Value (High Byte)	M	xx	TVHI
#6	Test Value (Low Byte)	M	xx	TVLO
#7	Test Limit (High Byte)	C ^a	xx	TLHI
	Test Limit (Low Byte)]	C	xx	TLLO

^a C = Conditional. If Test Limit is either a Minimum or a Maximum Limit depends on the parameter Test Limit Type & Component ID value (bit 7).

7.6.3 Parameter definition

7.6.3.1 Test IDs supported

The Test IDs supported is the same concept as used for PID support in Services 0x01 and 0x02 as specified in SAE J1979-DA.

7.6.3.2 Test ID and data byte descriptions

SAE J1979-DA specifies standardized and vehicle manufacturer-specific Test ID ranges, which are permitted to be supported in this service.

NOTE For ISO 9141-2, SAE J1850 and ISO 14230-4 protocols that SAE J1979-DA is recommended but not required. This is for backward compatibility and only applies to Test ID range 0x01 – 0x1F.

7.6.3.3 Test Limit Type and Component ID description

The Test Limit Type and Component ID is a one (1) byte parameter and are defined in Table 76.

Table 76 — Test Limit Type and Component ID description

Parameter Name	Bit	Description
Component ID	0 - 6	Component ID - manufacturer specified - necessary when multiple components or systems are present on the vehicle and have the same definition of Test ID. If the same test is performed on more than one component, multiple test results shall be reported for that Test ID. For example, a test for bank 1 catalyst can be the same as a test for a bank 2 catalyst, or a test for a pre-catalyst oxygen sensor can be the same as a test for a post-catalyst oxygen sensor. In either case, a request for a single Test ID would result in two test results being reported with different Component IDs.
Test Limit Type	7	Most Significant Bit (MSB) indicates type of test limit, where: 0 - test limit is maximum value - test fails if test value is greater than this value; and 1 - test limit is minimum value - test fails if test value is less than this value.

7.6.3.4 Test Result description

The Test Result represents the test result and is defined in Table 77.

Table 77 — Test Result description

Parameter Name	# of Bytes	Description
Test Result	2 (High and Low Byte)	Test Result - this value shall be less than or equal to the test limit if MSB of Test Limit Type and Component ID byte is "0", and shall be greater than or equal to the test limit if MSB of Test Limit Type and Component ID byte is "1". The Test Value is a two-byte unsigned numeric value (0 - 65535).

7.6.3.5 Test Limit description

The Test Limit is defined in Table 78.

Table 78 — Test Limit description

Parameter Name	# of Bytes	Description
Test Limit	2 (High and Low Byte)	The Test Limit value is either a minimum or a maximum value to which the test results are compared. The Test Limit is a two-byte unsigned numeric value (0 - 65535).

7.6.4 Message example

Tables 79 to 81 below show how the "request on-board monitoring test results for specific monitored systems" service shall be implemented.

7.6.4.1 Step #1: Request on-board monitoring test results for specific monitored systems (request for supported Test IDs)

The external test equipment requests all supported Test IDs from the vehicle. Refer to the example of Service 0x01 for guidance on requesting supported PIDs (the same concept is used for supported TIDs).

As a result of the supported TID request, the external test equipment creates an internal list of supported TIDs for each ECU. ECU#1 (ECM) supports Test ID 0x02. ECU#2 (TCM) does not support any Test IDs.

7.6.4.2 Step #2: Request on-board monitoring test results for specific monitored systems

The external test equipment sends a "request on-board monitoring test results for specific monitored systems" request message with one (1) supported Test ID to the vehicle. The response messages indicate which Component IDs are supported. The request message includes the following Test ID:

Test ID 0x02 - Lean to rich sensor threshold voltage (constant), (supported Component IDs: 0x04, 0x16).

In general, the external test equipment should read the test status of Service 0x01 PID 0x01 prior to executing Service 0x06 with Test ID 0x01 and 0x06 to verify whether the tests are supported and completed. The test values reported may be invalid if the test is not completed.

Table 79 — Request on-board monitoring test results for specific monitored systems request message

Message Direction:		External test equipment → All ECUs	
Message Type:		Request	
Data Byte	Description (all values are in hexadecimal)	Byte Value	Mnemonic
#1	Request on-board monitoring test results for specific monitored systems request SID	0x06	SIDRQ
#2	TID Lean to rich sensor threshold voltage (constant)	0x02	TID

Table 80 — Request on-board monitoring test results for specific monitored systems response message

Message Direction:		ECU#1 → External test equipment	
Message Type:		Response	
Data Byte	Description (all values are in hexadecimal)	Byte Value	Mnemonic
#1	Request on-board monitoring test results for specific monitored systems response SID	0x46	SIDPR
#2	TID Lean to rich sensor threshold voltage (constant)	0x02	TID
#3	Test Limit Type: test limit is minimum value; Component ID: 04	0x84	TLTCID
#4	Test Value High Byte: test fails if test value is less than test limit	0x00	TVHI
#5	Test Value Low Byte: test fails if test value is less than test limit	0x10	TVLO
#6	Minimum Test Limit High Byte	0x00	TLHI
#7	Minimum Test Limit Low Byte	0x00	TLLO

NOTE ECU#2 does not support any Test IDs and therefore does not send a response message.

Table 81 — Request on-board monitoring test results for specific monitored systems response message

Message Direction:		ECU#1 → External test equipment	
Message Type:		Response	
Data Byte	Description (all values are in hexadecimal)	Byte Value	Mnemonic
#1	Request on-board monitoring test results for specific monitored systems response SID	0x46	SIDPR
#2	TID Lean to rich sensor threshold voltage (constant)	0x02	TID
#3	Test Limit Type: test limit is maximum value; Component ID: 0x16	0x16	TLTCID
#4	Test Value High Byte: test fails if test value is greater than test limit	0x00	TVHI
#5	Test Value Low Byte: test fails if test value is greater than test limit	0x32	TVLO
#6	Maximum Test Limit High Byte	0x00	TLHI
#7	Maximum Test Limit Low Byte	0x20	TLLO

NOTE The above example shows that the test in ECU#1 for Test ID 0x02 and Component ID 0x04 passed and that the test in ECU#1 for Test ID 0x02 and Component ID 0x16 failed.

7.7 Service 0x07 — Request emission-related diagnostic trouble codes detected during current or last completed driving cycle

7.7.1 Functional description

The purpose of this service is to enable the external test equipment to obtain “pending” diagnostic trouble codes detected during current or last completed driving cycle for emission-related components/systems. Service 0x07 is required for all DTCs and is independent of Service 0x03. The intended use of this data is to assist the service technician after a vehicle repair, and after clearing diagnostic information, by reporting test results after a single driving cycle. If the test failed during the driving cycle, the DTC associated with that test will be reported. Test results reported by this service do not necessarily indicate a faulty component/system. If test results indicate a failure after additional driving, then the MIL will be illuminated and a DTC will be set and reported with Service 0x03, indicating a faulty component/system. This service can always be used to request the results of the latest test, independent of the setting of a DTC.

Test results for these components/systems are reported in the same format as the DTCs in Service 0x03 (see the functional description for Service 0x03).

If fewer than three (3) DTC values are reported for failed tests, the response messages used to report the test results shall be filled with 0x00 to fill seven (7) data bytes. This maintains the required fixed message length for all messages.

If there is no test failure to report, responses are permitted but not required for SAE J1850 and ISO 9141-2 interfaces. For ISO 14230-4 interfaces, the ECU will respond with a report containing no codes (all DTC values shall contain 0x00).

7.7.2 Message data bytes

7.7.2.1 Request emission-related diagnostic trouble codes detected during current or last completed driving cycle request message definition

Table 82 — Request emission-related diagnostic trouble codes detected during current or last completed driving cycle request message

Data Byte	Parameter Name	Cvt	Hex Value	Mnemonic
#1	Request emission-related diagnostic trouble codes detected during current or last completed driving cycle request SID	M	0x07	SIDRQ

7.7.2.2 Request emission-related diagnostic trouble codes detected during current or last completed driving cycle response message definition

Table 83 — Request emission-related diagnostic trouble codes detected during current or last completed driving cycle response message

Data Byte	Parameter Name	Cvt	Hex Value	Mnemonic
#1	Request emission-related diagnostic trouble codes detected during current or last completed driving cycle response SID	M	0x47	SIDPR
#2	DTC#1 (High Byte)	M/C ^a	xx	DTC1HI
#3	DTC#1 (Low Byte)	M/C	xx	DTC1LO
#4	DTC#2 (High Byte)	M/C	xx	DTC2HI
#5	DTC#2 (Low Byte)	M/C	xx	DTC2LO
#6	DTC#3 (High Byte)	M/C	xx	DTC3HI
#7	DTC#3 (Low Byte)	M/C	xx	DTC3LO

^a C = Conditional. DTC#1, DTC#2, and DTC#3 are always present. If no valid DTC number is included, the DTC values shall contain 0x00.

7.7.3 Parameter definition

This service does not support any parameters.

7.7.4 Message example

Refer to message example of Service 0x03.

7.8 Service 0x08 — Request control of on-board system, test or component

7.8.1 Functional description

The purpose of this service is to enable the external test equipment to control the operation of an on-board system, test or component.

The data bytes will be specified, if necessary, for each Test ID in SAE J1979-DA, and will be unique for each Test ID. If any data bytes are unused for any test, they shall be filled with 0x00 to maintain a fixed message length.

Possible uses for these data bytes in the request message are to:

- turn on-board system/test/component ON;
- turn on-board system/test/component OFF; and
- cycle on-board system/test/component for ‘n’ seconds.

Possible uses for these data bytes in the response message are to:

- report system status; and
- report test results.

A feature of this service is for the ECU to indicate which Test IDs are supported. Test ID 0x00 is a bit-encoded value that indicates support for Test IDs from 0x01 to 0x20. Test ID 0x20 indicates support for Test IDs 0x21 through 0x40, etc. This is the same concept as used for PID support in Services 0x01 and 0x02 as specified in SAE J1979-DA.

7.8.2 Message data bytes

7.8.2.1 Request control of on-board device request message definition (read-supported TIDs)

Table 84 — Request control of on-board device request message (read-supported TIDs)

Data Byte	Parameter Name	Cvt	Hex Value	Mnemonic
#1	Request control of on-board device request SID	M	0x08	SIDRQ
#2	Test ID (see SAE J1979-DA)	M	xx	TID
#3	data record of Test ID = [<div style="display: inline-block; vertical-align: middle; margin-left: 20px;">Data A,</div> <div style="display: inline-block; vertical-align: middle; margin-left: 20px;">Data B,</div> <div style="display: inline-block; vertical-align: middle; margin-left: 20px;">Data C,</div> <div style="display: inline-block; vertical-align: middle; margin-left: 20px;">Data D,</div> <div style="display: inline-block; vertical-align: middle; margin-left: 20px;">Data E]</div>	M	0x00	TIDREC_
#4		M	0x00	DATA_A
#5		M	0x00	DATA_B
#6		M	0x00	DATA_C
#7		M	0x00	DATA_D
			0x00	DATA_E

7.8.2.2 Request control of on-board device response message definition (report supported TIDs)

Table 85 — Request control of on-board device response message (report supported TIDs)

Data Byte	Parameter Name	Cvt	Hex Value	Mnemonic
#1	Request control of on-board device response SID	M	0x48	SIDPR
#2	Test ID	M	xx	TID
#3	Filler Byte	M	0x00	FB
#4	data record of supported Test IDs = [Data A: supported Test IDs, Data B: supported Test IDs, Data C: supported Test IDs, Data D: supported Test IDs]	M	xx	TIDREC_ DATA_A
#5		M	xx	DATA_B
#6		M	xx	DATA_C
#7		M	xx	DATA_D

7.8.2.3 Request control of on-board device request message definition (read TID values)

Table 86 — Request control of on-board device request message (read TID values)

Data Byte	Parameter Name	Cvt	Hex Value	Mnemonic
#1	Request control of on-board device request SID	M	0x08	SIDRQ
#2	Test ID (request Test ID values)	M	xx	TID
#3	data record of Test ID = [Data A, Data B, Data C, Data D, Data E]	M/C ^a	xx	TIDREC_ DATA_A
#4		M/C	xx	DATA_B
#5		M/C	xx	DATA_C
#6		M/C	xx	DATA_D
#7		M/C	xx	DATA_E

^a C = Conditional. Data A to E shall be filled with 0x00 if unused.

7.8.2.4 Request control of on-board device response message definition (report TID values)

Table 87 — Request control of on-board device response message (report TID values)

Data Byte	Parameter Name	Cvt	Hex Value	Mnemonic
#1	Request control of on-board device response SID	M	48	SIDPR
#2	Test ID (report Test ID values)	M	xx	TID
#3	data record of Test ID = [Data A, Data B, Data C, Data D, Data E]	M/C ^a	xx	TIDREC_ DATA_A
#4		M/C	xx	DATA_B
#5		M/C	xx	DATA_C
#6		M/C	xx	DATA_D
#7		M/C	xx	DATA_E

^a C = Conditional. Data A to E shall be filled with 0x00 if unused.

7.8.3 Parameter definition

7.8.3.1 Test IDs supported

Refer to SAE J1979-DA.

7.8.3.2 Test ID and data byte descriptions

Refer to SAE J1979-DA.

7.8.4 Message example

Tables 88 and 89 show how “request control of on-board system, test or component” service shall be implemented.

7.8.4.1 Step #1: Request control of on-board system, test or component (request for supported Test IDs)

The external test equipment requests all supported Test IDs from the vehicle. Refer to the example of Service 0x01 for guidance on requesting supported Test IDs (the same concept is used for supported TIDs).

As a result of the supported TID request, the external test equipment creates an internal list of supported PIDs for each ECU. ECU#1 (ECM) supports Test ID 0x01. ECU#2 (TCM) does not support any Test IDs and therefore does not send a response message.

7.8.4.2 Step #2: Request control of on-board device (Service 0x08, Test ID 0x01)

The external test equipment sends a “request control of on-board device” message with one (1) supported Test ID 0x01 to the vehicle.

Table 88 — Request control of on-board device request message

Message Direction:		External test equipment → All ECUs	
Message Type:		Request	
Data Byte	Description (all values are in hexadecimal)	Byte Value	Mnemonic
#1	Request control of on-board device request SID	0x08	SIDRQ
#2	TID: Evaporative system leak test	0x01	TID
#3	Data A: 0x00	0x00	DATA_A
#4	Data B: 0x00	0x00	DATA_B
#5	Data C: 0x00	0x00	DATA_C
#6	Data D: 0x00	0x00	DATA_D
#7	Data E: 0x00	0x00	DATA_E

Table 89 — Request control of on-board device response message

Message Direction:		ECU#1 → External test equipment	
Message Type:		Response	
Data Byte	Description (all values are in hexadecimal)	Byte Value	Mnemonic
#1	Request control of on-board device response SID	0x48	SIDPR
#2	TID: Evaporative system leak test	0x01	TID
#3	Data A: 0x00	0x00	DATA_A
#4	Data B: 0x00	0x00	DATA_B
#5	Data C: 0x00	0x00	DATA_C
#6	Data D: 0x00	0x00	DATA_D
#7	Data E: 0x00	0x00	DATA_E

NOTE ECU#2 does not support the Test ID and therefore does not send a response message.

7.9 Service 0x09 — Request vehicle information

7.9.1 Functional description

The purpose of this service is to enable the external test equipment to request vehicle-specific vehicle information such as Vehicle Identification Number (VIN) and Calibration IDs. Some of this information may be required by regulations and some should be reported in a standard format if supported by the vehicle manufacturer. INFOTYPES are defined in SAE J1979-DA.

A feature of this service is for the ECU to indicate which INFOTYPES are supported (support of INFOTYPE 0x00 is required for ISO 9141-2). INFOTYPE 0x00 is a bit-encoded value that indicates support for INFOTYPES from 0x01 to 0x20. INFOTYPE 0x20 indicates support for INFOTYPES 0x21 through 0x40, etc. This is the same concept as used for PID support in Services 0x01 and 0x02 as specified in SAE J1979-DA.

The external test equipment shall maintain a list of ECUs which support the INFOTYPES not equal to 0x00 in order to justify whether it expects a response message from this ECU or not. For request messages with INFOTYPES not equal to 0x00, the positive response messages may not be sent by the ECU(s) within the $P2_{max}$ timing window as specified in 6.2.2.

If INFOTYPE 0x02 (VIN) is indicated as supported, the ECU shall respond within $P2_{max}$ timing even if the VIN is missing or incomplete. For example, a development ECU may respond with 0xFF characters for VIN because the VIN has not been programmed.

7.9.2 Message data bytes

7.9.2.1 Request vehicle information request message definition (read-supported INFOTYPE)

Table 90 — Request vehicle information request message (read-supported INFOTYPE)

Data Byte	Parameter Name	Cvt	Hex Value	Mnemonic
#1	Request vehicle information request SID	M	0x09	SIDRQ
#2	INFOTYPE (see SAE J1979-DA)	M	xx	INFOTYP

7.9.2.2 Request vehicle information response message definition (report supported INFOTYPE)

Table 91 — Request vehicle information response message (report supported INFOTYPE)

Data Byte	Parameter Name	Cvt	Hex Value	Mnemonic
#1	Request vehicle information response SID	M	0x49	SIDPR
#2	INFOTYPE	M	xx	INFTYP_
#3	MessageCount	M	xx	MC_
#4	data record of INFOTYPE = [Data A: supported INFOTYPES, Data B: supported INFOTYPES, Data C: supported INFOTYPES, Data D: supported INFOTYPES]	M	xx	DATAREC_
#5		M	xx	DATA_A
#6		M	xx	DATA_B
#7		M	xx	DATA_C

7.9.2.3 Request vehicle information request message definition (read INFOTYPE values)

Table 92 — Request vehicle information request message (read INFOTYPE values)

Data Byte	Parameter Name	Cvt	Hex Value	Mnemonic
#1	Request vehicle information request SID	M	0x09	SIDRQ
#2	INFOTYPE	M	xx	INFTYP_

7.9.2.4 Request vehicle information response message definition (report INFOTYPE values)

Table 93 — Request vehicle information response message (report INFOTYPE values)

Data Byte	Parameter Name	Cvt	Hex Value	Mnemonic
#1	Request vehicle information response SID	M	0x49	SIDPR
#2	INFOTYPE	M	xx	INFTYP_
#3	MessageCount	M	xx	MC_
#4	data record of INFOTYPE = [Data A, Data B, Data C, Data D]	M/C ^a	xx	DATA_A
#5		M/C	xx	DATA_B
#6		M/C	xx	DATA_C
#7		M/C	xx	DATA_D

^a C = Conditional. Data A to D is only present if the requested INFOTYPE equals an even number.

7.9.3 Parameter definition

7.9.3.1 Vehicle information types supported

Refer to SAE J1979-DA.

7.9.3.2 Vehicle information types and data byte descriptions

Refer to SAE J1979-DA.

7.9.3.3 MessageCount description

The MessageCount parameter has two (2) definitions depending on the INFOTYPE parameter value:

- INFOTYPE parameter values 0x01, 0x03, 0x05, 0x07, 0x09, 0x0C: In this case, the MessageCount parameter includes a value which represents the number of response messages to be sent by the server (ECU) to report the Data A to D referenced by the corresponding INFOTYPE parameter value. The MessageCount parameter value is a “static value”.
- INFOTYPE parameter values 0x02, 0x04, 0x06, 0x08, 0x0A, 0x0B, 0x0D: In this case, the MessageCount parameter includes a value which represents a dynamic counter starting with the value of 1 and incremented by 1 in the following response messages (assuming error-free transmission of the response message). The MessageCount parameter value is a “dynamic incremented value” (increments of 1). The last response message shall include an incremented MessageCount value which matches the reported MessageCount parameter value previously reported by the server (ECU) with the odd INFOTYPE (even INFOTYPE – 1).

Refer to SAE J1979-DA.

7.9.4 Message example

The tables below show how the “request vehicle information” service shall be implemented.

7.9.4.1 Step #1: Request vehicle information (request supported INFOTYPE) from vehicle

The external test equipment requests all supported INFOTYPES from the vehicle. Refer to the example of Service 0x01 for guidance on requesting supported PIDs (the same concept is used for supported INFOTYPES). As a result of the supported INFOTYPE request, the external test equipment creates an internal list of supported INFOTYPES for each ECU: ECU#1 (ECM) supports the following INFOTYPES: 0x01, 0x02, 0x03, 0x04, 0x05, 0x06, 0x07, and 0x08. Since there is only one ECU which meets emission-related legislative requirements, no response messages from another ECU will occur.

7.9.4.2 Step #2: Request INFOTYPES from vehicle

Now the external test equipment requests the following INFOTYPE:

- INFOTYPE 0x01: MC_VIN = 5 response messages; supported by ECU#1.

Table 94 — Request vehicle information request message

Message Direction:	External test equipment → All ECUs		
Message Type:	Request		
Data Byte	Description (all values are in hexadecimal)	Byte Value	Mnemonic
#1	Request vehicle information request SID	0x09	SIDRQ
#2	INFOTYPE: MessageCount VIN	0x01	INFTYP

Table 95 — Request vehicle information response message

Message Direction:		ECU#1 → External test equipment	
Message Type:		Response	
Data Byte	Description (all values are in hexadecimal)	Byte Value	Mnemonic
#1	Request vehicle information response SID	0x49	SIDPR
#2	INFOTYPE: MessageCount VIN	0x01	INFOTYP
#3	MessageCount VIN = 5 response messages	0x05	MC_VIN

Now the external test equipment requests the following INFOTYPE:

— INFOTYPE 0x02: VIN = [1G1JC5444R7252367] supported by ECU#1.

Table 96 — Request vehicle information request message

Message Direction:		External test equipment → All ECUs	
Message Type:		Request	
Data Byte	Description (all values are in hexadecimal)	Byte Value	Mnemonic
#1	Request vehicle information request SID	0x09	SIDRQ
#2	INFOTYPE: VIN	0x02	INFOTYP

Table 97 — Request vehicle information response message (1)

Message Direction:		ECU#1 → External test equipment	
Message Type:		Response	
Data Byte	Description (all values are in hexadecimal)	Byte Value	Mnemonic
#1	Request vehicle information response SID	0x49	SIDPR
#2	INFOTYPE: VIN	0x02	INFOTYP
#3	MessageCount VIN = 1 st response message	0x01	MC_VIN
#4	Data A: Fill byte	0x00	DATA_A
#5	Data B: Fill byte	0x00	DATA_B
#6	Data C: Fill byte	0x00	DATA_C
#7	Data D: '1'	0x31	DATA_D

Table 98 — Request vehicle information response message (2)

Message Direction:		ECU#1 → External test equipment	
Message Type:		Response	
Data Byte	Description (all values are in hexadecimal)	Byte Value	Mnemonic
#1	Request vehicle information response SID	0x49	SIDPR
#2	INFOTYPE: VIN	0x02	INFOTYP
#3	MessageCount VIN = 2 nd response message	0x02	MC_VIN
#4	Data A: 'G'	0x47	DATA_A
#5	Data B: '1'	0x31	DATA_B
#6	Data C: 'J'	0x4A	DATA_C
#7	Data D: 'C'	0x43	DATA_D

Table 99 — Request vehicle information response message (3)

Message Direction:		ECU#1 → External test equipment	
Message Type:		Response	
Data Byte	Description (all values are in hexadecimal)	Byte Value	Mnemonic
#1	Request vehicle information response SID	0x49	SIDPR
#2	INFOTYPE: VIN	0x02	INFOTYP
#3	MessageCount VIN = 3 rd response message	0x03	MC_VIN
#4	Data A: '5'	0x35	DATA_A
#5	Data B: '4'	0x34	DATA_B
#6	Data C: '4'	0x34	DATA_C
#7	Data D: '4'	0x34	DATA_D

Table 100 — Request vehicle information response message (4)

Message Direction:		ECU#1 → External test equipment	
Message Type:		Response	
Data Byte	Description (all values are in hexadecimal)	Byte Value	Mnemonic
#1	Request vehicle information response SID	0x49	SIDPR
#2	INFOTYPE: VIN	0x02	INFOTYP
#3	MessageCount VIN = 4 th response message	0x04	MC_VIN
#4	Data A: 'R'	0x52	DATA_A
#5	Data B: '7'	0x37	DATA_B
#6	Data C: '2'	0x32	DATA_C
#7	Data D: '5'	0x35	DATA_D

Table 101 — Request vehicle information response message (5)

Message Direction:		ECU#1 → External test equipment	
Message Type:		Response	
Data Byte	Description (all values are in hexadecimal)	Byte Value	Mnemonic
#1	Request vehicle information response SID	0x49	SIDPR
#2	INFOTYPE: VIN	0x02	INFOTYP
#3	MessageCount VIN = 5 th response message	0x05	MC_VIN
#4	Data A: '2'	0x32	DATA_A
#5	Data B: '3'	0x33	DATA_B
#6	Data C: '6'	0x36	DATA_C
#7	Data D: '7'	0x37	DATA_D

Now the external test equipment requests the following INFOTYPE:

- INFOTYPE 0x03: MessageCount Calibration ID = 0x08; supported by ECU#1.

Table 102 — Request vehicle information request message

Message Direction:		External test equipment → All ECUs	
Message Type:		Request	
Data Byte	Description (all values are in hexadecimal)	Byte Value	Mnemonic
#1	Request vehicle information request SID	0x09	SIDRQ
#2	INFOTYPE: MessageCount Calibration ID	0x03	INFOTYP

Table 103 — Request vehicle information response message

Message Direction:		ECU#1 → External test equipment	
Message Type:		Response	
Data Byte	Description (all values are in hexadecimal)	Byte Value	Mnemonic
#1	Request vehicle information response SID	0x49	SIDPR
#2	INFOTYPE: MessageCount Calibration ID	0x03	INFOTYP
#3	MessageCount Calibration ID = 8 response messages	0x08	MC_CALID

Now the external test equipment requests the following INFOTYPE:

- INFOTYPE 0x04: CALID#1 = [JMB*36761500]; supported by ECU#1;
- INFOTYPE 0x04: CALID#2 = [JMB*47872611]; supported by ECU#1.

Table 104 — Request vehicle information request message

Message Direction:		External test equipment → All ECUs	
Message Type:		Request	
Data Byte	Description (all values are in hexadecimal)	Byte Value	Mnemonic
#1	Request vehicle information request SID	0x09	SIDRQ
#2	INFOTYPE: Calibration ID	0x04	INFTYP

Table 105 — Request vehicle information response message (1)

Message Direction:		ECU#1 → External test equipment	
Message Type:		Response	
Data Byte	Description (all values are in hexadecimal)	Byte Value	Mnemonic
#1	Request vehicle information response SID	0x49	SIDPR
#2	INFOTYPE: Calibration ID	0x04	INFTYP
#3	MessageCount Calibration ID#1 = 1 st response message	0x01	MC_CALID
#4	Data A: 'J'	0x4A	DATA_A
#5	Data B: 'M'	0x4D	DATA_B
#6	Data C: 'B'	0x42	DATA_C
#7	Data D: '*'	0x2A	DATA_D

Table 106 — Request vehicle information response message (2)

Message Direction:		ECU#1 → External test equipment	
Message Type:		Response	
Data Byte	Description (all values are in hexadecimal)	Byte Value	Mnemonic
#1	Request vehicle information response SID	0x49	SIDPR
#2	INFOTYPE: Calibration ID	0x04	INFTYP
#3	MessageCount Calibration ID#1 = 2 nd response message	0x02	MC_CALID
#4	Data A: '3'	0x33	DATA_A
#5	Data B: '6'	0x36	DATA_B
#6	Data C: '7'	0x37	DATA_C
#7	Data D: '6'	0x36	DATA_D

Table 107 — Request vehicle information response message (3)

Message Direction:		ECU#1 → External test equipment	
Message Type:		Response	
Data Byte	Description (all values are in hexadecimal)	Byte Value	Mnemonic
#1	Request vehicle information response SID	0x49	SIDPR
#2	INFOTYPE: Calibration ID	0x04	INFOTYP
#3	MessageCount Calibration ID#1 = 3 rd response message	0x03	MC_CALID
#4	Data A: '1'	0x31	DATA_A
#5	Data B: '5'	0x35	DATA_B
#6	Data C: '0'	0x30	DATA_C
#7	Data D: '0'	0x30	DATA_D

Table 108 — Request vehicle information response message (4)

Message Direction:		ECU#1 → External test equipment	
Message Type:		Response	
Data Byte	Description (all values are in hexadecimal)	Byte Value	Mnemonic
#1	Request vehicle information response SID	0x49	SIDPR
#2	INFOTYPE: Calibration ID	0x04	INFOTYP
#3	MessageCount Calibration ID#1 = 4 th response message	0x04	MC_CALID
#4	Data A: Fill byte	0x00	DATA_A
#5	Data B: Fill byte	0x00	DATA_B
#6	Data C: Fill byte	0x00	DATA_C
#7	Data D: Fill byte	0x00	DATA_D

Table 109 — Request vehicle information response message (5)

Message Direction:		ECU#1 → External test equipment	
Message Type:		Response	
Data Byte	Description (all values are in hexadecimal)	Byte Value	Mnemonic
#1	Request vehicle information response SID	0x49	SIDPR
#2	INFOTYPE: Calibration ID	0x04	INFOTYP
#3	MessageCount Calibration ID#2 = 5 th response message	0x05	MC_CALID
#4	Data A: 'J'	0x4A	DATA_A
#5	Data B: 'M'	0x4D	DATA_B
#6	Data C: 'B'	0x42	DATA_C
#7	Data D: '**'	0x2A	DATA_D

Table 110 — Request vehicle information response message (6)

Message Direction:		ECU#1 → External test equipment	
Message Type:		Response	
Data Byte	Description (all values are in hexadecimal)	Byte Value	Mnemonic
#1	Request vehicle information response SID	0x49	SIDPR
#2	INFOTYPE: Calibration ID	0x04	INFOTYP
#3	MessageCount Calibration ID#2 = 6 th response message	0x06	MC_CALID
#4	Data A: '4'	0x34	DATA_A
#5	Data B: '7'	0x37	DATA_B
#6	Data C: '8'	0x38	DATA_C
#7	Data D: '7'	0x37	DATA_D

Table 111 — Request vehicle information response message (7)

Message Direction:		ECU#1 → External test equipment	
Message Type:		Response	
Data Byte	Description (all values are in hexadecimal)	Byte Value	Mnemonic
#1	Request vehicle information response SID	0x49	SIDPR
#2	INFOTYPE: Calibration ID	0x04	INFOTYP
#3	MessageCount Calibration ID#2 = 7 th response message	0x07	MC_CALID
#4	Data A: '2'	0x32	DATA_A
#5	Data B: '6'	0x36	DATA_B
#6	Data C: '1'	0x31	DATA_C
#7	Data D: '1'	0x31	DATA_D

Table 112 — Request vehicle information response message (8)

Message Direction:		ECU#1 → External test equipment	
Message Type:		Response	
Data Byte	Description (all values are in hexadecimal)	Byte Value	Mnemonic
#1	Request vehicle information response SID	0x49	SIDPR
#2	INFOTYPE: Calibration ID	0x04	INFOTYP
#3	MessageCount Calibration ID#2 = 8 th response message	0x08	MC_CALID
#4	Data A: Fill byte	0x00	DATA_A
#5	Data B: Fill byte	0x00	DATA_B
#6	Data C: Fill byte	0x00	DATA_C
#7	Data D: Fill byte	0x00	DATA_D

Now the external test equipment requests the following INFOTYPE:

- INFOTYPE 0x05: MessageCount Calibration Verification Number = 0x02; supported by ECU#1.

Table 113 — Request vehicle information request message

Message Direction:		External test equipment → All ECUs	
Message Type:		Request	
Data Byte	Description (all values are in hexadecimal)	Byte Value	Mnemonic
#1	Request vehicle information request SID	0x09	SIDRQ
#2	INFOTYPE: MessageCount Calibration Verification Number	0x05	INFTYP

Table 114 — Request vehicle information response message

Message Direction:		ECU#1 → External test equipment	
Message Type:		Response	
Data Byte	Description (all values are in hexadecimal)	Byte Value	Mnemonic
#1	Request vehicle information response SID	0x49	SIDPR
#2	INFOTYPE: MessageCount Calibration Verification Number	0x05	INFTYP
#3	MessageCount Calibration Verification Number = 2 response messages	0x02	MC_CVN

Now the external test equipment requests the following INFOTYPE:

- INFOTYPE 0x06: CVN#1 = [17 91 BC 82]; supported by ECU#1;
- INFOTYPE 0x06: CVN#2 = [16 E0 62 BE]; supported by ECU#1.

Table 115 — Request vehicle information request message

Message Direction:		External test equipment → All ECUs	
Message Type:		Request	
Data Byte	Description (all values are in hexadecimal)	Byte Value	Mnemonic
#1	Request vehicle information request SID	0x09	SIDRQ
#2	INFOTYPE: Calibration Verification Number	0x06	INFTYP

Table 116 — Request vehicle information response message (1)

Message Direction:		ECU#1 → External test equipment	
Message Type:		Response	
Data Byte	Description (all values are in hexadecimal)	Byte Value	Mnemonic
#1	Request vehicle information response SID	0x49	SIDPR
#2	INFOTYPE: Calibration Verification Number	0x06	INFTYP
#3	MessageCount Calibration Verification Number = 1 st response message	0x01	MC_CVN
#4	Data A: 17	0x17	DATA_A
#5	Data B: 91	0x91	DATA_B
#6	Data C: BC	0xBC	DATA_C
#7	Data D: 82	0x82	DATA_D

Depending on which protocol the vehicle supports, the following situations may occur:

If the vehicle supports ISO 9141-2, the external test equipment may need to repeat the request message multiple times before the ECU(s) send a response message.

If the vehicle supports SAE J1850, the external test equipment may need to repeat the request message before the ECU(s) send a response message.

If the vehicle supports ISO 14230-4, the ECU(s) may send a negative response message with response code 0x22 - conditionsNotCorrect if, for example, the engine is running. After the vehicle conditions have been adjusted to meet this service request, the external test equipment shall repeat the request message and the ECU(s) shall send a positive response message.

Table 117 — Request vehicle information response message (2)

Message Direction:		ECU#1 → External test equipment	
Message Type:		Response	
Data Byte	Description (all values are in hexadecimal)	Byte Value	Mnemonic
#1	Request vehicle information response SID	0x49	SIDPR
#2	INFOTYPE: Calibration Verification Number	0x06	INFTYP
#3	MessageCount Calibration Verification Number = 2 nd response message	0x02	MC_CVN
#4	Data A: 0x16	0x16	DATA_A
#5	Data B: 0xE0	0xE0	DATA_B
#6	Data C: 0x62	0x62	DATA_C
#7	Data D: 0xBE	0xBE	DATA_D

Now the external test equipment requests the following INFOTYPE:

— INFOTYPE 0x07: MessageCount In-use Performance Tracking = 0x08; supported by ECU#1.

Table 118 — Request vehicle information request message

Message Direction:		External test equipment → All ECUs	
Message Type:		Request	
Data Byte	Description (all values are in hexadecimal)	Byte Value	Mnemonic
#1	Request vehicle information request SID	0x09	SIDRQ
#2	INFOTYPE: MessageCount In-use Performance Tracking	0x07	INFOTYP

Table 119 — Request vehicle information response message

Message Direction:		ECU#1 → External test equipment	
Message Type:		Response	
Data Byte	Description (all values are in hexadecimal)	Byte Value	Mnemonic
#1	Request vehicle information response SID	0x49	SIDPR
#2	INFOTYPE: MessageCount In-use Performance Tracking	0x07	INFOTYP
#3	MessageCount In-use Performance Tracking = 8 response messages	0x08	MC_IPT

Now the external test equipment requests the following INFOTYPE:

— INFOTYPE 0x08: MC_IPT = 8 response messages; supported by ECU#1.

Table 120 — Request vehicle information request message

Message Direction:		External test equipment → All ECUs	
Message Type:		Request	
Data Byte	Description (all values are in hexadecimal)	Byte Value	Mnemonic
#1	Request vehicle information request SID	0x09	SIDRQ
#2	INFOTYPE: In-use Performance Tracking	0x08	INFOTYP

Table 121 — Request vehicle information response message (1)

Message Direction:		ECU#1 → External test equipment	
Message Type:		Response	
Data Byte	Description (all values are in hexadecimal)	Byte Value	Mnemonic
#1	Request vehicle information response SID	0x49	SIDPR
#2	INFOTYPE: In-use Performance Tracking	0x08	INFOTYP
#3	MessageCount In-use Performance Tracking = 1 st response message	0x01	MC_IPT
#4	OBDCOND_A: 1024 counts	0x04	OBDCOND_A
#5	OBDCOND_B: 1024 counts	0x00	OBDCOND_B
#6	IGNCNTR_A: 3337 counts	0x0D	IGNCNTR_A
#7	IGNCNTR_B: 3337 counts	0x09	IGNCNTR_B

Table 122 — Request vehicle information response message (2)

Message Direction:		ECU#1 → External test equipment	
Message Type:		Response	
Data Byte	Description (all values are in hexadecimal)	Byte Value	Mnemonic
#1	Request vehicle information response SID	0x49	SIDPR
#2	INFOTYPE: In-use Performance Tracking	0x08	INFOTYP
#3	MessageCount In-use Performance Tracking = 2 nd response message	0x02	MC_IPT
#4	CATCOMP1_A: 824 counts	0x03	CATCOMP1_A
#5	CATCOMP1_B: 824 counts	0x38	CATCOMP1_B
#6	CATCOND1_A: 945 counts	0x03	CATCOND1_A
#7	CATCOND1_B: 945 counts	0xB1	CATCOND1_B

Table 123 — Request vehicle information response message (3)

Message Direction:		ECU#1 → External test equipment	
Message Type:		Response	
Data Byte	Description (all values are in hexadecimal)	Byte Value	Mnemonic
#1	Request vehicle information response SID	0x49	SIDPR
#2	INFOTYPE: In-use Performance Tracking	0x08	INFOTYP
#3	MessageCount In-use Performance Tracking = 3 rd response message	0x03	MC_IPT
#4	CATCOMP2_A: 711 counts	0x02	CATCOMP2_A
#5	CATCOMP2_B: 711 counts	0xC7	CATCOMP2_B
#6	CATCOND2_A: 945 counts	0x03	CATCOND2_A
#7	CATCOND2_B: 945 counts	0xB1	CATCOND2_B

Table 124 — Request vehicle information response message (4)

Message Direction:		ECU#1 → External test equipment	
Message Type:		Response	
Data Byte	Description (all values are in hexadecimal)	Byte Value	Mnemonic
#1	Request vehicle information response SID	0x49	SIDPR
#2	INFOTYPE: In-use Performance Tracking	0x08	INFOTYP
#3	MessageCount In-use Performance Tracking = 4 th response message	0x04	MC_IPT
#4	O2SCOMP1_A: 737 counts	0x02	O2SCOMP1_A
#5	O2SCOMP1_B: 737 counts	0xE1	O2SCOMP1_B
#6	O2SCOND1_A: 924 counts	0x03	O2SCOND1_A
#7	O2SCOND1_B: 924 counts	0x9C	O2SCOND1_B

Table 125 — Request vehicle information response message (5)

Message Direction:		ECU#1 → External test equipment	
Message Type:		Response	
Data Byte	Description (all values are in hexadecimal)	Byte Value	Mnemonic
#1	Request vehicle information response SID	0x49	SIDPR
#2	INFOTYPE: In-use Performance Tracking	0x08	INFOTYP
#3	MessageCount In-use Performance Tracking = 5 th response message	0x05	MC_IPT
#4	O2SCOMP2_A: 724 counts	0x02	O2SCOMP2_A
#5	O2SCOMP2_B: 724 counts	0xD4	O2SCOMP2_B
#6	O2SCOND2_A: 833 counts	0x03	O2SCOND2_A
#7	O2SCOND2_B: 833 counts	0x41	O2SCOND2_B

Table 126 — Request vehicle information response message (6)

Message Direction:		ECU#1 → External test equipment	
Message Type:		Response	
Data Byte	Description (all values are in hexadecimal)	Byte Value	Mnemonic
#1	Request vehicle information response SID	0x49	SIDPR
#2	INFOTYPE: In-use Performance Tracking	0x08	INFOTYP
#3	MessageCount In-use Performance Tracking = 6 th response message	0x06	MC_IPT
#4	EGRCOMP_A: 997 counts	0x03	EGRCOMP_A
#5	EGRCOMP_B: 997 counts	0xE5	EGRCOMP_B
#6	EGRCOND_A: 1010 counts	0x03	EGRCOND_A
#7	EGRCOND_B: 1010 counts	0xF2	EGRCOND_B

Table 127 — Request vehicle information response message (7)

Message Direction:		ECU#1 → External test equipment	
Message Type:		Response	
Data Byte	Description (all values are in hexadecimal)	Byte Value	Mnemonic
#1	Request vehicle information response SID	0x49	SIDPR
#2	INFOTYPE: In-use Performance Tracking	0x08	INFOTYP
#3	MessageCount In-use Performance Tracking = 7 th response message	0x07	MC_IPT
#4	AIRCOMP_A: 937 counts	0x03	AIRCOMP_A
#5	AIRCOMP_B: 937 counts	0xA9	AIRCOMP_B
#6	AIRCOND_A: 973 counts	0x03	AIRCOND_A
#7	AIRCOND_B: 973 counts	0xCD	AIRCOND_B

Table 128 — Request vehicle information response message (8)

Message Direction:	ECU#1 → External test equipment		
Message Type:	Response		
Data Byte	Description (all values are in hexadecimal)	Byte Value	Mnemonic
#1	Request vehicle information response SID	0x49	SIDPR
#2	INFOTYPE: In-use Performance Tracking	0x08	INFOTYP
#3	MessageCount In-use Performance Tracking = 8 th response message	0x08	MC_IPT
#4	EVAPCOMP_A: 68 counts	0x00	EVAPCOMP_A
#5	EVAPCOMP_B: 68 counts	0x44	EVAPCOMP_B
#6	EVAPCOND_A: 97 counts	0x00	EVAPCOND_A
#7	EVAPCOND_B: 97 counts	0x61	EVAPCOND_B

8 Diagnostic service definition for ISO 15765-4

8.1 Service 0x01 — Request current powertrain diagnostic data

8.1.1 Functional description

The purpose of this service is to allow access to current emission-related data values, including analogue inputs and outputs, digital inputs and outputs, and system status information. The request for information includes a parameter identification (PID) value that indicates to the on-board system the specific information requested. PID specifications, scaling information and display formats are included in SAE J1979-DA.

The ECU(s) shall respond to this message by transmitting the requested data value last determined by the system. All data values returned for sensor readings shall be actual readings, not default or substitute values used by the system because of a fault with that sensor.

Not all PIDs are applicable or supported by all systems. PID 0x00 is a bit-encoded value that indicates which PIDs are supported for each ECU. PID 0x00 indicates support for PIDs from 0x01 to 0x20. PID 0x20 indicates support for PIDs 0x21 through 0x40, etc. This is the same concept for PIDs/OBD Monitor IDs/TIDs/INFOTYPES support in Services 0x01, 0x02, 0x06, 0x08, 0x09. PID 0x00 is required for those ECUs that respond to a corresponding Service 0x01 request message as specified in SAE J1979-DA.

IMPORTANT — All emissions-related OBD ECUs which at least support one of the services defined in this part of ISO 15031, shall support Service 0x01 and PID 0x00. Service 0x01 with PID 0x00 is defined as the universal “initialization/keep alive/ping” message for all emissions-related OBD ECUs.

The request message may contain up to six (6) PIDs. External test equipment is not allowed to request a combination of PIDs supported and PIDs which report data values. The ECU shall support requests for up to six (6) PIDs. The request message may contain the same PID multiple times. The ECU shall treat each PID as a separate parameter and respond with data for each PID (data returned may be different for the same PID) as often as requested.

The order of the PIDs in the response message is not required to match the order in the request message.

8.1.2 Message data bytes

8.1.2.1 Request current powertrain diagnostic data request message definition (read-supported PIDs)

Table 129 — Request current powertrain diagnostic data request message (read-supported PIDs)

Data Byte	Parameter Name	Cvt	Hex Value	Mnemonic
#1	Request current powertrain diagnostic data request SID	M	0x01	SIDRQ
#2	PID#1 (PIDs supported: see SAE J1979-DA)	M	xx	PID
#3	PID#2 (PIDs supported: see SAE J1979-DA)	U ^a	xx	PID
#4	PID#3 (PIDs supported: see SAE J1979-DA)	U	xx	PID
#5	PID#4 (PIDs supported: see SAE J1979-DA)	U	xx	PID
#6	PID#5 (PIDs supported: see SAE J1979-DA)	U	xx	PID
#7	PID#6 (PIDs supported: see SAE J1979-DA)	U	xx	PID

^a U = User Optional. PID may be included to avoid multiple PID supported request messages.

To request PIDs supported range from 0xC1 to 0xFF, another request message with PID#1 = 0xC0 and PID#2 = 0xE0 shall be sent to the vehicle.

8.1.2.2 Request current powertrain diagnostic data response message definition (report supported PIDs)

ECU(s) shall respond to all supported ranges if requested. A range is defined as a block of 32 PIDs (e.g. range #1: PID 0x01 - 0x20). The ECU shall not respond to unsupported PID ranges unless subsequent ranges have a supported PID(s).

Table 130 — Request current powertrain diagnostic data response message (report supported PIDs)

Data Byte	Parameter Name	Cvt	Hex Value	Mnemonic
#1	Request current powertrain diagnostic data response SID	M	0x41	SIDPR
#2	data record of supported PIDs = [1 st supported PID Data A: supported PIDs, Data B: supported PIDs, Data C: supported PIDs, Data D: supported PIDs]	M	xx	PIDREC_ PID
#3		M	xx	DATA_A
#4		M	xx	DATA_B
#5		M	xx	DATA_C
#6		M	xx	DATA_D
:	:	:	:	:
#n-4	data record of supported PIDs = [m th supported PID Data A: supported PIDs, Data B: supported PIDs, Data C: supported PIDs, Data D: supported PIDs]	C1 ^a	xx	PIDREC_ PID
#n-3		C2 ^b	xx	DATA_A
#n-2		C2	xx	DATA_B
#n-1		C2	xx	DATA_C
#n		C2	xx	DATA_D

^a C1 = Conditional. PID value shall be the same value as included in the request message if supported by the ECU.

^b C2 = Conditional. Value indicates PIDs supported; range of supported PIDs depends on selected PID value (see C1).

The response message shall only include the PID(s) and Data A to D which are supported by the ECU. If the request message includes a PID value(s) which are not supported by the ECU, those shall not be included in the response message.

8.1.2.3 Request current powertrain diagnostic data request message definition (read PID values)

Table 131 — Request current powertrain diagnostic data request message

Data Byte	Parameter Name	Cvt	Hex Value	Mnemonic
#1	Request current powertrain diagnostic data request SID	M	0x01	SIDRQ
#2	PID#1 (see SAE J1979-DA)	M	xx	PID
#3	PID#2 (see SAE J1979-DA)	U ^a	xx	PID
#4	PID#3 (see SAE J1979-DA)	U	xx	PID
#5	PID#4 (see SAE J1979-DA)	U	xx	PID
#6	PID#5 (see SAE J1979-DAB)	U	xx	PID
#7	PID#6 (see SAE J1979-DAB)	U	xx	PID

^a U = User Optional. The parameter may be either present or not.

8.1.2.4 Request current powertrain diagnostic data response message definition (report PID values)

Table 132 — Request current powertrain diagnostic data response message

Data Byte	Parameter Name	Cvt	Hex Value	Mnemonic
#1	Request current powertrain diagnostic data response SID	M	0x41	SIDPR
#2	data record of 1 st supported PID = [PID#1 data #1.1, : : data #1.j]	M	xx	PIDREC_ PID
#3		M	xx	DATA_1.1
:		:	xx	:
#j+1		C1 ^a	xx	DATA_1.j
:	:	:	:	:
:	data record of m th supported PID = [PID#m data #m.1, : : data #m.k]	C2 ^b	xx	PIDREC_ PID
:		C2	xx	DATA_m.1
:		:	:	:
#n		C3 ^c	xx	DATA_1.k

^a C1 = Conditional. Data depends on selected PID value.
^b C2 = Conditional. Parameter is only present if supported by the ECU.
^c C3 = Conditional. Parameters and values for data depend on selected PID number and are only included if PID is supported by the ECU.

Not all PIDs which are included in the request message may be supported by all emission-related ECUs, which shall comply with this part of ISO 15031. Therefore, each vehicle ECU, which supports at least one (1) PID, shall send a response message including the PID(s) with data.

8.1.3 Parameter definition

8.1.3.1 PIDs supported

SAE J1979-DA specifies the interpretation of the data record of supported PIDs.

8.1.3.2 PID and data byte descriptions

SAE J1979-DA specifies standardized emission-related parameters.

8.1.4 Message example

Tables 133 to 135 show how the “request current powertrain diagnostic data” service shall be implemented.

8.1.4.1 Step #1: Request supported PIDs from vehicle

The external test equipment requests supported PIDs (0x00, 0x20, 0x40, 0x60, 0x80, 0xA0) from the vehicle. Refer to SAE J1979-DA to interpret the data bytes in the response messages.

ECU(s) shall respond to all supported ranges if requested. A range is defined as a block of 32 PIDs (e.g. range #1: PID 0x01 - 0x20). The ECU shall not respond to unsupported PID ranges unless subsequent ranges have a supported PID(s).

Table 133 — Request current powertrain diagnostic data request message

Message Direction:		External test equipment → All ECUs	
Message Type:		Request	
Data Byte	Description (All PID values are in hexadecimal)	Byte Value	Mnemonic
#1	Request current powertrain diagnostic data request SID	0x01	SIDRQ
#2	PID used to determine PID support for PIDs 0x01 - 0x20	0x00	PID
#3	PID used to determine PID support for PIDs 0x21 – 0x40	0x20	PID
#4	PID used to determine PID support for PIDs 0x41 – 0x60	0x40	PID
#5	PID used to determine PID support for PIDs 0x61 – 0x80	0x60	PID
#6	PID used to determine PID support for PIDs 0x81 – 0xA0	0x80	PID
#7	PID used to determine PID support for PIDs 0xA1 – 0xC0	0xA0	PID

Table 134 — ECU#1 response: Request current powertrain diagnostic data response message

Message Direction:	ECU#1 → External test equipment		
Message Type:	Response		
Data Byte	Description (All PID values are in hexadecimal)	Byte Value	Mnemonic
#1	Request current powertrain diagnostic data response SID	0x41	SIDPR
#2	PID requested	0x00	PID
#3	Data byte A, representing support for PIDs 0x01, 0x03 - 0x08	10111111b = 0xBF	DATA_A
#4	Data byte B, representing support for PIDs 0x09, 0x0B - 0x10	10111111b = 0xBF	DATA_B
#5	Data byte C, representing support for PIDs 0x11, 0x13, 0x15	10101000b = 0xA8	DATA_C
#6	Data byte D, representing support for PIDs 0x19, 0x1C, 0x20	10010001b = 0x91	DATA_D
#7	PID requested	0x20	PID
#8	Data byte A, representing support for PID 0x21	10000000b = 0x80	DATA_A
#9	Data byte B, representing no support for PIDs 0x29 - 0x30	00000000b = 0x00	DATA_B
#10	Data byte C, representing no support for PIDs 0x31 - 0x38	00000000b = 0x00	DATA_C
#11	Data byte D, representing no support for PIDs 0x39 - 0x40	00000000b = 0x00	DATA_D

Table 135 — ECU#2 response: Request current powertrain diagnostic data response message

Message Direction:	ECU#2 → External test equipment		
Message Type:	Response		
Data Byte	Description (All PID values are in hexadecimal)	Byte Value	Mnemonic
#1	Request current powertrain diagnostic data response SID	0x41	SIDPR
#2	PID requested	0x00	PID
#3	Data byte A, representing support for PID 0x01	10000000b = 0x80	DATA_A
#4	Data byte B, representing support for PID 0x0D	00001000b = 0x08	DATA_B
#5	Data byte C, representing no support for PIDs 0x11 - 0x18	00000000b = 0x00	DATA_C
#6	Data byte D, representing no support for PIDs 0x19 - 0x20	00000000b = 0x00	DATA_D

Now the external test equipment creates an internal list of supported PIDs for each ECU. ECU#1 (ECM) supports the following PIDs: 0x01, 0x03 - 0x09, 0x0B - 0x11, 0x13, 0x15, 0x19, 0x1C, 0x20, 0x21.

ECU#2 (TCM) supports the following PIDs: 0x01 and 0x0D.

8.1.4.2 Step #2: Request multiple PIDs from vehicle

Now the external test equipment requests a combination of a maximum of six (6) PIDs in one request message to gain best performance of displaying current data.

- PID 0x15: Bank 1 - Sensor 2, PID is supported by ECU#1;
- PID 0x01: Number of emission-related DTCs and MIL status, PID is supported by ECU#1 and #2;
- PID 0x05: Engine coolant temperature, PID is supported by ECU#1;
- PID 0x03: Fuel system 1 status, PID is supported by ECU#1;
- PID 0x0C: Engine speed, PID is supported by ECU#1;
- PID 0x0D: Vehicle speed, PID is supported by ECU#2.

Table 136 — Request current powertrain diagnostic data request message

Message Direction:		External test equipment → All ECUs	
Message Type:		Request	
Data Byte	Description (All PID values are in hexadecimal)	Byte Value	Mnemonic
#1	Request current powertrain diagnostic data request SID	0x01	SIDRQ
#2	PID: Bank 1 - Sensor 2	0x15	PID(15)
#3	PID: Number of emission-related DTCs and MIL status	0x01	PID(01)
#4	PID: Engine coolant temperature	0x05	PID(05)
#5	PID: Fuel system 1 status	0x03	PID(03)
#6	PID: Engine speed	0x0C	PID(0C)
#7	PID: Vehicle speed	0x0D	PID(0D)

Table 137 — ECU#1 response: Request current powertrain diagnostic data response message

Message Direction:		ECU#1 → External test equipment	
Message Type:		Response	
Data Byte	Description (All PID values are in hexadecimal)	Byte Value	Mnemonic
#1	Request current powertrain diagnostic data response SID	0x41	SIDPR
#2	PID #1: Engine coolant temperature	0x05	PID(05)
#3	Data #1.1	0x6E	DATA(A)
#4	PID #2: Number of emission-related DTCs and MIL status	0x01	PID(01)
#5	Data #2.1: MIL: ON; Number of emission-related DTCs: 03	0x83	DATA(A)
#6	Data #2.2: Misfire -, Fuel system -, Comprehensive monitoring	0x07	DATA(B)
#7	Data #2.3: Catalyst -, Heated catalyst -, ..., monitoring supported	0xEF	DATA(C)
#8	Data #2.4: Catalyst -, Heated catalyst -, ..., monitoring test complete/not complete	0x63	DATA(D)
#9	PID #3: Bank 1 - Sensor 2	0x15	PID(15)
#10	Data #3.1: Bank 2 - Sensor 2: 0.8 Volt	0xA0	DATA(A)
#11	Data #3.2: Bank 2 - Sensor 2: 93.7 %	0x78	DATA(B)
#12	PID #4: Engine speed	0x0C	PID(0C)
#13	Data #4.1: 667 rpm	0x0A	DATA(A)
#14	Data #4.2: 667 rpm	0x6B	DATA(B)
#15	PID #5: Fuel system 1 status	0x03	PID(03)
#16	Data #5.1: Closed loop - using oxygen sensor(s) as feedback for fuel control	0x02	DATA(A)
#17	Data #5.2:	0x00	DATA(B)

Table 138 — ECU#2 response: Request current powertrain diagnostic data response message

Message Direction:	ECU#2 → External test equipment		
Message Type:	Response		
Data Byte	Description (All PID values are in hexadecimal)	Byte Value	Mnemonic
#1	Request current powertrain diagnostic data response SID	0x41	SIDPR
#2	PID #1: Vehicle speed	0x0D	PID(0D)
#3	Data #1.1:	0x23	DATA(A)
#4	PID #2: Number of emission-related DTCs and MIL status	0x01	PID(01)
#5	Data #2.1: MIL: OFF; Number of emission-related DTCs: 01	0x01	DATA(A)
#6	Data #2.2: Comprehensive monitoring: supported, test complete	0x04	DATA(B)
#7	Data #2.3: Catalyst -, Heated catalyst -, ..., monitoring supported	0x00	DATA(C)
#8	Data #2.4: Catalyst -, Heated catalyst -, ..., monitoring test complete/not complete	0x00	DATA(D)

ECU #1 (ECM) reports MIL commanded on, three stored DTCs, all monitors as supported, catalyst, heated catalyst, oxygen sensor and oxygen sensor heater as not completed, and all other monitors as completed.

ECU #2 (TCM) reports MIL commanded off, one stored DTC, comprehensive components monitor as supported and complete, and all other monitors as not supported.

8.2 Service 0x02 — Request powertrain freeze frame data

8.2.1 Functional description

The purpose of this service is to allow access to emission-related data values in a freeze frame. This allows expansion to meet manufacturer-specific requirements not necessarily related to the required freeze frame, and not necessarily containing the same data values as the required freeze frame. The request message includes a parameter identification (PID) value that indicates to the on-board system the specific information requested. PID specifications, scaling information and display formats for the freeze frame are included in SAE J1979-DA.

The ECU(s) shall respond to this message by transmitting the requested data value stored by the system. All data values returned for sensor readings shall be actual stored readings, not default or substitute values used by the system because of a fault with that sensor.

Service 0x02 PID 0x02 indicates the DTC that caused the freeze frame data to be stored. If freeze frame data is not stored in the ECU, the system shall report 0x00 0x00 as the DTC.

The frame number byte shall indicate 0x00 for the freeze frame data. Manufacturers may optionally save additional freeze frames and use this service to obtain that data by specifying the freeze frame number in the request message. If a manufacturer uses these additional freeze frames, they shall be stored under conditions specified by the manufacturer, and contain data specified by the manufacturer.

Not all PIDs are applicable or supported by all systems. PID 0x00 is a bit-encoded value that indicates for each ECU, for each frame, which PIDs are supported. Different freeze frames can support a different set of PIDs depending on the DTC that caused the frame to be stored. PID 0x00 indicates support for PIDs from 0x01 to 0x20. PID 0x20 indicates support for PIDs 0x21 through 0x40, etc. This is the same concept for PIDs/TIDs/INFOTYPES support in Services 0x01, 0x02, 0x06, 0x08, 0x09. PID 0x00 is required for those ECUs that respond to a corresponding Service 0x02 request message as specified in SAE J1979-DA.

The order of the PIDs in the response message is not required to match the order in the request message.

External test equipment shall not request a combination of PIDs supported and PIDs which report data values. The ECU shall support requests for up to three (3) PIDs. The request message may contain the same PID multiple times. The ECU shall treat each PID as a separate parameter and respond with data for each PID as often as requested.

8.2.2 Message data bytes

8.2.2.1 Request powertrain freeze frame data request message definition (read-supported PIDs)

Table 139 — Request powertrain freeze frame data request message (read-supported PIDs)

Data Byte	Parameter Name	Cvt	Hex Value	Mnemonic
#1	Request powertrain freeze frame data request SID	M	0x02	SIDRQ
#2	PID#1 (PIDs supported: SAE J1979-DA)	M	xx	PID
#3	frame #	M	xx	FRNO_
#4	PID#2 (PIDs supported: SAE J1979-DA)	U ^a	xx	PID
#5	frame #	U/C ^b	xx	FRNO_
#6	PID#3 (PIDs supported: SAE J1979-DA)	U	xx	PID
#7	frame #	U/C	xx	FRNO_

^a U = User Optional. PID may be included to reduce multiple PID supported request messages.
^b C = Conditional. Parameter is only included if the preceding PID# is included.

To request PIDs supported range from 0x61 - 0xFF, multiple request messages with PIDs = 0x60, 0x80, 0xA0, 0xC0 and 0xE0 shall be sent to the vehicle.

8.2.2.2 Request powertrain freeze frame data response message definition (report supported PIDs)

The ECU(s) must respond to all supported ranges if requested. A range is defined as a block of 32 PIDs (e.g. range #1: PID 0x01 - 0x20). The ECU shall not respond to unsupported PID ranges unless subsequent ranges have a supported PID(s).

Table 140 — Request powertrain freeze frame data response message (report supported PIDs)

Data Byte	Parameter Name	Cvt	Hex Value	Mnemonic
#1	Request powertrain freeze frame data response SID	M	0x42	SIDPR
#2	1 st supported PID	M	0x00	PID
#3	frame #	M	xx	FRNO_
#4	data record of supported PIDs = [Data A: supported PIDs, Data B: supported PIDs, Data C: supported PIDs, Data D: supported PIDs]	M	xx	DATA_REC
#5		M	xx	DATA_A
#6		M	xx	DATA_B
#7		M	xx	DATA_C
:	:	:	:	:
#n-5	m th supported PID	C1 ^a	xx	PID
#n-4	frame #	C1	xx	FRNO_
#n-3	data record of supported PIDs = [Data A: supported PIDs, Data B: supported PIDs, Data C: supported PIDs, Data D: supported PIDs]	C2 ^b	xx	DATA_REC
#n-2		C2	xx	DATA_A
#n-1		C2	xx	DATA_B
#n		C2	xx	DATA_C

^a C1 = Conditional. PID value shall be the same value as included in the request message if supported by the ECU.
^b C2 = Conditional. Value indicates PIDs supported; range of supported PIDs depends on selected PID value (see C1).

The response message shall only include the PID(s) and Data A to D which are supported by the ECU. If the request message includes a PID value(s) which are not supported by the ECU, those shall not be included in the response message.

8.2.2.3 Request powertrain freeze frame data request message definition (read freeze frame PID values)

Table 141 — Request powertrain freeze frame data request message (read freeze frame PID values)

Data Byte	Parameter Name	Cvt	Hex Value	Mnemonic
#1	Request powertrain freeze frame data request SID	M	0x02	SIDRQ
#2	PID#1 (see SAE J1979-DA)	M	xx	PID
#3	frame #	M	xx	FRNO
#4	PID#2 (see SAE J1979-DA)	U ^a	xx	PID
#5	frame #	C1 ^b	xx	FRNO
#6	PID#3 (see SAE J1979-DA)	U	xx	PID
#7	frame #	C1	xx	FRNO

^a U = User Optional. The parameter may be either present or not.
^b C1 = Conditional. Parameter is only present if the preceding PID# is present.

8.2.2.4 Request powertrain freeze frame data response message definition (report freeze frame PID values)

Table 142 — Request powertrain freeze frame data response message (report freeze frame PID values)

Data Byte	Parameter Name	Cvt	Hex Value	Mnemonic
#1	Request powertrain freeze frame data response SID	M	0x42	SIDPR
#2	1 st supported PID	M	xx	PID_
#3	frame #	M	xx	FRNO_
#4	data record of 1 st supported PID = [data #1.1, data #1.2, : data #1.j]	M	xx	PIDREC_
#5		C1 ^a	xx	DATA_1.1
:		:	xx	DATA_1.2
#j+3		C1	xx	DATA_1.j
:	:	:	:	:
#n	m th supported PID	C2 ^b	xx	PID_
#n+1	frame #	C2	xx	FRNO_
#n+2	data record of m th supported PID = [data #m.1, data #m.2, : data #m.k]	C4 ^c	xx	PIDREC_
#n+3		C4 ^d	xx	DATA_m.1
:		:	xx	DATA_m.2
#n+k+1		C4	xx	DATA_m.k

^a C1 = Conditional. Data depends on selected PID.
^b C2 = Conditional. Parameter shall be the same value as included in the request message and only present if supported.
^c C3 = Conditional. Data #m.1 shall be included if preceding PID is supported.
^d C4 = Conditional. Parameters and values for data depends on selected PID number.

8.2.3 Parameter definition

8.2.3.1 PIDs supported

SAE J1979-DA specifies the interpretation of the data record of supported PIDs.

8.2.3.2 PID and data byte descriptions

SAE J1979-DA specifies standardized emission-related parameters.

8.2.3.3 Frame number description

The frame number identifies the freeze frame, which includes emission-related data values in case an emission-related DTC is detected by the ECU.

8.2.4 Message example

The tables below show how the “request powertrain freeze frame data” service shall be implemented.

8.2.4.1 Step #1: Request supported powertrain freeze frame PIDs from vehicle

The external test equipment requests all supported powertrain freeze frame PIDs of freeze frame 0x00 from the vehicle. Refer to the example of Service 0x01 for guidance on requesting supported PIDs.

As a result of the supported PID request, the external test equipment creates an internal list of supported PIDs for each ECU: ECU#1 (ECM) supports the following PIDs: 0x02 - 0x09, 0x0B - 0x0E. ECU#2 (TCM) does not support any PIDs for this service.

8.2.4.2 Step #2: Request PID 0x02 “DTC which caused freeze frame to be stored” from vehicle

Case #1: Freeze frame data are stored in ECU#1:

Now the external test equipment requests PID 0x02 of freeze frame 0x00 from the vehicle. Since ECU#2 (TCM) doesn't store a freeze frame data record, only ECU#1 (ECM) will send a response message. In this example, the freeze frame data are stored based on a DTC P0130 occurrence. The parameter value of PID 0x02 “DTC that caused required freeze frame data storage” is set to the DTC P0130.

Table 143 — Request powertrain freeze frame data request message

Message Direction:		External test equipment → All ECUs	
Message Type:		Request	
Data Byte	Description (all values are in hexadecimal)	Byte Value	Mnemonic
#1	Request powertrain freeze frame data request SID	0x02	SIDRQ
#2	PID: DTC that caused required freeze frame data storage	0x02	PID
#3	Frame #	0x00	FRNO

Table 144 — Request powertrain freeze frame data response message

Message Direction:		ECU#1 → External test equipment	
Message Type:		Response	
Data Byte	Description (all values are in hexadecimal)	Byte Value	Mnemonic
#1	Request powertrain freeze frame data response SID	0x42	SIDRQ
#2	PID: DTC that caused required freeze frame data storage	0x02	PID
#3	Frame #	0x00	FRNO
#4	DTC High Byte of P0130	0x01	DATA_A
#5	DTC Low Byte of P0130	0x30	DATA_B

NOTE ECU#2 does not store freeze frame data and therefore does not send a response message.

Now the external test equipment requests the parameter value of PID 0x0C “Engine Speed”, PID 0x05 “Engine coolant temperature”, and PID 0x04 “Load”, stored in the freeze frame.

Table 145 — Request powertrain freeze frame data request message

Message Direction:		External test equipment → All ECUs	
Message Type:		Request	
Data Byte	Description (all values are in hexadecimal)	Byte Value	Mnemonic
#1	Request powertrain freeze frame data request SID	0x02	SIDRQ
#2	PID: Engine Speed	0x0C	PID
#3	Frame #	0x00	FRNO
#4	PID: Engine coolant temperature	0x05	PID
#5	Frame #	0x00	FRNO
#4	PID: Load	0x04	PID
#5	Frame #	0x00	FRNO

Table 146 — Request powertrain freeze frame data response message

Message Direction:		ECU#1 → External test equipment	
Message Type:		Response	
Data Byte	Description (all values are in hexadecimal)	Byte Value	Mnemonic
#1	Request powertrain freeze frame data response SID	0x42	SIDRQ
#2	PID: Engine Speed	0x0C	PID
#3	Frame #	0x00	FRNO
#4	High Byte: Engine Speed: 2080 rpm	0x20	DATA_A
#5	Low Byte: Engine Speed: 2080 rpm	0x80	DATA_B
#6	PID: Load	0x04	PID
#7	Frame #	0x00	FRNO
#8	Load: 50,2 %	0x80	DATA_A
#9	PID: Engine coolant temperature	0x05	PID
#10	Frame #	0x00	FRNO
#11	Engine coolant temperature: 0 °C	0x28	DATA_A

Case #2: No freeze frame data is stored in any ECU:

If no freeze frame data is stored, then the parameter value of PID 0x02 “DTC that caused required freeze frame data storage” is set to 0x00 00. If the external test equipment requests a PID excluding 0x00, 0x02, 0x20, 0x40, etc., the ECU shall not send a response message.

Table 147 — Request powertrain freeze frame data request message

Message Direction:		External test equipment → All ECUs	
Message Type:		Request	
Data Byte	Description (all values are in hexadecimal)	Byte Value	Mnemonic
#1	Request powertrain freeze frame data request SID	0x02	SIDRQ
#2	PID: DTC that caused required freeze frame data storage	0x02	PID
#3	Frame #	0x00	FRNO

Table 148 — Request powertrain freeze frame data response message

Message Direction:		ECU#1 → External test equipment	
Message Type:		Response	
Data Byte	Description (all values are in hexadecimal)	Byte Value	Mnemonic
#1	Request powertrain freeze frame data response SID	0x42	SIDRQ
#2	PID: DTC that caused required freeze frame data storage	0x02	PID
#3	Frame #	0x00	FRNO
#4	DTC High Byte of P0000 {no freeze frame data stored}	0x00	DATA_A
#5	DTC Low Byte of P0000 {no freeze frame data stored}	0x00	DATA_B

Case #3: Multiple freeze frames

Cases #1 and #2 imply a scenario where only the required freeze frame (frame 0x00) is stored. This scenario implies the use of static PID support data where PID support data for a given ECU does not change for different frames or different DTCs. Since the PID support data is static, it can be obtained even before a freeze frame is stored.

Manufacturers who wish to store multiple freeze frames or, where allowed by OBD regulations, who wish to store different PID data in freeze frame based on the DTC, would be required to use dynamic PID support data. Dynamic PID support data allows for different PID support data for different freeze frames and for different DTCs. Because of this, dynamic PID support data is not valid until a freeze frame for a particular frame has been stored. Requesting PID support data before a freeze frame is stored would indicate that only PID 0x02 is supported.

External test equipment that supports dynamic PID support data for freeze frame retrieval will be compatible with ECUs that support static PID support data as well as dynamic PID support data, and is therefore the recommended approach.

In this example, every freeze frame supports a different set of PIDs. PID support cannot be determined until after a freeze frame is stored. In order to determine if there are any frames stored, the external test equipment shall request PID 0x02 of freeze frame 0x00 from the vehicle, then request PID 0x02 frame 0x01, then request PID 0x02 frame 0x02, etc. Any frames that report a DTC will have freeze frame data stored. When a frame reports 0x0000, indicating no DTC stored and no freeze frame data, subsequent frames shall also report 0x0000. Note that this requires the ECU to store freeze frames in ascending order starting with frame 0x00, then 0x01, etc. There can be no gaps in the frame numbers, e.g. 0x00, then 0x02, then 0x05. If there are gaps, the tool would have to ask for every possible frame from 0x00 to 0xFF to make sure that all frames are available to the technician. Therefore, gaps are not allowed.

Next, the external test equipment presents a list of available DTCs to the technician. After the technician selects a DTC, the external test equipment requests the supported PIDs for the DTC the technician selected. Once the PIDs supported by that freeze frame have been determined, the external test equipment requests the supported PIDs for the frame associated with the DTC.

8.3 Service 0x03 — Request emission-related diagnostic trouble codes

8.3.1 Functional description

The purpose of this service is to enable the external test equipment to obtain “confirmed” emission-related DTCs.

Send a Service 0x03 request for all emission-related DTCs. Each ECU that has DTCs shall respond with one (1) message containing all emission-related DTCs. If an ECU does not have emission-related DTCs, then it shall respond with a message indicating no DTCs are stored by setting the parameter # of DTC to 0x00.

DTCs are transmitted in two (2) bytes of information for each DTC. The first two (2) bits (high order) of the first (1) byte for each DTC indicate whether the DTC is a powertrain, chassis, body, or network DTC (refer to SAE J2012 for additional interpretation of this structure). The second two (2) bits shall indicate the first digit of the DTC (0 through 3). The second (2) nibble of the first (1) byte and the entire second (2) byte are the next three (3) hexadecimal characters of the actual DTC reported as hexadecimal. A powertrain DTC transmitted as 0x0143 shall be displayed as P0143.

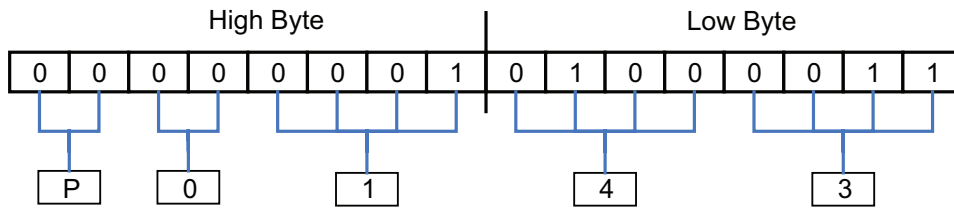

Figure 19 — Diagnostic trouble code encoding example DTC P0143

8.3.2 Message data bytes

8.3.2.1 Request emission-related DTC request message definition

Table 149 — Request emission-related DTC request message

Data Byte	Parameter Name	Cvt	Hex Value	Mnemonic
#1	Request emission-related DTC request SID	M	0x03	SIDRQ

8.3.2.2 Request emission-related DTC response message definition

Table 150 — Request emission-related DTC response message

Data Byte	Parameter Name	Cvt	Hex Value	Mnemonic
#1	Request emission-related DTC response SID	M	0x43	SIDPR
#2	# of DTC = [no emission-related DTCs stored emission-related DTCs stored]	M	xx = [0x00, 0x01 – 0xFF	#OFDTC
#3 #4	DTC#1 (High Byte) DTC#1 (Low Byte)	C ^a C	xx xx	DTC1HI DTC1LO
:	:	:	xx	
#n-1 #n	DTC#m (High Byte) DTC#m (Low Byte)	C C	xx xx	DTCmHI DTCmLO

^a C = Conditional. DTC#1 - DTC#m are only included if # of DTC parameter value ≠ 0x00.

8.3.3 Parameter definition

The # of DTC parameter reports the emission-related DTC(s) currently (at the time of the request message processing) stored in the ECU(s).

8.3.4 Message example

The tables below show how the “request emission-related DTCs” service shall be implemented. The external test equipment requests emission-related DTCs from the vehicle. The ECU#1 (ECM) has six (6) DTCs stored, the ECU#2 (TCM) has one (1) DTC stored, and the ECU#3 (ABS/Traction Control) has no DTC stored.

- ECU#1 (ECM): P0143, P0196, P0234, P02CD, P0357, P0A24
- ECU#2 (TCM): P0443
- ECU#3 (ABS/Traction Control): no emission-related DTC stored

Table 151 — Request emission-related diagnostic trouble codes request message

Message Direction:	External test equipment → All ECUs		
Message Type:	Request		
Data Byte	Description (all values are in hexadecimal)	Byte Value	Mnemonic
#1	Request emission-related DTCs request SID	0x03	SIDRQ

Table 152 — Request emission-related diagnostic trouble codes response message

Message Direction:		ECU#1 → External test equipment	
Message Type:		Response	
Data Byte	Description (all values are in hexadecimal)	Byte Value	Mnemonic
#1	Request emission-related DTCs response SID	0x43	SIDPR
#2	# of DTC {number of emission-related DTCs stored in this ECU}	0x06	#OFDTC
#3	DTC High Byte of P0143	0x01	DTC1HI
#4	DTC Low Byte of P0143	0x43	DTC1LO
#5	DTC High Byte of P0196	0x01	DTC2HI
#6	DTC Low Byte of P0196	0x96	DTC2LO
#7	DTC High Byte of P0234	0x02	DTC3HI
#8	DTC Low Byte of P0234	0x34	DTC3LO
#9	DTC High Byte of P02CD	0x02	DTC4HI
#10	DTC Low Byte of P02CD	0xCD	DTC4LO
#11	DTC High Byte of P0357	0x03	DTC5HI
#12	DTC Low Byte of P0357	0x57	DTC5LO
#13	DTC High Byte of P0A24	0x0A	DTC6HI
#14	DTC Low Byte of P0A24	0x24	DTC6LO

Table 153 — Request emission-related diagnostic trouble codes response message

Message Direction:		ECU#3 → External test equipment	
Message Type:		Response	
Data Byte	Description (all values are in hexadecimal)	Byte Value	Mnemonic
#1	Request emission-related DTCs response SID	0x43	SIDPR
#2	# of DTC {number of emission-related DTCs stored in this ECU}	0x00	#OFDTC

Table 154 — Request emission-related diagnostic trouble codes response message

Message Direction:		ECU#2 → External test equipment	
Message Type:		Response	
Data Byte	Description (all values are in hexadecimal)	Byte Value	Mnemonic
#1	Request emission-related DTCs response SID	0x43	SIDPR
#2	# of DTC {number of emission-related DTCs stored in this ECU}	0x01	#OFDTC
#3	DTC High Byte of P0443	0x04	DTC1HI
#4	DTC Low Byte of P0443	0x43	DTC1LO

8.4 Service 0x04 — Clear/Reset emission-related diagnostic information

8.4.1 Functional description

The purpose of this service is to provide a means for the external test equipment to command ECUs to clear all emission-related diagnostic information. This includes:

- MIL and number of diagnostic trouble codes (can be read with Service 0x01, PID 0x01);
- clear the I/M (Inspection/Maintenance) readiness bits (can be read with Service 0x01, PID 0x01);
- confirmed diagnostic trouble codes (can be read with Service 0x03);
- pending diagnostic trouble codes (can be read with Service 0x07);
- diagnostic trouble code for freeze frame data (can be read with Service 0x02, PID 0x02);
- freeze frame data (can be read with Service 0x02);
- status of system monitoring tests (can be read with Service 0x01, PID 0x41);
- on-board monitoring test results (can be read with Service 0x06);
- distance traveled while MIL is activated (can be read with Service 0x01, PID 0x21);
- number of warm-ups since DTCs cleared (can be read with Service 0x01, PID 0x30);
- distance traveled since DTCs cleared (can be read with Service 0x01, PID 0x31);
- engine run time while MIL is activated (can be read with Service 0x01, PID 0x4D);
- engine run time since DTCs cleared (can be read with Service 0x01, PID 0x4E);
- reset misfire counts of Standardized Test ID 0x0B to zero (can be read with Service 0x06).

Other manufacturer-specific “clearing/resetting” actions may also occur in response to this request message. All ECUs shall respond to this request message with ignition ON and with the engine not running.

For safety and/or technical design reasons, ECUs that cannot perform this operation under other conditions, such as with the engine running, shall send a negative response message with response code 0x22 - conditionsNotCorrect.

Some OBD regulations may require that all OBD ECUs clear diagnostic information under the same conditions (all ECUs must clear diagnostic information with the engine off). If one ECU cannot clear diagnostic information with the engine running, then all OBD ECUs are required to respond in the same manner and not clear diagnostic information with the engine running.

8.4.2 Message data bytes

8.4.2.1 Clear/Reset emission-related diagnostic information request message definition

Table 155 — Clear/Reset emission-related diagnostic information request message

Data Byte	Parameter Name	Cvt	Hex Value	Mnemonic
#1	Clear/reset emission-related diagnostic information request SID	M	0x04	SIDRQ

8.4.2.2 Clear/Reset emission-related diagnostic information response message definition

Table 156 — Clear/Reset emission-related diagnostic information response message

Data Byte	Parameter Name	Cvt	Hex Value	Mnemonic
#1	Clear/reset emission-related diagnostic information response SID	M	0x44	SIDPR

8.4.3 Parameter definition

This service does not support any parameters.

8.4.4 Message example

The example below shows how the “clear/reset emission-related diagnostic information” service shall be implemented if ignition is ON and the engine is not running. The external test equipment commands the vehicle to “clear/reset emission-related diagnostic information”.

Table 157 — Clear/Reset emission-related diagnostic information request message

Message Direction:		External test equipment → All ECUs		
Message Type:		Request		
Data Byte	Description (all values are in hexadecimal)	Byte Value	Mnemonic	
#1	Clear/reset emission-related diagnostic information request SID	0x04	SIDRQ	

Table 158 — Clear/Reset emission-related diagnostic information response message

Message Direction:		ECU#1 → External test equipment		
Message Type:		Response		
Data Byte	Description (all values are in hexadecimal)	Byte Value	Mnemonic	
#1	Clear/reset emission-related diagnostic information response SID	0x44	SIDPR	

Table 159 — Clear/Reset emission-related diagnostic information response message

Message Direction:		ECU#2 → External test equipment		
Message Type:		Response		
Data Byte	Description (all values are in hexadecimal)	Byte Value	Mnemonic	
#1	Clear/reset emission-related diagnostic information response SID	0x44	SIDPR	

Table 160 shows a negative response to “clear/reset emission-related diagnostic information” for an ECU that cannot clear diagnostic information with the engine running.

Table 160 — Negative response message

Message Direction:		ECU#1 → External test equipment	
Message Type:		Response	
Data Byte	Description (all values are in hexadecimal)	Byte Value	Mnemonic
#1	Negative Response Service Identifier	0x7F	SIDNR
#2	Clear/reset emission-related diagnostic information request SID	0x04	SIDRQ
#3	Negative Response Code: conditionsNotCorrect	0x22	NR_CNC

8.5 Service 0x05 — Request oxygen sensor monitoring test results

Service 0x05 is not supported for ISO 15765-4. The functionality of Service 0x05 is implemented in Service 0x06.

8.6 Service 0x06 — Request on-board monitoring test results for specific monitored systems

8.6.1 Functional description

The purpose of this service is to allow access to the results for On-Board Diagnostic monitoring tests of specific components/systems that are continuously monitored (e.g. misfire monitoring for gasoline vehicles) and non-continuously monitored (e.g. catalyst system).

The request message for test values includes an On-Board Diagnostic Monitor ID (see SAE J1979-DA) that indicates the information requested. The response message for test values includes Unit and Scaling information which is defined in SAE J1979-DA. The vehicle manufacturer shall use Unit and Scaling IDs that most closely match the physical quantities used for monitoring in order to make the information more useful to a service technician for diagnostic purposes, e.g. an On-Board Diagnostic Monitor ID in which the monitor checks for a pressure change shall utilize a Unit and Scaling ID which includes pressure in the description.

The vehicle manufacturer is responsible for assigning “Manufacturer Defined Test IDs” for different tests of a monitored system. The latest valid test values (results) are to be retained, even over multiple ignition OFF cycles, until replaced by more recent test values (results). Test values (results) are requested by On-Board Diagnostic Monitor ID. Test values (results) are always reported with the Minimum and Maximum Test Limits. The Unit and Scaling ID included in the response message defines the scaling and unit to be used by the external test equipment to display the test values (results), Minimum Test Limit, and Maximum Test Limit information.

If an On-Board Diagnostic Monitor has not been completed at least once since a “clear/reset emission-related diagnostic information” request was carried out or battery disconnect that erased the latest valid test values, then the parameters Test Value (Results), Minimum Test Limit, and Maximum Test Limit shall be set to zero (0x0000) values. Note that for some unit and scaling IDs, 0x0000 translates to a non-zero result (e.g. Unit and Scaling ID 0x16 for temperature, 0x0000 displays as -40.0 deg C) so some monitors that have not completed may show test results, minimum limits, and maximum limits that, after scaling, are all equal but are non-zero.

Not all On-Board Diagnostic Monitor IDs are applicable or supported by all systems. On-Board Diagnostic Monitor ID 0x00 is a bit-encoded value that indicates for each ECU which On-Board Diagnostic Monitor IDs are supported. On-Board Diagnostic Monitor ID 0x00 indicates support for On-Board Diagnostic Monitor IDs from 0x01 to 0x20. On-Board Diagnostic Monitor ID 0x20 indicates support for On-Board Diagnostic Monitor IDs 0x21 through 0x40, etc. This is the same concept for PIDs/TIDs/INFOTYPES support in Services 0x01, 0x02, 0x06, 0x08, and 0x09. On-Board Diagnostic Monitor ID 0x00 is required for those ECUs that respond to a corresponding Service 0x06 request message as specified in SAE J1979-DA.

The request message including supported On-Board Diagnostic Monitor IDs may contain up to six (6) OBDMIDs. A request message including an On-Board Diagnostic Monitor ID, which reports test values shall only contain one (1) OBDMID. External test equipment shall not request a combination of OBDMIDs supported and a single OBDMID, which report test values. The ECU shall support requests for up to six (6) supported OBDMIDs and only one (1) OBDMID which reports test values.

A unique method must be utilized for displaying data for monitors that have multiple tests. Many OBD monitors have multiple tests that are done in either a serial or parallel manner. If a monitor uses multiple OBD Monitor ID/Test ID combinations that may not all complete at the same time, the following method shall be used to update the stored test results at the time of monitor completion.

After the monitor completes, update all Monitor ID/Test ID combinations (or “test results”) that were utilized by the monitor with appropriate passing or failing results. If a test result (or “Monitor ID/Test ID”) was not utilized during this monitoring event, set the Test Values and Minimum and Maximum Test Limits to their initial values (0x0000, test not completed). Test results from the previously completed monitoring events shall not be mixed with test results from the current completed monitoring event.

In some cases, test results (or “Monitor ID/Test ID combinations”) will be displayed as being incomplete even though the monitor (as indicated by PID 0x41) was successfully completed and either passed or failed. In other cases, some Test IDs will show passing results while others will show failing results after the monitor (as indicated by PID 0x41) was successfully completed and failed. Note that OBD-II regulations prohibit a passing monitor from showing any failing test results. If an initial, serial test indicates a failure and a subsequent re-test of the system indicates a passing result, the test that was utilized to make the passing determination should be displayed, while the failing test that was utilized to make the initial determination should be reset to its initial values (0x0000, test not completed).

An example for a serial monitor is an evaporative leakage monitor where the monitor first checks a reference leak and then starts to execute the actual leakage check. If the reference test fails, then the leakage test is not executed.

As an example of a parallel monitor, a purge valve flow monitor can pass by having a large rich lambda shift, a large lean lambda shift or a large engine rpm increase. If the purge valve is activated and a large rich lambda shift occurs, the Test ID for the rich lambda shift would show a passing result while the other two Test IDs would show incomplete. Since some Test IDs for a completed monitor will show incomplete, PID 0x41 must be used to determine monitor completion status.

8.6.2 Message data bytes

8.6.2.1 Request on-board monitoring test results for specific monitored systems request message definition (read-supported OBDMIDs)

Table 161 — Request on-board monitoring test results for specific monitored systems request message (read-supported OBDMIDs)

Data Byte	Parameter Name	Cvt	Hex Value	Mnemonic
#1	Request on-board monitoring test results for specific monitored systems request SID	M	0x06	SIDRQ
#2	On-Board Diagnostic Monitor ID (OBDMIDs supported: SAE J1979-DA)	M	xx	OBDMID
#3	On-Board Diagnostic Monitor ID (OBDMIDs supported: SAE J1979-DA)	U ^a	xx	OBDMID
#4	On-Board Diagnostic Monitor ID (OBDMIDs supported: SAE J1979-DA)	U	xx	OBDMID
#5	On-Board Diagnostic Monitor ID (OBDMIDs supported: SAE J1979-DA)	U	xx	OBDMID
#6	On-Board Diagnostic Monitor ID (OBDMIDs supported: SAE J1979-DA)	U	xx	OBDMID
#7	On-Board Diagnostic Monitor ID (OBDMIDs supported: SAE J1979-DA)	U	xx	OBDMID
^a U = User Optional. OBDMID may be included to avoid multiple OBDMID supported request messages.				

To request OBDMIDs supported range from 0xC1 - 0xFF, another request message with OBDMID#1 = 0xC0 and OBDMID#2 = 0xE0 shall be sent to the vehicle

8.6.2.2 Request on-board monitoring test results for specific monitored systems response message definition (report supported OBDMIDs)

ECU(s) must respond to all supported ranges if requested. A range is defined as a block of 32 OBDMIDs (e.g. range #1: OBDMID 0x01 - 0x20). The ECU shall not respond to unsupported OBDMID ranges unless subsequent ranges have a supported OBDMID(s).

Table 162 — Request on-board monitoring test results for specific monitored systems response message (report supported OBDMIDs)

Data Byte	Parameter Name	Cvt	Hex Value	Mnemonic
#1	Request on-board monitoring test results for specific monitored systems response SID	M	0x46	SIDPR
#2	data record of supported OBDMID = [1 st supported OBDMID Data A: supported OBDMIDs, Data B: supported OBDMIDs, Data C: supported OBDMIDs, Data D: supported OBDMIDs]	M	xx	OBDMIDREC OBDMID
#3		M	xx	DATA_A
#4		M	xx	DATA_B
#5		M	xx	DATA_C
#6		M	xx	DATA_D
:	:	:	:	:
#n-4	data record of supported OBDMID = [m th supported OBDMID Data A: supported OBDMIDs, Data B: supported OBDMIDs, Data C: supported OBDMIDs, Data D: supported OBDMIDs]	C1 ^a	xx	OBDMIDREC OBDMID
#n-3		C2 ^b	xx	DATA_A
#n-2		C2	xx	DATA_B
#n-1		C2	xx	DATA_C
#n		C2	xx	DATA_D

^a C1 = Conditional. OBDMID value shall be the same value as included in the request message if supported by the ECU.

^b C2 = Conditional. Value indicates OBDMIDs supported; range of supported OBDMIDs depends on selected OBDMID value (see C1).

The response message shall only include the OBDMID(s) and Data A to D, which are supported by the ECU. If the request message includes a OBDMID value(s) which are not supported by the ECU, those shall not be included in the response message.

8.6.2.3 Request on-board monitoring test results for specific monitored systems request message definition (read OBDMID test values)

Table 163 — Request on-board monitoring test results for specific monitored systems request message (read OBDMID test values)

Data Byte	Parameter Name	Cvt	Hex Value	Mnemonic
#1	Request on-board monitoring test results for specific monitored systems request SID	M	0x06	SIDRQ
#2	On-Board Diagnostic Monitor ID	M	xx	OBDMID

8.6.2.4 Request on-board monitoring test results for specific monitored systems response message definition (report OBDMID test values)

Table 164 — Request on-board monitoring test results for specific monitored systems response message (report OBDMID test values)

Data Byte	Parameter Name	Cvt	Hex Value	Mnemonic
#1	Request on-board monitoring test results for specific monitored systems response SID	M	0x46	SIDPR
#2	data record of supported OBDMID = [OBDMIDREC
#3	On-Board Diagnostic Monitor ID	M	xx	OBDMID
#4	Std./Manuf. Defined TID#1	M	xx	S/MDTID
#5	Unit And Scaling ID#1	M	xx	UASID
#6	Test Value (High Byte)#1	M	xx	TVHI
#7	Test Value (Low Byte)#1	M	xx	TVLO
#8	Min. Test Limit (High Byte)#1	M	xx	MINTLHI
#9	Min. Test Limit (Low Byte)#1	M	xx	MINTLLO
#10	Max. Test Limit (High Byte)#1	M	xx	MAXTLHI
	Max. Test Limit (Low Byte)#1]	M	xx	MAXTLLO
:	:	:	:	:
#n-8	data record of supported OBDMID = [OBDMIDREC
#n-7	On-Board Diagnostic Monitor ID	C1 ^a	xx	OBDMID
#n-6	Std./Manuf. Defined TID#m	C2 ^b	xx	S/MDTID
#n-5	Unit And Scaling ID#m	C2	xx	UASID
#n-4	Test Value (High Byte)#m	C2	xx	TVHI
#n-3	Test Value (Low Byte)#m	C2	xx	TVLO
#n-2	Min. Test Limit (High Byte)#m	C2	xx	MINTLHI
#n-1	Min. Test Limit (Low Byte)#m	C2	xx	MINTLLO
#n	Max. Test Limit (High Byte)#m	C2	xx	MAXTLHI
	Max. Test Limit (Low Byte)#m]	C2	xx	MAXTLLO

^a C1 = Conditional. Parameter is only present if more than one (1) Manufacturer Defined TID is supported by the ECU for the requested Monitor ID.

^b C2 = Conditional. Parameter and value depend on selected Manufacturer Defined TID number and are only included if the Manufacturer Defined TID is supported by the ECU. The value shall be zero (0x00) in case the On-Board Diagnostic Monitor has not been completed at least once since clear/reset emission-related diagnostic information or battery disconnect.

8.6.3 Parameter definition

8.6.3.1 On-Board Diagnostic Monitor IDs supported

The On-Board Diagnostic Monitor IDs supported is the same concept as used for PID support in Services 0x01 and 0x02 as specified in SAE J1979-DA.

8.6.3.2 On-Board Diagnostic Monitor ID description

The On-Board Diagnostic Monitor ID is a one (1) byte parameter and is defined in SAE J1979-DA. An On-Board Diagnostic Monitor may have more than one (1) monitor test (Test ID).

NOTE The On-Board Diagnostic Monitor ID is similar to the Test ID parameter specified in Service 0x06 in 6.6.3.1.

8.6.3.3 Standardized and Manufacturer Defined Test ID description

The Standardized and Manufacturer Defined Test ID is a one (1) byte parameter. For example, the On-Board Diagnostic Monitor “Oxygen Sensor Monitor Bank 1 - Sensor 1” or the On-Board Diagnostic Misfire Monitor may use some of the following Standardized Test IDs.

Test IDs used in Service 0x05 which are constants (0x01, 0x02, 0x03, 0x04) are not required to be supported in Service 0x06.

Table 165 describes Standardized Test IDs.

For the Standardized Test IDs that are constant values, the Minimum and Maximum Test Limits shall be the same values as reported for the Test Value.

Table 165 — Standardized Test ID description

Range	Description
0x00	ISO/SAE reserved
0x01	Rich to lean sensor threshold voltage (constant)
0x02	Lean to rich sensor threshold voltage (constant)
0x03	Low sensor voltage for switch time calculation (constant)
0x04	High sensor voltage for switch time calculation (constant)
0x05	Rich to lean sensor switch time (calculated)
0x06	Lean to rich sensor switch time (calculated)
0x07	Minimum sensor voltage for test cycle (calculated)
0x08	Maximum sensor voltage for test cycle (calculated)
0x09	Time between sensor transitions (calculated)
0x0A	Sensor period (calculated)
0x0B	<p>Exponential Weighted Moving Average (EWMA) misfire counts for previous driving cycles (calculated, rounded to an integer value)</p> <p>General EWMA calculation: $0.1 * (\text{current misfire counts}) + 0.9 * (\text{previous misfire counts average})$</p> <p>Initial value for (previous misfire counts average) = 0</p> <p>NOTE Internal ECU calculation registers with precision higher than one count shall be used and retained to calculate the contents of registers 0x0B and 0x0C to prevent rounding errors. If this is not done, these registers will never count back down to zero after misfire stops. The calculations shall be carried out using the high-precision registers, then rounded to the nearest integer value to be output as register 0x0B and 0x0C.</p> <p>$\text{High_Precision_EWMA_Misfire_Counts}_{\text{current}} = \text{Rounded} [(0.1) * \text{High_Precision_Misfire_Counts}_{\text{current}} + (0.9) * \text{High_Precision_EWMA_Misfire_Counts}_{\text{previous}}]$</p> <p>Where: Rounded means rounded to the nearest integer. The high-precision values are never reported, they are only used for internal calculations.</p> <p>This TEST ID shall be reported with OBD Monitor IDs 0xA2 – 0xAD (refer to SAE J1979-DA) and the Scaling ID 0x24 (refer to SAE J1979-DA).</p>
0x0C	<p>Misfire counts for last/current driving cycles (calculated, rounded to an integer value).</p> <p>This TEST ID shall be reported with OBD Monitor IDs 0xA2 – 0xAD (see SAE J1979-DA) and the Scaling ID 0x24 (see SAE J1979-DA).</p>
0x0D – 0x7F	Reserved for future standardization

Table 166 — Manufacturer Defined Test ID description

Range	Description
0x80 – 0xFE	Manufacturer Defined Test ID range — This parameter is an identifier for the test performed within the On-Board Diagnostic Monitor.
0xFF	ISO/SAE reserved

The results of the latest mandated on-board oxygen sensor monitoring tests can be seen in Figure 20.

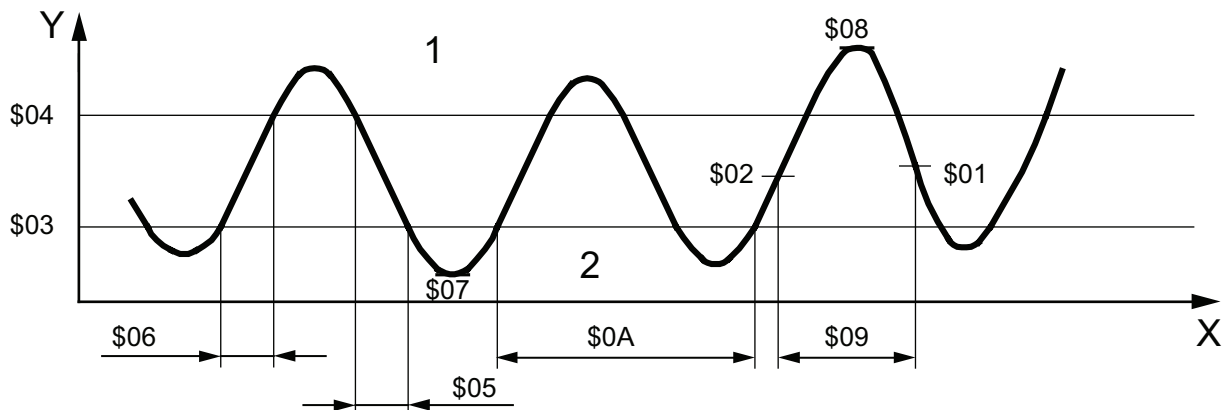

Key

- 1 rich
- 2 lean

Figure 20 — Standardized Test ID value example

8.6.3.4 Example for use of Standardized Test IDs for misfire monitor

OBD regulations may require reporting the number of misfires detected during the current driving cycle (Test ID 0x0C) and the average number of misfires detected during the previous driving cycles (Test ID 0x0B) for each cylinder. Therefore, for a 4-cylinder engine, eight (8) pieces of data must be reported for both Test IDs. The purpose of the misfire data is to help a service technician identify which cylinders are currently misfiring (0x0C) and identify which cylinders have been consistently misfiring in the previous driving cycles (0x0B). The actual misfire counts will depend on how the vehicle was driven, how long it was driven, etc. Misfire counts for cylinders shall only be compared relative to each other. If some cylinders have many more misfires than other cylinders, the technician should probably begin his troubleshooting with the cylinders that have the highest misfire counts.

The 0x0B registers contain the Exponential Weighted Moving Average (EWMA) values for misfire counted during previous driving cycles. The EWMA values should only be re-calculated once per driving cycle. This calculation can be done every power-up, or every power-down sequence if the ECU stays alive after the ignition key is turned off. The EWMA value uses the misfire counts collected during the last/current driving cycle. The value of the 0x0C counters, after the driving cycle ends, is the number of misfires counted during the current/last driving cycle. The software shall take the contents of the 0x0B register (this is the previous average) multiply by 0,9 and add the contents of the 0x0C register (this is the current counts) multiplied by 0,1. This becomes the new EWMA value.

The internal ECU calculation registers with precision higher than one count shall be used and retained to calculate the contents of registers 0x0B and 0x0C to prevent rounding errors. If this is not done, these registers will never count back down to zero after misfire stops. The calculations shall be done using the high-precision registers, then rounded to the nearest integer value to be output as register 0x0B and 0x0C. The last row of Table 167 shows the high-precision internal calculation.

The Test ID 0x0C counters shall count misfires for each cylinder and save them in Keep Alive or Non-Volatile Memory. They should update continuously, in 200 or 1 000 revolution increments, as a minimum. When the engine starts, the 0x0C misfire counters shall be reset to zero. Prior to engine start-up, the last value from the previous driving cycle shall be retained and displayed until the engine starts so that a service technician can see how many misfires occurred the last time the vehicle was driven.

If a vehicle has constant misfire in one or more cylinders, the service technician can watch the Test ID 0x0C counters count-up as he drives the vehicle, up to a maximum of 65 535 misfires. If the technician is driving and watching the 0x0C counters, he would be seeing misfire counts for the “current” driving cycle. If he turns off the ignition key, he has just ended the current driving cycle. If he then turns the key back on, but does not

start the engine, the 0x0C counters will contain the number of misfires that occurred during the “last” driving cycle. If the technician now starts the engine, the 0x0C counters will be reset to zero and the software starts counting misfires all over again.

There are no minimum or maximum misfire monitor threshold limits for misfire counts. Test IDs 0x0B and 0x0C just accumulate the number of misfires that occurred. These counts should accumulate with or without a misfire DTC. If there was a little misfire, but not enough to store a DTC, Test ID 0x0B and 0x0C values for each cylinder should still show the number of misfires that occurred. The minimum test limit value should be 0; the maximum test limit value should be 65 535. Therefore, there will never be a “fail” result.

For this example, the vehicle PCM or ECM does not stay alive after shutdown so EWMA values are updated at every power-up.

Table 167 — Misfire Test ID 0x0B and 0x0C example

Misfire counts	Cyl #1 Counts	Cyl #1 EWMA	Cyl #2 Counts	Cyl #2 EWMA	Cyl#3 Counts	Cyl#3 EWMA	Cyl#4 Counts	Cyl#4 EWMA
Monitor ID / Test ID	0xA2 / 0x0C	0xA2 / 0x0B	0xA3 / 0x0C	0xA3 / 0x0B	0xA4 / 0x0C	0xA4 / 0x0B	0xA5 / 0x0C	0xA5 / 0x0C
key on, drive cycle 1	0	0	0	0	0	0	0	0
start engine	0	0	0	0	0	0	0	0
drive with misfire	200	0	1	0	500	0	9	0
key off	200	0	1	0	500	0	9	0
key on, drive cycle 2	200	20	1	0	500	50	9	1
start engine	0	20	0	0	0	50	0	1
drive with misfire	1 000	20	4	0	3 000	50	12	1
key off	1 000	20	4	0	3 000	50	12	1
key on, drive cycle 3	1 000	118	4	0	3 000	345	12	2
start engine	0	118	0	0	0	345	0	2
drive with misfire	1 000	118	4	0	3 000	345	12	2
key off	1 000	118	4	0	3 000	345	12	2
key on, drive cycle 4	1 000	206	4	0	3 000	611	12	3
start engine	0	206	0	0	0	611	0	3
drive with misfire	1 000	206	4	0	3 000	611	12	3
key off	1 000	206	4	0	3 000	611	12	3
key on, drive cycle 5	1 000	286	4	0	3 000	849	12	4
start engine	0	286	0	0	0	849	0	4
drive with misfire	1 000	286	4	0	3 000	849	12	4
key off	1 000	285	4	0	3 000	849	12	4
key on, drive cycle 6	1 000	357	4	0	3 000	1 065	12	5
start engine	0	357	0	0	0	1 065	0	5
drive with misfire	1 000	357	4	0	3 000	1 065	12	5
key off	1 000	357	4	0	3 000	1 065	12	5
key on, drive cycle 12	1 000	692	4	0	3 000	2 074	12	8
start engine	0	692	0	0	0	2 074	0	8
Monitor ID / Test ID	0xA2 / 0x0C	0xA2 / 0x0B	0xA3 / 0x0C	0xA3 / 0x0B	0xA4 / 0x0C	0xA4 / 0x0B	0xA5 / 0x0C	0xA5 / 0x0C
drive with misfire	1 000	692	4	0	3 000	2 074	12	8
key off	1 000	692 (692,456)	4	0 (0,444)	3 000	2 074 (2 074,259)	12	8 (8,130)

8.6.3.5 Unit and Scaling ID definition

The Unit and Scaling ID is a one (1) byte identifier to reference the scaling and unit to be used by the external test equipment to calculate and display the test values (results), Minimum Test Limit, and the Maximum Test Limit for the Standardized and Manufacturer Defined Test ID requested. All standardized Unit And Scaling IDs are specified in SAE J1979-DA.

8.6.3.6 Test Value (Result) description

The Test Value represents the test result and is defined in Table 168.

Table 168 — Test Value description

Parameter Name	# of Bytes	Description
Test Value	2 (High and Low Byte)	Test Value (Result) — This value shall be calculated and displayed by the external test equipment based on the Unit and Scaling ID included in the response message. The Test Value shall be within the Minimum and Maximum Test Limit to indicate a “Pass” result.

8.6.3.7 Minimum Test Limit description

The Minimum Test Limit parameter is defined in Table 169.

Table 169 — Minimum Test Limit description

Parameter Name	# of Bytes	Description
Minimum Test Limit	2 (High and Low Byte)	<p>The Minimum Test Limit shall be calculated and displayed by the external test equipment based on the Unit and Scaling ID included in the response message. The Unit and Scaling IDs are specified in SAE J1979-DA of this document monitor identified by the On-Board Diagnostic Monitor ID. For the Standardized Test IDs that are constant values, the Minimum Test Limit shall be the same value as reported for the Test Value.</p> <p>The following conditions apply:</p> <ul style="list-style-type: none"> – if the Test Value is less than the Minimum Test Value, this results in a “Fail” condition; – if the Test Value equals the Minimum Test Value, this results in a “Pass” condition; – if the Test Value is greater than the Minimum Test Value, this results in a “Pass” condition.

8.6.3.8 Maximum Test Limit description

The Maximum Test Limit parameter is defined in Table 170.

Table 170 — Maximum Test Limit description

Parameter Name	# of Bytes	Description
Maximum Test Limit	2 (High and Low Byte)	<p>The Maximum Test Limit shall be calculated and displayed by the external test equipment based on the Unit and Scaling ID included in the response message. The Unit and Scaling IDs are specified in SAE J1979-DA. The Maximum Test Limit shall be the maximum value for the monitor identified by the On-Board Diagnostic Monitor ID. For the Standardized Test IDs that are constant values, the Maximum Test Limit shall be the same value as reported for the Test Value.</p> <p>The following conditions apply</p> <ul style="list-style-type: none"> – if the Test Value is less than the Maximum Test Value, this results in a “Pass” condition; – if the Test Value equals the Maximum Test Value, this results in a “Pass” condition; – if the Test Value is greater than the Maximum Test Value, this results in a “Fail” condition.

8.6.4 Message example

Tables 171 and 172 show how the “request on-board monitoring test results for specific monitored systems” service shall be implemented.

8.6.4.1 Step #1: Request on-board monitoring test results for specific monitored systems (request for supported OBDMIDs)

The external test equipment requests all supported OBDMIDs from the vehicle. Refer to the example of Service 0x01 for guidance in requesting supported PIDs (the same concept is used for supported OBDMIDs).

As a result of the supported OBDMID request, the external test equipment creates an internal list of supported OBDMIDs for each ECU. ECU#1 (ECM) supports OBDMIDs 0x01, 0x05, 0x10, and 0x21. ECU#2 (TCM) does not support any OBDMIDs.

8.6.4.2 Step #2: Request on-board monitoring test results for specific monitored systems

The external test equipment sends a “request on-board monitoring test results for specific monitored systems” message with one supported OBDMID in the request message to the vehicle. In this example, the request message includes the following OBDMID:

— Request message: OBDMID 0x01 - Oxygen Sensor Monitor Bank 1 - Sensor 1

Table 171 — Request oxygen sensor monitoring test results request message

Message Direction:	External test equipment → All ECUs		
Message Type:	Request		
Data Byte	Description (all values are in hexadecimal)	Byte Value	Mnemonic
#1	Request on-board monitoring test results for specific monitored systems request SID	0x06	SIDRQ
#2	OBDMID: 0x01 - Oxygen Sensor Monitor Bank 1 - Sensor 1	0x01	OBDMID

Table 172 — Request oxygen sensor monitoring test results response message

Message Direction:		ECU#1 → External test equipment	
Message Type:		Response	
Data Byte	Description (all values are in hexadecimal)	Byte Value	Mnemonic
#1	Request on-board monitoring test results for specific monitored systems response SID	0x46	SIDPRQ
#2	OBDMID: 0x01 - Oxygen Sensor Monitor Bank 1 - Sensor 1	0x01	OBDMID
#3	Standardized Test ID: 0x01 - Rich to lean sensor threshold voltage (constant)	0x01	STID
#4	Unit And Scaling ID: Voltage	0x0A	UASID
#5	Test Value High Byte:	0x0B	TESTVAL
#6	Test Value Low Byte: 0.365 V	0xB0	TESTVAL
#7	Minimum Test Limit High Byte:	0x0B	MINLIMIT
#8	Minimum Test Limit Low Byte: 0.365 V	0xB0	MINLIMIT
#9	Maximum Test Limit High Byte:	0x0B	MAXLIMIT
#10	Maximum Test Limit Low Byte: 0.365 V	0xB0	MAXLIMIT
#11	OBDMID: 01 - Oxygen Sensor Monitor Bank 1 - Sensor 1	0x01	OBDMID
#12	Standardized Test ID: 0x05 - Rich to lean sensor switch time (calculated)	0x05	STID
#13	Unit And Scaling ID: Time	0x10	UASID
#14	Test Value High Byte	0x00	TESTVAL
#15	Test Value Low Byte: 0.072 s (0 min, 0 s)	0x48	TESTVAL
#16	Minimum Test Limit High Byte	0x00	MINLIMIT
#17	Minimum Test Limit Low Byte: 0.000 s (0 min, 0 s)	0x00	MINLIMIT
#18	Maximum Test Limit High Byte	0x00	MAXLIMIT
#19	Maximum Test Limit Low Byte: 0.100 s (0 min, 0 s)	0x64	MAXLIMIT
#20	OBDMID: 0x01 - Oxygen Sensor Monitor Bank 1 - Sensor 1	0x01	OBDMID
#21	Manufacturer Defined Test ID: 133 _{dec} (The name of this Test ID shall be documented in the vehicle Service Information.)	0x85	MDTID
#22	Unit And Scaling ID: Counts	0x24	UASID
#23	Test Value High Byte	0x00	TESTVAL
#24	Test Value Low Byte: 150 counts	0x96	TESTVAL
#25	Minimum Test Limit High Byte	0x00	MINLIMIT
#26	Minimum Test Limit Low Byte: 75 counts	0x4B	MINLIMIT
#27	Maximum Test Limit High Byte	0xFF	MAXLIMIT
#28	Maximum Test Limit Low Byte: 65535 counts	0xFF	MAXLIMIT

NOTE ECU#2 does not support any Test IDs and therefore does not send a response message.

8.6.4.3 Request on-board monitoring test results for specific monitored systems

In this example, the requested monitor has not been completed since a clear/reset emission-related diagnostic information event. The request message includes the following OBDMID request message: OBDMID 0x21 - Catalyst Monitor Bank 1.

Table 173 — Request Catalyst Monitor Bank 1 monitoring test results request message

Message Direction:		External test equipment → All ECUs	
Message Type:		Request	
Data Byte	Description (all values are in hexadecimal)	Byte Value	Mnemonic
#1	Request on-board monitoring test results for specific monitored systems request SID	0x06	SIDRQ
#2	OBDMID: 0x21 - Catalyst Monitor Bank 1	0x21	OBDMID

Table 174 — Request Catalyst Monitor Bank 1 monitoring test results response message

Message Direction:		ECU#1 → External test equipment	
Message Type:		Response	
Data Byte	Description (all values are in hexadecimal)	Byte Value	Mnemonic
#1	Request on-board monitoring test results for specific monitored systems response SID	0x46	SIDPRQ
#2	OBDMID: 0x21 - Catalyst Monitor Bank 1	0x21	OBDMID
#3	Manufacturer Defined Test ID: 135 _{dec}	0x87	MDTID
#4	Unit And Scaling ID: Percent	0x2E	UASID
#5	Test Value High Byte: Monitor not completed at least once since erasure	0x00	TESTVAL
#6	Test Value Low Byte: 0.00 %	0x00	TESTVAL
#7	Minimum Test Limit High Byte	0x00	MINLIMIT
#8	Minimum Test Limit Low Byte: 0.00 %	0x00	MINLIMIT
#9	Maximum Test Limit High Byte	0x00	MAXLIMIT
#10	Maximum Test Limit Low Byte: 0.00%	0x00	MAXLIMIT

NOTE ECU#2 does not support any Test IDs and therefore does not send a response message.

8.7 Service 0x07 — Request emission-related diagnostic trouble codes detected during current or last completed driving cycle

8.7.1 Functional description

The purpose of this service is to enable the external test equipment to obtain “pending” diagnostic trouble codes detected during current or last completed driving cycle for emission-related components/systems. Service 0x07 is required for all DTCs and is independent of Service 0x03. The intended use of this data is to assist the service technician after a vehicle repair, and after clearing diagnostic information, by reporting test results after a single driving cycle. If the test failed during the driving cycle, the DTC associated with that test shall be reported. Test results reported by this service do not necessarily indicate a faulty component/system. If test results indicate a failure after additional driving, then the MIL will be illuminated and a DTC will be set and reported with Service 0x03, indicating a faulty component/system. This service can always be used to request the results of the latest test, independent of the setting of a DTC.

Test results for these components/systems shall be reported in the same format as the DTCs in Service 0x03 (see the functional description for Service 0x03).

8.7.2 Message data bytes

8.7.2.1 Request emission-related diagnostic trouble codes detected during current or last completed driving cycle request message definition

Table 175 — Request emission-related diagnostic trouble codes detected during current or last completed driving cycle request message

Data Byte	Parameter Name	Cvt	Hex Value	Mnemonic
#1	Request emission-related diagnostic trouble codes detected during current or last completed driving cycle request SID	M	0x07	SIDRQ

8.7.2.2 Request emission-related diagnostic trouble codes detected during current or last completed driving cycle response message definition

Table 176 — Request emission-related diagnostic trouble codes detected during current or last completed driving cycle response message

Data Byte	Parameter Name	Cvt	Hex Value	Mnemonic
#1	Request emission-related diagnostic trouble codes detected during current or last completed driving cycle response SID	M	0x47	SIDPR
#2	# of DTC = [no emission-related DTCs # of emission-related DTCs]	M	0x00 0x01 – 0xFF	#OFDTC
#3	DTC#1 (High Byte)	C ^a	xx	DTC1HI
#4	DTC#1 (Low Byte)	C	xx	DTC1LO
:	:	:	xx	
#n-1	DTC#m (High Byte)	C	xx	DTCmHI
#n	DTC#m (Low Byte)	C	xx	DTCmLO

^a C = Conditional. DTC#1 - DTC#m are only included if # of DTC parameter value ≠ 0x00.

8.7.3 Parameter definition

The # of DTC parameter reports the emission-related DTC(s) currently (at the time of the request message processing) stored in the ECU(s).

8.7.4 Message example

Refer to message example of Service 0x03.

8.8 Service 0x08 — Request control of on-board system, test or component

8.8.1 Functional description

The purpose of this service is to enable the external test equipment to control the operation of an on-board system, test or component.

The data bytes will be specified, if necessary, for each Test ID in SAE J1979-DA, and will be unique for each Test ID.

Possible uses for these data bytes in the request message are to:

- turn on-board system/test/component ON;
- turn on-board system/test/component OFF; and
- cycle on-board system/test/component for 'n' seconds.

Possible uses for these data bytes in the response message are to:

- report system status; and
- report test results.

Not all TIDs are applicable or supported by all systems. TID 0x00 is a bit-encoded value that indicates for each ECU which TIDs are supported. TID 0x00 indicates support for TIDs from 0x01 to 0x20. TID 0x20 indicates support for TIDs 0x21 through 0x40, etc. This is the same concept for PIDs/TIDs/INFOTYPES support in Services 0x01, 0x02, 0x06, 0x08, 0x09. TID 0x00 is required for those ECUs that respond to a corresponding Service 0x08 request message as specified in SAE J1979-DA.

The order of the TIDs in the response message is not required to match the order in the request message.

The request message, including supported Test IDs, may contain up to six (6) Test IDs. A request message, including a Test ID with optional data, shall only contain one (1) Test ID. External test equipment is not allowed to request a combination of Test IDs supported and a single Test ID with optional data. The ECU shall support requests for up to six (6) supported Test IDs and only one (1) Test ID with optional data.

8.8.2 Message data bytes

8.8.2.1 Request control of on-board device request message definition (read-supported TIDs)

Table 177 — Request control of on-board device request message (read-supported TIDs)

Data Byte	Parameter Name	Cvt	Hex Value	Mnemonic
#1	Request control of on-board device request SID	M	0x08	SIDRQ
#2	TID#1 (Test IDs supported: SAE J1979-DA)	M	xx	TID
#3	TID#2 (Test IDs supported: SAE J1979-DA)	U	xx	TID
#4	TID#3 (Test IDs supported: SAE J1979-DA)	U	xx	TID
#5	TID#4 (Test IDs supported: SAE J1979-DA)	U	xx	TID
#6	TID#5 (Test IDs supported: SAE J1979-DA)	U	xx	TID
#7	TID#6 (Test IDs supported: SAE J1979-DA)	U	xx	TID

U = User Optional. TID may be included to avoid multiple TID supported request messages.

To request TIDs supported range from 0xC1 to 0xFF, another request message with TID#1 = 0xC0 and TID#2 = 0xE0 shall be sent to the vehicle.

8.8.2.2 Request control of on-board device response message definition (report supported TIDs)

ECU(s) shall respond to all supported ranges if requested. A range is defined as a block of 32 TIDs (e.g. range #1: TID 0x01 - 0x20). The ECU shall not respond to unsupported TID ranges unless subsequent ranges have a supported TID(s).

Table 178 — Request control of on-board device response message (report supported TIDs)

Data Byte	Parameter Name	Cvt	Hex Value	Mnemonic
#1	Request control of on-board device response message SID	M	0x48	SIDPR
#2	data record of supported TIDs = [1 st supported TID Data A: supported TIDs, Data B: supported TIDs, Data C: supported TIDs, Data D: supported TIDs]	M	xx	TIDREC_ TID
#3		M	xx	DATA_A
#4		M	xx	DATA_B
#5		M	xx	DATA_C
#6		M	xx	DATA_D
:	:	:	:	:
#n-4	data record of supported TIDs = [m th supported TID Data A: supported TIDs, Data B: supported TIDs, Data C: supported TIDs, Data D: supported TIDs]	C1 ^a	xx	TIDREC_ TID
#n-3		C2 ^b	xx	DATA_A
#n-2		C2	xx	DATA_B
#n-1		C2	xx	DATA_C
#n		C2	xx	DATA_D
^a C1 = Conditional. TID value shall be the same value as included in the request message if supported by the ECU.				
^b C2 = Conditional. Value indicates TIDs supported; range of supported TIDs depends on selected TID value (see C1).				

The response message shall only include the TID(s) and Data A to D which are supported by the ECU. If the request message includes a TID value(s) which are not supported by the ECU, those shall not be included in the response message.

8.8.2.3 Request control of on-board system request message definition (read TID values)

Table 179 — Request control of on-board device request message (read TID values)

Data Byte	Parameter Name	Cvt	Hex Value	Mnemonic
#1	Request control of on-board device request SID	M	0x08	SIDRQ
#2	data record of Test ID = [Test ID (request Test ID values) Data A, Data B, Data C, Data D, Data E]	M/C1 ^a	xx	TIDREC TID
#3		C2 ^b	xx	DATA_A
#4		C2	xx	DATA_B
#5		C2	xx	DATA_C
#6		C2	xx	DATA_D
#7		C2	xx	DATA_E
^a C1 = Conditional. Test ID value shall be one of the supported Test IDs of previous response message.				
^b C2 = Conditional. Presence and values of Data A to E parameter depend on Test ID.				

8.8.2.4 Request control of on-board device response message definition (report TID values)

Table 180 — Request control of on-board device response message (report TID values)

Data Byte	Parameter Name	Cvt	Hex Value	Mnemonic
#1	Request control of on-board device response SID	M	0x48	SIDPR
#2	data record of Test ID = [Test ID (report Test ID values) Data A, Data B, Data C, Data D, Data E]	M/C1 ^a	xx	TIDREC TID
#3		C2 ^b	xx	DATA_A
#4		C2	xx	DATA_B
#5		C2	xx	DATA_C
#6		C2	xx	DATA_D
#7		C2	xx	DATA_E
^a C1 = Conditional. Test ID value shall be the same value as included in the request message.				
^b C2 = Conditional. Presence and values of Data A to E parameter depend on Test ID.				

8.8.3 Parameter definition

8.8.3.1 Test IDs supported

Refer to SAE J1979-DA.

8.8.3.2 Test ID description

Refer to SAE J1979-DA.

8.8.4 Message example

Tables 181 and 182 show how “request control of on-board system, test or component” service shall be implemented.

8.8.4.1 Step #1: Request control of on-board system, test or component (request for supported Test IDs)

The external test equipment requests all supported Test IDs from the vehicle. Refer to the example of Service 0x01 for guidance on requesting supported Test IDs (the same concept is used for supported TIDs).

As a result of the supported TID request, the external test equipment creates an internal list of supported PIDs for each ECU: ECU#1 (ECM) supports Test ID 0x01. ECU#2 (TCM) does not support any Test IDs and therefore does not send a response message.

8.8.4.2 Step #2: Request control of on-board device (Service 0x08, Test ID 0x01)

The external test equipment sends a “request control of on-board device” message with one (1) supported Test ID 0x01 to the vehicle.

Table 181 — Request control of on-board device request message

Message Direction:		External test equipment → All ECUs	
Message Type:		Request	
Data Byte	Description (all values are in hexadecimal)	Byte Value	Mnemonic
#1	Request control of on-board device request SID	0x08	SIDRQ
#2	Test ID: 01 - Evaporative system leak test	0x01	TID

Table 182 — Request control of on-board device response message

Message Direction:		ECU#1 → External test equipment	
Message Type:		Response	
Data Byte	Description (all values are in hexadecimal)	Byte Value	Mnemonic
#1	Request control of on-board device response SID	0x48	SIDPR
#2	Test ID: 0x01 - Evaporative system leak test	0x01	TID

In Table 184, the conditions of the system are not acceptable to run the evaporative system leak test. Therefore, the ECM (ECU#1) responds with a negative response message with response code 0x22 - conditionsNotCorrect. The TCM (ECU#2) does not respond because it previously reported that it does not support the evaporative system leak test.

Table 183 — Request control of on-board device request message

Message Direction:		External test equipment → All ECUs	
Message Type:		Request	
Data Byte	Description (all values are in hexadecimal)	Byte Value	Mnemonic
#1	Request control of on-board device request SID	0x08	SIDRQ
#2	Test ID: 0x01 - Evaporative system leak test	0x01	TID

Table 184 — Negative response message

Message Direction:		ECU#1 → External test equipment	
Message Type:		Response	
Data Byte	Description (all values are in hexadecimal)	Byte Value	Mnemonic
#1	Negative Response Service Identifier	0x7F	SIDNR
#2	Request control of on-board device request SID	0x08	SIDRQ
#3	Negative Response Code: conditionsNotCorrect	0x22	NR_CNC

8.9 Service 0x09 — Request vehicle information

8.9.1 Functional description

The purpose of this service is to enable the external test equipment to request vehicle-specific vehicle information such as Vehicle Identification Number (VIN) and Calibration IDs. Some of this information may be required by regulations and some should be reported in a standard format if supported by the vehicle manufacturer. INFOTYPES are defined in SAE J1979-DA.

Not all INFOTYPES are applicable or supported by all systems. INFOTYPE 0x00 is a bit-encoded value that indicates for each ECU which INFOTYPES are supported. INFOTYPE 0x00 indicates support for INFOTYPES from 0x01 to 0x20. INFOTYPE 0x20 indicates support for INFOTYPES 0x21 through 0x40, etc. This is the same concept for PIDs/TIDs/INFOTYPES support in Services 0x01, 0x02, 0x06, 0x08, 0x09. INFOTYPE 0x00 is required for those ECUs that respond to a corresponding Service 0x09 request message as specified in SAE J1979-DA.

The request message including supported INFOTYPES may contain up to six (6) INFOTYPES. A request message including an INFOTYPE, which reports vehicle information shall only contain one (1) INFOTYPE. External test equipment shall not request a combination of INFOTYPES supported and a single INFOTYPE, which reports vehicle information. The ECU shall support requests for up to six (6) supported INFOTYPES and only one (1) Info Type which reports vehicle information.

If INFOTYPE 0x02 (VIN) is indicated as supported, the ECU shall respond within $P2_{max}$ timing even if the VIN is missing or incomplete. For example, a development ECU may respond with 0xFF characters for VIN because the VIN has not been programmed.

8.9.2 Message data bytes

8.9.2.1 Request vehicle information request message definition (request supported INFOTYPE)

Table 185 — Request vehicle information request message (request supported INFOTYPE)

Data Byte	Parameter Name	Cvt	Hex Value	Mnemonic
#1	Request vehicle information request SID	M	0x09	SIDRQ
#2	INFOTYPE#1 (INFOTYPEs supported: SAE J1979-DA)	M	xx	INFOTYP
#3	INFOTYPE#2 (INFOTYPEs supported: SAE J1979-DA)	U ^a	xx	INFOTYP
#4	INFOTYPE#3 (INFOTYPEs supported: SAE J1979-DA)	U	xx	INFOTYP
#5	INFOTYPE#4 (INFOTYPEs supported: SAE J1979-DA)	U	xx	INFOTYP
#6	INFOTYPE#5 (INFOTYPEs supported: SAE J1979-DA)	U	xx	INFOTYP
#7	INFOTYPE#6 (INFOTYPEs supported: SAE J1979-DA)	U	xx	INFOTYP

^a U = User Optional. INFOTYPE may be included to avoid multiple INFOTYPE supported request messages.

To request INFOTYPEs supported range from 0xC1 to 0xFF, another request message with INFOTYPE#1 = 0xC0 and INFOTYPE#2 = 0xE0 shall be sent to the vehicle.

8.9.2.2 Request vehicle information response message definition (report supported INFOTYPE)

ECU(s) shall respond to all supported ranges if requested. A range is defined as a block of 32 INFOTYPEs (e.g. range #1: INFOTYPE 0x01 to 0x20). The ECU shall not respond to unsupported INFOTYPE ranges unless subsequent ranges have a supported INFOTYPE(s).

Table 186 — Request vehicle information response message (report supported INFOTYPE)

Data Byte	Parameter Name	Cvt	Hex Value	Mnemonic
#1	Request vehicle information response SID	M	0x49	SIDPR
#2	data record of supported INFOTYPEs = [1 st supported INFOTYPE Data A: supported INFOTYPEs, Data B: supported INFOTYPEs, Data C: supported INFOTYPEs, D: supported INFOTYPEs]	M	xx	INFOTYPREC
#3		M	xx	INFOTYP
#4		M	xx	DATA_A
#5		M	xx	DATA_B
#6		M	xx	DATA_C
:	:	:	:	:
#n-4	data record of supported INFOTYPEs = [m th supported INFOTYPE Data A: supported INFOTYPEs, Data B: supported INFOTYPEs, Data C: supported INFOTYPEs, Data D: supported INFOTYPEs]	C1 ^a	xx	INFOTYPREC
#n-3		C2 ^b	xx	INFOTYP
#n-2		C2	xx	DATA_A
#n-1		C2	xx	DATA_B
#n		C2	xx	DATA_C

^a C1 = Conditional. INFOTYPE value shall be the same value as included in the request message if supported by the ECU.

^b C2 = Conditional. Value indicates INFOTYPEs supported; range of supported INFOTYPEs depends on selected INFOTYPE value (see C1).

The response message shall only include the INFOTYPEs and Data A to D which are supported by the ECU. If the request message includes an INFOTYPE value(s), which are not supported by the ECU, those shall not be included in the response message.

8.9.2.3 Request vehicle information request message definition (read INFOTYPE values)

Table 187 — Request vehicle information request message (read INFOTYPE values)

Data Byte	Parameter Name	Cvt	Hex Value	Mnemonic
#1	Request vehicle information request SID	M	0x09	SIDRQ
#2	INFOTYPE (read INFOTYPE values)	M	xx	INFOTYP

8.9.2.4 Request vehicle information response message definition (report INFOTYPE values)

Table 188 — Request vehicle information response message (report INFOTYPE values)

Data Byte	Parameter Name	Cvt	Hex Value	Mnemonic
#1	Request vehicle information response SID	M	0x49	SIDPR
#2	data record of INFOTYPE = [M/C1 ^a	xx	INFOTYPREC
#3	INFOTYPE (report INFOTYPE values)	M	xx	INFOTYP
#4	NOofDataItems	M	xx	NODI
#5	data #1,	M	xx	DATA_#1
#6	data #2,	C2 ^b	xx	DATA_#2
:	:	C2	xx	:
#m	data #m]	C2	xx	DATA_#m

^a C1 = Conditional. INFOTYPE value shall be the same value as included in the request message.
^b C2 = Conditional. Data #1 - #m depend on selected INFOTYPE value.

8.9.3 Parameter definition

8.9.3.1 Vehicle information types supported

Refer to SAE J1979-DA.

8.9.3.2 Vehicle information type description

Refer to SAE J1979-DA.

8.9.3.3 Number of data items data byte description

This parameter defines the number of data items included in the response message which are identified and belong to the INFOTYPE reported.

EXAMPLE A request message with the INFOTYPE for CVN may cause the ECU to send a response message that contains multiple CVNs. The number of CVNs is included in the “number of data items” parameter.

8.9.4 Message example

The tables below show how the “request vehicle information” service shall be implemented.

8.9.4.1 Step #1: Request vehicle information (request supported INFOTYPE) from vehicle

The external test equipment requests all supported INFOTYPES (INFOTYPE#1 = 0x00) from the vehicle. ECU#1 (ECM) and ECU#2 (TCM) send a response message with INFOTYPES supported information for INFOTYPES 0x01 - 0x20.

Now the external test equipment creates an internal list of supported INFOTYPES for each ECU. ECU#1 (ECM) supports the following INFOTYPES: 0x02, 0x04, 0x06, 0x08 and 0x0A. ECU#2 (TCM) supports INFOTYPES 0x04 and 0x06.

8.9.4.2 Step #2: Request INFOTYPES from vehicle

Now the external test equipment requests the following INFOTYPES:

- INFOTYPE 0x02: VIN = [1G1JC5444R7252367] supported by ECU#1;
- INFOTYPE 0x04: Cal. ID#1 = [JMB*36761500] supported by ECU#1;
- INFOTYPE 0x04: Cal. ID#2 = [JMB*4787261111] supported by ECU#1;
- INFOTYPE 0x06: Cal. CVN#1 = [1791BC82] supported by ECU#1;
- INFOTYPE 0x06: Cal. CVN#2 = [16E062BE] supported by ECU#1;
- INFOTYPE 0x08: IPT = [04000D09 ... 02BF031B] supported by ECU#1 (spark ignition);
- INFOTYPE 0x0A: ECU Name = [ECU – Engine Control] supported by ECU#1; and
- INFOTYPE 0x04: Cal. ID [JMA*431299110000] supported by ECU#2; and
- INFOTYPE 0x06: Cal. CVN = [98123476] supported by ECU#2.

NOTE A compression ignition engine will support INFOTYPE 0x0B instead of 0x08 for In-use Performance Tracking (IPT) data.

Table 189 — Request vehicle information request message

Message Direction:		External test equipment → All ECUs	
Message Type:		Request	
Data Byte	Description (all values are in hexadecimal)	Byte Value	Mnemonic
#1	Request vehicle information request SID	0x09	SIDRQ
#2	INFOTYPE: 0x02 - VIN (Vehicle Identification Number)	0x02	INFTYP

Table 190 — Request vehicle information response message

Message Direction:		ECU#1 → External test equipment	
Message Type:		Response	
Data Byte	Description (all values are in hexadecimal)	Byte Value	Mnemonic
#1	Request vehicle information response SID	0x49	SIDPR
#2	INFOTYPE: 0x02 - VIN (Vehicle Information Number)	0x02	INFOTYP
#3	Number of data items: 0x01	0x01	NODI
#4	1 st ASCII character of VIN: '1'	0x31	VIN
#5	2 nd ASCII character of VIN: 'G'	0x47	VIN
#6	3 rd ASCII character of VIN: '1'	0x31	VIN
#7	4 th ASCII character of VIN: 'J'	0x4A	VIN
#8	5 th ASCII character of VIN: 'C'	0x43	VIN
#9	6 th ASCII character of VIN: '5'	0x35	VIN
#10	7 th ASCII character of VIN: '4'	0x34	VIN
#11	8 th ASCII character of VIN: '4'	0x34	VIN
#12	9 th ASCII character of VIN: '4'	0x34	VIN
#13	10 th ASCII character of VIN: 'R'	0x52	VIN
#14	11 th ASCII character of VIN: '7'	0x37	VIN
#15	12 th ASCII character of VIN: '2'	0x32	VIN
#16	13 th ASCII character of VIN: '5'	0x35	VIN
#17	14 th ASCII character of VIN: '2'	0x32	VIN
#18	15 th ASCII character of VIN: '3'	0x33	VIN
#19	16 th ASCII character of VIN: '6'	0x36	VIN
#20	17 th ASCII character of VIN: '7'	0x37	VIN

Now the external test equipment requests the following INFOTYPE:

- INFOTYPE 0x04: CALID#1 = [JMB*36761500] and CALID#2 =[JMB*4787261111]; supported by ECU#1.
- INFOTYPE 0x04: CALID#1 = [JMA*431299110000]; supported by ECU#2.

Table 191 — Request vehicle information request message

Message Direction:		External test equipment → All ECUs	
Message Type:		Request	
Data Byte	Description (all values are in hexadecimal)	Byte Value	Mnemonic
#1	Request vehicle information request SID	0x09	SIDRQ
#2	INFOTYPE: Calibration ID	0x04	INFOTYP

Table 192 — Request vehicle information response message

Message Direction:		ECU#1 → External test equipment	
Message Type:		Response	
Data Byte	Description (all values are in hexadecimal)	Byte Value	Mnemonic
#1	Request vehicle information response SID	0x49	SIDPR
#2	INFOTYPE: Calibration ID	0x04	INFTYP
#3	Number of data items: 02	0x02	NODI
#4	Data A: 'J'	0x4A	DATA_A
#5	Data B: 'M'	0x4D	DATA_B
#6	Data C: 'B'	0x42	DATA_C
#7	Data D: '*'	0x2A	DATA_D
#8	Data E: '3'	0x33	DATA_E
#9	Data F: '6'	0x36	DATA_F
#10	Data G: '7'	0x37	DATA_G
#11	Data H: '6'	0x36	DATA_H
#12	Data I: '1'	0x31	DATA_I
#13	Data J: '5'	0x35	DATA_J
#14	Data K: '0'	0x30	DATA_K
#15	Data L: '0'	0x30	DATA_L
#16	Data M: Fill byte	0x00	DATA_M
#17	Data N: Fill byte	0x00	DATA_N
#18	Data O: Fill byte	0x00	DATA_O
#19	Data P: Fill byte	0x00	DATA_P
#20	Data A: 'J'	0x4A	DATA_A
#21	Data B: 'M'	0x4D	DATA_B
#22	Data C: 'B'	0x42	DATA_C
#23	Data D: '*'	0x2A	DATA_D
#24	Data E: '4'	0x34	DATA_E
#25	Data F: '7'	0x37	DATA_F
#26	Data G: '8'	0x38	DATA_G
#27	Data H: '7'	0x37	DATA_H
#28	Data I: '2'	0x32	DATA_I
#29	Data J: '6'	0x36	DATA_J
#30	Data K: '1'	0x31	DATA_K
#31	Data L: '1'	0x31	DATA_L
#32	Data M: '1'	0x31	DATA_M
#33	Data N: '1'	0x31	DATA_N
#34	Data O: Fill byte	0x00	DATA_O
#35	Data P: Fill byte	0x00	DATA_P

Table 193 — Request vehicle information response message

Message Direction:		ECU#2 → External test equipment	
Message Type:		Response	
Data Byte	Description (all values are in hexadecimal)	Byte Value	Mnemonic
#1	Request vehicle information response SID	0x49	SIDPR
#2	INFOTYPE: Calibration ID	0x04	INFOTYP
#3	Number of data items: 01	0x01	NODI
#4	Data A: 'J'	0x4A	DATA_A
#5	Data B: 'M'	0x4D	DATA_B
#6	Data C: 'A'	0x41	DATA_C
#7	Data D: '*'	0x2A	DATA_D
#8	Data E: '4'	0x34	DATA_E
#9	Data F: '3'	0x33	DATA_F
#10	Data G: '1'	0x31	DATA_G
#11	Data H: '2'	0x32	DATA_H
#12	Data I: '9'	0x39	DATA_I
#13	Data J: '9'	0x39	DATA_J
#14	Data K: '1'	0x31	DATA_K
#15	Data L: '1'	0x31	DATA_L
#16	Data M: '0'	0x30	DATA_M
#17	Data N: '0'	0x30	DATA_N
#18	Data O: '0'	0x30	DATA_O
#19	Data P: '0'	0x30	DATA_P

NOTE The same response message with different data byte content will be sent by ECU#2 in this example.

In the following example, the ECUs need more time than $P2_{CAN}$ to calculate the CVN(s). Therefore, both ECUs respond with negative response messages with response code 0x78 - RequestCorrectlyReceived-ResponsePending as long as the positive response message is not ready in the ECU.

Now the external test equipment requests the following INFOTYPE:

— INFOTYPE 0x06: CVN#1 = [0x17 0x91 0xBC 0x82] and CVN#2 = [0x16 0xE0 0x62 0xBE];
supported by ECU#1;

and

— INFOTYPE 0x06: CVN = [0x98 0x12 0x34 0x76];
supported by ECU#2.

Table 194 — Request vehicle information request message

Message Direction:		External test equipment → All ECUs	
Message Type:		Request	
Data Byte	Description (all values are in hexadecimal)	Byte Value	Mnemonic
#1	Request vehicle information request SID	0x09	SIDRQ
#2	INFOTYPE: Calibration Verification Number	0x06	INFTYP

Table 195 — Negative response message

Message Direction:		ECU#1 → External test equipment	
Message Type:		Response	
Data Byte	Description (all values are in hexadecimal)	Byte Value	Mnemonic
#1	Negative Response Service Identifier	0x7F	SIDNR
#2	Request vehicle information request SID	0x09	SIDRQ
#3	Negative Response Code: RequestCorrectlyReceived-ResponsePending	0x78	NR_RCR_RP

Table 196 — Negative response message

Message Direction:		ECU#2 → External test equipment	
Message Type:		Response	
Data Byte	Description (all values are in hexadecimal)	Byte Value	Mnemonic
#1	Negative Response Service Identifier	0x7F	SIDNR
#2	Request vehicle information request SID	0x09	SIDRQ
#3	Negative Response Code: RequestCorrectlyReceived-ResponsePending	0x78	NR_RCR_RP

Table 197 — Request vehicle information response message (1st)

Message Direction:		ECU#1 → External test equipment	
Message Type:		Response	
Data Byte	Description (all values are in hexadecimal)	Byte Value	Mnemonic
#1	Request vehicle information response SID	0x49	SIDPR
#2	INFOTYPE: Calibration Verification Number	0x06	INFTYP
#3	Number of data items: 0x02	0x02	NODI
#4	Data A: 0x17	0x17	DATA_A
#5	Data B: 0x91	0x91	DATA_B
#6	Data C: 0xBC	0xBC	DATA_C
#7	Data D: 0x82	0x82	DATA_D
#8	Data E: 0x16	0x16	DATA_E
#9	Data F: 0xE0	0xE0	DATA_F
#10	Data G: 0x62	0x62	DATA_G
#11	Data H: 0xBE	0xBE	DATA_H

Table 198 — Request vehicle information response message (1st)

Message Direction:		ECU#2 → External test equipment	
Message Type:		Response	
Data Byte	Description (all values are in hexadecimal)	Byte Value	Mnemonic
#1	Request vehicle information response SID	0x49	SIDPR
#2	INFOTYPE: Calibration Verification Number	0x06	INFOTYP
#3	Number of data items: 0x01	0x01	NODI
#4	Data A: 0x98	0x98	DATA_A
#5	Data B: 0x12	0x12	DATA_B
#6	Data C: 0x34	0x34	DATA_C
#7	Data D: 0x76	0x76	DATA_D

Now, for a spark ignition engine, the external test equipment requests the following INFOTYPE:

— INFOTYPE 0x08: IPT; supported by ECU#1.

Table 199 — Request vehicle information request message

Message Direction:		External test equipment → All ECUs	
Message Type:		Request	
Data Byte	Description (all values are in hexadecimal)	Byte Value	Mnemonic
#1	Request vehicle information request SID	0x09	SIDRQ
#2	INFOTYPE: In-use Performance Tracking	0x08	INFOTYP

Table 200 — Request vehicle information response message (1)

Message Direction:		ECU#1 → External test equipment	
Message Type:		Response	
Data Byte	Description (all values are in hexadecimal)	Byte Value	Mnemonic
#1	Request vehicle information response SID	0x49	SIDPR
#2	INFOTYPE: In-use Performance Tracking	0x08	INFOTYP
#3	Number of data items: 20 _{dec} (some vehicles will report 16 _{dec} items)	0x14	NODI
#4	OBDCOND_A: 1024 counts	0x04	OBDCOND_A
#5	OBDCOND_B: 1024 counts	0x00	OBDCOND_B
#6	IGNCNTR_A: 3337 counts	0x0D	IGNCNTR_A
#7	IGNCNTR_B: 3337 counts	0x09	IGNCNTR_B
#8	CATCOMP1_A: 824 counts	0x03	CATCOMP1_A
#9	CATCOMP1_B: 824 counts	0x38	CATCOMP1_B
#10	CATCOND1_A: 945 counts	0x03	CATCOND1_A
#11	CATCOND1_B: 945 counts	0xB1	CATCOND1_B
#12	CATCOMP2_A: 711 counts	0x02	CATCOMP2_A
#13	CATCOMP2_B: 711 counts	0xC7	CATCOMP2_B
#14	CATCOND2_A: 945 counts	0x03	CATCOND2_A
#15	CATCOND2_B: 945 counts	0xB1	CATCOND2_B

Table 200 (continued)

Message Direction:		ECU#1 → External test equipment	
Message Type:		Response	
Data Byte	Description (all values are in hexadecimal)	Byte Value	Mnemonic
#16	O2SCOMP1_A: 737 counts	0x02	O2SCOMP1_A
#17	O2SCOMP1_B: 737 counts	0xE1	O2SCOMP1_B
#18	O2SCOND1_A: 924 counts	0x03	O2SCOND1_A
#19	O2SCOND1_B: 924 counts	0x9C	O2SCOND1_B
#20	O2SCOMP2_A: 724 counts	0x02	O2SCOMP2_A
#21	O2SCOMP2_B: 724 counts	0xD4	O2SCOMP2_B
#22	O2SCOND2_A: 833 counts	0x03	O2SCOND2_A
#23	O2SCOND2_B: 833 counts	0x41	O2SCOND2_B
#24	EGRCOMP_A: 997 counts	0x03	EGRCOMP_A
#25	EGRCOMP_B: 997 counts	0xE5	EGRCOMP_B
#26	EGRCOND_A: 1010 counts	0x03	EGRCOND_A
#27	EGRCOND_B: 1010 counts	0xF2	EGRCOND_B
#28	AIRCOMP_A: 937 counts	0x03	AIRCOMP_A
#29	AIRCOMP_B: 937 counts	0xA9	AIRCOMP_B
#30	AIRCOND_A: 973 counts	0x03	AIRCOND_A
#31	AIRCOND_B: 973 counts	0xCD	AIRCOND_B
#32	EVAPCOMP_A: 68 counts	0x00	EVAPCOMP_A
#33	EVAPCOMP_B: 68 counts	0x44	EVAPCOMP_B
#34	EVAPCOND_A: 97 counts	0x00	EVAPCOND_A
#35	EVAPCOND_B: 97 counts	0x61	EVAPCOND_B
#36	SO2SCOMP1_A: 677 counts	0x02	SO2SCOMP1_A
#37	SO2SCOMP1_B: 677 counts	0xA5	SO2SCOMP1_B
#38	SO2SCOND1_A: 824 counts	0x03	SO2SCOND1_A
#39	SO2SCOND1_B: 824 counts	0x38	SO2SCOND1_B
#40	SO2SCOMP2_A: 703 counts	0x02	SO2SCOMP2_A
#41	SO2SCOMP2_B: 703 counts	0xBF	SO2SCOMP2_B
#42	SO2SCOND2_A: 795 counts	0x03	SO2SCOND2_A
#43	SO2SCOND2_B: 795 counts	0x1B	SO2SCOND2_B

Now the external test equipment requests the following INFOTYPE:

- INFOTYPE 0x0A: ECUNAME; supported by ECU#1; The name of the ECU is: "ECM-EngineControl".

Table 201 — Request vehicle information request message

Message Direction:		External test equipment → All ECUs	
Message Type:		Request	
Data Byte	Description (all values are in hexadecimal)	Byte Value	Mnemonic
#1	Request vehicle information request SID	0x09	SIDRQ
#2	INFOTYPE: ECU's/module's acronym and text name	0x0A	INFOTYP

Table 202 — Request vehicle information response message (1)

Message Direction:		ECU#1 → External test equipment	
Message Type:		Response	
Data Byte	Description (all values are in hexadecimal)	Byte Value	Mnemonic
#1	Request vehicle information response SID	0x49	SIDPR
#2	INFOTYPE: ECU's/module's acronym and text name	0x0A	INFOTYP
#3	Number of data items: 01 _{dec}	0x01	NODI
#4	Data A: 'E'	0x45	ECUNAME_A
#5	Data B: 'C'	0x43	ECUNAME_B
#6	Data C: 'M'	0x4D	ECUNAME_C
#7	Data D: '1' (or filler byte, 0x00, if single ECM in the vehicle)	0x31	ECUNAME_D
#8	Data E: '-' delimiter	0x2D	ECUNAME_E
#9	Data F: 'E'	0x45	ECUNAME_F
#10	Data G: 'n'	0x6E	ECUNAME_G
#11	Data H: 'g'	0x67	ECUNAME_H
#12	Data I: 'i'	0x69	ECUNAME_I
#13	Data J: 'n'	0x6E	ECUNAME_J
#14	Data K: 'e'	0x65	ECUNAME_K
#15	Data L: 'C'	0x43	ECUNAME_L
#16	Data M: 'o'	0x6F	ECUNAME_M
#17	Data N: 'n'	0x6E	ECUNAME_N
#18	Data O: 't'	0x74	ECUNAME_O
#19	Data P: 'r'	0x72	ECUNAME_P
#20	Data Q: 'o'	0x6F	ECUNAME_Q
#21	Data R: 'l'	0x6C	ECUNAME_R
#22	Data S: filler byte	0x00	ECUNAME_S
#23	Data T: filler byte	0x00	ECUNAME_T

The external test equipment requests the following INFOTYPE for a compression ignition engine:

- INFOTYPE 0x0B: IPT for compression ignition engines; supported by ECU#1.

Table 203 — Request vehicle information request message

Message Direction:		External test equipment → All ECUs	
Message Type:		Request	
Data Byte	Description (all values are in hexadecimal)	Byte Value	Mnemonic
#1	Request vehicle information request SID	0x09	SIDRQ
#2	INFOTYPE: In-use Performance Tracking	0x0B	INFOTYP

Table 204 — Request vehicle information response message

Message Direction:		ECU#1 → External test equipment	
Message Type:		Response	
Data Byte	Description (all values are in hexadecimal)	Byte Value	Mnemonic
#1	Request vehicle information response SID	0x49	SIDPR
#2	INFOTYPE: In-use Performance Tracking	0x0B	INFOTYP
#3	Number of data items: 16 _{dec} (some vehicles will report 18 _{dec} items)	0x10	NODI
#4	OBDCOND_A: 1024 counts	04	OBDCOND_A
#5	OBDCOND_B: 1024 counts	00	OBDCOND_B
#6	IGNCNTR_A: 3337 counts	0D	IGNCNTR_A
#7	IGNCNTR_B: 3337 counts	09	IGNCNTR_B
#8	HCCATCOMP_A: 824 counts	03	HCCATCOMP_A
#9	HCCATCOMP_B: 824 counts	38	HCCATCOMP_B
#10	HCCATCOND_A: 945 counts	03	HCCATCOND_A
#11	HCCATCOND_B: 945 counts	B1	HCCATCOND_B
#12	NCATCOMP_A: 711 counts	02	NCATCOMP_A
#13	NCATCOMP_B: 711 counts	C7	NCATCOMP_B
#14	NCATCOND_A: 945 counts	03	NCATCOND_A
#15	NCATCOND_B: 945 counts	B1	NCATCOND_B
#16	NADSCOMP_A: 737 counts	02	NADSCOMP_A
#17	NADSCOMP_B: 737 counts	E1	NADSCOMP_B
#18	NADSCOND_A: 924 counts	03	NADSCOND_A
#19	NADSCOND_B: 924 counts	9C	NADSCOND_B
#20	PMCOMP_A: 724 counts	02	PMCOMP_A
#21	PMCOMP_B: 724 counts	D4	PMCOMP_B
#22	PMCOND_A: 833 counts	03	PMCOND_A
#23	PMCOND_B: 833 counts	41	PMCOND_B
#24	EGSCOMP_A: 997 counts	03	EGSCOMP_A
#25	EGSCOMP_B: 997 counts	E5	EGSCOMP_B
#26	EGSCOND_A: 1010 counts	03	EGSCOND_A
#27	EGSCOND_B: 1010 counts	F2	EGSCOND_B
#28	EGRCOMP_A: 937 counts	03	EGRCOMP_A
#29	EGRCOMP_B: 937 counts	A9	EGRCOMP_B
#30	EGRCOND_A: 973 counts	03	EGRCOND_A
#31	EGRCOND_B: 973 counts	CD	EGRCOND_B
#32	BPCOMP_A: 68 counts	00	BPCOMP_A
#33	BPCOMP_B: 68 counts	44	BPCOMP_B
#34	BPCOND_A: 97 counts	00	BPCOND_A
#35	BPCOND_B: 97 counts	61	BPCOND_B

8.10 Service 0x0A — Request emission-related diagnostic trouble codes with permanent status

8.10.1 Functional description

The purpose of this service is to enable the external test equipment to obtain all DTCs with “permanent DTC status”. These are DTCs that are “confirmed” and are retained in the non-volatile memory of the server until the appropriate monitor for each DTC has determined that the malfunction is no longer present and is not commanding the MIL on.

Service 0x0A is required for all emissions-related DTCs. The intended use of this data is to prevent vehicles from passing an in-use inspection simply by disconnecting the battery or clearing DTCs with a scan tool prior to the inspection. The presence of permanent DTCs at an inspection without the MIL illuminated is an indication that a proper repair was not verified by the on-board monitoring system.

Permanent DTCs shall be stored in non-volatile memory (NVRAM) and may not be erased by any diagnostic services (generic or enhanced) or by disconnecting power to the ECU.

A confirmed DTC shall be stored as a permanent DTC no later than the end of the ignition cycle and subsequently at all times that the confirmed DTC is commanding the MIL on (e.g. for currently failing systems but not during the 40 warm-up cycle self-healing process).

Permanent DTCs may be erased if:

- The OBD system itself determines that the malfunction that caused the permanent fault code to be stored is no longer present and is not commanding the MIL on, e.g. three consecutive complete driving cycles with no malfunction, or as specified by the OBD regulations.
- After clearing fault information in the ECU (i.e. through the use of a diagnostic service or battery disconnect):
 - For monitors subject to minimum in-use ratio requirement, the diagnostic monitor for the malfunction that caused the permanent DTC to be stored has fully executed (i.e. has executed the minimum number of checks necessary for MIL illumination) and determined the malfunction is no longer present, e.g. one complete driving cycle with no malfunction or as specified by the OBD regulations.
 - For monitors not subject to minimum in-use ratio requirement, the diagnostic monitor for the malfunction that caused the permanent DTC to be stored has fully executed (i.e. has executed the minimum number of checks necessary for MIL illumination) and determined the malfunction is no longer present, e.g. one complete driving cycle with no malfunction or as specified by the OBD regulations and the vehicle has completed a standard driving cycle used to increment the in-use general denominator.
- Permanent fault codes may be erased when the ECU containing the permanent DTCs is reprogrammed if the readiness status for all monitored components and systems is set to “not complete” in conjunction with the reprogramming event.

NOTE Due to implementation timing differences during the phase-in of permanent DTCs, there may be cases where some ECUs support permanent DTCs while other ECUs do not within the same vehicle.

8.10.2 Message data bytes

8.10.2.1 Request emission-related diagnostic trouble codes with permanent status request message

Table 205 — Request emission-related diagnostic trouble codes with permanent status request message

Data Byte	Parameter Name	Cvt	Hex Value	Mnemonic
#1	Request emission-related diagnostic trouble codes with permanent status request SID	M	0x0A	SIDRQ

8.10.2.2 Request emission-related diagnostic trouble codes with permanent status response message definition

Table 206 — Request emission-related diagnostic trouble codes with permanent status response message

Data Byte	Parameter Name	Cvt	Hex Value	Mnemonic
#1	Request emission-related diagnostic trouble codes with permanent status response SID	M	0x4A	SIDPR
#2	# of DTC = [no emission-related DTCs with permanent status # of emission-related DTCs with permanent status]	M	0x00 0x01 – 0xFF	#OFDTC
#3 #4	DTC#1 (High Byte) DTC#1 (Low Byte)	C ^a C	xx xx	DTC1HI DTC1LO
:	:	:	xx	
#n-1 #n	DTC#m (High Byte) DTC#m (Low Byte)	C C	xx xx	DTCmHI DTCmLO

^a C = Conditional. DTC#1 - DTC#m are only included if # of DTC parameter value ≠ 0x00.

8.10.3 Parameter definition

The # of DTC parameter reports the emission-related DTC(s) currently (at the time of the request message processing) stored in the ECU(s).

8.10.4 Message example

Refer to message example of Service 0x03.

Bibliography

- [1] ISO 11898-1, *Road vehicles — Controller area network (CAN) — Part 1: Data link layer and physical signalling*
- [2] ISO 11898-2, *Road vehicles — Controller area network (CAN) — Part 2: High-speed medium access unit*
- [3] ISO 14230-1, *Road vehicles — Diagnostic systems — Keyword Protocol 2000 — Part 1: Physical layer*
- [4] ISO 15031-3, *Road vehicles — Communication between vehicle and external equipment for emissions-related diagnostics — Part 3: Diagnostic connector and related electrical circuits, specification and use*
- [5] SAE J1850, *Class B data communications network interface*
- [6] SAE J1978, *OBD II scan tool*

