

First edition
2004-09-15

Welding — Comparison of standardised methods for the avoidance of cold cracks

*Soudage — Comparaison de méthodes normalisées pour éviter les
fissures à froid*



Reference number
ISO/TR 17844:2004(E)

© ISO 2004

PDF disclaimer

This PDF file may contain embedded typefaces. In accordance with Adobe's licensing policy, this file may be printed or viewed but shall not be edited unless the typefaces which are embedded are licensed to and installed on the computer performing the editing. In downloading this file, parties accept therein the responsibility of not infringing Adobe's licensing policy. The ISO Central Secretariat accepts no liability in this area.

Adobe is a trademark of Adobe Systems Incorporated.

Details of the software products used to create this PDF file can be found in the General Info relative to the file; the PDF-creation parameters were optimized for printing. Every care has been taken to ensure that the file is suitable for use by ISO member bodies. In the unlikely event that a problem relating to it is found, please inform the Central Secretariat at the address given below.

© ISO 2004

All rights reserved. Unless otherwise specified, no part of this publication may be reproduced or utilized in any form or by any means, electronic or mechanical, including photocopying and microfilm, without permission in writing from either ISO at the address below or ISO's member body in the country of the requester.

ISO copyright office
Case postale 56 • CH-1211 Geneva 20
Tel. + 41 22 749 01 11
Fax + 41 22 749 09 47
E-mail copyright@iso.org
Web www.iso.org

Published in Switzerland

Foreword

ISO (the International Organization for Standardization) is a worldwide federation of national standards bodies (ISO member bodies). The work of preparing International Standards is normally carried out through ISO technical committees. Each member body interested in a subject for which a technical committee has been established has the right to be represented on that committee. International organizations, governmental and non-governmental, in liaison with ISO, also take part in the work. ISO collaborates closely with the International Electrotechnical Commission (IEC) on all matters of electrotechnical standardization.

International Standards are drafted in accordance with the rules given in the ISO/IEC Directives, Part 2.

The main task of technical committees is to prepare International Standards. Draft International Standards adopted by the technical committees are circulated to the member bodies for voting. Publication as an International Standard requires approval by at least 75 % of the member bodies casting a vote.

In exceptional circumstances, when a technical committee has collected data of a different kind from that which is normally published as an International Standard ("state of the art", for example), it may decide by a simple majority vote of its participating members to publish a Technical Report. A Technical Report is entirely informative in nature and does not have to be reviewed until the data it provides are considered to be no longer valid or useful.

Attention is drawn to the possibility that some of the elements of this document may be the subject of patent rights. ISO shall not be held responsible for identifying any or all such patent rights.

ISO/TR 17844 was prepared by the European Committee for Standardization (CEN) in collaboration with Technical Committee ISO/TC 44, *Welding and allied processes*, Subcommittee SC 10, *Unification of requirements in the field of metal welding*, in accordance with the Agreement on technical cooperation between ISO and CEN (Vienna Agreement).

Throughout the text of this document, read "...this CEN Report..." to mean "...this Technical Report...".

Contents

Page

Foreword.....	vi
Introduction	vii
1 Scope	1
2 CE-method	1
2.1 Cracking test method	1
2.2 Parent metal composition range	1
2.3 Plate thickness and joint geometry	2
2.4 Hydrogen level and welding process	2
2.4.1 Hydrogen scales	2
2.4.2 Selection of hydrogen scales	2
2.5 Heat input	3
2.6 Special considerations.....	7
2.6.1 Conditions which might require more stringent procedures.....	7
2.6.2 Relaxations.....	8
2.6.3 Simplified conditions for manual metal-arc welding	8
2.7 Determination of preheat	10
3 CET-method.....	18
3.1 Cracking test method	18
3.2 Parent metal composition range	19
3.3 Plate thickness.....	20
3.4 Hydrogen level and welding process	21
3.5 Heat input	21
3.6 Influence of residual stress	22
3.7 Determination of preheat	22
3.7.1 Calculation of the minimum preheat temperature.....	22
3.7.2 Example for determination : numerical determination of the preheat temperature	23
3.7.3 Example for determination : graphical determination of the preheat temperature	23
3.8 Special considerations.....	25
3.8.1 Reduction of hydrogen content by post heating (soaking)	25
3.8.2 Welding with reduced preheating	25
3.8.3 Welding with austenitic consumables.....	25
4 CE_N-method	25
4.1 Cracking test method	25
4.2 Parent metal composition range	26
4.3 Material thickness.....	27
4.4 Weld metal hydrogen content and welding process.....	27
4.5 Heat input	27
4.6 Weld metal yield strength	28
4.7 Determination of preheat	29
4.8 Special considerations.....	29
4.8.1 Weld metal hydrogen content	29
4.8.2 Number of the weld layers and weld metal strength.....	30
4.8.3 Restraint	30
4.8.4 Weld metal hydrogen cracking.....	30
5 P_{cm}-method	34
5.1 General.....	34
5.1.1 Cracking test method	34
5.1.2 HAZ hardness control method	34
5.1.3 Hydrogen controlled method.....	35
5.2 Parent metal composition range	35
5.2.1 Hardness controlled method.....	35
5.2.2 Hydrogen controlled method.....	35

5.2.3	Selection of method	35
5.2.4	Hydrogen controlled method	36
5.3	Plate thickness and joint geometry	36
5.3.1	HAZ hardness controlled method	36
5.3.2	Hydrogen controlled method	36
5.4	Hydrogen levels and welding process	37
5.4.1	HAZ hardness controlled method	37
5.4.2	Hydrogen controlled method	37
5.5	Energy input.....	37
5.6	Special considerations.....	38
5.7	Determination of minimum preheat	38
5.7.1	Method according to value of <i>CE</i>	38
5.7.2	HAZ hardness controlled method.....	38
5.7.3	Hydrogen content controlled method	39
Annex A	(informative) Comparison of the different methods	48
A.1	General.....	48
A.2	Parent metal composition range.....	48
A.3	Plate thickness and joint geometry	48
A.4	Hydrogen levels	49
A.5	Heat input	49
A.6	Prediction comparison.....	49
A.7	Summary and conclusions.....	50
Annex B	(informative) Abbreviations	71
Bibliography	72

Foreword

This document CEN ISO/TR 17844:2004 has been prepared by Technical Committee CEN/TC 121 “Welding”, the secretariat of which is held by DIN, in collaboration with Technical Committee ISO/TC 44 “Welding and allied processes”.

This document includes a Bibliography.

Introduction

The purpose of this document is to compare currently available methods for determining welding procedures for avoiding hydrogen induced cold cracking during fabrication.

This subject has been extensively studied in recent years and many methods of providing guidance on avoidance of cold cracking have been published. These methods vary considerably in how comprehensively the subject has to be treated. It was considered appropriate to set certain important working criteria for selecting the published methods to be included in this document. In deciding which criteria would be adopted it was agreed that these should include the capabilities for effective use by industry, the end user. Thus the methods should be able to be used on the basis of traditionally available information and relevant factors. The agreed list of criteria was set to include the following main input parameters

- steel composition;
- welding heat input;
- joint geometry and material thickness;
- weld hydrogen level;
- preheat

and in addition

- graphical/computer format of data.

Using the above criteria, the following methods were selected.

- CE (EN 1011-2/ISO/TR 17671-2, C.2-Method A);
- CET (EN 1011-2/ISO/TR 17671-2, C.3-Method B);
- CE_N (JIS B 8285);
- P_{cm} (ANSI/AWS D1.1).

Each method is considered in a separate clause, under the following headings.

- Description of type of test data used to devise the guidelines, e.g. CTS, y-groove, etc;
- Parent metal composition and range of applicability;
- Material thickness and range of applicability;
- Hydrogen level and welding processes;
- Heat input;
- Other factors/special considerations;
- Determination of preheat (step-by-step example description).

An informative Annex compares and contrasts the predictions of the methods in respect of ten different steels and a range of material thickness, joint geometry's, heat inputs and hydrogen levels.

It is important that any calculations using a given method are undertaken using the current edition of the appropriate standard.

.....

1 Scope

In addition to EN 1011-2/ISO/TR 17671-2, this document contains further methods for avoidance of cold cracking used by other members of ISO. This document gives guidance for manual, semi-mechanized, mechanized and automatic arc welding of ferritic steels, excluding ferritic stainless steels, in all product forms.

Further information about the materials and process parameters is given in Clauses 2 to 5.

NOTE 1 All references are listed in the annex "Bibliography".

NOTE 2 All used abbreviations in this document are explained in EN 1011-2/ISO/TR 17671-2 and Annex B.

2 CE-method

2.1 Cracking test method

This method is based on an original concept of critical hardness to avoid HAZ (heat affected zone) hydrogen cracking. It has been empirically developed incorporating the extensive results of HAZ hardenability studies and cracking tests, the latter mainly but not exclusively being the CTS test type. In its present general format the scheme was originally published in 1973 and, with modifications and updates, has been continuously incorporated in British Standards for nearly 25 years. The experience of its use, both in the UK and elsewhere, has been extremely satisfactory.

2.2 Parent metal composition range

The parent metals covered are carbon, carbon manganese, fine grained and low alloyed steels (groups 1 to 3 of CR ISO 15608:2000).

The steels that were used over many years to develop the method have covered a wide range of compositions and it is believed that they are adequately represented by Table 1.

Table 1 — Range of chemical composition of the main constituents for parent metal for CE-method

Element	Percentage by weight
Carbon	$\geq 0,05 \leq 0,25$
Silicon	$\leq 0,8$
Manganese	$\leq 1,7$
Chromium	$\leq 0,9$
Copper	$\leq 1,0$
Nickel	$\leq 2,5$
Molybdenum	$\leq 0,75$
Vanadium	$\leq 0,20$

Carbon equivalent values (in %) for parent metals are calculated using the following equation (1):

$$CE_{IIW} = C + \frac{Mn}{6} + \frac{Cr + Mo + V}{5} + \frac{Ni + Cu}{15} \quad (1)$$

and are applicable to steels with carbon equivalents in the range $CE = 0,30\%$ to $0,70\%$.

If of the elements in this formula only carbon and manganese are stated on the mill sheet for carbon and carbon manganese steels, then $0,03\%$ should be added to the calculated value to allow for residual elements and impurities. Where steels of different carbon equivalents or grades are to be joined, the higher carbon equivalent value should be used.

This carbon equivalent formula may not be suitable for boron containing steels.

2.3 Plate thickness and joint geometry

The influence of plate thickness and joint geometry is determined by calculating the combined thickness. This should be determined as the sum of the parent metal thickness averaged over a distance of 75 mm from the weld centre line (see Figure 1).

Combined thickness is used to assess the heat sink of a joint for the purpose of determining the cooling rate.

If the thickness increases greatly beyond 75 mm from the weld centre line, it may be necessary to use a higher combined thickness value.

Steels with thicknesses, t , in the range $6\text{ mm} \leq t \leq 100\text{ mm}$ were used in the tests to develop the scheme.

2.4 Hydrogen level and welding process

2.4.1 Hydrogen scales

The hydrogen scales to be used for any arc welding process depend principally on the weld diffusible hydrogen content (according to EN ISO 3690) and should be as given in Table 2.

Table 2 — Hydrogen scales

Diffusible hydrogen content (ml/100 g deposited material)	Hydrogen scale
> 15	A
10 ≤ 15	B
5 ≤ 10	C
3 ≤ 5	D
≤ 3	E

Data from a wide range of arc welding processes has been used in developing the scheme and these include manual metal arc (111), gas metal arc with solid wire (131, 135) and tubular wire (136, 137), the latter of both gas shielded and self shielded types, and submerged arc welding (121).

NOTE The numbers in brackets are process numbers according to EN ISO 4063.

2.4.2 Selection of hydrogen scales

The following is general guidance on the selection of the appropriate hydrogen scale for various welding processes.

Manual metal arc welding with basic covered electrodes can be used with the scale B to D depending on the electrode manufacturer's/supplier's classification of the consumable. Manual metal arc welding with rutile or cellulosic electrodes should be used with scale A.

Flux cored or metal cored consumables can be used with scales B to D depending on the manufacturer's/supplier's classification of the wire electrodes. Submerged arc welding with one wire electrode (121) and flux consumable combinations can have hydrogen levels appropriate to scales B to D, although most typically these will be scale C but therefore need assessing for each named product combination and condition. Submerged arc fluxes can be classified by the manufacture/supplier but this does not necessarily confirm that a practical flux wire combination also meets the same classification.

Solid wire electrodes for gas-shielded arc welding (131, 135) and for TIG welding (141) may be used with scale D unless specifically assessed and shown to meet scale E. Scale E may also be found to be appropriate for some cored wires (136, 137) and some manual metal arc covered electrodes, but only after specific assessment. In achieving these low levels of hydrogen consideration should be given to the contribution of hydrogen from the shielding gas composition and atmospheric humidity.

For plasma arc welding (15), specific assessment should be made.

NOTE The numbers in brackets are process numbers according to EN ISO 4063.

2.5 Heat input

Heat input values (in kJ/mm) for use with Figure 2 a) to m) should be calculated in accordance with EN 1011-1/ISO/TR 17671-1 and EN 1011-2/ISO/TR 17671-2.

For manual metal-arc welding, heat input values are expressed in Tables 3 to 6 in terms of electrode size and weld run lengths.

The details given in Tables 3 to 6 relate to electrodes having an original length of 450 mm. For other electrode lengths the following equation (2) may be used:

$$Run\ length(mm) = \frac{(Electrode\ diameter)^2 \times L \times F}{Heat\ input} \quad (2)$$

where

L is the consumed length of the electrode (in mm) (normally the original length of 450 mm less 40 mm for stub end);

F is a factor (in kJ/mm^3) having a value depending on the electrode efficiency, as follows:

efficiency approximately 95 % $F = 0,0368$

95 % < efficiency \leq 110 % $F = 0,0408$

110 % < efficiency \leq 130% $F = 0,0472$

efficiency > 130% $F = 0,0608$

Table 3 — Run length for manual metal-arc welding – 95 % electrode efficiency, approximately

Heat input kJ/mm	Run length from 410 mm of a 450 mm electrode of diameter					
	2,5 mm	3,2 mm	4,0 mm	5,0 mm	6,0 mm	6,3 mm
0,8	120	195	300	470		
1,0	95	155	240	375	545	600
1,2		130	200	315	450	500
1,4		110	170	270	390	430
1,6		95	150	235	340	375
1,8		85	135	210	300	335
2,0			120	190	270	300
2,2			110	170	245	270
2,5			95	150	215	240
3,0			80	125	180	200
3,5				110	155	170
4,0				95	135	150
4,5				85	120	135
5,0					110	120
5,5					100	110

Table 4 — Run length for manual metal-arc welding – 95% < electrode efficiency ≤ 110%

Heat input kJ/mm	Run length from 410 mm of a 450 mm electrode of diameter					
	2,5 mm	3,2 mm	4,0 mm	5,0 mm	6,0 mm	6,3 mm
0,8	130	215	325	525		
1,0	105	170	270	420	600	
1,2	85	145	225	350	500	555
1,4		120	190	300	430	475
1,6		105	165	260	375	415
1,8		95	150	230	335	370
2,0		85	135	210	300	330
2,2			120	190	275	300
2,5			105	165	240	265
3,0			90	140	200	220
3,5				120	170	190
4,0				105	150	165
4,5				95	135	150
5,0				85	120	135
5,5					110	120

Table 5 — Run length for manual metal-arc welding – $110 \% < \text{electrode efficiency} \leq 130 \%$

Heat input kJ/mm	Run length from 410 mm of a 450 mm electrode of diameter					
	2,5 mm	3,2 mm	4,0 mm	5,0 mm	6,0 mm	6,3 mm
0,8	150	250	385	605		
1,0	120	200	310	485		
1,2	100	165	260	405	580	
1,4	85	140	220	345	500	550
1,6		125	195	300	435	480
1,8		110	170	270	385	425
2,0		100	155	240	350	385
2,2		90	140	220	315	350
2,5			125	195	280	305
3,0			105	160	230	255
3,5			90	140	200	220
4,0				120	175	190
4,5				110	155	170
5,0				95	140	155
5,5				90	125	140

Table 6 — Run length for manual metal-arc welding – electrode efficiency > 130%

Heat input kJ/mm	Run length from 410 mm of a 450 mm electrode of diameter				
	3,2	4,0	5,0	6,0	6,3
	mm	mm	mm	mm	mm
0,8	320	500			
1,0	255	400	625		
1,2	215	330	520		
1,4	180	285	445		
1,6	160	250	390	560	620
1,8	140	220	345	500	550
2,0	130	200	310	450	495
2,2	115	180	285	410	450
2,5	100	160	250	360	395
3,0	85	135	210	300	330
3,5		115	180	255	285
4,0		100	155	225	245
4,5		90	140	200	220
5,0			125	180	200
5,5			115	165	180

2.6 Special considerations

2.6.1 Conditions which might require more stringent procedures

The preheating conditions presented in Figure 2 a) to m) have been found from experience to provide a satisfactory basis for deriving safe welding procedures for many welded fabrications. However, the risk of hydrogen cracking is influenced by several parameters and these can sometimes exert an adverse influence greater than accounted for in Figure 2 a) to m). The following covers some of the factors that may increase the risk of cracking to above that envisaged in drawing up the data in Figure 2. Precise quantification of the effects of these factors on the need for a more stringent procedure and on the changes to the welding procedure required to avoid cracking cannot be made at present. The following should therefore be considered as guidelines only.

Joint restraint is a complex function of section thickness, weld preparation, joint geometry and the stiffness of the structure. Welds made in section thicknesses above approximately 50 mm and root runs in double bevel butt joints may require more stringent procedures.

Certain welding processes may not be adequate for avoiding weld metal hydrogen cracking when welding steels of low carbon equivalent. This is more likely to be the case when welding thick sections (e.g. greater than approximately 50 mm) and with higher heat inputs.

The use of higher strength alloyed weld metal or carbon manganese weld metal with a manganese content above approximately 1,5 % may lead to higher operative stresses. Whether or not this causes an increased risk of HAZ cracking, the weld deposit would generally be harder and more susceptible to cracking itself, and in this condition increased precautions against hydrogen cracking are advised.

Experience and research have indicated that lowering the inclusion content of the steel, principally by lowering the sulphur content (but also the oxygen content), may increase the hardness of the heat-affected zone, and possibly cause a small increase in the risk of HAZ hydrogen cracking. Accurate quantification of the effect is not presently practicable.

Although modifications to the procedures to deal with welds involving the above factors can, in principle, be obtained through a change in heat input or preheat or weld hydrogen level, the most effective modification is to lower the weld hydrogen level. This can be done either directly, by lowering the weld hydrogen input to the weld (use of lower hydrogen welding processes or consumables), or by increasing hydrogen loss from the weld by diffusion through the use of post-heat for a period of time after welding. The required post-heat time will depend on many factors, but a period of 2 h to 3 h has been found to be beneficial in many instances. It is recommended that the required modifications to the procedures be derived by the use of adequate joint simulation weld testing.

2.6.2 Relaxations

Relaxations of the welding procedures may be possible under the following conditions:

- *General preheating.* If the whole component or a width more than twice that stated in Clause 12 of EN 1011-2 : 2001 (ISO/TR 17671-2:2002) is preheated, it is generally possible to reduce the preheating temperature by a limited amount;
- *Limited heat sink.* If the heat sink is limited in one or more directions (e.g. when the shortest heat path is less than ten times the fillet leg length) especially in the thicker plate (e.g. in the case of a lap joint where the outstand is only marginally greater than the fillet weld leg length), it is possible to reduce preheating levels;
- *Austenitic consumables.* In some circumstances where sufficient preheating to ensure crack-free welds is impracticable an advantage may be gained by using certain austenitic or high nickel alloyed consumables. In such cases preheat may not be necessary, especially if the condition of the consumable is such as to deposit weld metal containing very low levels of hydrogen;
- *Joint fit up.* Close fillet welds (where the gap is 0,5 mm or less) may justify relaxation in the welding procedure.

2.6.3 Simplified conditions for manual metal-arc welding

Where single run minimum leg length fillet welds are specified in the design, Table 7 may be used to obtain the approximate heat input values for use in determining the welding procedure from Figure 2.

Table 7 — Values for heat input for manual metal-arc welding of single run fillet welds

Minimum leg length mm	Heat input for electrodes with covering types ^a and electrodes efficiencies		
	R and RR < 110 % kJ/mm	B < 130 % kJ/mm	R and RR > 130 % kJ/mm
4	0,8	1,0	—
5	1,1	1,4	0,6
6	1,6	1,8	0,9
8	2,2	2,7	1,3

^a Covering types (R, RR, B) see EN 499/ISO 2560.

These values are appropriate for the practical situation where a contractor is required to make single run fillet welds of a specified dimension related to the minimum leg length of the fillet welds, and where in practice one leg would be longer than that minimum, as for example in a horizontal-vertical fillet weld (position PB according to EN ISO 6947) and the data is therefore not appropriate for direct conversion to welds of specified throat dimension.

In other cases heat input should be controlled by control of electrode runout (see Table 6) or directly through welding parameters.

2.7 Determination of preheat

Table 8 — Steps for the determination of preheat

Step	Terms	Clause/Figure/ equation	Example
1	Determine the carbon equivalent of the steel. This may be assessed by reference to mill certificates or the maximum carbon equivalent in the steel standard.	Equation (1)	0,45 %
2	Determine the hydrogen scale of the welding process and consumable as hydrogen scale A, B, C, D or E	2.4 and Table 2	Manual metal-arc welding and that the weld hydrogen level is appropriate to scale B in Table 2
3	Determine whether the joint is a fillet or butt weld.	–	Butt weld
4	From Figure 2 select the appropriate graph for scale B and carbon equivalent of 0,45. Use Figure 2 e). When a graph for the selected hydrogen scale and carbon equivalent is not available use the graph appropriate to the next highest carbon equivalent value.	–	Figure 2 e)
5	Determine the heat input to be used. This can be done either by reference to 2.5 or by using the minimum run dimensions for the butt weld.	Table 5	Assume this will be deposited with a 4 mm electrode to be run out in about 260 mm of run length 1,2 kJ/mm
6	Determine the combined thickness of the butt joint, referring to 2.3.	–	Assume calculated combined thickness of 50 mm
7	Using Figure 2 e), plot the co-ordinates of 1,2 kJ/mm heat input and 50 mm combined thickness. The preheating temperature to be used should be obtained by reading the preheat line immediately above or to the left of the co-ordinated point for the heat input and combined thickness. Read off minimum preheating and interpass temperature required. Variation at step 7. In the event that the preheat is undesirable, proceed as follows.	–	75 °C
8	Re-examine Figure 2 e) to determine the minimum heat input for no preheat (20 °C line, normally).	–	For butt weld example: 1,4 kJ/mm
9	If by reference to Table 5 and consideration of welding position this heat input is feasible, proceed using electrode diameter and run length chosen from Table 5. If not feasible, proceed to step 10.	–	–
10	Using Figure 2 a) and d) examine the feasibility for using lower hydrogen levels (by the use of higher electrode drying temperatures or change of consumables or change of the welding process) to avoid the need for preheat at acceptable heat input levels.	–	–

d_1 = average thickness over a length of 75 mm

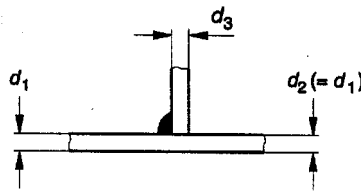
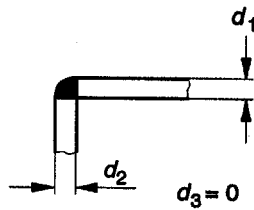
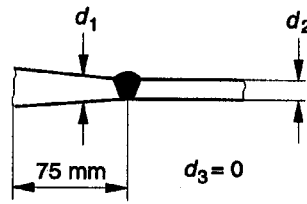

Combined thickness = $d_1 + d_2 + d_3$

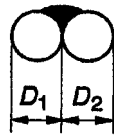

Combined thickness = $\frac{1}{2} (D_1 + D_2)$ to take account of heat sink.

Maximum diameter 40 mm for bar

Figure 1 — Examples for determination of combined thickness

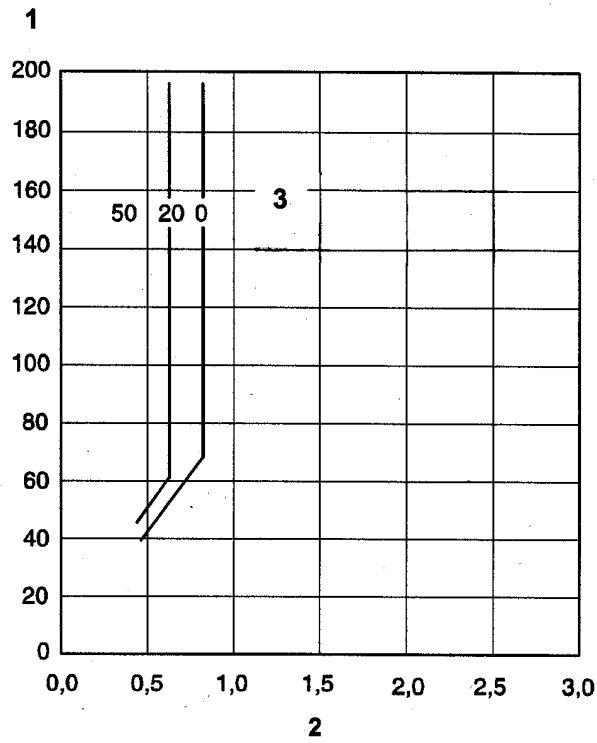

4	A	B	C	D	E
5	0,30	0,34	0,38	0,44	0,46

Figure 2a)

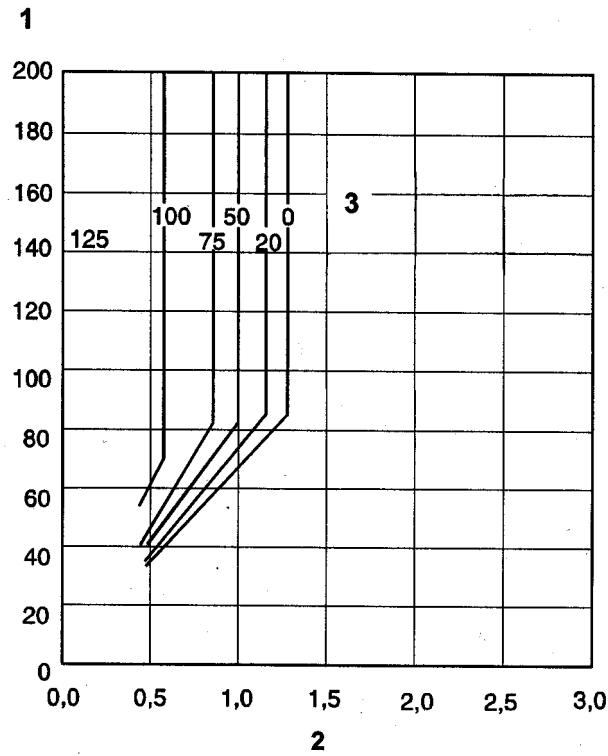

4	A	B	C	D	E
5	0,34	0,39	0,41	0,46	0,48

Figure 2b)

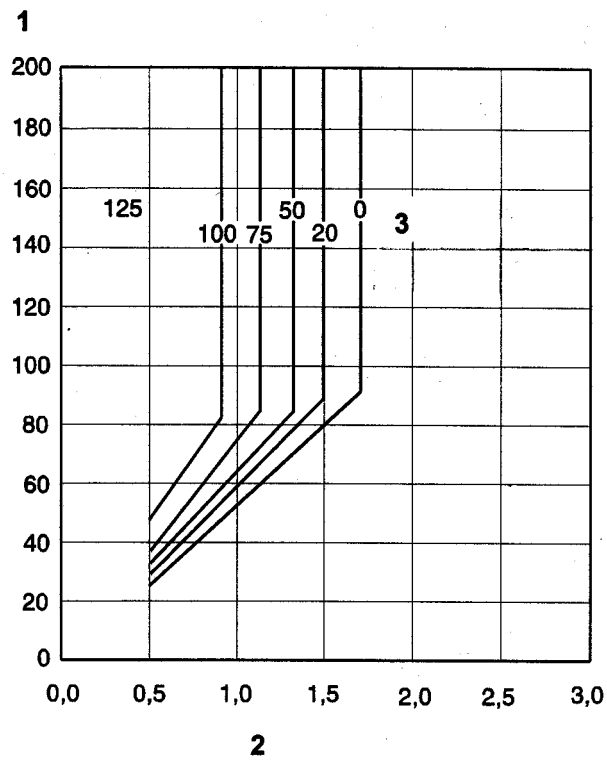

4	A	B	C	D	E
5	0,38	0,41	0,43	0,48	0,50

Figure 2c)

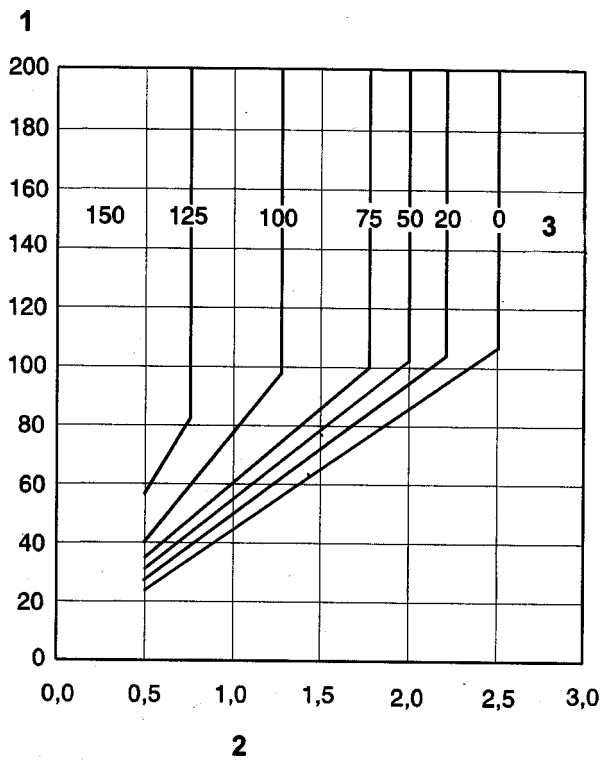

4	A	B	C	D	E
5	0,41	0,43	0,45	0,50	0,52

Figure 2d)

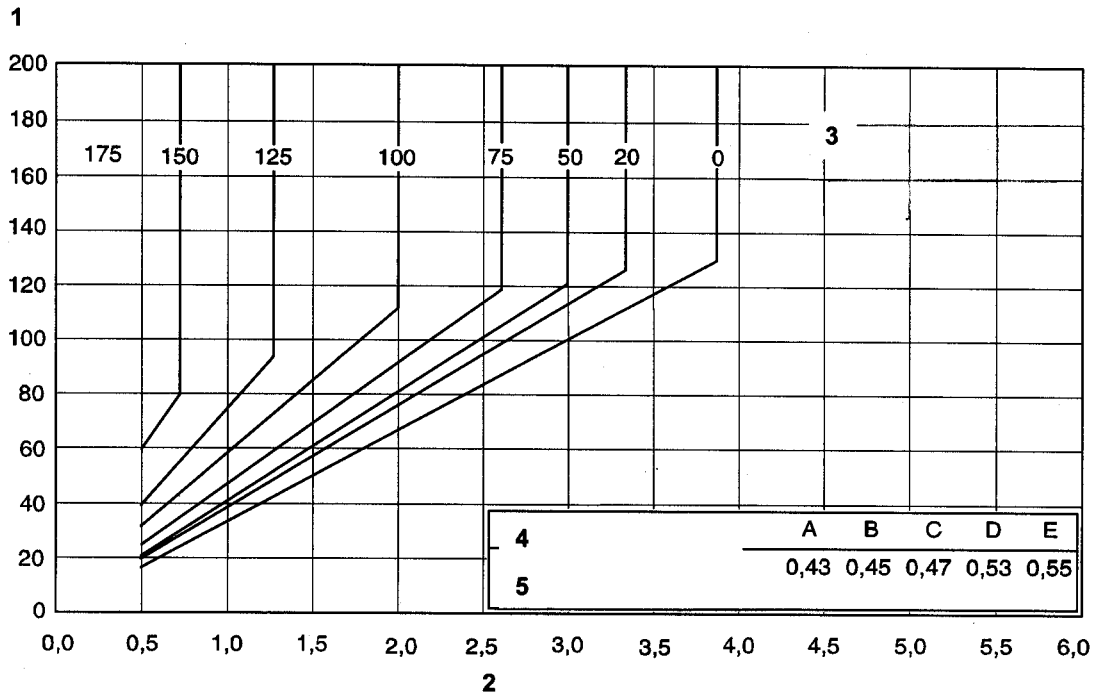

Figure 2e)

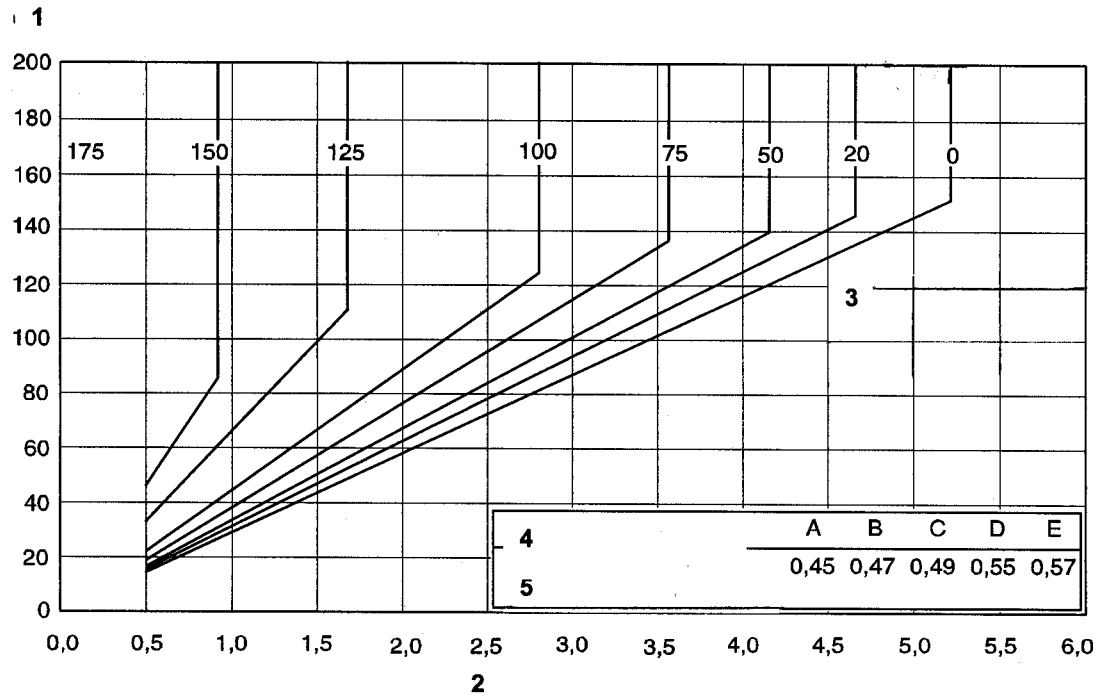

Figure 2f)

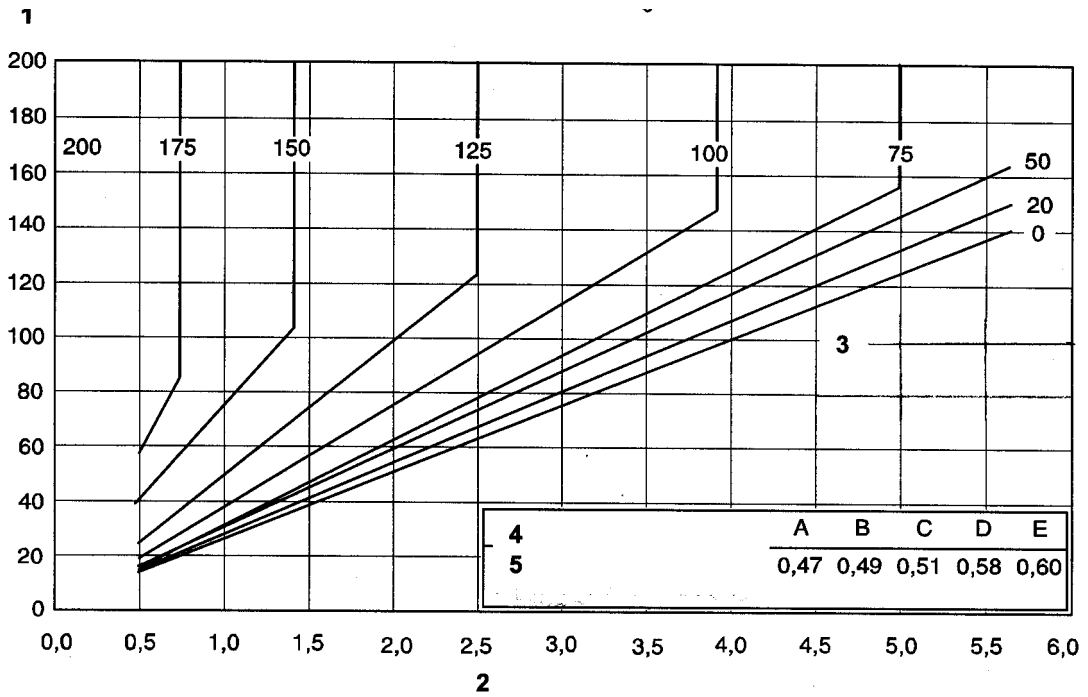

Figure 2g)

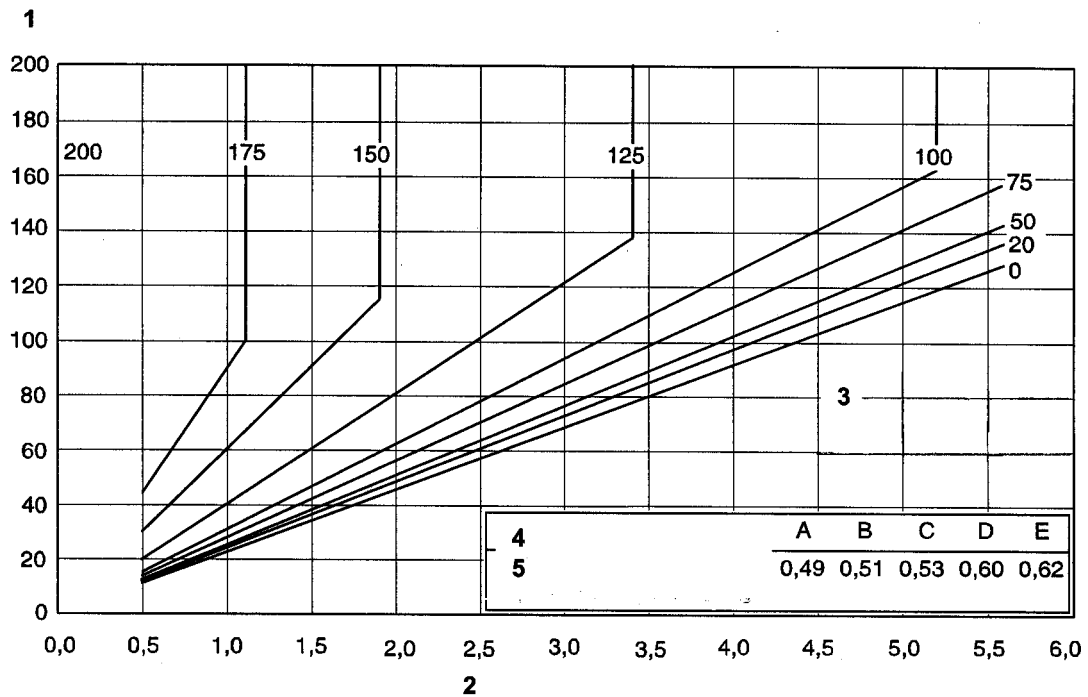

Figure 2h)

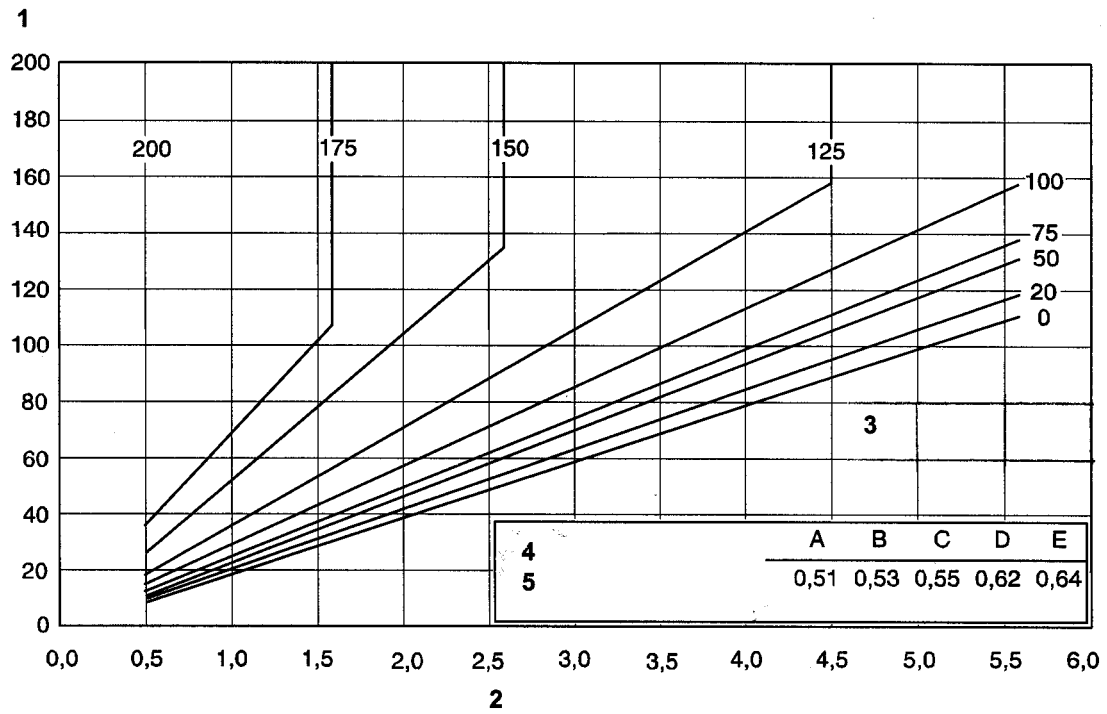

Figure 2i)

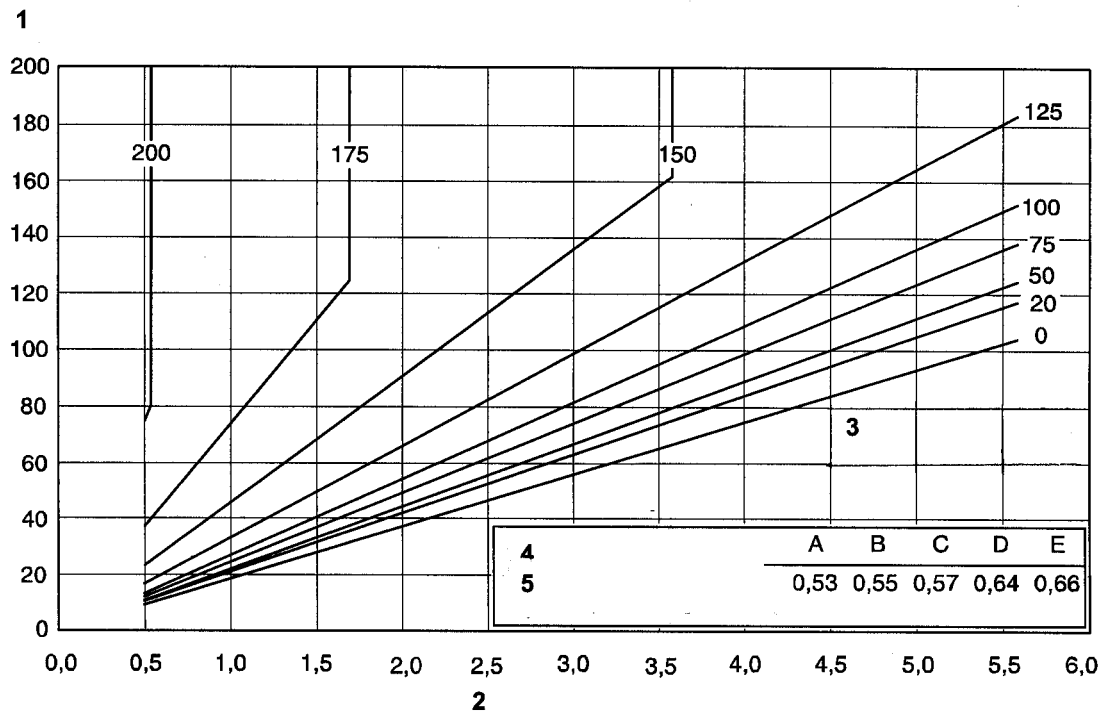

Figure 2j)

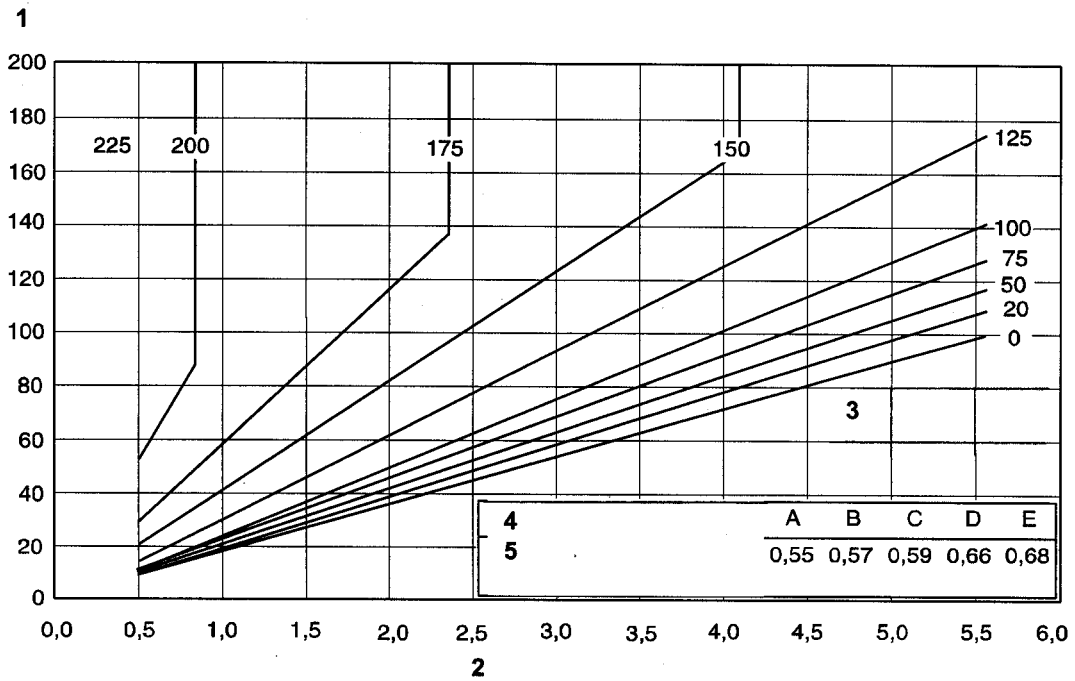

Figure 2k)

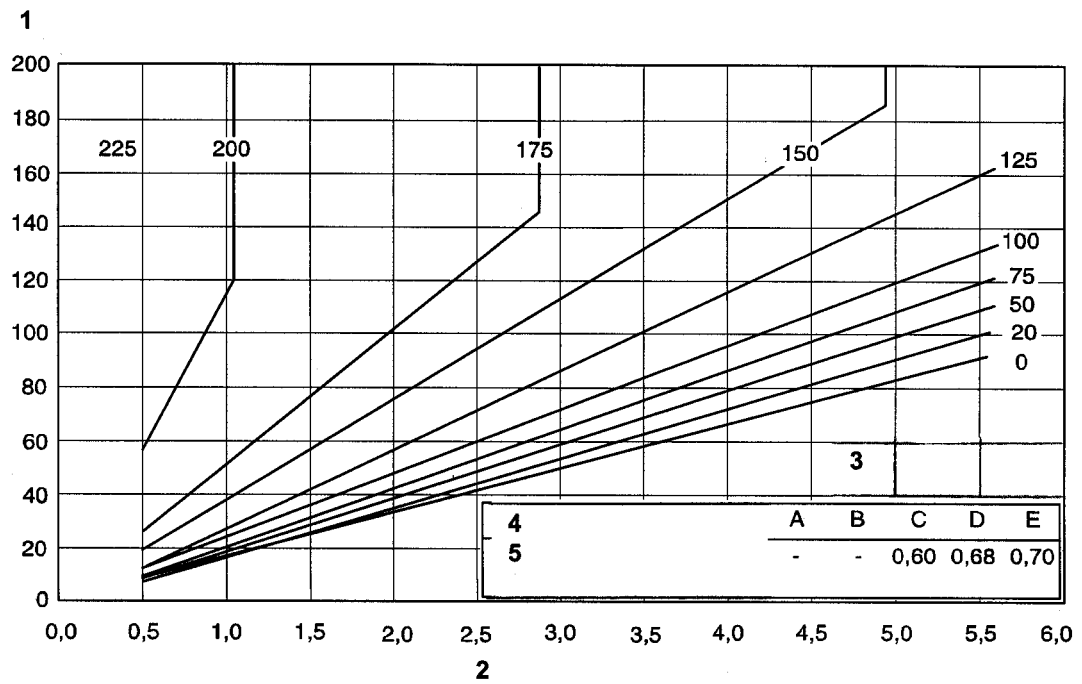

Figure 2l)

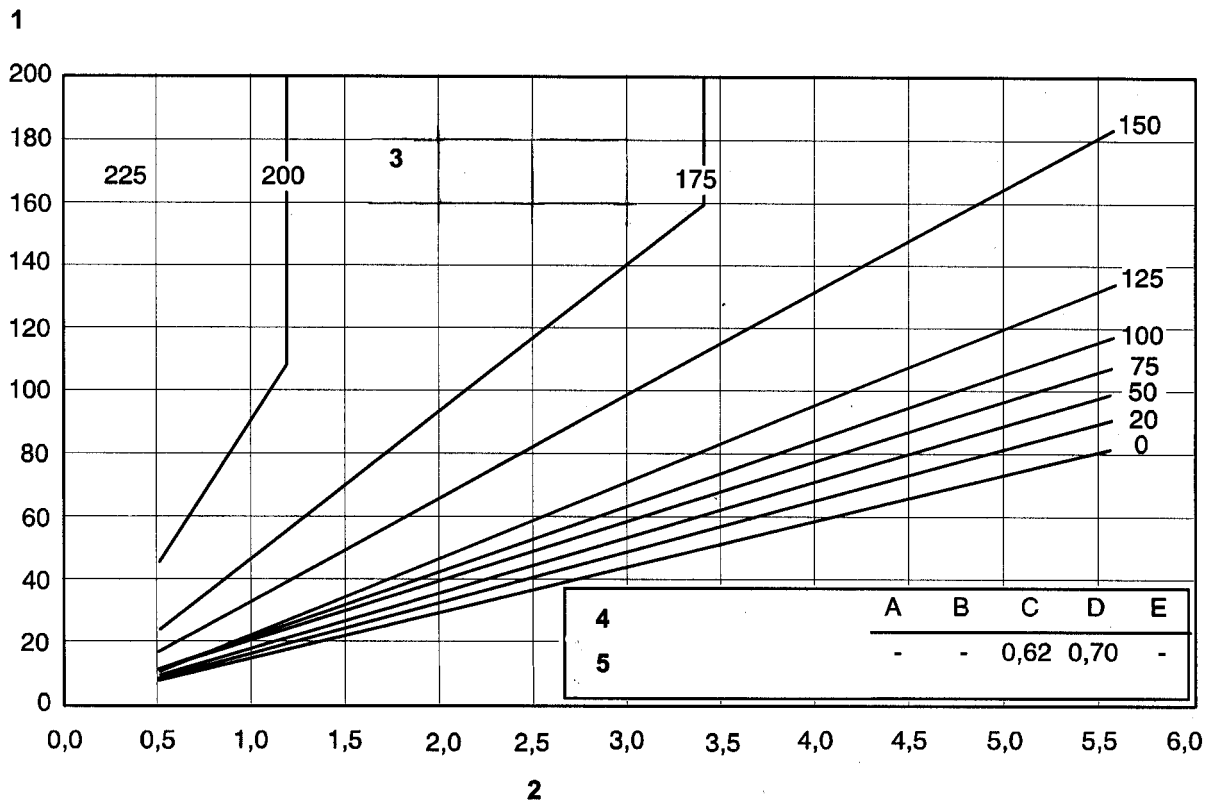

Figure 2m)

Key

- 1 Combined thickness, mm
- 2 Heat input, kJ/mm
- 3 Minimum preheating temperature, °C
- 4 Scale
- 5 To be used for carbon equivalent not exceeding

Figure 2 — Conditions for welding with defined carbon equivalents

3 CET-method

3.1 Cracking test method

This method of calculating the minimum preheat temperature for arc welding is based mainly on the results of the y-joint (Tekken) weld cracking test and butt welds. Fillet welding data, mainly resulting from the CTS-test type, has also been incorporated. It should be noted that single run fillet welds (CTS tests) show a lower restraint than the critical root runs in butt welds (Tekken tests). The different preheat temperature amounted approximately to 60 °C. Therefore the calculated preheat temperature for fillet welds might be too stringent. It is up to the experience of the fabricator to use this advantage. To determine the preheat temperature of fillet and butt welds with different plate thicknesses the thicker parent metal should always be used as the basis for the calculation. Multi run fillet welds show a restraint similar to butt welds. Therefore it is preferable to use the same preheat temperature as for butt welds.

The investigations were carried out in the early 1980s and published as IIW-Documents IX-1630-91 and IX-1631-91. After successful application especially in welding high-strength low-alloyed steels with yield strengths up to 960 N/mm² the method was introduced in Stahl Eisen Werkstoffblatt SEW 088, a German national guideline for welding. The application of the method has been proven to predict conditions for welded joints that will not induce cold cracking.

According to extensive investigations, the cold cracking behaviour is mainly influenced by the chemical composition of the parent metal and the weld metal, the plate thickness, the hydrogen content of the weld metal, the heat input and the residual stress. A brief overview of these influencing factors is given in 3.2 to 3.5.

3.2 Parent metal composition range

The parent metals included are fine grained low alloyed steels as well as unalloyed steels of groups 1 to 4 and 11 in accordance with CR ISO 15608:2000. The range of composition is also detailed in Table 9.

Table 9 — Range of chemical composition of the main constituents for parent metal for the CET-method

Element	Percentage by weight
Carbon	0,05 to 0,32
Silicon	≤ 0,8
Manganese	0,5 to 1,9
Chromium	≤ 1,5
Copper	≤ 0,7
Molybdenum	≤ 0,75
Niobium	≤ 0,06
Nickel	≤ 2,5
Titanium	≤ 0,12
Vanadium	≤ 0,18
Boron	≤ 0,005

The effect of the chemical composition on the cold cracking susceptibility is characterised by the carbon equivalent, *CET*, which is defined (in %) as:

$$CET = C + \frac{Mn + Mo}{10} + \frac{Cr + Cu}{20} + \frac{Ni}{40} \quad (3)$$

Within the range of the chemical composition detailed in Table 9 usual *CET* values are between 0,2 % and 0,5 %. Normally, the higher value either of the parent metal or the weld metal increased by 0,03 % is to be used.

Table 10 — Range of validity

Abbreviation	Term	Dimension	Range of validity
<i>d</i>	Thickness	mm	$10 \leq d \leq 90$
<i>HD</i>	Hydrogen content	ml/100 g	$1 \leq HD \leq 20$
<i>Q</i>	Heat input	kJ/mm	$0,5 \leq Q \leq 4,0$
<i>YS</i>	Yield strength	N/mm ²	$YS \leq 1\ 000$

A linear relationship exists between the carbon equivalent *CET* and the preheat temperature T_p .

$$T_{pCET} = 750 \times CET - 150 \quad (4)$$

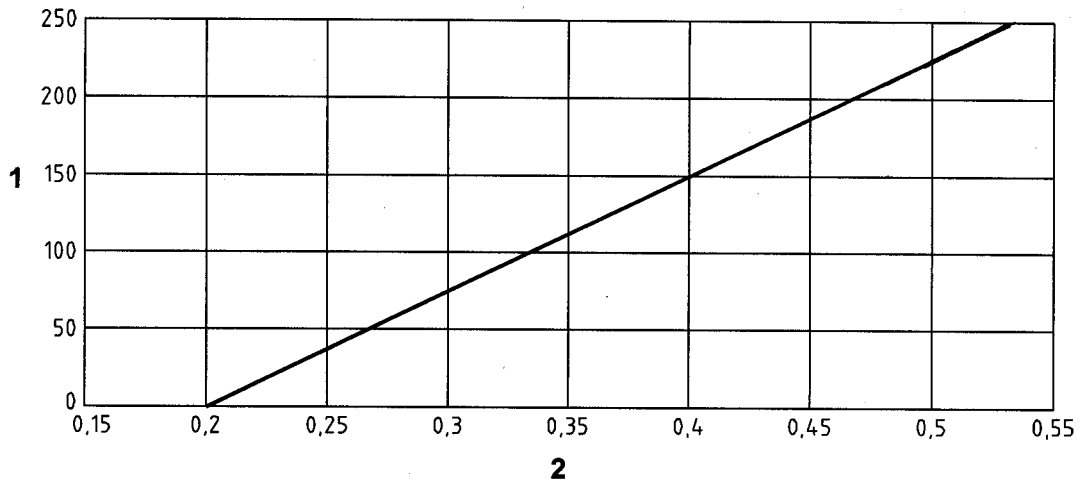

Key

- 1 T_{pCET} in °C
- 2 Carbon equivalent *CET* in %

Figure 3 — Preheat temperature in relation to *CET*

Figure 3 shows that an increase of about 0,01 % in the carbon equivalent, *CET*, leads to an increase of about 7,5 °C in the preheat temperature.

3.3 Plate thickness

The relationship between plate thickness, *d*, and preheat temperature, T_p , is given in equation (5) and Figure 4. In the case of different parent metal thickness, the thickness of the thicker one is relevant.

$$T_{pd} = 160 \times \tanh(d / 35) - 110 \tag{5}$$

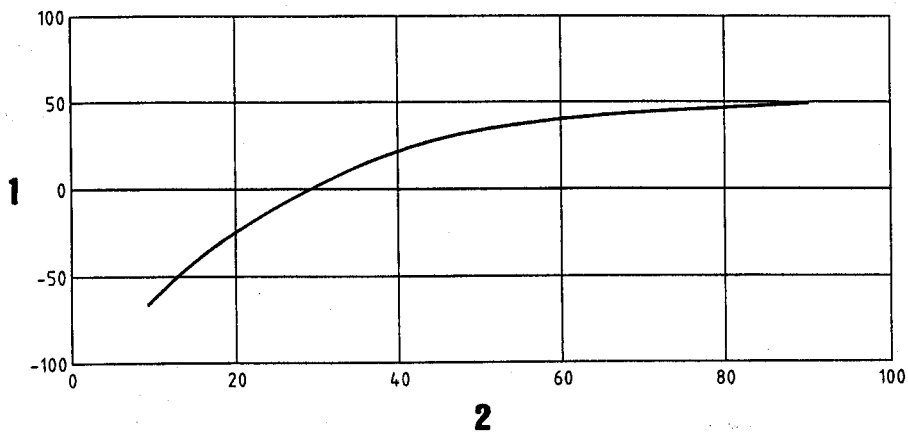

Key

- 1 T_{pd} in °C
- 2 Plate thickness *d* in mm

Figure 4 — Preheat temperature in relation to the plate thickness

Figure 4 shows that a change in thickness exerts a strong influence in cases where the plate thickness is < 40 mm. This influence diminishes, however, with increasing plate thickness and is only small for thickness > 60 mm.

3.4 Hydrogen level and welding process

The effect of hydrogen content, HD , of the weld metal according to EN ISO 3690 on preheat temperature level is given in equation (6) and Figure 5.

$$T_{pHD} = 62 \times HD^{0,35} - 100 \quad (6)$$

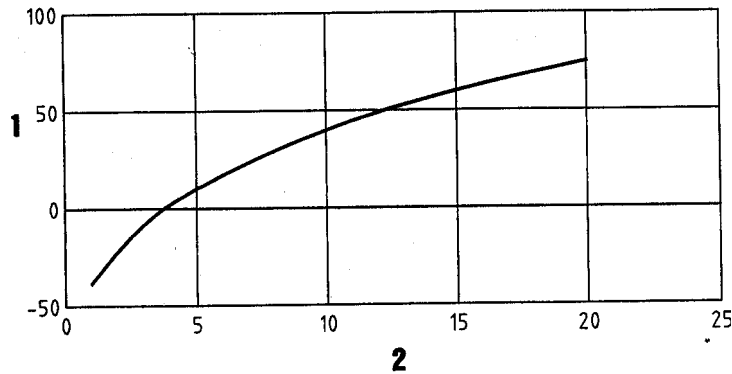

Key

- 1 T_{pHD} in °C
2 Hydrogen content HD in ml/100g

Figure 5 — Preheat temperature in relation to hydrogen content, HD

Figure 5 shows that an increase of hydrogen content (HD) requires an increase of the preheat temperature. A change in hydrogen content has a greater effect on the preheat temperature for lower concentrations than for higher ones.

A reduction in the hydrogen content of the weld metal by the use of correctly dried and baked consumables or consumables with very low hydrogen levels for manual metal arc welding (111) and submerged arc welding (121) leads to a remarkable reduction in the required preheat temperature.

However, the most favourable welding process in this context is gas shielded arc welding with solid wire (131, 135) resulting in a hydrogen content of about 2,0 ml/100g deposit weld metal.

NOTE The numbers in brackets are process numbers according to EN ISO 4063.

3.5 Heat input

Values of the heat input, Q , (in kJ/mm) for use with Figure 6 should be calculated in accordance with EN 1011-1 and EN 1011-2.

The influence of the heat input, Q , on the preheat temperature is given in equation (7) and Figure 6.

$$T_{pQ} = (53 \times CET - 32) \times Q - 53 \times CET + 32 \quad (7)$$

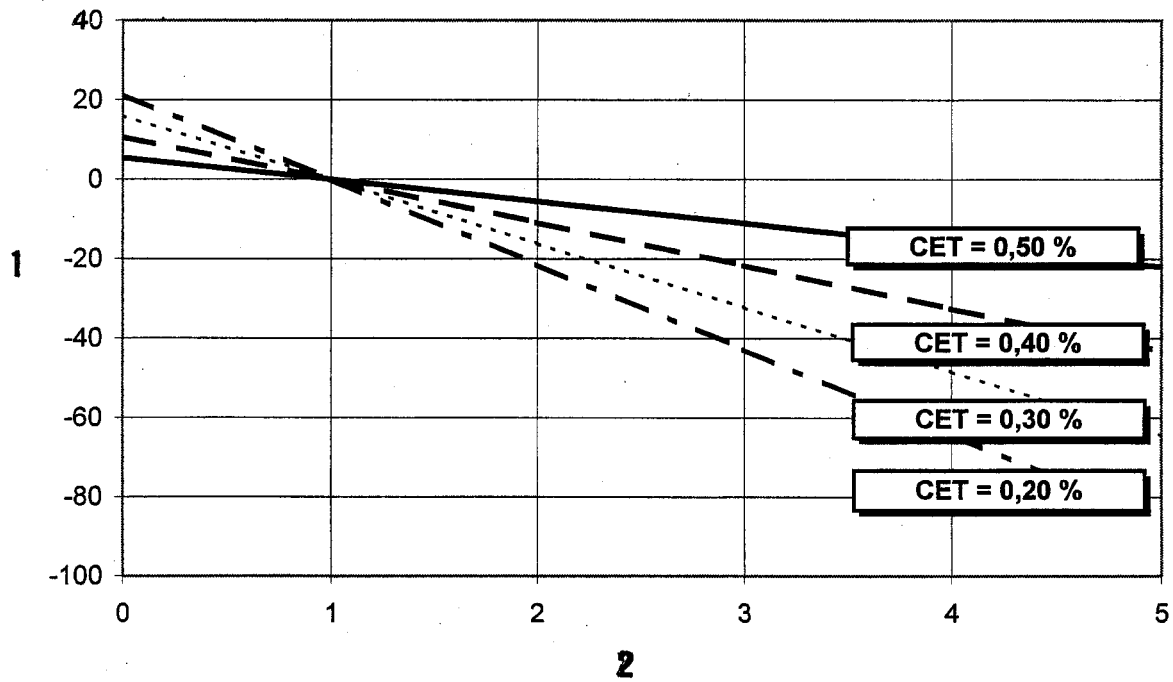

Key

- 1 T_{pQ} in °C
- 2 Heat input Q in kJ/mm

Figure 6 — Preheat temperature in relation to heat input, Q

Figure 6 shows that an increase in the heat input during welding permits a reduction of the preheat temperature. Furthermore the influence depends on the alloy content and is more pronounced for a low carbon equivalent than for a higher one. If other than the given CET values are required they have to be interpolated from the plotted curves. However the maximum heat input may be restricted by the effect on the toughness of the HAZ and weld metal.

3.6 Influence of residual stress

The relationship between the residual stress level and the preheat temperature is known only to a qualitative extent. An increase in the residual stresses and constraint results in an increase in the required preheat temperature. In deriving the equation for calculating the preheat temperature, it has been assumed that residual stresses in the weld region correspond to the yield strength of the parent metal or the weld metal.

3.7 Determination of preheat

3.7.1 Calculation of the minimum preheat temperature

The effect of the above mentioned influencing factors are summarized in a formula. In the case of different parent metal thicknesses the thicker one is relevant. The chemical composition, characterized by the carbon equivalent CET, the heat input Q, the plate thickness d, and the hydrogen content of the weld metal HD are combined in equation (8)

$$T_p = T_{pCET} + T_{pd} + T_{pHD} + T_{pQ} \tag{8}$$

This results to the following equation to calculate the preheat temperature T_p

$$T_p = 697 \times CET + 160 \times \tanh(d / 35) + 62 \times HD^{0.35} + (53 \times CET - 32) \times Q - 328 \tag{9}$$

According to experience, welding is safe when using the preheat temperatures calculated with the aid of equation (9) provided the following conditions are fulfilled.

- Tack and root welds as well as single run fillet welds should have a minimum length of 50 mm. If the plate thickness exceeds 25 mm, at least two layers should be deposited. For tack and root welds the use of consumables that give a mild ductile weld metal is recommended.
- In the case of filling runs of butt welds no intermediate cooling should take place as long as the weld thickness has not yet reached one-third of the parent metal thickness of the thicker material involved; otherwise it is recommended that the hydrogen content be reduced by means of a post-heating (soaking).
- The welding sequence should be selected in such a way that the plastic deformations of partly filled welds are reduced
- As mentioned before, single run fillet welds show a lower restraint than the critical root runs in butt welds. Therefore the calculated preheat temperature might be too conservative about 60 °C. It is up to the experience of the fabricator to use this advantage. For multi run fillet welds it is preferable to use the same preheat temperature as for butt welds.

3.7.2 Example for determination : numerical determination of the preheat temperature

The following example shows how to calculate the minimum preheat temperature for a butt joint according to the equations or figures.

Table 11 — Steel with the following chemical composition in % by weight

C	Mn	Cu	Ni	Cr	Mo
0,11	1,4	< 0,01	1,0	0,5	0,3

Carbon equivalent according to equation (3) $CET = 0,33 \%$

Plate thickness $d = 50 \text{ mm}$

Heat input $Q = 2 \text{ kJ/mm}$

Hydrogen content $HD 7$

The required preheat temperature is calculated according to equation (9):

$$T_p = 697 \times 0,33 + 160 \tanh(50/35) + 62 \times 7^{0,35} + (53 \times 0,33 - 32) \times 2,0 - 328$$

$$T_p = 138 \text{ °C}$$

3.7.3 Example for determination : graphical determination of the preheat temperature

The preheat temperature T_p and the minimum interpass temperature T_i can also be determined graphically using Figure 7.

- CET is known or can be calculated by using equation (3).
- Plate thickness is known.
- Hydrogen content is known depending on the welding process and applied consumables.
- Heat input, Q (in kJ/mm), is known or should be calculated by using the following equation:

$$Q = k \times \frac{I \times U}{v} \times 10^{-3} \quad (10)$$

where

- k is the heat transfer efficiency (0,9 for SAW(121), 0,8 for MMA(111), MIG(131) and MAG (135), 0,6 for TIG(141));
- I is the current (A);
- U is the voltage (V);
- v is the travel speed (mm/s).

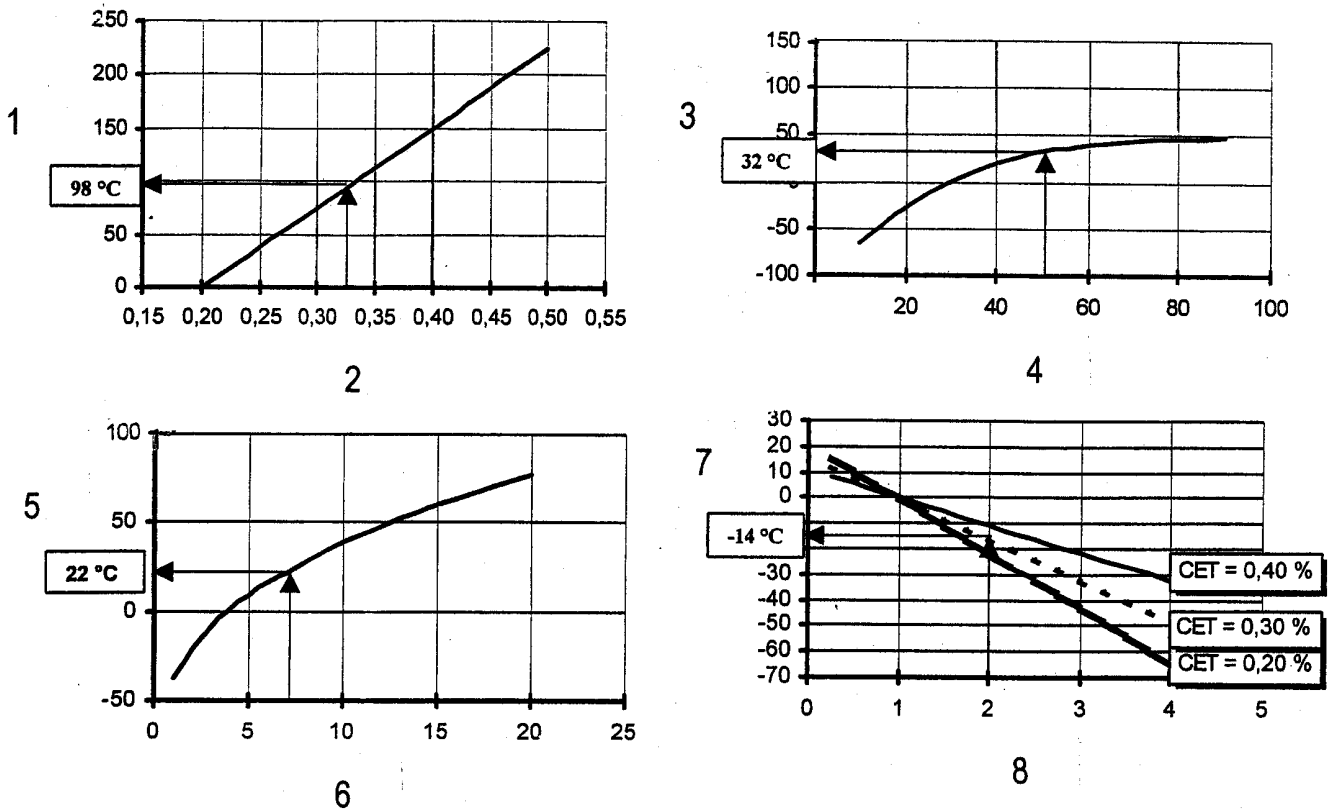

Key

- | | |
|--------------------------------|------------------------------------|
| 1 T_{CET} in °C | 5 T_{HD} in °C |
| 2 Carbon equivalent CET in % | 6 Hydrogen content HD in ml/100g |
| 3 T_d in °C | 7 T_Q in °C |
| 4 Plate thickness d in mm | 8 Heat input Q in kJ/mm |

Figure 7 — Graphical method for the determination of minimum preheat temperature

Table 12 — Steps for determination

Step	Terms	Figure/equation	Example
1	Determine the preheat temperature depending on the influencing factor <i>CET</i>	Figure 3	$T_{CET} = 98 \text{ }^{\circ}\text{C}$
2	Determine the preheat temperature depending on the influencing factor <i>d</i> .	Figure 4	$T_d = 32 \text{ }^{\circ}\text{C}$
3	Determine the preheat temperature depending on the influencing factor <i>HD</i> .	Figure 5	$T_{HD} = 22 \text{ }^{\circ}\text{C}$
4	Determine the preheat temperature depending on the influencing factor <i>Q</i> .	Figure 6	$T_Q = - 14 \text{ }^{\circ}\text{C}$
5	Add up the single values of the temperature		$T_p = 138 \text{ }^{\circ}\text{C}$

3.8 Special considerations

3.8.1 Reduction of hydrogen content by post heating (soaking)

When there is an increased risk of cold cracking, especially when steels with a yield strength of $\geq 460 \text{ N/mm}^2$ and in a thickness $\geq 30 \text{ mm}$ are used in multilayer submerged arc welded joints, it is advisable to reduce the hydrogen content by means of heat treatment immediately after welding. In order to reduce the amount of hydrogen, the weld region has to be kept at a temperature $200 \text{ }^{\circ}\text{C} \leq T_p \leq 300 \text{ }^{\circ}\text{C}$ for an appropriate time depending on the plate thickness.

3.8.2 Welding with reduced preheating

Depending on the experience of the fabricator in multi-run welding it may be possible to reduce preheating by maintaining an adequately high interpass temperature, T_i , by using a suitable welding sequence with short interpass times. The possibility of reducing the preheat by maintaining a high interpass temperature depends not only on limiting conditions during fabrication but also on the chemical composition of the steel to be welded, i.e. on the *CET* and the resulting value for T_i . The interpass temperature T_i , should be calculated by equation (9) as for T_p .

3.8.3 Welding with austenitic consumables

Where sufficient preheating is not applicable, an advantage can be gained by using austenitic or high nickel alloyed consumables. The calculated preheat temperature can be reduced considerably as a result of the better strain condition and hydrogen distribution. Basic consumables should be preferred. However, this method can only be applied in accordance with the relevant design code or application standard.

4 CE_N -method

4.1 Cracking test method

This method is partly based on the results of y-groove tests, which have been used in Japan for a long time by steel manufacturers as weldability performance tests for newly developed steels by fabricators as welding procedure specification tests. The scheme was originally published in 1989, and was described with modifications in *Welding in the World*, Vol.35, No.5, pp327-334, 1995.

4.2 Parent metal composition range

The parent metals covered are ferritic carbon, carbon manganese, and low carbon low alloy steels.

The range of chemical compositions applicable for this method is shown in Table 13.

Table 13 — Range of chemical composition of main constituents for parent metal for CE_N method

Element	Percentage by weight
Carbon	0,02 to 0,30
Silicon	≤ 0,6
Manganese	≤ 2,0
Chromium	≤ 2,5
Copper	≤ 1,0
Nickel	≤ 3,75
Molybdenum	≤ 0,75
Vanadium	≤ 0,10
Niobium	≤ 0,10
Boron	≤ 0,0003 (3ppm)

This method uses two types of carbon equivalents.

One is CE_N carbon equivalent, which this method considers as an index of the susceptibility of steels to hydrogen cracking. Values of this carbon equivalent are calculated using the following equation (11):

$$CE_N = C + f(C) \left[\frac{Si}{24} + \frac{Mn}{6} + \frac{Cu}{15} + \frac{Ni}{20} + \frac{Cr + Mo + V}{5} \right] \quad (11)$$

where, $f(C) = 0,75 + 0,25 \tanh\{ 20 (C - 0,12) \}$

$f(C)$ is a coefficient which decreases with a decreasing carbon content and values of $f(C)$ are given in Table 14.

Table 14 — Value of coefficient $f(C)$

C(%)	$f(C)$	C(%)	$f(C)$
0,02	0,51	0,13	0,80
0,03	0,51	0,14	0,85
0,04	0,52	0,15	0,88
0,05	0,53	0,16	0,92
0,06	0,54	0,17	0,94
0,07	0,56	0,18	0,96
0,08	0,58	0,19	0,97
0,09	0,62	0,20	0,98
0,10	0,66	0,21	0,99
0,11	0,70	0,22	0,99
0,12	0,75	0,23	1,00

Figure 8 gives the master curves describing the necessary minimum preheat to avoid root cracks in y-groove testing as a function of CE_N and material thickness under the condition of the weld metal hydrogen content of 5ml/100g and a heat input of 1,36 kJ/mm (arc energy of 1,7 kJ/mm and arc heat transfer efficiency of 0,80).

The other carbon equivalent is of an IIW type, which this method considers as an index of the extent to which high levels of hardness persist under high heat input welding conditions (see Figure 9). Values of this carbon equivalent are calculated using the following equation (11):

$$CE_{IIW} = C + \frac{Mn}{6} + \frac{Cr + Mo + V}{5} + \frac{Ni + Cu}{15} \quad (12)$$

4.3 Material thickness

This method is applicable for the material thickness in the range $10 \geq t \leq 200$ mm. The effect of the material thickness on hydrogen cracking is indicated in Figure 8.

4.4 Weld metal hydrogen content and welding process

This method is applicable to any arc welding process. The weld metal hydrogen content is the volume of diffusible hydrogen (ml) per 100 g deposited metal, determined by either a mercury displacement method (IIW-method) or a gas-chromatographic method (JIS Z 3118). The effect of the weld metal hydrogen content on hydrogen cracking is shown in Figure 10.

4.5 Heat input

This method is applicable for heat input values in the range $0,4 \leq Q \leq 5,0$ kJ/mm. Preheating is normally not required for welding of most steels when the heat input is higher $\geq 4,0$ kJ/mm. The effect of the heat input on hydrogen cracking is shown in Figure 9. The heat input is calculated by the following equations (13) and (14):

$$\text{Heat input (kJ/mm)} = k \cdot \text{Arc energy (kJ/mm)} \tag{13}$$

$$\text{Arc energy (kJ/mm)} = I \cdot U / v \tag{14}$$

where

k is the heat transfer efficiency (0,9 for SAW (121), 0,8 for MMA (111), MIG (131) and MAG (135), 0,6 for TIG (141));

NOTE The numbers in brackets are process numbers according to EN ISO 4063.

I is the current (A);

U is the voltage (V);

v is the travel speed (mm/s)

Graduation for heat input in Figure 9 is prepared for the case of *k* = 0,8.

4.6 Weld metal yield strength

This method is applicable for the yield strength levels of weld metal in the range $300 \text{ MPa} \leq \text{YS} \leq 800 \text{ MPa}$. The effect of the weld metal yield strength on hydrogen cracking is shown in Figure 11. Table 15 shows the yield strength levels of the all-weld-metal of some steel grades.

Table 15 — Yield strength levels for all-weld-metal

Steel grade	Yield strength MPa
Mild steel	360
HT 490 (Tensile strength 490 MPa)	400
HT 590 (Tensile strength 590 MPa)	500
HT 780 (Tensile strength 780 MPa)	700
1,25%Cr-0,5Mo	570
2,25%Cr-1%Mo	600
2,5%Ni	520
3,5%Ni	500

4.7 Determination of preheat

Table 16 — Steps for the determination of preheat

Step	Text	Example
1	Determine the carbon CE_N and equivalents, CE_{IIV} of the steel. This may be assumed by reference to mill certificates.	Assume 0,40 CE_N and 0,45 CE_{IIV}
2	Determine the hydrogen content of weld metal and find ΔCE_N (hydrogen) from Figure 10.	Assume 7m1/100g, then ΔCE_N (hydrogen) is +0,03
3	Determine the heat input value of the welding process and find ΔCE_N (heat input) from heat input and CE_{IIV} from Figure 9.	Assume 1,6kJ/mm, then ΔCE_N (heat input) is -0,01
4	Calculate the relevant CE_N as follows: CE_N (relevant) = $CE_N + \Delta CE_N$ hydrogen + ΔCE_N heat input	CE_N (relevant) is 0,42 = 0,40 + 0,03 - 0,01
5	Determine the material thickness, which is that of the thicker plate or pipe in both a butt and fillet geometry.	Assume 50 mm
6	Find the necessary preheat temperature to avoid root cracking in the y-groove test from CE_N (relevant) and the plate thickness from Figure 8.	Preheat for y-groove test, PHT(y-groove) is 142 °C
7	Determine the yield strength of the weld metal. This may be assumed by reference to manufacturer's catalogue of the all-weld-metal or to Table 15.	Assume 400MPa
8	Find the preheat temperature correction for the welding practice from the weld metal strength from Figure 11. In case of repair welding or short-single- run welding, select slit welding. Otherwise, select ordinary welding.	Preheat to be corrected, ΔPHT is -70°C for ordinary welding
9	Calculate the necessary preheat temperature from the following relation: $PHT = PHT(y - groove) + \Delta PHT$	Preheat is 72 °C, (142 °C to 70 °C)
10	Round the preheat value established in step 9 upwards to the nearest 5°C.	Preheat is 75 °C.

4.8 Special considerations

4.8.1 Weld metal hydrogen content

A reduction of the weld metal hydrogen content is very beneficial in avoiding hydrogen cracking as shown in Figure 10. Therefore, the use of a low hydrogen welding process or welding consumable is recommended. However, it should be noted that the weld metal hydrogen content increases by 1 ml/100 g to 3 ml/100 g in the following cases:

- a) welding is performed on grooves with rust or grease present;
- b) welding is performed using moist welding materials or rusted welding electrodes due to inappropriate storage;

c) welding is performed under hot and humid conditions.

The cases a) and b) apply to all the welding processes and the case c) applies only to manual metal arc welding (111).

4.8.2 Number of the weld layers and weld metal strength

The y-groove test examines root cracks that are initiated at the acute notch of a y-groove in a short single-run weld under high restraint. In ordinary welding practice, weld runs are longer than those in the y-groove test and this results in slower cooling rates. Furthermore, multi-run welding is normally performed and post heating from the subsequent weld layers assists the effusion of hydrogen out of the weld root. It follows that the risk of root cracking is considerably reduced in ordinary multi-run welding.

Experience in welding fabrication has indicated that the y-groove testing provides conservative results, and that preheat temperature of some $50\text{ °C} \leq T_p \leq 75\text{ °C}$ than given by the y-groove testing can safely be used in practice when welding 360 MPa yield strength grade steel. In this method, as shown in Figure 11 the relaxation of preheat by 75 °C is made when welding 360 MPa yield strength grade steel. This relaxation is not recommended when welding of short-single-run welds such as encountered in jig welding or tack welding. The slit welding case in Figure 11 should be selected.

The occurrence of hydrogen cracking is greatly influenced by weld residual stress level. As the yield strength of weld metal increases and thereby weld residual stress increases, not only root cracks but also toe cracks and under layer cracks are more likely. However, y-groove testing cannot examine toe cracking and under layer cracking. Therefore, the extent of the relaxation of preheat from the critical preheat obtained in the y-groove testing should be reduced as the yield strength of weld metal increases, as shown in Figure 11.

4.8.3 Restraint

Joint restraint significantly influences hydrogen cracking in single-run welding. High restraint generally enhances the occurrence of hydrogen cracking. However, there is a case that root cracking is very likely in a fillet geometry under low restraint because the weld root is subjected to high bending stress. The effect of joint restraint is less significant in multi-run welding because the weld joint is constrained once a root weld is completed. Therefore, the degree of joint restraint is not considered as the factor for determining preheat in this method, except in the case of repair welding normally conducted under high restraint. The relaxation of preheat is not recommended in repair welding, as shown in Figure 11.

4.8.4 Weld metal hydrogen cracking

The subject of the relative behaviour of hydrogen cracking between the HAZ of the parent metal and the weld metal has not yet been satisfactorily clarified. The weld metal hydrogen cracking is known to be of more concern when welding carbon-reduced higher strength steels. In the case when the carbon equivalent CE_N of the steel is lower than that of the weld metal, this method recommends the use of CE_N of the weld metal or the all-weld-metal instead of that of the parent metal for the time being until the above subject is elucidated.

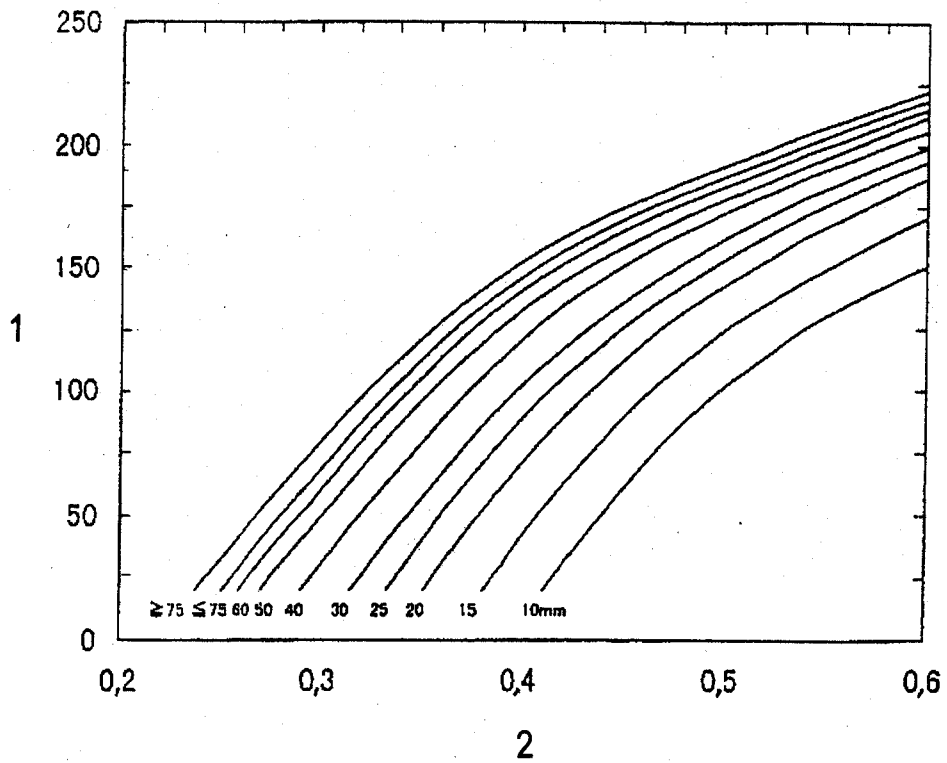

$HD_{IIW} = 5\text{ml}/100\text{ g DM}$
 $H.I. = 1,36\text{kJ}/\text{mm}$
 Ambient temperature = 10 °C.

Key

- 1 Critical preheat temperature in °C
- 2 Carbon equivalent CE_N

Figure 8 — Master curves for minimum preheat for y-groove cracking test

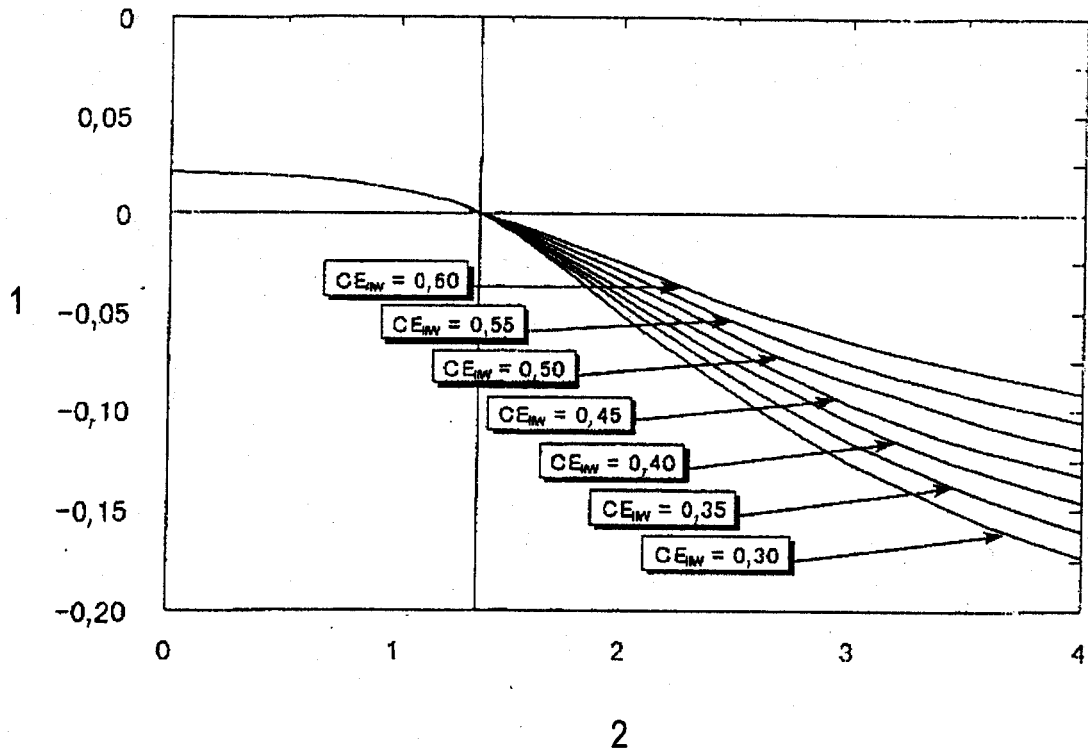

$$CE_{Iw} = C + \frac{Mn}{6} + \frac{Cr + Mo + V}{5} + \frac{Cu + Ni}{15}$$

Key

- 1 ΔCE_N
- 2 Heat input in kJ/mm

Figure 9 — CE_N correction with respect to weld heat input and CE_{Iw}

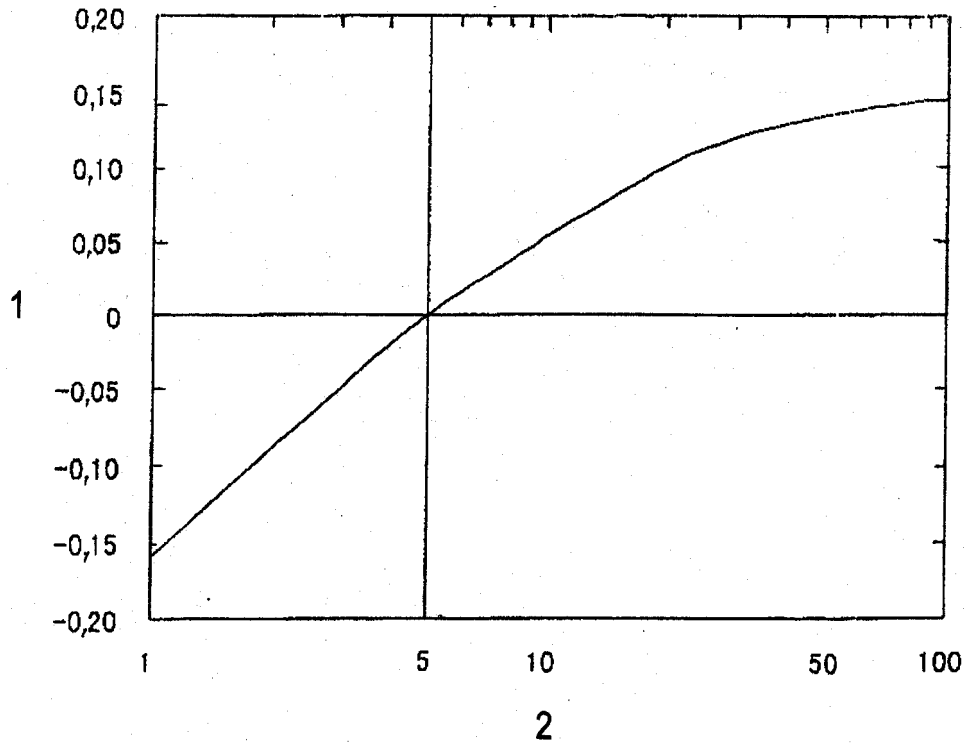
**Key**

- 1 ΔCE_N
 2 Weld metal hydrogen, HD_{IIW} in ml/100g DM

Figure 10 — CE_N correction with respect to weld metal hydrogen content (DM is deposited metal)

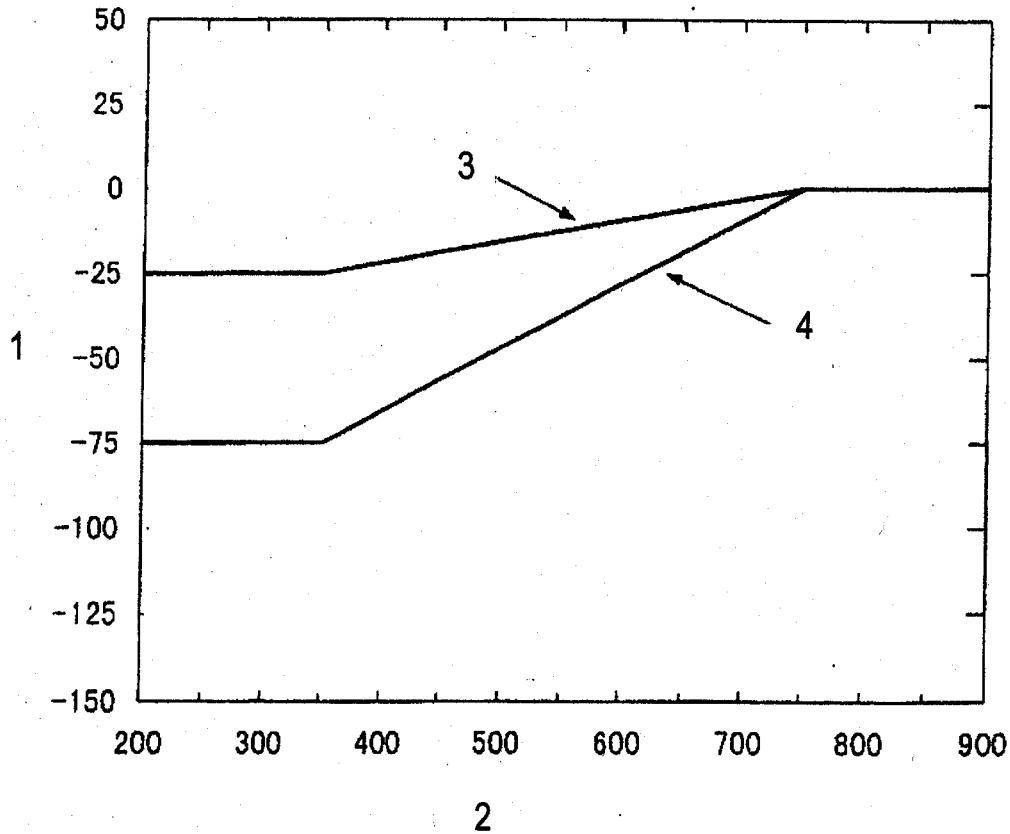

Key

- 1 Correction preheat temperature in °C
- 2 Yield strength in MPa
- 3 Slit welding, repair welding
- 4 Ordinary welding

Figure 11 — Correction of necessary preheat of welding practice

5 P_{cm} -method

5.1 General

5.1.1 Cracking test method

Two methods are used as the basis for estimating welding conditions to avoid cold cracking:

- heat-affected zone (HAZ) hardness control;
- hydrogen control.

5.1.2 HAZ hardness control method

HAZ hardness control is based on the assumption that cracking will not occur if the hardness of the HAZ is kept below some critical values. This is achieved by controlling the cooling rate below a critical value dependent on the hardenability of the steel. The selection of the critical hardness will depend on a number of factors such as steel type, hydrogen level, restraint, and service conditions. Laboratory tests with fillet welds show that HAZ cracking does not occur if the HAZ hardness is less than 350 HV, even with high-hydrogen electrodes. With low-hydrogen electrodes, hardnesses of 400 HV could be tolerated without cracking. Such hardness, however, may not be

tolerable in service where there is an increased risk of stress corrosion cracking, brittle fracture initiation, or other risks for the safety or serviceability of the structure.

The critical cooling rate for a given hardness can be approximately related to the carbon equivalent of the steel (see Figure 12). Since the relationship is only approximate, the curve shown in Figure 12 may be conservative for unalloyed carbon and carbon-manganese steels and thus allow the use of the high hardness curve with less risk.

Some low-alloy steels, particularly those containing niobium, may be more hardenable than Figure 12 indicates, and the use of the lower hardness curve is recommended.

Although the method can be used to determine a preheat level, its main value is in determining the minimum heat input (and hence the minimum weld size) that prevents excessive hardening. It is particularly useful for determining the minimum size of single-run fillet welds that can be deposited without preheat.

The hardness approach does not consider the possibility of weld metal cracking. However, from experience it is found that the heat input determined by this method is usually adequate to prevent weld metal cracking, in most cases, in fillet welds if the electrode is not a high-strength filler metal and is generally of a low-hydrogen type (e.g. low-hydrogen (MMA) electrode, gas shielded metal arc, flux cored arc, submerged arc).

Because the method depends solely on controlling the HAZ hardness, the hydrogen level and restraint are not explicitly considered.

5.1.3 Hydrogen controlled method

The hydrogen control method is based on the assumption that cracking will not occur if the average quantity of hydrogen remaining in the joint after it has cooled down to approximately 50 °C (120 °F) does not exceed a critical value dependent on the composition of the steel and the restraint. The preheat necessary to allow enough hydrogen to diffuse out of the joint can be estimated using this method.

This method is based mainly on results of restrained partial penetration butt weld tests; the weld metal used in the tests matched the parent metal. There has not been extensive testing of this method on fillet welds; however, by allowing for restraint, the method has been suitably adapted for those welds.

A determination of the restraint level and the original hydrogen level in the weld deposit is required for the hydrogen method.

The hydrogen control method is based on a single low-heat input weld run representing a root layer and assumes that the HAZ hardens. The method is, therefore, particularly useful for high strength, low-alloy steels having quite high hardenability where hardness control is not always feasible. Consequently, because it assumes that the HAZ fully hardens, the predicted preheat may be too conservative for carbon steels.

5.2 Parent metal composition range

5.2.1 Hardness controlled method

The parent metals covered are carbon, carbon manganese and low-alloy steels.

This method is not applicable **to quenched and tempered** steels.

5.2.2 Hydrogen controlled method

This method is particularly useful for high strength, low-alloy steels having quite high hardenability where hardness control is not always feasible.

5.2.3 Selection of method

The following procedure is suggested as a guide for selection of either the hardness control or hydrogen control method.

Determine carbon and carbon equivalent (in %) from the following equation (15):

$$CE = C + \frac{(Mn + Si)}{6} + \frac{(Cr + Mo + V)}{5} + \frac{(Ni + Cu)}{15} \quad (15)$$

to locate the zone position of the steel in Figure 13.

The chemical analysis may be obtained from:

- mill test certificates;
- typical production chemistry (from the mill);
- specification chemistry (using maximum values);
- user tests (chemical analysis).

The performance characteristics of each zone and the suggested action are as follows:

- **Zone I.** Cracking is unlikely, but may occur with high hydrogen content or high restraint. Use the hydrogen control method to determine preheat for steels in this zone.
- **Zone II.** The hardness control method and selected hardness are used to determine the minimum energy input for single-run fillet welds without preheat. If the energy input is not practical, use the hydrogen method to determine preheat. For butt welds, the hydrogen control method is used to determine preheat for steels with high carbon content, a minimum energy to control hardness and preheat to control hydrogen may be required for both types of welds, i.e. fillet and butt welds.
- **Zone III.** The hydrogen control method is used, where heat input is restricted to preserve the HAZ properties (e.g. some quenched and tempered steels), the hydrogen control method should be used to determine preheat.

5.2.4 Hydrogen controlled method

The values of the composition parameters P_{CM} (in %) is calculated from the following equation (16):

$$P_{CM} = C + \frac{Si}{30} + \frac{Mn}{20} + \frac{Cu}{20} + \frac{Ni}{60} + \frac{Cr}{20} + \frac{Mo}{15} + \frac{V}{10} + 5 \times B \quad (16)$$

The chemical analysis is obtained as in 5.2.3

5.3 Plate thickness and joint geometry

5.3.1 HAZ hardness controlled method

The provisions included in this document for use of this method are restricted to fillet welds.

The range of applicability for flange thickness is 6 mm (approximately ¼ in) up to 100 mm (approximately 4 in).

5.3.2 Hydrogen controlled method

This method is mainly based on results of restrained partial joint penetration groove weld tests. There has not been extensive testing of this method on fillet welds; however, by allowing for restraint, the method has been suitably adapted for those welds.

5.4 Hydrogen levels and welding process

5.4.1 HAZ hardness controlled method

The low hydrogen consumables give a diffusible hydrogen content of less than 10 ml/100g deposited metal when measured using EN ISO 3690.

This method is valid for the following welding processes shown in Table 17.

Table 17 — Welding process designations and terminology

Terminology of welding process	EN ISO 4063	previous US abbreviation
Submerged arc welding (SAW)	121	SAW
Manual metal arc welding (MMA)	111	SMAW
Metal active gas welding (MAG)	135	GMAW
Fluxed cored welding (FCAW)	136/137	FCAW

5.4.2 Hydrogen controlled method

The hydrogen level is determined and defined as follows.

- **H1 extra-low hydrogen content.** These consumables give a diffusible hydrogen content of ≤ 5 ml/100g deposited metal when measured according to EN ISO 3690. This may be established by testing each type, brand of consumable, or wire/flux combination used after removal from the package or container and exposure for the intended duration, paying due consideration to the actual storage conditions prior to immediate use. The following may be assumed to meet this requirement.
 - Low-hydrogen electrodes taken from hermetically sealed containers, dried at $370\text{ °C} \leq T \leq 430\text{ °C}$ ($700\text{ °F} \leq T \leq 800\text{ °F}$) for one hour and used within two hours after removal.
 - MAG welding (135) with clean solid wires.
- **H2 low hydrogen content.** These consumables give a diffusible hydrogen content of ≤ 10 ml/100g deposited metal when measured according to EN ISO 3690. This may be established by a test on each type, brand of consumable, or wire/flux combination used. The following may be assumed to meet this requirement.
 - Low-hydrogen electrodes taken from hermetically sealed containers conditioned in accordance with 5.3.2.1 of ANSI/AWS D1.1 and used within four hours after removal.
 - SAW welding (121) with dry flux.
- **H3 hydrogen content not controlled.** All other consumables not meeting the recommendations of H1 or H2.

5.5 Energy input

This energy input applies to submerged arc welds.

For other processes, minimum energy input for single pass fillet welds can be estimated by applying the multiplication factors according to Table 18 to the energy estimated for submerged arc welding (SAW) process

Table 18 — Multiplication factors relating to welding processes

Welding Process	Multiplication factor
SAW (121)	1,00
SMAW (111)	1,50
GMAW (135), FCAW (137)	1,25

The arc energy (AE) (in J/in) is calculated as follows:

$$AE = (I \cdot U) / (\text{travel speed}) \tag{17}$$

Figure 14 may be used to determine the leg length of fillet welds as a function of energy input.

5.6 Special considerations

Because the HAZ hardness controlled method depends solely on controlling the HAZ hardness, the restraint is not explicitly considered.

For the hydrogen controlled method the welds are divided in three levels of restraint.

- **Low restraint.** This level describes common fillet and butt welded joints in which a reasonable freedom of movement of members exists.
- **Medium restraint.** This level describes fillet and butt welded joints in which, because of members being already attached to structural work, a reduced freedom of movement exists.
- **High restraint.** This level describes welds in which there is almost no freedom of movement for members joined (such as repair welds, especially in thick material).

The classification of types of welds at various restraint levels should be determined on the basis of experience, engineering judgement, research, or calculation.

5.7 Determination of minimum preheat

5.7.1 Method according to value of CE

Table 19 — Steps of the method

Step	Terms	Figure/equation
1	Determine CE	equation (15)
2	Locate zone position of the steel	Figure 13
3	Select method according	5.2.3

5.7.2 HAZ hardness controlled method

In this method there is a correlation between the material thickness at the joint (see Figures 15 a) to f)), the heat input and the cooling rate at 540 °C (R_{540}).

Table 20 — Steps of the method

Step	Terms	Figure/Equation
1	Determine CE	equation (15)
2	Determine the heat input of the welding process	
3	Select the correct figure according to the material thickness and estimate the cooling rate	Figure 15 a) to f)
4	Estimate the expected hardness with the cooling rate in relationship to the CE	Figure 12
5	If the expected hardness is ≤ 350 HV consumables with high-hydrogen content may be used. If the expected hardness is ≥ 350 HV and ≤ 400 HV consumables with low-hydrogen content shall be used.	

5.7.3 Hydrogen content controlled method

Table 21 — Steps of the method

Step	Terms	Figure/Equation
1	Calculated the P_{cm} .	equation (16)
2	Select the welding process and estimate the hydrogen content of the weld metal.	
3	Estimate the index grouping using Table 22 including the notes.	Table 22
4	Estimate the minimum preheat and interpass temperatures for the relevant levels of restraint in Table 23.	Table 23

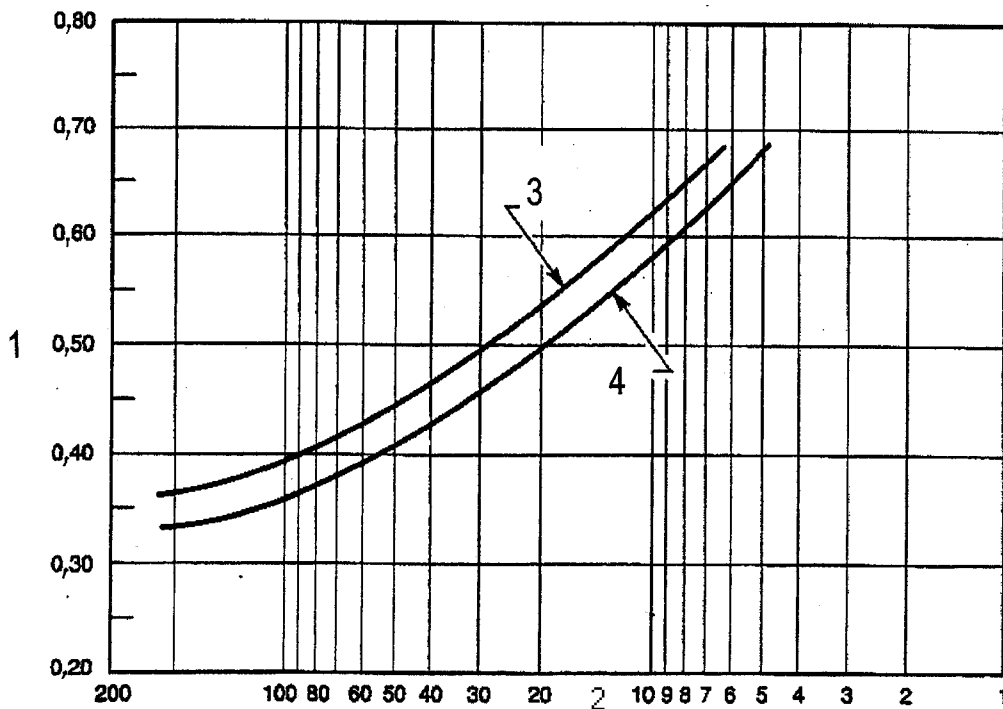

Key

- | | | | |
|---|--|---|--------|
| 1 | Carbon equivalent CE | 3 | 400 HV |
| 2 | R ₅₄₀ in °C/s for HAZ hardness of 350 HV and 400 HV | 4 | 350 HV |

Figure 12 — Critical cooling rate for 350 HV and 400 HV

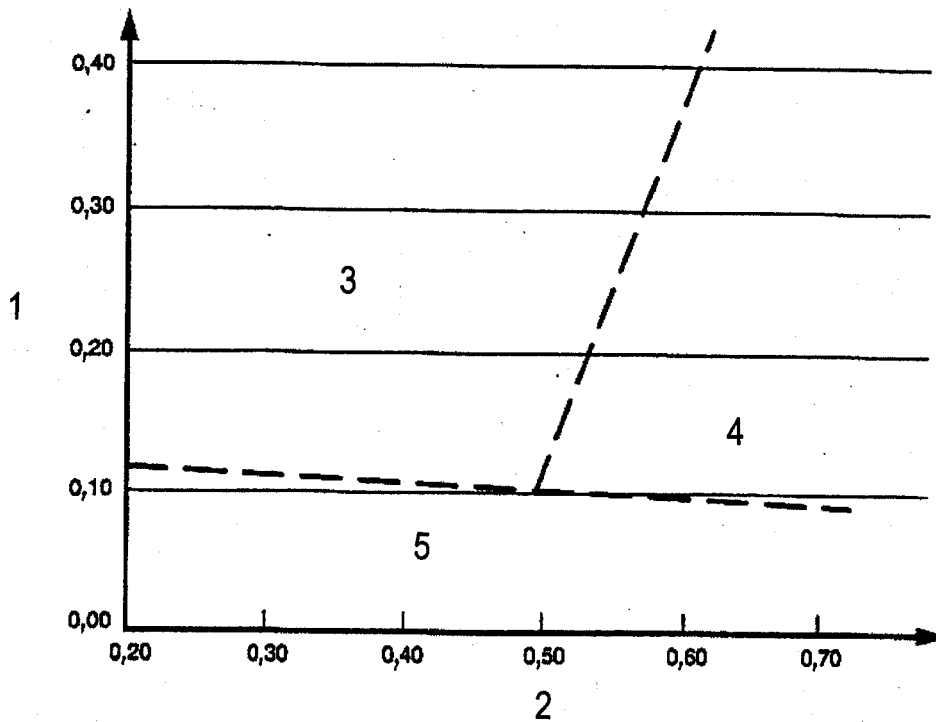

Key

- | | | | |
|---|----------------------|---|----------|
| 1 | Carbon content in % | 3 | Zone II |
| 2 | Carbon equivalent CE | 4 | Zone III |
| | | 5 | Zone I |

Figure 13 — Zone classification of steels

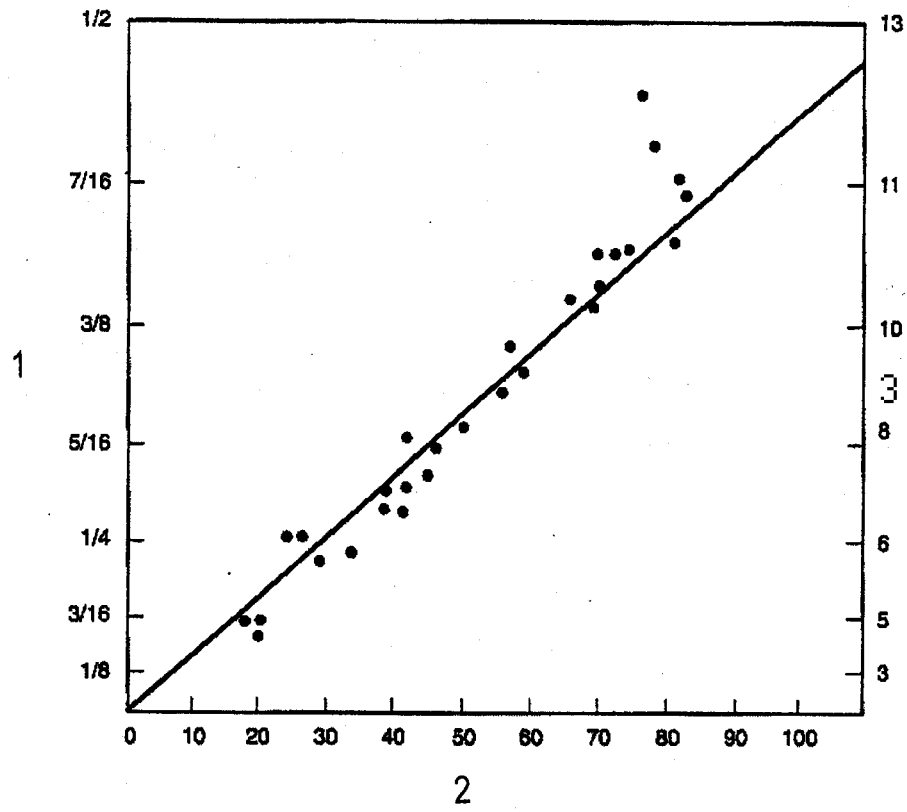

Key

1 Leg length in inch

3 Leg length in mm

2 Average energy input in kJ/inch

Figure 14a) – Shielded metal arc welding (SMAW)

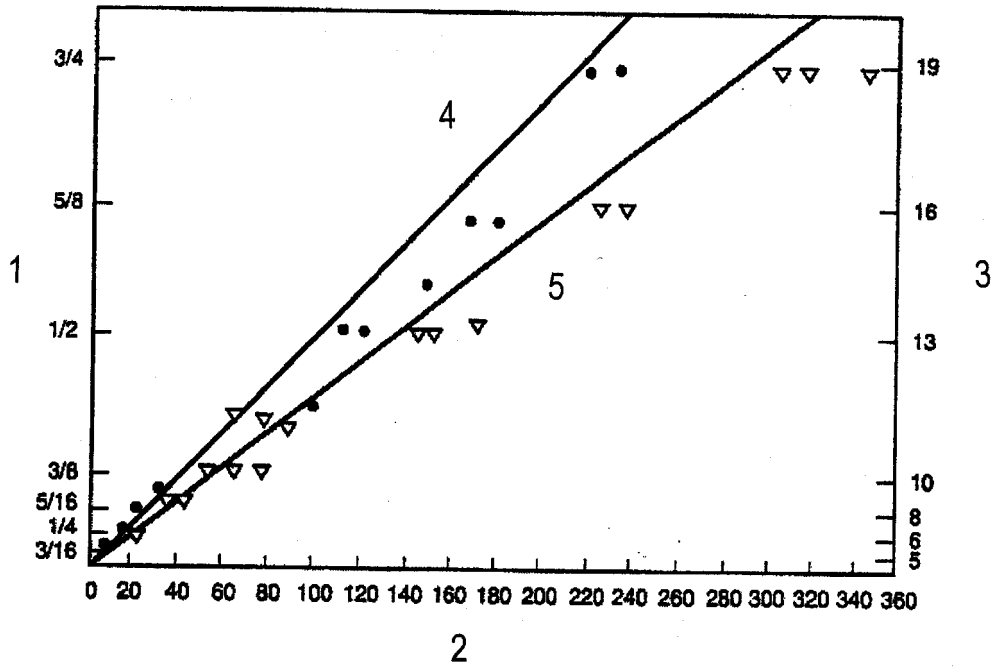

Key

1	Leg length in inch	4	400 HV	●	DCEN
2	Average energy input in kJ/inch	5	350 HV	▽	DCEP
3	Leg length in mm				

Figure 14b) – Submerged arc welding (SAW)

Figure 14 — Relationship between fillet weld size and energy input

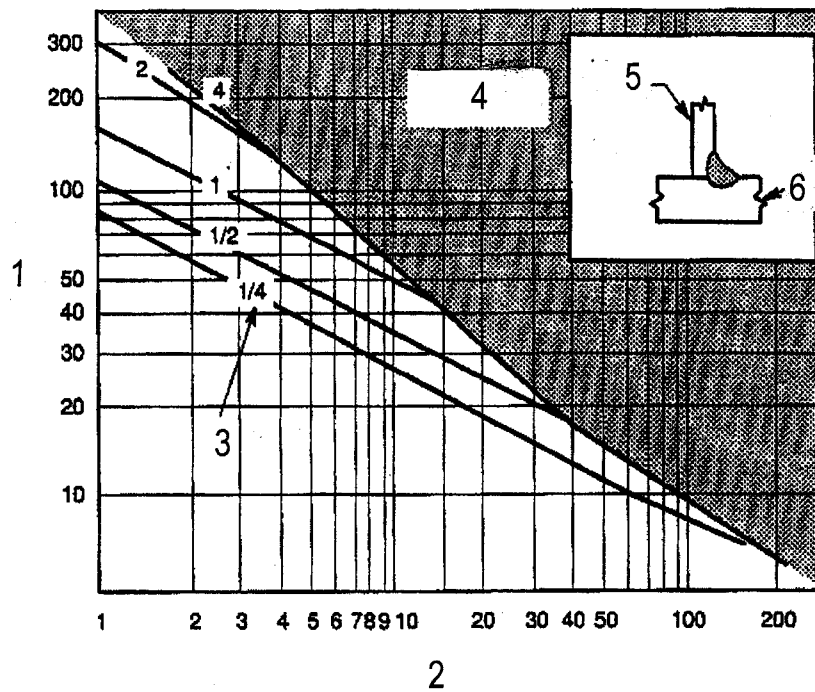

Figure 15a) – Single-pass SAW fillet welds with web and flange of same thickness

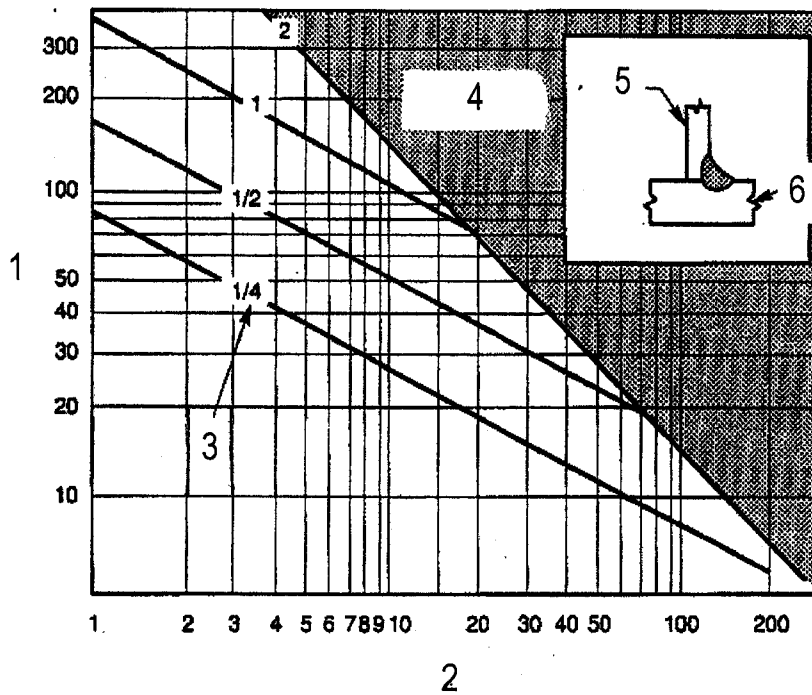

Figure 15b) – Single-pass SAW fillet welds with 1/4 in flanges and varying web thickness

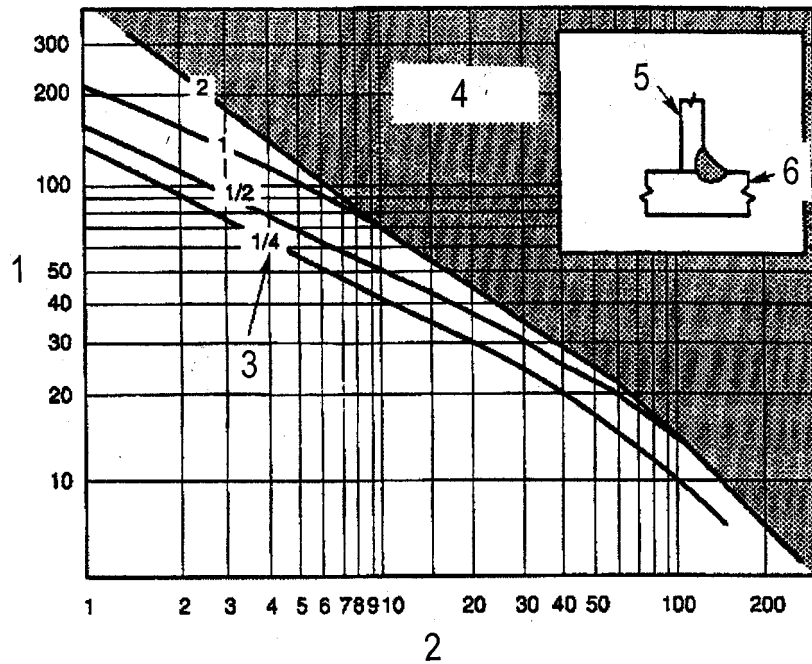

Figure 15c) – Single-pass SAW fillet welds with 1/2 in flanges and varying web thickness

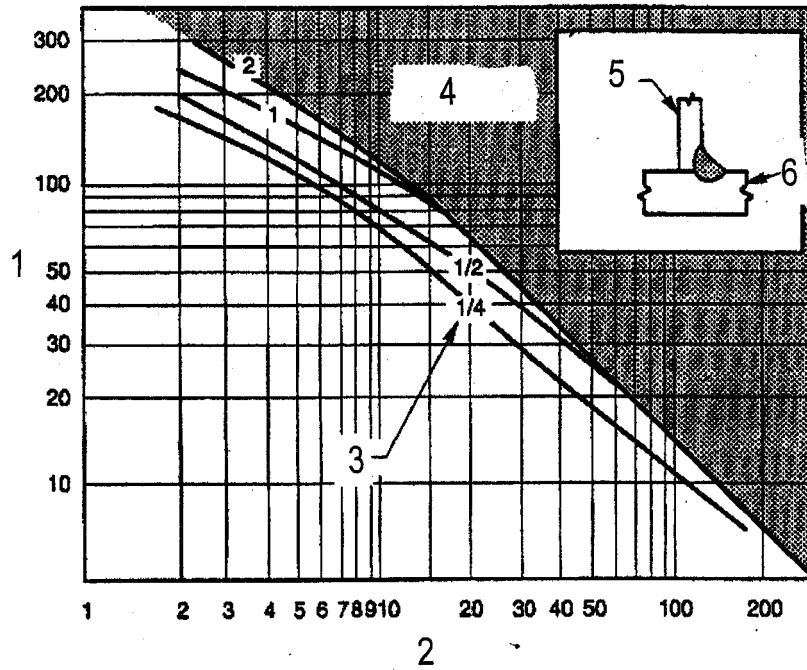

Figure 15d) – Single-pass SAW fillet welds with 1 in flanges and varying web thickness

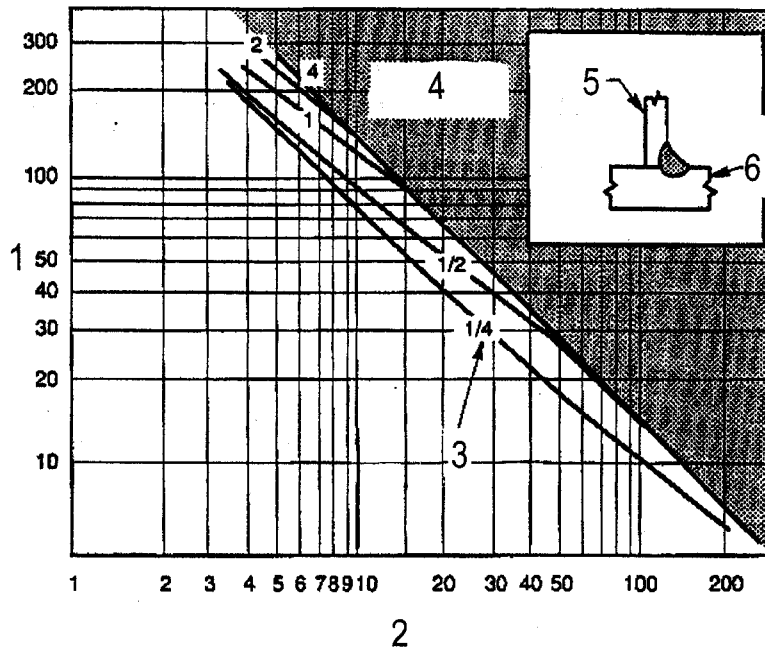

Figure 15e) – Single-pass SAW fillet welds with 2 in flanges and varying web thickness

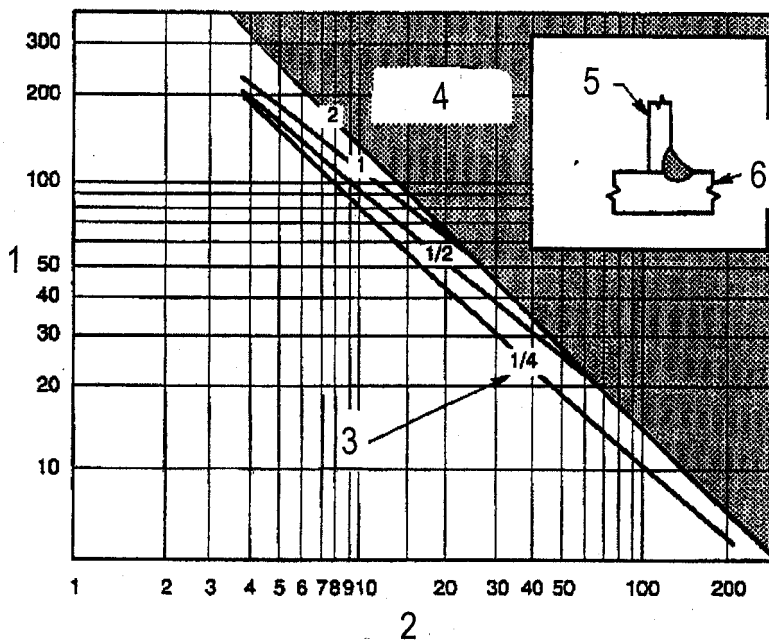

Figure 15f) – Single-pass SAW fillet welds with 4 in flanges and varying web thickness

Key

- | | | | |
|---|--------------------------------|---|----------------------|
| 1 | Energy input in kJ/inch | 4 | Any thickness |
| 2 | Cooling rate at 540 °C in °C/s | 5 | Designated as web |
| 3 | Web thickness | 6 | Designated as flange |

NOTE Energy input determined from chart does not imply suitability for practical applications. For certain combinations of thicknesses melting can occur through the thickness.

Figure 15 — Graphs to determine cooling rates for single-pass submerged arc fillet welds

Table 22 — Susceptibility index grouping as function of hydrogen content level HD and composition parameter P_{cm}

Hydrogen level, HD	Susceptibility index grouping (see NOTE 2)				
	Carbon equivalent = P_{cm}				
	< 0,18	< 0,23	< 0,28	< 0,33	< 0,38
H1	A	B	C	D	E
H2	B	C	D	E	F
H3	C	D	E	F	G

NOTE 1 P_{cm} (in %) is given by:

$$P_{cm} = C + \frac{Si}{30} + \frac{Mn}{20} + \frac{Cu}{20} + \frac{Ni}{60} + \frac{Cr}{20} + \frac{Mo}{15} + \frac{V}{10} + 5 \times B$$

NOTE 2 Susceptibility index = $12 P_{cm} + \log_{10} HD$.

NOTE 3 Susceptibility index groupings, A through G, encompass the combined effect of the composition parameter, P_{cm} and hydrogen level, in accordance with the formula shown in note 2.

The exact numerical quantities are obtained from the Note 2 formula using the stated values of P_{cm} and the followings values of HD , given in ml/100 g of weld metal

$$H\ 1 = 5; H\ 2 = 10; H\ 3 = 30$$

For greater convenience, susceptibility index groupings have been expressed in the table by means of letters, A through G, to cover the following narrow ranges:

$$A = 3,0; B = 3,1\ \text{to}\ 3,5; C = 3,6\ \text{to}\ 4,0; D = 4,1\ \text{to}\ 4,5;$$

$$E = 4,6\ \text{to}\ 5,0; F = 5,1\ \text{to}\ 5,5; G = 5,6\ \text{to}\ 7,0$$

The groupings are used in Table 23 in conjunction with restraint and thickness to determine the minimum preheat and interpass temperature.

Table 23 — Minimum preheat and interpass temperature for three levels of restraint

Restraint	Minimum preheat and interpass temperature (°C)							
	Susceptibility index grouping							
	Thickness ^a mm	A	B	C	D	E	F	G
Low	< 9,5	< 18	< 18	< 18	< 18	60	138	149
	9,5 to 19	< 18	< 18	18	60	99	138	149
	19,1 to 38,1	< 18	< 18	18	79	110	138	149
	38,1 to 76,2	18	18	38	93	121	138	149
	> 76,2	18	18	38	93	121	138	149
Medium	< 9,5	< 18	< 18	< 18	< 18	71	138	160
	9,5 to 19	< 18	< 18	18	79	115	143	160
	19,1 to 38,1	18	18	74	110	138	149	160
	38,1 to 76,2	18	79	110	129	149	149	160
	> 76,2	93	121	138	149	160	160	160
High	< 9,5	< 18	< 18	18	38	110	149	160
	9,5 to 19	< 18	18	66	104	138	160	160
	19,1 to 38,1	18	85	116	138	149	160	160
	38,1 to 76,2	116	129	149	149	160	160	160
	> 76,2	116	129	149	149	160	160	160

^a Thickness is that of the thicker part welded.

Annex A (informative)

Comparison of the different methods

A.1 General

In comparing the methods it is first of all importance to recall their origins.

- The CE -method uses a critical hardness approach based on data predominantly from CTS fillet weld testing using mainly carbon manganese steels but including some low alloy steels.
- The CET -method is an empirical approach based mainly on y-groove testing but incorporates some CTS fillet weld data. Steels tested cover both carbon manganese and low alloy types.
- The CE_N -method is an empirical approach based predominantly on y-groove test data, many of which comes from low alloy steels.
- The P_{cm} -method includes both a critical hardness approach, and a hydrogen control method. The hardness control method is principally for carbon manganese and some low alloy steels, but excludes quenched and tempered steels. The hydrogen control approach is said to be for high hardenability, high strength, low alloy steels where hardness control is not practicable.

A.2 Parent metal composition range

As can be seen in Table A.1, there are some differences in the precise compositional ranges covered, that for the CE_N method probably providing the widest coverage.

Table A.1 — Parent metal composition range

Element	CE	CET	CE_N	P_{cm}
	$0,30 \leq CE \leq 0,70$	$0,20 \leq CET \leq 0,50$	$0,20 \leq CE_N \leq 0,60$	—
C	$\geq 0,05 \leq 0,25$	$\geq 0,05 \leq 0,32$	$\geq 0,02 \leq 0,30$	NS
Si	$\leq 0,8$	$\leq 0,8$	$\leq 0,6$	NS
Mn	$\leq 1,7$	$\geq 0,5 \leq 1,9$	$\leq 2,0$	NS
Cr	$\leq 0,9$	$\leq 1,5$	$\leq 2,5$	NS
Cu	$\leq 1,0$	$\leq 0,7$	$\leq 1,0$	NS
Ni	$\leq 2,5$	$\leq 2,5$	$\leq 3,75$	NS
Mo	$\leq 0,75$	$\leq 0,75$	$\leq 0,75$	NS
V	$\leq 0,20$	$\leq 0,18$	$\leq 0,10$	NS
Nb	NS	$\leq 0,06$	$\leq 0,10$	NS
B	NA	$\leq 0,005$	$\leq 0,0003$	NS
NS = Not specified		NA = Not applicable		

A.3 Plate thickness and joint geometry

The plate thickness ranges covered are similar for CE , CET and P_{cm} with an upper limit of 100 mm, while the upper limit for CE_N is 200 mm.

Both the CE_N - and CET -methods make no fundamental distinction between butt and fillet welds, predicting preheats for butt welds, although some limited guidance on fillet welds is provided by the CET -method. The CE - and the P_{cm} -methods have detailed approaches to providing guidance for fillet welds as well as for butt welds. In certain cases the CE -method results in higher preheat temperatures for fillet welds than for butt welds due to the influence of the combined plate thickness. The P_{cm} -method allows determination of the preheat temperature for fillet welds of certain steels depending on the hardening in the HAZ. For all the other steels the P_{cm} -method does not distinguish between preheating of fillet and butt welds, of the same weld thickness.

A.4 Hydrogen levels

For the CE_N and CET approaches, hydrogen input is via any value, between 1 ml/100 g and 20ml/100 g for CET and a limit is not defined in CE_N . For the CE and P_{cm} approaches, hydrogen input is via a scale or group covering a range of hydrogen levels.

A.5 Heat input

For the CE - and the CE_N -method the heat input for no preheating can be determined for butt welds while for fillet welds the parameters can be determined only by the CE - and P_{cm} -methods. Most of the P_{cm} -method does not take account of heat input. Thus, full advantage of the benefit of increased heat input in reducing HAZ hardness cannot be used with the P_{cm} -method, except for the case of fillet welds and no preheat. For butt welds this point is well illustrated when considering the results at 25 mm, where at 3 kJ/mm, the P_{cm} -method nearly always produces the highest preheat (see Table A.5).

Depending on the carbon equivalent Figure 6 illustrates the influence of the heat input on the preheat temperature for the CET -method. This is similar to the CE_N -method where the heat input up to 4 kJ/mm also influences the preheat temperatures in a certain range depending on the carbon equivalent.

A.6 Prediction comparison

A comparison of the predicted preheats has been made for a range of steel types and composition, for a range of hydrogen levels, plate thicknesses and for butt and fillet welds. Table A.2 gives information about the minimum yield strength, the chemical compositions and the different carbon equivalents of the ten different steels chosen for the comparison. They represent the different types of steels covered by the four methods. These are unalloyed normalized CMn-steels (No. 1 to 3), a low alloyed normalized steel (No 5), TMCR-steels (No. 4,6,7) as well as quenched and tempered steels (No. 8 to 10). The minimum yield strength ranges from 235 MPa to 960 MPa. The result for the full range of conditions for a hydrogen content of 13,6 ml/100g weld metal is presented in Table A.5 for fillet and butt welds. In the CET -method, for example, the preheat temperature for single run fillet welds can be reduced by 60 °C compared to butt welds of the same plate thickness. For multi run fillet welds the same preheat temperatures as for butt welds are recommended due to similar restraint in both types of joint. A more detailed comparison has been made for the same conditions, but for butt welds only in Table A.3 and A.4 as well as graphically in Figures A.1 to A.12.

Compared to the CE -method the CET -method seems to be conservative in the case of mild steels, (see Figure A.1). However with low carbon equivalents ($CE < 0,4 \%$) the minimum preheat temperatures determined from the CE -method are considerably lower than those calculated by the CET -method. On the contrary, for low alloyed steels with higher CE values the CE -method results in higher preheat temperatures than those calculated by the CET -method when applying low heat inputs. This means that in the CE -method an increase of the carbon equivalent has a stronger influence on the minimum preheat temperature than according to the CET -method. As a consequence the CE -method results in lower preheat temperatures from mild steels and higher preheat temperatures for low alloyed steel. Additionally when welding low alloyed steels the range of preheating between low and high heat inputs is distinctly wider than determined by the CET -method. The following examples may show some of the differences between the two methods. As can be seen from Figure A.1b), the CE -method evaluates the influence of the heat input on the preheat temperature much more strongly than the CET -method. This is specially the case when welding low alloyed high strength steels. Figure. A.1c) shows the effect of the hydrogen content, at 1 kJ/mm on the preheat temperature. The CET -method proceeds from a proportional ratio between the carbon equivalent and the hydrogen content. With increasing carbon equivalents the influence of the hydrogen content on the preheat temperature also increased steadily. In the CE -method there is no effect for CE values below 0,45% and a plate thickness less than 25 mm (see Table A.5). Above this CE value there is first of all a

strong dependency of the preheat temperature from the hydrogen content. This ratio becomes smaller with increasing carbon equivalents.

Figure A.2 shows the comparison between the CE_N - and the CET -method. There is quite a good conformity for normalized steels. Looking at high strength steels the CE_N -method tends to predict higher preheat temperatures than the CET -method. According to Figure A.3 the P_{cm} -proposal in most cases, and specially for mild steels, also results in higher preheat temperatures than the CET -method. It is interesting to note that in the P_{cm} -method for butt welds the heat input has no influence on the preheat temperature.

When comparing the CE - and the CE_N -methods, in Figure A.4 the CE -method in general seems to predict the lower preheat temperatures. That becomes quite obvious for mild steels and welding with high heat inputs, where the CE_N -method as the CET -method also might be too conservative. The same result is shown in Figure A.5 between the P_{cm} - and the CE -methods where AWS usually tends to higher preheat temperatures. Figure A.6 shows the comparison of the P_{cm} - and the CE_N -method. It is interesting to see that for mild steels CE_N -method gives the lower preheat temperatures. This alters when welding high strength steels, when the CE_N -method leads to higher preheating.

Figures A.7 to A.12 contain the results for the 50 mm plates. If the preheating for 25 mm and 50 mm plates is compared, there is the expected increase in the preheat temperatures for the thicker plates. However, the fundamental predictions of the different methods do not alter. It should be recognised that the results of the methods should be viewed only as recommendations. Despite the differences between the four methods they should be seen as proposals which may be adopted for the welding procedure test plates (see EN ISO 15614-1). It is the intention to help the user who fabricates a certain steel for the first time to find safe and economic welding conditions. The user should employ the method that best fits his application. The methods should not prevent an experienced fabricator from using lower preheat temperatures than calculated on the basis of one of the four methods subject to this satisfactory practical experience.

A.7 Summary and conclusions

It is clear that there are several distinguishing features to the different methods and these may carry both advantages and disadvantages for the end user, depending on the manner of application. The origins of the different methods, should therefore be considered when seeking a method to use, with the aim of achieving the best alignment of the practical situation and the original test data when making the selection in the anticipation that this will produce the best prediction. It is recommended that whichever method is chosen as providing the best fit to the practical situation, it is used for determining preliminary welding conditions to be subsequently validated by appropriate procedure testing and qualifications.

Table A.2 — Steels used for comparing predicted preheats

Test material		Minimum yield strength (N/mm ²)	Typical chemical composition, %										Carbon equivalents, %				
No	Steel grade		According to standard	C	Si	Mn	Cr	Cu	Mo	Nb	Ni	Ti	V	CE	CET	CE _N	P _{cm}
1	S235J2G3	235	0,08	0,22	0,85	0,02	0,01	0,01	0,01	—	—	—	—	0,23	0,17	0,17	0,13
2	S355N	355	0,15	0,32	1,46	0,02	0,03	0,01	0,031	0,03	0,003	0,10	0,41	0,30	0,39	0,24	
3	S355N	355	0,20	0,32	1,42	0,02	0,02	0,01	0,047	0,03	0,004	0,10	0,45	0,35	0,46	0,29	
4	S355M	355	0,10	0,33	1,38	0,02	0,02	0,01	0,018	0,04	0,022	0,10	0,34	0,24	0,27	0,18	
5	S460N	460	0,18	0,32	1,59	0,03	0,04	0,01	0,010	0,55	0,010	0,080	0,51	0,36	0,50	0,29	
6	S460M	460	0,10	0,22	1,50	0,01	0,25	0,01	0,023	0,25	—	—	0,39	0,27	0,29	0,20	
7	S460M	460	0,07 4	0,24	1,50	0,03	0,01	0,01	0,039	0,21	0,016	0,12	0,35	0,23	0,24	0,16	
8	S690QL	690	0,16	0,26	1,50	0,70	0,01	0,01	0,46	0,80	—	—	0,70	0,41	0,65	0,32	
9	S690QL	690	0,17	0,65	0,90	0,85	0,02	0,45	0,020	0,03	0,020	0,003	0,58	0,35	0,59	0,31	
10	S960QL	960	0,17	0,31	0,80	0,60	0,04	0,42	0,001	1,82	0,001	0,070	0,65	0,37	0,60	0,32	

Table A.3 — Comparison of preheat temperature according to different methods (plate thickness 25 mm)

HD	Q	T _o in °C, Steel 1				T _o in °C, Steel 2				T _o in °C, Steel 3				T _o in °C, Steel 4				T _o in °C, Steel 5							
		CE	CET	CE _N	P _{cm}	CE	CET	CE _N	P _{cm}	CE	CET	CE _N	P _{cm}	CE	CET	CE _N	P _{cm}	CE	CET	CE _N	P _{cm}	CE	CET	CE _N	P _{cm}
3	1	0	-45	-25	18	0	53	-5	85	0	91	65	116	0	8	-25	18	0	98	98	0	20	98	98	116
—	2	0	-68	-25	18	0	37	-25	85	0	77	17	116	0	-11	-25	18	0	85	65	0	0	85	65	116
—	3	0	-91	-25	18	0	21	-25	85	0	64	-25	116	0	-31	-25	18	0	72	15	0	0	72	15	116
7	1	0	-13	-25	18	0	85	85	116	50	122	127	138	0	39	-25	18	0	130	150	0	150	130	150	138
—	2	0	-36	-25	18	0	68	45	116	0	109	105	138	0	20	-25	18	0	117	130	0	0	117	130	138
—	3	0	-59	-25	18	0	52	-25	116	0	95	60	138	0	1	-25	18	0	104	100	0	0	104	100	138
13,6	1	0	19	-25	18	0	117	105	116	100	154	141	149	0	71	-5	85	0	162	162	0	150	162	162	149
—	2	0	-4	-25	18	0	101	70	116	0	141	120	149	0	52	-25	85	0	149	145	0	50	149	145	149
—	3	0	-27	-25	18	0	84	0	116	0	127	85	149	0	33	-25	85	0	136	118	0	0	136	118	149

Table A.3 (concluded)

HD	Q	T _o in °C, Steel 6				T _o in °C, Steel 7				T _o in °C, Steel 8				T _o in °C, Steel 9				T _o in °C, Steel 10							
		CE	CET	CE _N	P _{cm}	CE	CET	CE _N	P _{cm}	CE	CET	CE _N	P _{cm}	CE	CET	CE _N	P _{cm}	CE	CET	CE _N	P _{cm}				
3	1	0	31	-20	18	0	0	-20	18	0,35	0,23	0,24	0,16	0,70	0,41	0,65	0,32	0,58	0,35	0,59	0,31	175	106	170	138
-	2	0	13	-20	18	0	-19	-20	18	0	-19	-20	18	100	126	177	138	0	77	147	138	100	93	160	138
-	3	0	-5	-20	18	0	-39	-20	18	0	-39	-20	18	0	115	166	138	0	64	120	138	0	81	142	138
7	1	0	62	0	85	0	32	-20	18	0	32	-20	18	200	167	210	149	175	122	195	149	200	137	202	149
-	2	0	44	-20	85	0	12	-20	18	0	12	-20	18	150	157	207	149	100	109	185	149	150	125	195	149
-	3	0	27	-20	85	0	-8	-20	18	0	-8	-20	18	50	147	201	149	0	95	167	149	50	112	185	149
13,6	1	0	94	22	116	0	64	-20	85	0	64	-20	85	200	199	217	160	175	154	205	149	200	169	215	149
-	2	0	76	-20	116	0	44	-20	85	0	44	-20	85	150	189	215	160	125	141	195	149	150	157	205	149
-	3	0	59	-20	116	0	24	-20	85	0	24	-20	85	75	179	208	160	0	127	180	149	75	145	192	149

NOTE Carbon equivalents: CE, CET according to EN 1011-2/ISO/TR 17671-2, CE_N according to JIS B8285, P_{cm} according to ANSI/AWS D1.1.

Table A.4 — Comparison of preheat temperature according to different methods (plate thickness 50 mm)

HD	Q	T _o in °C, Steel 1					T _o in °C, Steel 2					T _o in °C, Steel 3					T _o in °C, Steel 4					T _o in °C, Steel 5								
		CE	CET	CE _N	P _{cm}		CE	CET	CE _N	P _{cm}		CE	CET	CE _N	P _{cm}		CE	CET	CE _N	P _{cm}		CE	CET	CE _N	P _{cm}		CE	CET	CE _N	P _{cm}
		0,23	0,17	0,17	0,13		0,41	0,30	0,39	0,24		0,45	0,35	0,46	0,29		0,34	0,24	0,27	0,18		0,51	0,36	0,50	0,29					
3	1	0	0	-25	116	0	98	53	129	129	0	135	105	149	149	0	52	-25	116	116		125	143	133	149					
-	2	0	-23	-25	116	0	81	5	129	129	0	122	72	149	149	0	33	-25	116	116		50	130	109	149					
-	3	0	-46	-25	116	0	65	-25	129	129	0	108	25	149	149	0	14	-25	116	116		0	117	68	149					
7	1	0	31	-25	116	50	129	125	149	149	125	167	155	149	149	0	84	25	116	116		175	174	171	149					
-	2	0	8	-25	116	0	113	95	149	149	50	153	135	149	149	0	65	-25	116	116		150	161	156	149					
-	3	0	-15	-25	116	0	97	35	149	149	0	140	105	149	149	0	45	-25	116	116		100	148	136	149					
13,6	1	0	63	-25	116	100	161	135	149	149	150	199	165	160	160	0	116	60	129	129		200	206	183	160					
-	2	0	40	-25	116	0	145	110	149	149	100	185	150	160	160	0	97	5	129	129		150	193	167	160					
-	3	0	17	-25	116	0	129	62	149	149	20	172	125	160	160	0	77	-25	129	129		125	180	148	160					

Table A.4 (concluded)

HD	Q	T _o in °C, Steel 6				T _o in °C, Steel 7				T _o in °C, Steel 8				T _o in °C, Steel 9				T _o in °C, Steel 10			
		CE	CET	CE _N	P _{cm}	CE	CET	CE _N	P _{cm}	CE	CET	CE _N	P _{cm}	CE	CET	CE _N	P _{cm}	CE	CET	CE _N	P _{cm}
3	1	0	75	-20	116	0	45	-20	116	200	180	204	149	150	135	182	149	200	150	190	149
-	2	0	57	-20	116	0	25	-20	116	175	170	198	149	125	122	170	149	175	138	180	149
-	3	0	40	-20	116	0	5	-20	116	150	160	186	149	75	108	153	149	150	126	170	149
7	1	0	106	58	129	0	76	10	116	225	212	221	160	200	167	210	160	225	182	218	160
-	2	0	89	10	129	0	57	-20	116	200	202	220	160	175	153	202	160	200	169	210	160
-	3	0	71	-20	129	0	37	-20	116	175	191	216	160	150	140	187	160	175	157	202	160
13,6	1	50	139	85	149	0	108	40	129	225	244	226	160	200	199	213	160	225	214	220	160
-	2	0	121	40	149	0	89	-20	129	200	234	224	160	175	185	210	160	200	201	217	160
-	3	0	103	-20	149	0	69	-20	129	175	223	223	160	150	172	197	160	175	189	210	160

NOTE Carbon equivalents: CE, CET according to EN 1011-2/ISO/TR 17671-2, CE_N according to JIS B8285, P_{cm} according to ANSI/AWS D1.1.

Table A.5 — Comparison of minimum preheat temperature (hydrogen level of 13,6 ml/100 g)

d	weld Q	Steel 1					Steel 2					Steel 3					Steel 4					Steel 5								
		CE	CET	CE _N	P _{cm}		CE	CET	CE _N	P _{cm}		CE	CET	CE _N	P _{cm}		CE	CET	CE _N	P _{cm}		CE	CET	CE _N	P _{cm}		CE	CET	CE _N	P _{cm}
mm		0,23	0,17	0,17	0,13		0,40	0,30	0,39	0,24		0,44	0,34	0,46	0,28		0,34	0,24	0,29	0,18		0,49	0,36	0,50	0,28		0,49	0,36	0,50	0,28
25	Butt																													
	Minimum heat input kJ/mm for 20 °C preheat	0,5	–	–	^a	0,85	–	–	^a	1,25	–	–	–	^a	0,5	–	–	–	^a	1,9	–	–	–	–	^a	1,9	–	–	^a	
	1,0	0	19	-25	18	0	117	105	116	100	154	141	149	149	0	71	-5	85	85	150	162	160	149	149	149	20	149	135	149	
	2,0	0	-4	-25	18	0	101	70	116	0	141	120	149	149	0	52	-25	85	85	20	149	135	149	149	20	149	135	149	149	
	3,0	0	-27	-25	18	0	84	0	116	0	127	85	149	149	0	33	-25	85	85	0	136	110	149	149	0	136	110	149	149	
25	Fillet																													
	Minimum heat input kJ/mm for 20 °C preheat	0,65	–	–	^a	1,3	–	–	1,4	2	–	–	1,9	0,65	–	–	–	0,7	2,9	–	–	–	–	–	2,8	175	102	160	149	
	1,0	0	0	-25	18	100	57	105	116	150	94	141	149	149	0	11	-5	85	85	125	89	135	149	149	125	89	135	149	149	
	2,0	0	0	-25	18	0	41	70	116	20	81	120	149	149	0	0	-25	85	85	125	89	135	149	149	125	89	135	149	149	
	3,0	0	0	-25	18	0	24	0	116	0	67	85	149	149	0	0	-25	85	85	20	76	110	149	149	20	76	110	149	149	

^a Beyond range of data.

Table A.5 (continued)

D	weld Q	Steel 6					Steel 7					Steel 8					Steel 9					Steel 10							
		CE	CET	CE _N	P _{cm}	CE	CET	CE _N	P _{cm}	CE	CET	CE _N	P _{cm}	CE	CET	CE _N	P _{cm}	CE	CET	CE _N	P _{cm}	CE	CET	CE _N	P _{cm}	CE	CET	CE _N	P _{cm}
mm		0,38	0,27	0,28	0,20	0,35	0,23	0,28	0,16	0,70	0,41	0,66	0,32	0,58	0,35	0,59	0,31	0,65	0,37	0,60	0,32								
25	Butt																												
	Minimum heat input kJ/mm for 20 °C preheat	0,5	—	—	a	0,5	—	—	a	a	—	—	a	a	—	a	—	a	—	a	—	a	—	a	—	a	—	a	
	1,0	0	94	22	85	0	64	-20	85	200	199	217	149	175	154	205	149	200	169	215	149	200	169	215	149	200	169	215	149
	2,0	0	76	-20	85	0	44	-20	85	150	189	215	149	125	141	195	149	150	157	205	149	150	157	205	149	150	157	205	149
	3,0	0	59	-20	-85	0	24	-20	85	75	179	202	149	0	127	180	149	75	145	192	149	75	145	192	149	75	145	192	149
25	Fillet																												
	Minimum heat input kJ/mm for 20 °C preheat	1	—	—	0,6	1	—	—	0,6	a	—	a	—	a	—	a	—	a	—	a	—	a	—	a	—	a	—	a	
	1,0	50	34	22	85	50	4	-20	85	a	139	217	149	a	94	205	149	a	109	215	149	a	109	215	149	a	109	215	149
	2,0	0	16	-20	85	0	0	-20	85	a	129	215	149	a	81	195	149	a	97	205	149	a	97	205	149	a	97	205	149
	3,0	0	0	-20	85	0	0	-20	85	a	119	201	149	a	67	180	149	a	85	192	149	a	85	192	149	a	85	192	149

^a Beyond range of data.

Table A.5 (continued)

D	weld Q kJ/mm	Steel 1					Steel 2					Steel 3					Steel 4					Steel 5							
		CE	CET	CE _N	P _{cm}	CE	CET	CE _N	P _{cm}	CE	CET	CE _N	P _{cm}	CE	CET	CE _N	P _{cm}	CE	CET	CE _N	P _{cm}	CE	CET	CE _N	P _{cm}	CE	CET	CE _N	P _{cm}
mm		0,23	0,17	0,17	0,13	0,40	0,30	0,39	0,24	0,44	0,34	0,46	0,28	0,34	0,24	0,29	0,18	0,49	0,36	0,50	0,28								
50	Butt																												
	Minimum heat input kJ/mm for 20 °C preheat	0,65	—	—	^a	1,5	—	—	^a	2,6	—	—	^a	0,65	—	—	3,75	—	—	—	^a								
	1,0	0	63	-25	116	100	161	135	149	150	199	165	160	0	116	60	129	175	206	177	160								
	2,0	0	40	-25	116	0	145	110	149	100	185	150	160	0	97	5	129	150	193	160	160								
	3,0	0	17	-25	116	0	129	62	149	20	172	125	160	0	77	-25	129	100	180	145	160								
50	Fillet																												
	Minimum heat input kJ/mm for 20 °C preheat	0,65	—	—	^a	1,5	—	—	1,4	3,3	—	—	1,9	0,65	—	—	5,65	—	—	—	2,8								
	1,0	0	3	-25	116	100	101	135	149	150	139	165	160	0	56	60	129	175	146	177	160								
	2,0	0	0	-25	116	0	85	110	149	100	125	150	160	0	37	5	129	150	133	160	160								
	3,0	0	0	-25	116	0	69	62	149	20	112	125	160	0	17	-25	129	125	120	145	160								

^a Beyond range of data.

Table A.5 (concluded)

		Steel 6					Steel 7					Steel 8					Steel 9					Steel 10								
D	weld Q	CE	CET	CE _N	P _{cm}	CE	CET	CE _N	P _{cm}	CE	CET	CE _N	P _{cm}	CE	CET	CE _N	P _{cm}	CE	CET	CE _N	P _{cm}	CE	CET	CE _N	P _{cm}	CE	CET	CE _N	P _{cm}	
mm	kJ/mm	0,38	0,27	0,28	0,20	0,35	0,23	0,28	0,16	0,70	0,41	0,66	0,32	0,58	0,35	0,59	0,31	0,65	0,37	0,60	0,32									
50	Butt																													
	Minimum heat input kJ/mm for 20 °C preheat	1,15	—	—	^a	1,15	—	—	^a	a	—	—	a	—	—	—	a	a	—	—	—	a	—	—	—	—	—	—	a	
	1,0	50	139	85	129	0	108	40	129	225	244	220	160	200	199	213	160	225	214	220	160	200	175	185	210	160	200	201	217	160
	2,0	0	121	40	129	0	89	-20	129	200	234	217	160	175	185	210	160	200	201	217	160	175	185	210	160	200	201	217	160	
	3,0	0	103	-20	129	0	69	-20	129	175	223	213	160	150	172	197	160	175	189	210	160	175	189	210	160	175	189	210	160	
50	Fillet																													
	Minimum heat input kJ/mm for 20 °C preheat	1,15	—	—	0,6	1,15	—	—	0,6	a	—	—	a	a	—	—	a	a	—	—	—	a	—	—	—	a	—	—	a	
	1,0	50	69	85	129	50	48	40	129	184	184	220	160	139	139	213	160	154	154	220	160	154	154	220	160	154	154	220	160	
	2,0	0	61	40	129	0	29	-20	129	a	174	217	160	a	125	210	160	a	141	217	160	a	141	217	160	a	141	217	160	
	3,0	0	43	-20	129	0	9	-20	129	a	163	213	160	a	112	197	160	a	129	210	160	a	129	210	160	a	129	210	160	

^a Beyond range of data.

NOTE (to Figures A.1 to A.12 (without A.1b) and A.1c)) The diagrams show only the final results of the calculated preheating temperatures about the different methods for the selected steels without differentiation with regard to the heat-input or hydrogen contents. Figures A.1 to A.6 refer to 25 mm plate thickness and Figures A.7 to A.12 refer to 50 mm plate thickness. The accurate values of preheating temperatures relating to heat input and hydrogen content are given in Table A.3 for 25 mm plate thickness and Table A.4 for 50 mm plate thickness.

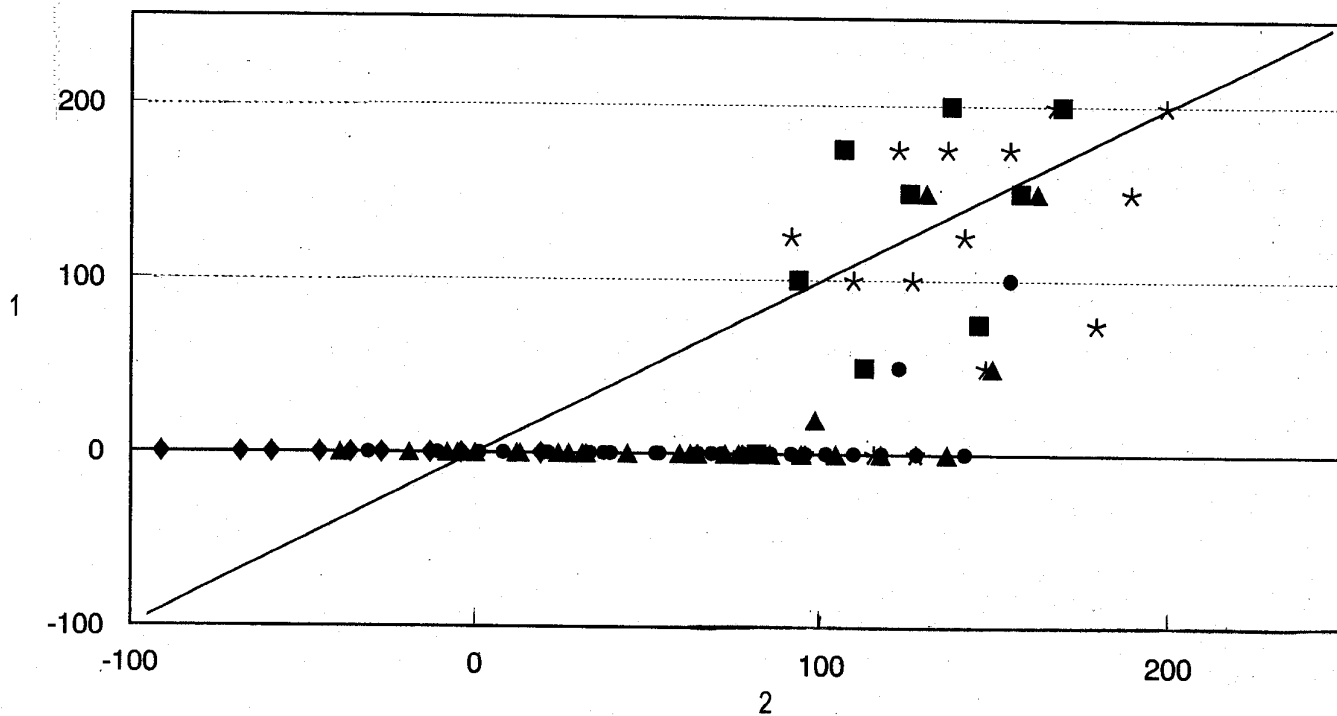

Heat input $Q = 1, 2$ and 3 kJ/mm
 Hydrogen content $HD = 3, 7$ and $13,6$ ml/100g

Key

- | | | | |
|---|---|---|----------|
| 1 | T_0 according to <i>CE</i> -method | ● | YS = 355 |
| 2 | T_0 according to the <i>CET</i> -method | ★ | YS = 690 |
| | | ■ | YS = 960 |
| | | ◆ | YS = 235 |

Figure A.1a) – General

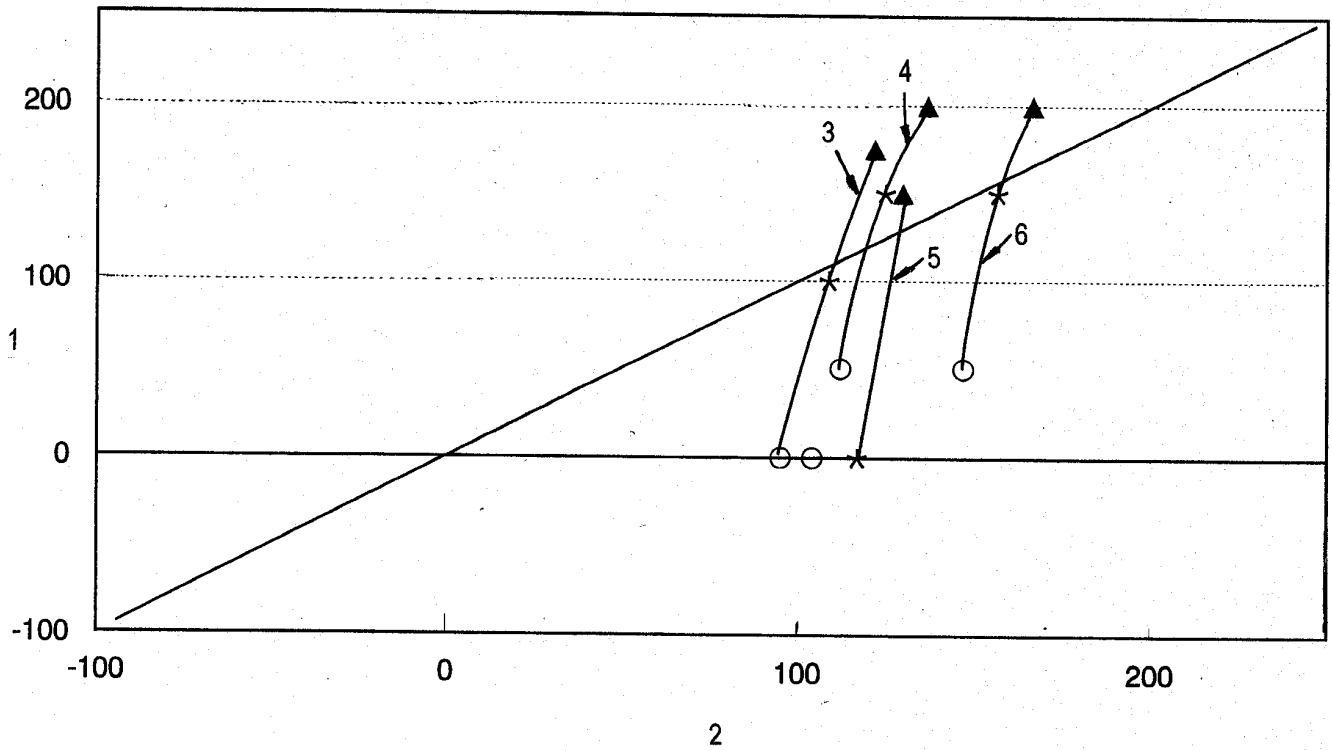

Hydrogen content $HD = 7\text{ml}/100\text{ g}$

Key

- | | | | |
|---|---------------------------------------|---|----------------------|
| 1 | T_0 according to <i>CE</i> -method | ▲ | $Q = 1\text{ kJ/mm}$ |
| 2 | T_0 according to <i>CET</i> -method | ★ | $Q = 2\text{ kJ/mm}$ |
| 3 | Steel No. 9 | ○ | $Q = 3\text{ kJ/mm}$ |
| 4 | Steel No. 10 | | |
| 5 | Steel No. 5 | | |
| 6 | Steel No. 8 | | |

Figure A.1b) – Influence of heat input

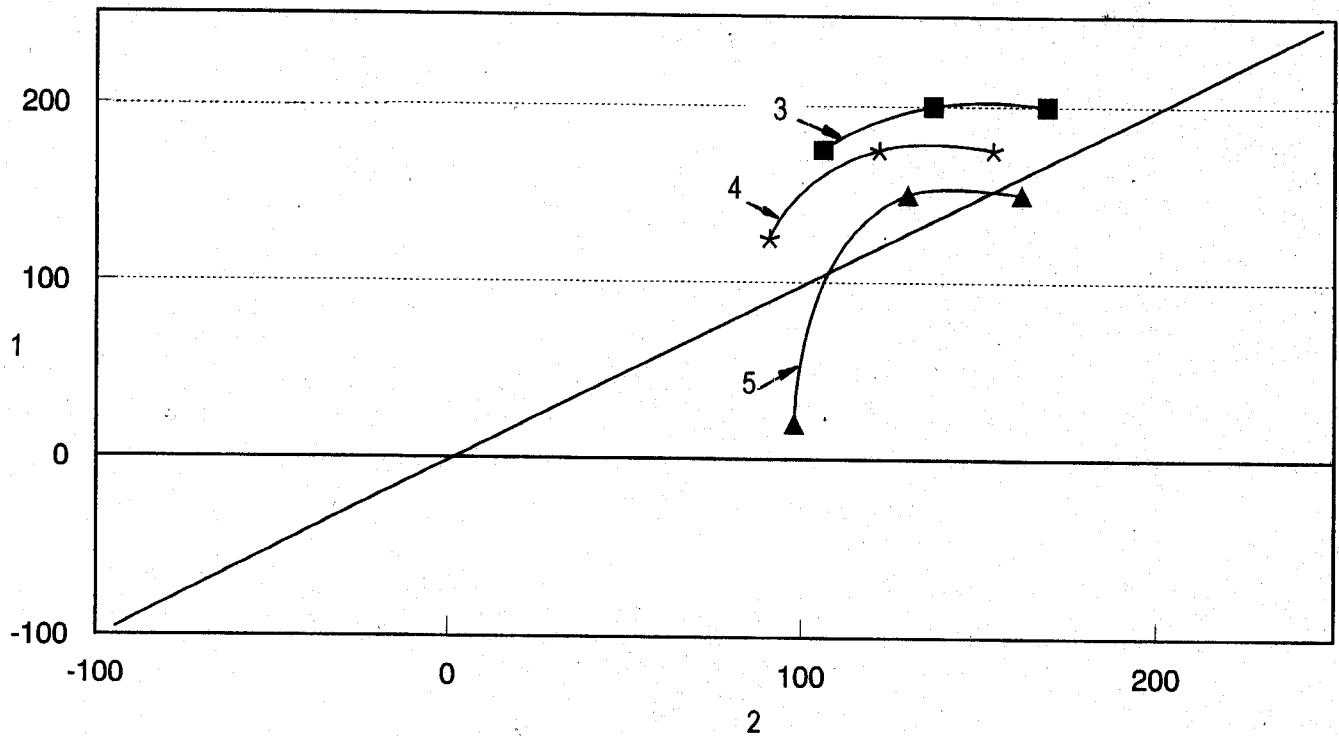

Heat input $Q = 1 \text{ kJ/mm}$
 $HD = 3, 7 \text{ and } 13,6$

- Key**
- | | | | |
|---|---------------------------------------|---|----------|
| 1 | T_0 according to <i>CE</i> -method | ▲ | YS = 460 |
| 2 | T_0 according to <i>CET</i> -method | ☆ | YS = 690 |
| 3 | Steel No. 10 | ■ | YS = 960 |
| 4 | Steel No. 9 | | |
| 5 | Steel No. 5 | | |

Figure A.1c) – Influence of hydrogen content

Figure A.1 — Comparison of preheat temperature T_0 according to *CE*- and *CET*-methods; plate thickness 25 mm

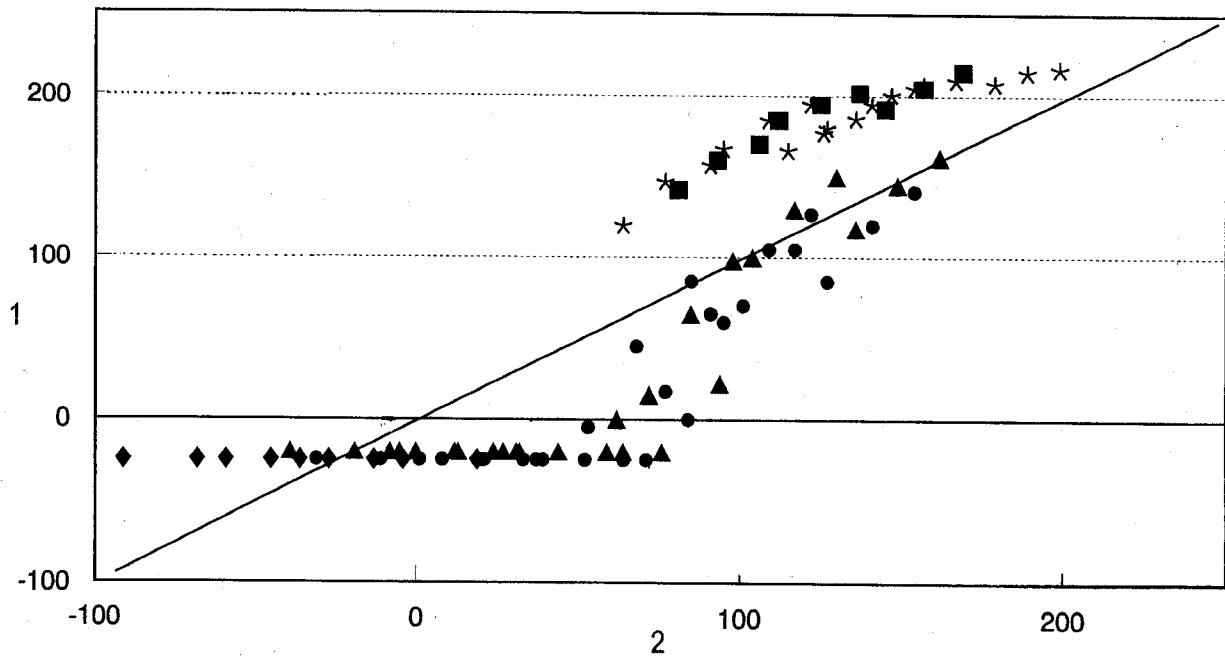

Heat input $Q = 1, 2$ and 3 kJ/mm
 Hydrogen content $HD = 3, 7$ and $13,6$ ml/100g

Key

- | | | | |
|---|-----------------------------------|---|----------|
| 1 | T_0 according to CE_N -method | ▲ | YS = 460 |
| 2 | T_0 according to CET -method | ☆ | YS = 690 |
| | | ■ | YS = 960 |
| | | ◆ | YS = 235 |
| | | ● | YS = 355 |

Figure A.2 — Comparison of preheat temperature T_0 according to CE_N - and CET -methods; plate thickness 25 mm

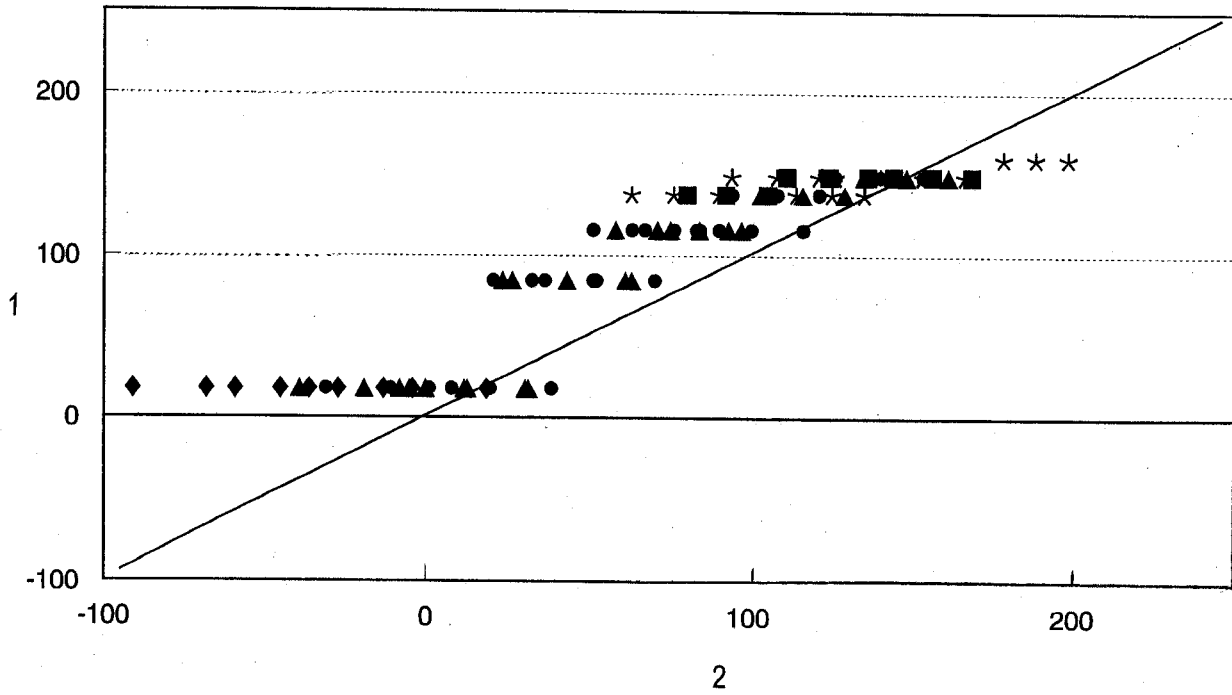

Heat input $Q = 1, 2$ and 3 kJ/mm
 Hydrogen content $HD = 3, 7$ and $13,6$ ml/100g

- Key**
- | | | | |
|---|-------------------------------------|---|----------|
| 1 | T_0 according to P_{cm} -method | ▲ | YS = 460 |
| 2 | T_0 according to CET -method | ☆ | YS = 690 |
| | | ■ | YS = 960 |
| | | ◆ | YS = 235 |
| | | ● | YS = 355 |

Figure A.3 — Comparison of preheat temperature T_0 according to P_{cm} - and CET -methods; plate thickness 25 mm

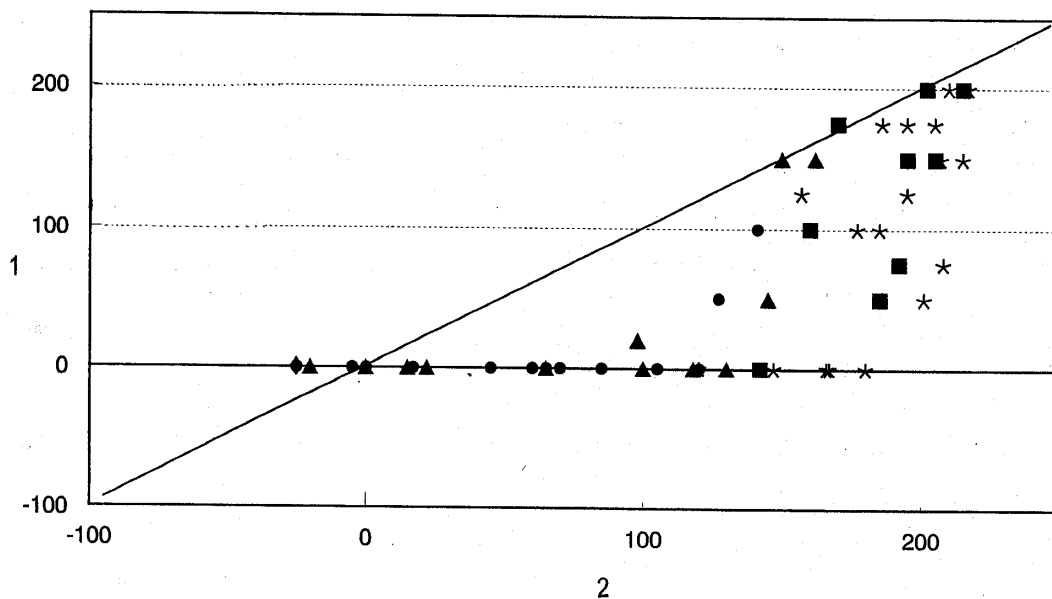

Heat input $Q = 1, 2$ and 3 kJ/mm
 Hydrogen content $HD = 3, 7$ and $13,6$ ml/100g

Key

- 1 T_0 according to CE -method ▲ YS = 460 ◆ YS = 235 ■ YS = 960
- 2 T_0 according to CE_N -method ☆ YS = 690 ● YS = 355

Figure A.4 — Comparison of preheat temperature T_0 according to CE - and CE_N -methods; plate thickness 25 mm

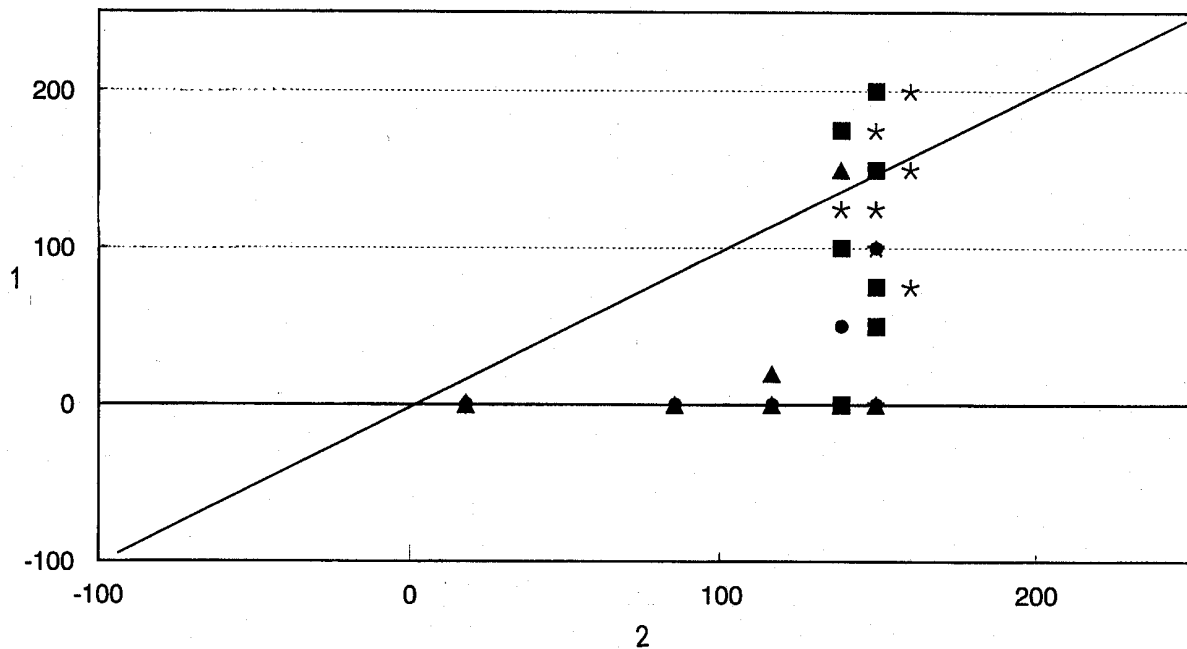

Heat input $Q = 1, 2$ and 3 kJ/mm
 Hydrogen content $HD = 3, 7$ and $13,6$ ml/100g

Key

- 1 T_0 according to CE -method ▲ YS = 460 ■ YS = 960 ● YS = 355
- 2 T_0 according to P_{cm} -method ☆ YS = 690 ◆ YS = 235

Figure A.5 — Comparison of preheat temperature T_0 according to CE - and P_{cm} -methods; plate thickness 25 mm

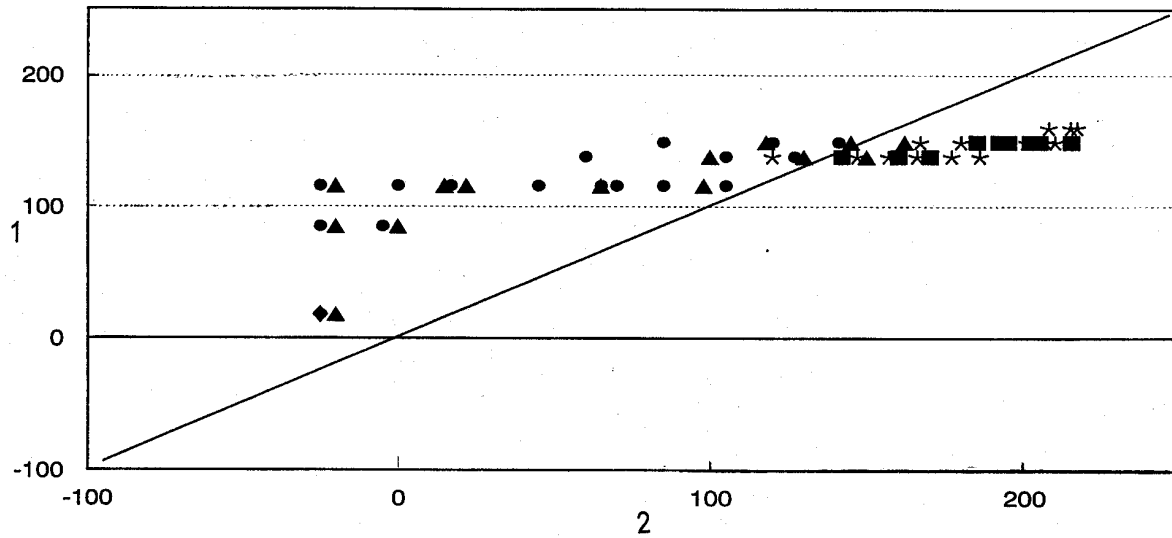

Heat input $Q = 1, 2$ and 3 kJ/mm
 Hydrogen content $HD = 3, 7$ and $13,6$ ml/100g

Key

- | | | | | | | | |
|---|-------------------------------------|---|----------|---|----------|---|----------|
| 1 | T_0 according to P_{cm} -method | ▲ | YS = 460 | ■ | YS = 960 | ● | YS = 355 |
| 2 | T_0 according to CE_N -method | ☆ | YS = 690 | ◆ | YS = 235 | | |

Figure A.6 — Comparison of preheat temperature T_0 according to P_{cm} - and CE_N -methods; plate thickness 25 mm

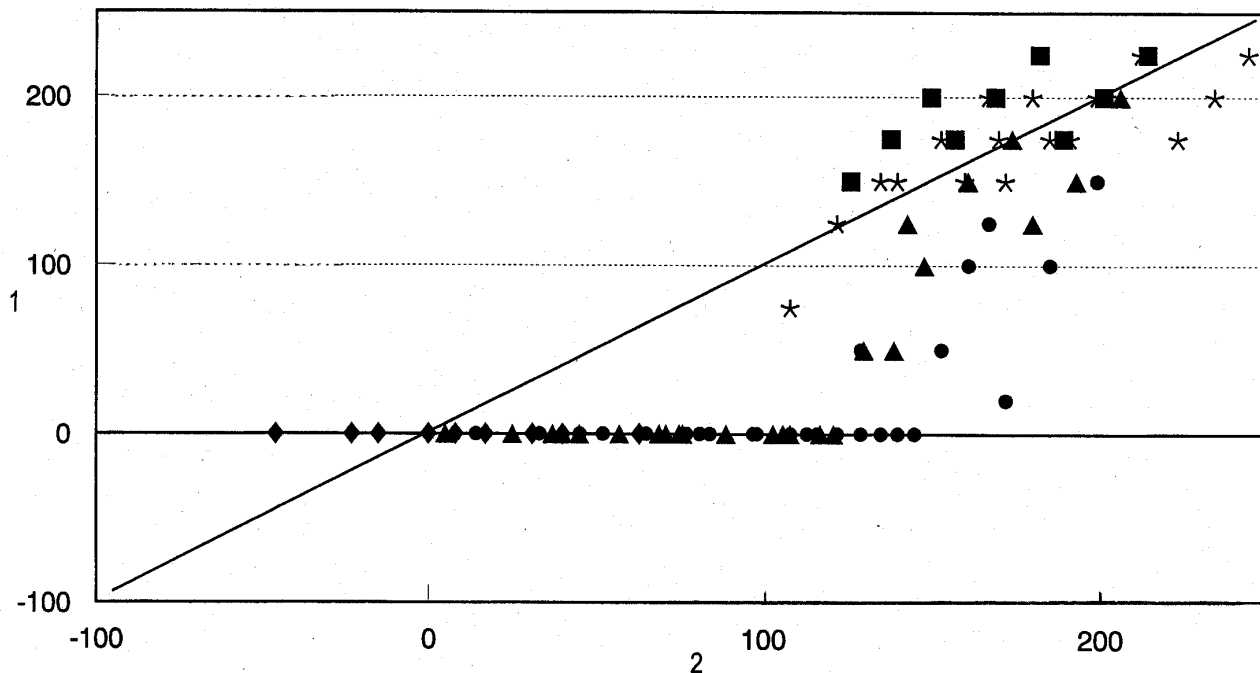

Heat input $Q = 1, 2$ and 3 kJ/mm
 Hydrogen content $HD = 3, 7$ and $13,6$ ml/100g

Key

- | | | | |
|---------------------------------|------------|------------|------------|
| 1 T_0 according to CE-method | ▲ YS = 460 | ■ YS = 960 | ● YS = 355 |
| 2 T_0 according to CET-method | ★ YS = 690 | ◆ YS = 235 | |

Figure A.7 — Comparison of preheat temperature T_0 according to CE- and CET-methods; plate thickness 50 mm

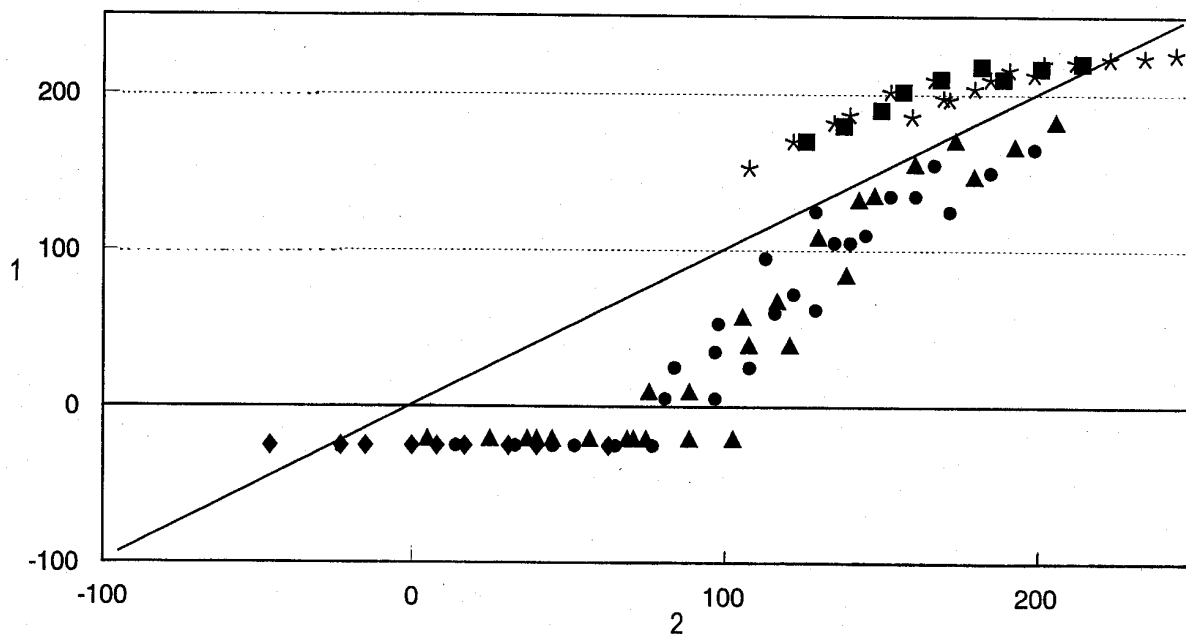

Heat input $Q = 1, 2$ and 3 kJ/mm
 Hydrogen content $HD = 3, 7$ and $13,6$ ml/100g

Key

- | | | | |
|-------------------------------------|------------|------------|------------|
| 1 T_0 according to CE_N -method | ▲ YS = 460 | ■ YS = 960 | ● YS = 355 |
| 2 T_0 according to CET-method | ★ YS = 690 | ◆ YS = 235 | |

Figure A.8 — Comparison of preheat temperature T_0 according to CE_N - and CET-methods; plate thickness 50 mm

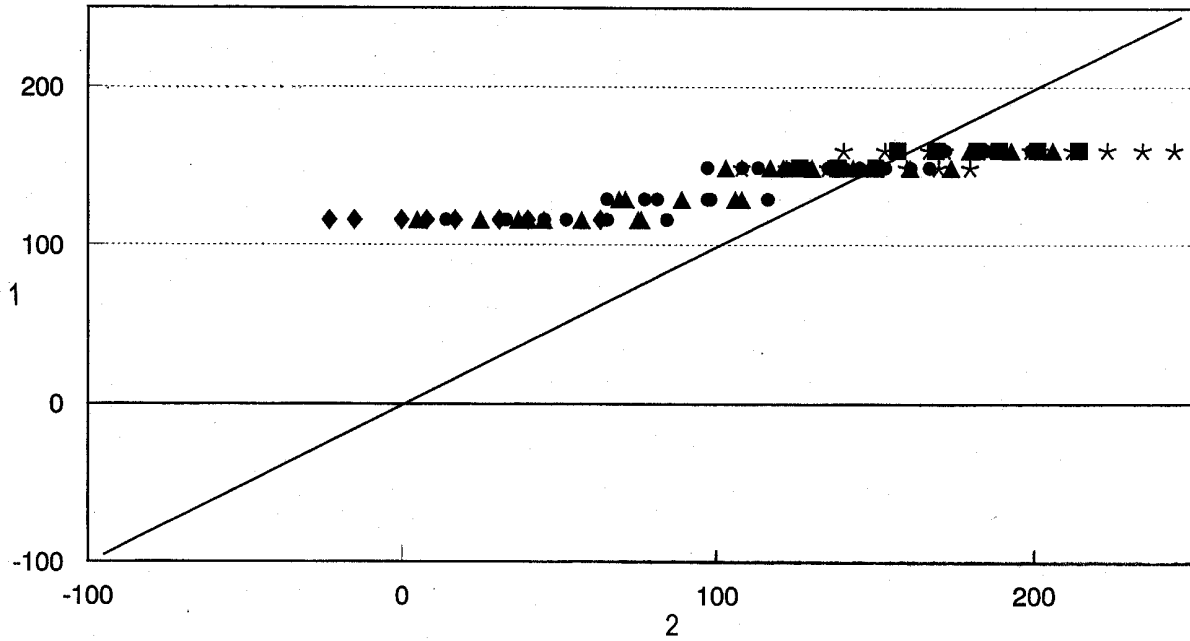

Heat input $Q = 1, 2$ and 3 kJ/mm
 Hydrogen content $HD = 3, 7$ and $13,6$ ml/100g

Key

- | | | | |
|---------------------------------------|------------|------------|------------|
| 1 T_0 according to P_{cm} -method | ▲ YS = 460 | ■ YS = 960 | ● YS = 355 |
| 2 T_0 according to CET -method | ★ YS = 690 | ◆ YS = 235 | |

Figure A.9 — Comparison of preheat temperature T_0 according to P_{cm} - and CET -methods; plate thickness 50 mm

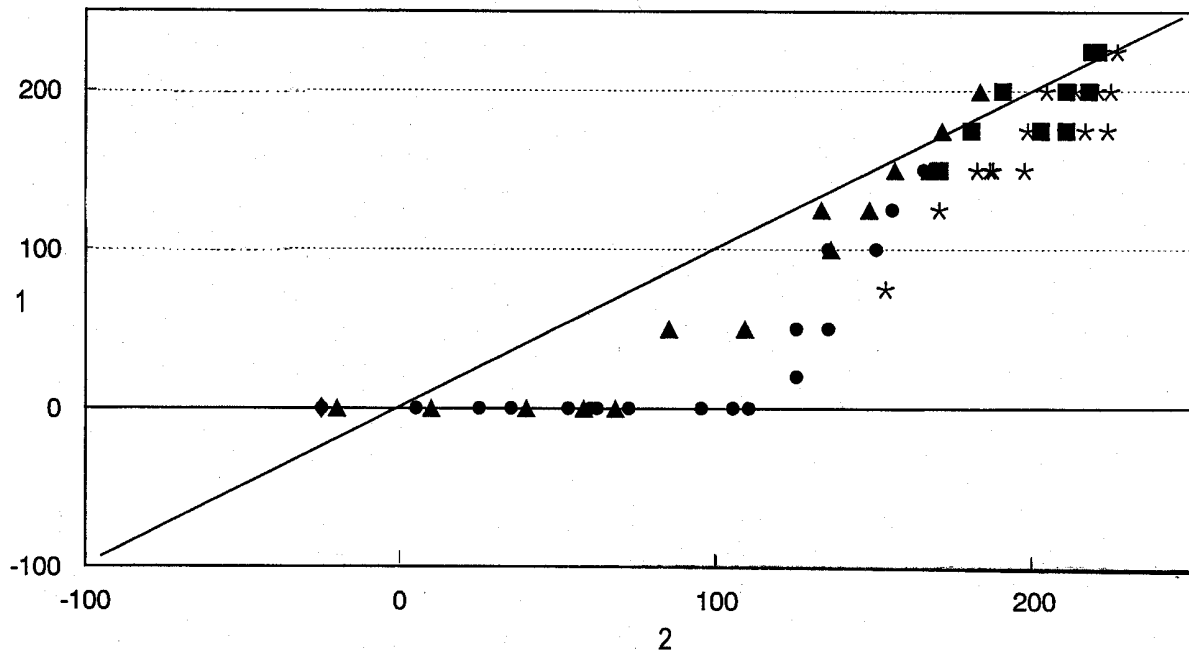

Heat input $Q = 1, 2$ and 3 kJ/mm
 Hydrogen content $HD = 3, 7$ and $13,6$ ml/100g

Key

- | | | | |
|-------------------------------------|------------|------------|------------|
| 1 T_0 according to CE -method | ▲ YS = 460 | ■ YS = 960 | ● YS = 355 |
| 2 T_0 according to CE_N -method | ★ YS = 690 | ◆ YS = 235 | |

Figure A.10 — Comparison of preheat temperature T_0 according to CE - and CE_N -methods; plate thickness 50 mm

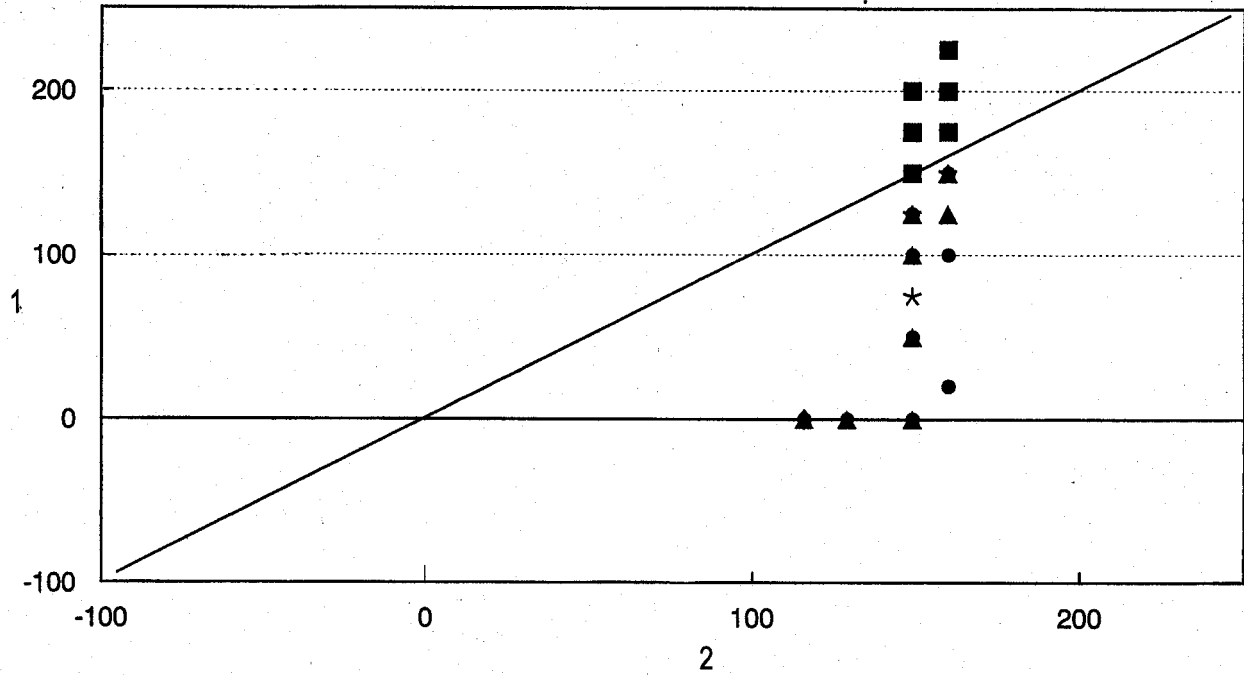

Heat input $Q = 1, 2$ and 3 kJ/mm
 Hydrogen content $HD = 3, 7$ and $13,6$ ml/100g

Key

- | | | | | | | | |
|---|-------------------------------------|---|----------|---|----------|---|----------|
| 1 | T_0 according to CE-method | ▲ | YS = 460 | ■ | YS = 960 | ● | YS = 355 |
| 2 | T_0 according to P_{cm} -method | ☆ | YS = 690 | ◆ | YS = 235 | | |

Figure A.11 — Comparison of preheat temperature T_0 according to CE- and P_{cm} -methods; plate thickness 50 mm

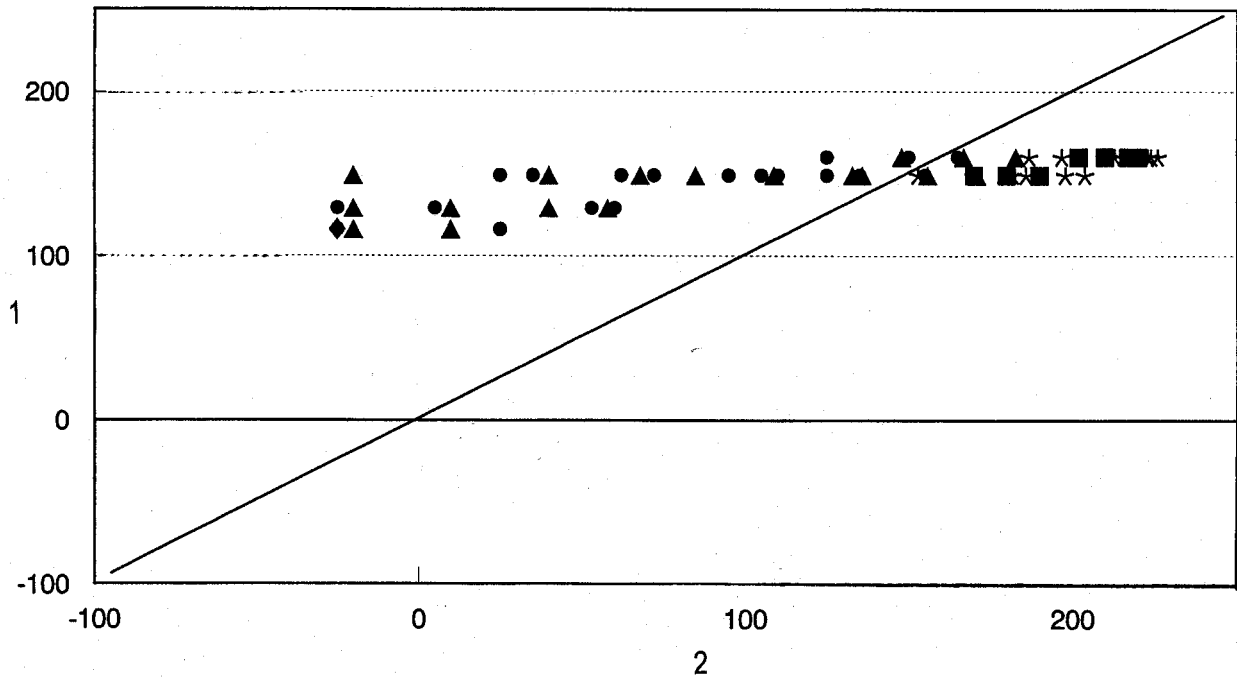

Heat input $Q = 1, 2$ and 3 kJ/mm
 Hydrogen content $HD = 3, 7$ and $13,6$ ml/100g

Key
 1 T_0 according to P_{cm} -method ▲ YS = 460 ■ YS = 960 ● YS = 355
 2 T_0 according to CE_N -method ☆ YS = 690 ◆ YS = 235

Figure A.12 — Comparison of preheat temperature T_0 according to P_{cm} - and CE_N -methods; plate thickness 50 mm

Annex B (informative)

Abbreviations

Symbol	Term	Unit
<i>B</i>	basic covering	–
<i>CE, CET, CE_N, P_{cm}</i>	carbon equivalent	%
<i>d</i>	plate thickness	mm
<i>HAZ</i>	heat affected zone	–
<i>HD</i>	hydrogen content	ml/100g
<i>I</i>	current	A
<i>k</i>	heat transfer efficiency	–
<i>PHT</i>	Post weld heat treatment	° C
<i>Q</i>	heat input	kJ/mm
<i>R</i>	rutile covering	–
<i>RR</i>	rutile thick covering	–
<i>R₅₄₀</i>	Cooling rate	° C/s
<i>i</i>	interpass temperature	° C
<i>T_o</i>	preheat temperature	° C
<i>T_p</i>	preheat temperature	° C
<i>U</i>	voltage	V
<i>v</i>	travel speed	mm/s
<i>YS</i>	yield strength	N/mm ²

Bibliography

- EN 499, *Welding consumables – Covered electrodes for manual metal arc welding of non alloy and fine grain steels – Classification.*
- EN 1011-1, *Welding – Recommendations for welding of metallic materials – Part 1: General guidance for arc welding.*
- EN 1011-2:2001, *Welding – Recommendations for welding of metallic materials – Part 2: Arc welding of ferritic steels.*
- EN 10025, *Hot rolled products of non-alloy structural steels – Technical delivery conditions (includes amendment A1:1993).*
- EN 10113-2, *Hot-rolled products in weldable fine grain structural steels– Part 2: Delivery conditions for normalized rolled steels.*
- EN 10113-3, *Hot-rolled products in weldable fine grain structural steels – Part 3: Delivery conditions for thermomechanically rolled steels.*
- EN 10137-2, *Plates and wide flats made of high yield strength structural steels in the quenched and tempered or precipitation hardened conditions – Part 2: Delivery conditions for quenched and tempered steels.*
- EN ISO 3690, *Welding and allied processes – Determination of hydrogen content in ferritic arc weld metal (ISO 3690:2000).*
- EN ISO 4063, *Welding and allied processes – Nomenclature of processes and reference numbers (ISO 4063:1998).*
- EN ISO 6947, *Welds – Working positions – Definitions of angles of slope and rotation (ISO 6947:1993).*
- EN ISO 15614-1, *Specification and qualification of welding procedures for metallic materials – Welding procedure test – Part 1: Arc and gas welding of steels and arc welding of nickel and nickel alloys (ISO 15614-1:2004).*
- ISO 2560, *Welding consumables – Covered electrodes for manual metal arc welding of non-alloy and fine grain steels – Classification.*
- ISO/TR 17671-1, *Welding – Recommendations for welding of metallic materials – Part 1: General guidance for arc welding.*
- ISO/TR 17671-2:2002, *Welding – Recommendations for welding of metallic materials – Part 2: Arc welding of ferritic steels.*
- CR ISO 15608:2000, *Welding – Guidelines for a metallic material grouping system (ISO/TR 15608:2000).*
- ANSI/AWS D 1.1, *Structural Welding Code – Steel.*
- JIS B 8285, *Welding procedure qualification test for pressure vessels.*
- JIS Z 3118, *Method of measurement for hydrogen evolved from steel welds.*
- SEW 088, *Schweißgeeignete Feinkornbaustähle – Richtlinien für die Verarbeitung, besonders für das Schmelzschweißen / Achtung: Enthält Beiblatt 1 und Beiblatt 2.*
- IIW Doc IX-1630-91, *Characterization of the cold cracking behaviour of steels during welding.*
- IIW Doc IX-1631-91, *Determination of suitable minimum preheating temperatures for cold crack-free welding of steels.*

1

ICS 25.160.10

Price based on 72 pages