

INTERNATIONAL STANDARD

ISO 13715

Second edition
2000-06-15

Technical drawings — Edges of undefined shape — Vocabulary and indications

*Dessins techniques — Arêtes de forme non définie — Vocabulaire et
indications sur les dessins*



Reference number
ISO 13715:2000(E)

© ISO 2000

PDF disclaimer

This PDF file may contain embedded typefaces. In accordance with Adobe's licensing policy, this file may be printed or viewed but shall not be edited unless the typefaces which are embedded are licensed to and installed on the computer performing the editing. In downloading this file, parties accept therein the responsibility of not infringing Adobe's licensing policy. The ISO Central Secretariat accepts no liability in this area.

Adobe is a trademark of Adobe Systems Incorporated.

Details of the software products used to create this PDF file can be found in the General Info relative to the file; the PDF-creation parameters were optimized for printing. Every care has been taken to ensure that the file is suitable for use by ISO member bodies. In the unlikely event that a problem relating to it is found, please inform the Central Secretariat at the address given below.

© ISO 2000

All rights reserved. Unless otherwise specified, no part of this publication may be reproduced or utilized in any form or by any means, electronic or mechanical, including photocopying and microfilm, without permission in writing from either ISO at the address below or ISO's member body in the country of the requester.

ISO copyright office
Case postale 56 • CH-1211 Geneva 20
Tel. + 41 22 749 01 11
Fax + 41 22 749 09 47
E-mail copyright@iso.ch
Web www.iso.ch

Printed in Switzerland

Contents

Page

Foreword.....	iv
Introduction	v
1 Scope	1
2 Normative references	1
3 Terms and definitions	1
4 Indications on drawings	4
5 Examples	9
Annex A (normative) Proportions and dimensions of graphical symbols	11
Annex B (informative) Recommended edge sizes	12
Annex C (informative) Relations between part edges and corners	13

Foreword

ISO (the International Organization for Standardization) is a worldwide federation of national standards bodies (ISO member bodies). The work of preparing International Standards is normally carried out through ISO technical committees. Each member body interested in a subject for which a technical committee has been established has the right to be represented on that committee. International organizations, governmental and non-governmental, in liaison with ISO, also take part in the work. ISO collaborates closely with the International Electrotechnical Commission (IEC) on all matters of electrotechnical standardization.

International Standards are drafted in accordance with the rules given in the ISO/IEC Directives, Part 3.

Draft International Standards adopted by the technical committees are circulated to the member bodies for voting. Publication as an International Standard requires approval by at least 75 % of the member bodies casting a vote.

Attention is drawn to the possibility that some of the elements of this International Standard may be the subject of patent rights. ISO shall not be held responsible for identifying any or all such patent rights.

International Standard ISO 13715 was prepared by Technical Committee ISO/TC 10, *Technical drawings, product definition and related documentation*, Subcommittee SC 6, *Mechanical engineering documentation*.

This second edition cancels and replaces the first edition (ISO 13715:1994), which has been technically revised.

Annex A forms a normative part of this International Standard. Annexes B and C are for information only.

Introduction

In technical drawings, the ideal geometric shape is represented without any deviation and, in general, without consideration of the states of the edges. Nevertheless, for many purposes (the functioning of a part, or out of safety considerations, for example) particular states of edges need to be indicated. Such states include those of external edges free from burr, sharp edges or those with a burr of limited size, and internal edges with a passing. In principle, all the edges of a part should be produced in their requisite states. In practice, unless those states are specified in the technical drawing or related documentation, the part will be delivered direct from the machine without the required treatment.

This International Standard is aimed at enabling this situation to be avoided, through specification of guidelines for the indication and graphic representation of the states of edges in technical drawings.

Technical drawings — Edges of undefined shape — Vocabulary and indications

1 Scope

This International Standard defines the terms defining the states of edges and specifies rules for representing states of edges of undefined shape in technical drawings.

The proportions and dimensions of the graphical symbols to be used are also specified.

In cases where the geometrically defined shape of an edge ($1 \times 45^\circ$, for example) is required, the general dimensioning principles given in ISO 129-1 apply.

2 Normative references

The following normative documents contain provisions which, through reference in this text, constitute provisions of this International Standard. For dated references, subsequent amendments to, or revisions of, any of these publications do not apply. However, parties to agreements based on this International Standard are encouraged to investigate the possibility of applying the most recent editions of the normative documents indicated below. For undated references, the latest edition of the normative document referred to applies. Members of ISO and IEC maintain registers of currently valid International Standards.

ISO 128-20, *Technical drawings — General principles of presentation — Part 20: Basic conventions for lines.*

ISO 128-22, *Technical drawings — General principles of presentation — Part 22: Basic conventions and applications for leader lines and reference lines.*

ISO 129-1—¹⁾, *Technical drawings — Indication of dimensions and tolerances — Part 1: General principles.*

ISO 3098-0:1997, *Technical product documentation — Lettering — Part 0: General requirements.*

ISO 81714-1:1999, *Design of graphical symbols for use in the technical documentation of products — Part 1: Basic rules.*

3 Terms and definitions

For the purposes of this International Standard, the following terms and definitions apply.

3.1

edge

intersection of two surfaces

NOTE See annex C for further information.

1) To be published. (Partial revision of ISO 129:1985)

3.2

state of an edge

geometrical shape and size of an edge

3.3

edge of undefined shape

edge with a shape that is not specified precisely

3.4

sharp edge

external or internal edge of a part with almost zero deviation from the ideal geometrical shape

NOTE Examples are presented in Figures 1 and 2.

3.5

burr

rough remainder of material outside the ideal geometrical shape of an external edge, residue of machining or of a forming process

NOTE Examples are presented in Figures 1 and 3.

3.6

undercut

deviation inside the ideal geometrical shape of an internal edge

NOTE Examples are presented in Figures 1, 2, 4 and 5.

3.7

passing

deviation outside the ideal geometrical shape of an internal edge

NOTE Examples are presented in Figures 2 and 6.

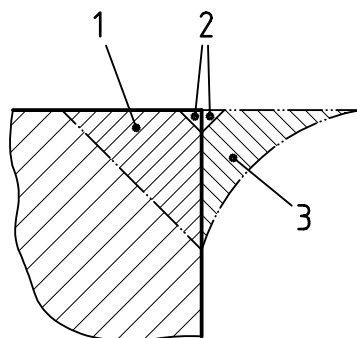

Key

- 1 Size of undercut
- 2 Size of sharp edge
- 3 Size of burr

Figure 1 — States of an external edge

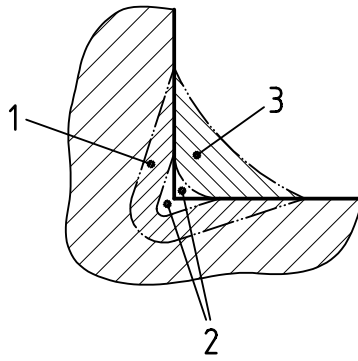

Key

- 1 Size of undercut
- 2 Size of sharp edge
- 3 Size of passing

Figure 2 — States of an internal edge

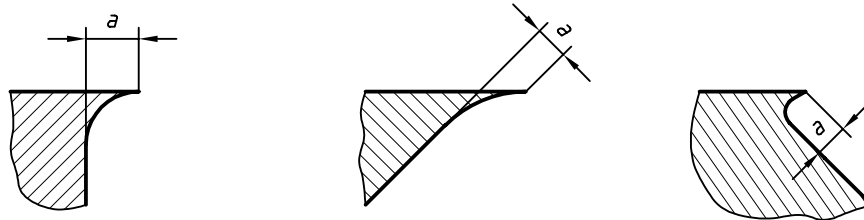

a is the size of the burr

Figure 3 — Examples of burr

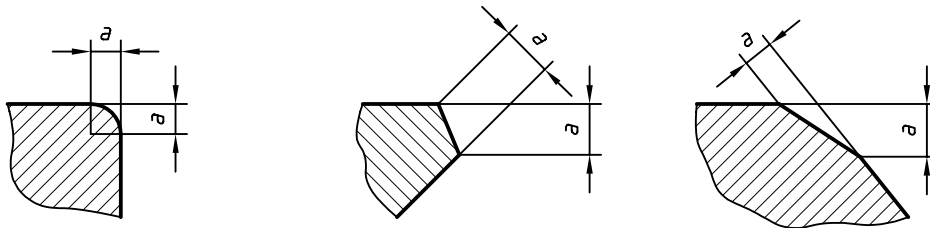

a is the size of the undercut

Figure 4 — Examples of undercut at an external edge

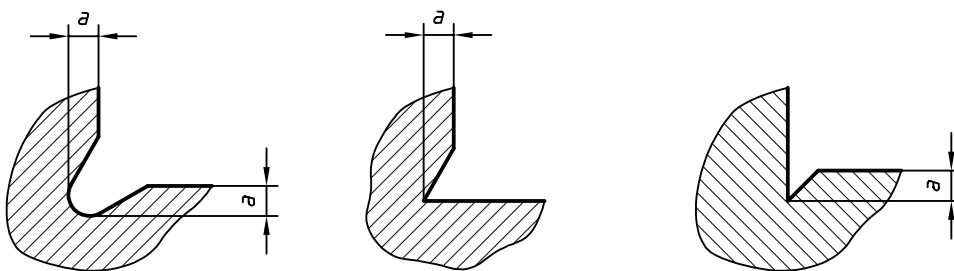

a is the size of the undercut

Figure 5 — Examples of undercut at an internal edge

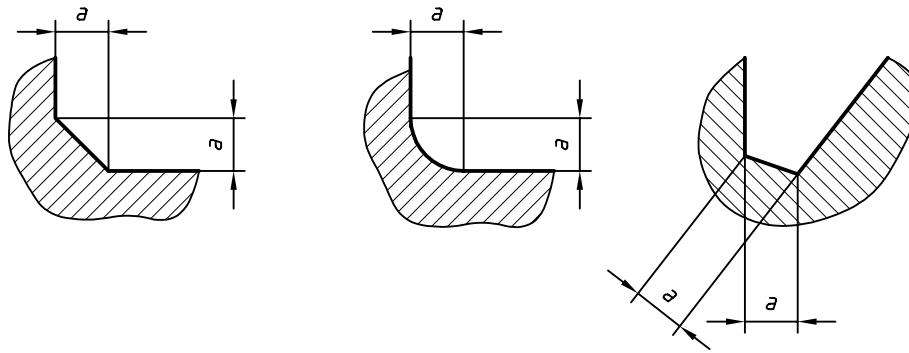

a is the size of the passing

Figure 6 — Examples of passing

4 Indications on drawings

4.1 Basic symbol

The state of the edges of a part shall be indicated by the basic graphical symbol shown in Figure 7. Complementary indications shall be placed in the areas a_1 , a_2 or a_3 defined in Figure A.1. The length and direction of the leader line may be adapted to suit the characteristics of the drawing (see, for example, Figure 14).

NOTE Rules for drafting the basic symbol are given in annex A.



Figure 7 — Basic symbol

4.2 Location of the basic symbol

The indications concerning edges of undefined shape shall be given as:

- an individual indication for a single edge;
- individual indications for all edges around the represented profile of a part;
- collective indications common to all or the majority of a part's edges.

Individual indications are immediately assigned to a line (e.g. visible outlines, areas with specific treatment or extension lines), or to a point representing an edge parallel with, or vertical to, the projection plane (see Figures 14 to 16).

Collective indications are indicated only once for all the common edges and are located near the representation of the part or near the title block (see Figures 17 to 21).

4.3 Shape of edges

The shape of an edge shall be indicated in the area a_1 (defined in Figure A.1), beside the basic symbol, by the element + (plus), - (minus) or \pm (plus or minus), in accordance with Table 1 (see Figures 8 to 10).

The symbol element + (plus) indicates permitted excess material in relation to the ideal shape of the edge: i.e. burr on external and passing on internal edges. The element – (minus) indicates required material removal in relation to the ideal shape of the edge: i.e. undercut of external and internal edges. Neither a burr's or undercut's direction nor its size is specified by a single symbol element.

The deviation from ideal shape can be controlled by indicating the direction of burr and undercut (see 4.4) and the size (see 4.5).

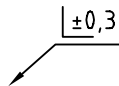

Figure 8 — Symbol element ±



Figure 9 — Symbol element +



Figure 10 — Symbol element –

Table 1 — Symbol elements for the shapes of edges

Symbol element	Meaning	
	External edge	Internal edge
+	Burr permitted; undercut not permitted	Passing permitted; undercut not permitted
-	Undercut required; burr not permitted	Undercut required; passing not permitted
± ^a	Burr or undercut permitted	Undercut or passing permitted

^a To be used only with an indication of size.

4.4 Direction of burr or undercut

Wherever indication of the permitted direction of burr on an external edge or undercut on an internal edge is needed, the indication of size shall be given in the area a₂ or a₃ (as defined in Figure A.1), accordingly (see Figures 11 and 12). Indication of the direction of the undercut on an external, or passing on an internal, edge is not permitted.

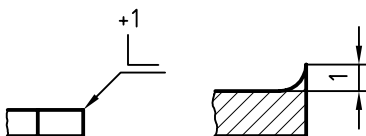

Figure 11 — Direction of the burr on an external edge

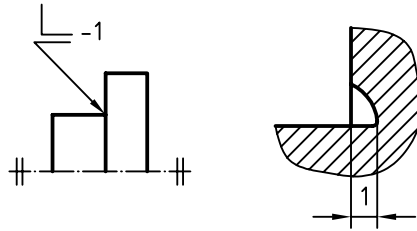

Figure 12 — Direction of the undercut on an internal edge

4.5 Sizes of edges

Recommended edge sizes are presented in annex B.

Whenever the specification of an upper and lower limit deviation for the size of an edge is necessary, both values shall be indicated, with the upper limit deviation placed above the lower limit deviation, following the symbol elements + or – [see Figure 13 a) to d)]. When a particular direction of burr or undercut is required, the indication shall be positioned accordingly (4.4). The indicated limit deviations correspond to the maximum and minimum dimensions, respectively.

When a single limit for the size of an edge is specified (for examples, see Figures 11, 12 and 15), the second limit deviation is the value 0 (zero).

$$\begin{array}{c} +1 \\ | \\ +0,5 \end{array}$$

a)

$$\begin{array}{c} +1 \\ | \\ -0,5 \end{array}$$

b)

$$\begin{array}{c} +0,2 \\ | \\ -0,5 \end{array}$$

c)

$$\begin{array}{c} -1 \\ | \\ -2,5 \end{array}$$

d)

Figure 13 — Examples of edge sizes

4.6 Meaning of indications on the drawing

4.6.1 The following may be indicated:

- an edge vertical to the projection plane (see Figure 14, front view);
- an edge of a feature, such as a hole (see Figure 14, section);
- the edges of the front and the back, if only one view is represented and the outlines of both front and back are the same (see Figures 15 and 16);
- all edges around the profile of a part represented on the drawing, if the symbol element “circle” is added to the basic symbol (see Figure 15). In the case of ambiguity, this indication may be used at corners.

The “circle” element shall not be used in sectional representations. For further information concerning the application of this symbol element, see ISO 128-22.

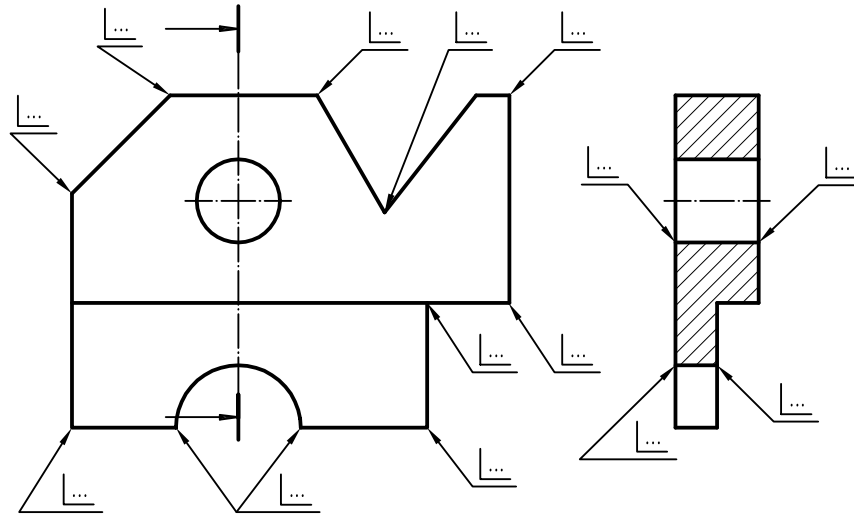

Figure 14 — States of edge vertical to the projection plane and of a feature

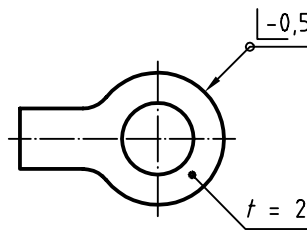

Figure 15 — States of all edges around the profile of a part

4.6.2 The graphical symbol indication and the specification shall be represented in such a way that they can be read from the bottom of the drawing.

4.6.3 A state of edge valid only for the prescribed length of an edge shall be indicated with the corresponding dimension and be represented by a long-dashed and dotted line (see ISO 128-20:1996, line type 04) (see Figure 16).

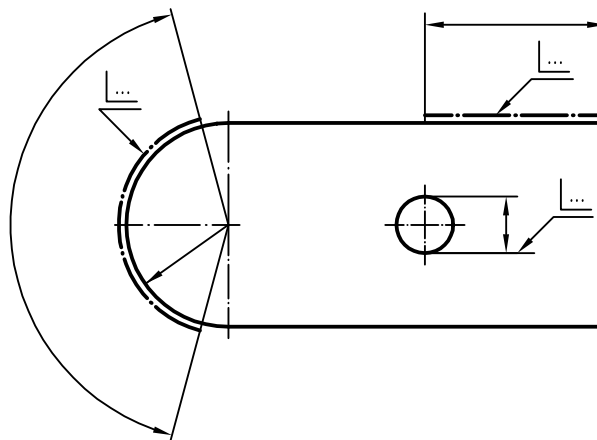

Figure 16 — States of edges valid only for a prescribed edge length

4.6.4 When the requirement for the state of an edge is common to all the edges of a part, one collective indication at the appropriate position on the drawing (near the representation or the title block, as in Figure 17) will

suffice. Collective indications of states common to only external or internal edges shall be indicated in accordance with Figure 18 and Figure 19, respectively.

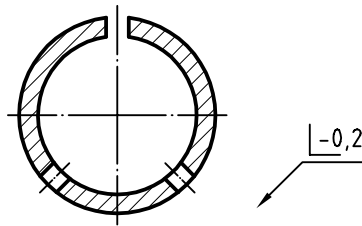

Figure 17 — State of edge common to all the edges of a part

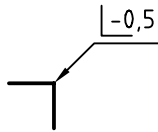

Figure 18 — State of edge common to external edges only

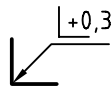

Figure 19 — State of edge common to internal edges only

4.6.5 If it is necessary to emphasize in a collective indication that another state of edge is present elsewhere on the drawing, an additional indication in parentheses is given at right of the collective indication [see Figure 20 a) and b)].

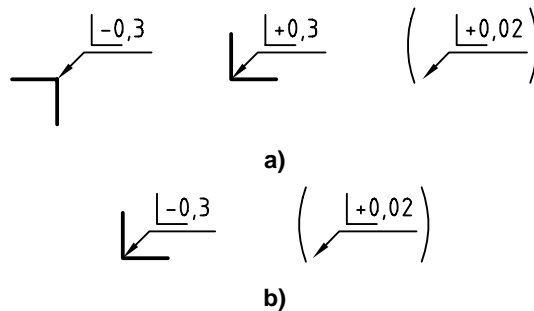

Figure 20 — Additional states of edges in the context of a collective indication

For purposes of simplification, if more than one other state of edge is present, only the basic symbol shall appear in parentheses at right of the collective indication (see Figure 21).

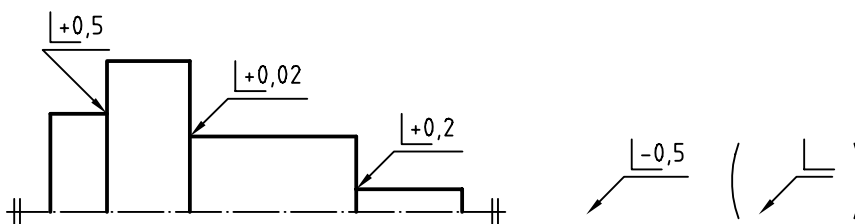

Figure 21 — Simplified representation of an additional state of edge in the context of a collective indication

4.7 Reference to this International Standard

It is recommended that reference be made to this International Standard — either within or near the title block, and in the manner shown by Figure 22.

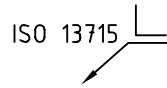

Figure 22 — Reference to this International Standard



5 Examples

See Table 2.

Table 2 — Examples of indications of edges

No.	Indication	Meaning	Explanation
5.1			External edge with burr acceptable up to 0,3 mm; burr direction undefined
5.2			External edge with acceptable burr; size and direction of burr undefined
5.3			External edge with burr acceptable up to 0,3 mm; burr direction defined
5.4			
5.5			External edge without burr; undercut up to 0,3 mm
5.6			External edge without burr; undercut in the zone from 0,1 mm to 0,5 mm
5.7			External edge without burr; undercut acceptable, size undefined

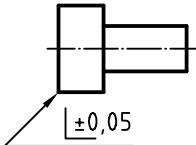
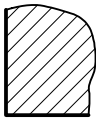
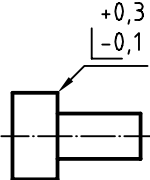
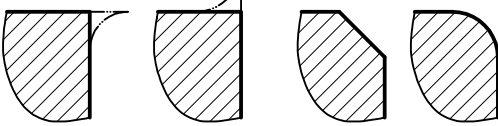
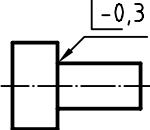
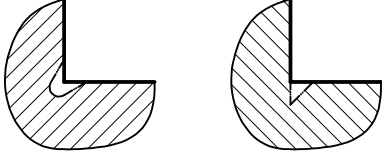
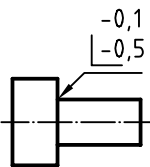
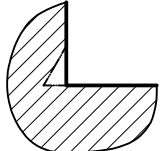
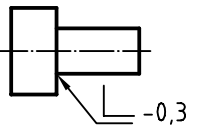
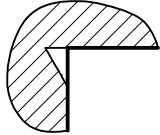
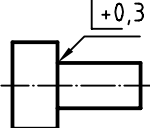
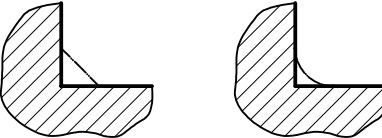
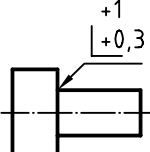
Table 2 (continued)

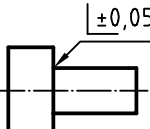
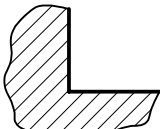
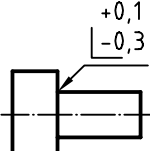
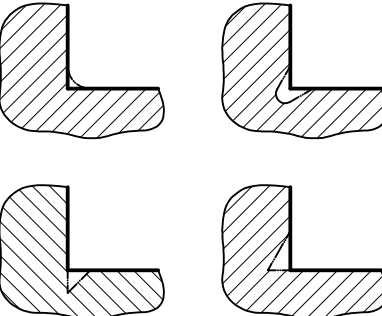
No.	Indication	Meaning	Explanation
5.8			<p>External edge with burr acceptable up to 0,05 mm or undercut down to 0,05 mm (sharp edge); burr direction undefined</p>
5.9			<p>External edge with burr acceptable up to 0,3 mm or with undercut down to 0,1 mm; burr direction undefined</p>
5.10			<p>Internal edge with undercut acceptable down to 0,3 mm; undercut direction undefined</p>
5.11			<p>Internal edge with undercut acceptable in the zone from 0,1 mm to 0,5 mm; undercut direction undefined</p>
5.12			<p>Internal edge with undercut acceptable down to 0,3 mm; undercut direction defined</p>
5.13			<p>Internal edge with passing acceptable up to 0,3 mm</p>
5.14			<p>Internal edge with passing acceptable in the zone of from 0,3 mm to 1 mm</p>
5.15			<p>Internal edge with undercut acceptable down to 0,05 mm or passing acceptable up to 0,05 mm (sharp edge); undercut direction undefined</p>
5.16			<p>Internal edge with passing acceptable up to 0,1 mm or undercut acceptable down to 0,3 mm; undercut direction undefined</p>

Annex A (normative)

Proportions and dimensions of graphical symbols

A.1 General requirements

In order to harmonize the size of the graphical symbols specified in this International Standard with that of the other indications on the drawing (dimensions, tolerances, etc.) observe the rules prescribed in ISO 81714-1.

Lettering shall be of the same height and line width as that used for dimensioning. The distance between lines should be twice the line width.

A.2 Proportions

The graphical symbols and the additional indications in the areas a_1 to a_3 shall be draughted in accordance with Figure A.1.

The use of the symbol element "circle" is optional; the angle of the leader line will depend on the case of application. The length of the leader line should be equal to, or greater than $1,5 \times h$. If appropriate, the reference line may be extended.

A.3 Dimensions

The dimensional requirements of the graphical symbols and additional indications are specified in Table A.1.

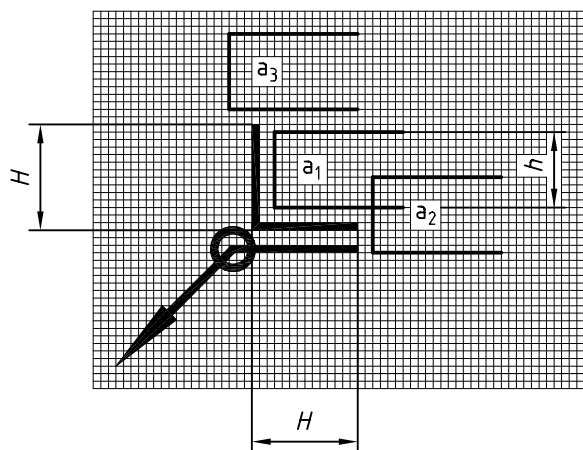

Figure A.1 — Proportions

Table A.1 — Dimensions

Dimensions in millimetres

Lettering height, h	3,5	5	7	10	14
Line width for symbols and lettering type B ISO 3098-0:1997, d	0,35	0,5	0,7	1	1,4
Symbol height, H	5	7	10	14	20

Annex B (informative)

Recommended edge sizes

The recommended sizes of edges, a , are given in Table B.1.

Table B.1 — Recommended sizes of edges

Dimensions in millimetres

a	Application
a + 2,5 + 1 + 0,5 + 0,3 + 0,1	Edges with permitted burr or passing; undercut not permitted
+ 0,05 + 0,02	
- 0,02 - 0,05	Sharp edges
- 0,1 - 0,3 - 0,5 - 1 - 2,5 a	Edges with permitted undercut; burr or passing not permitted
a	
a Additional sizes, if necessary.	

Annex C (informative)

Relations between part edges and corners

Contrasting with a part's edges (3.2), its corners are formed by the intersection of three or more surfaces. The part corner is represented by a point, as shown in Figure C.1.

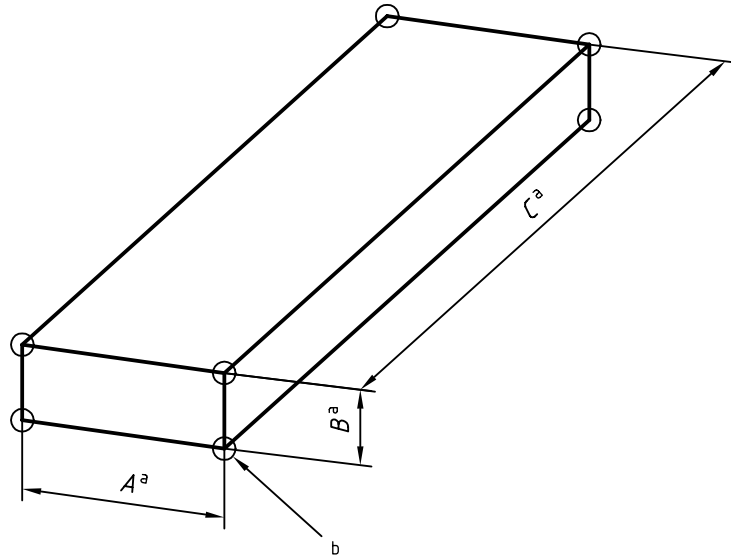

- a Length of edge
- b Corner

Figure C.1 — Relations between edges and corners

ICS 01.040.01; 01.100.20

Price based on 13 pages

© ISO 2000 – All rights reserved