**Non-destructive testing of welds —
Ultrasonic testing — Acceptance levels**

*Contrôle non destructif des assemblages soudés — Contrôle par
ultrasons — Niveaux d'acceptation*



PDF disclaimer

This PDF file may contain embedded typefaces. In accordance with Adobe's licensing policy, this file may be printed or viewed but shall not be edited unless the typefaces which are embedded are licensed to and installed on the computer performing the editing. In downloading this file, parties accept therein the responsibility of not infringing Adobe's licensing policy. The ISO Central Secretariat accepts no liability in this area.

Adobe is a trademark of Adobe Systems Incorporated.

Details of the software products used to create this PDF file can be found in the General Info relative to the file; the PDF-creation parameters were optimized for printing. Every care has been taken to ensure that the file is suitable for use by ISO member bodies. In the unlikely event that a problem relating to it is found, please inform the Central Secretariat at the address given below.



COPYRIGHT PROTECTED DOCUMENT

© ISO 2010

All rights reserved. Unless otherwise specified, no part of this publication may be reproduced or utilized in any form or by any means, electronic or mechanical, including photocopying and microfilm, without permission in writing from either ISO at the address below or ISO's member body in the country of the requester.

ISO copyright office
Case postale 56 • CH-1211 Geneva 20
Tel. + 41 22 749 01 11
Fax + 41 22 749 09 47
E-mail copyright@iso.org
Web www.iso.org

Published in Switzerland

Contents

Page

Foreword	iv
1 Scope	1
2 Normative references	1
3 Measurement of indication length	1
4 Sensitivity setting and levels	2
5 Acceptance levels	2
5.1 General	2
5.2 Longitudinal indications	3
5.3 Transverse indications	3
5.4 Grouping of indications	3
5.5 Cumulative length of acceptable indications	4
Annex A (normative) Levels	5
Annex B (normative) Fixed amplitude level technique	17

Foreword

ISO (the International Organization for Standardization) is a worldwide federation of national standards bodies (ISO member bodies). The work of preparing International Standards is normally carried out through ISO technical committees. Each member body interested in a subject for which a technical committee has been established has the right to be represented on that committee. International organizations, governmental and non-governmental, in liaison with ISO, also take part in the work. ISO collaborates closely with the International Electrotechnical Commission (IEC) on all matters of electrotechnical standardization.

International Standards are drafted in accordance with the rules given in the ISO/IEC Directives, Part 2.

The main task of technical committees is to prepare International Standards. Draft International Standards adopted by the technical committees are circulated to the member bodies for voting. Publication as an International Standard requires approval by at least 75 % of the member bodies casting a vote.

Attention is drawn to the possibility that some of the elements of this document may be the subject of patent rights. ISO shall not be held responsible for identifying any or all such patent rights.

ISO 11666 was prepared by the European Committee for Standardization (CEN) Technical Committee TC 121, *Welding*, Subcommittee SC 5, *Testing of welds*, in collaboration with ISO Technical Committee TC 44, *Welding and allied processes*, Subcommittee SC 5, *Testing and inspection of welds*, in accordance with the Agreement on technical cooperation between ISO and CEN (Vienna Agreement).

Requests for official interpretations of any aspect of this International Standard should be directed to the Secretariat of ISO/TC 44/SC 5 via your national standards body. A complete listing of these bodies can be found at www.iso.org.

Non-destructive testing of welds — Ultrasonic testing — Acceptance levels

1 Scope

This International Standard specifies ultrasonic acceptance levels 2 and 3 for full penetration welded joints in ferritic steels, which correspond to ISO 5817 quality levels B and C. An acceptance level corresponding to ISO 5817 quality level D is not included in this International Standard as ultrasonic testing is generally not requested for this weld quality.

These acceptance levels are applicable to testing carried out in accordance with ISO 17640.

This International Standard applies to the examination of full penetration ferritic steel welds, with thicknesses from 8 mm to 100 mm. It can also be used for other types of welds, materials and thicknesses above 100 mm, provided the examinations have been performed with necessary consideration of the geometry and acoustic properties of the component, and an adequate sensitivity can be employed to enable the acceptance levels of this International Standard to be applied. The nominal frequency of probes used in this International Standard is between 2 MHz and 5 MHz unless attenuation or requirements for higher resolution call for other frequencies. The use of these acceptance levels in conjunction with frequencies outside this range needs to be considered carefully.

2 Normative references

The following referenced documents are indispensable for the application of this document. For dated references, only the edition cited applies. For undated references, the latest edition of the referenced document (including any amendments) applies.

ISO 5817, *Welding — Fusion-welded joints in steel, nickel, titanium and their alloys (beam welding excluded) — Quality levels for imperfections*

ISO 17635, *Non-destructive testing of welds — General rules for metallic materials*

ISO 17640, *Non-destructive testing of welds — Ultrasonic testing — Techniques, testing levels, and assessment*

ISO 23279, *Non-destructive testing of welds — Ultrasonic testing — Characterization of indications in welds*

3 Measurement of indication length

The length of an indication shall be determined by measuring the distance along the length over which the echo amplitude is above the evaluation level, using the fixed amplitude level technique specified in Annex B.

Alternative techniques for measuring indication length may be used when specified.

4 Sensitivity setting and levels

The sensitivity setting may be performed by one of the following techniques. For sensitivity setting and the subsequent examinations, the same technique shall be used:

- a) technique 1: based on 3 mm diameter side-drilled holes;
- b) technique 2: based on distance gain size (DGS) curves for flat-bottom holes (disk-shaped reflectors);
- c) technique 3: using a distance-amplitude-corrected (DAC) curve of a rectangular notch of 1 mm depth and 1 mm width;
- d) technique 4: using the tandem technique with reference to a 6 mm diameter flat-bottom hole (disk-shaped reflector).

Four levels as defined in ISO 17640 are used in this International Standard:

- 1) reference level;
- 2) evaluation level;
- 3) recording levels (for two acceptance levels, reference levels are derived from the relevant acceptance level minus 4 dB);
- 4) acceptance levels (for two quality levels).

All levels are linked to the reference reflectors specified in Table A.1.

Annex A specifies levels.

5 Acceptance levels

5.1 General

The relationship between acceptance levels, testing levels and quality levels is given in ISO 17635. See also Table 1.

Table 1 — Ultrasonic pulse echo technique (UT)

Quality level in accordance with ISO 5817	Testing technique and level in accordance with ISO 17640 ^a	Acceptance level in accordance with this International Standard
B	at least B	2
C	at least A	3
D	at least A	3 ^b
^a When characterization of indications is required, ISO 23279 shall be applied. ^b UT is not recommended but can be defined in a specification (with the same requirements as quality level C).		

The acceptance levels in this International Standard are valid for all testing levels and for all techniques as defined in ISO 17640, including tests with straight beam probes.

If characterization has been specified in accordance with ISO 23279, planar indications are not acceptable and for non-planar indications, the acceptance levels in this International Standard apply.

If characterization has not been specified, the acceptance levels in this International Standard apply to all indications.

5.2 Longitudinal indications

Table A.1 gives information on the techniques used for evaluation of indications according to ISO 17640 and the related evaluation and acceptance levels. Table A.2 specifies the acceptance levels for technique 2 using transverse waves. Table A.3 specifies the acceptance levels for technique 2 using longitudinal waves.

For techniques 1 (side-drilled holes) and 3 (rectangular notch), see Figures A.1 to A.4.

For techniques 2 [flat-bottom holes (disk-shaped reflectors)] and 4 (tandem technique), see Figures A.5 to A.8.

Any indication with an amplitude below the acceptance level but with a length (above evaluation level) exceeding t , for the thickness range of $8 \text{ mm} \leq t < 15 \text{ mm}$, or $t/2$ or 20 mm , whichever is the larger, for all other thickness ranges, shall be subject to further testing. This requires the use of additional probe angle(s), and, if specified, the tandem technique.

The final evaluation shall be based on the maximum echo amplitude and length measured.

5.3 Transverse indications

When detection of transverse indications is specified, the acceptance levels stated in 5.2 apply.

5.4 Grouping of indications

Grouping is based on the length and the separation of two individually acceptable indications having amplitudes above the recording level. The length of a group shall not be used for further grouping.

For evaluation, a group of indications shall be considered as a single one if:

- the distance, d_x , is less than twice the length of the longer indication (see Figure 1);
- the distance, d_y , is less than half of the thickness but not more than 10 mm;
- the distance, d_z , is less than half of the thickness but not more than 10 mm.

The combined length is:

$$l_{12} = l_1 + l_2 + d_x$$

(see Figure 2).

The combined length, l_{12} , and the larger maximum amplitude of the two indications shall then be assessed against the applicable acceptance levels given in Table A.1.

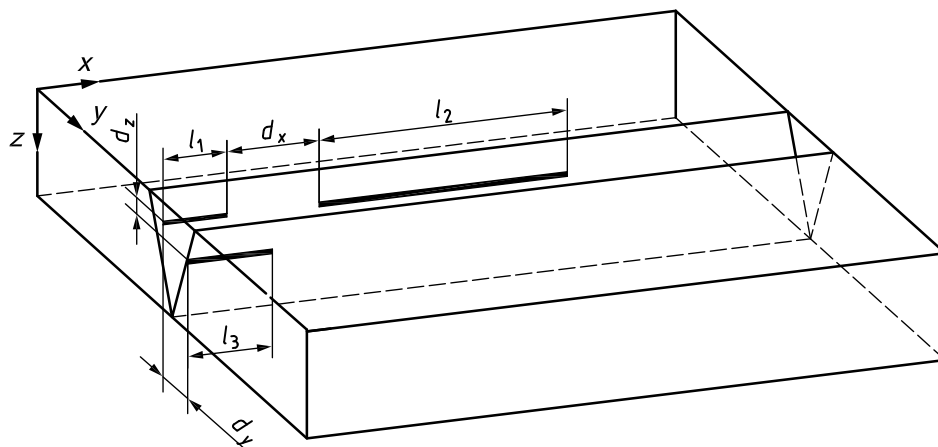

Key

d_x, d_y, d_z distances in the x -, y -, and z -directions, respectively

l_n where $n = 1 \dots 3$, individual indications

Figure 1 — Geometric configuration for grouped indications

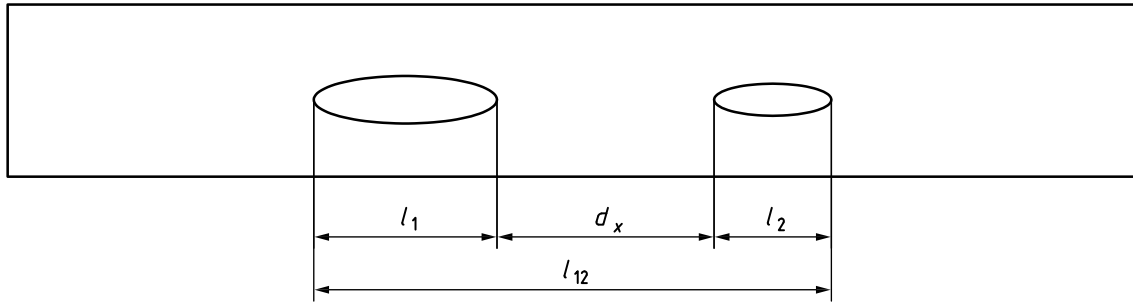

- Key**
- d_x distance in the x -direction
 - l_1, l_2 individual indications
 - l_{12} combined length

Figure 2 — Length of a group of indications

5.5 Cumulative length of acceptable indications

The cumulative length of all individually acceptable indications above recording level is given as the sum of lengths of both single indications and linearly aligned indications of combined length within a given section of weld length.

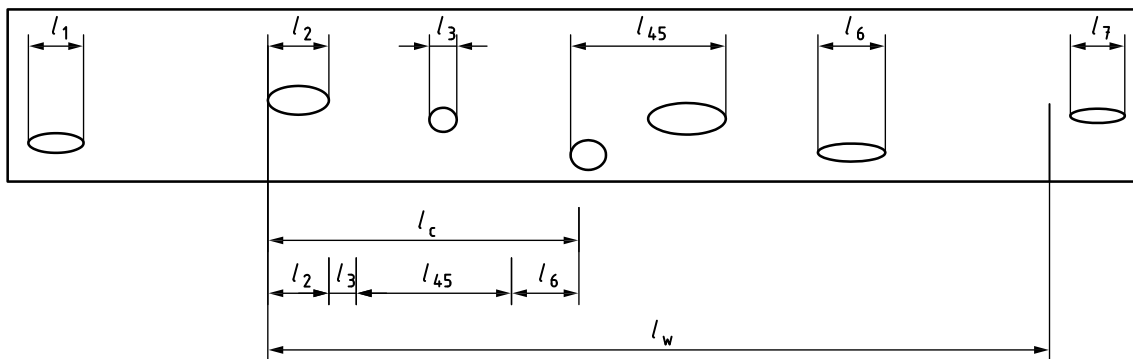

- Key**
- l_c cumulative length
 - $l_c = l_2 + l_3 + l_{45} + l_6$
 - l_w weld length
 - l_n where $n = 1 \dots 7$, individual indications

Figure 3 — Cumulative length of indications

For any section of weld length, l_w , the maximum cumulative length of all individually acceptable indications above the recording level shall not exceed 20 % of this length for acceptance level 2, or 30 % of this length for acceptance level 3, where $l_w = 6 t$ for $t < 15$ mm and $l_w = 100$ mm for $t \geq 15$ mm.

Annex A (normative)

Levels

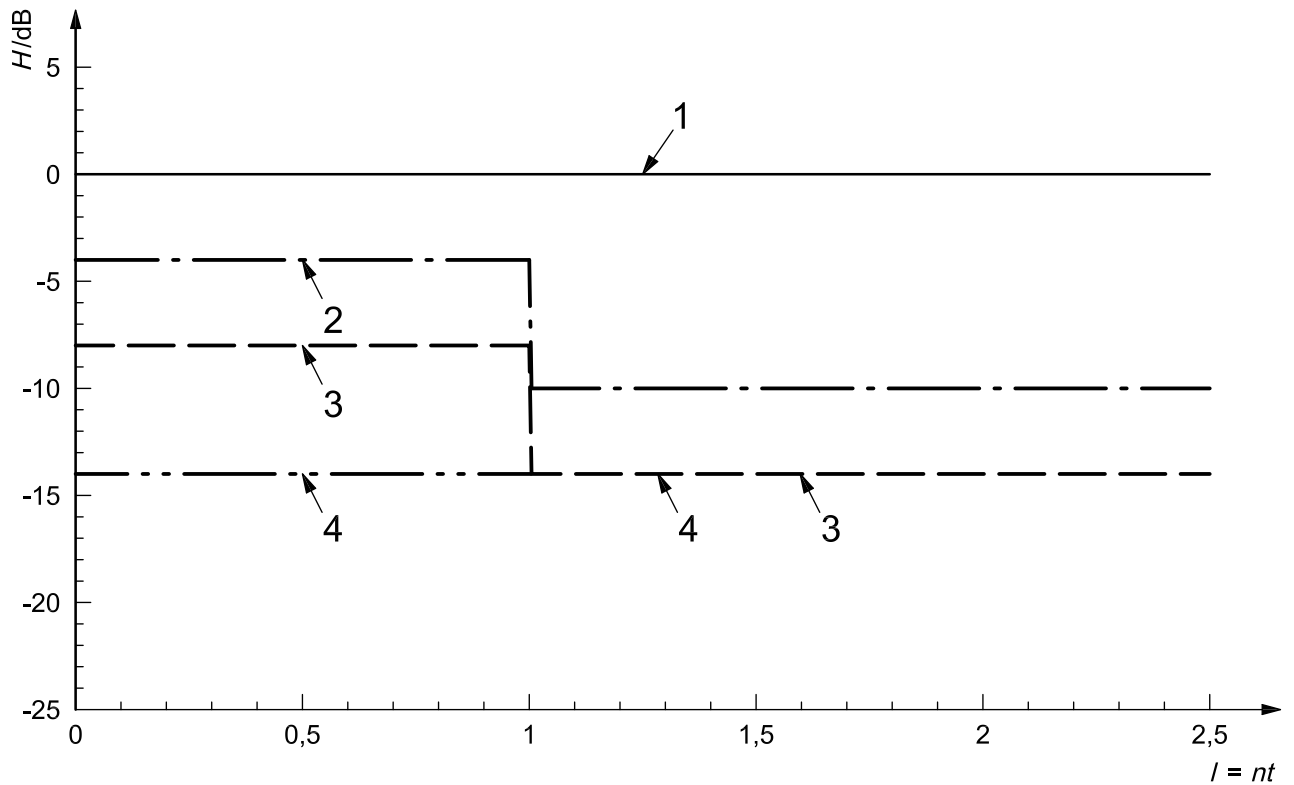

Key

- 1 reference level
- 2 acceptance level 2
- 3 recording level
- 4 evaluation level
- H amplitude
- l indication length
- n multiplier of t
- t thickness

Figure A.1 — Levels for techniques 1 and 3 for thicknesses 8 mm to 15 mm — Acceptance level 2

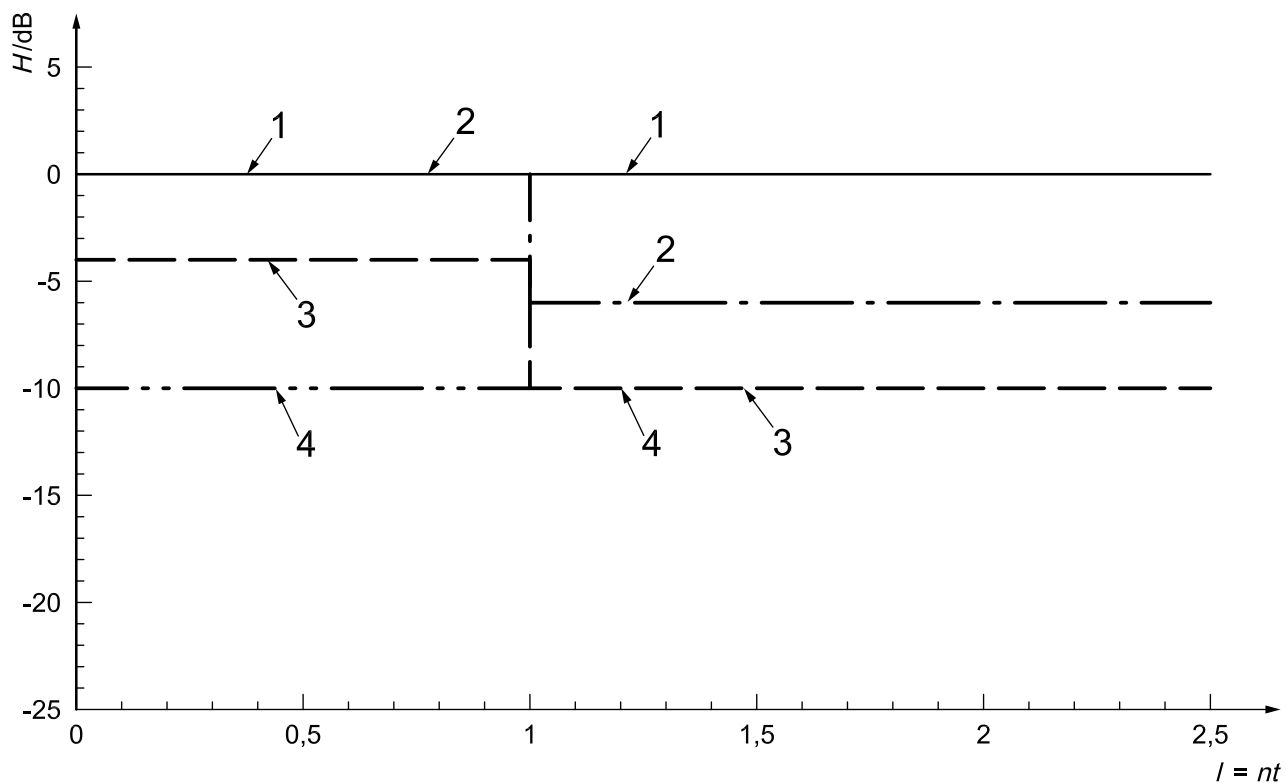

Key

- 1 reference level
- 2 acceptance level 3
- 3 recording level
- 4 evaluation level
- H amplitude
- l indication length
- n multiplier of t
- t thickness

Figure A.2 — Levels for techniques 1 and 3 for thicknesses 8 mm to 15 mm — Acceptance level 3

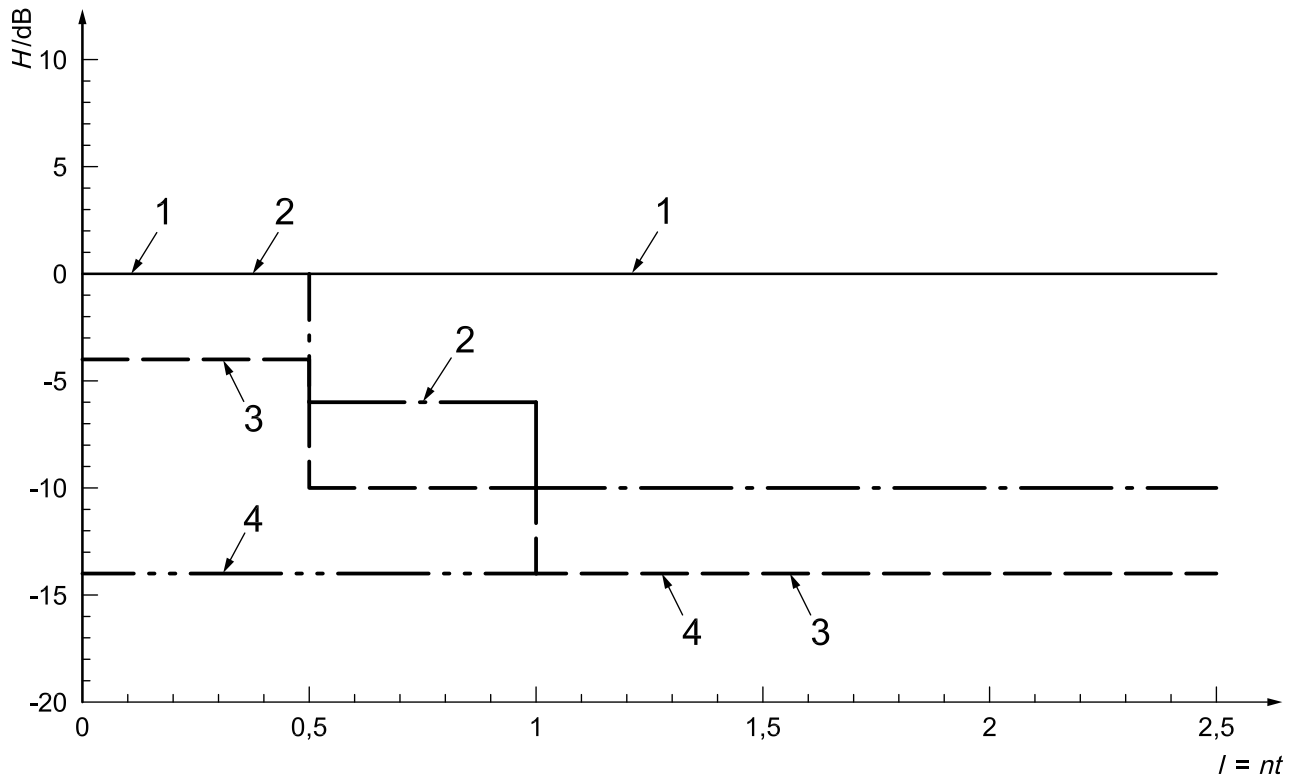
**Key**

- 1 reference level
- 2 acceptance level 2
- 3 recording level
- 4 evaluation level
- H amplitude
- l indication length
- n multiplier of t
- t thickness

Figure A.3 — Levels for technique 1 for thicknesses 15 mm to 100 mm — Acceptance level 2

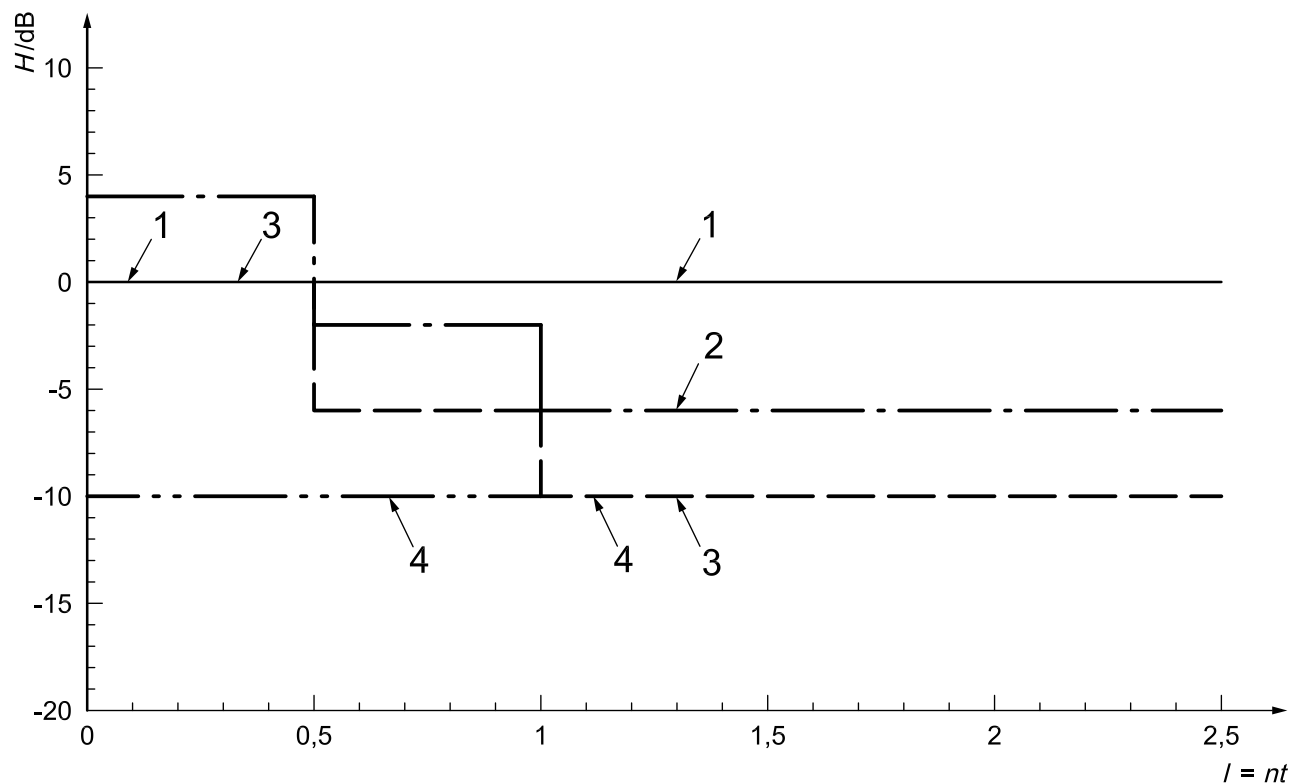

Key

- 1 reference level
- 2 acceptance level 3
- 3 recording level
- 4 evaluation level
- H amplitude
- l indication length
- n multiplier of t
- t thickness

Figure A.4 — Levels for technique 1 for thicknesses 15 mm to 100 mm — Acceptance level 3

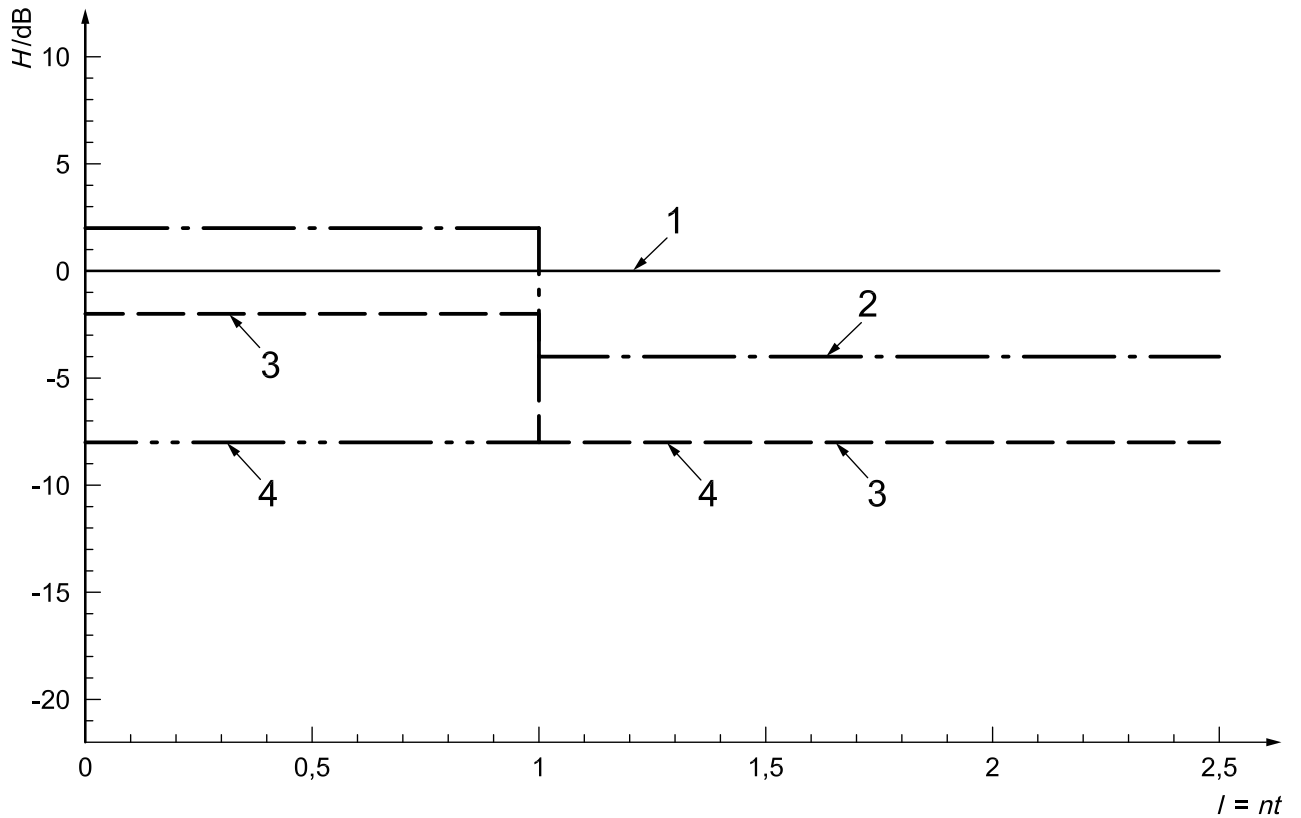
**Key**

- 1 reference level
- 2 acceptance level 2
- 3 recording level
- 4 evaluation level
- H amplitude
- l indication length
- n multiplier of t
- t thickness

Figure A.5 — Levels for technique 2 for thicknesses 8 mm to 15 mm — Acceptance level 2

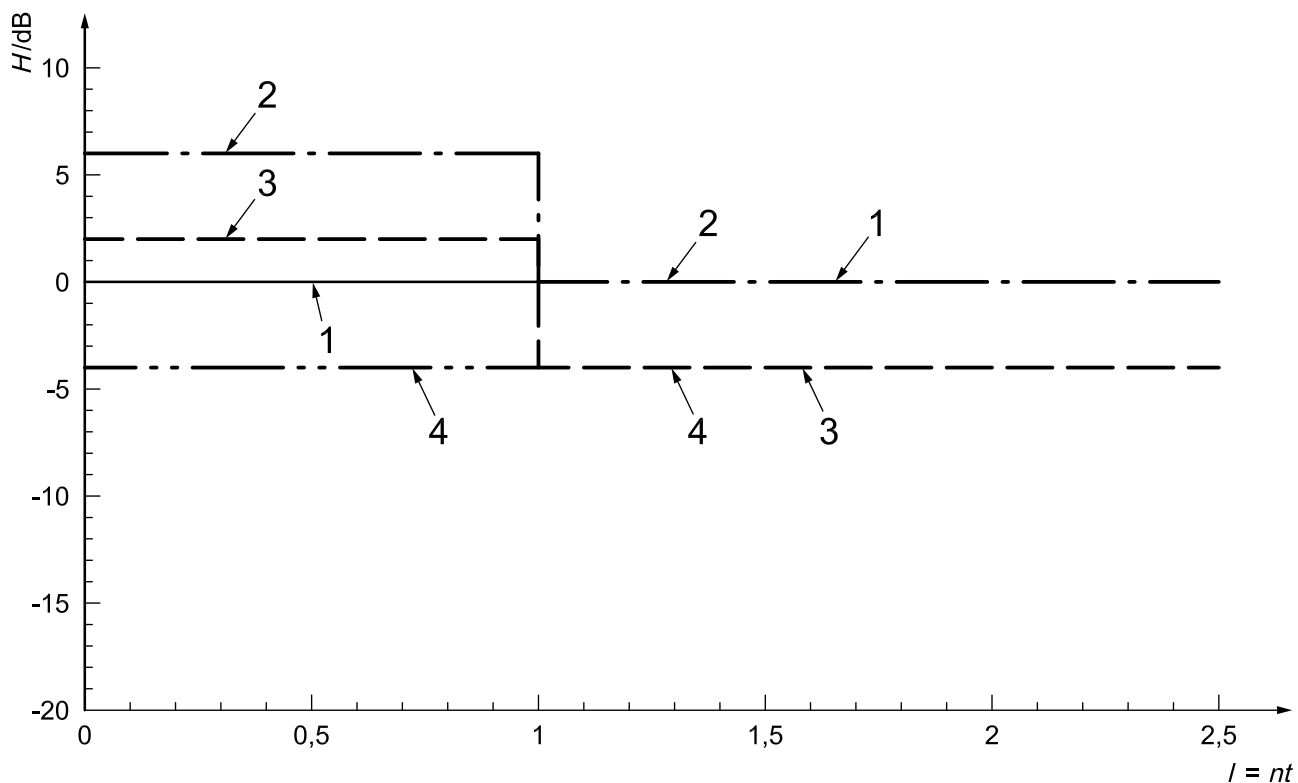

Key

- 1 reference level
- 2 acceptance level 3
- 3 recording level
- 4 evaluation level
- H amplitude
- l indication length
- n multiplier of t
- t thickness

Figure A.6 — Levels for technique 2 for thicknesses 8 mm to 15 mm — Acceptance level 3

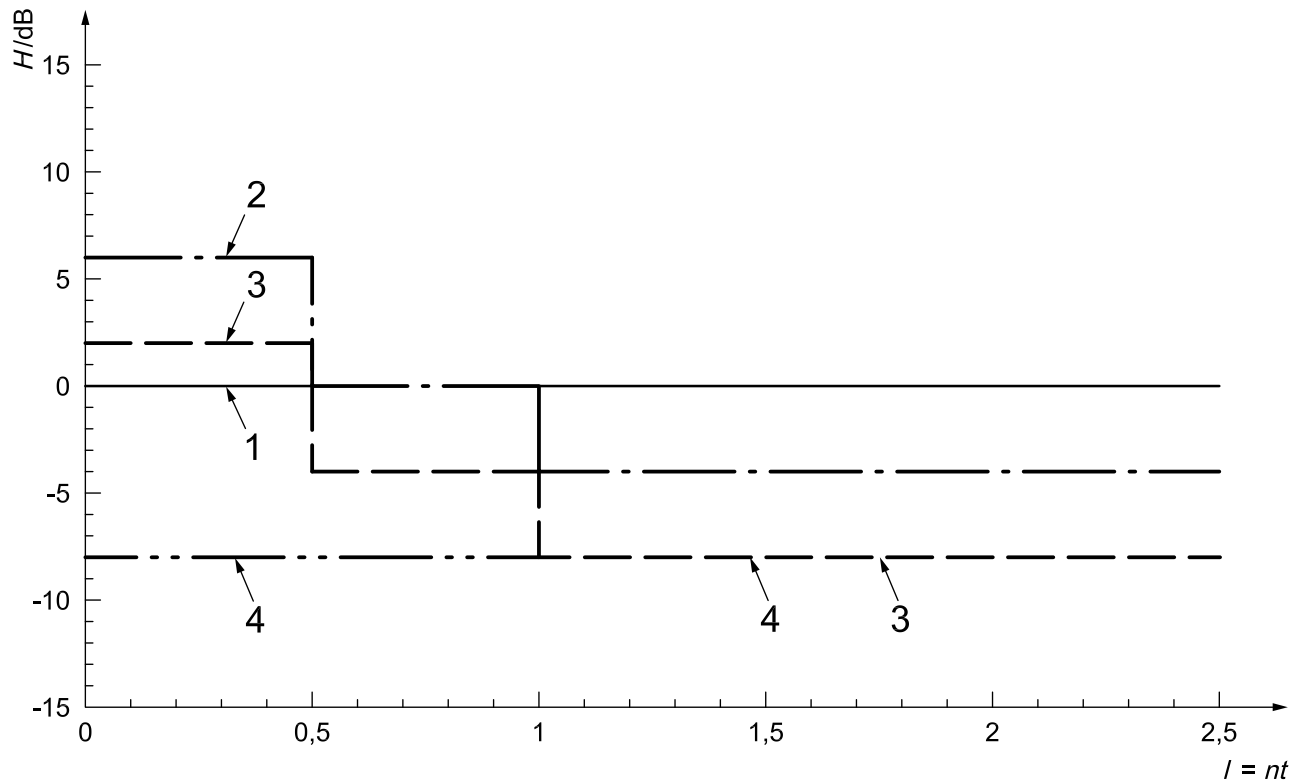
**Key**

- 1 reference level
- 2 acceptance level 2
- 3 recording level
- 4 evaluation level
- H amplitude
- l indication length
- n multiplier of t
- t thickness

Figure A.7 — Levels for technique 2 for thicknesses 15 mm to 100 mm — Acceptance level 2

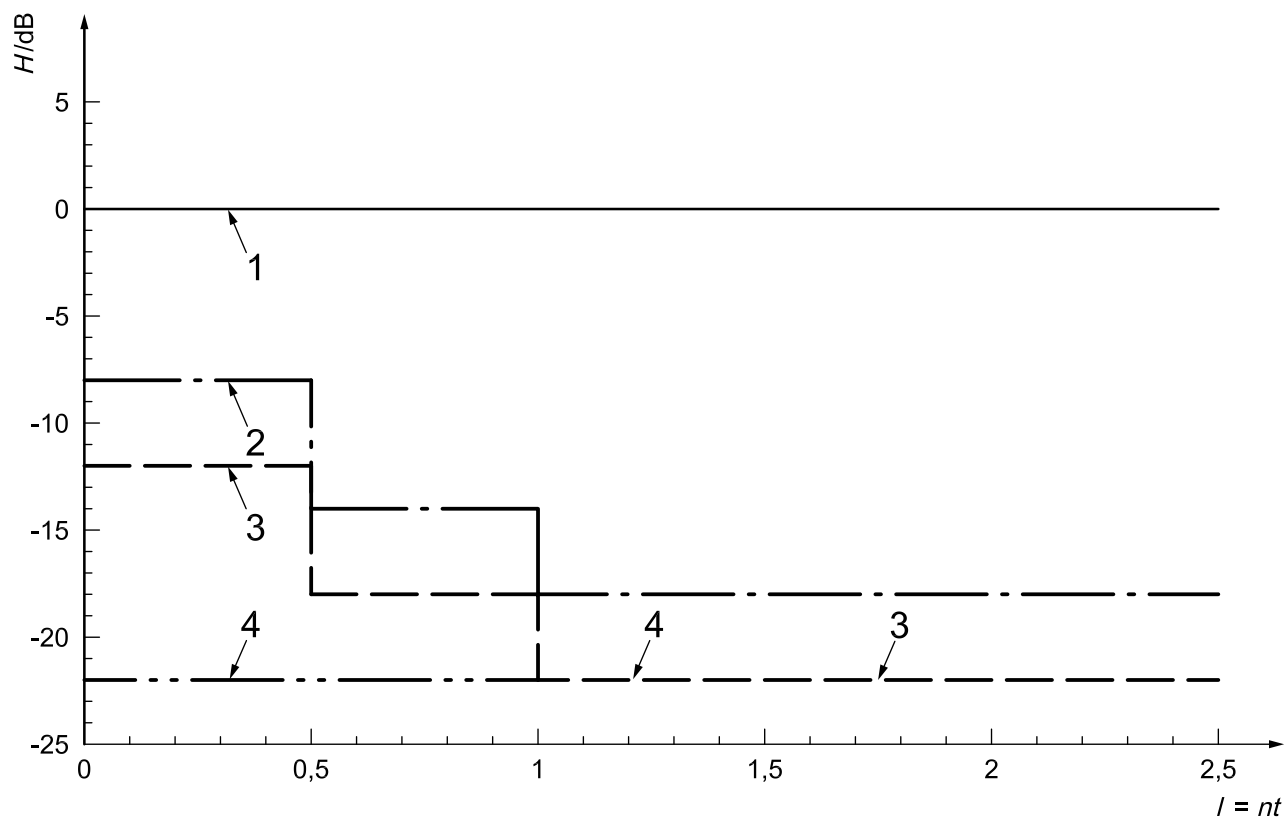

Key

- 1 reference level
- 2 acceptance level 2
- 3 recording level
- 4 evaluation level
- H amplitude
- l indication length
- n multiplier of t
- t thickness

Figure A.8 — Levels for technique 4 for thicknesses 15 mm to 100 mm — Acceptance level 2

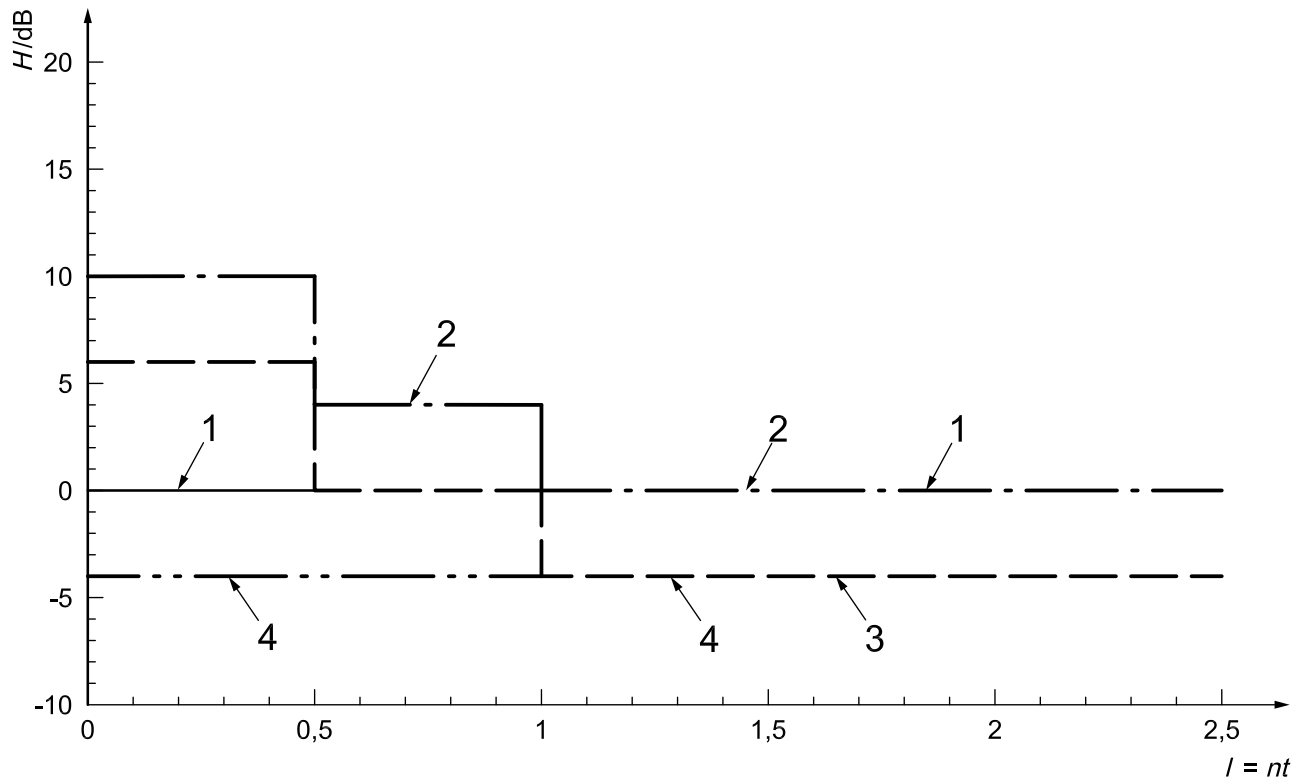
**Key**

- 1 reference level
- 2 acceptance level 3
- 3 recording level
- 4 evaluation level
- H amplitude
- l indication length
- n multiplier of t
- t thickness

Figure A.9 — Levels for technique 2 for thicknesses 15 mm to 100 mm — Acceptance level 3

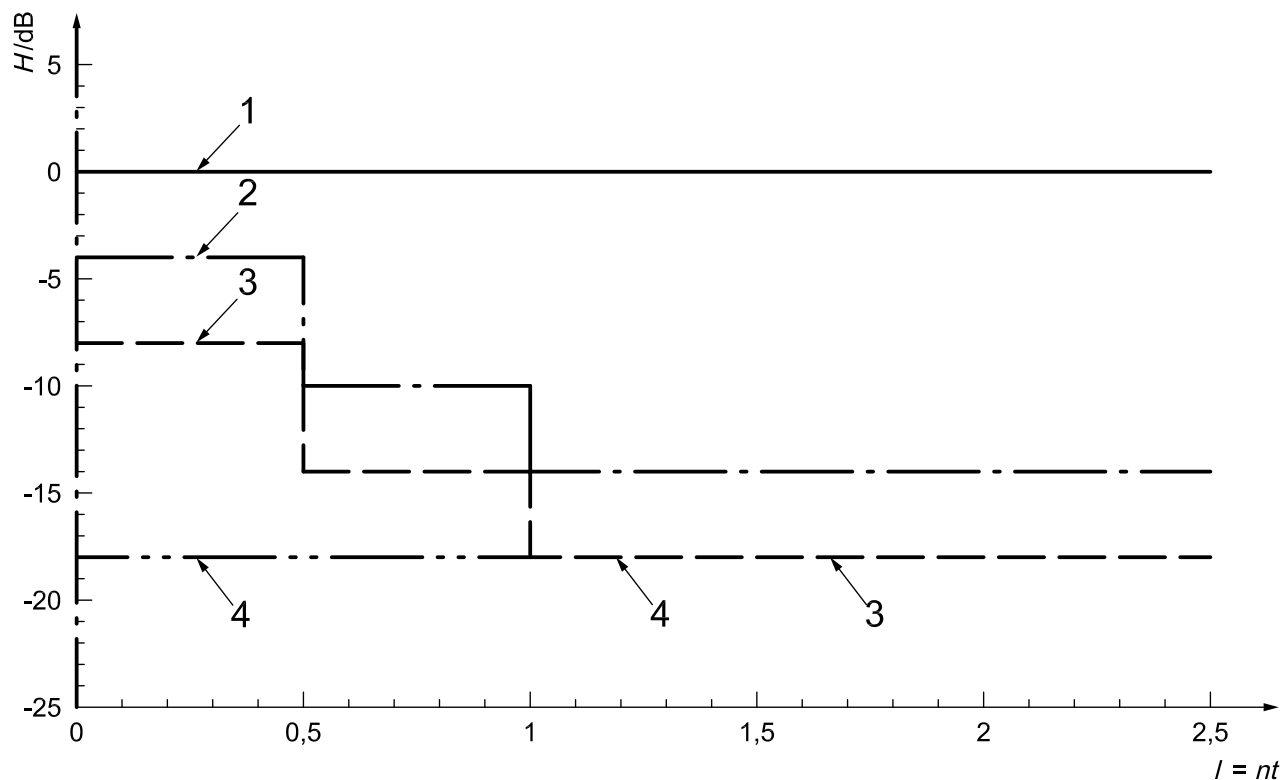

Key

- 1 reference level
- 2 acceptance level 3
- 3 recording level
- 4 evaluation level
- H amplitude
- l indication length
- n multiplier of t
- t thickness

Figure A.10 — Levels for technique 4 for thicknesses 15 mm to 100 mm — Acceptance level 3

Table A.1 — Acceptance levels 2 and 3 for techniques 1, 2, 3, and 4

Technique (according to ISO 17640)	Evaluation level		Acceptance level 2 (AL 2)		Acceptance level 3 (AL 3)	
	for AL 2	for AL 3	8 mm ≤ <i>t</i> < 15 mm	15 mm ≤ <i>t</i> < 100 mm	8 mm ≤ <i>t</i> < 15 mm	15 mm ≤ <i>t</i> < 100 mm
1 (side-drilled holes)	$H_0 - 14$ dB	$H_0 - 10$ dB	For $l \leq t$: $H_0 - 4$ dB For $l > t$: $H_0 - 10$ dB	For $l \leq 0,5 t$: H_0 For $0,5 t < l \leq t$: $H_0 - 6$ dB For $l > t$: $H_0 - 10$ dB	For $l \leq t$: H_0 For $l > t$: $H_0 - 6$ dB	For $l \leq 0,5 t$: $H_0 + 4$ dB For $0,5 t < l \leq t$: $H_0 - 2$ dB For $l > t$: $H_0 - 6$ dB
2 [flat-bottom holes (disk-shaped reflectors)]	$H_0 - 8$ dB in accordance with Table A.2 or A.3	$H_0 - 4$ dB in accordance with Table A.2 or A.3	For $l \leq t$: $H_0 + 2$ dB For $l > t$: $H_0 - 4$ dB	For $l \leq 0,5 t$: $H_0 + 6$ dB For $0,5 t < l \leq t$: H_0 For $l > t$: $H_0 - 4$ dB	For $l \leq t$: $H_0 + 6$ dB For $l > t$: H_0	For $l \leq 0,5 t$: $H_0 + 10$ dB For $0,5 t < l \leq t$: $H_0 + 4$ dB For $l > t$: H_0
3 (rectangular notch)	$H_0 - 14$ dB	$H_0 - 10$ dB	For $l \leq t$: $H_0 - 4$ dB For $l > t$: $H_0 - 10$ dB	—	For $l \leq t$: H_0 For $l > t$: $H_0 - 6$ dB	—
4 (tandem technique)	$H_0 - 22$ dB	$H_0 - 18$ dB	—	For $l \leq 0,5 t$: $H_0 - 8$ dB For $0,5 t < l \leq t$: $H_0 - 14$ dB For $l > t$: $H_0 - 18$ dB	—	For $l \leq 0,5 t$: $H_0 - 4$ dB For $0,5 t < l \leq t$: $H_0 - 10$ dB For $l > t$: $H_0 - 14$ dB

Recording levels are 4 dB below the corresponding acceptance levels.

 H_0 is the reference level.

Table A.2 — Reference levels for acceptance levels 2 and 3 for technique 2 using angle beam scanning with transverse waves

Nominal probe frequency MHz	Thickness of parent material, <i>t</i>					
	8 mm ≤ <i>t</i> < 15 mm		15 mm ≤ <i>t</i> < 40 mm		40 mm ≤ <i>t</i> < 100 mm	
1,5 to 2,5	AL 2	AL 3	AL 2	AL 3	AL 2	AL 3
	—	—	$D_{DSR} = 2,5 \text{ mm}$	$D_{DSR} = 2,5 \text{ mm}$	$D_{DSR} = 3,0 \text{ mm}$	$D_{DSR} = 3,0 \text{ mm}$
3,0 to 5,0	$D_{DSR} = 1,5 \text{ mm}$	$D_{DSR} = 1,5 \text{ mm}$	$D_{DSR} = 2,0 \text{ mm}$	$D_{DSR} = 2,0 \text{ mm}$	$D_{DSR} = 3,0 \text{ mm}$	$D_{DSR} = 3,0 \text{ mm}$

D_{DSR} is the diameter of the disk-shaped reflector.

Table A.3 — Reference levels for acceptance levels 2 and 3 for technique 2 using straight beam scanning with longitudinal waves

Nominal probe frequency MHz	Thickness of parent material, <i>t</i>					
	8 mm ≤ <i>t</i> < 15 mm		15 mm ≤ <i>t</i> < 40 mm		40 mm ≤ <i>t</i> < 100 mm	
1,5 to 2,5	AL 2	AL 3	AL 2	AL 3	AL 2	AL 3
	—	—	$D_{DSR} = 2,5 \text{ mm}$	$D_{DSR} = 2,5 \text{ mm}$	$D_{DSR} = 3,0 \text{ mm}$	$D_{DSR} = 3,0 \text{ mm}$
3,0 to 5,0	$D_{DSR} = 2,0 \text{ mm}$	$D_{DSR} = 2,0 \text{ mm}$	$D_{DSR} = 2,0 \text{ mm}$	$D_{DSR} = 2,0 \text{ mm}$	$D_{DSR} = 3,0 \text{ mm}$	$D_{DSR} = 3,0 \text{ mm}$

D_{DSR} is the diameter of the disk-shaped reflector.

Annex B (normative)

Fixed amplitude level technique

The technique measures the lateral dimensions of an indication over which the echo is equal to or greater than the evaluation level.

To make a measurement, the beam is scanned over the indications, and the probe position and beam path range, at which the echo has fallen to the evaluation level, are noted (positions 1 and 2 in Figure B.1).

The lateral dimension, l , is then determined by the distance between the positions 1 and 2.

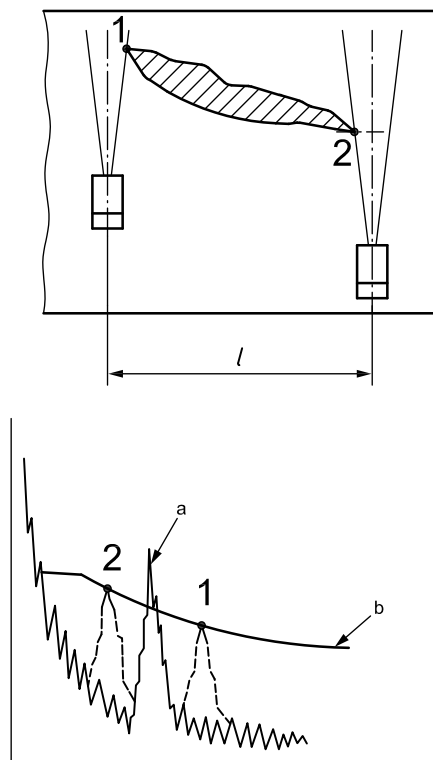

Key

- l measured lateral dimension of indication
- 1, 2 positions where indication amplitudes are equal to the evaluation level
- a Maximum echo.
- b Evaluation level.

Figure B.1 — Fixed amplitude level technique using the beam axis

