Cutting tool data representation and exchange —

Part 70: Graphical data layout — Layer setting for tool layout

*Représentation et échange des données relatives aux outils
coupants —*

*Partie 70: Disposition des données graphiques — Disposition en
couches des paramètres des outils*





COPYRIGHT PROTECTED DOCUMENT

© ISO 2016, Published in Switzerland

All rights reserved. Unless otherwise specified, no part of this publication may be reproduced or utilized otherwise in any form or by any means, electronic or mechanical, including photocopying, or posting on the internet or an intranet, without prior written permission. Permission can be requested from either ISO at the address below or ISO's member body in the country of the requester.

ISO copyright office
Ch. de Blandonnet 8 • CP 401
CH-1214 Vernier, Geneva, Switzerland
Tel. +41 22 749 01 11
Fax +41 22 749 09 47
copyright@iso.org
www.iso.org

Contents

Page

Foreword	iv
Introduction	vi
1 Scope	1
2 Terms and definitions	1
3 Layer concept	4
4 Structure of the layers	5
4.1 General.....	5
4.2 Colouring of the layers	5
4.3 Grouping and definition of the layers.....	6
4.3.1 Grouping	6
4.3.2 Basic layer.....	6
4.3.3 Tool drawing (main view — function number 3.0.1).....	6
4.3.4 NC-Geometry (CUT, NOCUT — function number 3.0.2).....	8
4.3.5 Extended tool drawing (further views — function number 3.0.3).....	9
4.3.6 Multilingual (global drawing — function number 3.0.4).....	10
4.3.7 Tool reconditioning (supplier specific information — function number 3.0.5) ...	12
4.3.8 Machine equipment layout (machining processes — function number 3.0.6).....	13
4.3.9 Drawing frame (multilingual and drawing space — function number 3.0.7).....	15
4.4 Determination of the layer properties.....	15
4.5 Rules of the layer concept.....	26
5 Data concept	27
5.1 Origin points and mating points	27
5.1.1 Rotationally symmetric cutting tool assembly.....	27
5.1.2 Non-rotationally symmetric cutting tool assembly	28
5.2 Rules for the Layer CUT and NOCUT	30
5.3 Rules for the concept of dimensioning.....	32
5.3.1 General.....	32
5.3.2 Cutting tool component.....	32
5.3.3 Cutting tool combination.....	33
Annex A (informative) Examples of the layer structure	34
Bibliography	49

Foreword

ISO (the International Organization for Standardization) is a worldwide federation of national standards bodies (ISO member bodies). The work of preparing International Standards is normally carried out through ISO technical committees. Each member body interested in a subject for which a technical committee has been established has the right to be represented on that committee. International organizations, governmental and non-governmental, in liaison with ISO, also take part in the work. ISO collaborates closely with the International Electrotechnical Commission (IEC) on all matters of electrotechnical standardization.

The procedures used to develop this document and those intended for its further maintenance are described in the ISO/IEC Directives, Part 1. In particular the different approval criteria needed for the different types of ISO documents should be noted. This document was drafted in accordance with the editorial rules of the ISO/IEC Directives, Part 2 (see www.iso.org/directives).

Attention is drawn to the possibility that some of the elements of this document may be the subject of patent rights. ISO shall not be held responsible for identifying any or all such patent rights. Details of any patent rights identified during the development of the document will be in the Introduction and/or on the ISO list of patent declarations received (see www.iso.org/patents).

Any trade name used in this document is information given for the convenience of users and does not constitute an endorsement.

For an explanation on the meaning of ISO specific terms and expressions related to conformity assessment, as well as information about ISO's adherence to the World Trade Organization (WTO) principles in the Technical Barriers to Trade (TBT) see the following URL: www.iso.org/iso/foreword.html.

The committee responsible for this document is ISO/TC 29, *Small tools*.

ISO/TS 13399 consists of the following parts, under the general title *Cutting tool data representation and exchange*:

- *Part 1: Overview, fundamental principles and general information model*
- *Part 2: Reference dictionary for the cutting items* [Technical Specification]
- *Part 3: Reference dictionary for tool items* [Technical Specification]
- *Part 4: Reference dictionary for adaptive items* [Technical Specification]
- *Part 5: Reference dictionary for assembly items* [Technical Specification]
- *Part 50: Reference dictionary for reference systems and common concepts* [Technical Specification]
- *Part 60: Reference dictionary for connection systems* [Technical Specification]
- *Part 70: Graphical data layout — Layer settings for tool layout* [Technical Specification]
- *Part 71: Graphical data layout — Creation of documents for the standardized data exchange — Graphical product information* [Technical Specification]
- *Part 72: Creation of documents for the standardized data exchange — Definition of properties for drawing header and their XML-data exchange* [Technical Specification]
- *Part 150: Usage guidelines* [Technical Specification]
- *Part 201: Creation and exchange of 3D models — Regular inserts* [Technical Specification]
- *Part 202: Creation and exchange of 3D models — Irregular inserts* [Technical Specification]
- *Part 203: Creation and exchange of 3D models — Replaceable inserts for drilling* [Technical Specification]

- *Part 204: Creation and exchange of 3D models — Inserts for reaming* [Technical Specification]
- *Part 301: Concept for the design of 3D models based on properties according to ISO/TS 13399-3: Modelling of thread-cutting taps, thread-forming taps and thread-cutting dies* [Technical Specification]
- *Part 302: Concept for the design of 3D models based on properties according to ISO/TS 13399-3: Modelling of solid drills and countersinking tools* [Technical Specification]
- *Part 303: Creation and exchange of 3D models — Solid end mills* [Technical Specification]
- *Part 304: Creation and exchange of 3D models — Solid milling cutters with arbor hole* [Technical Specification]
- *Part 307: Creation and exchange of 3D models — End mills for indexable inserts* [Technical Specification]
- *Part 308: Creation and exchange of 3D models — Milling cutters with arbor hole for indexable inserts* [Technical Specification]
- *Part 309: Creation and exchange of 3D models — Tool holders for indexable inserts* [Technical Specification]
- *Part 311: Creation and exchange of 3D models — Solid reamers* [Technical Specification]
- *Part 312: Creation and exchange of 3D models — Reamers for indexable inserts* [Technical Specification]
- *Part 401: Creation and exchange of 3D models — Converting, extending and reducing adaptive items* [Technical Specification]
- *Part 403: Creation and exchange of 3D models — Modelling of driven tool units* [Technical Specification]
- *Part 405: Creation and exchange of 3D models — Collets* [Technical Specification]
- *Part 406: Creation and exchange of 3D models — Modelling of connection interface* [Technical Specification]

The following parts are under preparation:

- *Part 80: Creation and exchange of 3D models — Overview and principles* [Technical Specification]
- *Part 100: Definitions, principles and methods for reference dictionaries* [Technical Specification]
- *Part 305: Creation and exchange of 3D models — Modular tooling systems with adjustable cartridges for boring* [Technical Specification]
- *Part 310: Creation and exchange of 3D models — Turning tools with carbide tips* [Technical Specification]
- *Part 313: Creation and exchange of 3D models — Creation and exchange of 3D models — Burrs* [Technical Specification]
- *Part 314: Creation and exchange of 3D models — Creation and exchange of 3D models — Cartridges for indexable inserts* [Technical Specification]
- *Part 315: Creation and exchange of 3D models — Modelling of machine operated feed out tools* [Technical Specification]

Introduction

This part of ISO/TS 13399 defines the terms, properties and definitions of the layers of a computer-aided design. The purpose of this part of ISO/TS 13399 is to provide a reference layer setting to support the use of CAD-designs of tool graphics to be used for simulation and documentation of cutting tool components and assemblies. The basis of this part of ISO/TS 13399 is the common layer structure of the production facility graphic — better known as the BMG (building model generation) layer structure. Mainly, this concept was used and will be used for the graphical layout of cutting tools and their components within the 2D area. Examples of the layer structure are given in [Annex A](#).

Cutting tool data representation and exchange —

Part 70:

Graphical data layout — Layer setting for tool layout

1 Scope

This part of ISO/TS 13399 is intended to be used for the design of tool layouts for the simulation and the documentation of cutting tool components and cutting tool assemblies. This part of ISO/TS 13399 can be used in connection and correlation with other parts of ISO/TS 13399.

The main purpose of this layer structure is the graphical layout of cutting tool components and cutting tool assemblies to be used within tool pre-setting, NC programming and the simulation of processes, as well as for the design of the machining equipment layout.

The common concept of the BMG (building model generation) layer structure has been extended with more layer definitions for universal use. This part of ISO/TS 13399 is applicable for a new layout; old, existing data files are not updated to this level. The use of this part of ISO/TS 13399 in terms of change management of existing cutting tool layout is at the manufacturer's discretion.

The extent of the dimensioning is limited to the number of dimensions that are also populated within manufacturer's or distributor's catalogues. The manufacturer determines the level of details and is understood as tool specific.

As the 3D-simulation systems proceed with stock removal, it is differentiated between cutting and non-cutting tool components. Also, the data concept includes the rules of zero points and mounting points for non-rotating tools (lathe tools).

2 Terms and definitions

For the purposes of this document, the following terms and definitions apply.

2.1

assembled tool

AT

tool components (also single parts and spare parts) that are arranged to an assembled tool to be able to run a computer-aided application

2.2

centre line

line that defines the axis of a rotational body or the symmetric axis of a feature

EXAMPLE Axis of a hole.

2.3

cladding contour

continuous line built from single lines which describes the outer contour of a complete tool or tool component that is relevant for collision purposes

2.4

colour index DXF

numerical value of a colour within the application of data transmission under the drawing exchange format DXF

Note 1 to entry: All CAx-systems interpret uniformly this colour index.

2.5
complete tool

illustration of single-tool components as in an assembled tool that is applicable to be used in simulation processes, machining equipment layout and for the development of NC-programs

2.6
connection

<workpiece side/machine side> transition from one tool component to the other seen in the respective direction of the transition, while mounting both adjacent components

Note 1 to entry: *Machine side* means that the connection is seen in the direction of the machine spindle, *workpiece side* calls a connection on the side of the component which points in the direction of the workpiece.

2.7
cutting contour

outer contour of an object that describes the part of a cutting tool that actively takes part in a cutting process and if revolved around the axis of the tool will change to a three-dimensional object

Note 1 to entry: Anomaly exists on drilling tools, where the lateral area is to be shown up to the maximum usable (drilling) depth, while if necessary, a cone exists, and this cone is non-cutting.

2.8
data exchange format
DXF

basic version of the graphical data exchange

2.9
dimensioning

representation of the spatial expansions of an object

Note 1 to entry: In this part of ISO/TS 13399, dimensioning is performed according to International Standards, e.g. ISO 16792.

2.10
expansion of the main view
INFMAINVIEW

maximum needed space of the main view, which is determined by two of each horizontal and vertical lines and its distances

Note 1 to entry: Either the two corner points in diagonal distance, lower left and upper right $[(x_1, y_1)/(x_2, y_2)]$, or the corresponding lines are indicated.

2.11
expansion of the total drawing
INFTOTAL

maximum needed space of the entire graphic images including any additional information but without a drawing frame and its variable content, which is determined by two of each horizontal and vertical lines and its distances

Note 1 to entry: Either the two corner points in diagonal distance left lower and right upper $[(X_1, Y_1)/(X_2, Y_2)]$ or the corresponding lines are indicated.

2.12
font size

standardized size of the letters within technical drawings

Note 1 to entry: The font size also controls the corresponding thickness of the lines and is defined in ISO 6428.

2.13
font type

definition of the style of lettering within the CAx-systems

2.14**inner contour**

illustration of object elements placed inside the object body and are therefore not visible

Note 1 to entry: These elements are shown as invisible contours in a defined line style.

2.15**line type**

characteristic of lines to differentiate the meaning within a technical drawing

Note 1 to entry: The definition and application of the line types is defined in ISO 128-20.

2.16**machining equipment layout**

representation of the sequence of the work routines which are likely to produce a workpiece within a process cycle

Note 1 to entry: The work routine can follow mechanically by means of chipping working steps in the mechanical manufacture or by means of working steps without chipping in the assemblies.

Note 2 to entry: Machining equipment layouts are designed only by means of bilateral agreements between a supplier and an end user.

2.17**main view****MV**

view of an object showing the function and where the main dimensions (functional dimensions) are attached to

2.18**non-cutting contour**

outline contour of an object describing the area of a cutting tool, which does not take part in the active cutting process and therefore can collide with the workpiece

Note 1 to entry: Anomaly on drilling tools — see 3.7.

2.19**outer contour**

visible contour of an object

2.20**RECON**

determination of layers solely used to illustrate contours and dimension to exchange information for the recondition of cutting tools only

2.21**RGB-values**

red, green and blue numerical values of a colour to illustrate this colour explicit within the different CAx-systems

2.22**single part****SP**

component of an assembled tool that is needed to show the function and the collision-relevant devices

2.23**SK-layer**

<single component> determination of layers, which are intended to show only features that are used for cutting tool components and will be blank if an assembled tool is shown

2.24

SKVIEW

determination of layers applied only if it is sufficient to show the functional application on the main view

Note 1 to entry: All of the necessary views, cross sections and details have to be filed within this layer grouping.

2.25

tool axis

rotational axis

imaginary line on rotational tools where the tool revolves to actively take part in a machining process

2.26

tool component

single cutting tool or tool holder (adaptor) that can form an assembled cutting tool, if mounted

2.27

tool contour

whole visible outline of a tool

3 Layer concept

The layer structure shall be designed in a way that all requirements of the layout of cutting tool assemblies and their components shall be fulfilled. This is mainly feasible for the tool pre-setting to be used as information for the tool procurement and tool management.

The interface contours of the cutting tool components, which become invisible in the assembly, shall be filed at the SK-layers. Therefore, it is guaranteed that these contours are not shown on tool assemblies because of the confusing views.

On the other hand, it is very reasonable to show coolant channels, for example, in the tool assembly, as well as in the tool component. Therefore, Layer 3 shall be arranged to file the hidden contours contained in tool assemblies and tool components.

The same principle shall apply to the dimensioning. Here, the dimensions shall be on Layer 2 if they are visible in the assembled tool.

Layer 6, correspondingly layer SK6, shall be used for text which is independent from any language. This information shall be filed here and shall not be translated into a foreign language (e.g. catalogue number or ordering number of the tool component or of the assembled tool, and so on. Textual information that has to be interpreted in another language for better understanding shall be filed in the respective layers of the grouping "multilingual."

If, beside the main view, other views, details, and cross sections, etc. are required to the designated and functional use of graphic data the layer from the grouping, SKVIEW shall be used.

Parts of this layer concept do not meet the generally admitted exchange of graphical data, but are limited to special areas, which shall be stipulated bilaterally between the tool manufacturer, or tool supplier and the user. This applies to the area of sensitive data, e.g. the reconditioning ("RECON") of cutting tools, or also the provision of complete machine equipment layouts (Layer 100 to Layer 200).

DXF version 2000 with its code AC1015 shall be determined as the basic version for the graphical data exchange. It shall not be allowed to transfer blocks (except frames, headers, and logos), external references and OLE objects. The point of origin shall be located onto the main view, which has to be in scale 1:1.

4 Structure of the layers

4.1 General

By the explicit structure of the layers, seven main functions can be defined and shall be as given in [Table 1](#).

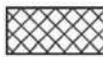







Table 1 — Grouping of the layers with their main functions

Function number	Description of the function	Grouping of the function
3.0.1	Tool drawing	Main view
3.0.2	NC-geometry	CUT, NOCUT
3.0.3	Extended tool drawing	Further views, cross sections, details, references
3.0.4	Multilingualism	Global drawings with lingual information
3.0.5	Tool reconditioning	Supplier internal information for reconditioning
3.0.6	Machine equipment layouts	Machine spindle, workpiece, fixture, operation path
3.0.7	Drawing frame	Drawing frame — multilingual and drawing space

4.2 Colouring of the layers

To make it possible to show the colours of the layers in this document, patterns are assigned to the colours. The patterns are depicted in [Table 2](#).

Table 2 — Allocation of the colours to RGB values and patterns

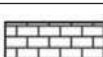
Colour	RGB-value			Colour index DXF	Pattern
	R	G	B		
Red	255	0	0	1	
Yellow	255	255	0	2	
Green	0	255	0	3	
Cyan	0	255	255	4	
Blue	0	0	255	5	
Magenta	255	0	255	6	
White	255	255	255	7	
Grey	192	192	192	9	
Orange	255	127	0	30	
Olive	0	127	0	96	

4.3 Grouping and definition of the layers

4.3.1 Grouping

The grouping of the layers is divided into three main groups:

- M = mandatory;
- C = conditional (depending on requirements);
- O = optional (upon request).

4.3.2 Basic layer

Each graphical file imported into another system via DXF interface shall have the basic layers according to [Table 3](#).

Table 3 — Basic layers

Main group	Designation	Layer name	Layer number	Layer description	Definition
0	Basic layer	0	0	System layer	Layer 0 is optional. For autocad system, layer 0 is mandatory.
0	Basic layer	Defpoints ^a	0	System layer	Compulsory needed in the CAD system; no further relevance for the drawing layout.
^a Layer is determined mainly in the 3D design mode and is not compulsory for DXF files, therefore, only optional.					

4.3.3 Tool drawing (main view — function number 3.0.1)

Within the tool drawing, Layers 1 to 4, 6, 7, and 11 for assembled tools shall be as defined in [Table 4](#) and Layers SK1 to SK4, SK6, and SK7 for tool components shall be as defined in [Table 5](#).

Table 4 — Layers for the main view for assembled cutting tools

Main group	Designation	Layer name	Layer number	Layer description	Definition
M	Main view of assembled tools and visible tool components	1	1	Contour	Outer contours that describe the contour of an assembled tool if tool components are mounted virtually.
		2	2	Dimensioning	Dimensions that are shown if different tool components are mounted virtually. Attention: The dimensions may not be drawn across the outer contour of Layer 1 because of the possible collision of the dimensions. There is also no associativity between the dimensions and the related geometrical features.
		3	3	Reference line/ inner contour	Reference lines and inner contours (invisible lines) that are displayed if an assembled tool is mounted virtually.
		4	4	Centre line	Centre lines of the single components, which create the entire centre line of the assembled tool, if mounted virtually. This centre line always starts at the first visible contour edge of the tool component and ends always at the last contour edge. It is not allowed to extend the centre line across the body contour.
		6	6	Text assembled tools (language independent)	Language-independent texts of the single components, which contain information for the assembled tool, if the components are mounted virtually. The positions of these texts should be located as accurate as possible above or below the tool component.
		7	7	Hatching	Hatching of cross sections or half cross sections, which has to be illustrated at the assembled tool, if mounted virtually.
		11	11	Additional line	Thin solid line for the illustration of thread root, imaginary line, bending line or similar drawing features.

Table 5 — Layers for the main view for tool components

Main group	Designation	Layer name	Layer number	Layer description	Definition
M	Main view of tool component —invisible on assembled tool	SK1	21	SK-contour	Outer contours of tool components, which should not be visible, if mounted virtually to an assembled tool
		SK2	22	SK-dimensioning	Dimensioning; this should be visible only within the illustration of the tool component and not be of interest either for the assembly or for consideration of collision. Attention: There will be no associativity between the dimensions and the related geometrical features.
		SK3	23	SK-reference line/inner contour	Reference lines and inner contours (invisible lines) that are not displayed if an assembled tool is mounted virtually.
		SK4	24	SK-centre line	Centre lines of the single components, which are visible only if the single component is illustrated. Remark: The centre line should start and end approximately 5 mm across the body contour in relation to the component.
		SK6	26	Textual part of a tool component (language independent)	Language-independent texts of the single components, which should not be visible if components are mounted virtually and do not contain information for the assembled tool. The positions of these texts should be located as accurately as possible above or below the tool component, but also separated from the texts contained in Layer 6.
		SK7	27	SK-Hatching	Hatching of cross sections or half cross sections, which does not have to be illustrated at the assembled tool, if mounted virtually.
		SK11	29	Additional line	Thin solid line for the illustration of thread root, imaginary line, bending line or similar drawing features, which do not have to be illustrated at the assembled tool, if mounted virtual.

4.3.4 NC-Geometry (CUT, NOCUT — function number 3.0.2)

Table 6 presents the information about the cutting and non-cutting part of an assembled tool of a tool component. Because of the different requirements regarding the creation of this information which

apply to the different CAM systems, the contours should consist of single lines, which should form a closed polyline — “contour of single lines in a closed polyline” with accuracy less than 0,001 mm.

These layers apply to tools with the following characteristics:

- Cutting and non-cutting tools;
- Rotating tools and stationary tools.

Table 6 — Layer for NC-geometry

Main group	Designation	Layer name	Layer number	Layer description	Definition
C	NC-contour of the tool for 3D simulation	CUT	15	Cutting	<p>Outer contour that defines the cutting area of the tool component.</p> <p>a) For rotating tool: By revolving around the tool axis, this contour becomes a 3D object which is used such as for NC programming.</p> <p>The cutting area shall be created as a polyline containing single lines only, which shall be taken from the cutting parts placed in the 3D coordinate system but projected onto the XZ plane defined in ISO/TS 13399-50. This means that this contour created at the workpiece by the cutting tool shall be illustrated.</p> <p>b) For stationary tool: The cutting line shall be created as a polyline containing single lines only, which shall be taken from the cutting area in the top view of the part.</p>
		NOCUT	16	Non-cutting	<p>Outer contour that defines the cutting area of the tool component. By revolving around the tool axis, this contour becomes a 3D object which is used such as for NC programming.</p> <p>Important: The areas shall be created as a polyline containing single lines only. All contours being relevant for collision shall be taken above the rotating axis. The contour shall be in accordance to all features located on the periphery projected onto the XZ plane defined in ISO/TS 13399-50.</p>

4.3.5 Extended tool drawing (further views — function number 3.0.3)

[Table 7](#) gives information about the extended tool drawing. This group of layer is applicable if it is not sufficient to illustrate the function of the tool, the arrangement of the cutting items, collision determining outer contours or other graphical features, which are important for the machining process in the main view.

The application of this layer group is upon the discretion of the designer of the drawing. It shall not be formally required and needs an agreement between the originator of the drawing and the user.

Table 7 — Layer for the extended tool drawing

Main group	Designation	Layer name	Layer number	Layer description	Definition
C	Additional views of the assembled tool or the tool component (without the main view)	SKVIEW1	31	SKVIEW-contour	Outer contour for all additional views (side view, top view, bottom view, cross section, ISO projection). The content of this layer is visible on both the tool component and the assembled tool.
		SKVIEW2	32	SKVIEW-dimensioning	Dimensioning for all additional views (for description, see SKVIEW1). Attention: There is no associativity between the dimensions and the related geometrical features.
		SKVIEW3	33	SKVIEW-reference line/inner contour	Reference lines and inner contours (invisible lines) for all additional views (for description, see SKVIEW1).
		SKVIEW4	34	SKVIEW-centre line	Centre lines for all additional views (for description, see SKVIEW1). NOTE See SK4 in Table 5 .
		SKVIEW6	36	SKVIEW-reference line/inner contour	Language-independent texts for all additional views (for description, see SKVIEW1).
		SKVIEW7	37	SKVIEW-centre line	Hatching of cross sections or half cross sections for all additional views (for description, see SKVIEW1).
		SKVIEW11	39	SKVIEW-additional line	Thin solid line for the illustration of thread root, imaginary line, bending line or similar drawing features (for description, see SKVIEW1).

4.3.6 Multilingual (global drawing — function number 3.0.4)

The multilingualism, according to [Table 8](#), shall be necessary for all functional grouping where a layer is defined with the layer number “x5x” or “x6x.”

This layer shall be defined as a two-digit number. It is denoted as 6-1 (six-one), for example. However, some CAx systems cannot reproduce this differentiation.

Table 8 — Layer for multilingualism

Main group	Designation	Layer name	Layer number	Layer description	Definition
0	Labelling of the text fields within the drawing frame (including multilingualism)	51	51	Texts within drawing frame (English)	Information in the text fields within the drawing frame given in the particular language
		52	52	Texts within drawing frame (French)	
		53	53	Texts within drawing frame (German)	
		54 to 59	54 to 59	Texts within drawing frame (additional languages)	
C	Labelling of assembled tools (including multilingualism)	61	61	Texts for assembled tool (English)	Texts of the tool component, which contains information for the assembled tools, given in the particular language, if mounted virtually.
		62	62	Texts for assembled tool (French)	
		63	63	Texts for assembled tool (German)	
		64 to 69	64 to 69	Texts for assembled tool (additional languages)	
	Labelling of tool components (including multilingualism)	SK61	71	Texts for assembled tool (English)	Texts of the tool component given in the particular language, which is not of interest for the assembled tool, if mounted virtually.
		SK62	72	Texts for assembled tool (French)	
		SK63	73	Texts for assembled tool (German)	
		SK64 to SK69	74 to 79	Texts for assembled tool (additional languages)	
C	Labelling of additional views (including multilingualism)	SKVIEW61	81	SKVIEW-LABEL (English)	Text of all additional views given in the particular language
		SKVIEW62	82	SKVIEW-LABEL (French)	
		SKVIEW63	83	SKVIEW-LABEL (German)	
		SKVIEW64-SKVIEW69	84 to 89	SKVIEW-LABEL (additional languages)	
0	Labelling of reconditioning (including multilingualism)	RECON61	111	RECON-LABEL (English)	Texts given in the particular language, which contain information for the reconditioning process
		RECON62	112	RECON-LABEL (French)	
		RECON63	113	RECON-LABEL (German)	
		RECON64 to RECON69	114 to 119	RECON-LABEL (additional languages)	

Table 8 (continued)

Main group	Designation	Layer name	Layer number	Layer description	Definition
C	Labelling of additional texts for tool components which do not belong to geometry (including multilingualism)	INFTEXT61	121	INFTEXT (English)	Additional texts in the particular language, which cannot be related to any layer group, but which are important for the use of assembled tools or tool components.
		INFTEXT62	122	INFTEXT (French)	
		INFTEXT63	123	INFTEXT (German)	
		INFTEXT64 to INFTEXT69	124 to 129	INFTEXT (additional languages)	

4.3.7 Tool reconditioning (supplier specific information — function number 3.0.5)

[Table 9](#) gives information for the tool reconditioning which is not part of a standardised graphical data exchange. This information shall be communicated bilaterally between the manufacturer or supplier and the user.

In this part of ISO/TS 13399, only the layers are defined and standardized for this kind of documentation, in which the suitable information should be filed. The level of detail of this graphical information shall be also negotiated bilaterally between the involved parties.

This part of ISO/TS 13399 does not determine any entitlement of the user for the data exchange of this kind of documentation.

Table 9 — Layer for tool reconditioning data

Main group	Designation	Layer name	Layer number	Layer description	Definition
0	Tool reconditioning of tool components	RECON1	101	RECON-contour	Contour lines for all additional views that are necessary for the tool reconditioning.
		RECON2	102	RECON-dimensioning	Dimensioning for all additional views that is necessary for the tool reconditioning. Attention: There is no associativity between the dimensions and the related geometrical features.
		RECON3	103	RECON-reference line/ inner contour	Reference lines and inner contours (invisible lines) for all additional views that are necessary for the tool reconditioning.
		RECON4	104	RECON-centre line	Centre lines for all additional views that are necessary for the tool reconditioning. Remark: See SK4 in Table 5 .
		RECON6	106	RECON-label (language independent)	Language-independent texts for all additional views that are necessary for the tool reconditioning.
		RECON7	107	RECON-hatching	Hatchings for all additional views that are necessary for the tool reconditioning.
		RECON11	109	RECON-additional line	Thin solid line for the illustration of thread root, imaginary line, bending line or similar drawing features for all additional views that will be necessary for the tool reconditioning.

4.3.8 Machine equipment layout (machining processes — function number 3.0.6)

Machine equipment layouts, according to [Table 10](#), are required to be able to document complete machining processes of a workpiece. This kind of the documentation is created predominantly by the tool user because only he disposes of the knowledge of the required application data. Within the scope of the standardization of the layers, this subclause is also important for the application of the layer setting. Machine equipment layouts are created only in direct arrangement between the supplier and the end user.

Table 10 — Layer for machine equipment layout

Main group	Designation	Layer name	Layer number	Layer description	Definition
0	Workpiece component	INFWKP	133	Workpiece geometry	Illustration, also in sections, of the workpiece for tool components and machine equipment layouts to be able to identify interference contours during tool development and the process sequence.
0	Machine equipment layout	100	100	Assembled tool	Geometries from the Layers 1 to 11 of the single tool components and geometries from the Layers SK1 to SK7 of the connection in the direction towards the machine tool spindle of that tool component nearest the machine tool spindle.
		110	110	Dimensioning	Dimensions of the machine equipment layout; if applicable, adaption of the dimensions of the single tool components from Layer 2. No associativity between the dimensions and the related geometrical features and no control characters.
		120	120	Machine spindle	Illustration of the machine tool spindle and its elements being relevant for collision.
		130	130	Motion-sequence, operation chart	Illustration of the motions of the cutting tool (tool path) and/or the motions of the workpiece.
		140	140	Lettering/text	Language-independent and language-dependent texts of the machine equipment layout; if applicable, adaption of the relevant texts from the lettering layers of the tool.
		150	150	Clamping devices, fixtures	Clamping devices and fixtures that are important for the process flow in terms of collision and simulation.
		160	160	Inspection devices, measuring parts	Illustration of inspection devices that are applied during the machining process into the machine equipment layout.
0	Machine equipment layout/work piece component	200	200	Other geometries	E.g. disruption lines, frames around texts, a. s. o

4.3.9 Drawing frame (multilingual and drawing space — function number 3.0.7)

Drawing frames shall be filed in its layout on different layers layout depending on the indicated language, according to [Table 11](#). On this occasion, the invariable text field names are also a component of the respective drawing frame.

Table 11 — Layer for drawing frame

Main group	Designation	Layer name	Layer number	Layer description	Definition
0	Drawing frame and area of geometry	FRAME50	90	Drawing frame with all fields	Graphical characteristic of the drawing frame with company logo.
		FRAME51	91	Fixed text field names (English)	Names of the text fields given in the designated language. WARNING: No text field contents.
		FRAME52	92	Fixed text field names (French)	
		FRAME53	93	Fixed text field names (German)	
		FRAME54 to FRAME59	94 to 99	Fixed text field names (additional languages)	
		INF-MAIN-VIEW	131	Expansion of the main view	Horizontal and vertical expansion of the content of Layers 1 to 11 and SK1 to SK11 (indicated are both horizontal and vertical lines with their maximum elongation).
		INF-TOTAL	132	Expansion of the entire geometry and all of the additional information	Horizontal and vertical expansion of the content of all graphics, including all of the additional information, but excluding the frame (indicated are both horizontal and vertical lines with their maximum elongation).

NOTE If a drawing frame in another language is defined on a layer "FRAME5x," the number "x" shall be used for all other language-dependent layers for this defined language.

EXAMPLE Layer FRAME54 is given for a Spanish drawing frame; therefore, Layers 54, 64, and SK64 a. s. o. shall be specified for the Spanish language.

4.4 Determination of the layer properties

Beside the definitions of the layers and their use agreed in [5.3](#), the attributes of the layers such as colour, line type, etc. shall be determined according to [Table 12](#). These attributes cannot be changed and form the basis of the graphic data exchange.

Table 12 — Definition of the layer properties







Pos. no.	Layer no.	Layer name	MV	AT	SP	Drawing	Colour	R	G	B	Colour index	Scale	Line type	Line size	Example line type	Font type	Font size
1	0	System layer	-a	Y ^b	Y	Y	-	-	-	-	-	-	-	-	-	-	-
2	Defpoints	System layer	-	Y	Y	Y	-	-	-	-	-	-	-	-	-	-	-
3	1	Contour	Y	Y	Y	Y	Cyan	0	255	255	4	1:1	Continuous wide line	0,5		-	-
4	2	Dimensioning	Y	Y	Y	Y	White	255	255	255	7	1:1	Continuous wide line	0,25		Monospace 821BT	3,5
5	3	Reference line/ inner contour	Y	Y	Y	Y	Red	255	0	0	1	1:1	Dashed narrow line	0,35		-	-
6	4	Centre line	Y	Y	Y	Y	Yellow	255	255	0	2	1:1	Long dashed dotted narrow line	0,25		-	-
7	6	Text assembled tools (language independent)	Y	Y	Y	Y	Blue	0	0	255	5	1:1	Continuous wide line	-		Monospace 821BT	3,5
8	7	Hatching	Y	Y	Y	Y	Blue	0	0	255	5	1:1	Continuous wide line	0,25		-	-
9	11	Additional line	Y	Y	Y	Y	Cyan	0	255	255	4	1:1	Continuous wide line	0,25		-	-
10	CUT	Cutting	Y	NV ^c	Nv	Y	Red	255	0	0	1	1:1	Continuous wide line	0,25		-	-
<p>^a Not applicable for this characteristic.</p> <p>^b Applicable and necessary for this characteristic.</p> <p>^c Invisible for this characteristic.</p> <p>^d Not applicable and not necessary for this characteristic.</p>																	

Table 12 (continued)









Pos. no.	Layer no.	Layer name	MV	AT	SP	Drawing	Colour	R	G	B	Colour index	Scale	Line type	Line size	Example line type	Font type	Font size
11	NOCUT	Non-cutting	Y	NV	Nv	Y	White	255	255	255	7	1:1	Continuous wide line	0,25		-	-
12	SK1	SK-contour	Y	N ^d	Y	Y	Cyan	0	255	255	4	1:1	Continuous wide line	0,5		-	-
13	SK2	SK-dimensioning	Y	N	Y	Y	White	255	255	255	7	1:1	Continuous wide line	0,25		Monospace 821BT	3,5
14	SK3	SK-reference line/inner contour	Y	N	Y	Y	Red	255	0	0	1	1:1	Dashed narrow line	0,35		-	-
15	SK4	SK-centre line	Y	N	Y	Y	Yellow	255	255	0	2	1:1	Long dashed dotted narrow line	0,25		-	-
16	SK6	Textual part of tool component (language independent)	Y	N	Y	Y	Blue	0	0	255	5	1:1	Continuous wide line	-		Monospace 821BT	3,5
17	SK7	SK-hatching	Y	N	Y	Y	Blue	0	0	255	5	1:1	Continuous wide line	0,25		-	-
18	SK11	SK-additional line	Y	N	Y	Y	Cyan	0	255	255	4	1:1	Continuous wide line	0,25		-	-
19	SKVIEW1	SKVIEW-contour	N	N	Y	Y	Cyan	0	255	255	4	To scale	Continuous wide line	0,5		-	-
a	Not applicable for this characteristic.																
b	Applicable and necessary for this characteristic.																
c	Invisible for this characteristic.																
d	Not applicable and not necessary for this characteristic.																

Table 12 (continued)











Pos. no.	Layer no.	Layer name	MV	AT	SP	Drawing	Colour	R	G	B	Colour index	Scale	Line type	Line size	Example line type	Font type	Font size
20	SKVIEW2	SKVIEW-dimensioning	N	N	Y	Y	White	255	255	255	7	To scale	Continuous wide line	0,25		Monospace 821BT	3,5
21	SKVIEW3	SKVIEW-reference line/inner contour	N	N	Y	Y	Red	255	0	0	1	To scale	Dashed narrow line	0,35		-	-
22	SKVIEW4	SKVIEW-centre line	N	N	Y	Y	Yellow	255	255	0	2	To scale	Long dashed dotted narrow line	0,25		-	-
23	SKVIEW6	SKVIEW-text (language independent)	N	N	Y	Y	Blue	0	0	255	5	1:1	Continuous wide line	-		Monospace 821BT	3,5
24	SKVIEW7	SKVIEW-hatching	N	N	Y	Y	Blue	0	0	255	5	To scale	Continuous wide line	0,25		-	-
<p>a Not applicable for this characteristic.</p> <p>b Applicable and necessary for this characteristic.</p> <p>c Invisible for this characteristic.</p> <p>d Not applicable and not necessary for this characteristic.</p>																	

Table 12 — (continued)

Pos. no.	Layer no.	Layer name	MV	AT	SP	Drawing	Colour	R	G	B	Colour index	Scale	Line type	Line size	Example line type	Font type	Font size
25	SKVIEW11	SKVIEW-additional line	N	N	Y	Y	Cyan	0	255	255	4	To scale	Continuous wide line	0,25		-	-
26	RECON1	RECON-contour	N	N	N	Y	Cyan	0	255	255	4	At user's discretion	Continuous wide line	0,5		-	-
27	RECON2	RECON-dimensioning	N	N	N	Y	White	255	255	255	7	At user's discretion	Continuous wide line	0,25		Mono-space 821BT	3,5
28	RECON3	RECON-reference line/inner contour	N	N	N	Y	Red	255	0	0	1	At user's discretion	Dashed narrow line	0,35		-	-
29	RECON4	RECON-centre line	N	N	N	Y	Yellow	255	255	0	2	At user's discretion	Long dashed dotted narrow line	0,25		-	-
30	RECON6	RECON-label (language independent)	N	N	N	Y	Blue	0	0	255	5	At user's discretion	Continuous wide line	-		Mono-space 821BT	3,5
31	RECON7	RECON-hatching	N	N	N	Y	Blue	0	0	255	5	At user's discretion	Continuous wide line	0,25		-	-
32	RECON11	RECON-additional line	N	N	Y	Y	Cyan	0	255	255	4	To scale	Continuous wide line	0,25		-	-

- a Not applicable for this characteristic.
- b Applicable and necessary for this characteristic.
- c Invisible for this characteristic.
- d Not applicable and not necessary for this characteristic.

Table 12 (continued)







Pos. no.	Layer no.	Layer name	MV	AT	SP	Drawing	Colour	R	G	B	Colour index	Scale	Line type	Line size	Example line type	Font type	Font size
33	FRAME50	Drawing frame	N	N	N	Y	White	255	255	255	7	1:1	Continuous wide line	At user's discretion			
34	FRAME51	Fixed text field names (English)	N	N	N	Y	White	255	255	255	7	1:1	Continuous wide line	At user's discretion		Monospace 821BT	At user's discretion
35	FRAME52	Fixed text field names (French)	N	N	N	Y	White	255	255	255	7	1:1	Continuous wide line	At user's discretion		Monospace 821BT	At user's discretion
36	FRAME53	Fixed text field names (German)	N	N	N	Y	White	255	255	255	7	1:1	Continuous wide line	At user's discretion		Monospace 821BT	At user's discretion
37	FRAME54-FRAME59	Fixed text field names (additional languages)	N	N	N	Y	White	255	255	255	7	1:1	Continuous wide line	At user's discretion		Monospace 821BT	At user's discretion
38	INF-MAIN-VIEW	Expansion of the main view	Y	NV	NV	NV	Grey	192	192	192	9	1:1	Continuous wide line	0,18		-	-
39	INFTOTAL	Expansion of the entire geometry and all of the additional information	N	NV	NV	NV	Grey	192	192	192	9	1:1	Continuous wide line	0,18		-	-
40	51	Texts within drawing frame (English)	N	N	N	Y	Blue	0	0	255	5	At user's discretion	Continuous wide line	Based on font size		Monospace 821BT	3,5/5/7/10
<p>a Not applicable for this characteristic.</p> <p>b Applicable and necessary for this characteristic.</p> <p>c Invisible for this characteristic.</p> <p>d Not applicable and not necessary for this characteristic.</p>																	

Table 12 (continued)

Pos. no.	Layer no.	Layer name	MV	AT	SP	Drawing	Colour	R	G	B	Colour index	Scale	Line type	Line size	Example line type	Font type	Font size
41	52	Texts within drawing frame (French)	N	N	N	Y	Blue	0	0	255	5	At user's discretion	Continuous wide line	Based on font size		Mono-space 821BT	3,5/5/7/10
42	53	Texts within drawing frame (German)	N	N	N	Y	Blue	0	0	255	5	At user's discretion	Continuous wide line	Based on font size		Mono-space 821BT	3,5/5/7/10
43	54-59	Texts within drawing frame (additional languages)	N	N	N	Y	Blue	0	0	255	5	At user's discretion	Continuous wide line	Based on font size		Mono-space 821BT	3,5/5/7/10
<p>a Not applicable for this characteristic.</p> <p>b Applicable and necessary for this characteristic.</p> <p>c Invisible for this characteristic.</p> <p>d Not applicable and not necessary for this characteristic.</p>																	

Table 12 — (continued)

Pos. no.	Layer no.	Layer name	MV	AT	SP	Drawing	Colour	R	G	B	Colour index	Scale	Line type	Line size	Example line type	Font type	Font size
44	61	Texts for assembled tool (English)	Y	Y	Y	Y	Blue	0	0	255	5	1:1	Continuous wide line	-		Monospace 821BT	3,5
45	62	Texts for assembled tool (French)	Y	Y	Y	Y	Blue	0	0	255	5	1:1	Continuous wide line	-		Monospace 821BT	3,5
46	63	Texts for assembled tool (German)	Y	Y	Y	Y	Blue	0	0	255	5	1:1	Continuous wide line	-		Monospace 821BT	3,5
47	64-69	Texts for assembled tool (additional languages)	Y	Y	Y	Y	Blue	0	0	255	5	1:1	Continuous wide line	-		Monospace 821BT	3,5
48	SK61	Text for tool component (English)	Y	N	Y	Y	Blue	0	0	255	5	1:1	Continuous wide line	-		Monospace 821BT	3,5
49	SK62	Text for tool component (French)	Y	N	Y	Y	Blue	0	0	255	5	1:1	Continuous wide line	-		Monospace 821BT	3,5
50	SK63	Text for tool component (German)	Y	N	Y	Y	Blue	0	0	255	5	1:1	Continuous wide line	-		Monospace 821BT	3,5
51	SK64–SK69	Text for tool component (additional languages)	Y	N	Y	Y	Blue	0	0	255	5	1:1	Continuous wide line	-		Monospace 821BT	3,5
52	SK-VIEW61	SKVIEW-LABEL (English)	N	N	Y	Y	Blue	0	0	255	5	1:1	Continuous wide line	-		Monospace 821BT	3,5
<p>a Not applicable for this characteristic.</p> <p>b Applicable and necessary for this characteristic.</p> <p>c Invisibile for this characteristic.</p> <p>d Not applicable and not necessary for this characteristic.</p>																	

Table 12 (continued)

Pos. no.	Layer no.	Layer name	MV	AT	SP	Drawing	Colour	R	G	B	Colour index	Scale	Line type	Line size	Example line type	Font type	Font size
53	SK-VIEW62	SKVIEW-LABEL (French)	N	N	Y	Y	Blue	0	0	255	5	1:1	Continuous wide line	-		Mono-space 821BT	3,5
54	SK-VIEW63	SKVIEW-LABEL (German)	N	N	Y	Y	Blue	0	0	255	5	1:1	Continuous wide line	-		Mono-space 821BT	3,5
55	SK-VIEW64 - SK-VIEW69	SKVIEW-LABEL (additional languages)	N	N	Y	Y	Blue	0	0	255	5	1:1	Continuous wide line	-		Mono-space 821BT	3,5
56	RECON61	RECON-LABEL (English)	N	N	N	Y	Blue	0	0	255	5	At user's discretion	Continuous wide line	-		Mono-space 821BT	3,5
57	RECON62	RECON-LABEL (French)	N	N	N	Y	Blue	0	0	255	5	At user's discretion	Continuous wide line	-		Mono-space 821BT	3,5
58	RECON63	RECON-LABEL (German)	N	N	N	Y	Blue	0	0	255	5	At user's discretion	Continuous wide line	-		Mono-space 821BT	3,5
59	RECON64-RECON69	RECON-LABEL (additional languages)	N	N	N	Y	Blue	0	0	255	5	At user's discretion	Continuous wide line	-		Mono-space 821BT	3,5
60	INF-TEXT61	INFTEXT (English)	N	N	N	Y	Blue	0	0	255	5	1:1	Continuous wide line	Based on font size		Mono-space 821BT	3,5/5/7/10
a	Not applicable for this characteristic.																
b	Applicable and necessary for this characteristic.																
c	Invisible for this characteristic.																
d	Not applicable and not necessary for this characteristic.																

Table 12 (continued)

Pos. no.	Layer no.	Layer name	MV	AT	SP	Drawing	Colour	R	G	B	Colour index	Scale	Line type	Line size	Example line type	Font type	Font size
61	INF-TEXT62	INFTEXT (French)	N	N	N	Y	Blue	0	0	255	5	1:1	Continuous wide line	Based on font size		Mono-space 821BT	3,5/5/7/10
62	INF-TEXT63	INFTEXT (German)	N	N	N	Y	Blue	0	0	255	5	1:1	Continuous wide line	Based on font size		Mono-space 821BT	3,5/5/7/10
63	INF-TEXT64 - INF-TEXT69	INFTEXT (additional languages)	N	N	N	Y	Blue	0	0	255	5	1:1	Continuous wide line	Based on font size		Mono-space 821BT	3,5/5/7/10
64	INFWKP	Workpiece geometry	N	N	N	Y	Orange	255	127	0	30	1:1/to scale	Long dashed double dotted narrow line	0,25	— . . —		
65	100	Assembled tool	N	N	N	Y	Cyan	0	255	255	4	To scale	At user's discretion	Based on line type		-	-
66	110	Dimensioning	N	N	N	Y	White	255	255	255	7	To scale	Continuous wide line	0,25	————	Mono-space 821BT	3,5
67	120	Machine spindle	N	N	N	Y	Green	0	255	0	3	To scale	At user's discretion	Based on line type		-	-
68	130	Motion-sequence, operation chart	N	N	N	Y	Magenta	255	0	255	6	To scale	At user's discretion	Based on line type		-	-
69	140	Lettering/text	N	N	N	Y	Blue	0	0	255	5	1:1	Continuous wide line	Based on font size		Mono-space 821BT	3,5/5/7/10

- a Not applicable for this characteristic.
- b Applicable and necessary for this characteristic.
- c Invisible for this characteristic.
- d Not applicable and not necessary for this characteristic.

Table 12 (continued)

Pos. no.	Layer no.	Layer name	MV	AT	SP	Drawing	Colour	R	G	B	Colour index	Scale	Line type	Line size	Example line type	Font type	Font size
70	150	Clamping devices, fixtures	N	N	N	Y	Olive	0	127	0	96	To scale	At user's discretion	Based on line type		-	-
71	160	Inspection devices, measuring parts	N	N	N	Y	Red	255	0	0	1	To scale	At user's discretion	Based on line type		-	-
72	200	Other geometries	N	N	N	Y	Yellow	255	255	255	2	To scale	At user's discretion	Based on line type		-	-
<p>a Not applicable for this characteristic.</p> <p>b Applicable and necessary for this characteristic.</p> <p>c Invisible for this characteristic.</p> <p>d Not applicable and not necessary for this characteristic.</p>																	

4.5 Rules of the layer concept

The different contours shall be placed on the appropriate layers as defined in [Tables 3 to 11](#). For the application within, for example, tool management systems, NC-programming systems and simulation software systems, the layer extension (see [4.3.5 to 4.3.9](#)) shall not be taken into account.

For the layer structure, the rules shall be applied according to [Table 13](#).

Table 13 — Rules for the layer structure

Rule number	Description	Layer
1	Outside contour — visible for tool assemblies	1
2	Outside contour of the interface — invisible for tool assemblies	SK1
3	Inside contour (hidden lines), only visible on tool components	SK3
4	Inside contour (hidden lines), which shall be visible on tool components as well as on tool assemblies (e.g. coolant channels)	3
5	Contour of the non-cutting elements (features)	NOCUT
6	Contour of the cutting elements (features)	CUT
7	Dimensions that are visible for the tool assembly	2
8	Dimensions that are visible only for the tool component	SK2
9	Centre line used for the tool assembly — the length is equivalent to the useable length	4
10	Centre line used for the tool component — the length may extend about 5 mm across the tool contour	SK4
11	Text which is readable on the tool assembly as well as on the tool component	6
12	Text which is readable only on the tool component	SK6
13	Texts which are language independent and applicable only for the additional views	SKVIEW6
14	Hatching of cross sections, half cross sections and details which are visible on both the assembled tools and the tool components	7
15	Hatching of cross sections, half cross sections and details which are only visible on the tool component	SK7
16	Hatching of cross sections, half cross sections and details which are only applicable for the additional views	SKVIEW7
17	Drawing frame with its field names which is defined language dependent and filed on the appropriate layers according to the determination of the language	FRAME50 to FRAME59
18	Language-dependent information which is attached to the appropriate defined text layers according to its assignment to geometry, additional views, drawing frame or information layers	51 to 59; 61 to 69; SK61 to SK69; SKVIEW61 to SKVIEW69; INFTEXT61 to INFTEXT69; RECON61 to RECON69;
19	If another language that is not defined yet is necessary, all the language-dependent layers are allocated with the same logic: e.g. for the Spanish language Layer 64, then also Layers SK64, 54, and SKVIEW64.	64, 54, SK64, etc.
20	Information — of graphical or textual manner — in terms of regrinding is negotiated in principle bilateral between the involved parties	RECON1 to RECON69

5 Data concept

5.1 Origin points and mating points

5.1.1 Rotationally symmetric cutting tool assembly

Assembled tools shall be mounted within the CAD system from left side to right side, from the machine tool to the workpiece (see [Figure 1](#)).

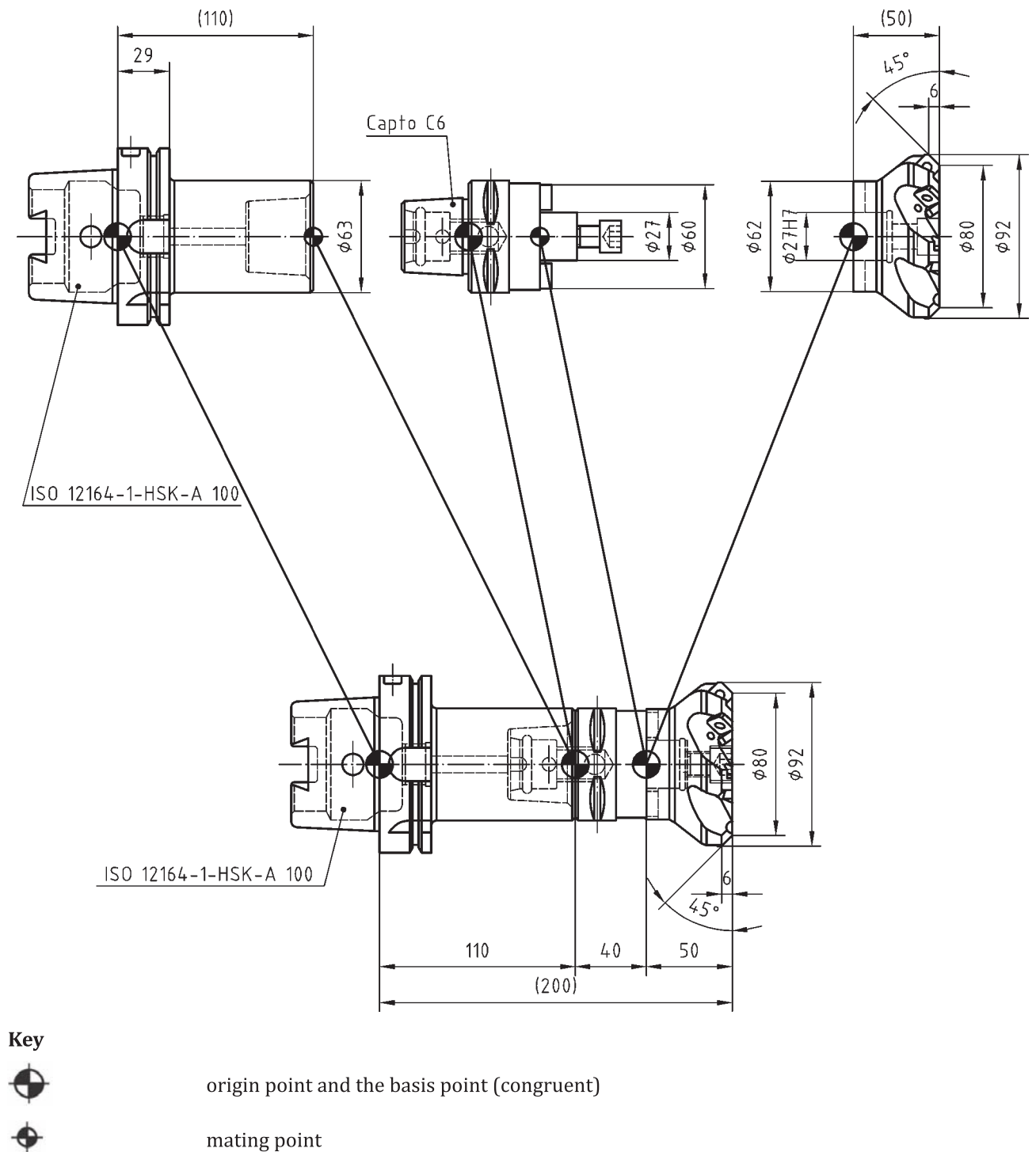
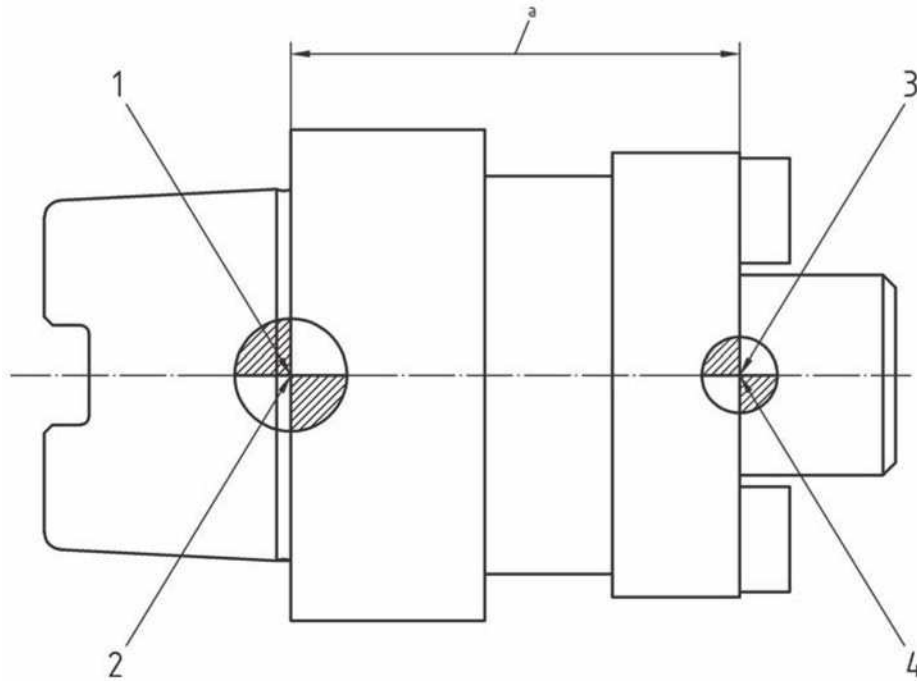

Figure 1 — Origin point (basis point) and mating points of a rotationally symmetric cutting tool assembly

The mating point(s) is (are) always placed in the direction of the workpiece, and the origin point of the tool component is always located in the direction of the machine tool. It is also important that the origin point of the tool component shall be congruent with the origin point of the drawing (basis point). Otherwise, collision problems can occur during the virtual mounting by faulty positioning.

The position of the origin point of the drawing (origin point of DXF) and the application length or the mating point of a tool component is simply displayed as illustrated in [Figure 2](#).



Key

- 1 and 2 drawing origin point (basis point): left-hand origin point of the tool component (left-hand mating point to next tool component for the assembled tool)
- 3 and 4 right-hand mating point of the tool component (connection point to the next tool component on the right-hand side)
- a LF: functional length.

Figure 2 — Schematic layout of origin point and mating point

5.1.2 Non-rotationally symmetric cutting tool assembly

The origin point and the mating point of inserts are illustrated in [Figure 3](#) and in accordance with the definitions of reference systems and common concepts in ISO/TS 13399-50. The point of origin of the replaceable insert is at the theoretical sharp corner of the insert as shown in [Figure 3](#).

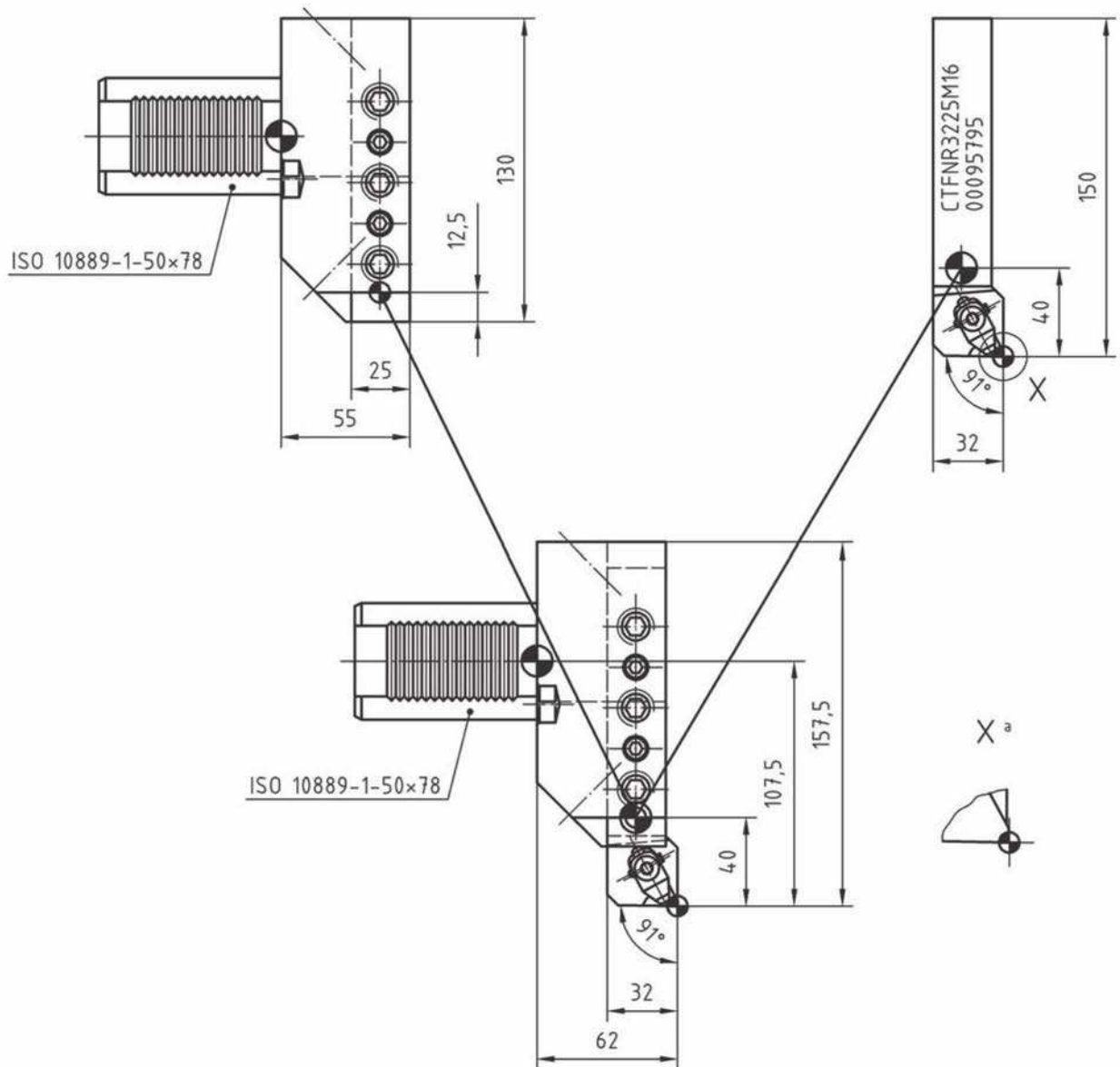

Key



origin point and the basis point (congruent)



mating point

a

Detail X (10x1).

Figure 3 — Origin point (basis point) and mating points of a non-rotationally symmetric cutting tool

The positions of the origin points and the mating points on lathe cutting tools are recommendations based on the experiences got from several cutting tool data management systems. The definition of the distances in x-, y- and z-directions from the origin point determines the location of the reference mating point.

The location of the point of origin, e.g. at the middle of the shank with the protruding length, shall be reasonable in case of the publication of the protruding length in the cutting tool catalogues. The point of origin at inserts is the theoretical sharp corner of major and minor cutting edge. At parting (cut off)

inserts, the point of origin is exactly on the symmetry axis of the insert because of the possibility of mounting different parting width onto the same basic holder.

NOTE The exact definitions of the points of origin and the mating points of regular and irregular inserts are given in the ISO/TS 13399 series:

— concept of 3D models based on properties defined in the ISO/TS 13399 series — 3D models for regular inserts;

— concept of 3D models based on properties defined in the ISO/TS 13399 series — 3D models for irregular inserts.

The drawing of a cutting tool component shall be shown in the way that the point of origin is congruent with the origin of the drawing layout. The mating point shall not be defined within the image. Its position shall be defined with the distances from the origin at the corresponding vector directions that have to be calculated in means of the application (see also definitions for CSW in ISO/TS 13399-50).

By means of the high variety at non-rotationally cutting tool assemblies, additional data may be necessary for the correctness of the graphical display, which shall be used within cutting tool data management systems.

Thus, on cutting tool components:

— the distance between point of origin and the reference point for the assembly of the next component;

and on cutting tool assemblies:

— the position within the Cartesian coordinate system of each of the component for its application;

— the position “normal” or “drop head” at tool holders (lathe tools);

— the rectified functional width at cut off inserts;

— the transition vectors at modified protruding length of the cutting component.

5.2 Rules for the Layer CUT and NOCUT

A 3D-model for simulation can be created by means of rotating a 2D-graphic design of an assembled tool around its tool axis, which is mounted virtually out of tool components (see [Figure 4](#)).

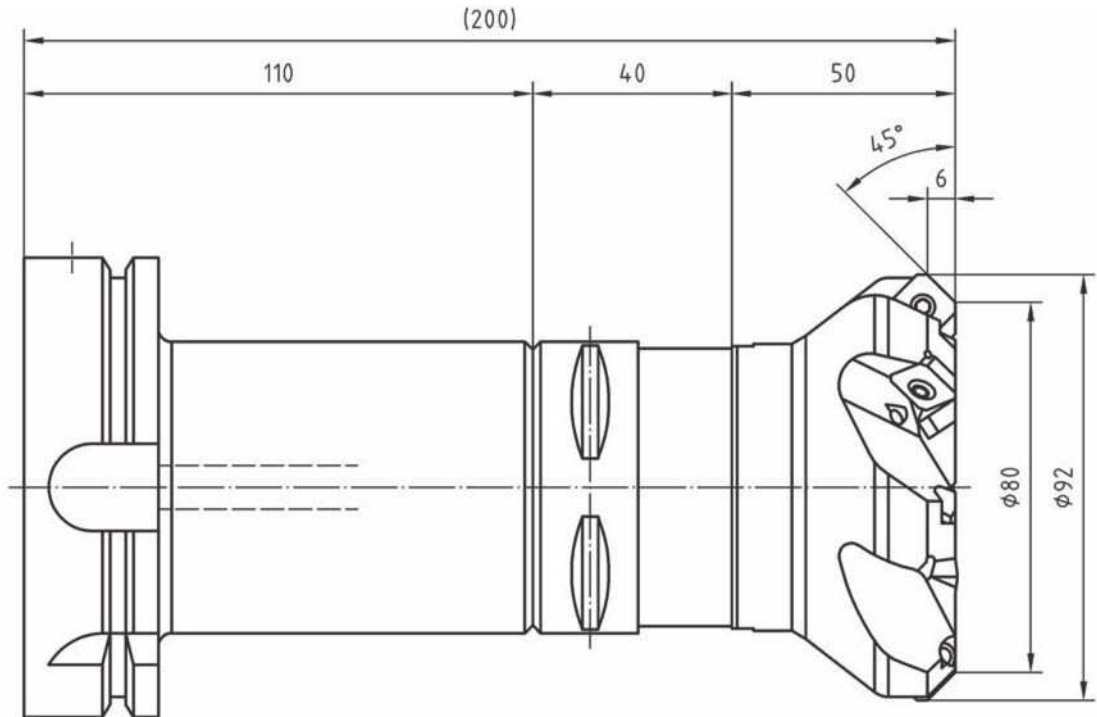

Figure 4 — Assembled tool — Illustration of Layers 1 to 11

The cladding contour, shown as a 2D graphic, of each single cutting tool component shall be closed without any gap and shall be used for the creation of the 3D assembly tool as is — without any gap between the individual single lines according to the definitions for CUT and NOCUT (see [Figure 5](#)).

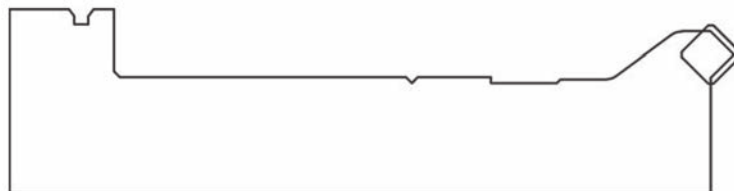

Figure 5 — Layers CUT and NOCUT

Revolving the 2D-layer CUT and NOCUT around the tool axis, a 3D wireframe model is created (see [Figure 6](#).)

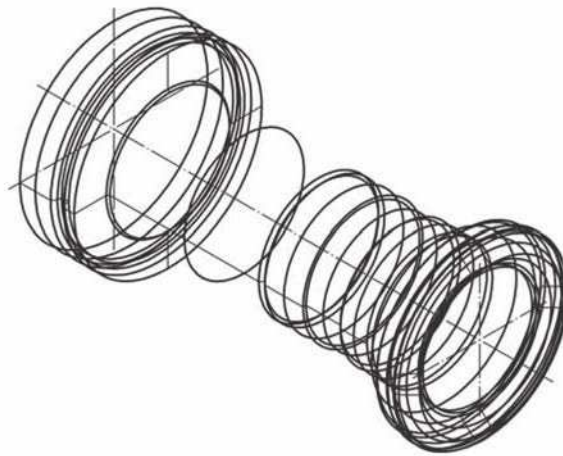

Figure 6 — 3D cutting tool assembly — Wireframe model

After the cutting tool combination is assembled, the 3D model for simulation shall be created by means of rotating the outline contour of the individual cutting tool components around their tool axis (see [Figure 7](#).)



Key

- 1 Layer NOCUT
- 2 Layer CUT

Figure 7 — Solid model with cut and no cut layers

5.3 Rules for the concept of dimensioning

5.3.1 General

Based on different native sources of CAD-systems, the dimensions shall not be associated to the geometry. Dimensions shall be to scale 1:1. Furthermore, the block structure of the dimension can be disbanded. Dimension line, projection line, arrow head and dimension can be addressed separately if the exporting system is not capable to transmit the block structure.

5.3.2 Cutting tool component

For the cutting tool components, the rules are applied as follows:

- The point of origin on rotationally symmetric components is the intersection of the centre line and the planar surface of the shank on the machine side, the planar reference surface of the gauge line

which shall be visible in the assembly view of the cutting tool combination (see [Figures 1](#) and [2](#) and ISO/TS 13399-50).

- The functional lengths and collision diameters of each cutting tool component shall be indicated in the assembly view of the cutting tool combination. The distance of the dimension line from the centre line at rotationally symmetric images shall be determined within a 15 mm grid starting from the centre line, where a minimum distance of 15 mm from the outline of the cutting tool body shall be kept (see [Figure 8](#)).

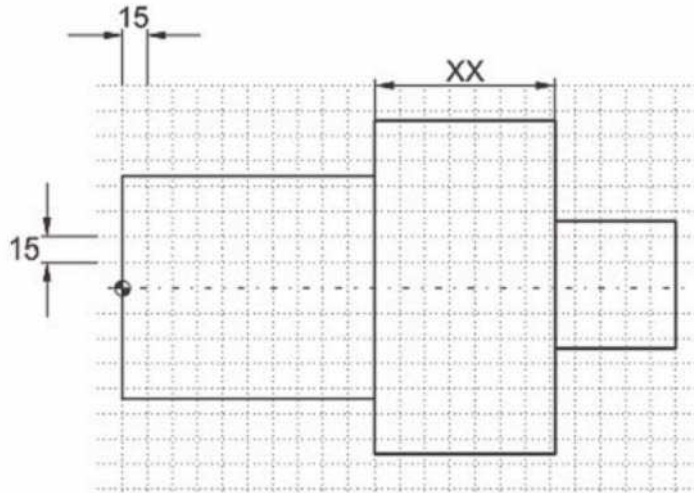

Figure 8 — 15 mm grid for dimensions

5.3.3 Cutting tool combination

For the cutting tool combinations, the rules are applied as follows:

- Overall length, functional length and functional width (only at non-rotationally symmetric components, e.g. tool holder) shall be measured from the point of origin of the adaptor to the cutting corner.
- All functional lengths of each cutting tool component shall be indicated within a 15 mm grid from the centre line or backing surface, where a minimum distance of 15 mm from the largest outline body contour shall be kept.
- If the cutting diameter is not the outermost one, all collision diameters of the components shall be visible at the cutting tool combination.

Annex A (informative)

Examples of the layer structure

A.1 Tool component — Adaptive item — Rotationally symmetric

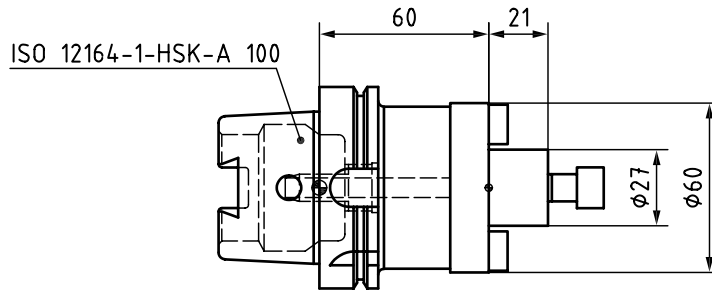

Figure A.1 — Tool component — All layers

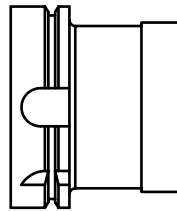

Figure A.2 — Layer 1 — Outer contour for assembled tool

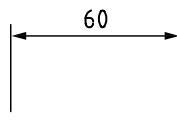

Figure A.3 — Layer 2 — Dimensioning for assembled tool

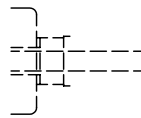

Figure A.4 — Layer 3 — Reference lines/invisible lines for assembled tool

Figure A.5 — Layer 4 — Centre lines for assembled tool

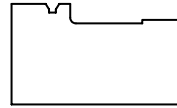

Figure A.6 — Layer NOCUT — Non-cutting cladding contour



Figure A.7 — Layer SK1 — Outer contour of the tool component

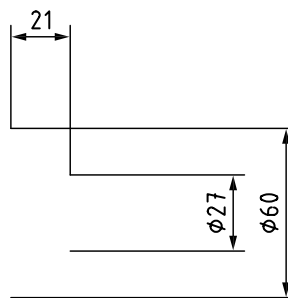

Figure A.8 — Layer SK2 — Dimensioning of the tool component

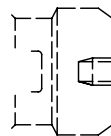

Figure A.9 — Layer SK3 — Reference lines/invisible lines of the tool component

Figure A.10 — Layer SK4 — Centre lines of the tool component

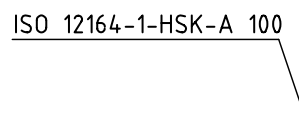

Figure A.11 — Layer SK6 — Lettering (language independent) of the tool component

A.2 Tool component — Cutting tool — Rotationally symmetric

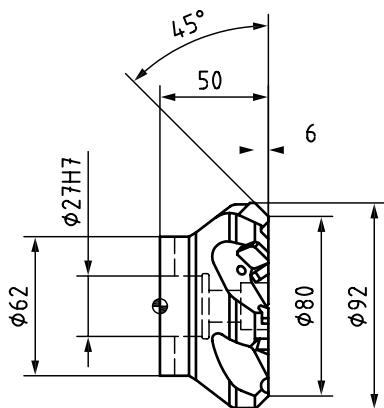

Figure A.12 — Tool component — All layers

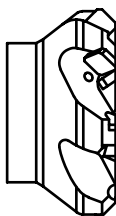

Figure A.13 — Layer 1 — Outer contour for assembled tool

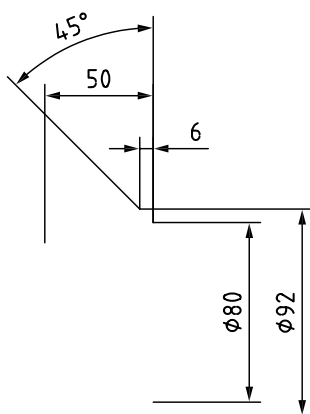

Figure A.14 — Layer 2 — Dimensioning for assembled tool

Figure A.15 — Layer 4 — Centre lines for assembled tool

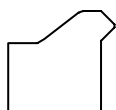

Figure A.16 — Layer NOCUT — Non-cutting cladding contour



Figure A.17 — Layer CUT — Cutting cladding contour

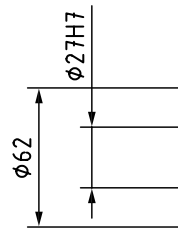

Figure A.18 — Layer SK2 — Dimensioning of the tool component

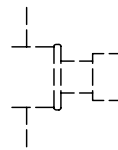

Figure A.19 — Layer SK3 — Reference lines/invisible lines of the tool component

Figure A.20 — Layer SK4 — Centre lines of the tool component

**A.3 Tool component — Lathe tool (boring bar) — Non-rotationally symmetric
A20Q-STJCL11**

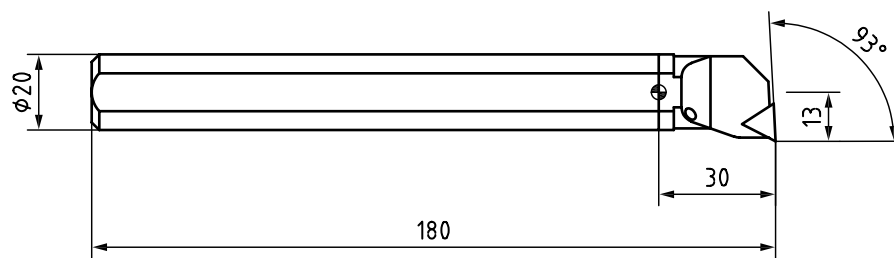

Figure A.21 — Tool component — All layers

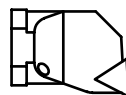

Figure A.22 — Layer 1 — Outer contour for assembled tool

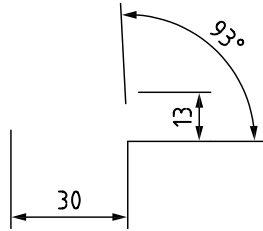

Figure A.23 — Layer 2 — Dimensioning for assembled tool

Figure A.24 — Layer 4 — Centre line for assembled tool

Figure A.25 — Layer NOCUT — Non-cutting contour for assembled tool



Figure A.26 — Layer CUT — Cutting contour

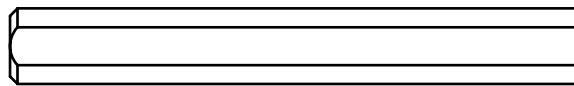

Figure A.27 — Layer SK1 — Outer contour of the tool component

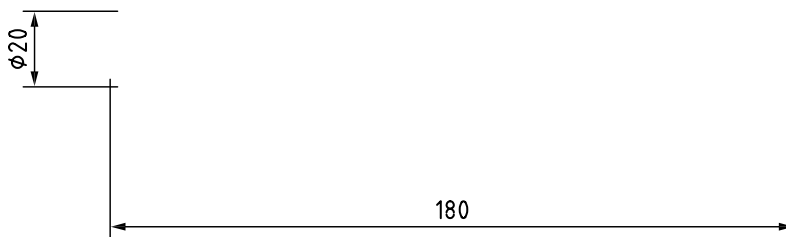

Figure A.28 — Layer SK2 — Dimensioning of the tool component

Figure A.29 — Layer SK4 — Centre line of the tool component

A20Q-STJCL11

Figure A.30 — Layer SK6 — Lettering (language independent) of the tool component

A.4 Tool component — Lathe tool (tool holder) — Non-rotationally symmetric

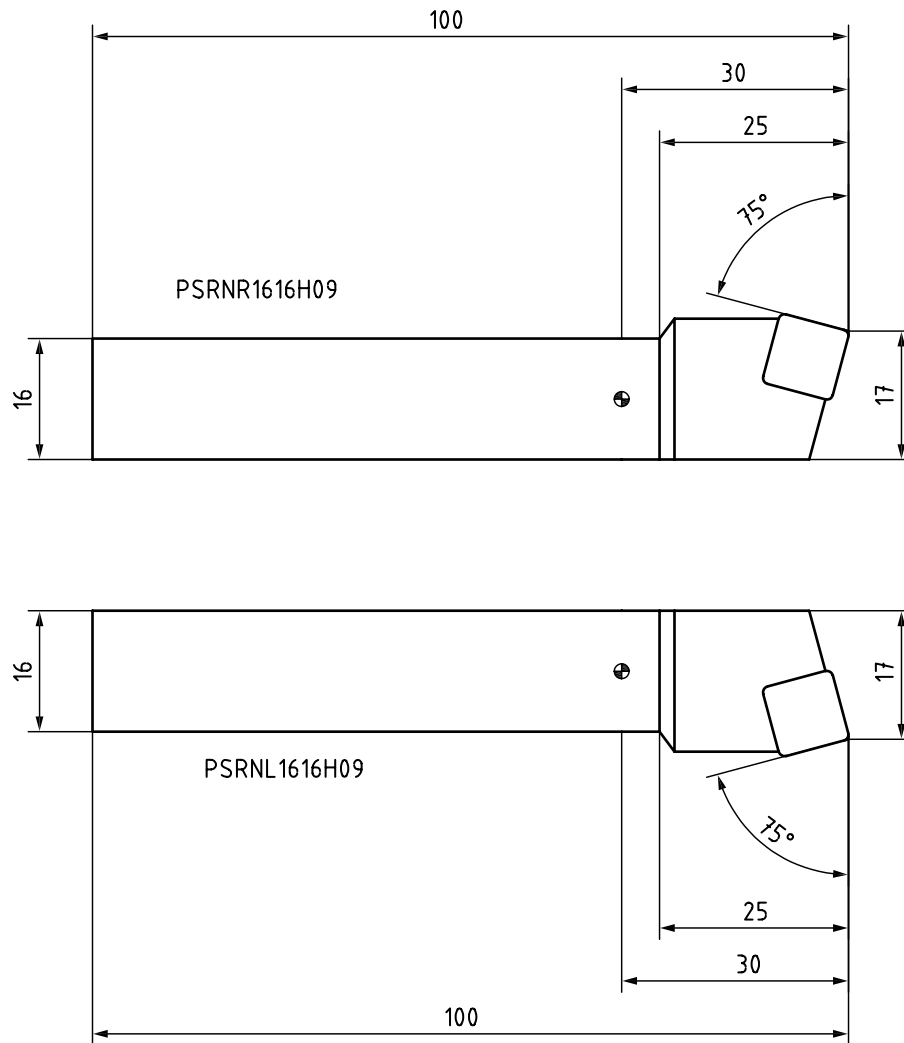

Figure A.31 — Tool component — All layers

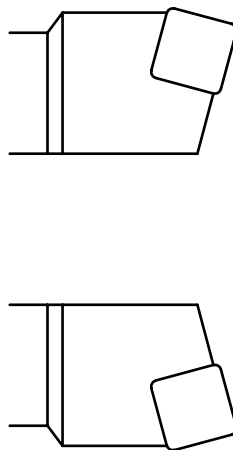

Figure A.32 — Layer 1 — Outer contour for assembled tool

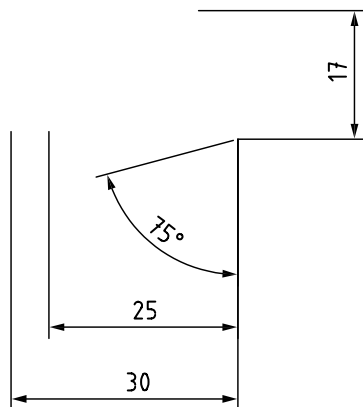
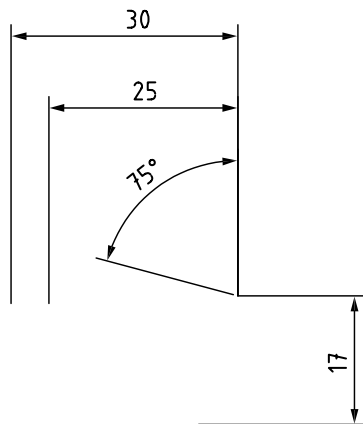

Figure A.33 — Layer 2 — Dimensioning for assembled tool

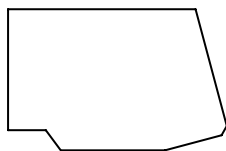
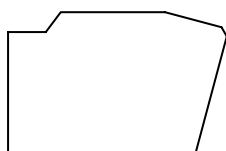

Figure A.34 — Layer NOCUT — Non-cutting contour for assembled tool



Figure A.35 — Layer CUT — Cutting contour for tool component and assembled tools

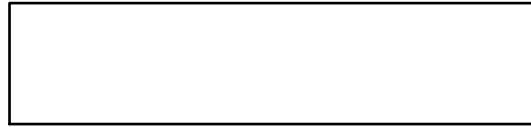

Figure A.36 — Layer SK1 — Outer contour of the tool component

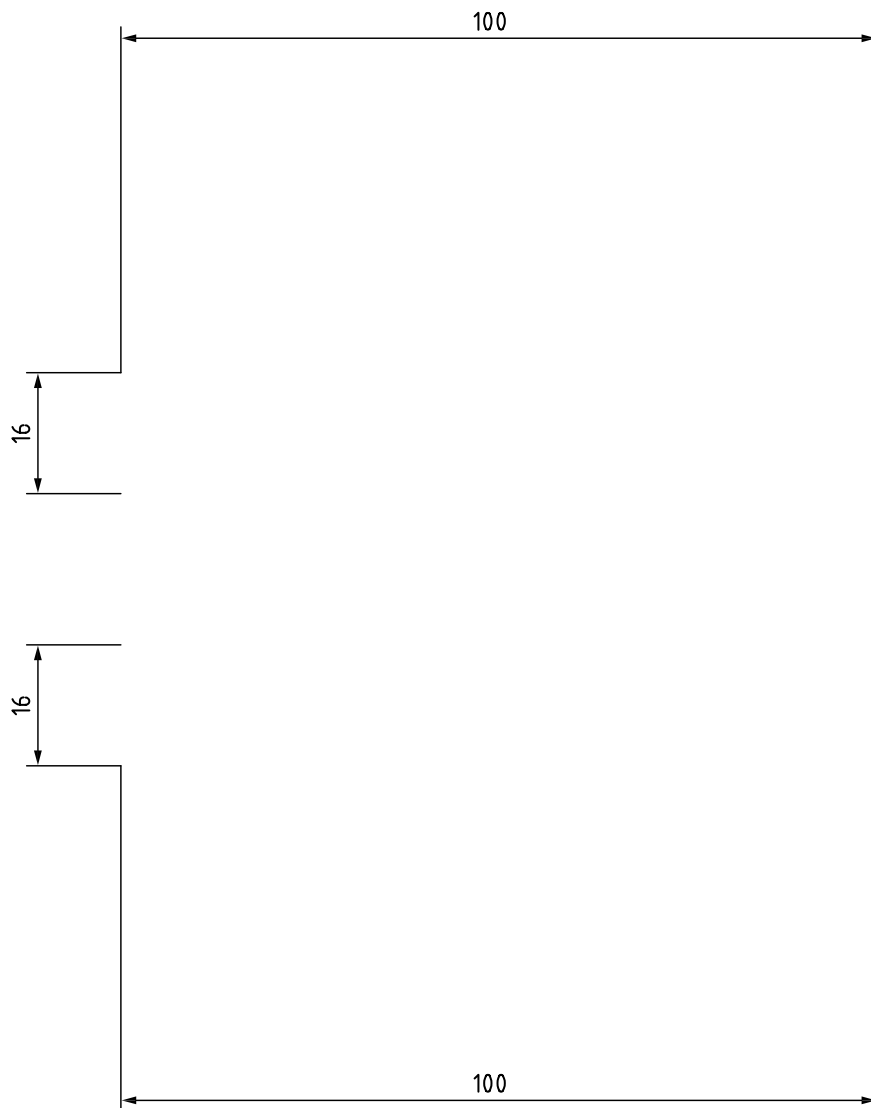
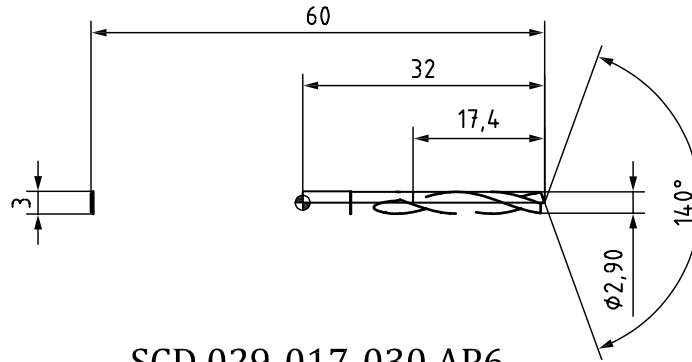

Figure A.37 — Layer SK2 — Dimensioning of the tool component

right handed too. ↲SRNR1616H09 left handed too. ↲SRNL1616H09

Figure A.38 — Layer SK6 — Lettering (language independent) of the tool component

A.5 Tool component — Solid drilling tool — Rotationally symmetric



SCD 029-017-030 AP6

Figure A.39 — Tool component — All layers



Figure A.40 — Layer 1 — Outer contour for assembled tool

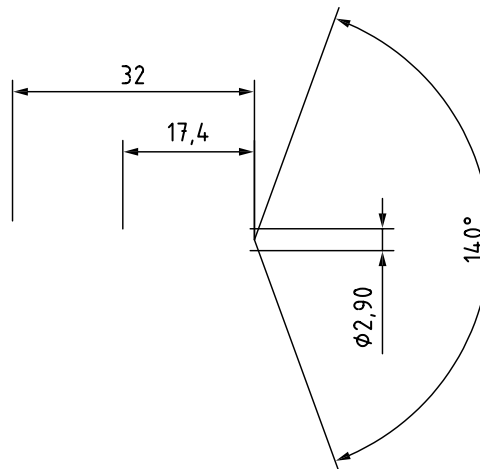

Figure A.41 — Layer 2 — Dimensioning for assembled tool

Figure A.42 — Layer 4 — Centre line for assembled tool

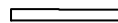

Figure A.43 — Layer NOCUT — Non-cutting contour for assembled tool

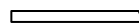

Figure A.44 — Layer CUT — Cutting contour for tool component and assembled tools

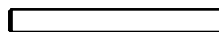

Figure A.45 — Layer SK1 — Outer contour of the tool component

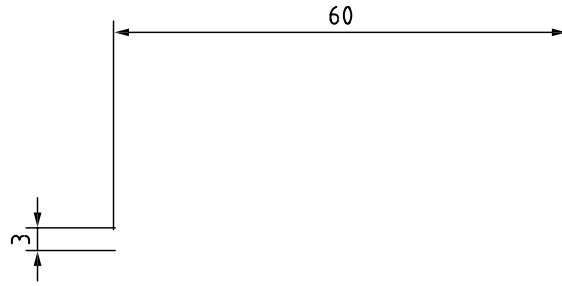

Figure A.46 — Layer SK2 — Dimensioning of the tool component

Figure A.47 — Layer SK4 — Centre line of the tool component

SCD 029-017-030 AP6

Figure A.48 — Layer SK6 — Lettering (language independent) of the tool component

A.6 Tool component — Indexable drilling tool — Rotationally symmetric

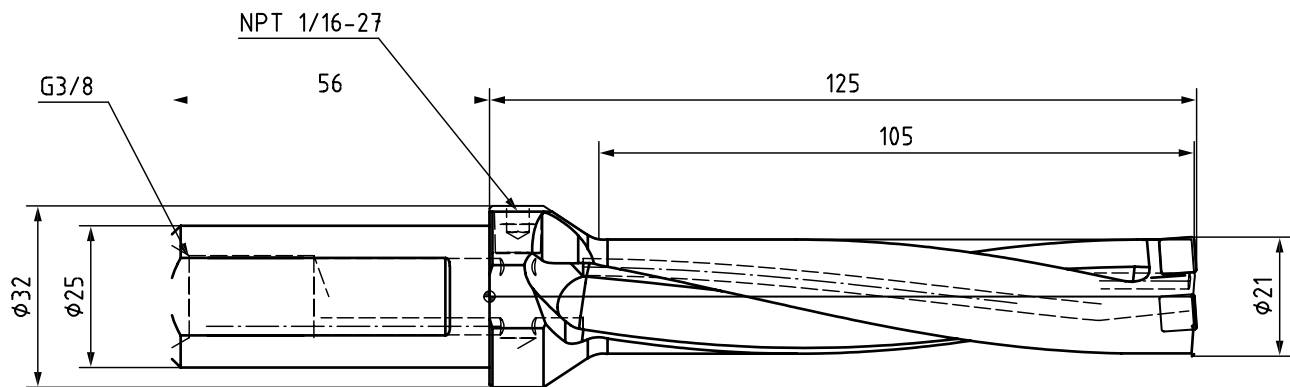

DR210-105-25-07-5D-N

Figure A.49 — Tool component — All layers

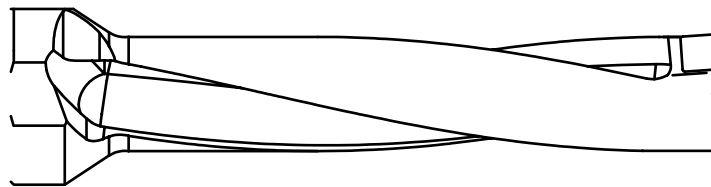

Figure A.50 — Layer 1 — Outer contour for assembled tool

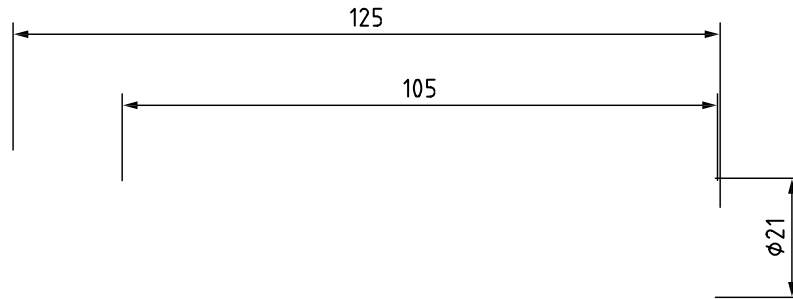

Figure A.51 — Layer 2 — Dimensioning for assembled tool

Figure A.52 — Layer 4 — Centre line for assembled tool

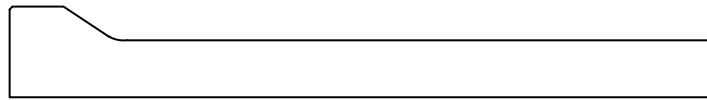

Figure A.53 — Layer NOCUT — Non-cutting contour for assembled tool



Figure A.54 — Layer CUT — Cutting contour for tool component and assembled tools

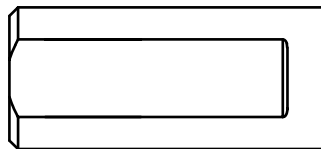

Figure A.55 — Layer SK1 — Outer contour of the tool component

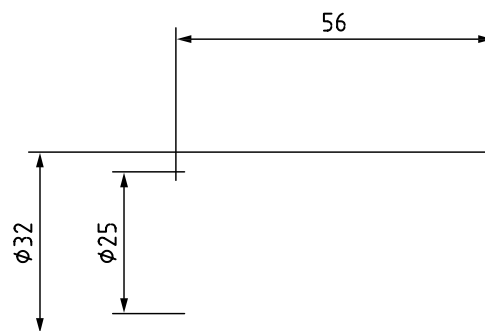

Figure A.56 — Layer SK2 — Dimensioning of the tool component

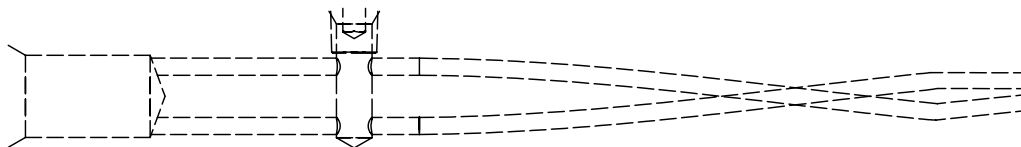
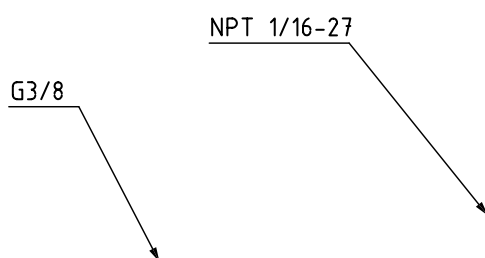

Figure A.57 — Layer SK3 — Reference lines/invisible lines of the tool component

Figure A.58 — Layer SK4 — Centre line of the tool component



DR210-105-25-07-5D-N

Figure A.59 — Layer SK6 — Lettering (language independent) of the tool component

A.7 Cutting item — Irregular insert for threading operations

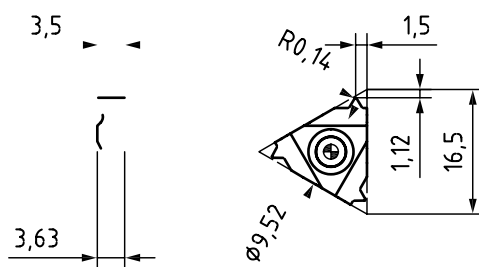

16IR 11 UN

Figure A.60 — Cutting item — all layers



Figure A.61 — Layer 1 — Outer contour for assembled tool

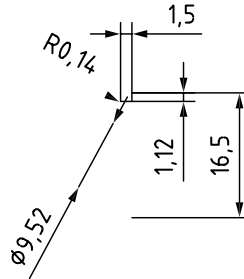

Figure A.62 — Layer SK2 — Dimensioning of the cutting item

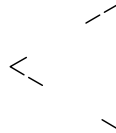

Figure A.63 — Layer SK3 — Reference lines/invisible lines of the cutting item

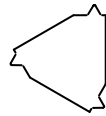

Figure A.64 — Layer CUT — Cutting contour for assembled tools

Figure A.65 — Layer SK4 — Centre line of the cutting item

16IR 11 UN

Figure A.66 — Layer SK6 — Lettering (language independent) of the cutting item



Figure A.67 — Layer SKVIEW1 — Outer contour of additional views

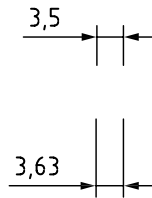

Figure A.68 — Layer SKVIEW2 — Dimensioning of additional views

--
--

Figure A.69 — Layer SKVIEW3 — Invisible lines of additional views

Figure A.70 — Layer SKVIEW4 — Centre line of additional views

Bibliography

- [1] ISO 128-20, *Technical drawings — General principles of presentation — Part 20: Basic conventions for lines*
- [2] ISO 6428, *Technical drawings — Requirements for microcopying*
- [3] ISO 13399-1, *Cutting tool data representation and exchange — Part 1: Overview, fundamental principles and general information model*
- [4] ISO/TS 13399-2, *Cutting tool data representation and exchange — Part 2: Reference dictionary for the cutting items*
- [5] ISO/TS 13399-3, *Cutting tool data representation and exchange — Part 3: Reference dictionary for tool items*
- [6] ISO/TS 13399-4, *Cutting tool data representation and exchange — Part 4: Reference dictionary for adaptive items*
- [7] ISO/TS 13399-5, *Cutting tool data representation and exchange — Part 5: Reference dictionary for assembly items*
- [8] ISO/TS 13399-50, *Cutting tool data representation and exchange — Part 50: Reference dictionary for reference systems and common concepts*
- [9] ISO/TS 13399-60, *Cutting tool data representation and exchange — Part 60: Reference dictionary for connection systems*
- [10] ISO/TS 13399-100, *Cutting tool data representation and exchange — Part 100: Definitions, principles and methods for reference dictionaries*
- [11] ISO/TS 13399-150, *Cutting tool data representation and exchange — Part 150: Usage guidelines*
- [12] ISO 16792, *Technical product documentation — Digital product definition data practices*

