

---

---

**Health informatics — Point-of-care  
medical device communication —**

Part 90101:

**Analytical instruments — Point-of-care  
test**

*Informatique de santé — Communication entre dispositifs médicaux sur  
le site des soins —*

*Partie 90101: Instruments analytiques — Essai sur le site des soins*



Reference number  
ISO 11073-90101:2008(E)

© ISO 2008

**PDF disclaimer**

This PDF file may contain embedded typefaces. In accordance with Adobe's licensing policy, this file may be printed or viewed but shall not be edited unless the typefaces which are embedded are licensed to and installed on the computer performing the editing. In downloading this file, parties accept therein the responsibility of not infringing Adobe's licensing policy. The ISO Central Secretariat accepts no liability in this area.

Adobe is a trademark of Adobe Systems Incorporated.

Details of the software products used to create this PDF file can be found in the General Info relative to the file; the PDF-creation parameters were optimized for printing. Every care has been taken to ensure that the file is suitable for use by ISO member bodies. In the unlikely event that a problem relating to it is found, please inform the Central Secretariat at the address given below.



**COPYRIGHT PROTECTED DOCUMENT**

© ISO 2008

All rights reserved. Unless otherwise specified, no part of this publication may be reproduced or utilized in any form or by any means, electronic or mechanical, including photocopying and microfilm, without permission in writing from either ISO at the address below or ISO's member body in the country of the requester.

ISO copyright office  
Case postale 56 • CH-1211 Geneva 20  
Tel. + 41 22 749 01 11  
Fax + 41 22 749 09 47  
E-mail [copyright@iso.org](mailto:copyright@iso.org)  
Web [www.iso.org](http://www.iso.org)

Published in Switzerland

## Foreword

ISO (the International Organization for Standardization) is a worldwide federation of national standards bodies (ISO member bodies). The work of preparing International Standards is normally carried out through ISO technical committees. Each member body interested in a subject for which a technical committee has been established has the right to be represented on that committee. International organizations, governmental and non-governmental, in liaison with ISO, also take part in the work. ISO collaborates closely with the International Electrotechnical Commission (IEC) on all matters of electrotechnical standardization.

International Standards are drafted in accordance with the rules given in the ISO/IEC Directives, Part 2.

The main task of technical committees is to prepare International Standards. Draft International Standards adopted by the technical committees are circulated to the member bodies for voting. Publication as an International Standard requires approval by at least 75 % of the member bodies casting a vote.

Attention is drawn to the possibility that some of the elements of this document may be the subject of patent rights. ISO shall not be held responsible for identifying any or all such patent rights.

ISO 11073-90101 was prepared by the Clinical and Laboratory Standards Institute (as POCT1-A2) and was adopted, under a special "fast-track procedure", by Technical Committee ISO/TC 215, *Health informatics*, in parallel with its approval by the ISO member bodies.

.....



POCT1-A2  
Vol. 26 No. 28  
Replaces POCT1-A  
Vol. 21 No. 24

---

# Point-of-Care Connectivity; Approved Standard—Second Edition

This document provides the framework for engineers to design devices, work stations, and interfaces that allow multiple types and brands of point-of-care devices to communicate bidirectionally with access points, data managers, and laboratory information systems from a variety of vendors.

---

A standard for global application developed through the Clinical and Laboratory Standards Institute consensus process.



(Formerly NCCLS)



# Clinical and Laboratory Standards Institute

*Advancing Quality in Healthcare Testing*

The Clinical and Laboratory Standards Institute (CLSI, formerly NCCLS) is an international, interdisciplinary, nonprofit, standards-developing, and educational organization that promotes the development and use of voluntary consensus standards and guidelines within the healthcare community. It is recognized worldwide for the application of its unique consensus process in the development of standards and guidelines for patient testing and related healthcare issues. Our process is based on the principle that consensus is an effective and cost-effective way to improve patient testing and healthcare services.

In addition to developing and promoting the use of voluntary consensus standards and guidelines, we provide an open and unbiased forum to address critical issues affecting the quality of patient testing and health care.

## PUBLICATIONS

A document is published as a standard, guideline, or committee report.

**Standard** A document developed through the consensus process that clearly identifies specific, essential requirements for materials, methods, or practices for use in an unmodified form. A standard may, in addition, contain discretionary elements, which are clearly identified.

**Guideline** A document developed through the consensus process describing criteria for a general operating practice, procedure, or material for voluntary use. A guideline may be used as written or modified by the user to fit specific needs.

**Report** A document that has not been subjected to consensus review and is released by the Board of Directors.

## CONSENSUS PROCESS

The CLSI voluntary consensus process is a protocol establishing formal criteria for:

- the authorization of a project
- the development and open review of documents
- the revision of documents in response to comments by users
- the acceptance of a document as a consensus standard or guideline.

Most documents are subject to two levels of consensus—“proposed” and “approved.” Depending on the need for field evaluation or data collection, documents may also be made available for review at an intermediate consensus level.

**Proposed** A consensus document undergoes the first stage of review by the healthcare community as a proposed standard or guideline. The document should receive a wide and thorough technical review, including an overall review of its scope, approach, and utility, and a line-by-line review of its technical and editorial content.

**Approved** An approved standard or guideline has achieved consensus within the healthcare community. It should be reviewed to assess the utility of the final document, to ensure attainment of consensus (i.e., that comments on earlier versions have been satisfactorily addressed), and to identify the need for additional consensus documents.

Our standards and guidelines represent a consensus opinion on good practices and reflect the substantial agreement by materially affected, competent, and interested parties obtained by following CLSI’s established consensus procedures. Provisions in CLSI standards and guidelines may be more or less stringent than applicable regulations. Consequently, conformance to this voluntary consensus document does not relieve the user of responsibility for compliance with applicable regulations.

## COMMENTS

The comments of users are essential to the consensus process. Anyone may submit a comment, and all comments are addressed, according to the consensus process, by the committee that wrote the document. All comments, including those that result in a change to the document when published at the next consensus level and those that do not result in a change, are responded to by the committee in an appendix to the document. Readers are strongly encouraged to comment in any form and at any time on any document. Address comments to the Clinical and Laboratory Standards Institute, 940 West Valley Road, Suite 1400, Wayne, PA 19087, USA.

## VOLUNTEER PARTICIPATION

Healthcare professionals in all specialties are urged to volunteer for participation in CLSI projects. Please contact us at [customerservice@clsi.org](mailto:customerservice@clsi.org) or +610.688.0100 for additional information on committee participation.

---

**Point-of-Care Connectivity; Approved Standard—Second Edition**

Lou Dunka, PhD  
 Bryan Allen  
 Todd Cooper  
 Christopher Fetters  
 Wayne Mullins  
 James Nichols, PhD  
 Thomas Norgall  
 Paul Schluter, PhD  
 Robert Uleski

**Abstract**

Clinical and Laboratory Standards Institute document POCT1-A2, *Point-of-Care Connectivity; Approved Standard—Second Edition* was developed for those engaged in the manufacture of point-of-care diagnostic devices, as well as the hardware and software used to connect the devices to various information systems in healthcare facilities. This document incorporates the work product of the Connectivity Industry Consortium, an organization that developed specifications for point-of-care device and information system communication interoperability. It provides the basis for multivendor, seamless interoperability between point-of-care devices, data managers, and clinical results management systems.

Clinical and Laboratory Standards Institute (CLSI). *Point-of-Care Connectivity; Approved Standard—Second Edition*. CLSI document POCT1-A2 (ISBN 1-56238-616-6). Clinical and Laboratory Standards Institute, 940 West Valley Road, Suite 1400, Wayne, Pennsylvania 19087-1898 USA, 2006.

The Clinical and Laboratory Standards Institute consensus process, which is the mechanism for moving a document through two or more levels of review by the healthcare community, is an ongoing process. Users should expect revised editions of any given document. Because rapid changes in technology may affect the procedures, methods, and protocols in a standard or guideline, users should replace outdated editions with the current editions of CLSI/NCCLS documents. Current editions are listed in the CLSI catalog, which is distributed to member organizations, and to nonmembers on request. If your organization is not a member and would like to become one, and to request a copy of the catalog, contact us at: Telephone: 610.688.0100; Fax: 610.688.0700; E-Mail: [customerservice@clsi.org](mailto:customerservice@clsi.org); Website: [www.clsi.org](http://www.clsi.org)



This publication is protected by copyright. No part of it may be reproduced, stored in a retrieval system, transmitted, or made available in any form or by any means (electronic, mechanical, photocopying, recording, or otherwise) without prior written permission from Clinical and Laboratory Standards Institute, except as stated below.

Clinical and Laboratory Standards Institute hereby grants permission to reproduce limited portions of this publication for use in laboratory procedure manuals at a single site, for interlibrary loan, or for use in educational programs provided that multiple copies of such reproduction shall include the following notice, be distributed without charge, and, in no event, contain more than 20% of the document's text.

Reproduced with permission, from CLSI publication POCT1-A2—*Point-of-Care Connectivity; Approved Standard—Second Edition* (ISBN 1-56238-616-6). Copies of the current edition may be obtained from Clinical and Laboratory Standards Institute, 940 West Valley Road, Suite 1400, Wayne, Pennsylvania 19087-1898, USA.

Permission to reproduce or otherwise use the text of this document to an extent that exceeds the exemptions granted here or under the Copyright Law must be obtained from Clinical and Laboratory Standards Institute by written request. To request such permission, address inquiries to the Executive Vice President, Clinical and Laboratory Standards Institute, 940 West Valley Road, Suite 1400, Wayne, Pennsylvania 19087-1898, USA.

Copyright ©2006. Clinical and Laboratory Standards Institute.

### **Suggested Citation**

(Clinical and Laboratory Standards Institute. *Point-of-Care Connectivity; Approved Standard—Second Edition*. CLSI document POCT1-A2 [ISBN 1-56238-616-6]. Clinical and Laboratory Standards Institute, 940 West Valley Road, Suite 1400, Wayne, Pennsylvania 19087-1898 USA, 2006.)

### **Proposed Standard**

May 2001

### **Approved Standard**

December 2001

### **Approved Standard—Second Edition**

July 2006

ISBN 1-56238-616-6

ISSN 0273-3099



## Committee Membership

### Area Committee on Point-of-Care Testing

**Louis J. Dunka, Jr, PhD**  
**Chairholder**  
**LifeScan, Inc.**  
**Milpitas, California**

**James H. Nichols, PhD, DABCC, FACB**  
**Vice Chairholder**  
**Baystate Medical Center**  
**Springfield, Massachusetts**

Diana R. DeHoyos, MS, MT(ASCP)  
 The University of Texas Medical  
 Branch  
 Galveston, Texas

Christopher Feters  
 NOVA Biomedical  
 Waltham, Massachusetts

George W. Gaebler, III, MSEd., RRT,  
 FAARC  
 University Hospital  
 Syracuse, New York

Ethan D. Hausman, MD, FAAP,  
 FCAP  
 FDA Ctr. for Devices/Rad. Health  
 Rockville, Maryland

Frank M. LaDuca, PhD  
 Bayer HealthCare Diagnostics  
 Division  
 Tarrytown, New York

Raelene M. Peretto, MBA,  
 MT(ASCP)  
 Centers for Medicare & Medicaid  
 Services  
 Baltimore, Maryland

Kathy Scruggs, MT(ASCP)  
 Dayton VA Medical Center  
 Dayton, Ohio

Patrick J. St. Louis, Ph.D., Dip.CC  
 Ste. Justine Hospital  
 Montreal, Quebec

#### Advisors

Jeff Dahlen, PhD  
 Biosite Incorporated  
 San Diego, California

Sharon S. Ehrmeyer, PhD  
 University of Wisconsin  
 Madison, Wisconsin

Valerio M. Genta, MD  
 Sentara Virginia Beach General  
 Hospital  
 Virginia Beach, Virginia

Barry H. Ginsberg, MD, PhD  
 BD  
 Franklin Lakes, New Jersey

Ellis Jacobs, PhD, DABCC, FACB  
 New York State Dept. of Health  
 Albany, New York

David Klonoff, MD  
 Diabetes Technology Society  
 Foster City, California

Katsuhiko Kuwa, PhD  
 University of Tsukuba  
 Tsukuba 305-8575, Japan

Ronald H. Ng, PhD, DABCC, FACB  
 Abbott Diabetes Care  
 Alameda, California

Carmina Pascual, MT(ASCP),  
 CLS(NCA)  
 Roche Instrument Center AG  
 Rotkreuz, Switzerland

David L. Phillips  
 HemoSense, Inc.  
 San Jose, California

Paula J. Santrach, MD  
 Mayo Clinic  
 Rochester, Minnesota

Lou Ann Wyer, MT(ASCP)  
 Sentara Healthcare  
 Norfolk, Virginia

### Working Group on Point-of-Care Connectivity

**Louis J. Dunka, Jr, PhD**  
**Chairholder**  
**LifeScan, Inc.**  
**Milpitas, California**

Joanna C. Baker, MSPH,  
 MT(ASCP)SC, C  
 Moncrief Army Community Hospital  
 Ft. Jackson, South Carolina

Chris Budgen  
 Canterbury Health Laboratories  
 Christchurch, New Zealand

James Callaghan  
 FDA Center for Devices/Radiological  
 Health  
 Rockville, Maryland

Todd Cooper  
 Breakthrough Solutions, Inc.  
 (Representing IEEE)  
 Poway, California

Christopher Feters  
 NOVA Biomedical  
 Waltham, Massachusetts

Andrzej J. Knafel, PhD  
 Roche Instrument Center  
 (Representing HL7)  
 Rotkreuz, Switzerland

Wayne Mullins  
 Medical Automation Systems  
 Charlottesville, Virginia

James Nichols, PhD  
 Baystate Medical Center  
 (Representing CLSI)  
 Springfield, Massachusetts

Thomas Norgall  
 Institut Integrierte Schaltungen  
 Erlangen, Germany

Carmina Pascual, MT(ASCP),  
 CLS(NCA)  
 Roche Instrument Center AG  
 Rotkreuz, Switzerland

Phil Pash  
 Roche Diagnostics  
 Indianapolis, Indiana

## Working Group (Continued)

Melvin I. Reynolds  
AMS Consulting  
Ross-on-Wye  
Herefordshire, United Kingdom

Christina Rode-Schubert, MBA  
BE Consult  
Heidelberg, Germany

Paul Schluter, PhD  
GE Medical Systems *Information Technologies*  
(Representing IEEE)  
Milwaukee, Wisconsin

Allan Soerensen  
Radiometer Medical Aps  
Broenshoej, Denmark

Andrew St. John  
ARC Consulting  
Mt. Lawley, Washington

Andreas Staubert, PhD  
Roche Diagnostics GmbH  
Mannheim, Germany

William Thorpe  
Bayer  
Norwood, Massachusetts

Robert Uleski  
Robert Uleski Consulting  
Fishers, Indiana

### Staff

Clinical and Laboratory Standards  
Institute  
Wayne, Pennsylvania

John J. Zlockie, MBA  
*Vice President, Standards*

David E. Sterry, MT(ASCP)  
*Staff Liaison*

Donna M. Wilhelm  
*Editor*

Melissa A. Lewis  
*Assistant Editor*

## Acknowledgement

CLSI gratefully acknowledges the contributions of the late Dr. Louis J. Dunka, Jr., LifeScan, Inc, who served as the Chairholder of the Area Committee on Point-of-Care Testing and was an active participant on the Working Group on Point-of-Care Connectivity during the revision of this document.

**Contents**

|   |     |
|---|-----|
| Abstract .....  | i   |
| Committee Membership.....                               | iii |
| Foreword .....  | ix  |
| 1 Scope.....  | 1   |
| 2 Introduction.....                                     | 1   |
| 3 Definitions .....                                     | 2   |
| 4 Specifications.....                                   | 4   |
| 4.1 Description of Connectivity System Components ..... | 5   |
| 4.2 The Interfaces .....                                | 6   |
| References.....   | 15  |

**Figures**

|  |    |
|--|----|
| Figure 1. Cooperative Evolution of Point-of-Care Standards ..... | 2  |
| Figure 2. The Two Interfaces.....                                | 5  |
| Figure 3. Device Interface Layers.....                           | 7  |
| Figure 4. Lower-Layer Networking Evolution .....                 | 8  |
| Figure 5. Device Messaging Layer Data Topics.....                | 8  |
| Figure 6. Device Messaging Layer ‘Script’ .....                  | 10 |
| Figure 7. Example Glucose Test Results Message .....             | 11 |
| Figure 8. Example Access Point Deployment Scenario.....          | 12 |
| Figure 9. Observation Reporting Interface .....                  | 13 |
| Figure 10. Sample Observation Reporting Interface Message.....   | 14 |

Contents—Appendixes

Appendix A. Device and Access Point (DAP) Interface Specification

1 Scope and Introduction..... 25
2 Definitions ..... 25
3 Abbreviations ..... 27
4 Overview of POC Device Networking (Informative) ..... 28
5 Overview of IrDA and ISO/IEEE 11073-30200 (Informative)..... 30
6 Requirements for a 'POCT1-compatible' Device (Normative)..... 36
7 Requirements for a 'POCT1-compatible' Access Point (Normative) ..... 38
8 Networked Access Points (Normative if Implemented)..... 41
9 Remote Modem Access (Informative) ..... 47
10 POC Devices With Direct Network Connections (Informative)..... 48
11 Data Security (Informative) ..... 49
12 RF Wireless Networking Technologies (Informative)..... 50
13 References ..... 53

Appendix B. Device Messaging Layer (DML) Specification

1 Scope and Introduction ..... 63
2 Bidirectional Communication ..... 66
3 General Messaging Issues ..... 71
4 Messaging Profile ..... 76
5 Information Model ..... 91
6 Messaging Model ..... 110
7 Extending the Device Messaging Layer..... 126
8 Annex A. Device Messaging Layer Data Types (Normative)..... 128
9 Annex B. Asynchronous Observation Acknowledgements (Normative) ..... 138
10 Annex C. 'SET-TIME' Time Stamp and Time Zone Information ..... 139
11 Annex D. Example Messages (Informative) ..... 144

**Contents—Appendixes (Continued)**

|   |     |
|---|-----|
| 12 Annex E. POCT1 Messaging DTDs (Normative)..... | 171 |
|---|-----|

**Appendix C. Observation Reporting Interface (ORI) Specification**

|                                |     |
|--------------------------------|-----|
| 1 Scope and Introduction ..... | 203 |
| 2 Use Case Descriptions.....   | 203 |
| 3 Message Profile .....        | 205 |
| 4 HL7 Message Definition ..... | 208 |
| 5 Sample Messages .....        | 223 |

**Appendix D. Point-of-Care Requirements**

|                      |     |
|----------------------|-----|
| 1 Requirements ..... | 257 |
|----------------------|-----|

**Appendix E. Connectivity Architecture**

|                      |     |
|----------------------|-----|
| 1 Architecture ..... | 275 |
| 2 Principles .....   | 275 |
| 3 Approach .....     | 277 |
| 4 Model .....        | 278 |

**Appendix F. Vendor Codes**

|                      |     |
|----------------------|-----|
| 1 Vendor Codes ..... | 283 |
|----------------------|-----|

|  |            |
|--|------------|
| <b>Summary of Comments and Subcommittee Responses.....</b> | <b>285</b> |
|--|------------|

|   |            |
|---|------------|
| <b>The Quality System Approach.....</b> | <b>288</b> |
|---|------------|

|  |            |
|--|------------|
| <b>Related CLSI/NCCLS Publications .....</b> | <b>289</b> |
|--|------------|



## Foreword

Over the last decade, advances in microfluidic and other miniaturization technologies have enabled a new class of diagnostic device. This new device class—point-of-care diagnostic—supports a wide diversity of diagnostic testing directly at the *point of care*. Tests that had been previously limited to the domain of central laboratory analyzers are now available in a variety of care settings. Sophisticated tests are possible at the hospital bedside, during patient encounters in primary- and secondary-care clinics, and even in the home. This new point-of-care diagnostic device class offers the advantages of fast turnaround time for test results and quite possibly cost reduction for some types of tests.

In general, from a regulatory perspective, a diagnostic test is not differentiated based on where the test is performed. Someone in the institution must be able to show that the test was performed in compliance with the policies of an overall diagnostic testing quality system for the institution. It is thus incumbent upon point-of-care diagnostic device vendors to offer mechanisms by which their devices may be integrated into an institution's diagnostic information management system. It is this requirement for integration that drives the need for standardization.

To date, point-of-care diagnostic vendors and partners have faced this integration problem individually and have derived unique solutions. Any institution embarking on incorporating multivendor point-of-care diagnostic devices into their diagnostic testing facilities has had to face the equipment and management costs of multiple integration solutions. In fact, the cost and disjointedness of multivendor point-of-care diagnostic integration is seen as a significant barrier to the adoption of this new and exciting class of diagnostic device.

For the purposes of this specification, point-of-care testing is defined as all testing conducted near the site of patient care. This encompasses many different environments, including hospital-based testing, near-patient testing, physician's-office testing, and patient self-testing. A point-of-care connectivity specification must be applicable to all of these settings.

In February 2000, 49 healthcare institutions, point-of-care diagnostic vendors, diagnostic test system vendors, and system integrators formed the Connectivity Industry Consortium (CIC) to address this point-of-care diagnostic integration problem. The CIC Board of Directors created the following statement to guide the CIC work teams:

*“The vision of the CIC is to expeditiously develop, pilot, and transfer the foundation for a set of seamless ‘plug-and-play’ POC communication standards ensuring fulfillment of the critical user requirements of bidirectionality, device connection commonality, commercial software interoperability, security, and QC / regulatory compliance.”*

The result is a set of standards that will become the foundation for POC connectivity across the healthcare continuum. To meet this vision, the resulting standards are self-sustaining and utilize practical, cost-effective, user-focused solutions. The desired outcome of this vision is broad-based vendor and provider adoption of the CIC standards.<sup>a</sup>

Sections 1 through 4 of this document introduce and explain the technical aspects of point-of-care connectivity specifications. Appendixes A through C are the specifications for constructing a connectivity system; Appendixes D and E describe the basic concepts CIC employed to develop this standard.

---

<sup>a</sup> The governing principles, guidelines, timeline, and other information about the CIC can be found at the CIC's website: [www.poct.fraunhofer.de/about/index.html](http://www.poct.fraunhofer.de/about/index.html). The CIC development process emulated the standards-development processes of ANSI-approved standards organizations.

**Foreword (Continued)**

Note that the following trade names are included in this document: Palm™, Pocket PC™, and Bluetooth™. It is CLSI policy to avoid using trade names unless the products identified are the only ones available; they serve as an example of the point illustrated in the consensus document; and there is no generic description of the design and functional features of the products. Inclusion of these trade names in no way constitutes endorsement by CLSI. Please include in your comments any information that relates to our adherence to this trade name policy.

**Connectivity Industry Consortium Membership**

| <b>CORE VENDORS</b>                                | <b>CORE PROVIDERS</b>             |
|--|-----------------------------------|
| Abbott Laboratories                                | Banner Health System              |
| Agilent Technologies                               | Bradford Royal Infirmary          |
| Bayer Diagnostics                                  | Geisinger Healthcare System       |
| BD   | John Hopkins Medical Institutions |
| Instrumentation Laboratory                         | Kaiser Permanente                 |
| Lifescan/J&J                                       | Mayo Clinic                       |
| Medical Automation Systems                         | Profil GmbH                       |
| Radiometer Medical                                 | St. Vincent Mercy Medical Center  |
| Roche Diagnostics                                  | The Mount Sinai Hospital          |
| Sunquest Information Systems                       | University of Iowa Healthcare     |
| <b>SUPPORTING VENDORS</b>                          | <b>INDIVIDUAL PROVIDERS</b>       |
| Abaxis   | Maurice Green, PhD                |
| Avocet Medical                                     | Neil Halpern, MD                  |
| Cerner   | Georg Hoffmann                    |
| Clarinet Systems                                   | Colonel Forrest Kneisel           |
| Control Corporation                                | Gerald Kost, MD, PhD              |
| First Medical/Sigma Diagnostics                    | Petrie Rainey, MD PhD             |
| GE Medical Systems <i>Information Technologies</i> |                                   |
| HemoCue  | <b>LIAISONS</b>                   |
| HemoSense  | AACC                              |
| InterComponentWare                                 | COLA                              |
| i-STAT Corporation                                 | IFCC Scientific Division          |
| International Technidyne Corporation (ITC)         | Medical Devices Agency            |
| Lantronix  |                                   |
| Medtronic  |                                   |
| Motorola   |                                   |
| Orasure Technologies, Inc.                         |                                   |
| Pharmacia & Upjohn                                 |                                   |
| SMS/Siemens  |                                   |
| TELCOR Inc   |                                   |



## Foreword (Continued)

The CIC worked within a “fast-track” model and developed the point-of-care diagnostic integration specification within its planned 12- to 15-month lifetime. The CIC organization then handed the specification to CLSI ([www.CLSI.org](http://www.CLSI.org)), Health Level 7 ([www.hl7.org](http://www.hl7.org)), and IEEE ([www.ieee.org](http://www.ieee.org)) organizations for subsequent maintenance and extension.

This document, then, represents the work product of the Connectivity Industry Consortium (CIC).

Since the initial publishing of the CLSI POCT1-A standard, communication technologies have evolved, including in the area of radio frequency (RF) networking. The current POCT1 standard makes numerous references to both Bluetooth (802.15.1) and WiFi (802.11) transport interfaces; however, at that time it wasn't clear whether one technology should be chosen in favor of another. As a result, though RF wireless networking is mentioned in the document, there is no clear direction other than that the standard should be easily extended to include one or more of these transport technologies as long as they provide reliable connection-oriented communications.

This document replaces the first approved edition, POCT1-A, which was published in 2001. Several changes have been made in this edition; chief among them is the addition of a new section related to RF Wireless Networking Technologies (see Section 12 in Appendix A). Another significant change in this document is the conversion of each message prefix from “NCCLS” to “CLSI.” This change has been made to reflect the organizational name change that has occurred since the original publication of this standard. In the case of manufacturers with existing or distributed implementations that used the “NCCLS” prefix, the “NCCLS” prefix is a deprecated but valid string, in addition to the preferred “CLSI.”

CLSI also gratefully acknowledges the approval of POCT1 by the Scientific Division of the International Federation of Clinical Chemistry and Laboratory Medicine (IFCC). The joint efforts of the AACC Point-of-Care Testing Division, CIC, HL7, IEEE, IFCC, and CLSI, along with the many committee participants and experts involved in the development of POCT1, have served to strengthen the value of this standard and its usefulness worldwide.

## Acknowledgements

Many individuals contributed a tremendous amount of time and effort to the CIC toward developing, describing, and reviewing these point-of-care connectivity specifications.

The following individuals served technical organizational roles within the consortium:

|                                 |  |
|---------------------------------|--|
| <b>Chief Technical Officer:</b> | Jeff Perry, Walker Informatics   |
| <b>Architecture Team:</b>       | Jack Harrington, Philips Medical Systems                               |
| <b>Device Team Co-Chairs:</b>   | Alan Greenburg, Roche Diagnostics<br>Bob Uleski, FluorRx               |
| <b>EDI Team Co-Chairs:</b>      | Rodney Kugizaki, LifeScan<br>Wayne Mullins, Medical Automation Systems |
| <b>Point-of-Care Workflow:</b>  | Marcy Anderson, Medical Automation Systems                             |
| <b>Requirements Team:</b>       | Teresa Prego, Bayer Diagnostics  |

The following individuals are recognized for their significant contributions to the development, authoring, and review of the original CIC Specification:

- Bryan Allen, Bayer Diagnostics
- Bob Anders, HealthWyse
- Nils Graversen, Radiometer Medical
- Alan Greenburg, Roche Diagnostics
- Jack Harrington, Philips Medical Systems
- Rodney Kugizaki, LifeScan
- David Ma, Clarinet Systems
- Mark Maund, i-STAT Corporation
- Chris Melo, Philips Medical Systems
- Wayne Mullins, Medical Automation Systems
- Dan Nowicki, GE Medical Systems *Information Technologies*
- Joe Rogers, i-STAT Corporation
- Paul Schluter, GE Medical Systems *Information Technologies*
- Allan Soerensen, Radiometer Medical
- Dan Trainor, Philips Medical Systems
- Imre Trefil, LifeScan
- Bob Uleski, FluorRx

## Key Words

Access point, connectivity, device interfaces, diagnostics, diagnostic devices, HL7, IrDA, IEEE 1073, ISO 11073, medical information bus, MIB, CLSI, point-of-care, POC, point-of-care testing, POCT

## Point-of-Care Connectivity; Approved Standard—Second Edition

### 1 Scope

This standard establishes a set of specifications to allow seamless multivendor interoperability and communication between point-of-care devices, data concentrators, and clinical information systems. CLSI document POCT1 provides the framework for engineers to design devices, workstations, and interfaces that allow multiple types and brands of point-of-care devices to communicate bidirectionally with access points, data concentrators, and laboratory information systems from a variety of vendors.

As an *interface* standard, this document specifies the common communication interfaces and protocols between systems and devices. It facilitates the transfer of data to support the creation of point-of-care applications, services, and institutional policies. This document does not directly address specific point-of-care application and service level functions, such as device lockout and operator list management. This document specifies protocol, not policy. The interfaces specified support the communication required for engineers to build such application-level functionality. Specifying, building, and providing the applications to support these services are left to customers, device and information system vendors.

The only relationship of this point-of-care standard to the laboratory automation domain is through the use of the HL7 standard. In version 2.4,<sup>1</sup> the HL7 standard was expanded to provide elements essential to laboratory automation, which also improved the HL7 standard for the entire laboratory-testing domain. These additions to HL7, along with four proposed new HL7 message triggers (see Section 4.1 in Appendix C of this CLSI standard), enable the point-of-care community to use HL7 as its electronic data interchange (EDI).

This specification also leverages several communication standards. It specifies the use of a single device transport protocol (IrDA TinyTP) running over two possible physical layers: *IrDA-infrared*, as specified by the Infrared Data Association (IrDA) and ISO/IEEE 11073-30300<sup>2</sup>; and *cable-connected*, as specified by the IEEE 1073 lower-layers standard.<sup>3</sup> This specification also utilizes local area networking standards such as IEEE 802.3<sup>4</sup> and protocols such as TCP/IP in cases where network connectivity is required.

### 2 Introduction

This document on point-of-care connectivity has been developed by the CLSI Subcommittee on Point-of-Care Connectivity. The core of the standard is a group of three specifications developed by the Connectivity Industry Consortium (CIC). The specifications describe the attributes of an access point; the communication protocols between the device and the access point; and communications between a data manager and clinical information systems. The collaborative effort among providers and manufacturers has produced a set of specifications acceptable to both. The constitution of the subcommittee is a balance among providers; representatives of CLSI, HL7, and IEEE; the professions (CAP); and the government (FDA). The specifications will become standards in IEEE, HL7, and CLSI in parallel.

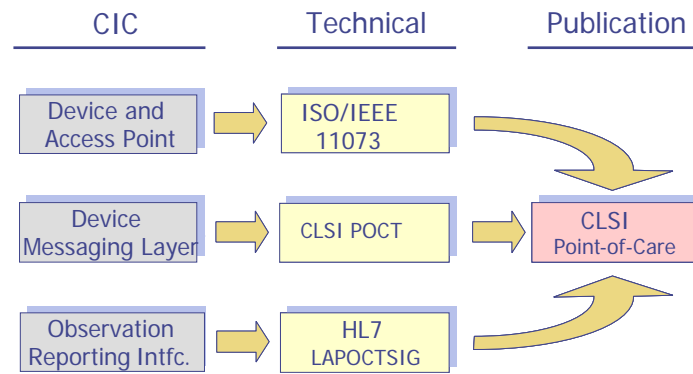

**Figure 1. Cooperative Evolution of Point-of-Care Standards**

### 3 Definitions

**Access Point (AP)** – a subsystem that consolidates data from one or more point-of-care devices (POCD) onto another communication link; **NOTE:** Examples of access points include a multiport concentrator or a dedicated single-port access point, typically connected to a local area network (LAN), or an access point that is part of a multifunctional device such as a patient monitor or personal computer.

**ANSI** – American National Standards Institute ([www.ansi.org](http://www.ansi.org)).

**Clinical Information System (CIS)** – any healthcare information system (HIS) responsible for housing clinical information; **NOTE:** Examples include laboratory information systems (LIS), clinical data repository (CDR), and electronic medical records (EMR).

**Connectivity** – the ability to reliably transfer test information between a point-of-care testing device and an information system.

**Data Manager (DM)** – typically, a network server that provides the services of an Observation Reviewer (e.g., POC data storage and forwarding, QA/QC, and other POC instrument and data management functions); **NOTE 1:** In addition to these services, Data Managers usually provide other applications or services tailored to particular devices or POC user needs (such as regulatory reporting and operator management applications); **NOTE 2:** Data Manager systems are specific instances of Observation Reviewer services.

**Device and Access Point interface (DAP)** – specifies the interface between a device and an Access Point or concentrator.

**Device Messaging Layer (DML)** – the DML describes a complete messaging protocol (message types and message flow) to exchange results and quality information (quality assurance and quality control) between a Device and an Observation Reviewer; **NOTE:** This protocol may sit on top of any robust, reliable transport, such as the one described by the POCT1 Device and Access Point specification.

**Docking Station** – a mechanical and electrical interface that supports the use of a POC Device, typically employing legacy mechanical interfaces, connectors, protocols, and power delivery methods.

**Electronic Data Interchange (EDI)** – a term used in many industries to describe protocols to exchange data between enterprise-class information systems; **NOTE 1:** The acronym is general (applying to all such exchange protocols and languages); however, in some industries it has come to refer to specific implementations; **NOTE 2:** In the point-of-care domain, this term is occasionally used to refer to the

specific interface found between point-of-care data management systems, laboratory information systems, clinical information systems, and other systems that serve as the final repository of POC results.

**Extensible Markup Language (XML)** – a meta-language widely used on the Web and for business-to-business data exchange; **NOTE:** XML is to data and information as HTML is to documents and presentations.

**Health Level 7 (HL7)** – the Health Level 7 organization ([www.hl7.org](http://www.hl7.org)), an ANSI-accredited standards development organization focused on messaging to support the exchange of clinical and administrative healthcare data; **NOTE:** The HL7 standard specifies a transport-independent messaging framework and structure that enables disparate healthcare information systems to exchange data.

**The Institute of Electrical and Electronics Engineers (IEEE)** – an international, ANSI-accredited standards development organization dedicated to the advancement of electrical and information technologies; **NOTE:** Among its many roles, the IEEE sets standards for the electronics industry such as IEEE Standard 1073 for Medical Device Communications and IEEE Standard 802.3, which forms much of the lower-layers foundation for the Internet ([www.ieee.org](http://www.ieee.org)).

**IEEE 1073** – a family of standards for medical device communications that are optimized for the acute care setting; **NOTE 1:** Devices include patient monitors, ventilators, infusions pumps, pulse oximeters, etc.; standards include IEEE Standard 1073 and lower-layers IEEE Standard 1073.3.2; also referred to as “MIB” (see **Medical Information Bus**); **NOTE 2:** These are internationally harmonized as the ISO/IEEE 11073 set of standards.

**Infrared (IR)** – the physical layer typically used by infrared data association (IrDA) devices.

**Infrared Data Association (IrDA)** – an organization that creates and promotes interoperable, low-cost infrared data interconnection standards ([www.irda.org](http://www.irda.org)); **NOTE:** ‘IrDA’ also refers to the protocol stack authored by that group.

**ISO/IEEE 11073** – a family of standards for medical device communications that are optimized for the acute care setting; **NOTE:** When they are harmonized with IEEE 1073 standards, the designation is ISO/IEEE 11073 (see **IEEE 1073**).

**Medical Information Bus (MIB)** – a common name used for the IEEE 1073 family of standards for medical device communications (see **IEEE 1073**); **NOTE:** Not to be confused with Management Information Base used in SNMP.

**Observation Recipient** – the Observation Recipient provides services to manage point-of-care test results and ordering information within a healthcare institution; **NOTE:** In current point-of-care information management solutions, this function is often performed by laboratory information systems, clinical information systems, and other systems that serve as the final repository of POC results.

**Observation Reporting Interface (ORI)** – the ORI specifies messages sent between Observation Reviewers and Observation Recipients; **NOTE:** The messages contain information regarding observation results and associated orders.

**Observation Reviewer** – the Observation Reviewer provides services to support the management of test results, quality assurance and quality control data, and medical orders; **NOTE:** In current point-of-care information management solutions, this function is often performed by a Data Manager.

**Personal Digital Assistant (PDA)** – the class of consumer electronic devices that handle functions such as management of calendars, contact lists, and task lists; **NOTE 1:** Examples of PDAs include the Palm™ and Pocket PC™ devices; **NOTE 2:** Please see Disclaimer Statement in the beginning of this standard.

**Point-of-Care (POC)** – the environment immediately surrounding a patient.

**Point-of-Care Coordinator (POCC)** – an individual who has overall responsibility for assuring that the operation of all POC devices in the institution is compliant with the institution's POC quality system; **NOTE:** The services provided by the data manager(s) in the system are key tools used by the POC Coordinator to assure compliance.

**Point-of-Care Device (POCD)** – in the context of this standard, a point-of-care device is an instrument used at the patient's side to measure and/or record a clinical observation; **NOTE:** This definition does not require that the POCD measure the observed value; thus, this definition encompasses devices that perform biochemical analyses, devices that calculate observations from results determined externally, or devices that simply record values determined by other procedures.

**Quality assurance (QA)** – part of quality management focused on providing confidence that quality requirements will be fulfilled (ISO 9000, 3.2.11<sup>5</sup>).

**Quality control (QC)** – part of quality management focused on fulfilling quality requirements (ISO 9000 3.2.10<sup>5</sup>).

**Tiny Transport Protocol (TinyTP)** – IrDA transport protocol that provides multiple, concurrent, reliable, bidirectional communication streams on an IrDA link with robust flow control.

**Transmission Control Protocol/Internet Protocol (TCP/IP)** – a transport protocol that provides reliable, bidirectional, stream-oriented network communication; **NOTE:** TCP/IP is one of the foundation protocols of the Internet.

## 4 Specifications

This specification covers two broad areas of point-of-care device behavior:

- *Application Integration*

This specification defines the dialogs in which point-of-care diagnostic devices and participating systems engage. Ultimately, these dialogs manifest as a set of *messages* that pass between participants via well-defined *interfaces* in a system compliant with this specification. This specification has sought to define a sufficient set of dialogs to meet the integration and regulatory requirements imposed on a diagnostic test system that includes point-of-care diagnostic devices. This specification has been careful to not over-specify such dialogs; doing so would leave the specification brittle in response to change and could impede innovative development in the relatively young point-of-care diagnostic industry.

- *Physical Integration*

There are significant costs in multivendor point-of-care diagnostic integration that cannot be reduced unless there is some standardization of the physical and link-level interfaces used by point-of-care diagnostic devices and associated systems. This specification, therefore, also defines a set of physical connections and associated protocols. This specification has sought to prescribe a minimal set of physical definitions to reduce the cost of point-of-care diagnostic integration but not restrict vendors in their delivery of point-of-care diagnostic innovation.

This specification has defined two interfaces — a Device Interface and an Observation Reporting Interface.<sup>b</sup> Figure 2 overlays these interfaces on the “boxes and wires” that comprise typical solutions for point-of-care information management.

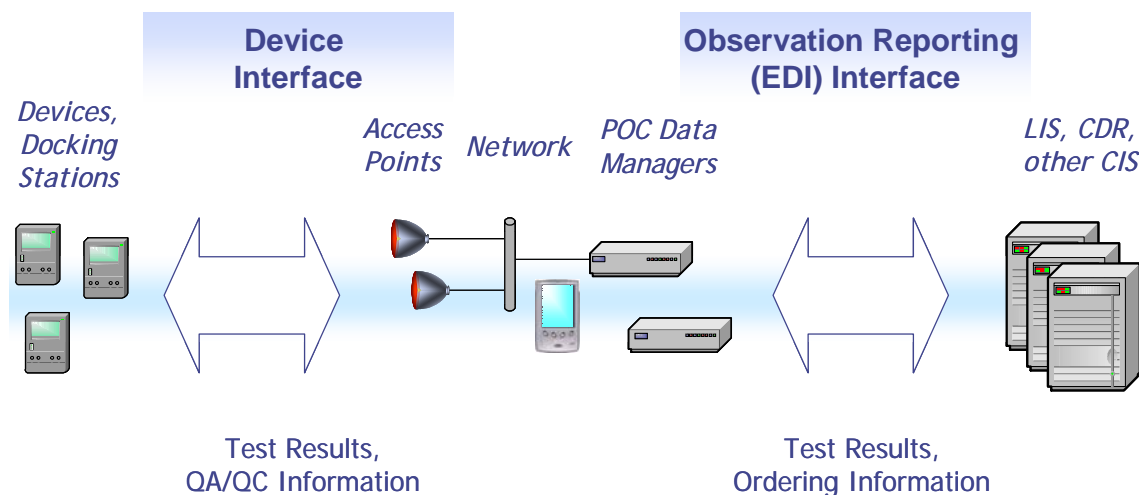

**Figure 2. The Two Interfaces**

## 4.1 Description of Connectivity System Components

Perhaps it is best to start by describing the devices and networks typically found in point-of-care testing systems to which this specification applies. It should be easier to understand the abstract parts of the interface specifications with a good image of a physical system in mind. The components and elements of the system may be:



### 4.1.1 The Point-of-Care Device

The emerging new diagnostic test technologies are packaged in a variety of devices. The devices that are within the scope of this specification are hand-held devices; test modules that are part of other instrumentation (a patient monitor, for example); or small, bench-top analyzers.

The bench-top devices support the concept of a remote or “satellite” laboratory located close to patients in the hospital or in a clinic setting. These modules leverage the electrical power and connectivity infrastructure provided by host instrumentation at the bedside. The hand-held devices are portable. They are used in a variety of settings that range from the hospital room to the home, as well as the clinic.

Although there is considerable diversity in device type and role, this specification attempts to support all point-of-care diagnostic devices. Accommodation is made in this specification to recognize the typically limited computing power and user interface facilities of these devices. In addition, this specification recognizes that hand-held devices are not continuously connected to a network, whereas other analyzers typically are.

<sup>b</sup> Also referred to as the “EDI interface.”



#### 4.1.2 Access Points

POC devices will need to communicate with an Observation Reviewer to report results and exchange information. In many hospital settings, one or more networked Access Points can be used to extend the ‘reach’ of the Observation Reviewer to all clinical care areas where POC devices can be used, both inside and outside the hospital or clinic. Standardization of this connectivity component is important, since it provides a common communication infrastructure that can be shared by many devices and services.



#### 4.1.3 The Observation Reviewer (POC Data Manager)

The primary role of an Observation Reviewer is to host one or more services to which point-of-care diagnostic devices connect. These services facilitate the collection of test and quality data from, as well as the management of these devices. In addition, services hosted by an Observation Reviewer may exchange data with existing information systems that already exist in the hospital or laboratory. In particular, Observation Reviewer services may interact with laboratory information systems (LIS), order communication systems, and medical record systems.

In general, products such as POC data managers currently fill the role of the Observation Reviewer; however, it is possible that in the future other systems concerned with observation management and reporting (e.g., LIS) may serve as Observation Reviewers. It may be easier to refer to Observation Reviewers as “data managers”; however, keep in mind that this specification does not require the existence of a stand-alone data manager. Instead, it requires only that some system fill the role and responsibilities of an Observation Reviewer.

Observation Reviewers are usually implemented in conventional information technology (IT) hardware with conventional IT software. Observation Reviewers typically reside within the IT spaces of the institution with fixed connections to the hospital’s network.

There may be more than one Observation Reviewer in a healthcare system. There may be some specialization of services in any given Observation Reviewer. An Observation Reviewer may host vendor-specific services in addition to the services required to support this connectivity standard.



#### 4.1.4 The Observation Recipient (LIS, CDR, or EMR)

Although outside the scope of this specification, Observation Recipient systems play an important role in point-of-care diagnostic systems. In many cases, the final resting place of a point-of-care diagnostic test observation is inside an Observation Recipient system.

Typically, LIS or Clinical Data Repository (CDR) systems fill the role of Observation Recipient.

This specification does not describe Observation Recipient behavior; however, services specified by this specification do facilitate interaction with Observation Recipient systems (e.g., to exchange test results and ordering information).

## 4.2 The Interfaces

One of the goals of this specification is to support a wide variety of POC information management implementations, including existing systems, as well as all reasonably conceivable future developments and topologies.



Two interfaces comprise the heart of this specification (Figure 2). In general, the *Device Interface* governs the flow of information between devices and Observation Reviewers, and the *Observation Reporting Interface* (sometimes referred to as the *EDI interface*) describes messaging between Observation Reviewers and Observation Recipients.

The character, nature, and attributes of the Device Messaging Layer and Access Point specifications are described in more detail in the following subsections.

### 4.2.1 The Device Interface

In general, Devices and Observation Reviewers are very tightly coupled systems. Devices with limited user-interface capabilities must rely on configuration and management services provided by Observation Reviewers. In turn, Observation Reviewers need strict control of devices to fulfill their responsibility to manage the quality and reporting of POC test results. The fact that this tight coupling must be deployed and maintained across large geographic areas and over a variety of telecommunication infrastructures (LAN, phone, Internet, wireless) presents additional complexity to the design of this interface.

The Device Interface addresses these requirements and challenges with a two-part specification. The Device Messaging Layer (DML) specification describes the structure, content, and flows of messages between a device and an Observation Reviewer. The Device and Access Point (DAP) specification defines a low-cost, flexible means to reliably communicate these messages.

Figure 3 illustrates how these two specifications are layered on top of one another.

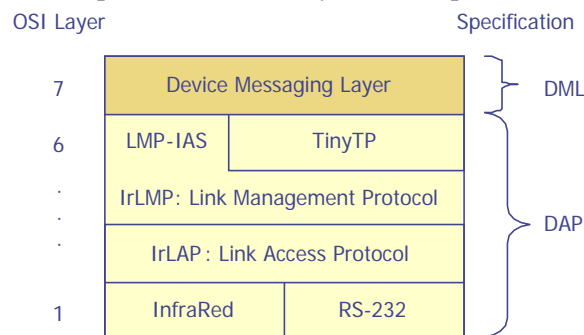
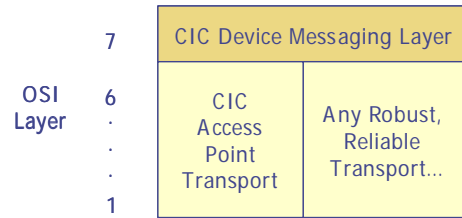

**Figure 3. Device Interface Layers**

Separating the specifications for messaging and for network access allows great flexibility for the future evolution of this interface. For example, one needs only to update the messaging layer to add support for additional application-level services (such as point-of-care ordering or result review). Similarly, the DAP can support other applications and devices, such as Medical Information Bus (MIB) and personal digital assistants (PDAs). The DAP can also support existing or vendor-specific protocols.

Likewise, while the DAP specification defines a transport optimized for current technology and market economics today (IrDA infrared and cable-connected), it is important to allow the future use of other lower-level transport and physical layers (e.g., Bluetooth™ or IEEE 802.11<sup>6</sup> wireless networking).

Figure 4 illustrates how other robust, reliable transports could be utilized in the future to carry device messages.



**Figure 4. Lower-Layer Networking Evolution**

*Device Messaging Layer (DML) Specification* (For the complete specification, see Appendix B.)

The Device Messaging Layer (DML) specification describes the dialog between a device and an Observation Reviewer. This protocol is a pure application-layer messaging scheme, requiring the existence of a robust, reliable lower-level transport.<sup>c</sup>

The DML allows for bidirectional data exchange on the following topics:

- 1 Device Status
- 2 Observations
  - 2.1 Patient Tests
  - 2.2 Calibration Tests
  - 2.3 Quality Tests
    - 2.3.1 Liquid QC
    - 2.3.2 Electronic QC
    - 2.3.3 Calibration Verification
    - 2.3.4 Proficiency Test
- 3 Device Events
  - 3.1 Test Denied
  - 3.2 Uncertified Operator
  - 3.3 Vendor-specific
- 4 Update Lists
  - 4.1 Operator List
  - 4.2 Patient List
- 5 Directives
  - 5.1 Set Time
  - 5.2 Lockout (with explanation)
  - 5.3 Remove Lockout
  - 5.4 Vendor-specific
- 6 Vendor-specific Data Exchange

**Figure 5. Device Messaging Layer Data Topics**

Point-of-care devices on the market today encompass a wide range of capabilities and complexity. For example, “simple” devices like some hand-held glucose meters only need to (and only are able to) report

<sup>c</sup> The terms “robust” and “reliable” have formal meanings. In short, a transport with these attributes guarantees messages will not be corrupted in transit and that senders will always be informed if a message can’t be delivered.

their status and stored observations. Other more complex hand-held devices may be able to handle the entire range of topics listed in Figure 5.

In addition, devices connect differently to download data. Most hand-held devices require a user to periodically “dock” the device to initiate the data exchange. In some cases, this docking involves placing the device in a special cradle. In other cases, it involves pointing the device’s infrared port at a fixed transceiver. No matter what the mechanism, the following general observations apply to these “docking” systems:

- user-initiated establishment of a physical connection;
- user-initiated start of a “data download” sequence; and
- periodic interruption of the physical connection (when the device is “undocked”).

In contrast to this *intermittent* connection model, some devices have built-in network connectivity, and can remain *continuously* connected to network-located Observation Reviewer services.<sup>d</sup> Consequently, there is no need for users to initiate download sequences. Typically, these devices automatically report new status, configuration, or observation information whenever it becomes available.

This variability presents several challenges for the messaging layer. In order to address these issues, the Device Messaging Layer allows some flexibility in how devices implement data exchange. Key aspects of this approach are as follows:

- (1) **Minimum Topic Requirements**—All devices are required to support at least the status and observation topics. An exchange covering only these topics would be sufficient to support test result reporting processes.
- (2) **Scalable Conversation Topics**—Beyond the minimum topic requirement, devices may support any number or combination of the additional topics listed in Figure 5. The Device Messaging Layer specification outlines a means by which a device informs an Observation Reviewer of the topics it supports.
- (3) **Dialogs Tailored to Device Capabilities**—The Observation Reviewer bears the responsibility to tailor the conversation to only those subjects that are relevant to the device.
- (4) **Support for Intermittently and Continuously Connected Devices**—The characteristics of the device connection determine the nature of the Device and Observation Reviewer message exchange. *Intermittently* connected devices use a message flow that is designed to rapidly exchange all data required to synchronize the Device and Observation Reviewer. *Continuously* connected devices maintain a long-term message flow, reporting new information as it becomes available.

Consider the following example of a dialog between an intermittently connected Device and an Observation Reviewer, described in terms of a dialog between two actors. The following “script” outlines how this dialog proceeds between a Device (DEV) and an Observation Reviewer (OR):

---

<sup>d</sup> Usually the connection is Ethernet running over twisted-pair cabling, but in some cases it is RS-232.

DEV: Hello Observation Reviewer, I'm device 'xyz'. I'm on-line.  
OR: Hello 'xyz'. You are a registered device. Please proceed.  
DEV: Here is my device status. What else would you like me to do?  
OR: Device 'xyz', please report your observations.  
DEV: Here are my observations. What else would you like me to do?  
OR: Device 'xyz', please report your device events.  
DEV: Here are my device events. What else would you like me to do?  
OR: Device 'xyz', please accept this Directive: 'xxx'.  
DEV: I can perform directive 'xxx'. What else would you like me to do?  
OR: Device 'xyz', please accept this vendor-specific communication: 'yyy'.  
DEV: I have received vendor-specific communication 'yyy'. What else would you like me to do?  
OR: Device 'xyz', please terminate this conversation.  
DEV: Goodbye, Observation Reviewer.

### Figure 6. Device Messaging Layer 'Script'

The individual messages in this conversation are encoded in XML. The XML-based approach best meets the requirements of flexibility, robustness, simplicity, and widespread, cross-industry support.

Rather than developing a completely new language in XML, the Device Messaging Layer leverages existing work done by HL7. Principally, this specification leverages the rules for encoding data types<sup>e</sup> and elements of the information model defined for Version 3 of the HL7 standard.<sup>7</sup>

<sup>e</sup> Defined in the HL7 Version 3 Data Types – Ballot Draft II (revision 1.3) document.

The following figure shows an example of the observation message used to report a glucose test result.

|  |  |   |
|--|--|---|
|  |  | <pre> &lt;?xml version="1.0" encoding="UTF-8"?&gt; &lt;!DOCTYPE OBS.R01 SYSTEM "OBS.R01.dtd"&gt; &lt;OBS.R01&gt;   &lt;HDR&gt;     &lt;HDR.control_id V="10003"/&gt;     &lt;HDR.version_id V="POCT1"/&gt;     &lt;HDR.creation_dttm V="2001-11-01T16:30:06-08:00"/&gt;   &lt;/HDR&gt;   &lt;SVC&gt;     &lt;SVC.role_cd V="OBS"/&gt;     &lt;SVC.observation_dttm V="2001-11-01T16:29:54-08:00"/&gt;     &lt;SVC.status_cd V="NRM"/&gt;     &lt;SVC.reason_cd V="NEW"/&gt;     &lt;SVC.sequence_nbr V="2524"/&gt;   &lt;PT&gt;     &lt;PT.patient_id V="PT222-55-7777"/&gt;     &lt;PT.location V="ICU-4"/&gt;     &lt;PT.name V="Jan Patient"&gt;       &lt;GIV V="Janet"/&gt;       &lt;FAM V="Patient"/&gt;     &lt;/PT.name&gt;     &lt;PT.birth_date V="1960-08-29"/&gt;     &lt;PT.gender_cd V="F"/&gt;     &lt;PT.weight V="110" U="lbs"/&gt;     &lt;PT.height V="66" U="inches"/&gt;   &lt;OBS&gt;     &lt;OBS.observation_id V="1517-2" SN="LN" DN="Glucose"/&gt;     &lt;OBS.value V="85" U="mg/dL"/&gt;     &lt;OBS.method_cd V="M"/&gt;     &lt;OBS.status_cd V="A"/&gt;     &lt;OBS.interpretation_cd V="N"/&gt;     &lt;OBS.normal_lo-hi_limit V="[80;120]" U="mg/dL"/&gt;     &lt;OBS.critical_lo-hi_limit V="[30;160]" U="mg/dL"/&gt;     &lt;NTE&gt;       &lt;NTE.text V="Temp warning"/&gt;     &lt;/NTE&gt;   &lt;/OBS&gt; &lt;/PT&gt; &lt;OPR&gt;   &lt;OPR.operator_id V="OP777-88-9999"/&gt;   &lt;OPR.name V="Pat Operator"&gt;     &lt;GIV V="Patrick"/&gt;     &lt;FAM V="Operator"/&gt;   &lt;/OPR.name&gt; &lt;/OPR&gt; &lt;SPC&gt;   &lt;SPC.specimen_dttm V="2001-11-01T16:27:00-08:00"/&gt; &lt;/SPC&gt; &lt;RGT&gt;   &lt;RGT.name V="GlucoseControl"/&gt;   &lt;RGT.lot_number V="123456" SN="BCHMX" SV="1.0"/&gt;   &lt;RGT.expiration_date V="2002-05-31"/&gt; &lt;/RGT&gt; &lt;NTE&gt;   &lt;NTE.text V="New strip"/&gt; &lt;/NTE&gt; &lt;NTE&gt;   &lt;NTE.text V="Repeat test"/&gt; &lt;/NTE&gt; &lt;/SVC&gt; &lt;/OBS.R01&gt; </pre> |
|--|--|---|

**Figure 7. Example Glucose Test Results Message**

#### 4.2.1.1 Device and Access Point (DAP) Specification (For the complete specification, see Appendix A.)

The Device and Access Point (DAP) specification describes a low-cost, flexible, reliable means to connect devices to Observation Reviewers located on a network. This standard describes low-level

communication protocols and physical interfaces used to connect to point-of-care devices. It specifies the use of a single transport protocol running over either of two physical layers—*IrDA infrared*<sup>f</sup> or *cable-connected*.<sup>g</sup>

To keep the implementation cost low (less than a dollar per device), this specification leverages widely adopted, commercially available existing standards. The infrared connection is based on the IrDA technology that is found in more than 100 million laptops, cell phones, and personal digital assistants.<sup>h</sup>

This standard also specifies how a *network access point* acts as a relay between the TinyTP connection to the device and a TCP/IP connection to a data manager on the network, and how the services of one or more POC data managers can be *registered* at an access point. This solution places most of the burden of finding, binding, and communicating with the appropriate network services on the access point rather than the device. Figure 8 illustrates how an Access Point can be used to provide an infrared or cable-connected device access to an Observation Reviewer located on a network.

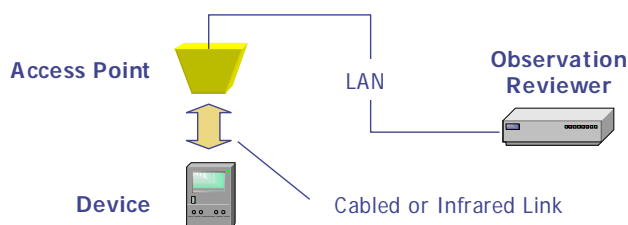

**Figure 8. Example Access Point Deployment Scenario**

Although not formally required by this standard, a key objective of this proposal is that it should be possible to build a *common access point* that can support point-of-care devices, MIB<sup>i</sup> and PDA<sup>j</sup> devices, regardless of differences between their upper-layer protocols and applications. The availability of a common access point infrastructure that could support POC, MIB, and hand-held PDA devices in all patient care areas would be a major benefit to clinicians and will accelerate the adoption of this standard.

Consistent with the need to support a variety of telecommunication and networking infrastructures, the Device and Access Point specification also provides recommendations regarding remote modem access. Commercially available IrDA-modem adapters provide one possible solution for remote modem access.

#### 4.2.2 The Observation Reporting Interface

The Observation Reporting Interface facilitates the communication of test results and order information between Observation Reviewers and Observation Recipients.<sup>k</sup> The interface provides bidirectional information flow between these services.

<sup>f</sup> As specified by the Infrared Data Association (IrDA).

<sup>g</sup> As specified by the ISO/IEEE 11073 lower-layers IrDA-based transport standard (ISO/IEEE 11073-30200<sup>3</sup>).

<sup>h</sup> The IrDA port is the small, semitransparent, red window on one of these devices.

<sup>i</sup> “Medical Information Bus” – an informal name for the IEEE 1073 family of standards for medical device communications, typically concerned with acute care devices such as infusion pumps, ventilators, and vital signs monitors to bedside patient monitors, internationally harmonized as ISO/IEEE 11073 standards.

<sup>j</sup> “Personal Digital Assistants” – consumer-oriented, hand-held computers.

<sup>k</sup> Again, it may help to think of Observation Reviewers as POC data managers and Observation Recipients as LIS systems. It’s important to keep in mind, though, that these alternate names describe one possible deployment configuration. For example, it’s quite possible that instead of an LIS, a clinical data repository (CDR) or other electronic medical record (EMR) system will serve the role of Observation Recipient.

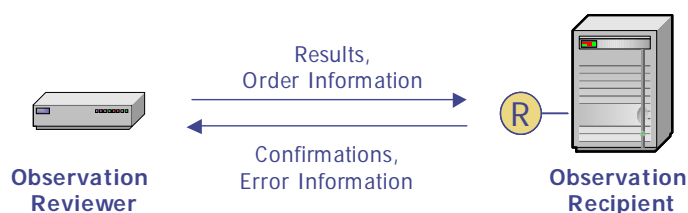

**Figure 9. Observation Reporting Interface**

Observation Reviewers use this interface to report test results with associated order information. Observation Recipients use this interface either to inform the Observation Reviewer when results have been successfully reported, or to communicate error information when a result or order can't be stored.

The clinical workflow surrounding point-of-care measurement and ordering processes is quite complex, dynamic, and flexible. The Observation Reviewer and Observation Recipient bear the major responsibility for making and managing the connection between orders and results. Thus, the Observation Reporting Interface is designed to handle the three most common result-and-ordering use cases:

- **Unordered Observation, Place an Order** – A test is performed without an order where the Observation Recipient should place an order.

One example of this use case occurs when a doctor verbally instructs a nurse to perform a test. From an information management perspective, it would be best if the nurse electronically enters an order before performing the test. However, in the real world, there usually isn't time for order entry in these situations. In fact, it is highly desirable for the point-of-care measurement process to become automated so that the only action a user needs to take is to make a measurement on the POC device, with all other processes for generating an order, and tying it in to the observation handled by the “machines.”

- **New Observation, Search for an Order** – A test is performed which may or may not have an order previously placed.

In this case, the Observation Reviewer does not know if an order has been placed. It instructs the Observation Recipient to search for an existing order for the associated results. The institution's business rules will determine what the Observation Recipient does if it can't find a matching order. Possibilities include automatically placing an order (as in use case 1, above), or logging an exception rather than recording the result.

- **Preordered Observation** – A test is performed that was previously ordered.

From a traditional central laboratory perspective, this use case is probably the predominant (if not exclusive) one. However, in the point-of-care environment, it is actually uncommon to have an order already generated when a test is performed.

#### 4.2.2.1 Observation Reporting Interface (ORI) Specification (For the complete specification, see Appendix C.)

The Observation Reporting Interface (ORI) specification heavily leverages the messages defined for laboratory instrument communication defined in Chapters 4, 7, and 13 of HL7's Version 2.4<sup>1</sup> specification. In fact, the specification is an implementation guide for using HL7 v2.4<sup>1</sup> messages to

support POC testing. As such, this specification does not define any new messages, segments or fields.<sup>1</sup> Instead, it simply provides a strict set of rules defining which messages are used and how each message is constructed. These rules increase the likelihood that separate implementations of this interface will easily interoperate.

For illustration purposes, Figure 10 shows a hypothetical message from an Observation Reviewer reporting a new result from a glucose meter (120 mg/dL) that is associated with a previously placed order (“OrdIDA24680”).

```

<VT>
MSH|^~\&|CICDMS|OBSREV|CICLIS|OBSRCPT|20000610010355||ORU^R30|20000610010355:023|P|2.4||AL|AL<CR>
PID||MR12345678^^^1|||||||ActID135792468^^^1<CR>
ORC|RE<CR>
OBR|OrdIDA24680||1234-5^GLU^LN|||||O||||5555^Smith^John^J^Dr<CR>
OBX|ST|1234-5^GLU^LN||120|mg/dl||||F||||User9876|CICDEV-111^SINGRES|20000609102135<CR>
NTE||Stat~Physician Notified<CR>
<FS><CR>
    
```

**Figure 10. Sample Observation Reporting Interface Message**

<sup>1</sup> The Observation Reporting Interface specification introduces four new HL7 message triggers that were not in the original v2.4 specification. HL7 has issued an “authoritative use statement” to formally authorize the use of these four new triggers in advance of being balloted by HL7 for a future version of their standard.



## References

- <sup>1</sup> HL7. *Health Level Seven – An Application Protocol for Electronic Exchange in Healthcare Environments*, Version 2.4. Ann Arbor, MI: Health Level Seven; 2000.
- <sup>2</sup> ISO/IEEE 11073-30300 *Health Informatics - Standard for point-of-care medical device communication – Part 30300: Transport profile – Infrared wireless*. Piscataway, NJ: Institute of Electrical and Electronics Engineers, Inc.; 2001.
- <sup>3</sup> ISO/IEEE 11073-30200. *Health Informatics – Point-of-care device communication – Transport file – Cable connected*. Piscataway, NJ: Institute of Electrical and Electronics Engineers, Inc.; Geneva, Switzerland: International Organization for Standardization; 2004.
- <sup>4</sup> IEEE 802.3. *Information Technology – LAN/MAN – Carrier Sense Multiple Access with Collision Detection (CSMA/CD) Access Method and Physical Layer Specifications*. Piscataway, NJ: Institute of Electrical and Electronics Engineers, Inc.; 2000.
- <sup>5</sup> ISO. ISO 9000:2000. *Quality management systems—Fundamentals and vocabulary*. Milwaukee, WI: American Society for Quality; 2000.
- <sup>6</sup> IEEE 802.11. *Information Technology – Telecommunications and Information Exchange Between Systems – LAN/MAN – Specific Requirements – Wireless LAN Medium Access Control (MAC) and Physical Layer (PHY) Specifications*. Piscataway, NJ: Institute of Electrical and Electronics Engineers, Inc.; 1999.
- <sup>7</sup> HL7. *Health Level Seven*. Version 3. Ann Arbor, MI: Health Level Seven; 2005.

**This page is intentionally left blank.**

## POINT-OF-CARE CONNECTIVITY SPECIFICATION

---

A standard for global application developed through the Clinical and Laboratory Standards Institute consensus process.





## Contents

### Appendix A. Device and Access Point (DAP) Interface Specification

|    |   |    |
|----|---|----|
| 1  | Scope and Introduction.....   | 25 |
| 2  | Definitions.....  | 25 |
| 3  | Abbreviations.....  | 27 |
| 4  | Overview of POC Device Networking (Informative).....                | 28 |
| 5  | Overview of IrDA and ISO/IEEE 11073-30200 (Informative).....        | 30 |
| 6  | Requirements for a 'POCT1-compatible' Device (Normative).....       | 36 |
| 7  | Requirements for a 'POCT1-compatible' Access Point (Normative)..... | 38 |
| 8  | Networked Access Points (Normative if Implemented).....             | 41 |
| 9  | Remote Modem Access (Informative).....                              | 47 |
| 10 | POC Devices With Direct Network Connections (Informative).....      | 48 |
| 11 | Data Security (Informative).....                                    | 49 |
| 12 | RF Wireless Networking Technologies.....                            | 50 |
| 13 | References.....   | 53 |

### Appendix B. Device Messaging Layer (DML) Specification

|    |   |     |
|----|---|-----|
| 1  | Scope and Introduction.....   | 63  |
| 2  | Bidirectional Communication.....                                    | 66  |
| 3  | General Messaging Issues.....                                       | 71  |
| 4  | Messaging Profile.....  | 76  |
| 5  | Information Model.....  | 91  |
| 6  | Messaging Model.....  | 110 |
| 7  | Extending the Device Messaging Layer.....                           | 126 |
| 8  | Annex A. Device Messaging Layer Data Types (Normative).....         | 128 |
| 9  | Annex B. Asynchronous Observation Acknowledgements (Normative)..... | 138 |
| 10 | Annex C. 'SET_TIME' Time Stamp and Time Zone Information.....       | 139 |
| 11 | Annex D. Example Messages (Informative).....                        | 144 |
| 12 | Annex E. POCT1 Messaging DTDs (Normative).....                      | 171 |

### Appendix C. Observation Reporting Interface (ORI) Specification

|   |                             |     |
|---|-----------------------------|-----|
| 1 | Scope and Introduction..... | 203 |
| 2 | Use Case Descriptions.....  | 203 |
| 3 | Message Profile.....        | 205 |
| 4 | HL7 Message Definition..... | 208 |
| 5 | Sample Messages.....        | 223 |

### Appendix D. Point-of-Care Requirements

|   |                   |     |
|---|-------------------|-----|
| 1 | Requirements..... | 257 |
|---|-------------------|-----|

### Appendix E. Connectivity Architecture

|   |                   |     |
|---|-------------------|-----|
| 1 | Architecture..... | 275 |
| 2 | Principles.....   | 275 |
| 3 | Approach.....     | 277 |
| 4 | Model.....        | 278 |

**Contents (Continued)**

**Appendix F. Vendor Codes**

1 Vendor Codes .....283

**APPENDIX A. DEVICE AND ACCESS POINT (DAP) INTERFACE  
SPECIFICATION**  
Transport and Physical Layer Specification

Paul Schluter and David Ma  
CIC Device Team Access Point Working Group

Alan Greenburg and Bob Uleski, Device Team Co-chairs and  
Imre Trefil, Joe Rogers, Mark Maund, and Dan Nowicki

---

A standard for global application developed through the Clinical and Laboratory Standards Institute consensus process.



© Clinical and Laboratory Standards Institute. All rights reserved.



**Contents**

|    |   |    |
|----|---|----|
| 1  | Scope and Introduction.....   | 25 |
| 2  | Definitions .....   | 25 |
| 3  | Abbreviations .....   | 27 |
| 4  | Overview of POC Device Networking (Informative) .....                           | 28 |
| 5  | Overview of IrDA and ISO/IEEE 11073-30200 (Informative).....                    | 30 |
|    | 5.1 IrDA Protocol Stack Summary .....   | 30 |
|    | 5.2 ISO/IEEE Standard 11073-30200 Cable-Connected Physical Layer .....          | 31 |
|    | 5.3 IrDA ‘Primary’ and ‘Secondary’ Roles .....                                  | 33 |
|    | 5.3.1 ISO/IEEE Standard 11073-30200 .....                                       | 33 |
|    | 5.3.2 PDA and LAN Access Point .....  | 34 |
|    | 5.3.3 Common Access Point .....   | 34 |
|    | 5.4 Client-Server Model for POC Device Communication .....                      | 35 |
| 6  | Requirements for a ‘POCT1-compatible’ Device (Normative) .....                  | 36 |
|    | 6.1 Device Physical Layer Requirements .....                                    | 36 |
|    | 6.2 Device Transport Layer and IAS Requirements .....                           | 37 |
| 7  | Requirements for a ‘POCT1-compatible’ Access Point (Normative) .....            | 38 |
|    | 7.1 Access Point Physical Layer Requirements.....                               | 39 |
|    | 7.2 Access Point Transport Layer and IAS Requirements.....                      | 40 |
| 8  | Networked Access Points (Normative if Implemented).....                         | 41 |
|    | 8.1 Transparent TinyTP to TCP/IP Connection.....                                | 42 |
|    | 8.2 Registering Data Managers in the Access Point IAS.....                      | 42 |
|    | 8.3 Control and Data Flow Between a Device, Access Point, and Data Manager..... | 42 |
|    | 8.3.1 Primary POC Device and Secondary Access Point (Case I).....               | 43 |
|    | 8.3.2 Secondary POC Device and Primary Access Point (Case II).....              | 44 |
|    | 8.3.3 TCP/IP Buffering and ‘Push’ Mechanism.....                                | 47 |
| 9  | Remote Modem Access (Informative) .....   | 47 |
|    | 9.1 Raw Serial Over WAN .....   | 47 |
|    | 9.2 Home PC as an Access Point .....  | 47 |
| 10 | POC Devices With Direct Network Connections (Informative).....                  | 48 |
| 11 | Data Security (Informative).....  | 49 |
| 12 | RF Wireless Networking Technologies (Informative) .....                         | 50 |
|    | 12.1 Background.....  | 50 |
|    | 12.2 Extending the DAP.....   | 51 |
|    | 12.3 RF Network Challenges.....   | 51 |

**Contents (Continued)**

13      References .....53

        13.1 ISO/IEEE 11073-30200 Transport and Physical Layer (Normative).....53

        13.2 ISO/IEEE 11073-30300 Transport and Physical Layer .....53

        13.3 IrDA Standards (Normative) .....53

        13.4 IrDA References (Normative if Implemented).....53

        13.5 World Wide Web Consortium Standards (W3C) (Normative) .....54

        13.6 HL7 Standards (Normative) .....54

**Figures**

Figure 11. Device and Access Point Scope ..... 25

Figure 12. Boxes 1a – 7a. Local and Remote Access Examples  
for POC Devices ..... 29

Figure 13. IrDA and IEEE OSI Stack Components ..... 30

Figure 14. Device and Access Point Interface Relationship ..... 31

Figure 15. Device and Access Point Client Server Model ..... 35

Figure 16. TinyTP to TCP/IP Connection Diagram ..... 42

Figure 17. IrCOMM to RS-232 Connection Diagram ..... 47

Figure 18. IrCOMM to Internet Connection Diagram ..... 48

**Tables**

Table 1. IAS Objects and Attributes for a POC Device (PDI) ..... 38

Table 2. IAS Objects and Attributes in an Access Point ..... 41

Table 3. Examples of IAS Object Classes, Server IP Addresses, and TCP  
Port Numbers for an Access Point ..... 42

Table 4. Control and Data Flow Between a Primary POC Device,  
a Secondary Access Point (AP), and a Data Manager (DM) ..... 44

Table 5. Control and Data Flow Between a Secondary POC Device (POCD),  
a Primary Access Point (AP), and a Data Manager (DM) ..... 46

## POINT-OF-CARE CONNECTIVITY SPECIFICATION

### 1 Scope and Introduction

This standard specifies the lower-layer communication protocols and physical interfaces for ‘point-of-care’ (POC) *Devices* and *Access Points*. The following figure illustrates this specification’s role relative to the other POCT1 specifications.

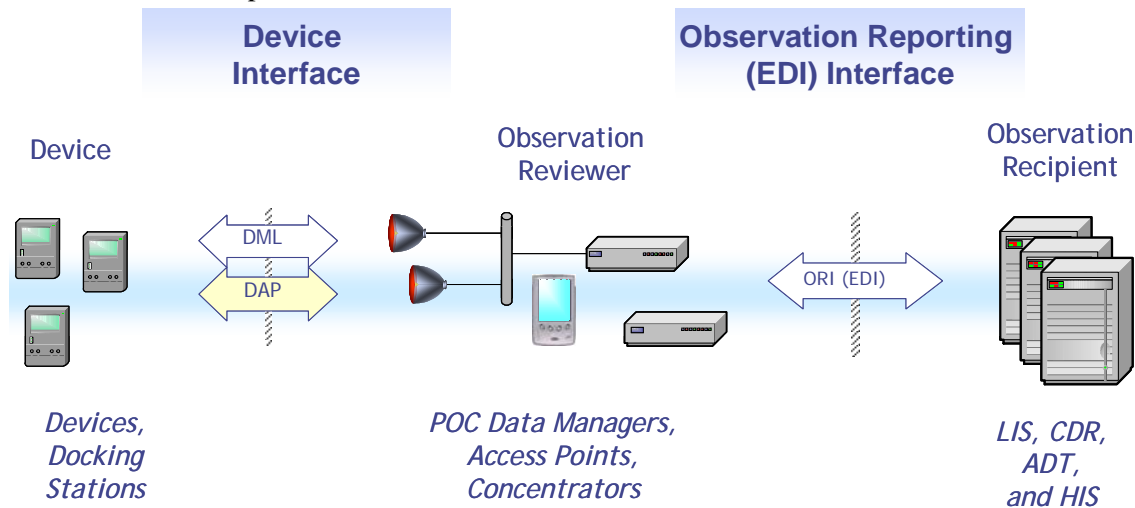

**Figure 11. Device and Access Point Scope**

This standard specifies the use of a single-transport protocol (IrDA TinyTP) running over either of two physical layers: 1) *IrDA-infrared*, as specified by the Infrared Data Association (IrDA); and 2) *cable-connected*, as specified by the IEEE Medical Information Bus (MIB) lower-layers standard ISO/IEEE 11073-30200.

This standard also specifies how a *network access point* acts as a relay between the TinyTP connection to the Device and a TCP/IP connection to a Data Manager on the network, and how the services of one or more POC Data Managers can be *registered* at a network access point. This solution places most of the burden of finding, binding, and communicating with the appropriate network services on the access point rather than the Device.

Although not formally required by this standard, a key objective is that it should be possible to build a *Common Access Point* that can support POC, MIB, and hand-held PDA devices, regardless of differences between their upper-layer protocols and applications. The availability of a Common Access Point infrastructure that could support POC, MIB, and hand-held PDA devices in all patient care areas would be a major benefit to clinicians and would accelerate the adoption of this standard.

Recommendations regarding remote modem access are also provided, based on the IrDA infrastructure and protocols defined by this document.

### 2 Definitions

**Access Point (AP)** – a subsystem that consolidates data from one or more point-of-care devices (POCD) onto another communication link; **NOTE:** Examples of access points include a multiport concentrator or a dedicated single-port access point, typically connected to a local area network (LAN), or an access point that is part of a multifunctional device such as a patient monitor or personal computer.

**Access Point Interface (API)** – specifies the interface (principally input) to an Access Point or concentrator; **NOTE:** This definition is equivalent to IEEE ‘BCC.’

**Bedside Communication Controller (BCC)** – specifies the interface (principally input) to an Access Point or concentrator; **NOTE:** This is an IEEE definition, equivalent to ‘API.’

**Common Access Point (CAP)** – an Access Point that can service MIB, POC, and hand-held PDA devices.

**Connectivity Industry Consortium (CIC)** – a group of more than 50 healthcare institutions, point-of-care diagnostic vendors, diagnostic test system vendors, and system integrators who formed a consortium in 2000 to address standards for point-of-care connectivity; **NOTE 1:** The CIC developed a standardization specification within its planned one-year lifetime, and then handed this specification over to CLSI ([www.clsi.org](http://www.clsi.org)), Health Level 7 ([www.hl7.org](http://www.hl7.org)), and IEEE ([www.ieee.org](http://www.ieee.org)) organizations for subsequent maintenance and extension; **NOTE 2:** The CIC specification forms the basis for the CLSI POCT1 standard.

**Data Manager (DM)** – typically, a network server that provides the services of an Observation Reviewer (e.g., POC data storage and forwarding, QA/QC, and other POC instrument and data management functions); **NOTE 1:** In addition to these services, Data Managers usually provide other applications or services tailored to particular devices or POC user needs (such as regulatory reporting and operator management applications); **NOTE 2:** Data Manager systems are specific instances of Observation Reviewer services.

**Data Manager Interface (DMI)** – specifies the TCP/IP network interface and protocol between a Data Manager and one or more Access Points.

**Device Communication Controller (DCC)** – specifies the interface (principally output) of a POC Device or its Docking Station to an Access Point; **NOTE:** This is an IEEE definition, equivalent to ‘PDI.’

**Docking Station (DS)** – a mechanical and electrical interface that supports the use of a POC Device, typically employing legacy mechanical interfaces, connectors, protocols, and power delivery methods.

**Electronic Data Interchange (EDI)** – electronic Data Interchange is a term used in many industries to describe protocols to exchange data between enterprise-class information systems; **NOTE 1:** The acronym is general (applying to all such exchange protocols and languages); however, in some industries it has come to refer to specific implementations; **NOTE 2:** In the point-of-care domain, this term is occasionally used to refer to the specific interface found between point-of-care data management systems, laboratory information systems, clinical information systems, and other systems that serve as the final repository of POC results.

**Information Access Service (IAS)** – advertises capabilities of IrDA Devices; **NOTE:** Also termed IrLMP-IAS.

**Infrared (IR)** – the physical layer typically used by infrared data association (IrDA) devices.

**Infrared Data Association (IrDA)** – an organization that creates and promotes interoperable, low-cost infrared data interconnection standards ([www.irda.org](http://www.irda.org)); **NOTE:** ‘IrDA’ also refers to the protocol stack authored by that group.

**The Institute of Electrical and Electronics Engineers (IEEE)** – an international, ANSI-accredited standard development organization dedicated to the advancement of electrical and information technologies; **NOTE:** Among its many roles, the IEEE sets standards for the electronics industry such as

IEEE Standard 1073 for Medical Device Communications and IEEE Standard 802.3, which forms much of the lower-layers foundation for the Internet ([www.ieee.org](http://www.ieee.org)).

**ISO/IEEE 11073** – a family of standards for medical device communications that are optimized for the acute care setting; **NOTE:** When they are harmonized with IEEE 1073 standards, the designation is ISO/IEEE 11073 (see **IEEE 1073**).

**Link Service Access Point (LSAP)** – see **Service Access Point**.

**Medical Data Device Language (MDDL)** – used as the upper-layer protocol for ISO/IEEE 11073 devices.

**Network Time Protocol (NTP)** – principal time synchronization and distribution protocol used on the Internet (RFC-1305); **NOTE:** NTP provides robust, reliable, and highly accurate time synchronization using algorithms and protocols that utilize a hierarchical network of time servers and clients that are ultimately tied to one or more primary time servers connected to external times sources, such as a GPS radio clock or ACTS telephone modem time service.

**Point of Care (POC)** – the environment immediately surrounding a patient.

**Point-of-Care Device (POCD)** – in the context of this standard, a point-of-care device is an instrument used at the patient’s side to measure and/or record a clinical observation; **NOTE:** This definition does not require that the POCD measure the observed value; thus, this definition encompasses devices that perform biochemical analyses, devices that calculate observations from results determined externally, or devices that simply record values determined by other procedures.

**POC Device Interface (PDI)** – specifies the interface (principally output) of a POC Device or its Docking Station to an Access Point; **NOTE:** This definition is equivalent to IEEE ‘DCC.’

**Point-to-Point Protocol (PPP)** – a protocol for framing IP datagrams over a serial line.

**Service Access Point (SAP)** – an IrDA connection service endpoint provided by the IrLMP-IAS Information Access Service directory; **NOTE:** Also termed **Link Service Access Point (LSAP)**.

**Simple Network Time Protocol (SNTP)** – a simplified version of NTP that can be used by small, lightweight clients (RFC-2030).

**Tiny Transport Protocol (TinyTP)** – IrDA transport protocol that provides multiple, concurrent, reliable, bidirectional communication streams on an IrDA link with robust flow control.

**Transmission Control Protocol/Internet Protocol (TCP/IP)** – a transport protocol that provides reliable, bidirectional, stream-oriented network communication; **NOTE:** TCP/IP is one of the foundation protocols of the Internet.

**Unshielded Twisted Pair (UTP)** – the type of CAT-5 cabling used in this standard.

### 3 Abbreviations

**DHCP** Dynamic Host Configuration Protocol [RFC-2131]

**FIR** IrDA ‘Fast Infrared’ at the negotiated speed of 4 MBd

- MIB** Medical Information Bus — ISO/IEEE standards, including the lower-layers standards ISO/IEEE 11073-30200 and 11073-30300
- MIB** Management Information Base [RFC-1213 ‘MIB-II’ and related RFCs]
- MIR** IrDA ‘Medium Infrared’ at the negotiated speeds of 576 or 1152 kBd
- SIR** IrDA ‘Serial Infrared’ at the slower speeds of 9600 Bd to 115.2 kBd
- SNMP** Simple Network Management Protocol [RFC-1157 for SNMPv1; SNMPv3 is the latest version]
- SNTP** Simple Network Time Protocol [RFC-2030] — A simplified version of SNTP suitable for ‘leaf’ Devices on a network
- VFIR** IrDA ‘Very Fast Infrared’ at the negotiated speed of 16 MBd

#### 4 Overview of POC Device Networking (Informative)

A ‘POC System’ is defined as a collection of one or more Devices and subsystems that can perform a POC measurement in the patient care area and report the results using an ‘Electronic Data Interchange’ (EDI) interface to a hospital ‘Laboratory Information System’ (LIS), ‘Hospital Information System’ (HIS), or other system that is the final repository for the POC measurement results. In most installations, the EDI interface uses the HL7 upper-layer protocol running over a network TCP/IP connection.

Devices, subsystems, and principal interfaces (highlighted in gray) that comprise a POC System are defined below in the order of data flow from a POC Device to a Laboratory Information System (LIS).

|             |  |
|-------------|--|
| <b>POCD</b> | A ‘ <b>POC Device</b> ’ performs the blood chemistry and other measurement(s) in the patient care area.  |
| <b>DS</b>   | A ‘ <b>Docking Station</b> ’ may be used to provide a mechanical and electrical interface that supports the POC Device. The docking station may use a legacy mechanical interface, a connector, a protocol and a power delivery method. <i>The docking station is optional.</i>  |
| <b>PDI</b>  | The POC Device or its Docking Station uses its ‘ <b>POC Device Interface</b> ’ to communicate its data (principally output) to an Access Point Interface.  |
| <b>API</b>  | The ‘ <b>Access Point Interface</b> ’ specifies the interface (principally input) to an Access Point or Concentrator.  |
| <b>AP</b>   | The ‘ <b>Access Point</b> ’ or ‘ <b>Concentrator</b> ’ consolidates the data from one or more Devices onto another communication link, possibly using a different physical layer and transport protocol. <i>This subsystem is optional.</i><br>Examples of an Access Point are listed below, and other implementations are permitted:<br>(a) a multipoint concentrator, typically connected to a local area network (LAN);<br>(b) a dedicated single-port access point, typically connected to a LAN; and<br>(c) an access point that is part of a multifunctional Device such as a personal computer. |
| <b>DMI</b>  | The ‘ <b>Data Manager Interface</b> ’ specifies the TCP/IP network interface to a Data Manager.  |
| <b>DM</b>   | A ‘ <b>Data Manager</b> ’ performs such functions as (1) Device data storage and forwarding, (2) QA/QC, and (3) other vendor-specific functionality.   |
| <b>EDI</b>  | The ‘ <b>EDI Interface</b> ’, typically provided by the Data Manager, is used to report the results to a hospital ‘Laboratory Information System’ (LIS), ‘Hospital Information System’ (HIS), or other system that is the final repository for the POC measurement results. The EDI interface typically uses HL7 over a network TCP/IP connection.   |

Boxes 1a - 7a of Figure 12 on the following page illustrate how POC Devices, subsystems, and their principal interfaces can be used in a typical hospital environment, including remote-access configurations that employ modems and analog phone lines. This figure depicts many of the common scenarios that the CIC has identified for possible standardization, but is not meant to preclude other configurations, such as connecting a Device in a home through a personal computer.

Although not shown on the diagram, multiple vendor-specific Data Managers can coexist on the network, and this standard allows a Device to communicate with a *vendor-specific* or *generic* Data Manager.

**1. Acute care settings (ICU, CCU, OR ...)**

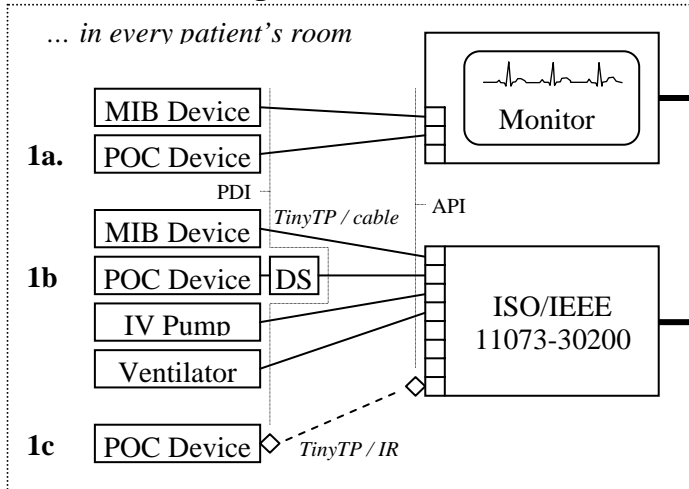

**2. IrDA devices in general clinical care areas**

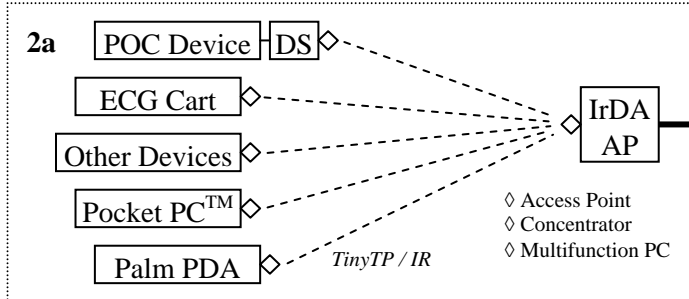

**3. Mobile devices using RF LAN or cellular**

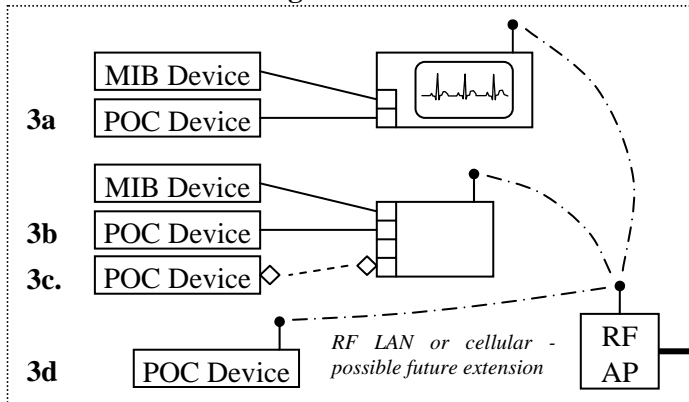

**4. Remote POC device using modem access**

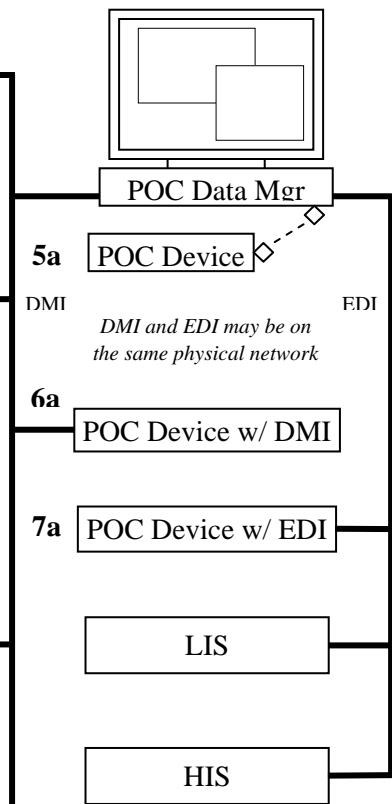
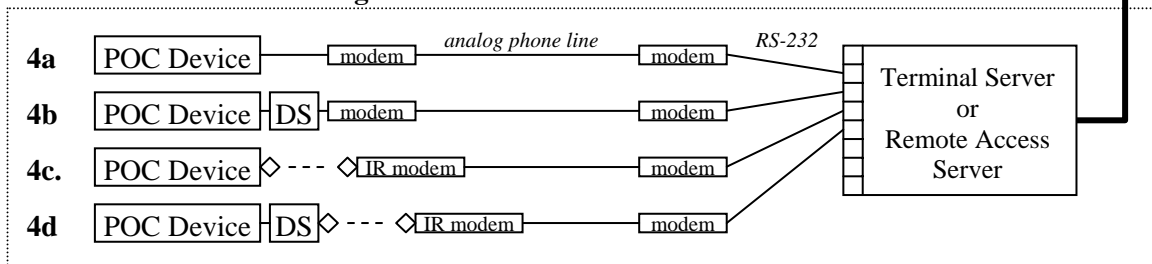

**Legend**

Cable —————

IrDA IR ◇ - - - - ◇

RF ● - - - - ●

Ethernet —————

*Ethernet hubs, switches, routers, etc. are not shown.*

TCP/IP or UDP/IP on Ethernet

**Figure 12. Boxes 1a-7a. Local and Remote Access Examples for POC Devices**

## 5 Overview of IrDA and ISO/IEEE 11073-30200 (Informative)

This section provides an overview of the Infrared Data Association (IrDA) and ISO/IEEE 11073-30200 on which most of this standard is based. References to these standards are listed in Section 13.

### 5.1 IrDA Protocol Stack Summary

Communication protocol layering is consistent with IrDA-Data standards, as shown below.

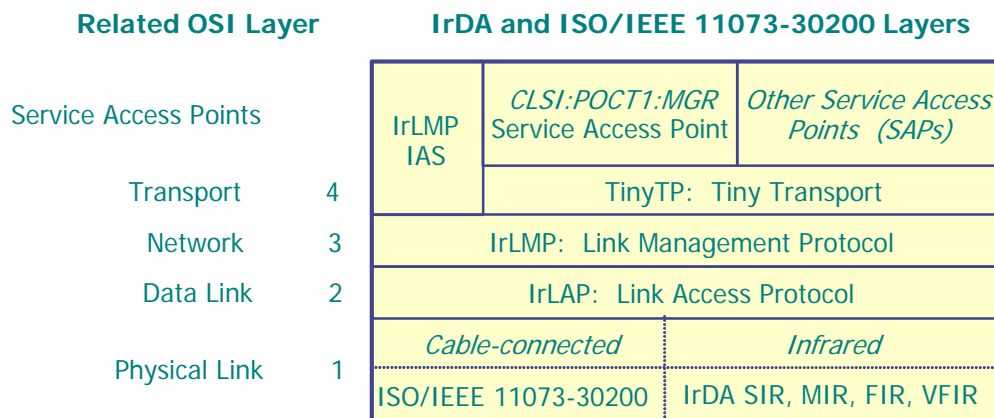

**Figure 13. IrDA and IEEE OSI Stack Components**

The components of the stack are briefly as follows:

**Physical layer** – defines a standard connector and electrical characteristics.

**ISO/IEEE 11073-30200:** cable-connected, RS-232; default: 9600 Bd, negotiated: 19.2, 38.4, 57.6, 115.2 kBd.

**IrDA ‘Serial Infrared’ (SIR):** default: 9600 Bd, negotiated: 19.2, 38.4, 57.6, 115.2 kBd.

**IrDA ‘Medium Infrared’ (MIR):** default: 9600 Bd, negotiated: 576 or 1152 kBd (optional).

**IrDA ‘Fast Infrared’ (FIR):** default: 9600 Bd, negotiated: 4 MBd (optional).

**IrDA ‘Very Fast Infrared’ (VFIR):** default: 9600 Bd, negotiated: 16 MBd (optional).

This standard, as well as ISO/IEEE 11073-30200, specifies signaling speeds consistent with IrDA SIR [default 9600 Bd and optional negotiated signaling speeds of 19.2, 38.4, 57.6, and 115.2 kBd]. An infrared access point or device may also support the optional IrDA ‘MIR’ speeds [576, 1152 kBd], ‘FIR’ speed [4 MBd] and/or ‘VFIR’ speed [16 MBd]. It should be recognized, however, that the majority of point-of-care devices will use the slower SIR signaling rates, and that the availability of multiple SIR rates should not be sacrificed in order to support the faster MIR, FIR, and VFIR rates. Like many other IrDA communication parameters, the signaling rate is negotiated and the fastest common rate is used by both entities, and communication at 9600 Bd is always possible.

**IrLAP** – provides a Device-to-host connection for the reliable, ordered transfer of data, including Device discovery procedures.



**IrLMP** – provides multiplexing of the IrLAP layer and Device information via the Device’s *Information Access Services* database of available services, the **IrLMP-IAS** (or simply the **IAS**).

**TinyTP** – provides flow control on IrLMP connections and negotiated optional segmentation and reassembly.

**CLSI:POCT1:MGR SAP** – an IrDA ‘service access point’ that provides a TCP/IP connection to a ‘CLSI POCT1 Data Manager.’ The services of a ‘generic’ and ‘vendor-specific’ data manager can be specified by ‘CLSI:POCT1:MGR:GENERIC’ and ‘CLSI:POCT1:MGR:VENDOR,’ respectively.

Additional SAPs may be defined in the Information Access Service (IAS) directory of the Access Point or Device. These include SAPs that support other application protocols such as the Medical Data Device Language (MDDL); Simple Network Time Protocol (SNTP); and IrDA IrCOMM serial port emulation for infrared-modems or network access using the Point-to-Point protocol (PPP).

This standard, as well as ISO/IEEE 11073-30200, requires that both the Device and Access Point support the IrDA protocol stack layers IrLAP, IrLMP, IrLMP-IAS, and TinyTP.

## 5.2 ISO/IEEE 11073-30200 Cable-Connected Physical Layer

This section summarizes the essential requirements and capabilities of ISO/IEEE 11073-30200 cable-connected physical layer. Unless otherwise noted, ISO/IEEE 11073-30200 shall be the authoritative specification for the POCT1 cable-connected physical layer standard.

The ISO/IEEE 11073-30200 specifies a *point-to-point cable connection* between a ‘Device Communication Controller’ (DCC) and a ‘Bedside Communication Controller’ (BCC). The relationship between the terminology used by this CLSI standard and ISO/IEEE 11073-30200 is summarized below; the CLSI terminology will be used in this standard unless otherwise noted.

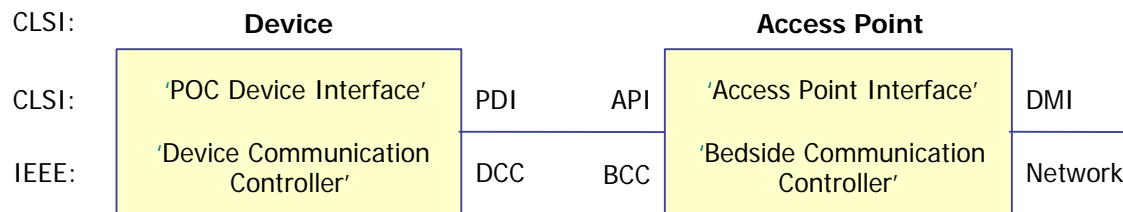

**Figure 14. Device and Access Point Interface Relationship**

The following section summarizes the key requirements for the POCT1 cable-connected physical layer and is fully compliant with the physical layer defined in ISO/IEEE 11073-30200:

1. RS-232 signaling levels over unshielded twisted pair (UTP) Category-5 cable;
2. RS-232 signaling speeds: 9600 Bd and optional negotiated speeds of 19.2, 38.4, 57.6, and 115.2 kBd;
3. Octet encoding: one start bit, eight data bits, no parity bit, one stop bit; and
4. An eight-pin RJ-45 modular connector at the Access Point (BCC/API) using the pin assignments shown in the table below. The POC Device or Docking Station Interface (DCC/PDI) may use (1) an RJ-45 connector with the pinout shown below; (2) any other connector or pinout appropriate to the clinical use of the Device; or (3) a permanently attached cable.

| Access Point (BCC/API) | Pin and signal direction | Function                        | Device (DCC/PDI)    |
|------------------------|--------------------------|---------------------------------|---------------------|
| <i>bRD+</i>            | 1 ←                      | <i>DPWR / 10/100BASE-T</i>      | <i>dDPWR / dTD+</i> |
| <i>bRD-</i>            | 2 ←                      | <i>BCC sense / 10/100BASE-T</i> | <i>dCS- / dTD-</i>  |
| <i>bCS+ / bTD+</i>     | 3 ⇒                      | <i>DCC sense / 10/100BASE-T</i> | <i>dRD+</i>         |
| <i>bGND</i>            | 4 ⇔                      | <i>Signal Ground</i>            | <i>dGND</i>         |
| <i>bRxD</i>            | 5 ←                      | <i>RS-232</i>                   | <i>dTxD</i>         |
| <i>bCS- / bTD-</i>     | 6 ⇒                      | <i>DCC sense / 10/100BASE-T</i> | <i>dRD-</i>         |
| <i>bTxD</i>            | 7 ⇒                      | <i>RS-232</i>                   | <i>dRxD</i>         |
| <i>bBPWR</i>           | 8 ⇒                      | <i>BPWR</i>                     | <i>dBPWR</i>        |

**Pinout Notes:**

The RxD, TxD, and GND signals support the RS-232 serial data interface. BPWR and DPWR provide power for a line accessory or a DCC. CS and DPWR provide connection sensing.

This standard is compatible with a 10/100BASE-T interface, supported by the RD± and TD± signals (pins 1-2 and 3-6). A BCC port may be designed to support the ability to detect an ISO/IEEE 11073-30200 (RS-232) connection or a 10/100BASE-T connection, and to communicate with either Device. [However, 10/100BASE-T functions for BCCs and DCCs are currently out of the scope of the ISO/IEEE 11073-30200.]

A BCC can sense the connection of a DCC by testing the resistance across its *bCS+* and *bCS-* pins. The alternative names *bTD+* and *bTD-* indicate the 10/100BASE-T transmit data function.

A DCC may provide power on its *dDPWR* line to a line-extender or communications adapter. A DCC can sense its connection to a BCC by testing the resistance between its *dDPWR* and *dCS-* pins. The alternative names *dTD+* and *dTD-* indicate the 10/100BASE-T transmit data function.

This section summarizes the *optional* capabilities for the POCT1 cable-connected physical layer for this CLSI standard and is consistent with the recommendations provided by ISO/IEEE 11073-30200:

- ISO/IEEE 11073-30200 specifies three DC-power delivery options the BCC/API and DCC/PDI:

|                   |  |
|-------------------|--|
| <b>Zero-power</b> | The BCC or DCC does not provide power.   |
| <b>Low-power</b>  | The BCC or DCC offers power levels that are typically provided by the parallel connection of RTS    DTR or a single RTS or DTR pin of a standard RS-232 communications port. This can be used to power line isolators and extenders. |
| <b>High-power</b> | The BCC or DCC offers DC power of +5.0 V ±5% @ 100 mA. This can be used for powering a wide range of Devices that have modest power requirements.  |

- ISO/IEEE 11073-30200 provides a detailed discussion of the three DC-power options. Although complete interoperability would require a single DC-power delivery option (e.g., ‘high-power’), the ability to communicate with a standard serial port using a passive adapter was also considered an essential requirement by the ISO/IEEE 11073-30200 subcommittee, and hence the ‘zero-power’ and ‘low-power’ options were created. *In order to promote the highest degree of cable-connected POC and MIB Device interoperability, it is recommended that the ‘high-power’ option be implemented at the Access Point.*
- ISO/IEEE 11073-30200 also defines additional optional physical layer capabilities, such as the ability of an Access Point to sense the connection of a Device and the ability of a Device to sense its connection to an Access Point, without requiring the sensed entity to be powered. This capability can be used to provide an informative message to the user such as ‘please turn on the Device’ or ‘communication error.’ Implementation of the terminating impedance (or short) in the DCC/PDI and BCC/API is mandatory, but implementation of the detection circuitry is optional.

8. ISO/IEEE 11073-30200 is compatible with the RJ-45 pinout for 10BASE-T as defined in Clause 14 of ISO/IEC 8802-3-1996 and IEEE Standard 802.3-1998, and 100BASE-TX for unshielded twisted pair cable as defined in Clause 25 of IEEE Standard 802.3-1998. The two standards, 10BASE-T and 100BASE-TX, are collectively referred to as '10/100BASE-T' in this document. Implementation of either of these physical layers is not required nor has a complete set of ISO/IEEE 11073 protocol(s) been defined for them at the present time.
9. The maximum recommended ISO/IEEE 11073-30200 cable length is 20 meters, based on the electrical properties of the cable and connectors and use of the 'high-power' DC-power delivery option.
10. ISO/IEEE 11073-30200 provides guidelines for physical media marking and color (yellow).

Although a nonisolated connection between the Device (DCC/PDI) and Access Point (BCC/API) is permitted by ISO/IEEE 11073-30200, it is highly recommended that at least one component (either the DCC/PDI, BCC/API, or a cable adapter) provide electrical isolation if direct connection to the patient could occur or in situations where 'ground-loops' would compromise communications reliability.

### 5.3 IrDA 'Primary' and 'Secondary' Roles

IrDA IrLAP communication partners act in one of two roles: there is one *primary* station and one or more *secondary* stations. The primary station *discovers* all available secondary stations and typically establishes a connection to a specific secondary station (although more than one is possible).

At the lower IrLAP protocol layer, the primary station is always the initiator of the data transfer and the secondary station reacts to commands from the primary. At the IrLMP and TinyTP layers, however, the master/slave nature of IrLAP is hidden from the application and a symmetrical set of services is provided, regardless of whether a station participates as a *primary* or *secondary*.

ISO/IEEE 11073-30200 and IrDA-compatible PDAs such as the Palm™ or PocketPCs™ use different conventions for assigning IrDA primary and secondary roles to Devices and access points. Although operation as an IrDA primary or secondary is generally hidden from applications that use the IrDA IrLMP and TinyTP protocol layers, differences do exist and are addressed in this section.

#### 5.3.1 ISO/IEEE 11073-30200

ISO/IEEE 11073-30200 uses the following IrDA primary and secondary conventions:

- the Device Communications Controller (DCC) participates as a IrDA *secondary* station; and
- the Bedside Communications Controller (BCC) participates as an IrDA *primary* station.

As frequently as every one or two seconds, the BCC performs IrDA *discovery* to see if a DCC is attached to the cable. The IrDA *secondary* role assigned to the DCC and *primary* role assigned to the BCC are appropriate for the acute-care settings that ISO/IEEE 11073-30200 is intended to be used for the following reasons:

1. The BCC can poll the DCC in a deterministic manner. This is critical in the acute-care setting where it is necessary to have second-by-second parameter and alarm updates from ventilators and heart-rate monitors.

2. The BCC, as the *client* (initiator and controlling entity) requests data from the DCC, which acts as the *data server* (source of data) during the session. This fits the IrDA client-server model with the BCC participating as a primary and the DCC participating as a secondary station.
3. DCCs are often memory constrained and thus benefit from the smaller secondary IrDA stack size.
4. Provides a broadcast capability, at least per BCC.
5. Allows the BCC to communicate with multiple DCCs.<sup>m</sup> Although point-to-multipoint communication is not supported by the cable-connected topology specified by ISO/IEEE 11073-30200, nor is it currently specified by the IrDA standards, this capability would be useful for a multiDevice POC download station.

### 5.3.2 PDA and LAN Access Point

A PDA and LAN Access Point (LAP) use the following IrDA primary and secondary conventions:

- the Palm<sup>TM</sup> or Pocket PC<sup>TM</sup> participates as an IrDA *primary* station; and
- the LAP participates as an IrDA *secondary* station.

The Palm<sup>TM</sup> or Pocket PC<sup>TM</sup> initiates the transaction as a *client* by performing IrDA *discovery*, and the LAP passively waits for the request on behalf of the *server* on the network in a *client-server* relationship.

The IrDA *primary* role assigned to the PDA and *secondary* role assigned to the LAP are also appropriate for POC data transfer for the following reasons:

1. The PDA, as the initiator of the client-server data exchange, contends for access to the IR medium only when it has something to transfer. This minimizes IR traffic that could interfere with other IR Devices.
2. The PDA, as the IrDA primary, can rapidly access the LAP services, since it does not need to wait for the discovery-polling interval (if the LAP was an IrDA primary station).
3. These roles (PDA as primary and LAP as secondary) represent industry-standard practice for the majority of IrDA-compatible Devices (including printers and modems) described in the IrDA ‘Point and Shoot’ profile.<sup>n</sup>

### 5.3.3 Common Access Point

Based on the discussion above, two conventions have been used for assigning IrDA primary and secondary roles for Devices and access points. The section explores how both conventions can be incorporated into a ‘Common Access Point’ that can support IEEE MIB, CLSI POC, and hand-held PDA Devices.

In order to support ISO/IEEE 11073-30200 cable-connected DCCs (Devices) as IrDA secondaries and hand-held PDAs or POC Devices as IrDA primaries, the ‘Common Access Point’ (CAP) should be able to function either as an IrDA primary or secondary station, depending on the type of Device that attempts

<sup>m</sup> The IrDA standards specify how a primary station can *discover* multiple secondary stations, and communicate with them one at a time. The IrDA standards currently do not specify how point-to-multipoint communication should be performed, but this capability could be added at a later date.

<sup>n</sup> Infrared Data Association ‘Point and Shoot Profile,’ Version 1.0, January 12, 2000; available from IrDA at <http://www.irda.org/displaycommon.cfm?an=l&subarticlenbr=7>.

to communicate with it.<sup>o</sup> It should be noted that many IrDA Devices are capable of participating as IrDA primary or secondary stations, so implementing this capability in an access point should not be difficult.

Although supporting both roles places an additional burden on the CAP, it provides the greatest flexibility to the POC Device designer, where limited memory size and processor capability may be major issues. A POC Device that has ample memory can participate as an IrDA primary, consistent with how hand-held PDAs communicate with LAN Access Points. As an IrDA primary, the POC Device would be able to rapidly establish a connection with the CAP since the POC Device would not have to wait for the ‘discovery-polling interval.’

A POC Device that has limited memory could instead participate as an IrDA *secondary*, similar to an ISO/IEEE 11073-30200 DCC (Device communication controller). A relatively short *discovery-polling interval* (~ one second) could be used with the cable-connected RS-232 physical layer specified by this standard, allowing rapid discovery of the POC or MIB Device.

### 5.4 Client-Server Model for POC Device Communication

Three cases of client-server and primary-secondary need to be considered.

Cases I and II summarize how the POC Device participates as the client and the Access Point participates as (or represents) the server in a client-server relationship, regardless of which entity is the IrDA primary or secondary. Both are supported and specified by this standard.

Case III summarizes how an ISO/IEEE 11073-30200 DCC participates as the data-server (and IrDA secondary), and the BCC participates as the client (and IrDA primary). This case can coexist with but is not required by this standard. A step-by-step protocol walk-through for this case is provided in ISO/IEEE 11073-30200.

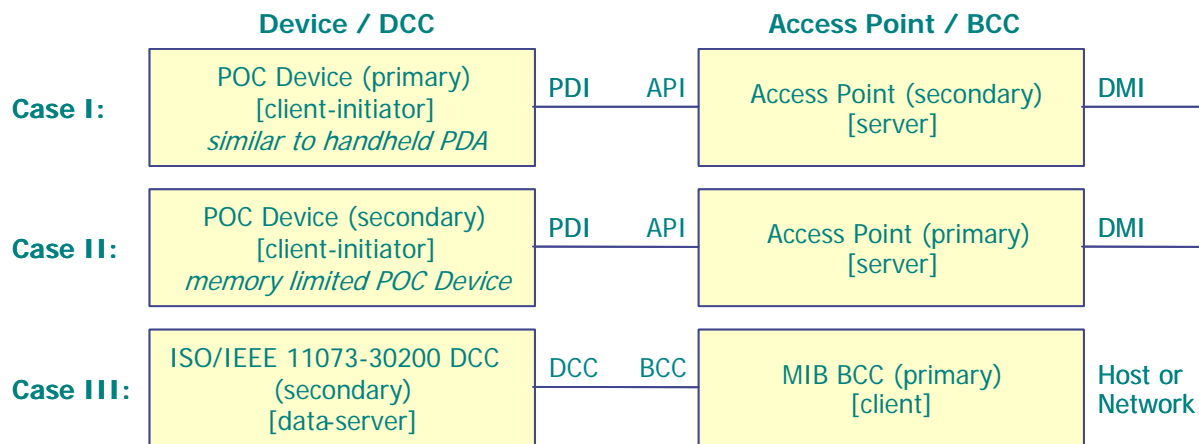

Figure 15. Device and Access Point Client Server Model

<sup>o</sup> The general intent here is that a POC Device can participate either as a primary or secondary, but not both. IrDA primary-secondary ‘role exchange’ is not supported by ISO/IEEE 11073-30200 or this standard.

## 6 Requirements for a 'POCT1-compatible' Device (Normative)

This clause defines the physical, transport layer, IrDA IAS entries, and additional requirements for the POC Device Interface (PDI) of a 'POCT1-compatible' POC Device or POC Device and Docking Station.

Unless otherwise stated, the required, recommended, optional, and default options and parameters for ISO/IEEE 11073-30200 shall apply to the *cable-connected* physical layer, and IrDA SIR shall apply to the *infrared* physical layer. An *infrared* port may also support the IrDA MIR signaling rates of 576 and 1152 kBd, FIR signaling rate of 4 MBd, and VFIR signaling rate of 16 MBd.

### 6.1 Device Physical Layer Requirements

A 'POCT1-compatible' POC Device or POC Device and Docking Station shall support *at least one* of the physical layer options listed below:

#### 1. CABLE-CONNECTED PRIMARY DEVICE

Uses the physical layer defined in ISO/IEEE 11073-30200 and participates as an IrDA primary.

#### 2. CABLE-CONNECTED SECONDARY DEVICE

Uses the physical layer defined in ISO/IEEE 11073-30200 and participates as an IrDA secondary. [This configuration is used by an ISO/IEEE 11073-30200 Device Communication Controller (DCC).]

#### 3. INFRARED PRIMARY DEVICE

May use either 'standard' or 'low-power' IrDA SIR and participates as an IrDA primary. [This configuration is typically used by a hand-held PDA that initiates a communication session.]

#### 4. INFRARED SECONDARY DEVICE

May use either 'standard' or 'low-power' IrDA SIR and participates as an IrDA secondary.

An *infrared secondary* Device shall respond to discovery command frames issued by the Access Point only if (1) the Device needs to communicate with a Data Manager, or (2) a sufficient amount of time has elapsed since the previous transmission. The purpose of this requirement is to prevent subsequent 'rediscovery' of the Device immediately after it has sent its data.

A *cable-connected* POC Device or POC Device and Docking Station may use (1) an RJ-45 connector with the Device (DCC) pinout defined by ISO/IEEE 11073-30200, (2) any other connector or pinout appropriate to the clinical use of the Device, or (3) a permanently attached cable. The cable end that connects to the Access Point shall be terminated with an RJ-45 plug using the BCC pinout defined by ISO/IEEE 11073-30200.

A *cable-connected* POC Device or POC Device and Docking Station may not assume that a particular DC-power delivery option is available from an Access Point (BCC) port.

An *infrared* POC Device shall support either the IrDA SIR 'standard' or 'low-power' option; the latter option is capable of supporting link distances up to 20 cm and typically requires LED drive currents of 10 mA (average) and 30 mA (peak).

For *cable-connected* and *infrared*, the default signaling rate of 9600 Bd shall be supported and the optional higher rates of 19200, 38400, 57600, and 115200 Bd may be negotiated, consistent with the ISO/IEEE 11073-30200 and IrDA SIR standards (2400 Bd is excluded by ISO/IEEE 11073-30200 and this standard). An *infrared* port may also support the IrDA MIR signaling rates of 576 and 1152 kBd, FIR signaling rate of 4 MBd, and VFIR signaling rate of 16 MBd.

## 6.2 Device Transport Layer and IAS Requirements

A POC Device or POC Device and Docking Station shall support the IrLAP, IrLMP, IrLMP-IAS, and TinyTP protocols.

The CLSI POC Device IAS shall include the object class 'CLSI:POCT1:DEV.' The 'Global ID' attribute for the Device is the IEEE 64-bit 'global identifier number' (EUI-64) which consists of a three-octet (24-bit) company identifier assigned by the IEEE Registration Authority Committee (RAC) followed by a five-octet (40-bit) extension identifier assigned by the manufacturer. This information can be used for Device tracking and inventory management, independent of the upper-layer application protocols; for Device authentication; and as a Device identifier for future access point options based on IPv6.

The principal difference between this CLSI standard and ISO/IEEE 11073-30200 is that the CLSI POC Device does not provide a Device upper-layer protocol connection endpoint such as the 'IEEE:1073.3.2:MDDL' object class, since it is a 'client' and not a 'data server.' Instead, the CLSI POC Device (as a client) accesses the 'CLSI:POCT1:MGR' object class in the Access Point IAS that specifies the service connection to the IrDA TinyTP service representing the Data Manager (the server). In the case of a networked Access Point, this would result in the establishment of a TCP/IP connection to a POC Data Manager on the network.

The mandatory and recommended IAS objects and attributes for a CLSI POC Device are shown in Table 1.

**Table 1. IAS Objects and Attributes for a POC Device (PDI)**

| OBJECT CLASS             | ATTRIBUTE NAME | VALUE TYPE     | DESCRIPTION  | IAS STATUS* |
|--------------------------|----------------|----------------|--|-------------|
| Device                   | DeviceName †   | user string    | This attribute is described in IrLMP.  | M           |
|                          | IrLMPSupport   | octet sequence | This attribute is described in IrLMP.  | M           |
| CLSI<br>:POCT1<br>:DEV § | GlobalID       | octet sequence | Specifies the global identifier number for the POC Device.                           | M ‡         |
|                          | NodeType       | integer        | 1 (= Device) ¶   | M           |
|                          | PortNumber     | integer        | Ascribes a specific number to each port on the POC Device.                           | M           |
|                          | PollInterval   | integer        | Indicates the Device's preferred polling interval, in ms. May be 0, 50, 100, or 250. | O #         |

**Notes:**

- \* IAS Status: ‘M’ is Mandatory; ‘R’ is Recommended; ‘O’ is Optional.
- † Examples of Device names and nicknames include “POCT Glucose,” “POCT Blood Analyzer,” etc.
- ‡ For Devices or adapters that cannot be individually serialized, a valid three-octet (24-bit) IEEE company identifier shall be provided with the five-octet (40-bit) extension identifier set to zero.
- § Although the CLSI:POCT1:DEV object class duplicates the functionality of the ‘IEEE:1073:3:2’ and ‘IEEE 1073.3.3’ object classes, using a different object class identifier provides one way of allowing a Device to support both the POCT1 and MIB upper-layer protocols. The object class attributes are defined in ISO/IEEE 11073-30200 and ISO/IEEE 11073-30300.
- ¶ An Access Point would have a ‘NodeType’ of 0.
- # If this capability is not supported, the attribute shall be omitted from the IAS.

**Additional Requirements and Recommendations for a Device:**

**Discovery information:** [A] Service hint bit 12 and extension bit 7 shall be asserted, in addition to any other hint bits that are set (it should be noted that not all IrDA Devices that assert hint bit 12 support the CLSI or ISO/IEEE 11073-30200 Standard); [B] The ‘Device nickname’ is a short, recognizable name for the Device and shall start with the acronym “POCT” followed by a space. For example, the nickname and Device name “POCT Glucose” or “POCT Blood Analyzer” could be used.

This standard *requires* that either [A] or [B] be implemented (preferably both, but not all IrDA platforms permit specific hint bits to be set). The programmatic test for whether a particular IAS service exists is by IAS Object Class such as “CLSI:POCT1:DEV.”

**7 Requirements for a ‘POCT1-compatible’ Access Point (Normative)**

This clause defines the physical, transport layer, IrDA IAS entries, and additional requirements for the Access Point Interface (API) of a ‘POCT1-compatible’ Access Point.

Unless otherwise stated, the required, recommended, optional, and default options and parameters for ISO/IEEE 11073-30200 shall apply to the *cable-connected* physical layer, and IrDA SIR shall apply to



the *infrared* physical layer. An *infrared* port may also support the IrDA MIR signaling rates of 576 and 1152 kBd, FIR signaling rate of 4 MBd, and VFIR signaling rate of 16 MBd.

## 7.1 Access Point Physical Layer Requirements

An *infrastructure* of ‘POCT1-compatible’ Access Points shall be capable of supporting *all* the physical layer options listed below. *Individual* Access Points that support only *cable-connected* or *infrared* are permitted, and may support the alternative physical layer as an adapter option. **It should be noted, however, that POC Devices are strictly free to use either the *cable-connected* or *infrared* physical layers, and may participate in a communication session either as an IrDA *primary* or *secondary* Device.**

### 1. CABLE-CONNECTED SECONDARY AP

Uses the physical layer defined in ISO/IEEE 11073-30200 and participates as an IrDA secondary.

### 2. CABLE-CONNECTED PRIMARY AP

Uses the physical layer defined in ISO/IEEE 11073-30200 and participates as an IrDA primary. [This configuration is used by an ISO/IEEE 11073-30200 Bedside Communication Controller (BCC).] A *cable-connected primary* Access Point may use a short *discovery-polling interval* (~ one second) to detect a secondary Device, since the discovery procedure cannot interfere with other IR Devices in the room. [In fact, ISO/IEEE 11073-30200 recognizes this property of the cable-connected topology and recommends that the BCC provide only a single time slot to minimize the time spent during the discovery process, and the same strategy could be used for POC Devices as well.]

### 3. INFRARED-SECONDARY AP

May use either ‘standard’ or ‘low-power’ IrDA SIR and participates as an IrDA secondary. [This configuration is typically used by an IrDA-compatible LAN access point that passively waits for incoming discovery requests from POC and hand-held PDA IrDA primary Devices.]

### 4. INFRARED-PRIMARY AP

May use either ‘standard’ or ‘low-power’ IrDA SIR and participates as an IrDA primary.

An *infrared-primary* Access Point may use a somewhat longer discovery-polling interval (~ two seconds) to minimize unnecessary interaction with other infrared Devices within its vicinity.

An *infrared-primary* Access Point may employ other strategies to preferentially accept connection requests by CLSI POC Devices by examining the IrDA ‘service hint bits’ and ‘Device nickname’ returned by the Device in response to the discovery command frame issued by the Access Point.

An Access Point may provide one or more *cable-connected* ports, a single *infrared* transceiver, or *both* in a given patient care area. An Access Point may support multiple *infrared* transceivers provided they are located in distinct IR ‘spaces.’

A *cable-connected* port on an Access Point shall be compatible with the requirements for a BCC port defined by ISO/IEEE 11073-30200, including the use of an RJ-45 modular jack with the BCC pinout.

A *cable-connected* port on an Access Point may provide any of the three DC power delivery options. [The ‘high-power’ option (+5V at 100 mA) would provide the highest degree of interoperability with other ISO/IEEE 11073-30200 Devices.]

An *infrared* port on an Access Point shall support either the IrDA SIR ‘standard’ or ‘low-power’ option; the ‘standard’ IR-power option is recommended for an Access Point, since it will support somewhat longer link distances (30 cm vs. 20 cm) when used with a ‘low-power’ IrDA Device.

For *cable-connected* and *infrared*, the default signaling rate of 9600 Bd shall be supported and the optional higher rates of 19200, 38400, 57600 and 115200 Bd may be negotiated, consistent with the ISO/IEEE 11073-30200 and IrDA SIR standards (2400 Bd is excluded by ISO/IEEE 11073-30200 and this standard). An *infrared* port may also support the IrDA MIR signaling rates 576 and 1152 kBd, FIR signaling rate of 4 MBd, and VFIR signaling rate of 16 MBd.

It is important to note that the majority of POC Devices will typically operate at SIR speeds, however; and that an Access Point should offer a broad range of SIR signaling rates in addition to any MIR, FIR, or VFIR signaling rates that it provides. The IrDA protocol automatically negotiates the use of these higher speeds at the beginning of a session.

As previously described, a cable-connected Access Point port may use a relatively short discovery-polling interval (~ one second) to detect nearby secondary Devices, since the discovery procedure cannot interfere with other IR Devices in the room. An infrared Access Point port should use a somewhat longer discovery-polling interval (~ two seconds) to minimize unnecessary interaction with other IR Devices in its vicinity. For either physical layer, the discovery-polling interval shall comply with the media access rules described in the IrDA IrLAP specification. Specifically, an Access Point or POC Device in the ‘contention state’ must ensure that there is no activity on the link for a time period greater than 500 ms (560 to 600 ms recommended) before attempting to transmit (usually the XID discovery frame).

## 7.2 Access Point Transport Layer and IAS Requirements

The Access Point shall support the IrLAP, IrLMP, IrLMP-IAS, and TinyTP protocols, and each port shall run a separate instance of the IrDA transport protocol stack.

The Access Point IAS shall include the object class ‘IEEE:1073:3:2’ for a cable-connected port or the object class ‘IEEE:1073:3:3’ for an infrared port which contains the ‘Global ID’ and ‘PortNumber’ attributes that uniquely identify a specific port on an Access Point. This information can be accessed by the Device and incorporated into the information it sends to the POC Data Manager to facilitate Device tracking. If a cable-connected port can support an infrared adapter, it is recommended that the port either (1) detects the adapter, or (2) allows the user to configure the presence of the adapter. This facilitates selection of the optimum IrDA communication parameters during the IrLAP negotiation phase. If a cable-connected port can support an infrared adapter but cannot identify the physical layer being used, then both ‘IEEE:1073:3:2’ and ‘IEEE:1073:3:3’ object classes shall be included in the IAS.

The Access Point IAS shall provide the object class ‘CLSI:POCT1:MGR:GENERIC’ with the attribute name ‘IrDA:TinyTP:LsapSel’ which returns an integer to the Device that specifies the service connection endpoint to an IrDA TinyTP service representing the POC Data Manager. Vendor-specific IAS object classes such as ‘CLSI:POCT1:MGR:VENDORNAME’ are permitted by this standard.

The mandatory and optional IAS objects and attributes for an Access Point are shown in Table 2.

**Table 2. IAS Objects and Attributes in an Access Point**

| OBJECT CLASS  | ATTRIBUTE NAME          | VALUE TYPE     | DESCRIPTION  | IAS STATUS *                               |
|---|-------------------------|----------------|--|--|
| Device  | DeviceName              | user string    | This attribute is described in IrLMP.  | M  |
|   | IrLMPSupport            | octet sequence | This attribute is described in IrLMP.  | M  |
| IEEE:1073:3:2<br>(cable-<br>connected)<br>- or -<br>IEEE:1073:3:3<br>(infrared) | GlobalID                | octet sequence | Specifies the global identifier number for the BCC / Access Point.   | M  |
|   | NodeType                | integer        | 0 (= BCC / Access Point).  | M  |
|   | PortNumber              | integer        | Ascribes a specific number to each port on the BCC / Access Point.   | M  |
| CLSI<br>:POCT1<br>:MGR<br>:GENERIC  | IrDA:TinyTP<br>:LsapSel | integer        | Specifies the service connection endpoint for the CLSI POC Device protocol to an IrDA TinyTP service representing a <i>generic</i> POC Data Manager.         | M  |
| CLSI<br>:POCT1<br>:MGR<br>:VENDOR †   | IrDA:TinyTP<br>:LsapSel | integer        | Specifies the service connection endpoint for the CLSI POC Device protocol to an IrDA TinyTP service representing a <i>vendor-specific</i> POC Data Manager. | O<br><i>multiple entries are permitted</i> |

**Notes:**

\* IAS Status: ‘M’ is Mandatory; ‘R’ is Recommended; ‘O’ is Optional.

† The substring ‘VENDOR’ is a vendor-specific string such as ‘LFS’ (Lifescan), ‘ROCHE,’ ‘I-STAT,’ etc. A complete list of vendor-specific strings is provided in Appendix F. The maximum length for an object class name is 60 octets. Recommendations for VENDOR identification strings are provided in Appendix F of this standard.

**Additional Requirements and Recommendations**

**Discovery information:** [A] Service hint bit 12 and extension bit 7 shall be asserted, in addition to any other hint bits that are set (it should be noted that not all IrDA Devices that assert hint bit 12 support the CLSI or ISO/IEEE 11073-30200 standards). [B] The ‘Device nickname’ is a short, recognizable name for the access point and shall start with the word “MIB” followed by a space. For example, the nickname and Device name “MIB BCC” could be used for a dedicated ISO/IEEE 11073-30200 concentrator.

This standard *requires* that either [A] or [B] be implemented (preferably both, but not all IrDA platforms permit specific hint bits to be set). The programmatic test for whether a particular IAS service exists is by IAS Object Class such as “IEEE:1073:3:2” or “CLSI:POCT1:MGR:GENERIC.”

**8 Networked Access Points (Normative if Implemented)**

Up to this point, the requirements for a ‘POCT1-compatible’ POC Device and Access Point have dealt solely with the PDI and API interfaces, and provide a complete specification of the transport and physical layers relevant to POC Device communication, regardless of how the Access Point is implemented.

In this section, the use of *networked access points* will be discussed. One of the key technical objectives of this effort was to maintain the simplicity of using the IrDA IAS as the mechanism that allows a small medical Device to ‘find-and-bind’ to the appropriate network services it needs. The burden of actually locating these services is placed on the Access Point, which typically has the CPU and memory resources to perform this task.

### 8.1 Transparent TinyTP to TCP/IP Connection

A key requirement for a *networked* Access Point is that it can transparently bridge the TinyTP protocol used by a POC Device to a TCP/IP network connection, as shown below.



**Figure 16. TinyTP to TCP/IP Connection Diagram**

After the POC Device initiates a TinyTP connection to the Access Point, the Access Point establishes a TCP/IP connection to the POC Data Manager on behalf of the POC Device request. TinyTP and TCP/IP provide robust, bidirectional data transfer with flow control mediated by all three subsystems.

### 8.2 Registering Data Managers in the Access Point IAS

The IrDA Information Access Service (IAS) of the Access Point plays a critical role in establishing the connection to the server. The IAS must first be configured by ‘registering’ the IAS Service Object Class and server IP Address and TCP Port Number for each network server and service port. After the services have been registered, POC Devices connected to the Access Point need only perform a simple IAS lookup to ‘find-and-bind’ to the servers and services they need.

**Table 3. Examples of IAS Object Classes, Server IP Addresses, and TCP Port Numbers for an Access Point**

| IAS Service Object Class<br>(visible to POC Device) | Server IP Address and TCP Port Number<br>(internally stored in the Access Point) |
|---|--|
| CLSI:POCT1:MGR:GENERIC                              | ( 128.9.0.32, 1184 )   |
| CLSI:POCT1:MGR:VENDORA                              | ( 128.9.0.32, 1184 )   |
| CLSI:POCT1:MGR:VENDORB                              | ( 128.9.0.34, 1184 )   |
| <i>additional entries ...</i>                       |  |

Vendor-specific suffixes may also be registered to allow a POC Device to select a particular POC Data Manager on the network. This allows a variety of policies to be implemented in a multivendor POC Device and manager network, but these are beyond the scope of this standard. Note that it is possible to register other services, such as LIS server or other medical data servers and services.

It is beyond the scope of this standard to specify the protocol used to ‘register’ the servers and services in the IAS of the Access Point. The ‘Simple Network Management Protocol’ (SNMP) would be appropriate, since it is widely used to configure network equipment such as bridges, routers, and access points. It is highly recommended that an Access Point support the registration of multiple services, perhaps globally for all ports as well as individually for selected ports. Data Managers should not abuse this capability by registering a large number of vendor-specific services.

### 8.3 Control and Data Flow Between a Device, Access Point, and Data Manager

This section describes the control and data flow between a POC Device, a network Access Point, and a Data Manager on the network and shows the relationship between the TinyTP and TCP/IP protocols.

Both cases of a *secondary* POC Device and *primary* Access Point, and of a *primary* POC Device and *secondary* Access Point are described. Both modes of operation can be supported by a single

instantiation of an Access Point that operates both as an IrDA *primary* and *secondary*, as mandated by this standard.

### 8.3.1 Primary POC Device and Secondary Access Point (Case I)

The control and data flow among a POC Device (POCD) as an IrDA *primary*, an Access Point (AP) as an IrDA *secondary*, and a Data Manager (DM) is shown in Table 4 and is summarized below.

As the first step in connecting to an Access Point, the POC Device acts as an IrDA *primary* to discover one or more secondary entities. If more than one secondary entity responds, the POC Device uses the hint bits and Device nicknames obtained during the discovery phase to select the entity that is most likely to be an Access Point.

Although this standard does not mandate any particular Access Point selection algorithm, the following strategy could be used by POC Devices that prefer a selection policy that favors access to POC Data Managers:

1<sup>st</sup> choice: Hint bit 12 set **.and.** “MIB” nickname prefix [required for MIB Access Points].

2<sup>nd</sup> choice: Hint bit 12 set **.or.** “MIB” nickname prefix [required for CLSI Access Points].

3<sup>rd</sup> choice: Hint bit 6 set (LAN Access).

4<sup>th</sup> choice: Hint bit 2 set (Computer).

5<sup>th</sup> choice: Hint bit 1 set (PDA/Palmtop).

[NOTE: An ‘access point’ that has hint bit four (modem) or hint bit ten (IrCOMM serial-line adapter) set could be selected by a POC Device that requires remote modem access.]

After an Access Point is selected, the POC Device connects to the Access Point with an SNRM and UA and interrogates the IAS of the Access Point to connect to the ‘CLSI:POCT1:MGR:GENERIC’ or other POC Data Manager service.

**Table 4. Control and Data Flow Between a Primary POC Device, a Secondary Access Point (AP), and a Data Manager (DM)**

| POC Device (IrDA Primary) |   | Access Point (IrDA Secondary) |   | Data Manager | Protocol    | Comments   |
|---------------------------|---|-------------------------------|---|--------------|-------------|--|
| XID                       | → |                               |   |              | IrDA LAP    | POCD discovery.  |
|                           | ← | XID                           |   |              | IrDA LAP    | AP discovery response with nickname and hint bits.   |
| XID                       | → |                               |   |              | IrDA LAP    | POCD ending discovery with hint bits and nickname.   |
| SNRM                      | → |                               |   |              | IrDA LAP    | Connection parameter negotiation.  |
|                           | ← | UA                            |   |              | IrDA LAP    | Parameter negotiation.   |
| LSAP connect request      | → |                               |   |              | IrDA LM     | LSAP connection request to LSAP 0 (IAS server port).   |
|                           | ← | LSAP connect confirm          |   |              | IrDA LM     | LSAP connect confirm.  |
| I frame                   | → |                               |   |              | IrDA LM     | IAS service query.   |
|                           | ← | I frame                       |   |              | IrDA LM     | IAS service reply with LSAP number.  |
| LSAP connect request      | → |                               |   |              | IrDA LM     | TinyTP Connection request to the LSAP returned.  |
|                           |   | SYNC                          | → |              | TCP         | AP tries to open a TCP connection to DM; this is the first TCP SYNC packet of the three-way handshake. |
|                           |   |                               | ← | SYNC ACK     | TCP         | This is the second packet of the three-way handshake.  |
|                           |   | ACK                           | → |              | TCP         | This is the third packet of the three-way handshake; a TCP connection is up.                           |
|                           | ← | LSAP connect confirm          |   |              | IrDA LM     | TinyTP connection confirm to POCD.   |
| data                      | → |                               |   |              | IrDA TinyTP | Data from POCD.  |
|                           |   | data                          | → |              | TCP         | AP forwards the data to DM.  |
|                           |   |                               | ← | data         | TCP         | DM sends some data back to POCD.   |
|                           | ← | data                          |   |              | IrDA TinyTP | AP forwards the data to POCD.  |
|                           |   | ...                           |   |              |             |  |
|                           |   | ...                           |   |              |             |  |
| DISC                      | → |                               |   |              | IrDA LAP    | POCD sends out 'Disconnect' command to AP.   |
|                           |   | FIN                           | → |              | TCP         | AP starts the three-way handshake to end the TCP connection.   |
|                           |   |                               | ← | FIN ACK      | TCP         | Second packet of the three-way handshake.  |
|                           |   | ACK                           | → |              | TCP         | Third packet of the three-way handshake.   |
|                           | ← | UA                            |   |              | IrDA LAP    | AP ACK. IrDA connection is now torn down.  |

**8.3.2 Secondary POC Device and Primary Access Point (Case II)**

The control and data flow between a POC Device (POCD) as an IrDA *secondary*, an Access Point (AP) as an IrDA *primary*, and a Data Manager (DM) is shown in Table 5 and is summarized below.

The Access Point acts as an IrDA primary, and sends out discovery packets at a predetermined interval.

After one or more secondary Devices have been found, the Access Point checks the hint bits and nickname of the secondary Device(s). If more than one secondary Device responds, the AP selects a Device based on the hint bits and Device nicknames obtained during the discovery phase.

Although this standard does not mandate any particular Device selection algorithm, it is recommended that a 'round-robin' or other fair access policy be used. If an Access Point prefers to implement a

selection policy that favors potential CLSI POCT Devices, it can select the Device that first satisfies the tests shown below:

- 1<sup>st</sup> test: Hint bit 12 set **.and.** “POCT” nickname prefix
- 2<sup>nd</sup> test: Hint bit 12 set **.or.** “POCT” nickname prefix [required for CLSI POC Devices]
- 3<sup>rd</sup> test: Hint bit 1 set (PDA/Palmtop)
- 4<sup>th</sup> test: Hint bit 2 set (Computer)

Otherwise: Use round-robin or other selection policy.

Although an Access Point could reject Devices that do not satisfy the first or second tests by issuing a disconnect command, it is recommended that other Devices such as a ‘PDA/Palmtop’ or ‘Computer’ be considered for further screening, especially if only a single secondary Device was found.

The AP connects to the selected secondary Device with an SNRM and UA and interrogates the Device’s IAS for the mandatory ‘CLSI:POCT1:DEV’ object class and ‘NodeType’ attribute. If present, the AP *waits* for the POC Device to connect to the ‘CLSI:POCT1:MGR’ or other service offered by the AP (note that it is also possible for the POC Device to request the ‘CLSI:POCT1:MGR’ service *before* the AP begins to wait). If the ‘CLSI:POCT1:DEV’ object class is not present, the AP can interrogate the Device’s IAS for other object classes such as ‘IEEE:1073:3:2’ or terminate the LSAP connection.

After receiving the LSAP connection request, the Access Point opens a TCP connection with the Data Manager. If the TCP connection is successfully opened, the Access Point then sends back the LSAP connection confirm message to the POC Device. At this point, the POC Device has an IrDA TinyTP connection, and the Access Point has a TCP connection with the Data Manager.

The differences between the two tables are in the IrDA discovery phase and IrDA connection tear down phase. The POC Device, whether it is an IrDA secondary or primary, is always the initiator. It starts the IAS query, makes the TinyTP connection request, and tears down the IrDA connection.

**Table 5. Control and Data Flow Between a Secondary POC Device (POCD), a Primary Access Point (AP), and a Data Manager (DM)**

| POC Device (IrDA Secondary) |   | Access Point (IrDA Primary) |   | Data Manager | Protocol    | Comments   |
|-----------------------------|---|-----------------------------|---|--------------|-------------|--|
|                             | ← | XID                         |   |              | IrDA LAP    | AP discovery.  |
| XID                         | → |                             |   |              | IrDA LAP    | POCD discovery response with nickname and hint bits.   |
|                             | ← | XID                         |   |              | IrDA LAP    | AP ending discovery with hint bits and nickname.   |
|                             | ← | SNRM                        |   |              | IrDA LAP    | Connection parameter negotiation.  |
| UA                          | → |                             |   |              | IrDA LAP    | Parameter negotiation.   |
| LSAP connect request        | → |                             |   |              | IrDA LM     | LSAP connection request to LSAP 0 (IAS server port).   |
|                             | ← | LSAP connect confirm        |   |              | IrDA LM     | LSAP connect confirm.  |
| I frame                     | → |                             |   |              | IrDA LM     | IAS service query.   |
|                             | ← | I frame                     |   |              | IrDA LM     | IAS service reply with LSAP number.  |
| LSAP connect request        | → |                             |   |              | IrDA LM     | TinyTP Connection request to the LSAP returned.  |
|                             |   | SYNC                        | → |              | TCP         | AP tries to open a TCP connection to DM; this is the first TCP SYNC packet of the three-way handshake. |
|                             |   |                             | ← | SYNC ACK     | TCP         | This is the second packet of the three-way handshake.  |
|                             |   | ACK                         | → |              | TCP         | This is the third packet of the three-way handshake; a TCP connection is up.                           |
|                             | ← | LSAP connect confirm        |   |              | IrDA LM     | TinyTP connection confirm to POCD.   |
| data                        | → |                             |   |              | IrDA TinyTP | Data from POCD.  |
|                             |   | data                        | → |              | TCP         | AP forwards the data to DM.  |
|                             |   |                             | ← | data         | TCP         | DM sends some data back to POCD.   |
|                             | ← | data                        |   |              | IrDA TinyTP | AP forwards the data to POCD.  |
|                             |   | ...                         |   |              |             |  |
|                             |   | ...                         |   |              |             |  |
| RD                          | → |                             |   |              | IrDA LAP    | POCD sends out 'Request Disconnect' command to AP.   |
|                             |   | FIN                         | → |              | TCP         | AP starts the three-way handshake to end the TCP connection.   |
|                             |   |                             | ← | FIN ACK      | TCP         | Second packet of the three-way handshake.  |
|                             |   | ACK                         | → |              | TCP         | Third packet of the three-way handshake.   |
|                             | ← | DISC                        |   |              | IrDA LAP    | AP sends 'Disconnect' command to POCD.   |
| UA                          | → |                             |   |              | IrDA LAP    | POCD ACK. IrDA connection is now torn down.  |

Abbreviations used in Tables 4 and 5:

POCD: POC Device  
 AP: Access Point  
 DM: Data Manager  
 LAP: IrDA Link Access Protocol  
 XID: Exchange Station Identification, IrDA control frame

SNRM: Set Normal Response Mode, IrDA control frame  
 UA: Un-numbered Acknowledgement, IrDA control frame  
 IAS: Information Access Service, IrDA protocol  
 LSAP: Link Service Access Point, IrDA protocol



### 8.3.3 TCP/IP Buffering and ‘Push’ Mechanism

To make transfers more efficient and to minimize network traffic, TCP/IP buffers data so that it can be sent in larger datagrams. For applications that require data to be delivered before a buffer is filled, TCP/IP provides a *push* mechanism to force the data to be sent over the network and cause it to be immediately forwarded to the receiving application (by setting the *PSH* bit in the TCP header). It should be noted, however, that the TCP/IP *push* mechanism only guarantees that all the data will be transferred and cannot be used to create or preserve record boundaries.

For example, there are several points within the POCT1 ‘Device Messaging Layer’ protocol where the Data Manager sends a command and waits for an acknowledgement from the POC Device before it proceeds to the next phase of the transfer. These points should be explicitly identified in any upper-layer messaging protocol.

Since the IrDA TinyTP protocol does not provide an equivalent *push* mechanism, the Access Point shall *push* every TinyTP frame that it receives from the POC Device.

## 9 Remote Modem Access (Informative)

This section explores two examples of remote access that utilize the IrDA-based infrastructure and protocols described earlier in this document.

### 9.1 Raw Serial Over WAN

One method for providing remote modem access is to use an ‘IR-modem’ and conventional modem. The POC Device uses the IrDA ‘IrCOMM’ protocol, and the ‘IR-modem’ sends the data as a raw serial character stream to the second modem and conventional serial-line concentrator that ultimately forwards the data to the appropriate network server.



**Figure 17. IrCOMM to RS-232 Connection Diagram**

Since the POC Device does not have access to the IAS of an ‘IrDA-smart’ Access Point, ‘finding-and-binding’ is accomplished by having the Device or IR-modem dial the appropriate number and by preconfiguring the appropriate IP address and TCP port number for the POC Data Manager into the serial-line concentrator.

The principal advantage of this method is that it can utilize the existing infrastructure of conventional terminal servers and that it is relatively easy to install in the patient’s home. Adding IrCOMM to an otherwise ‘POCT1-compatible’ Device that already supports TinyTP is not difficult, since IrCOMM runs above TinyTP. Also, the POC Device can determine whether IrCOMM support is available simply by interrogating the IAS of the IR-modem.

### 9.2 Home PC as an Access Point

A growing number of remote patient-care areas (such as the home) will have personal computers with network access. Eventually it will become more economical and convenient to integrate an IrDA transceiver and software into an existing personal computer (either as a ‘network access point’ or as part of a program that the patient uses for POC data logging and self-management of diet and medication) than it would be to implement the IR-modem solution described in the previous section.

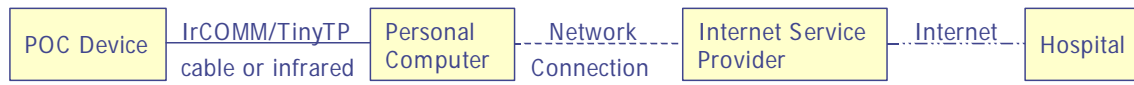

**Figure 18. IrCOMM to Internet Connection Diagram**

As shown above, the POC Device can use a cable or infrared connection (using an IR adapter) to a personal computer. The PC can send the data via an existing connection to an Internet service provider to the hospital or other clinical site.

## 10 POC Devices With Direct Network Connections (Informative)

Previous sections specified how a network access point acts as a relay between the TinyTP connection to a Device and a TCP/IP connection to a Data Manager on the network. This section essentially defines the requirements for a POC Device that has a built-in DMI interface: a TCP/IP connection to a Data Manager supporting the POC Device upper-layer protocol, as shown in Figure 12, Box 6a (see Section 4).

A POC Device with a built-in DMI interface, however, must obtain several additional communication parameters before it can communicate on a TCP/IP network:

- its own IP address,
- the IP address of a router to use,
- the subnet mask, and
- the IP address of a name server (which may be necessary to find a Data Manager).

For networks that support it, the Dynamic Host Configuration Protocol (DHCP) provides an excellent solution for mobile-networked POC Devices that need to attach and detach quickly. DHCP allows a server to allocate IP addresses automatically and dynamically, and allows a Device to ‘lease’ an IP address for as long or as little time as it needs.

In addition to providing an IP address, a DHCP message also contains a subnet mask, default router, and name server information. The name server can be used by the POC Device to obtain the IP address for a POC Data Manager or to locate a network directory server that would provide the same information. Alternatively, the IP address and TCP port number of the Data Manager can be manually configured into the Device.

For networks that use static IP addressing and do not support DHCP, the Device IP address, default router IP address, and subnet mask will need to be manually configured into the POC Device. The IP address and TCP port number of the Data Manager (or, alternatively, the IP address of a name server) will also need to be configured. Note that most of this information would have to be reconfigured if the Device was moved to another network segment.

The table below summarizes these options. It also recommends that 10/100BASE-T Ethernet physical interface be used, due to its widespread deployment. The RJ-45 connector and pinout used by ISO/IEEE 11073-30200 is compatible with 10/100BASE-T Ethernet, but providing that functionality is optional.

| Recommendations for POC Devices With Direct Network Connections                         |   |
|---|---|
| <b>Physical Interface</b>   | <b>10BASE-T or 10/100BASE-T Ethernet</b>  |
| <b>Device IP Address</b><br>also:<br>- default router<br>- subnet mask<br>- name server | <p><b>Dynamic Host Configuration Protocol (DHCP)</b></p> <p>This is the preferred solution for POC Devices with direct network connections. Using DHCP, the Device can 'lease' an IP address for an appropriate period of time. DHCP also provides default router, subnet mask, and other information. DHCP is described in RFC 2131 and other RFCs.</p> <p><b>Manually configured</b></p> <p>In networks that do not support DHCP, the Device IP address, default router, subnet mask, and other information would be manually entered into the Device. Note that most of this information would have to be reconfigured if the Device was moved to another network segment.</p> |
| <b>Data Manager IP Address and TCP Port Number</b>                                      | <p><b>Manually configured domain name and TCP port number</b>, if the Device has access to a domain name server.</p> <p><b>Manually configured IP address and TCP port number.</b></p>  |

At the present time there is no single, universally accepted network directory service that a networked POC Device can rely on to 'find and bind' to the appropriate Data Manager, equivalent to the lightweight directory service provided by the IrDA Information Access Service (IAS). Although several 'service discovery' methods have been developed based on proprietary and open standards, none have emerged as the clear technical or market leader, and it would be inappropriate for the Connectivity Industry Consortium to select one at the present time. Hopefully, the need for such a service by portable wireless Devices will drive the industry to a widely deployed standard that networked POC Devices can use in the future.

## 11 Data Security (Informative)

The CIC Device team considered several approaches to data security; however, three issues made it difficult to develop a complete specification for point-of-care connectivity security at this time.

First, the HIPAA<sup>p</sup> regulations, which mandate levels and responsibilities for data security, were under active development during the Consortium's lifetime. These proposed rules had still not been ratified at the Consortium's sunset, making it impossible for the Consortium to use them for more than very general guidance. HIPAA currently does not require encryption for Devices used on 'closed' networks within the hospital environment, which includes the majority of POC Devices and Access Points. Encryption of data between an Access Point and Data Manager would be required, however, if it was sent over an 'open' network such as the Internet.

Second, existing POC Devices often have limited memory and CPU resources, and mandating encryption was simply out of the question (adding 5 Kbytes of firmware to incorporate the IrDA protocol stack was a major issue for many vendors). This view is consistent with the Consortium's primary goal of providing *universal connectivity* for the broadest range of POC Devices (and cost). Furthermore, the majority of POC Devices considered by the Consortium are used on 'closed' networks within the hospital environment, where encryption is not required.

Third, a system is only as secure as its weakest link; thus, data security is a systems and solutions issue, not a particular technology issue.<sup>q</sup> To ensure security, one has to provide end-to-end protection for the entire data management system. As the POCT1 interfaces may be employed in a wide range of settings over a diverse set of infrastructures, no single security approach could fit the requirements of all solutions that incorporate these interfaces.

<sup>p</sup> HIPAA = "Healthcare Insurance Portability and Accountability Act." See [aspe.os.dhhs.gov/admsimp](http://aspe.os.dhhs.gov/admsimp) for detailed information.

<sup>q</sup> Even the security of particular technologies must be questioned, as illustrated by recently detected flaws in the security layers of the Wireless Access Protocol (WAP), Bluetooth<sup>TM</sup>, and the Wireless Equivalent Privacy (WEP) scheme of the IEEE 802.11b radio-frequency network standard.

Therefore, the POCT1 lower-layers specification supports, but does not mandate, several security and encryption approaches that can be used to safeguard data transmission. Vendors are free to select the most appropriate approach(es) from among the following, based on user, system engineering, regulatory, and other deployment requirements.

Features of the *cable-connected* (ISO/IEEE 11073-30200) and *IrDA infrared* physical layers and IrDA *TinyTP* transport layer that contribute to secure communication include:

1. *Secure Device to Access Point connection:*  
The link between a Device and an Access point is a short-range, point-to-point infrared or cabled connection. This approach physically secures this stage of the communication.<sup>†</sup>
2. *Access Point limits access:*  
The Access Point exposes only the specific services required for POC data management, not general access to the hospital network. Thus, a hostile individual could not use an Access Point to gain wide access to the 'back-end' network.
3. *Device Authentication:*  
An important aspect of secure communication is ensuring the identity of the participants. This standard as well as the Device Messaging Layer prescribes the use of an IEEE EUI-64 identifier, which can be used to globally and uniquely identify each Device.

The POCT1 lower-layers specification provides a foundation that can support encryption in the future:

4. *Advertise availability of encrypted services:*  
The availability of encrypted services by a POC Data Manager can be advertised in the Information Access Service (IAS) directory of the Access Point.
5. *Transparent binary communication:*  
The POCT1 lower-layers specification mandates the use of TCP/IP and TinyTP, both of which can support encryption formats that require transparent binary communication.

## 12 RF Wireless Networking Technologies (Informative)

This section reviews considerations relating to the use of RF (radio frequency) wireless network technologies for the device interface (PDI).

### 12.1 Background

This standard indicates in numerous places that RF wireless networking may be used as an alternative to point-to-point IrDA-based connections<sup>‡</sup>; however, there are additional issues that should be considered when utilizing RF technology, many of which derive from the fundamental difference of sharing a networked architecture vs. the much simpler point-to-point connections. These include security / privacy, coexistence of competing technologies, and performance management to ensure safe and reliable system performance. Many of these issues are not evident when developing and testing a single device in a single manufacturer system. Problems do become evident, though, when potentially hundreds of devices from multiple manufactures, possibly using multiple technologies (e.g., 802.15.1 and 802.11b) sharing the same RF spectrum, are all competing for bandwidth over a *shared IT infrastructure*.

<sup>†</sup> While there are techniques for 'eavesdropping' on infrared communications, these approaches require close proximity and a line-of-site view of the exchange. In practice, this is seldom reasonable. Thus, point-to-point infrared is regarded as a reasonably secure physical transport.

<sup>‡</sup> IEEE 1073.3.2-2000 and 1073.3.3-2004.

The IEEE 1073 general committee is actively working to develop a technical report providing analysis and guidelines for how RF wireless technologies should be used for medical device communications in order to ensure safe and effective system operation.<sup>1</sup> This group is looking at healthcare use cases that support a number of different networking architectures (e.g., patient area networking (PAN), local area networking (LAN), and wide area networking (WAN)), the patient acuity (from ICU to chronic home care), and mobility (stationary equipment vs. mobile devices where the connection needs to be maintained from locale to locale).

The guidelines from this project will be directly applicable to the POC devices addressed by this standard and should be considered in any implementations. Follow-on standardization projects may result from this effort to profile off-the-shelf RF wireless transports for use in medical equipment (e.g., an IEEE 1073.3.x standard for the use of 802.11 networking). It is anticipated that these standards would be similarly applicable to POCD interfaces as are the current IEEE 1073 transports.

Interoperability is directly affected by the number of transport technologies that may be used. As a result, transitioning from either the cable-connected or IR wireless transports to an RF transport should be weighed carefully. This is especially true when using technologies whose application are not differentiated by detailed use cases, such as using competing RF wireless networks. One application that would necessitate usage of RF wireless communication is the desire to support bidirectional on-demand connection establishment between a data manager and networked POCDs. In this case, RF wireless could support an always available transport service allowing the data manager to initiate a connection at any time and provide for “seamless downloading” without the operator having to initiate data transfer at the device.

## 12.2 Extending the DAP

By establishing the DAP and DML as separate component standards, new transport technologies may be added without necessitating changes to the upper-layers DML protocol. As stated in Appendix B, Section 2, DML – Bidirectional Communication, any transport technology must provide for robust and reliable connection-oriented communication. This relieves the DML of any responsibility for adding CRCs, message sequencing, and error detection, all of which are provided by the DAP layer. Additional transport requirements include:

- reliable connection-oriented (to support conversations between device & manager);
- connection initiated by device;
- device & service discovery mechanism (analogous to the IrDA IAS service); and
- bidirectional communication.

## 12.3 RF Network Challenges

There are numerous challenges that need to be addressed when using RF wireless technology, including the following:

- **Network Architecture and Technology** – Does the device need to utilize a wireless personal area network (wPAN), a local area network (wLAN), or a wide area network (WAN) connection? Also, will the devices be mobile or stationary and over what range? Is a nearby access point sufficient or does the device need to function more independently (e.g., using mobile phone technology)? In each of these cases, different technologies may be employed, including 802.11(a, b, or g), 802.15.1 (Bluetooth<sup>TM</sup>), 802.14.4 (ZigBee<sup>TM</sup>), cell phone, pagers, etc.

<sup>1</sup> ISO 11073-00101 / IEEE P1073.0.1.1, *Health informatics – Point-of-care medical device communication – Technical report – Guidelines for the use of RF wireless technology*.

- **EMI/EMC** – Requirements for electromagnetic compatibility testing and certification increase when using RF wireless in health care environments.
- **Quality of Service Management** – In order to ensure the safe and effective/reliable operation of communicating systems, support of a QoS management service may be necessary. For example, this type of system would ensure that high priority device alarm information is communicated to a central handler regardless of other traffic on the same network (e.g., transfer of an x-ray image transfer to the bedside, or real-time waveform display on PDAs). Even if the POC device doesn't have any high priority data to communicate, it needs to operate as a "good neighbor" in the shared RF networking environment, including configurable priority selection. In some technologies, such as 802.11, this may necessitate the usage of 802.11e-compliant interfaces.
- **Coexistence and Interface Conformance Disclosure** – Not all RF technologies work well when they have to coexist in the same space. For example, 802.11b and 802.15.1 use the same 2.4-GHz spectrum, and depending on the configuration of these interfaces, they may or may not perform well when transmitting simultaneously (including intermittent vs. persistent connections). This requires not only real-world interoperability testing, often on a per-installation basis, but also clear disclosure of the implementation profile employed for the selected technology.
- **Service Discovery Mechanism** – IrDA-based transports utilize the IAS service to determine the kinds of devices connected, the ports to be used, and the available managers for establishing a connection. There is generally no such standard for RF (and other LAN-based) networks. One such alternative under consideration is LDAP, which could not only support a network services directory, but also user and device authentication services.
- **Security** – When a network technology is used, security becomes a greater issue that must be addressed at the device interface as opposed to the access point. Depending on the technology used, security layers may already be defined (such as 802.11i), or another service may need to be adopted and agreed upon. In order to achieve secure plug-and-play interoperability, a standardized technology must be employed.<sup>u</sup> In any case, security is a system issue and must not be viewed as an issue for a single connection. Increased microprocessor bandwidth requirements needed to support a security layer may be minimized by only encrypting information identifying a specific patient, and then deidentifying the bulk of the data transferred.<sup>v</sup>
- **Interface Cost** – In general, RF networking technology still costs significantly more than the IrDA-based transports. Depending on the type of RF wireless interface used, this cost differential may also change significantly (for example, 802.11 interfaces typically cost considerably more than 802.15 interfaces).
- **Power Consumption** – RF radios may require more power than other transports, especially if the range is longer than a few feet (i.e., beyond a personal area network). As a result, either battery capacity must be increased or radio modulation techniques employed to minimize the affect this requirement has on the overall device power subsystem. Power consumption can become a major issue if mobile POC devices use RF connectivity as a means of enabling data managers to be able to initiate connections at any time (e.g., using an enterprise LAN technology such as 802.11), requiring the RF wireless transmitter to always be active and processing incoming communications traffic.
- **Technology Configurability** – One approach to minimizing the risk of technology obsolesce or customer requirement changes is to provide for a reconfigurable communications subsystem (e.g., a

<sup>u</sup> Again, this is a subject of the ISO/IEEE 11073-00101 working group.

<sup>v</sup> The W3C 'XML Encryption Syntax and Processing' recommendation could be used for this purpose.

PC card or compact flash); however, though this ensures that new technologies may be used as needed, it also significantly increases the overall cost of the interface.

These issues and others are being directly addressed by the IEEE (and ISO) 1073.0.1.1 RF guidelines working group.

## 13 References

### 13.1 ISO/IEEE 11073-30300 Transport and Physical Layer (Normative)

**ISO/IEEE 11073-30200.** *Health Informatics – Standard for point-of-care medical device communications – Transport file – Cable connected.* Piscataway, NJ: Institute of Electrical and Electronics Engineers, Inc.; Geneva, Switzerland: International Organization for Standardization; 2004.

**IEEE EUI-64 format** – Include in ISO/IEEE 11073-30200

The complete standard is available for a modest fee at: <http://standards.ieee.org/catalog/olis/meddev.html>.

### 13.2 ISO/IEEE 11073-30300 Transport and Physical Layer

**ISO/IEEE 11073-30300.** *Health Informatics - Standard for point-of-care medical device communication – Part 30300: Transport profile – Infrared wireless.* Piscataway, NJ: Institute of Electrical and Electronics Engineers, Inc.; 2001.<sup>w</sup>

### 13.3 IrDA Standards (Normative)

|  |      |         |
|--|------|---------|
| Serial Infrared Physical Layer Link Specification (IrPhys) | v1.2 | 10nov97 |
| Serial Infrared Link Access Protocol (IrLAP)               | v1.1 | 16jun96 |
| Serial Infrared Link Management Protocol (IrLMP)           | v1.1 | 23jan96 |
| ‘Tiny TP’: A Flow-Control Mechanism for Use With IrLMP     | v1.1 | 20oct96 |

The IrDA standards are available at no charge from the Infrared Data Association at: <http://www.irda.org>.

### 13.4 IrDA References (Normative if Implemented)

IrDA Serial Infrared Link Access Protocol Specification for 16 Mb/s Addition, Version 0.20, 5 January 1999. (*Adopted with status ‘final’ by the IrDA Board of Directors, San Francisco, CA, on 28 January 1999*). [IrLAP-VFIR].

IrDA Serial Infrared Physical Layer Specification for 16 Mb/s Addition (VFIR), 8 January 1999. (*Adopted with status ‘final’ by the IrDA Board of Directors, San Francisco, CA, on 28 January 1999*).

These documents are available at no charge from the Infrared Data Association at <http://www.irda.org>.

<sup>w</sup> The ISO/IEEE 11073-30300 standard defines a subset of the IrDa – Infrared connectivity options that are specified in CLSI POCT1, Appendix A. The specifications that are common to both standards are technically equivalent but are specified in greater detail in the ISO/IEEE 11073-30300 standard.

### 13.5 World Wide Web Consortium Standards (W3C) (Normative)

The W3C standards are available at <http://www.w3.org>.

The XML working group latest standards are available at <http://www.w3.org/2000/xml/group/>.

### 13.6 HL7 Standards (Normative)

HL7 v3 XML Implementation Technology Specification (ITS) for Version 3 Data Types

HL7 v2.4.1 – This document includes HL7 ER syntax.

The HL7 Standards are available at <http://www.hl7.org> for a modest fee.

---

END OF THE DEVICE AND ACCESS POINT SPECIFICATION



## APPENDIX B. DEVICE MESSAGING LAYER (DML) SPECIFICATION

### Device Interface Upper-Layer Messaging Protocol

Jeff Perry, Bryan Allen, Paul Schluter

CIC Device Team Upper-Layer Working Group

Bob Uleski and Alan Greenburg, Device Team Co-Chairs, and  
Nils Graversen, Allan Soerensen, Imre Trefil, and Mark Maund

---

A standard for global application developed through the CLSI consensus process.



(Formerly NCCLS)





**Contents**

|        |  |    |
|--------|--|----|
| 1      | Scope and Introduction .....                                 | 63 |
| 1.1    | Editorial Conventions .....                                  | 63 |
| 1.2    | Definitions .....  | 64 |
| 1.3    | Related Information .....                                    | 66 |
| 2      | Bidirectional Communication .....                            | 66 |
| 2.1    | Communication Content .....                                  | 67 |
| 2.2    | Principles .....   | 68 |
| 2.3    | The Dialog .....   | 69 |
| 2.4    | Messaging Scheme .....                                       | 69 |
| 2.4.1  | Messaging Components .....                                   | 69 |
| 2.4.2  | Message Encoding .....                                       | 70 |
| 3      | General Messaging Issues .....                               | 71 |
| 3.1    | Lower-Level Buffering .....                                  | 71 |
| 3.2    | Data Integrity .....   | 71 |
| 3.3    | Bandwidth Considerations .....                               | 73 |
| 3.4    | Error Handling .....   | 73 |
| 3.4.1  | Application Errors .....                                     | 73 |
| 3.4.2  | Protocol Errors .....  | 74 |
| 3.5    | Keep Alive Messages .....                                    | 74 |
| 3.6    | Application Timeouts .....                                   | 75 |
| 3.7    | Minimum Message Set for POCT1 Compliance .....               | 75 |
| 4      | Messaging Profile .....                                      | 76 |
| 4.1    | Basic Profile .....  | 76 |
| 4.1.1  | Ideal Message Flow .....                                     | 76 |
| 4.1.2  | Conversation Startup .....                                   | 78 |
| 4.1.3  | Flexible Conversation Topics .....                           | 78 |
| 4.1.4  | Using Multiple Messages for Large Data Transfers .....       | 78 |
| 4.1.5  | Observations .....   | 79 |
| 4.1.6  | Device Events .....  | 79 |
| 4.1.7  | Operator and Patient Lists .....                             | 80 |
| 4.1.8  | Directives .....   | 81 |
| 4.1.9  | Keep Alive Messages .....                                    | 81 |
| 4.1.10 | Vendor-specific Messages .....                               | 81 |
| 4.1.11 | Conversation Termination .....                               | 82 |
| 4.1.12 | Error Handling .....   | 84 |
| 4.2    | Continuous Mode .....  | 86 |
| 4.2.1  | Continuous Mode Message Flow .....                           | 87 |
| 4.2.2  | Continuous Mode Startup .....                                | 88 |
| 4.2.3  | Observations .....   | 88 |
| 4.2.4  | Device Events .....  | 88 |
| 4.2.5  | Update Lists .....   | 88 |
| 4.2.6  | Keep Alive Messages .....                                    | 89 |
| 4.2.7  | Directive Messages .....                                     | 89 |
| 4.2.8  | Vendor-specific Messages .....                               | 89 |
| 4.2.9  | Conversation Termination .....                               | 89 |
| 4.3    | Asynchronous Observation Acknowledgements .....              | 89 |
| 4.4    | Minimum Device Messaging Layer Compliance Requirements ..... | 90 |

**Contents (Continued)**

|      |   |     |
|------|---|-----|
| 5    | Information Model .....                                     | 91  |
| 5.1  | Access Control Object .....                                 | 92  |
| 5.2  | Access Point Object .....                                   | 92  |
| 5.3  | Acknowledgement Object .....                                | 93  |
| 5.4  | Control/Calibration Object .....                            | 93  |
| 5.5  | Device Object .....   | 94  |
| 5.6  | Device Capabilities Object .....                            | 95  |
| 5.7  | Device Static Capabilities Object .....                     | 95  |
| 5.8  | Device Event Object .....                                   | 96  |
| 5.9  | Device Status Object .....                                  | 97  |
| 5.10 | Directive Object .....                                      | 98  |
| 5.11 | End of Topic Object .....                                   | 98  |
| 5.12 | Escape Object .....   | 98  |
| 5.13 | Header Object .....   | 99  |
| 5.14 | Note Object .....   | 99  |
| 5.15 | Observation Object .....                                    | 100 |
|      | 5.15.1 Limit Encoding Rules .....                           | 102 |
| 5.16 | Operator Object .....                                       | 102 |
| 5.17 | Order Object .....  | 103 |
| 5.18 | Patient Object .....  | 103 |
| 5.19 | Reagent Object .....  | 104 |
| 5.20 | Request Object .....  | 104 |
| 5.21 | Service Object .....  | 104 |
| 5.22 | Specimen Object .....                                       | 105 |
| 5.23 | Termination Object .....                                    | 109 |
| 5.24 | Update Action Object .....                                  | 110 |
| 6    | Messaging Model .....                                       | 110 |
| 6.1  | Notation .....  | 110 |
| 6.2  | Acknowledgement Message (ACK.R01) .....                     | 111 |
| 6.3  | Device Events Message (EVS.R01) .....                       | 112 |
| 6.4  | Device Status Message (DST.R01) .....                       | 113 |
| 6.5  | Directive Message (DTV.R01, DTV.R02, DTV.VENDOR) .....      | 113 |
|      | 6.5.1 Basic Directives (DTV.R01) .....                      | 114 |
|      | 6.5.2 Complex Directives .....                              | 115 |
|      | 6.5.3 Vendor-specific Directive Messages (DTV.VENDOR) ..... | 117 |
| 6.6  | End of Topic Message (EOT.R01) .....                        | 117 |
| 6.7  | Escape Message (ESC.R01) .....                              | 118 |
| 6.8  | Hello Message (HEL.R01) .....                               | 118 |
| 6.9  | Keep Alive Message (KPA.R01) .....                          | 119 |
| 6.10 | Observations Message (OBS.R01, OBS.R02) .....               | 120 |
| 6.11 | Operator List Message (OPL.R01, OPL.R02) .....              | 123 |
| 6.12 | Patient List Message (PTL.R01, PTL.R02) .....               | 124 |
| 6.13 | Request Messages (REQ.R01) .....                            | 125 |
| 6.14 | Terminate Message (END.R01) .....                           | 126 |
| 7    | Extending the Device Messaging Layer .....                  | 126 |
| 7.1  | Custom Directive Messages .....                             | 126 |
|      | 7.1.1 Interoperability With the Basic Profile .....         | 127 |

**Contents (Continued)**

|        |  |     |
|--------|--|-----|
| 7.2    | Custom Message Topics, Types, and Models.....                        | 127 |
| 7.2.1  | Interoperability With the Basic Profile.....                         | 128 |
| 8      | Annex A. Device Messaging Layer Data Types (Normative) .....         | 128 |
| 8.1    | Encapsulated Data (ED).....  | 130 |
| 8.2    | Character String (ST).....   | 131 |
| 8.3    | Coded Simple Value (CS).....   | 131 |
| 8.4    | Coded Value (CV) .....   | 131 |
| 8.5    | Coded With Equivalents (CE) .....                                    | 132 |
| 8.6    | Person Name (PN) .....   | 133 |
| 8.7    | Organization Name (ON).....  | 133 |
| 8.8    | Integer Number (INT).....  | 134 |
| 8.9    | Real Number (REAL).....  | 135 |
| 8.10   | Physical Quantity (PQ) .....   | 135 |
| 8.11   | Point in Time (TS).....  | 135 |
| 8.12   | Physical Quantity Interval (IVL<PQ>).....                            | 136 |
| 8.12.1 | Interval Form .....  | 137 |
| 8.13   | Set (SET<V>).....  | 137 |
| 9      | Annex B. Asynchronous Observation Acknowledgements (Normative) ..... | 138 |
| 9.1    | Synchronous and Asynchronous Acknowledgements .....                  | 138 |
| 9.1.1  | Design Considerations for a Device .....                             | 138 |
| 9.1.2  | Design Considerations for the Observation Reviewer.....              | 139 |
| 10     | Annex C. ‘SET_TIME’ Time Stamp and Time Zone Information.....        | 139 |
| 11     | Annex D. Example Messages (Informative).....                         | 144 |
| 11.1   | POCT1 XML Message Examples.....                                      | 145 |
| 11.1.1 | Simple Glucose Result Exchange .....                                 | 145 |
| 11.2   | Example Blood Gas Observation.....                                   | 150 |
| 11.3   | Example Nonpatient-related Observation Message .....                 | 154 |
| 11.4   | Device Events Topic.....   | 156 |
| 11.5   | Operator List Topic.....   | 158 |
| 11.6   | Patient List Topic.....  | 161 |
| 11.7   | Directives Topic.....  | 163 |
| 11.7.1 | Basic Directive Example .....  | 163 |
| 11.7.2 | Set Time Directive Example.....                                      | 164 |
| 11.7.3 | Vendor-specific Directive Examples .....                             | 165 |
| 11.8   | Vendor-specific Topic Example .....                                  | 167 |
| 12     | Annex E. POCT1 Messaging DTDs (Normative) .....                      | 171 |
| 12.1   | Individual Message DTDs .....  | 171 |
| 12.2   | Message Element DTDs .....   | 172 |
| 12.3   | POCT1 Data Types DTD.....  | 178 |

**Contents (Continued)****Figures**

|   |     |
|---|-----|
| Figure 19. Device Messaging Layer Scope .....                           | 63  |
| Figure 20. Device Interface Stack .....                                 | 63  |
| Figure 21. POCT1 Device Messaging Layer .....                           | 66  |
| Figure 22. Device Messaging Layer and Access Point Specifications ..... | 67  |
| Figure 23. Messaging Scheme: Conversation, Topics, and Messages .....   | 70  |
| Figure 24. Acknowledgement Message Flow .....                           | 71  |
| Figure 25. Error-Free Basic Profile Flow .....                          | 77  |
| Figure 26. Large Data Set Transfers Using Multiple Messages .....       | 79  |
| Figure 27. Update List Topic Message Flow .....                         | 80  |
| Figure 28. Device-initiated Termination Flow .....                      | 83  |
| Figure 29. Example Flow With Error Handling .....                       | 84  |
| Figure 30. Ideal Continuous Mode Message Flow .....                     | 87  |
| Figure 31. Device Interface Messaging Layer Information Model .....     | 91  |
| Figure 32. Message Model Example .....                                  | 111 |
| Figure 33. Acknowledgement Message Model .....                          | 112 |
| Figure 34. Device Events Message Model .....                            | 112 |
| Figure 35. Device Status Message Model .....                            | 113 |
| Figure 36. Basic Directive Message Model .....                          | 114 |
| Figure 37. Complex Directive Message Model .....                        | 115 |
| Figure 38. Set Time Directive Message Model .....                       | 116 |
| Figure 39. Vendor-specific Directive Message Model .....                | 117 |
| Figure 40. End of Topic Message Model .....                             | 118 |
| Figure 41. Escape Message Model .....                                   | 118 |
| Figure 42. Hello Message Model .....                                    | 119 |
| Figure 43. Keep Alive Message Model .....                               | 119 |
| Figure 44. Patient-related Observation Message Model .....              | 121 |
| Figure 45. Nonpatient-related Observation Message Model .....           | 122 |
| Figure 46. Operator List Complete Update Message Model .....            | 123 |
| Figure 47. Operator List Incremental Update Message Model .....         | 124 |
| Figure 48. Patient List Complete Update Message Model .....             | 124 |
| Figure 49. Patient List Incremental Update Message Model .....          | 125 |
| Figure 50. Request Messages Model .....                                 | 125 |
| Figure 51. Terminate Message Model .....                                | 126 |
| Figure 52. Vendor-specific Message Model .....                          | 127 |
| Figure 53. Synchronous vs. Asynchronous Acknowledgements .....          | 138 |
| Figure 54. Simple Glucose Example Message Flow .....                    | 146 |
| Figure 55. General Update List Message Flow .....                       | 158 |
| Figure 56. Message DTD Definition Hierarchy .....                       | 171 |

**Contents (Continued)****Tables**

|  |     |
|--|-----|
| Table 6. Idealized Device - Observation Reviewer Dialog .....  | 69  |
| Table 7. Messages for Minimal Compliance.....                  | 90  |
| Table 8. Access Control Object Attributes .....                | 92  |
| Table 9. Access Control Method Code Values .....               | 92  |
| Table 10. Access Control Permission Level Values .....         | 92  |
| Table 11. Access Point Object Attributes .....                 | 92  |
| Table 12. Acknowledgement Object Attributes .....              | 93  |
| Table 13. Acknowledgement Type Code Values .....               | 93  |
| Table 14. Error Acknowledgement Detail Code Values.....        | 93  |
| Table 15. Control/Calibration Object Attributes .....          | 94  |
| Table 16. Control/Calibration Field Descriptions by Role ..... | 94  |
| Table 17. Device Object Attributes .....                       | 95  |
| Table 18. Device Capabilities Object Attributes .....          | 95  |
| Table 19. Device Static Capabilities Object Attributes .....   | 96  |
| Table 20. Connection Profile Values .....                      | 96  |
| Table 21. Topics Supported Values.....                         | 96  |
| Table 22. Device Event Object Attributes .....                 | 96  |
| Table 23. Severity Level Field Values .....                    | 97  |
| Table 24. Device Status Object Attributes .....                | 97  |
| Table 25. Device Condition Field Values .....                  | 97  |
| Table 26. Directive Object Attributes .....                    | 98  |
| Table 27. End of Topic Object Attributes .....                 | 98  |
| Table 28. End of Topic Code Values.....                        | 98  |
| Table 29. Escape Object Attributes .....                       | 98  |
| Table 30. Escape Detail Code Values .....                      | 99  |
| Table 31. Header Object Attributes .....                       | 99  |
| Table 32. Format of Header Encoding Characters String .....    | 99  |
| Table 33. Note Object Attributes .....                         | 99  |
| Table 34. Observation Object Attributes .....                  | 100 |
| Table 35. Observation Qualitative Value Field Values.....      | 101 |
| Table 36. Observation Method Code Field Values .....           | 101 |
| Table 37. Observation Status Code Field Values.....            | 101 |
| Table 38. Observation Interpretation Code Field Values.....    | 102 |
| Table 39. Operator Object Attributes .....                     | 103 |
| Table 40. Predefined Operator ID Values .....                  | 103 |
| Table 41. Order Object Attributes.....                         | 103 |
| Table 42. Patient Object Attributes .....                      | 103 |
| Table 43. Patient Gender Field Values .....                    | 104 |
| Table 44. Reagent Object Attributes .....                      | 104 |
| Table 45. Request Message Type Codes.....                      | 104 |
| Table 46. Service Object Attributes.....                       | 105 |
| Table 47. Service Role Field Values.....                       | 105 |
| Table 48. Service Status Code Field Values.....                | 105 |
| Table 49. Service Reason Code Attributes.....                  | 105 |
| Table 50. Specimen Object Attributes .....                     | 106 |
| Table 51. Specimen Source Field Values.....                    | 107 |
| Table 52. Specimen Type Field Values.....                      | 108 |
| Table 53. Termination Object Attributes.....                   | 110 |
| Table 54. Termination Reason Field Values .....                | 110 |

**Contents (Continued)****Tables (Continued)**

|   |     |
|---|-----|
| Table 55. Update Action Object Attributes .....                         | 110 |
| Table 56. Update Action Code Values .....                               | 110 |
| Table 57. Summary of Standard (Basic and Complex) Directives .....      | 114 |
| Table 58. Device Messaging Layer Data Type Descriptions.....            | 129 |
| Table 59. Common Data Type Attributes .....                             | 130 |
| Table 60. ED Data Type Attributes .....                                 | 130 |
| Table 61. ST Data Type Attributes .....                                 | 131 |
| Table 62. CS Data Type Attributes.....                                  | 131 |
| Table 63. CV Data Type Attributes .....                                 | 132 |
| Table 64. SN Attribute Values for the CV Data Type.....                 | 132 |
| Table 65. CE Data Type Attributes.....                                  | 132 |
| Table 66. PN Data Type Attributes.....                                  | 133 |
| Table 67. PN Data Type Child Elements .....                             | 133 |
| Table 68. ON Data Type Attributes .....                                 | 134 |
| Table 69. INT Data Type Attributes .....                                | 134 |
| Table 70. Null Code Values.....   | 134 |
| Table 71. REAL Data Type Attributes.....                                | 135 |
| Table 72. PQ Data Type Attributes.....                                  | 135 |
| Table 73. TS Data Type Attributes .....                                 | 136 |
| Table 74. IVL<PQ> Data Type Attributes.....                             | 136 |
| Table 75. Interval Form Literal Encoding.....                           | 137 |
| Table 76. Required Messages for Simple Glucose Example .....            | 146 |
| Table 77. Simple Glucose Example Message Details.....                   | 147 |
| Table 78. Simple Glucose Example Messages .....                         | 147 |
| Table 79. Example Blood Gas Message Values .....                        | 150 |
| Table 80. Example Blood Gas Message.....                                | 150 |
| Table 81. Control/Calibration Observation Example Message.....          | 154 |
| Table 82. Example Device Events Topic .....                             | 157 |
| Table 83. Complete Operator List Message Example .....                  | 159 |
| Table 84. Incremental Operator List Update Message Example.....         | 161 |
| Table 85. Complete Patient List Message Example .....                   | 162 |
| Table 86. Incremental Patient List Message Example.....                 | 163 |
| Table 87. Basic Directive Example Message .....                         | 164 |
| Table 88. Set Time Directive Example Message.....                       | 165 |
| Table 89. Vendor-specific Directive Example (Standard Data Types) ..... | 166 |
| Table 90. Vendor-specific Directive Example (Any Valid XML).....        | 167 |
| Table 91. Vendor-specific Topic Example.....                            | 168 |
| Table 92. Biochemtronix Service Request Response Example DTD.....       | 170 |
| Table 93. Acknowledgement (ACK.R01) Message DTD.....                    | 172 |
| Table 94. DML Message Elements DTD .....                                | 172 |



# 1 Scope and Introduction

The CIC Provider Review Committee (PRC) identified general requirements for a link between a point-of-care Device and an Observation Reviewer. This document specifies message structures and flows that communicate the data elements needed to support these requirements.

This document describes the messaging protocol defined for the POCT1 Device Interface. This Device Messaging Layer (DML) specification sits ‘on top’ of the Device and Access Point (DAP) Interface specification, as shown in Figure 19.

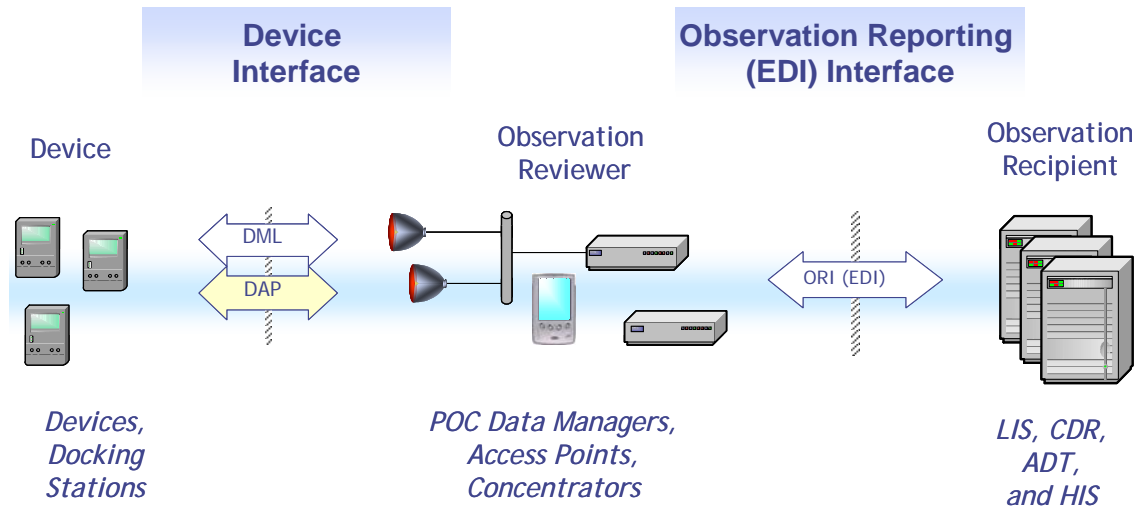

**Figure 19. Device Messaging Layer Scope**

In the ISO Open Systems Interconnect (OSI)<sup>1</sup> networking model, this specification describes a session and application layer protocol (layers 5 to 7, Figure 20).

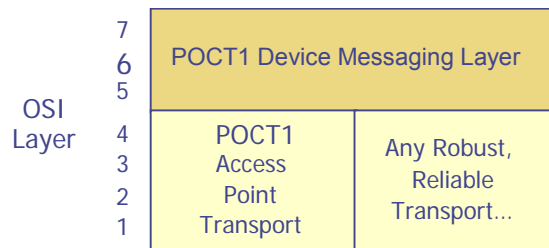

**Figure 20. Device Interface Stack**

Thus, this messaging protocol can be used on top of any robust, reliable transport.

## 1.1 Editorial Conventions

The following editorial conventions are used throughout this document.

- Class names start with capital letters, e.g., **My\_class**

<sup>1</sup> The OSI model describes a ‘stack’ of seven interoperable protocol layers that can be used by two systems to communicate over a network.

- For classes that have general meaning as well as specific meaning within the protocol (e.g., result, operator, service), capitalized names are used when referring to the class and lower case when referring to the general term
- Attribute names are always represented as class name followed by attribute name, separated by a period, e.g., **My\_class.my\_attribute**
- Attribute values are in quotation marks, e.g., **My\_class.my\_attribute** = "MyValue"
- When quoting other sources, the names of the sources are italicized, e.g., *USAM*
- All abbreviations are spelled out the first time used (e.g., Clinical and Laboratory Standards Institute [CLSI])

## 1.2 Definitions

Like many technical documents, the POCT1 Standard uses a number of terms and abbreviations. This document assumes that the reader is familiar with the terms and abbreviations relevant to networking and messaging protocols; however, this specification introduces several new terms and abbreviations. The most common of these are defined as follows:

**Connectivity Industry Consortium (CIC)** – a group of more than 50 healthcare institutions, point-of-care diagnostic vendors, diagnostic test system vendors, and system integrators who formed a consortium in 2000 to address standards for point-of-care connectivity; **NOTE 1:** The CIC developed a standardization specification within its planned one-year lifetime, and then handed this specification over to CLSI ([www.clsi.org](http://www.clsi.org)), Health Level 7 ([www.hl7.org](http://www.hl7.org)), and IEEE ([www.ieee.org](http://www.ieee.org)) organizations for subsequent maintenance and extension; **NOTE 2:** The CIC specification forms the basis for the CLSI POCT1 standard.

**Clinical Data Repository (CDR)** – one of three enterprise healthcare information systems trusted as repositories for clinical result and observation data; **NOTE 1:** See also **Electronic Medical Record** and **Laboratory Information System**; **NOTE 2:** These three types of systems have differing additional responsibilities.

**Coordinated Universal Time (UTC)** – time scale maintained by the Bureau international des poids et mesures (International Bureau of Weights and Measures) and the International Earth Rotation Service (IERS), which forms the basis of a coordinated dissemination of standard frequencies and time signals; **NOTE:** UTC is strictly ‘isotonic’ with International Atomic Time (TAI) with occasional ‘leap-second’ adjustments to ensure approximate agreement with UT1 (a time scale based on the rotation of the Earth.)

**Data Manager (DM)** – typically, a network server that provides the services of an Observation Reviewer (e.g., POC data storage and forwarding, QA/QC, and other POC instrument and data management functions); **NOTE 1:** In addition to these services, Data Managers usually provide other applications or services tailored to particular devices or POC user needs (such as regulatory reporting and operator management applications); **NOTE 2:** Data Manager systems are specific instances of Observation Reviewer services.

**Device Messaging Layer (DML)** – the DML describes a complete messaging protocol (message types and message flow) to exchange results and quality information (quality assurance and quality control) between a Device and an Observation Reviewer; **NOTE:** This protocol may sit on top of any robust, reliable transport, such as the one described by the POCT1 Device and Access Point specification.

**Electronic Data Interchange (EDI)** – electronic Data Interchange is a term used in many industries to describe protocols to exchange data between enterprise-class information systems; **NOTE 1:** The acronym is general (applying to all such exchange protocols and languages); however, in some industries it has come to refer to specific implementations; **NOTE 2:** In the point-of-care domain, this term is occasionally used to refer to the specific interface found between point-of-care data management systems, laboratory information systems, clinical information systems, and other systems that serve as the final repository of POC results.

**Electronic Medical Record (EMR)** – one of three enterprise healthcare information systems trusted as repositories for clinical result and observation data; **NOTE 1:** See also **Clinical Data Repository** and **Laboratory Information System**; **NOTE 2:** These three types of systems have differing additional responsibilities.

**Extensible Markup Language (XML)** – a meta-language widely used in the web and for business-to-business data exchange; **NOTE:** XML is to data and information as HTML is to documents and presentations.

**Health Level 7 (HL7)** – the Health Level 7 organization ([www.hl7.org](http://www.hl7.org)) is an ANSI-accredited standards development organization focused on messaging to support the exchange of clinical and administrative healthcare data; **NOTE:** The HL7 standard specifies a transport-independent messaging framework and structure that enables disparate healthcare information systems to exchange data.

**Laboratory Information System (LIS)** – one of three enterprise healthcare information systems trusted as repositories for clinical result and observation data; **NOTE 1:** See also **Clinical Data Repository** and **Electronic Medical Record**; **NOTE 2:** The three types of systems have differing additional responsibilities.

**Leap-Second** – intentional time step of one second used to adjust UTC to ensure approximate agreement with UT1 (a time scale based on the rotation of the Earth); **NOTE:** An inserted second is called “positive leap second” and an omitted second is called “negative leap second.”

**Network Time Protocol (NTP)** – principal time synchronization and distribution protocol used on the Internet (RFC-1305); **NOTE:** NTP provides robust, reliable, and highly accurate time synchronization using algorithms and protocols that utilize a hierarchical network of time servers and clients that are ultimately tied to one or more primary time servers connected to external times sources, such as a GPS radio clock or ACTS telephone modem time service.

**Observation Recipient** – the Observation Recipient provides services to manage point-of-care test results and ordering information within a healthcare institution; **NOTE:** In current point-of-care information management solutions, this function is often performed by laboratory information systems, clinical information systems, and other systems that serve as the final repository of POC results.

**Observation Reviewer** – the Observation Reviewer provides services to support the management of test results, quality assurance, quality control data, and medical orders; **NOTE:** In current point-of-care information management solutions, this function is often performed by a Data Manager.

**Personal Digital Assistant (PDA)** – the class of consumer electronic devices that handle functions such as management of calendars, contact lists, and task lists; **NOTE 1:** Examples of PDAs include the Palm™ and Pocket PC™ devices; **NOTE 2:** Please see Disclaimer Statement in the beginning of this standard.

**Point of Care (POC)** – the environment immediately surrounding a patient.

**Point-of-Care Device (POCD)** – in the context of this standard, a point-of-care device is an instrument used at the patient’s side to measure and/or record a clinical observation; **NOTE:** This definition does not require that the POCD measure the observed value; thus, this definition encompasses devices that perform biochemical analyses, devices that calculate observations from results determined externally, or devices that simply record values determined by other procedures.

**POCT1 Specification** – this term refers to the entire set of technical proposals and specifications: the Observation Reporting Interface specification, the Device and Access Point specification, and the Device Messaging Layer specification (this document); **NOTE:** *Specification* is capitalized when used to refer to the complete set of the POCT1 technical standards, the *POCT1 Specification*. It is used in lower-case when it refers to one of the three component documents: e.g., the Device and Access Point *specification*.

**Simple Network Time Protocol (SNTP)** – a simplified version of NTP that can be used by small, lightweight clients (RFC-2030).

**1.3 Related Information**

*POCT1 Device and Access Point Specification* – a detailed specification of a lower-layer protocol and service access infrastructure that this Messaging Layer protocol may use.

*XML Implementation Technology Specification (ITS) for Version 3 Data Types* – a HL7 draft document that specifies rules for using XML to encode the data types used by POCT1 messages.

**2 Bidirectional Communication**

This protocol is a session and application-layer messaging scheme, requiring the existence of a robust, reliable, lower-level transport (see Figure 21).

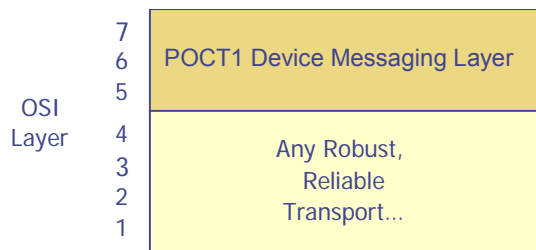

**Figure 21. POCT1 Device Messaging Layer**

The terms “robust” and “reliable” have formal meanings that impose requirements on the lower-layer transports. From a messaging perspective, these requirements may be stated as follows:

- **Robust:** messages are communicated with perfect integrity; i.e., the transport guarantees that message content will not be mangled or disrupted in transit. This capability is often provided using checksums, parity bits, retry schemes, and other means.
- **Reliable:** the transport guarantees that the sender will be informed if a message cannot be delivered to the recipient. Note that this requirement does not guarantee that all messages sent are received (as message queuing middleware does); rather, this property ensures that the sender will be informed if an unrecoverable error was encountered during the transmission of a message.

As the Device Messaging Layer is truly separable from the lower transport layers, it may be used on top of any robust, reliable transport (e.g., TCP/IP, IPX/SPX, IEEE 802.11b, Bluetooth™). The *POCT1*

*Device and Access Point* specification proposes one such compatible transport, which is very low cost and enables both RS-232 and IrDA-infrared physical connections (Figure 22).

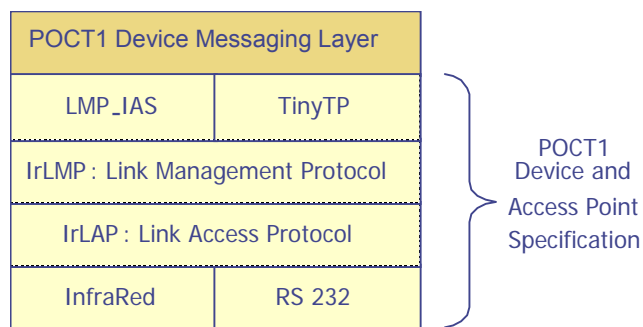

**Figure 22. Device Messaging Layer and Access Point Specifications**

The principal benefit of requiring a robust, reliable transport is that the Messaging Layer protocol does not need to incorporate features such as checksums, retries, packet serialization, and routing. Please refer to the *POCT1 Device and Access Point Specification* for more detailed information about the features provided by the lower-level protocol.

## 2.1 Communication Content

In accordance with the requirements that the CIC's Provider Review Committee stated for point-of-care Device communication, this specification supports bidirectional communication of the following data elements between a point-of-care Device and an Observation Reviewer:

1. Device Status
2. Observations
  - 2.1 Patient Tests
  - 2.2 Calibration Tests
  - 2.3 Quality Tests
    - 2.3.1 Liquid QC
    - 2.3.2 Electronic QC
    - 2.3.3 Calibration Verification<sup>u</sup>
    - 2.3.4 Proficiency Test
3. Device Events
4. Update Lists
  - 4.1 Operator List
  - 4.2 Patient List
5. Directives
  - 5.1 Basic (e.g., Lockout, Goto Standby)
  - 5.2 Complex (e.g., Set Time)
  - 5.3 Vendor-specific
6. Vendor-specific Data

<sup>u</sup> A 'linearity' test is an example of a calibration verification test.

© Clinical and Laboratory Standards Institute. All rights reserved.

## 2.2 Principles

Many message flows could be constructed to communicate the content described in Section 2.1. The following design principles are used to limit the possible flows.

1. The flow should be as simple as possible, but no simpler.
  - 1.1 In general, the number of messages, not the size of the messages, governs messaging performance.
  - 1.2 An effort should be made to keep the implementation complexity low (e.g., to simplify the Device and Observation Reviewer state diagrams).
2. The Messaging Layer relies on a robust, reliable lower-level transport and protocol. Therefore, the messaging layer does not need to deal with issues like detecting transmission errors, link-level timeouts, and end-to-end flow control.
3. The message protocol should support both intermittently connected (docked) and persistently connected (bench top LAN-enabled) Devices.
4. In general, the Observation Reviewer should ‘drive’ the conversation. Allowing Devices to simply react to Observation Reviewer messages will reduce the complexity of Device implementations.<sup>v</sup>
5. The messaging protocol must support application-level errors. These errors include:
  - 5.1 *Application Errors* — encountered when parsing or processing messages.
  - 5.2 *Protocol Errors* — encountered when one participant sends an unexpected message to the other.
6. The messaging protocol should be able to detect and handle unresponsive participants. The protocol should support two features (which vendors may choose whether to implement):
  - 6.1 *Timeouts* — a Device may specify an application-level timeout period for which it is willing to wait for a response from the Observation Reviewer.
  - 6.2 *Keep Alives* — both the Observation Reviewer and the Device may use keep alive messages to confirm that the other participant is able to respond.
7. The messaging protocol should place few requirements on and make few assumptions about the participants’ expected behavior.
8. The messaging protocol should scale to support the capabilities of the Device. Not all Devices will support the same rich set of POCT1 messages. The protocol should allow an Observation Reviewer to tailor a conversation with a Device to only the features and functions that the Device supports.
9. The minimal messages required for a Device to be POCT1 compliant are:

---

<sup>v</sup> Note that this principle is relaxed for the case of Devices that are continuously connected to a network (Section 4.2), as these Devices are generally much more capable than a periodically docked hand-held Device.

- Hello
- Device Status
- Observations (including both patient-test and nonpatient-test results)
- Terminate

## 2.3 The Dialog

In general, the communication between the Device and the Observation Reviewer can be described at a high-level in terms of a dialog between two actors. The following ‘script’ outlines how an idealized dialog proceeds between a Device (DEV) and an Observation Reviewer (OR):

**Table 6. Idealized Device - Observation Reviewer Dialog**

DEV: Hello Observation Reviewer, I’m Device ‘xyz’. I’m on-line.  
OR: Hello ‘xyz.’ You are a registered Device. Please proceed.  
DEV: Here is my Device Status. What else would you like me to do?  
OR: Device ‘xyz,’ please report your Observations.  
DEV: Here are my Observations. What else would you like me to do?  
OR: Device ‘xyz,’ please report your Device Events.  
DEV: Here are my Device Events. What else would you like me to do?  
OR: Device ‘xyz,’ please accept this Directive: ‘xxx’.  
DEV: I can perform Directive ‘xxx.’ What else would you like me to do?  
OR: Device ‘xyz,’ please accept this Vendor-specific Communication: ‘yyy’.  
DEV: I have received Vendor-specific Communication ‘yyy.’ What else would you like me to do?  
OR: Device ‘xyz,’ please terminate this conversation.  
DEV: Goodbye, Observation Reviewer.

## 2.4 Messaging Scheme

### 2.4.1 Messaging Components

The following terms are used to describe messaging between a Device and an Observation Reviewer.

Conversation: A prescribed flow of messages between the Device and Observation Reviewer, having both an initialization and a termination phase. A Conversation is made up of a series of ‘Topics.’

Topic: The flow of messages to exchange a complete set of data within a Conversation (e.g., Observations, Device Events). A Topic is composed of a series of ‘Messages.’

Message: The simplest element of data exchange between the Device and Observation Reviewer. Each Message is composed of one or more ‘Objects.’

Object: An Object is the smallest logical element of a message (e.g., Header, Observation, Order). Each Object is composed of one or more ‘Attributes.’

Attribute: An Attribute is the smallest named element of a message that contains data. Examples of attributes include ‘expiration\_date,’ ‘value,’ and ‘permission\_level\_cd.’

The following figure illustrates the relationship between the high-level concepts of Conversation, Topics, and Messages.

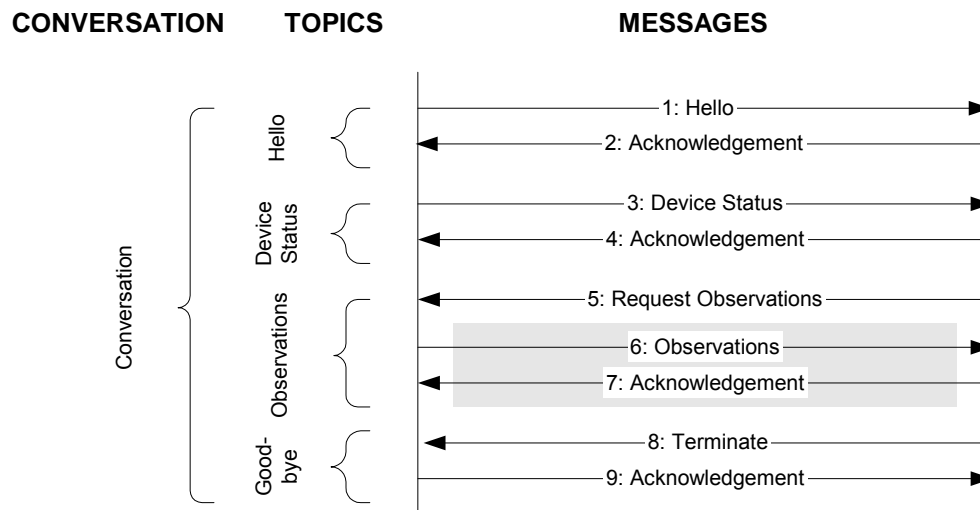

Figure 23. Messaging Scheme: Conversation, Topics, and Messages

### 2.4.2 Message Encoding

Many possible schemes have been used in the past for application-level message encoding. These schemes include:

- Fixed Field-Length schemes – legacy record-based transport protocols
- Tag-Delimited schemes – HL7 ER syntax
- Tagged Markup schemes – eXtensible Markup Language (XML), Hyper-Text Markup Language (HTML)

The CIC weighed the merits of each of these approaches and determined that an XML-based approach best met the requirements of flexibility, robustness, simplicity, and widespread industry standardization.<sup>w</sup>

XML is a meta-language: i.e., a language for specifying other languages. Thus, the role of XML in this context is as a tool to define the specific language used for Device communication. POCT1 employs XML to define a tagged markup language for messaging between a Device and an Observation Reviewer.

Rather than developing a completely new language in XML, the POCT1 Device Messaging Layer’s messages leverage the XML encoding rules defined in HL7 version 3. Principally, the CIC leveraged the data type encoding rules defined in the HL7 *Version 3 Data Types – Ballot Draft II (revision 1.3)* document.

Section 11 of this document contains examples of Device Messaging Layer messages encoded using these rules.

**NOTE:** All messages must be well-formed XML messages per the XML working group’s latest standard, available at <http://www.w3.org/TR/REC-xml/>. For example, all message headers shall have as their first line `<?xml version = “1.0” encoding = “UTF-8”?>`

<sup>w</sup> See the *CIC XML White Paper* document for more details on the motivation for encoding messages using XML.



### 3 General Messaging Issues

The following subsections discuss general messaging and protocol issues that are common to all profiles:

- Lower-Level Buffering
- Data Integrity
- Bandwidth Considerations
- Error Handling
- Keep-Alive Messages
- Application Timeouts
- Minimum Message Set for POCT1 Compliance

#### 3.1 Lower-Level Buffering

Some transports used by the lower-layer link may buffer data to increase transmission efficiency. For example, TCP/IP stacks will usually buffer data before sending to ensure that network packets are optimally utilized. While this behavior does not directly impact this messaging specification, applications built on these specifications should be aware of this possible issue. To minimize buffering delays and ensure adequate performance, Devices and Observation Reviewers may need to use explicit commands to flush the lower-layer transmission buffer after each message is queued. TCP/IP provides a ‘Push’ operation that accomplishes this task.

#### 3.2 Data Integrity

Common information management practices place two data integrity requirements on the participants (Device and Observation Reviewer) in a dialog:

- that the participants not lose or corrupt any observations or measurements; and
- that the participants not duplicate any observations or measurements.

To ensure that the first requirement is met, this protocol requires formal acknowledgement of all dynamic data<sup>x</sup> messages and imposes certain responsibilities on the participants to ensure that no observations or other data are lost.

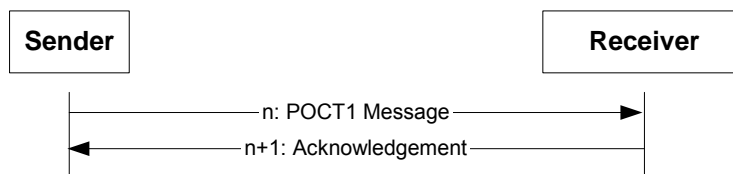

**Figure 24. Acknowledgement Message Flow**

In general, every message that involves transfer of dynamic data from sender to recipient requires that an Acknowledgement message be sent from recipient back to sender (Figure 24). The sender maintains responsibility for preserving the data until it receives an acknowledgement indicating that the data has been successfully transferred. Once the recipient sends an acknowledgement message, it assumes responsibility for managing and maintaining the data.

<sup>x</sup> Dynamic data messages include all messages except for Request, Acknowledgement, Escape, and End of Topic.

A combination of the Acknowledgement protocol and participant behaviors ensures that the second requirement is met: that duplicate observations do not result from the conversation. The receiver always bears the burden of ensuring that any given data element is recorded only once. The sender may ‘assist’ the receiver in this task by sending acknowledged data only once. Specifically, once the sender receives acknowledgement that data has been transferred, it may ensure that that data is not transferred again (e.g., by deleting the data from its memory). However, the final responsibility for preventing duplicate records always falls on the receiver. For justification, consider the following two cases:

- Devices may need to intentionally resend measurement data:

For example, if an Observation Reviewer was incorrectly started in a TEST rather than a PRODUCTION mode, any Device that uploaded observations to the wrong area should be able to ‘resend’ the observations once the Observation Reviewer has been switched to PRODUCTION.

- A failure could cause data to be resent:

After receiving an Observation from a Device, an Observation Reviewer sends an Acknowledgement message to the Device. Since the protocol described in Figure 24 does not “ACK the ACK” (i.e., there is no Acknowledgement message in response to ACK, message #2), the Observation Reviewer can never be certain that the Device received the Acknowledgement message. If a catastrophic error (e.g., battery failure, internal coding error) prevented the Device from processing the Acknowledgement, it will try to send the same observation message again with the next conversation.

So, the receiver bears the final responsibility for ensuring that duplicate data is not recorded.

In summary, the message structures and flows themselves cannot ensure data integrity. Instead, the protocol relies on the participants in the exchange to implement behaviors that maintain a chain of responsibility for the data. These behavioral rules are quite simple. In an exchange characterized by a ‘sender’ transmitting dynamic data to a ‘receiver’:

- The ‘sender’ is responsible for:
  - preserving dynamic data until it has received an acknowledgement message from the receiver.
- The ‘receiver’ is responsible for:
  - preserving dynamic data once it has sent an acknowledgement message to the sender; and
  - ensuring that duplicate data are not recorded.

As an example, consider the case of a Device transmitting observations to an Observation Reviewer. The Device should free the memory associated with a particular set of observations only after it receives an acknowledgement message in response to transmission of those observations. On the other side, the Observation Reviewer becomes the custodian of the observations once it sends an acknowledgement message to the sender. Before persistently storing the observations (or forwarding them on to another system that then assumes responsibility for preserving the observation data), the Observation Reviewer must determine that they are unique (i.e., not duplicate results resent by the Device). This last responsibility is not an onerous burden, as the POC data management applications currently on the market perform this service.

### 3.3 Bandwidth Considerations

The Device Messaging Layer is designed to be useable in a variety of settings and over a range of communication technologies. Thus, the protocols' bandwidth requirements were of principal concern to the committee. The committee analyzed several real-world communication examples. In a 'worst case scenario,' using a 9600 bit-per-second communication link, sending 100 simple test result messages (about 800 bytes, each) takes about 50 seconds to transmit.

It is anticipated, however, that the widespread deployment of a universal access point infrastructure within the hospital will lead to more frequent and briefer downloads of POCT data, leading to more timely and accurate reporting of POCT results.

### 3.4 Error Handling

The Messaging Layer protocol can convey errors resulting from two general classes of faults:

- Application Errors – faults that occur during the processing of messages; and
- Protocol Errors – faults that occur because of either the delivery of an unexpected message or a situation in which the receiver can't handle the messages in the current Topic.

Application errors are communicated using the Acknowledgement message. Protocol errors are handled by the Escape message. These messages and their use cases are discussed in more detail in the following subsections.

#### 3.4.1 Application Errors

The Acknowledgement message is used to handle application errors. This message can communicate two states:

- Acknowledged: the message was received without error; or
- Error: an application-level error was encountered while processing the message.

This specification does not stipulate the processing that an application must do prior to sending an Acknowledgement message. In most cases, a message recipient will at least validate the message's structure before sending an Acknowledgement. This level of validation can usually be performed quickly. If the recipient encounters a problem during this validation, it should send an Error Acknowledgement message back to the sender.

In some cases, the recipient will also check to see that individual message values are correct and perhaps apply logic to process the contents of the message. If the recipient encounters an error during this processing, it should send an Error Acknowledgement message back to the sender. Vendors should judiciously choose the amount and extent of any application-level processing their systems perform, as long delays in sending Acknowledgement messages will adversely impact message throughput.

Note that the Messaging Layer protocol does not impose any behavior on the recipient of Error Acknowledgement messages beyond the data integrity requirements discussed in Section 3.2. For example, the recipient of an Error Acknowledgement message is free to take any of the following actions:

- to retry sending the offending message;

- to ‘give up’ sending that particular message and proceed to the next message in the Conversation sequence; or
- to terminate the Conversation.

As a note, senders that choose to try resending the message should implement a maximum retry counter to prevent an infinite loop from occurring with a receiver that keeps encountering problems handling a particular message.

### 3.4.2 Protocol Errors

The Escape message is used to communicate protocol or message structure errors. Protocol faults can occur for two reasons:

- An unexpected message – occurs when one participant sends an unexpected message to the other. Possible causes of this fault include:
  - Installation configuration errors – for example, an Observation Reviewer is configured to expect that a Device has capabilities that it in fact doesn’t support.
  - Protocol implementation errors – for example, errors in the programming of a participant’s protocol state machine.
  - Message structure errors – for example, the sender did not provide all of the message elements that the receiver expected.
- An error encountered while handling the Topic – occurs when the receiver encounters a situation that prevents it from being able to complete the current Topic. As an example, this case would occur if the receiver had insufficient memory to store new data.

The Escape message allows one participant to inform the other that it cannot complete the current Topic and to request that the other participant move on to the next Topic. The recipient of an Escape message must stop processing the current Topic and move on to the next Topic in the message flow. The use of Escape messages is covered in more detail in Section 4.1.12.2.

### 3.5 Keep Alive Messages

The Messaging Layer protocol provides brief messages that both Devices and Observation Reviewers can use in a ‘keep alive’ dialog. In general, Keep Alive messages are not needed if the lower-layer protocols described in the Access Point specification are used.<sup>y</sup> However, deployments that incorporate a communication link that does ‘time out’ (e.g., dial-up modem connections) may require the use of these messages.

This CLSI standard does not define or prescribe any specific keep alive behavior. Vendors are allowed to implement approaches that are most suitable to their products’ requirements.

Typically, one participant in a Conversation will send a Keep Alive message to the other if it has not received a message within a given period. For example, an Observation Reviewer that has not received any messages from a Device within the last minute may send a Keep Alive message to test whether the Device is still responsive. It is important to note that unless the lower-level transport employs a

---

<sup>y</sup> Both TCP/IP and IrDA TinyTP can maintain a connection forever.

communications link that disconnects due to inactivity, there is no reason to send a Keep Alive to manage or maintain the lower-level connection.

Upon receiving a Keep Alive message, a participant should immediately reply with an Acknowledgement message. Note that since Keep Alive messages are not part of the minimum POCT1-compliance message set (Section 4.4), it is possible that a participant could not be prepared to receive a Keep Alive message. In these cases, the participant would reply with an Escape message, rather than an Acknowledgement. In either case, the objective of the Keep Alive dialog is accomplished.

To keep protocol implementations simple, Keep Alive messages may only be sent when neither participant is waiting for a response. For example, a Device that is waiting for a response to an Observation message may not send a Keep Alive before the expected Acknowledgement is received. In general, a participant may always send a Keep Alive if the last message exchanged in the Conversation was an Acknowledgement or an End of Topic.

### 3.6 Application Timeouts

An application timeout occurs when one participant in a Conversation does not send an expected response within a predetermined period. An application-level timeout is distinct from lower-level timeouts that occur when the data link is broken.

A Device might encounter an application timeout after sending an Observation message if the Observation Reviewer it is conversing with becomes so preoccupied with other tasks that it does not send an Acknowledgement message within an acceptable interval. The Device reports this interval in the **Device Capabilities.application\_timeout** field of the Hello message.

An Observation Reviewer detects a timeout when a Device fails to send a timely response to a message. In general, Observation Reviewers should be very generous with their timeout behavior (e.g., set timeouts of several minutes). Usually, it does not cost an Observation Reviewer much to be tolerant of long delays. It is best for the Observation Reviewer to wait as long as possible for a Device to respond, rather than terminating a conversation while there's still some chance that it can be completed.

A participant that encounters an application timeout has only a few options:

- it may send a Terminate message to end the Conversation;
- it may send a Keep Alive message and reset its application timeout counter;
- it may choose to continue waiting for a response; or
- it may tear down the lower-level connection, thereby (abnormally) terminating the Conversation.

One option that is not available to a participant that detects an application timeout is to resend the previous message. Such behavior could result in a participant receiving duplicate messages, an unacceptable outcome. The messaging protocol runs on top of a reliable, robust lower-level protocol that guarantees that all messages will be delivered. If the lower-layer protocol reports that the message has been successfully transmitted (i.e., no exceptions or transport errors), only an application-level error can provide reason to resend the particular message.

### 3.7 Minimum Message Set for POCT1 Compliance

This specification provides an assortment of messages to support the communication needs of a wide variety of point-of-care instruments. Within certain limitations, Devices may choose to implement only

the messages that support functions they provide. However, all Devices and Observation Reviewers must support a minimum set of messages to be compliant with the POCT1 Device Messaging Layer specification. This minimum message set is sufficient to support a simple dialog to exchange patient- and nonpatient-test result data.

Section 4.4 describes in detail the messages in this minimum compliance set.

## 4 Messaging Profile

The Device Messaging Layer specification describes a single *messaging profile* designed to fit the needs of Devices that connect to Observation Reviewers via docking stations, network ports, or wireless access points. The objective of this profile is to transfer all of the required message elements (Section 2.1) as efficiently as possible, with as little complexity burden on the Device as possible.

This profile takes the form of a Basic Profile with a couple of optional extensions to accommodate the needs of all point-of-care Devices.

### 4.1 Basic Profile

Simple hand-held Devices use the Basic Profile to quickly and efficiently exchange data with an Observation Reviewer. This profile accommodates the needs of Devices that perform synchronization tasks when periodically ‘docked’<sup>z</sup> to an access point.

Two simple extensions to the Basic Profile accommodate special circumstances presented by two important categories of Devices:

- Section 4.2 - Continuous Mode: Supports Devices that are deployed with a dedicated Access Point or LAN connection to the Observation Reviewer.<sup>aa</sup>
- Section 4.3 - Asynchronous Observation Acknowledgements: Supports sophisticated Devices that can use asynchronous messaging to achieve higher messaging throughput and efficiency.

#### 4.1.1 Ideal Message Flow

The following schematic illustrates an error-free message flow between a Device and an Observation Reviewer using the Basic Profile.

---

<sup>z</sup> The Device and Access Point specification describes a *Common Access Point* infrastructure that all Devices may use to link to an Observation Reviewer via a cabled or infrared wireless connection.

<sup>aa</sup> Today, cabling provides the infrastructure for these continuously connected Devices. In the future, this approach will meet the needs of Devices that use radio-frequency wireless networks to link to Observation Reviewers.

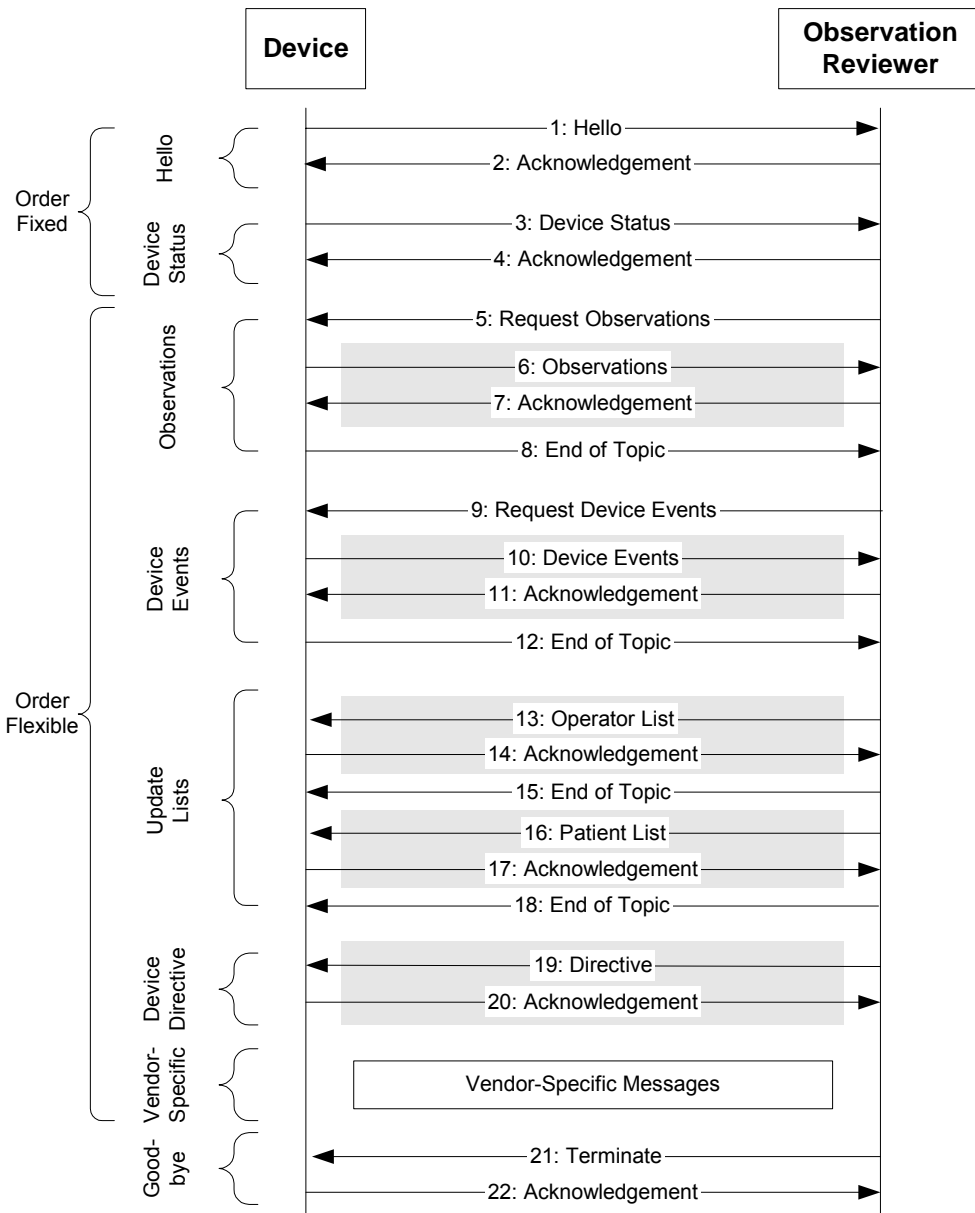

**Figure 25. Error-Free Basic Profile Flow**

Notes on Figure 25:

- The following message types are not illustrated in this flow. They are discussed in following sections.
  - Keep Alive messages (Section 4.1.9); and
  - Escape messages (Section 4.1.12.2).
- The ‘gray bar’ underlying messages indicates a potentially repetitive message sequence. For example, this notation indicates that Message 7: Acknowledgement may be followed by either an End of Topic or another Observation message.

### 4.1.2 Conversation Startup

The protocol strictly defines the sequence of Topics and Messages required to start a Conversation.

A Device initiates this startup sequence by sending a Hello message to an Observation Reviewer.

If the Observation Reviewer encounters an error parsing or interpreting the Hello message, it should reply with an Error Acknowledgement message indicating the appropriate error code. The Observation Reviewer should follow this message with a Terminate to gracefully end the conversation. This Terminate message should indicate the reason the Conversation was terminated.

If the Observation Reviewer is able to parse the Hello message but does not want to talk to the Device (e.g., it has not been configured to recognize this particular Device type or ID), it should send an Error Acknowledgement message to the Device with **ACK.error\_detail\_cd** set to '200' (see Table 14), indicating that the Device's ID value is not supported. This message could also contain text that the Device could display to inform the operator of an action to take (e.g., "Call the support desk").

If the Observation Reviewer wants to establish a dialog with the Device, it sends a positive Acknowledgement message in response to the Hello. The Device then responds with a Device Status message. The Observation Reviewer completes the Conversation Startup sequence when it sends a positive Acknowledgement message in response to the Device Status message.

If the Device does not receive a positive Acknowledgement message in response to its Hello and Device Status messages, it must assume that the Observation Reviewer does not want to establish a Conversation. The Device should immediately disconnect from the Observation Reviewer by tearing down the lower-level link.

### 4.1.3 Flexible Conversation Topics

Once the Conversation Startup sequence has been successfully completed, the message flow becomes more flexible. The Observation Reviewer controls the order of the Topics addressed after the Conversation Startup. Since no restrictions are placed on the Observation Reviewer regarding ordering of Topics, the Device must be prepared to handle Topics in any order. In addition, the Observation Reviewer is allowed to revisit Topics more than once in a Conversation. For example, an Observation Reviewer might reissue a Device Events request to learn about completion status of a Directive.

All POCT1-compliant Devices are required to support the Observations Topic.<sup>bb</sup> It is the Observation Reviewer's responsibility to tailor the Topics addressed to the capabilities of the Device, as expressed in the Device Static Capabilities object (Section 5.7). If a Device receives a message for a Topic it does not support, it should reply with an Escape message to terminate the unsupported Topic.

### 4.1.4 Using Multiple Messages for Large Data Transfers

Occasionally, a Topic may involve an exchange of a large amount of data. To address reliability and performance concerns, the Basic Profile provides a flexible scheme to send such blocks of data in any number of messages. For example, a Device could send several hundred new observations either in a single large Observation message or in several smaller Observation messages.

The general scheme for splitting large data transfers into several messages is shown in Figure 26.

---

<sup>bb</sup> Section 4.4 describes the minimum set of messages Devices and Observation Reviewers are required to support to be CIC-compliant.



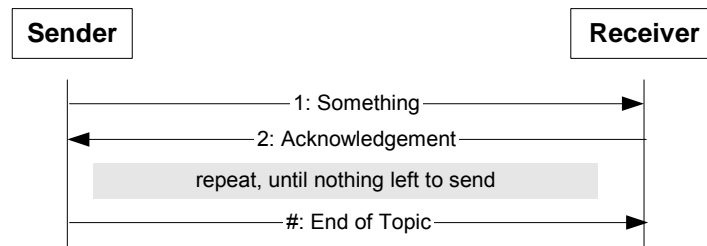

**Figure 26. Large Data Set Transfers Using Multiple Messages**

As shown in the figure, this approach requires that the Sender send an End of Topic message to indicate that this particular data transfer is complete and there are no more messages forthcoming in this Topic. Note that even if the entire data set is transferred in a single message, the End of Topic message still must be sent.

The Sender decides when and how it is appropriate to break a data set into multiple messages. This specification provides no guidance regarding how this decision should be made. Vendors must consider a variety of issues such as network reliability and performance and system implementation characteristics when making the tradeoff between message size and number of messages.

#### 4.1.5 Observations

The Observations Topic is used to transfer both patient- and nonpatient-test results from a Device to an Observation Reviewer. Examples of nonpatient test results communicated with this message include QC results, calibration results, and calibration verification results. All Devices and Observation Reviewers must support the Observations Topic.

If a Device reports that it has new observations (using the **Device Status.new\_observations\_qty** field of the Device Status message), the Observation Reviewer shall process the Observations Topic at some point in the Conversation. The Observation Reviewer starts this Topic by sending a Request Observations message to the Device.

The Device responds to this request message with zero or more Observations messages containing the new test results. If the Device has no new observations to report, it shall send an End of Topic message in response to the Request Observations message (rather than sending an ‘empty’ Observations message or sending an Error Acknowledgement message).

If the Device receives an Error Acknowledgement message, it may choose one of the following two courses of action:

- continue to send the remaining observations; or
- terminate the Observations Topic by sending an End of Topic message.

The Device is responsible for storing any untransmitted or unacknowledged observations.

#### 4.1.6 Device Events

If a Device indicates that it has new events to report (using the **Device Status.new\_events\_qty** field of the Device Status message), the Observation Reviewer shall process the Device Events Topic at some point in the conversation. The Observation Reviewer begins this Topic by sending a Request Device Events message to the Device.

As is the case with the Observations topic (Section 4.1.5), the Device must respond to this request with zero or more Device Events messages, followed by an End of Topic message.

Similar to the Observations Topic, the Device may choose either to continue or to terminate the topic if it receives an Error Acknowledgement message. Of course, the Device retains responsibility for saving any untransmitted Device event data.

If an Observation Reviewer requests events but the Device has none to provide, the Device shall respond by sending an End of Topic message (rather than sending an 'empty' Device Events message or sending an Acknowledgement with an error code).

#### 4.1.7 Operator and Patient Lists

The Operator List and Patient List Topics are similar in that they involve the transfer of potentially long lists of entries from the Observation Reviewer to the Device. Although the message models for the Patient List and Operator List messages are different, the message flows in these Topics are identical. This section uses the generic term "Update List" to discuss both flows.

Figure 27 illustrates the message flow for an Update List Topic.

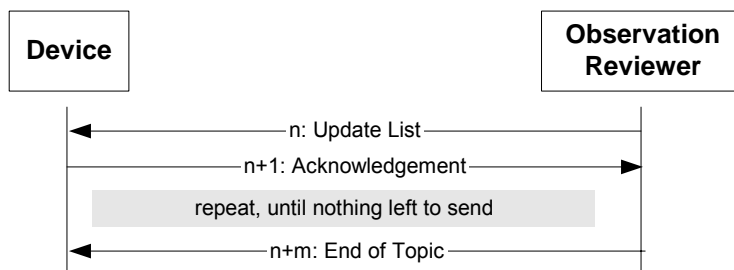

**Figure 27. Update List Topic Message Flow**

The Observation Reviewer must wait for an Acknowledgement message from the Device before sending the next Update List message. The Observation Reviewer must send an End of Topic message after receiving the Acknowledgement in response to the message containing the last of the Update List data.

If a Device that does not manage lists receives an Update List message, it shall reply with an Escape message. If, however, a Device can handle lists but receives an Update List message that it cannot parse or process, it shall respond with an Acknowledge message indicating the error reason. In the latter case, the Observation Reviewer can follow one of two courses of action:

- continue sending the remaining Update List messages to the Device; or
- give up on the topic by sending an End of Topic message to the Device.

With either action, the Device will not contain a complete view of the current list. The Observation Reviewer shall note this and attempt to upload a complete list during the next Conversation.

The Update List Topic provides two different schemes for updating the Device: Complete and Incremental. In the Complete scheme, the Observation Reviewer sends the entire current list to the Device, which replaces its list with the new one. In the Incremental scheme, the Observation Reviewer sends only the changes to the list that have occurred since the Device was last updated.

This ‘time of last update’ is determined by the **End of Topic.update\_dttm** value returned by the Observation Reviewer in the End of Topic message sent at the completion of a successful list update.

#### 4.1.8 Directives

The Directive Topic provides the Observation Reviewer with a mechanism to send commands to the Device. This Topic is comprised of one or more Directive messages. Each Directive message contains one command, followed by zero or more objects containing parameter data (Section 6.5).

Upon receipt of a Directive, the Device shall parse the command message and any supplied parameters to determine if it can perform the specified operation. If the Device cannot parse or interpret the message, it shall reply with an Error Acknowledgement message specifying why the Directive was rejected. If the Device cannot handle Directive messages at all, the Device shall reply with an Escape message.

Once the Device has parsed the Directive and determined that it can perform the specified operation, it shall send the Observation Reviewer a positive Acknowledgement message. This Acknowledgement message indicates to the Observation Reviewer that the Device has promised to execute the specified action — not necessarily that it has actually performed the operation. Although the Device may decide to perform the operation prior to returning an Acknowledgement, a positive Acknowledgement message only indicates that the Device understood and will perform the Directive. Errors encountered during the execution of a Directive shall be reported as Device Events.

The Observation Reviewer cannot rely on the Directive Acknowledgement message to indicate that the operation is complete. The Device decides whether to acknowledge a Directive after the specified operation is complete or after parsing and understanding the Directive message. For example, a Device that receives a Set Time Directive might acknowledge the message immediately after it has set the Device time, as this is a quick operation. On the other hand, a Device that receives a GOTO\_READY Directive might acknowledge the message after it has parsed and understood the Directive, as getting to the ‘ready’ state might involve time-consuming tasks such as heating ovens and performing internal calibration. After achieving the ‘ready’ state, the device should indicate the change in status with a Device Event message.

An Observation Reviewer may send a Directive at any time that it is not waiting for a response message from the Device. Because these messages may be sent at any time, no End of Topic message is employed.

#### 4.1.9 Keep Alive Messages

If desired, participants may exchange Keep Alive messages as described in Section 3.5. In general, if the lower-level protocols described in the *Device and Access Point* specification are used, Keep Alive messages will not be necessary to maintain the lower-level link.

#### 4.1.10 Vendor-specific Messages

The messages defined in this document support a basic functional level of point-of-care connectivity for test result reporting and QC/QA management. Occasionally, a Device will need to exchange information with a vendor-specific component of an Observation Reviewer. Examples of these vendor-specific exchanges include:

- Firmware updates: new firmware code is downloaded from a point-of-care Data Manager application when the Device is docked; and
- Performance/Diagnostic data: some Devices support uploading vendor-specific performance or diagnostic data to Data Manager applications for research or vendor-specific analysis purposes.

Clearly, the Messaging Layer protocol cannot standardize these types of exchanges. However, the protocol does provide several mechanisms by which vendor-specific point-of-care data management components may hold vendor-specific exchanges with a Device. These include:

- Custom Directive messages; and
- Custom message topics, types, and models.

These approaches are discussed in more detail in the following sections.

#### 4.1.10.1 Custom Directive Messages

A vendor may define a new Directive to communicate data from the Observation Reviewer to the Device. The basic structure of a Directive message is a command code, followed by zero or more parameter objects. Vendors are free to define new command codes and to specify appropriate parameter objects for these new commands. This specification predefines several common Directive messages (Section 6.5), which should be used if appropriate.

This approach is discussed in more detail in Section 7.1.

#### 4.1.10.2 Custom Message Topics, Types, and Models

This approach involves creating new message types, models, and flows to enable vendor-specific data exchange. Though this approach is more complicated than using custom Directive messages, it provides a flexible and extensible framework for bidirectional data exchange. Unlike the Directive-based approach, custom messages can be used to more efficiently transfer data between a Device and a POCT data management application.

This approach is discussed in more detail in Section 7.2.

### 4.1.11 Conversation Termination

Conversations that end normally always conclude with the Terminate Topic. Either the Device or the Observation Reviewer may initiate this topic by sending a Terminate message.

#### 4.1.11.1 Observation Reviewer-initiated Termination

Under normal circumstances, the Observation Reviewer will always decide when a conversation should be terminated. Figure 25 illustrates a ‘normal’ scenario. Once the Observation Reviewer has completed all of the Topics that the Device is capable of handling, it will start the Terminate Topic by sending a Terminate message to the Device. The only valid response from the Device is to acknowledge this message with a positive Acknowledgement. Once the Observation Reviewer has received the Acknowledgement message, or after an appropriate timeout period, it may begin the process of tearing down the lower-level connection.

In this scenario, the Observation Reviewer begins the Terminate Topic only after all relevant Topics in the dialog with the Device have been completed. However, it may be necessary for the Observation Reviewer to terminate a conversation before completing all Topics. For example, an Observation Reviewer might need to quickly terminate a conversation prior to a forced maintenance shutdown of the system. Under such circumstances, the Observation Reviewer may begin the Terminate Topic at any time after sending a positive Acknowledgement of the Device’s Hello message. Thus, a Device must be prepared to receive and process a Terminate message at any time after it receives this first Acknowledgement.

## 4.1.11.2 Device-initiated Termination

A more common scenario for unexpected conversation termination involves an operator canceling a conversation in order to free the Device for patient testing. In these cases, the Device initiates the Terminate Topic in response to the operator's request.

Experience has shown that once an operator has requested an immediate end to the Conversation, s/he won't wait more than a few seconds before physically breaking the lower-level connection. Quick completion of the Terminate Topic is very important in these scenarios; therefore, a Device is allowed to send a Terminate message at any time.<sup>cc</sup>

Figure 28 illustrates a Device terminating a Conversation during transmission of the Observation Topic.

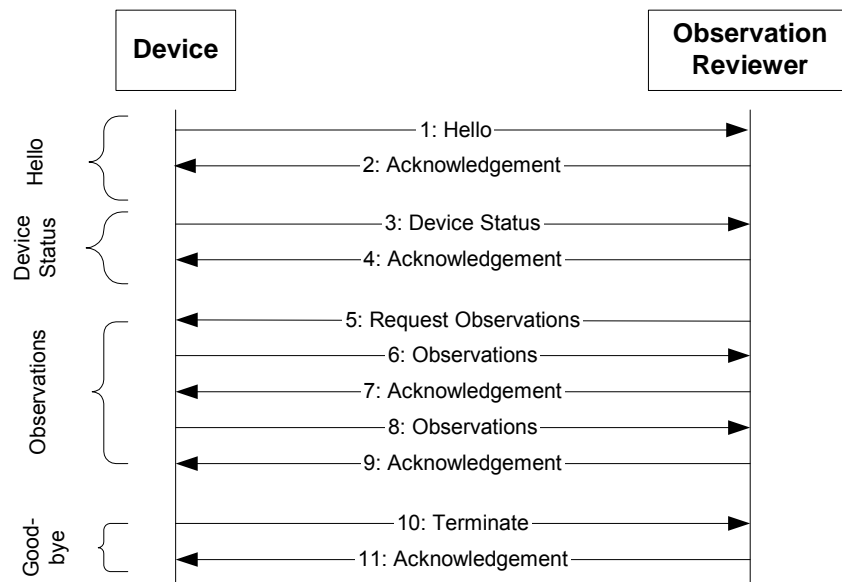

**Figure 28. Device-initiated Termination Flow**

In this flow, the operator requested that the Device terminate the Conversation while it was in the midst of transmitting observations. To comply with the operator's request, the Device sent message 10: Terminate in place of either another Observations or an End of Topic message.<sup>dd</sup> The Observation Reviewer must reply to the Terminate message with an Acknowledgement message. After receiving this final Acknowledgement (11: Acknowledgement), the Device may tear down the lower-layer connection.

## 4.1.11.3 Abnormal Termination

Another termination scenario involves an abnormal breakdown in the communication logic or the lower-layer communications link.

The first case, a breakdown of communication logic, involves one participant in the conversation failing to send or respond to messages appropriately. In this case, a combination of Escape messages and/or timeout logic (Section 3.6) will terminate the conversation.

<sup>cc</sup> Note that the one exception to this rule is the final Acknowledgement message a Device sends in response to a Terminate message from the Observation Reviewer. As the Conversation is already terminating in this case, this is a reasonable exception.

<sup>dd</sup> The actual message type depends on whether or not the Device had more observations to transmit.

In the latter case, a failure of the lower-layer link, the participants have no choice but to clean up any local Conversation session state and wait for a new communications link to be established. A common example of this case involves the user intentionally breaking the communications link to use the Device to perform a test. Since the lower-layer protocol is *reliable*, it will inform the application logic once the communications link is lost. At this point, the conversation participants have no choice but to free any session state and wait for a new connection.

**4.1.12 Error Handling**

As discussed in Section 3.4, participants may use Escape and Error Acknowledgement messages to handle error conditions. Figure 29 illustrates the use of both of these messages during the course of a single Conversation.

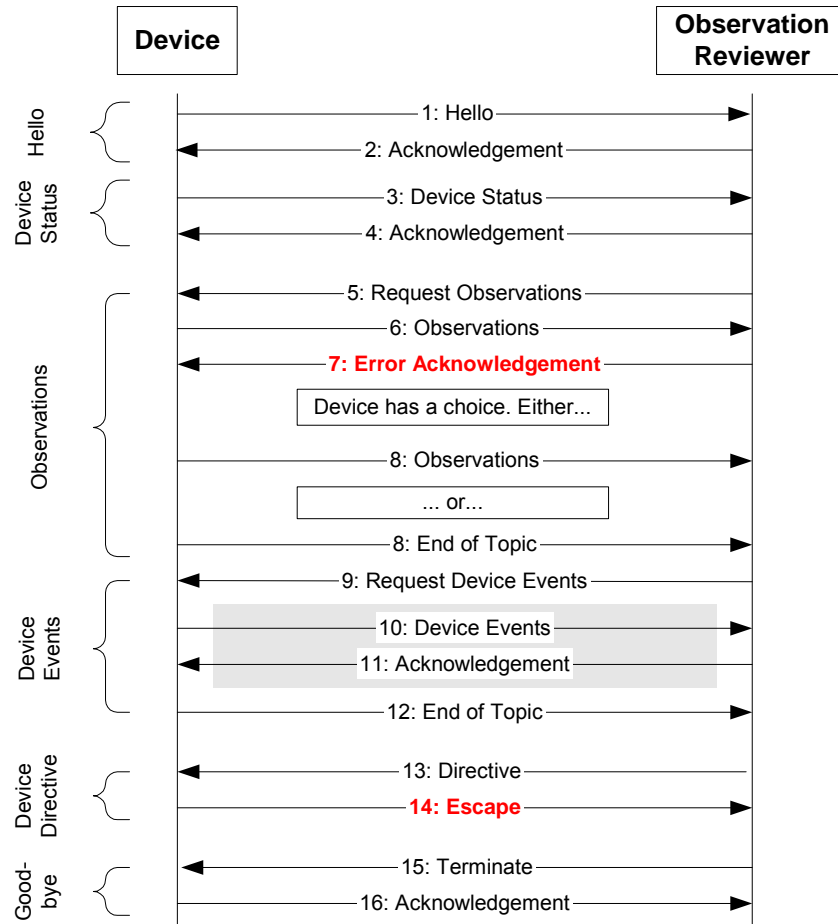

**Figure 29. Example Flow With Error Handling**

The following subsections discuss the use of these messages in more detail.

**4.1.12.1 Error Acknowledgement Message**

Message 7 illustrates an Error Acknowledgement message sent from the Observation Reviewer to the Device. The Observation Reviewer might send this message if the Observations message contained invalid data values, such as a garbled patient identifier.

The behavior of the Device in response to this Error Acknowledgement message is only loosely prescribed by the Device Messaging Layer protocol. The Device may choose one of the three following courses of action:

- the Device may decide that the problem is likely a temporary issue and retry sending the same message (i.e., the contents of 6: Observations);
- the Device may decide to continue trying to send Observations (if there are more to send) by composing and sending a new Observations message with new Observation data (8: Observations); or
- the Device may decide that it does not want to continue trying to transmit Observations and send an End of Topic to conclude the Observation topic (8: End of Topic).

After sending the Error Acknowledgement message, the Observation Reviewer shall continue processing the current topic. In this case, for example, the Observation Reviewer continues to process the Observation Topic messages, pending normal conclusion of the topic by an End of Topic message from the Device.

The expected behavior of the participants in an error condition is left intentionally flexible, to allow for a variety of implementations. However, it is important to note several constraints on the participants' behavior.

- Per the rules for data integrity (Section 3.2), a participant that receives an Error Acknowledgement message must preserve any dynamic data associated with the message that caused the problem.
- When an implementation decides to retry sending the offending message, it should implement a maximum retry protocol to prevent creating an infinite loop.
- In general, Observation Reviewers should be generous regarding messages that they will accept without error. Generally, it is much easier to correct problems at an Observation Reviewer than it is at a Device. For example, for minor formatting problems, it would be best for an Observation Reviewer to accept the message and mark it as an 'exception,' rather than returning an Error to the Device. Later, a point-of-care coordinator could attempt to resolve any problems with the message at the Observation Review station.
- Implementation issues may drive the Device's decision whether to continue trying to send Observations or to end the Observation topic. When only particular observations in a sequence are acknowledged, a Device can only free certain (likely noncontiguous) blocks of the observation store. A Device with a moderately complex memory management scheme might be able to handle the resulting memory fragmentation; however, some Devices might not. These latter Devices would choose to end the Observation Topic after the receipt of the first Error Acknowledgement message. The more complex Devices might decide to continue to send the remaining observations.

#### 4.1.12.2 Escape Message

Message #14 in Figure 29 illustrates an Escape message sent by a Device in response to a Directive message. Escape messages allow a participant to request termination of the current Topic. A participant sends an Escape message whenever it becomes unable to complete the current Topic.

The responsibilities of the participants following an Escape message are straightforward.

The Observation Reviewer: After sending or receiving an Escape, the Observation Reviewer must proceed to the next topic in the dialog. In this example, the next topic is the Terminate topic, so the Observation Reviewer sends a Terminate message to the Device.

The Device: After sending or receiving an Escape, the Device must return to a state that waits for additional commands from the Observation Reviewer.

It is important to note two issues regarding the particular example shown in Figure 29:

- This example illustrates only one possible use for an Escape message. Devices and Observation Reviewers may use Escape messages to terminate any Topic they are not prepared to handle.
- If the Device in this example were able to process Directives but received a Directive in message #13 that it didn't understand, it shall send an Error Acknowledgement message with an **error\_detail\_cd** of 200 (see Table 14). This reply indicates that the particular Directive operation is not understood or supported by the Device.

## 4.2 Continuous Mode

The Continuous Mode of the Basic Profile supports the needs of Devices that are persistently connected to an Observation Reviewer.<sup>ee</sup> This mode extends the Basic Profile in two major respects:

- The Continuous Mode allows Devices to link to Observation Reviewers 'forever.'<sup>ff</sup>
- In the Continuous Mode, the Device provides 'unsolicited'<sup>gg</sup> Observation and Device Event messages, which the Observation Reviewer then acknowledges.

This mode uses many of the same conventions, messages, and structures as the Basic message flow. The Continuous mode begins when the Observation Reviewer sends a special Directive message, Start Continuous, to the Device. After the Device acknowledges this Directive, the message flow enters the Continuous mode.

Messaging in the Continuous mode is driven primarily by the Device. The only communications initiated by the Observation Reviewer in this mode are the Keep Alive, Directive, Update List, Terminate, and Vendor-specific messages. Because Observations and Device Events are sent by the Device when convenient, the Request Observations and Request Device Events messages are not needed, and the End of Topic message is used by the Observation Reviewer only when communicating one of the Update List Topics.

<sup>ee</sup> Today, these Devices are wired directly to a LAN/WAN. In the future, this profile will support Devices persistently connected to Observation Reviewers via radio-frequency networks (e.g., Bluetooth<sup>TM</sup> and IEEE 802.11).

<sup>ff</sup> Barring communications link failures and shutdowns due to routine maintenance.

<sup>gg</sup> In the Basic Profile, the Observation Reviewer sends a Request message to prompt the Device to send Observations and Events. In the Continuous mode extension, the Device does not wait for a Request message, instead sending *unsolicited* Observation and Event messages to the Observation Reviewer.



4.2.1 Continuous Mode Message Flow

Figure 30 illustrates an error-free Continuous mode message flow.

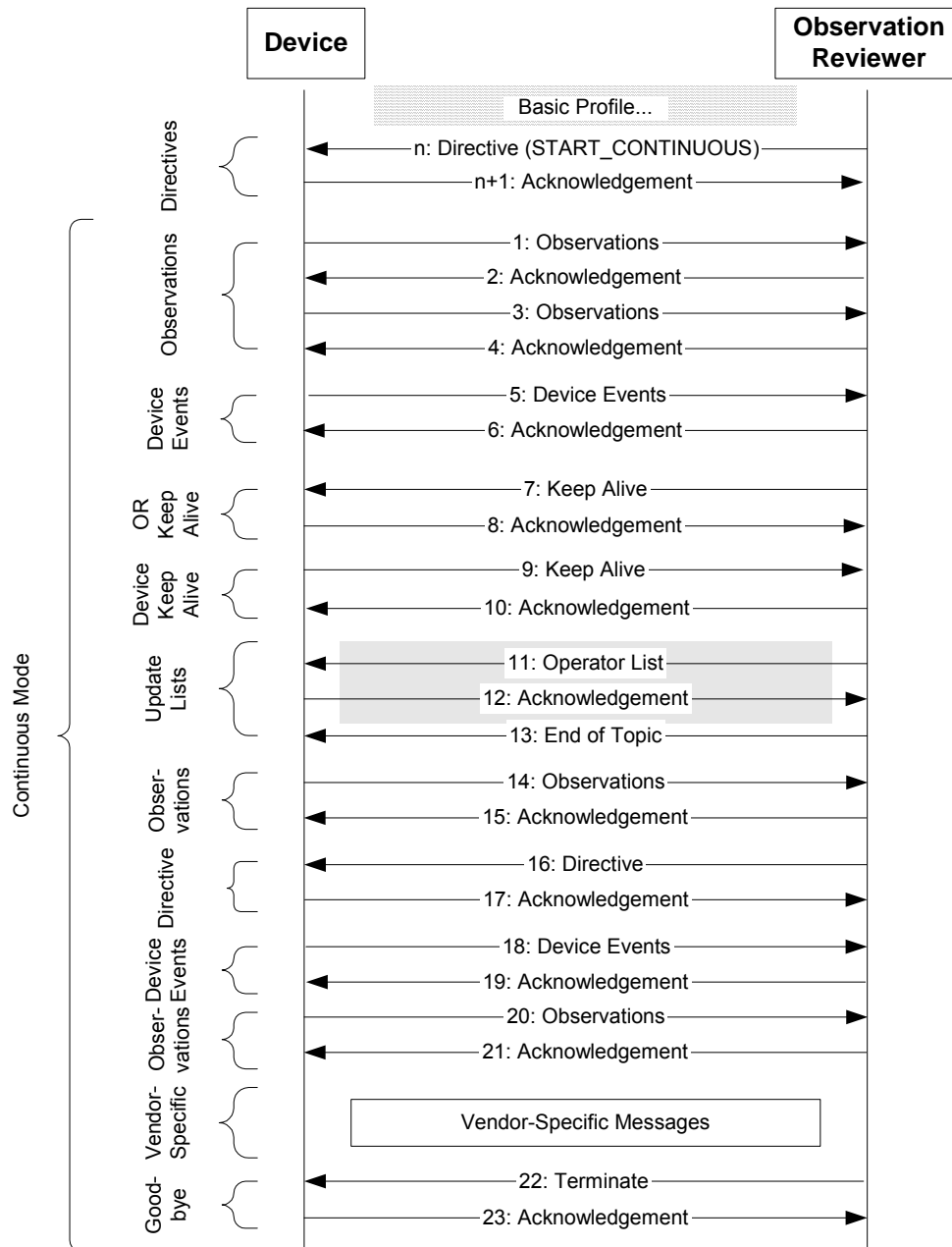

Figure 30. Ideal Continuous Mode Message Flow

Note that the messages in this figure are shown with constant vertical (temporal) spacing only for presentation purposes. In fact, while some messages may be communicated in quick order with little intermessage delay, long delays may occur between other messages in the sequence. For example, a long period of time (the Keep Alive period) must elapse between message #8 (an Acknowledgement from the Observation Reviewer) and message #9 (a Keep Alive from the Device to the Observation Reviewer).

#### 4.2.2 Continuous Mode Startup

The Observation Reviewer uses a special Directive, Start Continuous, to launch the Continuous mode. If the Device does not want to transition to the Continuous mode, it will reply with an Escape message. Otherwise, the Device will respond with a positive Acknowledgement and the Continuous mode will begin.

#### 4.2.3 Observations

Before starting the Continuous Mode, the Observation Reviewer shall request any untransmitted Observations that the Device reported in the Device Status message (Section 4.1.5). Once in the Continuous mode, the Device reports new results in Observation messages, sent at its convenience. The Observation Reviewer sends an Acknowledgement message in reply to each Observation message successfully processed. Once the Device receives a positive Acknowledgement for a particular Observation message, it may<sup>hh</sup> delete the associated results from its memory store.

If the Observation Reviewer does not reply to an Observation message with a positive Acknowledgement, the Device must retain the associated result data. The Device may attempt to resend the problematic observations later. However, the Device should implement logic (e.g., a maximum retry scheme) to prevent an infinite loop occurring with observation messages that the Observation Reviewer never accepts.

Because observations are not formally requested by the Observation Reviewer, the Device does not use an End of Topic message to indicate when all new observations have been transmitted. The Observation Topic in the Continuous mode consists simply of an Observation message paired with an Acknowledgement.

#### 4.2.4 Device Events

A Device may send unsolicited Device Event messages whenever it has new events to report.

The Observation Reviewer must confirm the successful receipt of each Device Event message with a positive Acknowledgement message.

Error reporting and handling proceeds in a manner analogous to that for Observations (Section 4.2.3).

As in the case of Observation Topic, the Device Event Topic in the Continuous mode does not include an End of Topic message. Each paired Device Event and Acknowledgement message can be thought of as a single, self-contained Topic.

#### 4.2.5 Update Lists

The Observation Reviewer may use the Operator List and Patient List messages (hereafter referred to as Update List messages) to update lists stored on the Device.

In the Continuous mode, the Observation Reviewer may send an Update List message to the Device at any time that meets both of the following criteria:

---

<sup>hh</sup> This specification does not require Devices to delete data once its transmission has been acknowledged. Vendors are free to implement appropriate memory management schemes (i.e., any scheme that preserves data until it has been acknowledged).

- The Observation Reviewer is not waiting for a response from the Device. For example, the Observation Reviewer must wait until it receives an Acknowledgement message from the Device in response to a Keep Alive or a Directive before sending an Update List message.
- The Device is not waiting for a response from the Observation Reviewer. For example, if a Device has just sent a Status message, the Observation Reviewer must send an Acknowledgement before sending an Update List message.

The Device shall confirm receipt of each Update List message with an Acknowledgement message. Error notification and handling is the same as described Section 4.1.7, Operator and Patient Lists.

#### 4.2.6 Keep Alive Messages

Keep Alive messages are handled exactly as described in Section 3.5. Note that the Device may also use a Device Status message to perform the Keep Alive function.

#### 4.2.7 Directive Messages

The Observation Reviewer may send a Directive message at any time that it could send an Update List message (Section 4.2.5).

The Device will acknowledge the message upon receipt. Note that the Device may take some time after receipt and acknowledgement of a Directive to actually perform the specified operation.

If a Device already in the Continuous Mode receives a START\_CONTINUOUS Directive, it shall reply with a positive Acknowledgement message.

#### 4.2.8 Vendor-specific Messages

Vendor-specific messaging is handled exactly as described in the Basic Profile, Section 4.1.10.

#### 4.2.9 Conversation Termination

The Continuous mode defines a Conversation Termination protocol to handle situations in which either participant needs to terminate the Conversation. For example, if the Device or Observation Reviewer was about to be taken off-line for servicing it would need to signal that the Conversation should end. In such cases, a participant would send a Terminate message. The recipient shall respond with a positive Acknowledgement message, indicating that the lower-level transport may be torn down. Both participants in a Continuous mode Conversation must be prepared to accept and process Terminate messages at any time.

### 4.3 Asynchronous Observation Acknowledgements

An optional communication optimization termed 'asynchronous acknowledgement' is defined for Devices. This optimization approach is summarized as follows:

During the Observations Topic, a Device is permitted to send Observations messages, up to and including the terminating End of Topic, without waiting for Acknowledgements from the Observation Reviewer.

This optimization is designed to maintain high communication throughput while providing an individual acknowledgement of each Observations message. This optimization requires a transport layer that

provides end-to-end flow control (such as that provided by TinyTP and TCP/IP) that allows the Observation Recipient to moderate the transmission if it cannot accept data from the Device.

This ‘asynchronous acknowledgement’ optimization is fully specified in Annex B, Asynchronous Observation Acknowledgements.

#### 4.4 Minimum Device Messaging Layer Compliance Requirements

The Basic Profile specifies a minimum set of Conversation Topics that Devices and Observation Reviewers must support. These Topics are:

- Hello
- Device Status
- Observations
- Termination

Consequently, Devices and Observation Reviewers must be able to handle at least the following messages:

**Table 7. Messages for Minimal Compliance**

| DEVICE SEND,<br>OBSERVATION REVIEWER RECEIVE | DEVICE RECEIVE,<br>OBSERVATION REVIEWER SEND |
|--|--|
| Hello [HEL.R01]                              | Request Observations [REQ.R01]               |
| Device Status [DST.R01]                      | Terminate [END.R01]                          |
| Observations [OBS.R01]                       | Acknowledgement (Positive, Error) [ACK.R01]  |
| End of Topic [EOT.R01]                       | Escape [ESC.R01]                             |
| Terminate [END.R01]                          |  |
| Acknowledgement (Positive, Error) [ACK.R01]  |  |
| Escape [ESC.R01]                             |  |

## 5 Information Model

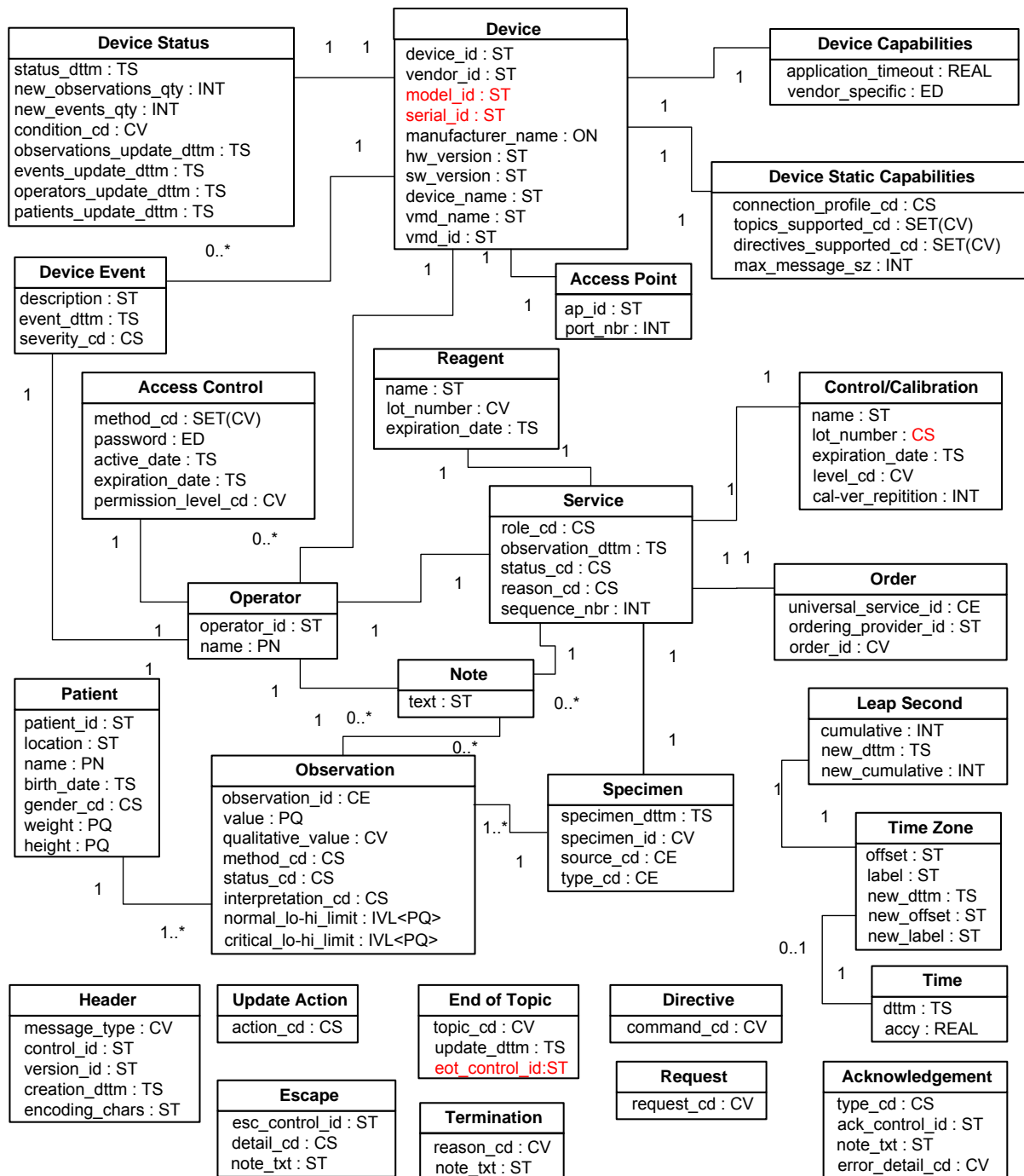

Figure 31. Device Interface Messaging Layer Information Model

The objects in this model are described in more detail in the following subsections, arranged alphabetically.

## 5.1 Access Control Object

The Access Control object is a component of the Operator List message (see Section 6.11).

**Table 8. Access Control Object Attributes**

| ATTRIBUTE           | TYPE                   | FORMAT   | DESCRIPTION   |
|---------------------|------------------------|----------|---|
| method_cd           | SET (CV) <sup>ii</sup> | Table 9  | The Device's analytic method(s) that should be restricted by the information in this object. Vendors that extend this table should use the code system component of the CV data type to ensure unique values. |
| password            | ED                     |          | This user's password to access the described method. This field is of type ED to allow communication of encrypted passwords.  |
| active_date         | TS                     |          | The date after which this certificate is valid.   |
| expiration_date     | TS                     |          | The date on which this certificate expires.   |
| permission_level_cd | CV                     | Table 10 | Code indicating what operations the user is allowed to perform. A default set of codes is provided in Table 10. Vendors may extend this set, following the rules for the CV data type.                        |

**Table 9. Access Control Method Code Values**

| CODE | VALUE       | DESCRIPTION  |
|------|-------------|--|
| ALL  | All methods | The operator is granted permission to use all methods. |

**Table 10. Access Control Permission Level Values**

| CODE | VALUE        | DESCRIPTION  |
|------|--------------|--|
| 1    | SUPERVISOR   | Full Access to system.   |
| 2    | KEY OPERATOR | Access to everything except to add new user and change access level.                             |
| 3    | TRUSTED USER | Same as USER except can also accept failed QC.   |
| 4    | USER         | Can operate system to produce test results.  |
| 5    | SERVICE      | Allows access to special service diagnostics and configuration modes.                            |
| 6    | TRAINING     | Can operate system but not report results. QC if run is not added to QC statistics calculations. |

## 5.2 Access Point Object

The Access Point object is a component of the Hello message (see Section 6.8).

**Table 11. Access Point Object Attributes**

| ATTRIBUTE | TYPE | FORMAT             | DESCRIPTION   |
|-----------|------|--------------------|---|
| ap_id     | ST   | IEEE EUI-64 format | The unique address of the access point.                         |
| port_nbr  | INT  | 0..n               | The port number of the access point used to connect the Device. |

<sup>ii</sup> Refer to Section 8.13 for a description of how the SET construct is implemented using XML.

### 5.3 Acknowledgement Object

The Acknowledgement object is a component of the Acknowledgement message (see Section 6.2).

**Table 12. Acknowledgement Object Attributes**

| ATTRIBUTE       | TYPE | FORMAT   | DESCRIPTION   |
|-----------------|------|----------|---|
| type_cd         | CS   | Table 13 | A code indicating whether the associated message was accepted, was in error, or was rejected. |
| ack_control_id  | ST   |          | The control ID of the message sent that this message is in acknowledgement of.                |
| note_txt        | ST   |          | Text describing the error condition. May be logged or presented to user.                      |
| error_detail_cd | CV   | Table 14 | A code indicating the type of error that occurred.  |

**Table 13. Acknowledgement Type Code Values<sup>ij</sup>**

| CODE | VALUE              | DESCRIPTION  |
|------|--------------------|--|
| AA   | Application Accept | The receiver assumes responsibility for the message contents.  |
| AE   | Application Error  | The receiver encountered an error processing the message. See error_detail_cd for more information (Table 14). |

**Table 14. Error Acknowledgement Detail Code Values**

| CODE           | VALUE                      | DESCRIPTION/COMMENT   |
|----------------|----------------------------|---|
| <b>SUCCESS</b> |                            |   |
| 0              | Message accepted           | Success. Optional, as the AA conveys success.   |
| <b>ERRORS</b>  |                            |   |
| 100            | Object sequence error      | The message objects were not in the proper order, or required objects are missing.  |
| 101            | Required field missing     | A required field is missing from a segment.   |
| 102            | Data type error            | A message element is not of the type expected: e.g., a field that the receiver expects to be of type PQ is actually of type CV in the current message.                                  |
| 103            | Table value not found      | A coded field (i.e., a field of data type CS, CV, CE) was compared against the corresponding table, and no match was found.   |
| 200            | Unsupported field value    | The field contained data of the wrong field value, e.g., a PQ field contained a value without units, or a Device supplied a <b>device_id</b> value that is not recognized or supported. |
| 201            | Unsupported version id     | The Message version identifier ( <b>HDR.version_id</b> ) is not supported.  |
| 202            | Application internal error | A catch-all for internal errors not explicitly covered by other codes.  |

### 5.4 Control/Calibration Object

The Control/Calibration object is a component of the Observations message (see Section 6.10).

<sup>ij</sup> Note that this table is a subset of the complete HL7 Acknowledgement code set described in *HL7 Table 0008 - Acknowledgement code*. This table includes only a subset of the Original Acknowledgement codes, as Devices are not expected to support the Enhanced Acknowledgement protocol.

The Control/Calibration object contains identification information for Calibration tests, Quality Control tests, Proficiency tests, and Calibration Verification tests. This object’s role is determined by the value of the **Service.role\_cd** field (see Section 5.21) in the Observation message (see Section 6.10).

Because this object has several roles, the individual fields have descriptions that vary based on whether the object is reporting a QC, Proficiency, or Calibration-verification result. The following tables (see Table 15 and Table 16) describe the format and meaning of this object’s attributes for each role.

**Table 15. Control/Calibration Object Attributes**

| ATTRIBUTE          | TYPE | FORMAT | DESCRIPTION |
|--------------------|------|--------|-------------|
| name               | ST   | Vendor | Table 16    |
| lot_number         | CS   | Vendor | Table 16    |
| expiration_date    | TS   |        | Table 16    |
| level_cd           | CV   | Vendor | Table 16    |
| cal-ver_repetition | INT  |        | Table 16    |

**Table 16. Control/Calibration Field Descriptions by Role**

| ATTRIBUTE          | QC  | PROFICIENCY    | CALIBRATION                      | CALIBRATION VERIFICATION  |
|--------------------|---|----------------|----------------------------------|---|
| name               | Vendor  | Vendor         | Vendor<br>(e.g., '1 pt', '2 pt') | Vendor  |
| lot_number         | The (vendor-specific) lot number of the control/calibration material. |                |                                  |   |
| expiration_date    | The expiration date for the reagent used for this test.               |                |                                  |   |
| level_cd           | The level for this QC test (e.g., 'hi', 'lo', '1', '2')               | Not Applicable | Not Applicable                   | The level for this calibration verification test (e.g., 0,1,2,3...n).   |
| cal-ver_repetition | Not Applicable  | Not Applicable | Not Applicable                   | If tests within a linearity sequence are repeated at a given level, this field indicates the repetition count for this particular test. |

### 5.5 Device Object

The Device Object is a component of the Hello message (see Section 6.8).



**Table 17. Device Object Attributes**

| ATTRIBUTE         | TYPE | FORMAT | DESCRIPTION  |
|-------------------|------|--------|--|
| device_id         | ST   | EUI-64 | IEEE EUI-64 string-encoded Device identifier.  |
| vendor_id         | ST   | Vendor | Vendor-specific unique identifier. Example: <vendor name>. Note (1)  |
| model_id          | ST   | Vendor | Vendor-specific unique model identifier. Example: <model>  |
| serial_id         | ST   | Vendor | Vendor-specific unique serial identifier. Example: <serial number>   |
| manufacturer_name | ON   | Vendor | The manufacturer's corporate name. Note (2)  |
| hw_version        | ST   | Vendor | The version number for the Device hardware.  |
| sw_version        | ST   | Vendor | The software version number(s) for the Device.   |
| device_name       | ST   |        | A convenient name for the Device (e.g., 'ICU-4').  |
| vmd_name          | ST   |        | Text, noncoded name of "virtual medical Device." This to support a Device with multiple Device capability ("lab on a chip").             |
| vmd_id            | ST   |        | Institutionally unique, coded ID for Virtual Medical Device. This to support a Device with multiple Device capability ("lab on a chip"). |

- (1) If a vendor identifier is supplied in the **vendor\_id** field, it should be selected from the list of registered identifiers defined in Appendix F — Vendor Codes.
- (2) The **manufacturer\_name** field may contain a 'long' version of the manufacturer referenced in the **vendor\_id** field. As a fictional example, while the **vendor\_id** field would contain the 'BCHMX' code, the **manufacturer\_name** field would contain 'Biochemtronix.'

## 5.6 Device Capabilities Object

The Device Capabilities object is a component of the Hello message (see Section 6.8).

**Table 18. Device Capabilities Object Attributes**

| ATTRIBUTE           | TYPE | FORMAT  | DESCRIPTION  |
|---------------------|------|---------|--|
| application_timeout | REAL | Seconds | Application-level timeout this Device uses (specified in seconds). |
| vendor_specific     | ED   | Vendor  | Proprietary device Topic capabilities.                             |

## 5.7 Device Static Capabilities Object

The Device Static Capabilities object is a component of the Hello message (see Section 8).

This object describes 'fixed' attributes of the Device: i.e., attributes and capabilities that do not ordinarily vary between Conversations.

**Table 19. Device Static Capabilities Object Attributes**

| ATTRIBUTE               | TYPE      | FORMAT   | DESCRIPTION   |
|-------------------------|-----------|----------|---|
| connection_profile_cd   | CS        | Table 20 | CIC messaging profile the Device supports.                      |
| topics_supported_cd     | SET( CV ) | Table 21 | The message topics (beyond the minimum) supported.              |
| directives_supported_cd | SET( CV ) | Table 57 | The Directive commands the Device supports. Note (1).           |
| max_message_sz          | INT       |          | The maximum size message (in bytes) that the Device can handle. |

(1) The predefined values for this field may be found in the ‘Code’ column of Table 57. Vendors may define new Directives (see Section 4.1.10.1). Each vendor-specific Directive shall be qualified with the unique vendor identifier (see Appendix F) and should define a unique identification code that will be reported in this field.

**Table 20. Connection Profile Values**

| CODE | VALUE                        | DESCRIPTION  |
|------|------------------------------|--|
| CS   | Continuous Synchronous       | Uses continuous-connection (synchronous) message flow. |
| SA   | Synchronous Acknowledgement  | Uses the synchronous acknowledgement message flow.     |
| AA   | Asynchronous Acknowledgement | Uses the asynchronous acknowledgement message flow.    |

**Table 21. Topics Supported Values**

| CODE     | VALUE                     | DESCRIPTION   |
|----------|---------------------------|---|
| D_EV     | Device Events             | Device supports Device Events topic.                |
| DTV      | Directives                | Device supports Directives.                         |
| OP_LST   | Operator List             | Device supports Operator List topic.                |
| OP_LST_I | Incremental Operator List | Device supports Incremental Operator List topic.    |
|          |                           |   |
| PT_LST   | Patient List              | Device supports the Patient List topic.             |
| PT_LST_I | Patient List Incremental  | Device supports the Incremental Patient List topic. |

## 5.8 Device Event Object

The Device Event object is a component of the Device Events message (see Section 6.3).

**Table 22. Device Event Object Attributes**

| ATTRIBUTE   | TYPE | FORMAT   | DESCRIPTION  |
|-------------|------|----------|--|
| description | ST   | Vendor   | Free text description of the event.                  |
| event_dttm  | TS   |          | Time the event occurred.                             |
| severity_cd | CS   | Table 23 | An indication of the level of operator intervention. |

**Table 23. Severity Level Field Values**

| CODE | VALUE    | MEANING   | EXAMPLE               |
|------|----------|---|-----------------------|
| C    | Critical | A critical event requires operator intervention to restore normal operation of this Device.                             | "Internal Error #304" |
| N    | Note     | Indicates information about the normal operation of the Device.   | "Oven Door Open"      |
| W    | Warning  | Indicates that the Device has encountered a situation that may affect the normal operation of the Device in the future. | "Battery Low"         |

## 5.9 Device Status Object

The Device Status object is a component of the Device Status message (see Section 6.4).

**Table 24. Device Status Object Attributes**

| ATTRIBUTE                | TYPE | FORMAT   | DESCRIPTION   |
|--------------------------|------|----------|---|
| status_dttm              | TS   |          | The time that this status information was observed.   |
| new_observations_qty     | INT  | 0...n    | The number of observations the Device has to report.  |
| new_events_qty           | INT  | 0...n    | The number of events since the last sync.   |
| condition_cd             | CV   | Table 25 | The current level of readiness of the Device. Table 25 defines a default set of values. Vendors that extend this table shall use the code system component of the CV data type to ensure unique values. |
| observations_update_dttm | TS   |          | The time the Device last uploaded observations (i.e., successfully completed the Observations Topic).   |
| events_update_dttm       | TS   |          | The time the Device last successfully completed the Device Events Topic.  |
| operators_update_dttm    | TS   |          | The time the Device last successfully completed the Operator List Topic.  |
| patients_update_dttm     | TS   |          | The time the Device last successfully completed the Patient List Topic.   |

**Table 25. Device Condition Field Values**

| CODE | VALUE        | DESCRIPTION  |
|------|--------------|--|
| B    | Busy         | The Device is in the process of running a test or is otherwise occupied and unable to start a new test.                        |
| L    | Locked       | The Device has been locked so that it cannot be used to run tests (i.e., by a Device directive from the Observation Reviewer). |
| P    | Partial Lock | One or more analytic tests have been disabled for this Device (i.e., by a Device directive from the Observation Reviewer).     |
| R    | Ready        | The Device is ready to process tests.  |
| S    | Standby      | The Device is capable of running a new test once it has been awakened from this 'idle' mode.                                   |

## 5.10 Directive Object

The Directive object is a component of the Directive message (see Section 6.5).

**Table 26. Directive Object Attributes**

| ATTRIBUTE  | TYPE | FORMAT   | DESCRIPTION   |
|------------|------|----------|---|
| command_cd | CV   | Note (1) | A coded value representing a command for the Device to perform. |

(1) The values for this coded field may be found in the 'Code' column of Table 57.

## 5.11 End of Topic Object

The End of Topic object is used in the End of Topic message (see Section 6.6).

**Table 27. End of Topic Object Attributes**

| ATTRIBUTE      | TYPE | FORMAT   | DESCRIPTION  |
|----------------|------|----------|--|
| topic_cd       | CV   | Table 28 | A code for the Topic that has just been completed. Vendors may extend this list to accommodate vendor-specific message Topics, using the code system attribute of the CV data type to ensure uniqueness. |
| update_dttm    | TS   |          | A time stamp provided to indicate the date and time that the current list was valid.   |
| eot_control_id | ST   |          | A message control code from the header of the message to which this EOT is a response.   |

**Table 28. End of Topic Code Values**

| CODE | MEANING                        |
|------|--------------------------------|
| EVS  | End of the Device Events Topic |
| OBS  | End of the Observations Topic  |
| OPL  | End of the Operator List Topic |
| PTL  | End of the Patient List Topic  |

## 5.12 Escape Object

The Escape object is a component of the Escape message (see Section 6.7).

**Table 29. Escape Object Attributes**

| ATTRIBUTE      | TYPE | FORMAT   | DESCRIPTION   |
|----------------|------|----------|---|
| esc_control_id | ST   |          | The message control code from the Header of the message to which this Escape is a response. |
| detail_cd      | CS   | Table 30 | A code indicating the reason for the Escape message.  |
| note_txt       | ST   |          | Further explanatory text that may be logged or displayed by the Receiver.                   |

**Table 30. Escape Detail Code Values**

| CODE | MEANING                            |
|------|------------------------------------|
| OTH  | Other reason                       |
| TOP  | Unsupported topic                  |
| CNC  | Cannot complete Topic at this time |

### 5.13 Header Object

The Header object is a mandatory component of every message.

**Table 31. Header Object Attributes**

| ATTRIBUTE      | TYPE | FORMAT   | DESCRIPTION   |
|----------------|------|----------|---|
| message_type   | CV   |          | A code made up of the message name and trigger value. Values for this field may be found in the descriptions of each message in Section 6. For vendor-specific messages, specific rules apply (see Sections 6.5.3 and 7.2). |
| control_id     | ST   |          | A string guaranteed to uniquely identify this message throughout the conversation.  |
| version_id     | ST   |          | Set to "POCT1" for all messages that adhere to this standard.   |
| creation_dttm  | TS   |          | The Sender's time when the message was sent.  |
| encoding_chars | ST   | Table 32 | A list of special characters used to encode components of string fields. Note (1).  |

(1) This field takes the form of a four-character string. The default value for the string is “^~\&.” The format and meaning of this string is borrowed from *HL7 v2.4 Section 2.8 – Message Delimiters*.

In general, the use of subfield encoding is deprecated in the Device Messaging Layer.

**Table 32. Format of Header Encoding Characters String**

| POSITION | DEFAULT | USAGE  |
|----------|---------|--|
| 1        | ^       | Separates adjacent components of data fields.    |
| 2        | ~       | Separates multiple occurrences of a field.       |
| 3        | \       | Escape character.                                |
| 4        | &       | Separates adjacent subcomponents of data fields. |

### 5.14 Note Object

The Note object is used in several message models, including Observations and Operator List.

**Table 33. Note Object Attributes**

| ATTRIBUTE | TYPE | FORMAT | DESCRIPTION   |
|-----------|------|--------|---|
| text      | ST   |        | A text string. The string's contents are dependent on the context in which the Note object is used. |

## 5.15 Observation Object

The Observation object is a component of the Observations message (see Section 6.10).

**Table 34. Observation Object Attributes**

| ATTRIBUTE            | TYPE    | FORMAT         | DESCRIPTION  |
|----------------------|---------|----------------|--|
| observation_id       | CE      | LOINC, local   | The unique identifier for the result. Preferably, this code will come from the LOINC code set; however, local codes may be used. |
| value                | PQ      |                | The observation result, if expressed quantitatively. Notes (1), (3)  |
| qualitative_value    | CV      | Table 35       | The observation result, if expressed qualitatively. Notes (2), (3)   |
| method_cd            | CS      | Table 36       | How was this value determined? Measured? Calculated?   |
| status_cd            | CS      | Table 37       | e.g., Accepted, Rejected, etc.   |
| interpretation_cd    | CS      | Table 38       | Commonly referred to as 'abnormal flags.' Note (3)   |
| normal_lo-hi_limit   | IVL<PQ> | Section 5.15.1 | The low and high limit range for a normal test.  |
| critical_lo-hi_limit | IVL<PQ> | Section 5.15.1 | The low and high limit range outside which clinical review is required.  |

- (1) The **value** attribute contains a quantitative value (i.e., a numerical value with units).
- (2) If the result value is expressed qualitatively, the **qualitative\_value** field must be supplied instead of the **value** field.

Table 35 contains predefined values for this field. Vendors may extend the codes in this table if necessary; however, the given codes should be used where appropriate.

- (3) Every Observation object instance must contain either a **value** or a **qualitative\_value** field. The **interpretation\_cd** field may be used to provide additional information about the quantitative or qualitative value. For example, to communicate a measurement greater than the Device's maximum valid range of 600 mg/dL, the Device would provide a **value** field containing 600 mg/dL and set the **interpretation\_cd** field to '>' (see Table 38). Thus, an Observation Reviewer must always examine three fields (**value**, **qualitative\_value**, and **interpretation\_cd**) to correctly interpret the observation that the Device is reporting.

**Table 35. Observation Qualitative Value Field Values**

| CODE | DESCRIPTION   |
|------|---|
| L    | Low   |
| H    | High  |
| LL   | Very low  |
| HH   | Very high   |
| N    | Normal  |
| A    | Abnormal  |
| AA   | Very abnormal (analogous to panic limits for numeric units) |
| U    | Significant change up                                       |
| D    | Significant change down                                     |
| B    | Better—use when direction not relevant                      |
| W    | Worse—use when direction not relevant                       |

**Table 36. Observation Method Code Field Values**

| CODE | MEANING    | DESCRIPTION                                   |
|------|------------|---|
| C    | Calculated | The value was calculated.                     |
| D    | Default    | The value is a default value.                 |
| E    | Estimated  | The value is estimated.                       |
| I    | Input      | The value was externally input to the Device. |
| M    | Measured   | The value was measured on this Device.        |
| U    | Unknown    | It is unknown from where the value came.      |

**Table 37. Observation Status Code Field Values**

| CODE | MEANING   | DESCRIPTION                                |
|------|-----------|--|
| A    | Accepted  | The result was accepted.                   |
| D    | Discarded | The result was discarded. <sup>kk</sup>    |
| U    | Unknown   | The status of the result is not known.     |
| X    | Rejected  | The result was not accepted. <sup>ll</sup> |

<sup>kk</sup> This code likely only applies to control/calibration results, as institutional policy usually prevents discarding patient test results.

<sup>ll</sup> This code likely only applies to control/calibration results, as institutional policy usually prevents rejecting patient test results.

**Table 38. Observation Interpretation Code Field Values<sup>mmm</sup>**

| VALUE | DESCRIPTION   |
|-------|---|
| L     | Below low normal.   |
| H     | Above high normal.  |
| LL    | Below lower panic limits.   |
| HH    | Above upper panic limits.   |
| <     | Below absolute low-off instrument scale.  |
| >     | Above absolute high-off instrument scale.   |
| N     | Normal (applies to nonnumeric results).   |
| A     | Abnormal (applies to nonnumeric results).   |
| AA    | Very abnormal (applies to nonnumeric units, analogous to panic limits for numeric units). |
| null  | No range defined, or normal ranges don't apply.   |
| U     | Significant change up.  |
| D     | Significant change down.  |
| B     | Better—use when direction not relevant.   |
| W     | Worse—use when direction not relevant.  |

### 5.15.1 Limit Encoding Rules

The **normal\_lo-hi\_limit** and **critical\_lo-hi\_limit** attributes contain the high and low value limits for the normal and critical ranges of a test. The Physical Quantity Interval (IVL<PQ>) data type, using the ‘interval’ form for the literal value, is used to encode these limit ranges. The interval form uses a semi-colon to separate the low and high limits, and square brackets to indicate whether the boundary values are open or closed. POCT1 requires that both the low- and high-boundary values be provided. The following examples illustrate the possible ranges this form can express:

- If both lower (lo) and upper (hi) limit are known:

[ 70 ; 105 ]                      ( 70 <= x <= 105 )

- If only the lower limit is known:

[ 70 ; +inf[                      ( 70 <= x < +∞ )

- If only the upper limit is known:

] -inf ; 105 ]                      ( -∞ < x <= 105 )

See Section 8.12 for more details concerning POCT1’s use of the IVL<PQ> data type.

### 5.16 Operator Object

The Operator object is a component of both the Observations (see Section 6.10) and the Operator List (see Section 6.11) messages.

<sup>mmm</sup> Referenced from HL7 v2.4, Chapter 7 - *User-defined Table 0078 - Abnormal flags*.



**Table 39. Operator Object Attributes**

| ATTRIBUTE   | TYPE | FORMAT   | DESCRIPTION   |
|-------------|------|----------|---|
| operator_id | ST   | Table 40 | The unique identifier for the operator of the Device. |
| Name        | PN   |          | The name of the operator who performed the test.      |

Table 40 predefines several common **Operator.operator\_id** field values.

**Table 40. Predefined Operator ID Values**

| CODE   | DESCRIPTION   |
|--------|---|
| AUTO   | The event was caused by an automatic, internal process. |
| REMOTE | An unknown remote user caused the event.                |

## 5.17 Order Object

The Order object is a component of the Observation (see Section 6.10) message.

**Table 41. Order Object Attributes**

| ATTRIBUTE            | TYPE | FORMAT         | DESCRIPTION   |
|----------------------|------|----------------|---|
| universal_service_id | CE   | LOINC or local | Identifies the service provided by these observations. LOINC is the preferred encoding scheme; however, some institutions mandate the use of local codes. The CE data type allows transmission of both encodings, if appropriate. |
| ordering_provider_id | ST   | Local          | An identifier that uniquely identifies the provider who ordered this service.   |
| order_id             | CV   | Local          | An identifier that uniquely identifies this service instance. This field may contain an order id, accession number, or other such identifier.   |

## 5.18 Patient Object

The Patient object is a component of both the Observation (see Section 6.10) and the Patient List (see Section 6.12) messages.

**Table 42. Patient Object Attributes**

| ATTRIBUTE  | TYPE | FORMAT   | DESCRIPTION   |
|------------|------|----------|---|
| patient_id | ST   |          | The unique identifier for the Patient — Note (1).                         |
| location   | ST   |          | The location of the Patient when the specimen was drawn (e.g., 'Bed-42'). |
| name       | PN   |          | The name of the patient.  |
| birth_date | TS   |          | The patient's date of birth.  |
| gender_cd  | CS   | Table 43 | The patient's gender.   |
| weight     | PQ   |          | The patient's weight.   |
| height     | PQ   |          | The patient's height.   |

(1) Typically, the **patient\_id** value will be a medical record number (MRN). The value of this field should be sufficiently unique to positively identify this patient within the scope that this device is used.

**Table 43. Patient Gender Field Values**

| CODE | MEANING        |
|------|----------------|
| F    | Female         |
| M    | Male           |
| O    | Other          |
| U    | Unknown        |
| A    | Ambiguous      |
| N    | Not applicable |

### 5.19 Reagent Object

The Reagent object is a component of the Observations message (see Section 6.10).

**Table 44. Reagent Object Attributes**

| ATTRIBUTE       | TYPE | FORMAT | DESCRIPTION  |
|-----------------|------|--------|--|
| name            | ST   | Vendor | The manufacturer's name for the reagent (e.g., 'Chem 7+'). |
| lot_number      | CS   | Vendor | The lot number of the reagent used.                        |
| expiration_date | TS   |        | The date past which the reagent should not be used.        |

### 5.20 Request Object

The Request object is a component of the Request messages (see Section 6.13).

| ATTRIBUTE  | TYPE | FORMAT   | DESCRIPTION   |
|------------|------|----------|---|
| request_cd | CV   | Table 45 | A code denoting the information requested — Note (1). |

- (1) The **request\_cd** field is a CV data type to allow vendors to extend the request message structure to accommodate vendor-specific messaging needs.

**Table 45. Request Message Type Codes**

| CODE | CIC MESSAGE           |
|------|-----------------------|
| ROBS | Request Observations  |
| RDEV | Request Device Events |

### 5.21 Service Object

The Service object is a component of the Observations message (see Section 6.10).

**Table 46. Service Object Attributes**

| ATTRIBUTE        | TYPE | FORMAT   | DESCRIPTION   |
|------------------|------|----------|---|
| role_cd          | CS   | Table 47 | Is this a patient test, a QC test, Calibration test, etc.?  |
| Observation_dttm | TS   |          | The time the observation (test) was performed.  |
| status_cd        | CS   | Table 48 | Was this test performed normally or under 'override' conditions?  |
| reason_cd        | CS   | Table 49 | Are these observations 'original,' re-sent, edited?   |
| sequence_nbr     | INT  |          | An optional number to indicate the position of this service in a historical list of services performed by this Device. This number is unique only across a single Device, and may wrap (e.g., a 'use counter'). |

**Table 47. Service Role Field Values**

| CODE | MEANING                  | DESCRIPTION   |
|------|--------------------------|---|
| UNK  | Unknown                  | Unknown role for the observation(s).                    |
| OBS  | Observation              | Patient test observation(s).                            |
| LQC  | Liquid QC                | Observation(s) from a liquid quality control test.      |
| EQC  | Electronic QC            | Observation(s) from an electronic quality control test. |
| CVR  | Calibration Verification | Observation(s) from a calibration verification test.    |
| CAL  | Calibration              | Observation(s) from a calibration test.                 |
| PRF  | Proficiency              | Observation(s) from a proficiency test.                 |

**Table 48. Service Status Code Field Values**

| CODE | MEANING  | DESCRIPTION  |
|------|----------|--|
| NRM  | Normal   | <u>Default</u> . This test was performed under normal conditions.  |
| OVR  | Override | This test was performed in an 'override' or 'stat' circumstance. Some normal procedures (e.g., QC) may not have been followed. |
| UNK  | Unknown  | It is not known under what circumstances this test was performed.  |

**Table 49. Service Reason Code Attributes**

| CODE | MEANING | DESCRIPTION   |
|------|---------|---|
| NEW  | New     | <u>Default</u> . This is a new observation.                                   |
| RES  | Resend  | This observation is being re-sent.  |
| EDT  | Edited  | Some fields of this observation have been edited since previous transmission. |

## 5.22 Specimen Object

The Specimen object is a component of the Observations message (see Section 6.10).

**Table 50. Specimen Object Attributes**

| ATTRIBUTE     | TYPE | FORMAT   | DESCRIPTION  |
|---------------|------|----------|--|
| specimen_dttm | TS   |          | Time the specimen was drawn.                       |
| specimen_id   | CV   |          | The code identifying the specimen.                 |
| source_cd     | CE   | Table 51 | Location of the specimen, Arterial, Left Arm, etc. |
| type_cd       | CE   | Table 52 | The type of specimen.                              |

Table 51. Specimen Source Field Values<sup>nm</sup>

| CODE                              | DESCRIPTION             | CODE  | DESCRIPTION              |
|-----------------------------------|-------------------------|-------|--------------------------|
| BE                                | Bilateral Ears          | LVL   | Left Vastus Lateralis    |
| OU                                | Bilateral Eyes          | NB    | Nebulized                |
| BN                                | Bilateral Nares         | PA    | Perianal                 |
| BU                                | Buttock                 | PERIN | Perineal                 |
| CT                                | Chest Tube              | RA    | Right Arm                |
| LA                                | Left Arm                | RAC   | Right Anterior Chest     |
| LAC                               | Left Anterior Chest     | RACF  | Right Antecubital Fossa  |
| LACF                              | Left Antecubital Fossa  | RD    | Right Deltoid            |
| LD                                | Left Deltoid            | RE    | Right Ear                |
| LE                                | Left Ear                | REJ   | Right External Jugular   |
| LEJ                               | Left External Jugular   | OD    | Right Eye                |
| OS                                | Left Eye                | RF    | Right Foot               |
| LF                                | Left Foot               | RG    | Right Gluteus Medius     |
| LG                                | Left Gluteus Medius     | RH    | Right Hand               |
| LH                                | Left Hand               | RIJ   | Right Internal Jugular   |
| LIJ                               | Left Internal Jugular   | RLAQ  | Rt Lower Abd Quadrant    |
| LLAQ                              | Left Lower Abd Quadrant | RLFA  | Right Lower Forearm      |
| LLFA                              | Left Lower Forearm      | RMFA  | Right Mid Forearm        |
| LMFA                              | Left Mid Forearm        | RN    | Right Naris              |
| LN                                | Left Naris              | RPC   | Right Posterior Chest    |
| LPC                               | Left Posterior Chest    | RSC   | Right Subclavian         |
| LSC                               | Left Subclavian         | RT    | Right Thigh              |
| LT                                | Left Thigh              | RUA   | Right Upper Arm          |
| LUA                               | Left Upper Arm          | RUAQ  | Right Upper Abd Quadrant |
| LUAQ                              | Left Upper Abd Quadrant | RUFA  | Right Upper Forearm      |
| LUFA                              | Left Upper Forearm      | RVL   | Right Vastus Lateralis   |
| LVG                               | Left Ventragluteal      | RVG   | Right Ventragluteal      |
| Continued in right-hand column... |                         |       |                          |

<sup>nm</sup> Referenced from HL7 v2.4, Chapter 7 - HL7 Table 0163 - Body site.

**Table 52. Specimen Type Field Values<sup>00</sup>**

| CODE  | DESCRIPTION           |
|-------|-----------------------|
| ABS   | Abscess               |
| AMN   | Amniotic fluid        |
| ASP   | Aspirate              |
| BPH   | Basophils             |
| BIFL  | Bile fluid            |
| BLDA  | Blood arterial        |
| BBL   | Blood bag             |
| BLDC  | Blood capillary       |
| BLMV  | Blood mixed venous    |
| BPU   | Blood product unit    |
| BLDV  | Blood venous          |
| BON   | Bone                  |
| BIRTH | Breath (use EXHLD)    |
| BRO   | Bronchial             |
| BRN   | Burn                  |
| CALC  | Calculus (=Stone)     |
| CDM   | Cardiac muscle        |
| CNL   | Cannula               |
| CTP   | Catheter tip          |
| CSF   | Cerebral spinal fluid |
| CVM   | Cervical mucus        |
| CVX   | Cervix                |
| COL   | Colostrum             |
| BLDCO | Cord blood            |
| CNJT  | Conjunctiva           |
| CUR   | Curettage             |
| CYST  | Cyst                  |
| DIAF  | Dialysis fluid        |
| DOSE  | Dose med or substance |
| DRN   | Drain                 |
| DUFL  | Duodenal fluid        |

| CODE | DESCRIPTION                       |
|------|-----------------------------------|
| MAR  | Marrow                            |
| MEC  | Meconium                          |
| MBLD | Menstrual blood                   |
| MLK  | Milk                              |
| MILK | Breast milk                       |
| NAIL | Nail                              |
| NOS  | Nose (nasal passage)              |
| ORH  | Other                             |
| PAFL | Pancreatic fluid                  |
| PAT  | Patient                           |
| PRT  | Peritoneal fluid /ascites         |
| PLC  | Placenta                          |
| PLAS | Plasma                            |
| PLB  | Plasma bag                        |
| PLR  | Pleural fluid (thoracentesis fld) |
| PMN  | Polymorphonuclear neutrophils     |
| PPP  | Platelet poor plasma              |
| PRP  | Platelet rich plasma              |
| PUS  | Pus                               |
| RT   | Route of medicine                 |
| SAL  | Saliva                            |
| SMN  | Seminal fluid                     |
| SER  | Serum                             |
| SKN  | Skin                              |
| SKM  | Skeletal muscle                   |
| SPRM | Spermatozoa                       |
| SPT  | Sputum                            |
| SPTC | Sputum - coughed                  |
| SPTT | Sputum - tracheal aspirate        |
| STON | Stone (use CALC)                  |
| STL  | Stool = Fecal                     |

<sup>00</sup> Referenced from HL7 v2.4, Chapter 7 - HL7 Table 0070 - Specimen source codes, with the addition of BLMV – Blood mixed venous.

Table 52. (Continued)

| CODE                              | DESCRIPTION            |
|-----------------------------------|------------------------|
| EAR                               | Ear                    |
| EARW                              | Ear wax (cerumen)      |
| ELT                               | Electrode              |
| ENDC                              | Endocardium            |
| ENDM                              | Endometrium            |
| EOS                               | Eosinophils            |
| RBC                               | Erythrocytes           |
| EYE                               | Eye                    |
| EXG                               | Exhaled gas (=breath)  |
| FIB                               | Fibroblasts            |
| FLT                               | Filter                 |
| FIST                              | Fistula                |
| FLU                               | Body fluid, unsp       |
| GAS                               | Gas                    |
| GAST                              | Gastric fluid/contents |
| GEN                               | Genital                |
| GENC                              | Genital cervix         |
| GENL                              | Genital lochia         |
| GENV                              | Genital vaginal        |
| HAR                               | Hair                   |
| IHG                               | Inhaled gas            |
| IT                                | Intubation tube        |
| ISLT                              | Isolate                |
| LAM                               | Lamella                |
| WBC                               | Leukocytes             |
| LN                                | Line                   |
| LNA                               | Line arterial          |
| LNV                               | Line venous            |
| LIQ                               | Liquid NOS             |
| LYM                               | Lymphocytes            |
| MAC                               | Macrophages            |
| Continued in right-hand column... |                        |

| CODE  | DESCRIPTION                  |
|-------|------------------------------|
| SWT   | Sweat                        |
| SNV   | Synovial fluid (Joint fluid) |
| TEAR  | Tears                        |
| THRT  | Throat                       |
| THRB  | Thrombocyte (platelet)       |
| TISS  | Tissue                       |
| TISG  | Tissue gall bladder          |
| TLGI  | Tissue large intestine       |
| TLNG  | Tissue lung                  |
| TISPL | Tissue placenta              |
| TSMI  | Tissue small intestine       |
| TISU  | Tissue ulcer                 |
| TUB   | Tube NOS                     |
| ULC   | Ulcer                        |
| UMB   | Umbilical blood              |
| UMED  | Unknown medicine             |
| URTH  | Urethra                      |
| UR    | Urine                        |
| URC   | Urine clean catch            |
| URT   | Urine catheter               |
| URNS  | Urine sediment               |
| USUB  | Unknown substance            |
| VITF  | Vitreous fluid               |
| VOM   | Vomitus                      |
| BLD   | Whole blood                  |
| BDY   | Whole body                   |
| WAT   | Water                        |
| WICK  | Wick                         |
| WND   | Wound                        |
| WNDA  | Wound abscess                |
| WNDE  | Wound exudate                |
| WNDD  | Wound drainage               |

### 5.23 Termination Object

The Termination object is a component of the Terminate message (see Section 6.14).

**Table 53. Termination Object Attributes**

| ATTRIBUTE | TYPE | FORMAT   | DESCRIPTION   |
|-----------|------|----------|---|
| reason_cd | CV   | Table 54 | The reason for terminating the conversation.              |
| note_txt  | ST   |          | An optional text message that may be logged or displayed. |

**Table 54. Termination Reason Field Values**

| CODE | VALUE    | DESCRIPTION  |
|------|----------|--|
| NRM  | Normal   | The conversation was terminated normally.                |
| ABN  | Abnormal | An event occurred that caused an abnormal termination.   |
| USR  | User     | The conversation was terminated at the user's request.   |
| UNK  | Unknown  | The reason for the end of the conversation is not known. |

## 5.24 Update Action Object

The Update Action object is a component of the Patient List (see Section 6.12) and Operator List (see Section 6.11) messages.

**Table 55. Update Action Object Attributes**

| ATTRIBUTE | TYPE | FORMAT   | DESCRIPTION   |
|-----------|------|----------|---|
| action_cd | CS   | Table 56 | What operation should we perform using the referenced data? |

**Table 56. Update Action Code Values**

| CODE | VALUE  | MEANING  |
|------|--------|--|
| I    | Insert | Insert the specified entries into the associated list. |
| D    | Delete | Delete the specified entries from the associated list. |

Note that the **Update.action\_cd** values do not contain an option to 'edit' or 'replace.' These in-place operations may be implemented using paired Delete and Insert operations.

## 6 Messaging Model

### 6.1 Notation

The following notation conventions apply to the message model figures:

- Fields prepended with '+' are Required
- Fields prepended with a '-' are Optional
- Object cardinality is noted as part of the object name
  - (0...1) — zero or one instance
  - (0...\*) — zero or more instances



- (1...\*) — one or more instances
- The absence of a cardinality notation indicates one, and only one, instance.
- Figure 32 illustrates the connector notation used to relate objects within a hierarchy:
  - A vertical, left-side ‘L’ connector indicates parent-child relationship (containment).
  - A horizontal, right-side ‘U’ connector indicates a sibling relationship.

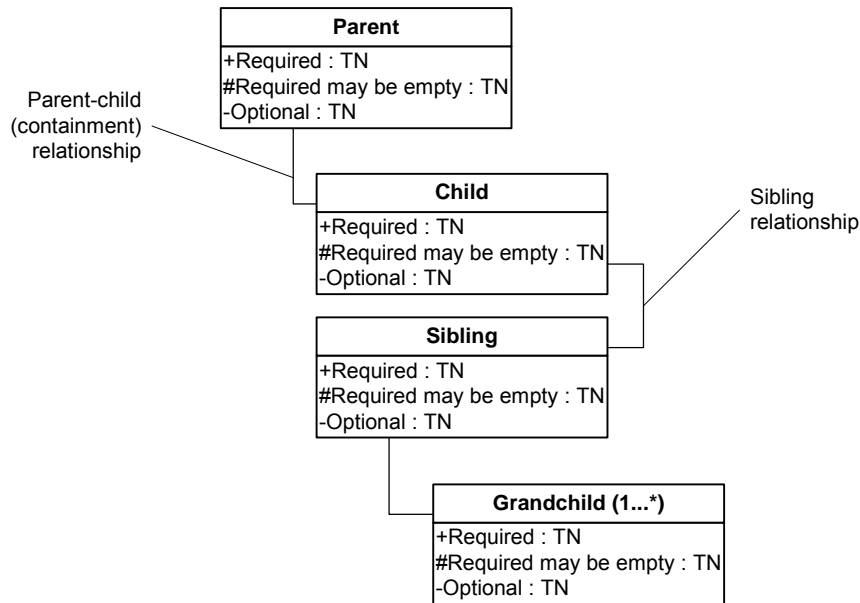

**Figure 32. Message Model Example**

## 6.2 Acknowledgement Message (ACK.R01)

The Acknowledgement message model is shown in Figure 33. The type of this message is ACK.R01.

If the Acknowledgement object is conveying an error condition, the **Acknowledgement.note\_txt** element may contain explanatory text (in addition to the **Acknowledgement.error\_detail\_cd** value) that the receiving system may log, display, or discard.

| OBJECT MODEL  | XML DTD FRAGMENT  |
|---|---|
| <div style="border: 1px solid black; padding: 5px;"> <p style="text-align: center;"><b>Header</b></p> <p>-message_type : CV<br/>+control_id : ST<br/>+version_id : ST<br/>+creation_dttm : TS<br/>-encoding_chars : ST</p> </div> <div style="border: 1px solid black; padding: 5px; margin-top: 5px;"> <p style="text-align: center;"><b>Acknowledgement</b></p> <p>+type_cd : CS<br/>+ack_control_id : ST<br/>-note_txt : ST<br/>-error_detail_cd : CV</p> </div> | <pre>&lt;!ELEMENT ACK.R01 (HDR, ACK)&gt; &lt;!ELEMENT HDR (HDR.message_type?, HDR.control_id, HDR.version_id, HDR.creation_dttm, HDR.encoding_chars?)&gt; &lt;!ELEMENT ACK (ACK.type_cd, ACK.ack_control_id, ACK.note_txt?, ACK.error_detail_cd?)&gt;</pre> |

**Figure 33. Acknowledgement Message Model**

### 6.3 Device Events Message (EVS.R01)

Figure 34 illustrates the Device Events message model. The type of this message is EVS.R01.

As indicated by the cardinality of the Device Event object, multiple Device Events may be communicated in a single message.

| OBJECT MODEL  | XML DTD FRAGMENT  |
|---|---|
| <div style="border: 1px solid black; padding: 5px;"> <p style="text-align: center;"><b>Header</b></p> <p>-message_type : CV<br/>+control_id : ST<br/>+version_id : ST<br/>+creation_dttm : TS<br/>-encoding_chars : ST</p> </div> <div style="border: 1px solid black; padding: 5px; margin-top: 5px;"> <p style="text-align: center;"><b>Device Event (1...*)</b></p> <p>+description : ST<br/>+event_dttm : TS<br/>+severity_cd : CS</p> </div> <div style="border: 1px solid black; padding: 5px; margin-top: 5px;"> <p style="text-align: center;"><b>Operator</b></p> <p>+operator_id : ST<br/>-name : PN</p> </div> | <pre>&lt;!ELEMENT EVS.R01 (HDR, EVT+)&gt; &lt;!ELEMENT HDR (HDR.message_type?, HDR.control_id, HDR.version_id, HDR.creation_dttm, HDR.encoding_chars?)&gt; &lt;!ELEMENT EVT (EVT.description, EVT.event_dttm, EVT.severity_cd, OPR)&gt; &lt;!ELEMENT OPR (OPR.operator_id, OPR.name?)&gt;</pre> |

**Figure 34. Device Events Message Model**

An operator shall be specified for every event; however, in some cases the operator may not be known. For example, events generated as the result of automatic processes would not be associated with a particular operator. In these cases, it is still important to provide some description of the initiator associated with the event. Table 40 defines two values, AUTO and REMOTE, to handle these situations.

## 6.4 Device Status Message (DST.R01)

Figure 35 defines the message model for Device Status messages. The type of this message is DST.R01.

| OBJECT MODEL  | XML DTD FRAGMENT |                    |                  |                  |                     |                      |               |                   |                             |                       |                    |                                |                          |                             |                            |   |
|---|------------------|--------------------|------------------|------------------|---------------------|----------------------|---------------|-------------------|-----------------------------|-----------------------|--------------------|--------------------------------|--------------------------|-----------------------------|----------------------------|---|
| <table border="1"> <thead> <tr> <th>Header</th> </tr> </thead> <tbody> <tr> <td>-message_type : CV</td> </tr> <tr> <td>+control_id : ST</td> </tr> <tr> <td>+version_id : ST</td> </tr> <tr> <td>+creation_dttm : TS</td> </tr> <tr> <td>-encoding_chars : ST</td> </tr> </tbody> </table><br><table border="1"> <thead> <tr> <th>Device Status</th> </tr> </thead> <tbody> <tr> <td>+status_dttm : TS</td> </tr> <tr> <td>+new_observations_qty : INT</td> </tr> <tr> <td>-new_events_qty : INT</td> </tr> <tr> <td>+condition_cd : CV</td> </tr> <tr> <td>-observations_update_dttm : TS</td> </tr> <tr> <td>-events_update_dttm : TS</td> </tr> <tr> <td>-operators_update_dttm : TS</td> </tr> <tr> <td>-patients_update_dttm : TS</td> </tr> </tbody> </table> | Header           | -message_type : CV | +control_id : ST | +version_id : ST | +creation_dttm : TS | -encoding_chars : ST | Device Status | +status_dttm : TS | +new_observations_qty : INT | -new_events_qty : INT | +condition_cd : CV | -observations_update_dttm : TS | -events_update_dttm : TS | -operators_update_dttm : TS | -patients_update_dttm : TS | <pre> &lt;ELEMENT DST.R01 (HDR, DST)&gt; &lt;ELEMENT HDR (HDR.message_type?, HDR.control_id, HDR.version_id, HDR.creation_dttm, HDR.encoding_chars?)&gt; &lt;ELEMENT DST (DST.status_dttm, DST.new_observations_qty, DST.new_events_qty?, DST.condition_cd, DST.observations_update_dttm?, DST.events_update_dttm?, DST.operators_update_dttm?, DST.patients_update_dttm?)&gt; </pre> |
| Header  |                  |                    |                  |                  |                     |                      |               |                   |                             |                       |                    |                                |                          |                             |                            |   |
| -message_type : CV  |                  |                    |                  |                  |                     |                      |               |                   |                             |                       |                    |                                |                          |                             |                            |   |
| +control_id : ST  |                  |                    |                  |                  |                     |                      |               |                   |                             |                       |                    |                                |                          |                             |                            |   |
| +version_id : ST  |                  |                    |                  |                  |                     |                      |               |                   |                             |                       |                    |                                |                          |                             |                            |   |
| +creation_dttm : TS   |                  |                    |                  |                  |                     |                      |               |                   |                             |                       |                    |                                |                          |                             |                            |   |
| -encoding_chars : ST  |                  |                    |                  |                  |                     |                      |               |                   |                             |                       |                    |                                |                          |                             |                            |   |
| Device Status   |                  |                    |                  |                  |                     |                      |               |                   |                             |                       |                    |                                |                          |                             |                            |   |
| +status_dttm : TS   |                  |                    |                  |                  |                     |                      |               |                   |                             |                       |                    |                                |                          |                             |                            |   |
| +new_observations_qty : INT   |                  |                    |                  |                  |                     |                      |               |                   |                             |                       |                    |                                |                          |                             |                            |   |
| -new_events_qty : INT   |                  |                    |                  |                  |                     |                      |               |                   |                             |                       |                    |                                |                          |                             |                            |   |
| +condition_cd : CV  |                  |                    |                  |                  |                     |                      |               |                   |                             |                       |                    |                                |                          |                             |                            |   |
| -observations_update_dttm : TS  |                  |                    |                  |                  |                     |                      |               |                   |                             |                       |                    |                                |                          |                             |                            |   |
| -events_update_dttm : TS  |                  |                    |                  |                  |                     |                      |               |                   |                             |                       |                    |                                |                          |                             |                            |   |
| -operators_update_dttm : TS   |                  |                    |                  |                  |                     |                      |               |                   |                             |                       |                    |                                |                          |                             |                            |   |
| -patients_update_dttm : TS  |                  |                    |                  |                  |                     |                      |               |                   |                             |                       |                    |                                |                          |                             |                            |   |

**Figure 35. Device Status Message Model**

## 6.5 Directive Message (DTV.R01, DTV.R02, DTV.VENDOR)

A Directive message allows an Observation Reviewer to instruct a Device to perform an operation. There are three types of Directive messages: (1) Basic Directives, (2) Complex Directives, and (3) Vendor-specific Directives. Basic Directives allow an Observation Reviewer to send a simple command code to a Device. Complex Directives enhance Basic Directives to allow parameters to be communicated in addition to the simple command code.

POCT1 defines several Basic Directives and one Complex Directive. The POCT1 standard does not attempt to define or specify the content of Vendor-specific Directives; rather, it defines a mechanism that vendors may use to define their own Directive messages. The approach described ensures that a Directive defined by one vendor will never be confused with a Directive defined by any other vendor. These three types of Directive messages are described in more detail in the following subsections.

Directive messages are not intended to provide general query capabilities. Specifically, a Device is only required (and allowed) to respond to a Directive with an Acknowledgement. The Device should send the Acknowledgement as soon as it determines that it can (or can't) perform the specified operation.

POCT1 identifies several general Directives that a vendor may choose to implement. Vendors are allowed to define their own command codes; however, CLSI suggests that vendors implement the Directives summarized in Table 57, if appropriate.

**Table 57. Summary of Standard (Basic and Complex) Directives**

| NAME             | COMMAND CODE     | MEANING  | TYPE    |
|------------------|------------------|--|---------|
| Set Device Time  | SET_TIME         | Set the clock on the Device to the supplied time stamp value.  | Complex |
| Lockout          | LOCK             | Lockout all testing functions on the Device.   | Basic   |
| Release Lockout  | UNLOCK           | Enable all testing functions on the Device.  | Basic   |
| Set Standby      | GOTO_STANDBY     | Place the Device in 'standby' mode.  | Basic   |
| Set Ready        | GOTO_READY       | Place the Device in the 'ready' mode.  | Basic   |
| Start Continuous | START_CONTINUOUS | Enable the Device and Observation Reviewer to maintain a continuous link, as described in Section 4.2. | Basic   |

**6.5.1 Basic Directives (DTV.R01)**

A Basic Directive message consists of a single command code, which is specified in the **Directive.command\_cd** field. The type of this message is DTV.R01.

| OBJECT MODEL  | XML DTD FRAGMENT   |
|---|--|
| <div style="border: 1px solid black; padding: 5px; margin-bottom: 5px;"> <p style="text-align: center;"><b>Header</b></p> <p>-message_type : CV<br/>                     +control_id : ST<br/>                     +version_id : ST<br/>                     +creation_dttm : TS<br/>                     -encoding_chars : ST</p> </div> <div style="border: 1px solid black; padding: 5px;"> <p style="text-align: center;"><b>Directive</b></p> <p>+command_cd : CV</p> </div> | <pre>&lt;ELEMENT DTV.R01 (HDR, DTV)&gt; &lt;ELEMENT HDR (HDR.message_type?, HDR.control_id, HDR.version_id, HDR.creation_dttm, HDR.encoding_chars?)&gt; &lt;ELEMENT DTV (DTV.command_cd)&gt;</pre> |

**Figure 36. Basic Directive Message Model**

The Basic Directives defined by this standard are described in more detail in the following subsections.

**6.5.1.1 Lockout**

The Observation Reviewer uses the Lockout directive to instruct a Device to prevent further analysis operations. This directive might be used by a POC coordinator who detects that a particular Device is operating outside acceptable ranges.

The **Directive.command\_cd** field value for this directive is “LOCK.”

**6.5.1.2 Release Lockout**

The Observation Reviewer uses the Release Lockout directive to restore a Device to full analytic functioning status.

The **Directive.command\_cd** field value for this directive is “UNLOCK.”

**6.5.1.3 Go to Standby**

The Observation Reviewer uses the Go to Standby directive to place a Device in ‘standby’ mode. The exact behavior and characteristics of the standby state are particular to the Device.

The **Directive.command\_cd** field value for this directive is “GOTO\_STANDBY.”

#### 6.5.1.4 Go to Ready

The Observation Reviewer uses the Go to Ready directive to restore a Device to full analytic functioning status. If the Device is already in the ‘ready’ state when it receives this Directive, it shall return a positive Acknowledgement message (rather than returning an error).

The **Directive.command\_cd** field value for this directive is “GOTO\_READY.”

#### 6.5.1.5 Start Continuous

The Observation Reviewer uses the Start Continuous directive to enable the Device and Observation Reviewer to maintain a continuous link, as described in Section 4.2.

The **Directive.command\_cd** field value for this directive is “START\_CONTINUOUS.”

### 6.5.2 Complex Directives

Complex Directives differ from Basic Directives in that they include one or more parameter objects or elements as siblings of the Directive object. The general structure of these Directives is illustrated by the following figure.

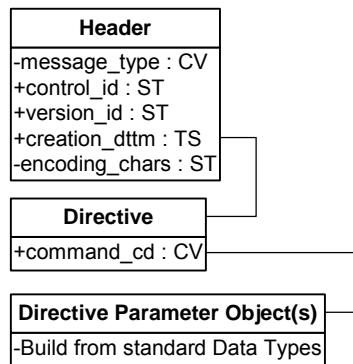

**Figure 37. Complex Directive Message Model**

Complex Directives use message trigger codes starting with ‘R02’ to differentiate them from the Basic Directive message (trigger ‘R01’). POCT1 defines only one Complex Directive: Set Device Time.

#### 6.5.2.1 Set Device Time (DTV.R02)

The Observation Reviewer uses the Set Device Time directive to set the clock on a Device and to provide local time zone and other timekeeping information. The structure of this message is shown in Figure 38. Additional information about this directive is provided in Annex C.

| OBJECT MODEL   | XML DTD FRAGMENT   |
|--|--|
| <div style="border: 1px solid black; padding: 5px; margin-bottom: 5px;"> <p><b>Header</b></p> <p>-message_type : CV<br/>                     +control_id : ST<br/>                     +version_id : ST<br/>                     +creation_dttm : TS<br/>                     -encoding_chars : ST</p> </div> <div style="border: 1px solid black; padding: 5px; margin-bottom: 5px;"> <p><b>Directive</b></p> <p>+command_cd : CV</p> </div> <div style="border: 1px solid black; padding: 5px; margin-bottom: 5px;"> <p><b>Time</b></p> <p>+dttm : TS<br/>                     -accy : REAL</p> </div> <div style="border: 1px solid black; padding: 5px; margin-bottom: 5px;"> <p><b>Time Zone (0..1)</b></p> <p>+offset : ST<br/>                     -label : ST<br/>                     -new_dttm : TS<br/>                     -new_offset : ST<br/>                     -new_label : ST</p> </div> <div style="border: 1px solid black; padding: 5px;"> <p><b>Leap Second (0..1)</b></p> <p>+cumulative : INT<br/>                     -new_dttm : TS<br/>                     -new_cumulative : INT</p> </div> | <pre>&lt;!ELEMENT DTV.R02 (HDR, DTV, (TM, TZ?, LS?))&gt; &lt;!ELEMENT HDR (HDR.message_type?, HDR.control_id, HDR.version_id, HDR.creation_dttm, HDR.encoding_chars?)&gt; &lt;!ELEMENT DTV (DTV.command_cd)&gt; &lt;!ELEMENT TM (TM.dttm, TM.accy?)&gt; &lt;!ELEMENT TZ (TZ.offset, TZ.label?, (TZ.new_dttm, TZ.new_offset, TZ.new_label?)?)&gt; &lt;!ELEMENT LS (LS.cumulative, (LS.new_dttm, LS.new_cumulative?)?)&gt;</pre> |

**Figure 38. Set Time Directive Message Model**

This type of message is DTV.R02, and the **Directive.command\_cd** field value for this Directive is ‘SET\_TIME’. This directive uses the following parameter name and value pairs:

| Name              | Type | Value   | Status |
|-------------------|------|---|--------|
| TM.dttm           | TS   | Observation Reviewer date-time time stamp, conforming to the TS data type rules. It must include a valid time zone offset relative to UTC.  | R      |
| TM.accy           | REAL | Decimal number (e.g., '10.', '5.', '0.5', etc.) indicating the 'accuracy,' or maximum error of the Observation Reviewer's time stamps relative to a primary reference clock source, in seconds. | RK     |
| TZ.offset         | ST   | Device's local time zone offset, relative to UTC, if known. Format '+hh:mm' or '+hh' for locations east of GMT and '-hh:mm' or '-hh' for locations west of GMT.                                 | RK     |
| TZ.label          | ST   | Device's local time zone label, if known. Type ST, examples: 'EST', 'EDT', etc.   | O      |
| TZ.new_dttm       | TS   | Device's local date-time when Daylight Savings Time change will occur. Default time is 2AM local time if only the date is provided.   | C      |
| TZ.new_offset     | ST   | Device's new local time zone offset, relative to UTC, after TZ.new_dttm.  | C      |
| TZ.new_label      | ST   | Device's new local time zone label, after TZ.new_dttm.  | O      |
| LS.cumulative     | INT  | Cumulative leap-seconds, which when subtracted from NTP seconds yields UTC seconds, relative to 1900-01-01T00:00:00Z. Format '+nn'; for the entire year 2001, LS.cumulative is '+32'.           | RK     |
| LS.new_dttm       | TS   | Date of transition from previous to new cumulative leap-second value. The leap-second adjustment occurs at the end (23:59:59Z) of the specified date.   | RK     |
| LS.new_cumulative | INT  | New cumulative leap-second value (may be the same as LS.cumulative).  | C      |

**Notes:**

TM.dttm is a required parameter for the SET\_TIME directive, and must include a valid time zone offset relative to UTC, consistent with other time stamps sent by the Observation Reviewer. A time zone offset of 'Z' may be specified, regardless of the local time zone of the Observation Reviewer.

TM.accy is reported only if the Observation Reviewer's clock has been synchronized by the Internet 'Network Time Protocol' (RFC-1305), 'Simple Network Time Protocol' (RFC-2030), the HL7 v2.4 'NCK' system clock segment, or other time synchronization protocol or method ultimately traceable to UTC. Estimated values for TM.accy may be used. TM.accy shall not be reported if the Observation Reviewer's clock has not been synchronized, as the Device may rely on this value to determine whether it should update its clock and to otherwise qualify the accuracy of its time stamps. TM.accy does *not* include the communication latency between the Observation Reviewer and the Device; it only specifies the known accuracy of the Observation Reviewer's time stamp relative to a primary reference clock source.

TZ.offset is reported only if the time zone of the Device (or Access Point) is known; TZ.label is optional. If TZ.offset is reported, TZ.new\_dttm and TZ.new\_offset are required if Daylight Savings Time is used; TZ.new\_label is optional.

LS.cumulative is reported if the Observation Reviewer supports Devices that use NTP or SNTP to synchronize their time. LS.new\_dttm and LS.new\_cumulative are reported if known, even if no leap-second adjustment is planned (i.e., LS.cumulative = LS.new\_cumulative).

**Status:** R - Required; RK - Recommended if Known; C - Conditional on preceding RK; O - Optional.

If the Observation Reviewer uses TCP/IP to communicate with the Device, it shall expeditiously send the Set Time Directive to the Device using the TCP/IP 'push' operation.

### 6.5.3 Vendor-specific Directive Messages (DTV.VENDOR)

Vendors are allowed to create new Directive messages for their Devices and Observation Viewers to use.

For the naming of vendor-specific directive messages, the string content of field V in the message\_type CV attribute of the Header Object (see Section 8.4) shall begin with the characters DTV, followed by the Coded Vendor Identifier (see Appendix F, Table 115), if defined. See also Section 7.2 for naming conventions.

The following figure illustrates the structure to which these messages must adhere:

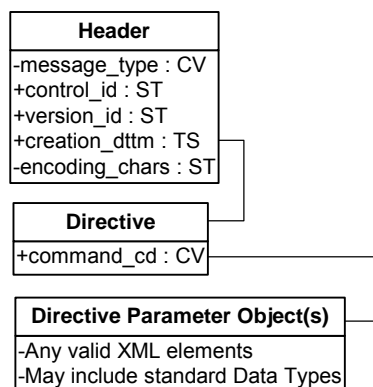

**Figure 39. Vendor-specific Directive Message Model**

## 6.6 End of Topic Message (EOT.R01)

Because the size of the data to be transferred in some Topics can be quite large, the protocol provides a scheme to break large transfers into a series of messages. The End of Topic message is used to indicate that all messages in such a series have been transmitted.

This type of message is EOT.R01.

| OBJECT MODEL   | XML DTD FRAGMENT |   |                     |                                     |  |
|--|------------------|---|---------------------|-------------------------------------|--|
| <table border="1"> <tr> <td style="text-align: center;"><b>Header</b></td> </tr> <tr> <td>-message_type : CV<br/>+control_id : ST<br/>+version_id : ST<br/>+creation_dttm : TS<br/>-encoding_chars : ST</td> </tr> <tr> <td style="text-align: center;"><b>End of Topic</b></td> </tr> <tr> <td>+topic_cd : CV<br/>-update_dttm : TS</td> </tr> </table> | <b>Header</b>    | -message_type : CV<br>+control_id : ST<br>+version_id : ST<br>+creation_dttm : TS<br>-encoding_chars : ST | <b>End of Topic</b> | +topic_cd : CV<br>-update_dttm : TS | <pre>&lt;ELEMENT EOT.R01 (HDR, EOT)&gt; &lt;ELEMENT HDR (HDR.message_type?, HDR.control_id, HDR.version_id, HDR.creation_dttm, HDR.encoding_chars?)&gt; &lt;ELEMENT EOT (EOT.topic_cd, EOT.update_dttm?)&gt;</pre> |
| <b>Header</b>  |                  |   |                     |                                     |  |
| -message_type : CV<br>+control_id : ST<br>+version_id : ST<br>+creation_dttm : TS<br>-encoding_chars : ST  |                  |   |                     |                                     |  |
| <b>End of Topic</b>  |                  |   |                     |                                     |  |
| +topic_cd : CV<br>-update_dttm : TS  |                  |   |                     |                                     |  |

**Figure 40. End of Topic Message Model**

The optional **End of Topic.update\_dttm** field can be used to inform the receiver the time at which the update was current. If provided, the receiver may use this field for display purposes (e.g., to indicate to the user when the most recent operator list was uploaded).

It is legitimate for a sender to provide an update that is not current for the present time. For example, to increase performance, an Observation Reviewer may periodically build a list of operator list updates. The Observation Reviewer might then use this prebuilt list for some period. In this case, the **End of Topic.update\_dttm** field’s value would reflect the time the list was created, not the current system time.

### 6.7 Escape Message (ESC.R01)

The Escape message model is shown in Figure 41. The type of this message is ESC.R01.

The **Escape.note\_txt** element may contain explanatory text (in addition to the **Escape.detail\_cd** value) that the receiving system may choose to log, display, or discard.

| OBJECT MODEL  | XML DTD FRAGMENT |   |               |   |  |
|---|------------------|---|---------------|---|--|
| <table border="1"> <tr> <td style="text-align: center;"><b>Header</b></td> </tr> <tr> <td>-message_type : CV<br/>+control_id : ST<br/>+version_id : ST<br/>+creation_dttm : TS<br/>-encoding_chars : ST</td> </tr> <tr> <td style="text-align: center;"><b>Escape</b></td> </tr> <tr> <td>+esc_control_id : ST<br/>+detail_cd : CS<br/>-note_txt : ST</td> </tr> </table> | <b>Header</b>    | -message_type : CV<br>+control_id : ST<br>+version_id : ST<br>+creation_dttm : TS<br>-encoding_chars : ST | <b>Escape</b> | +esc_control_id : ST<br>+detail_cd : CS<br>-note_txt : ST | <pre>&lt;ELEMENT ESC.R01 (HDR, ESC)&gt; &lt;ELEMENT HDR (HDR.message_type?, HDR.control_id, HDR.version_id, HDR.creation_dttm, HDR.encoding_chars?)&gt; &lt;ELEMENT ESC (ESC.esc_control_id, ESC.detail_cd, ESC.note_txt?)&gt;</pre> |
| <b>Header</b>   |                  |   |               |   |  |
| -message_type : CV<br>+control_id : ST<br>+version_id : ST<br>+creation_dttm : TS<br>-encoding_chars : ST   |                  |   |               |   |  |
| <b>Escape</b>   |                  |   |               |   |  |
| +esc_control_id : ST<br>+detail_cd : CS<br>-note_txt : ST   |                  |   |               |   |  |

**Figure 41. Escape Message Model**

### 6.8 Hello Message (HEL.R01)

A Device sends the Hello message only once as the first message in a Conversation. This type of message is HEL.R01.



The Hello message contains sufficient information for the Observation Reviewer to determine if a conversation should occur and, if so, how it should take place (e.g., using what connection profile, concerning what Topics, and involving what Directives).

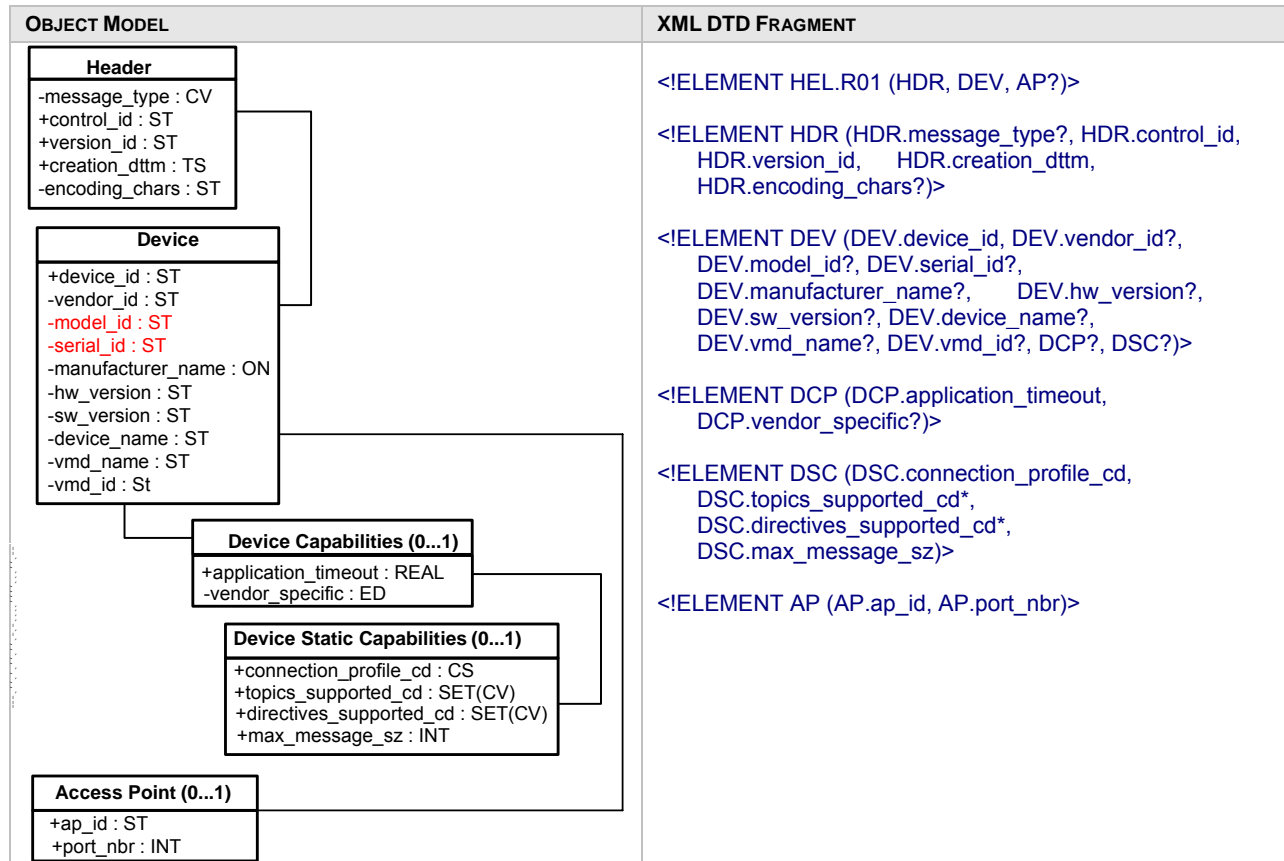

Figure 42. Hello Message Model

## 6.9 Keep Alive Message (KPA.R01)

Figure 43 illustrates the Keep Alive message model. This type of message is KPA.R01.

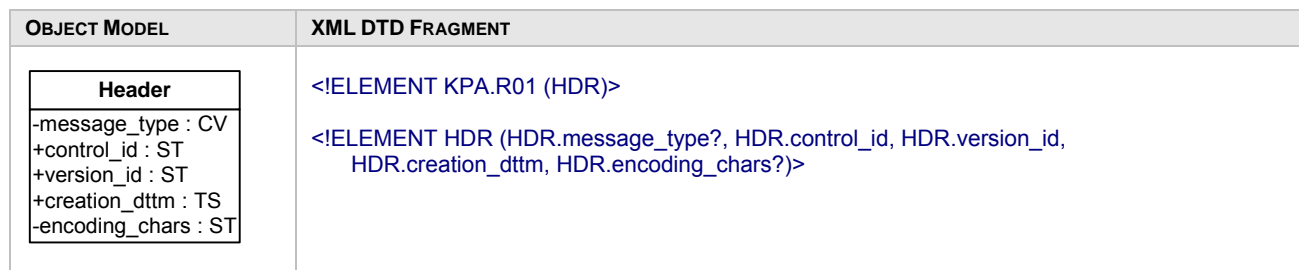

Figure 43. Keep Alive Message Model

This message requires no information in addition to the message type; therefore, there are no message objects associated with the Header.

## 6.10 Observations Message (OBS.R01, OBS.R02)

The particular observation message structure employed depends on whether the observation is a patient– or a nonpatient–related test. Patient-related tests use the OBS.R01 message, while nonpatient test results are reported using the OBS.R02 message.

The patient-related observation message structure is illustrated in Figure 44.

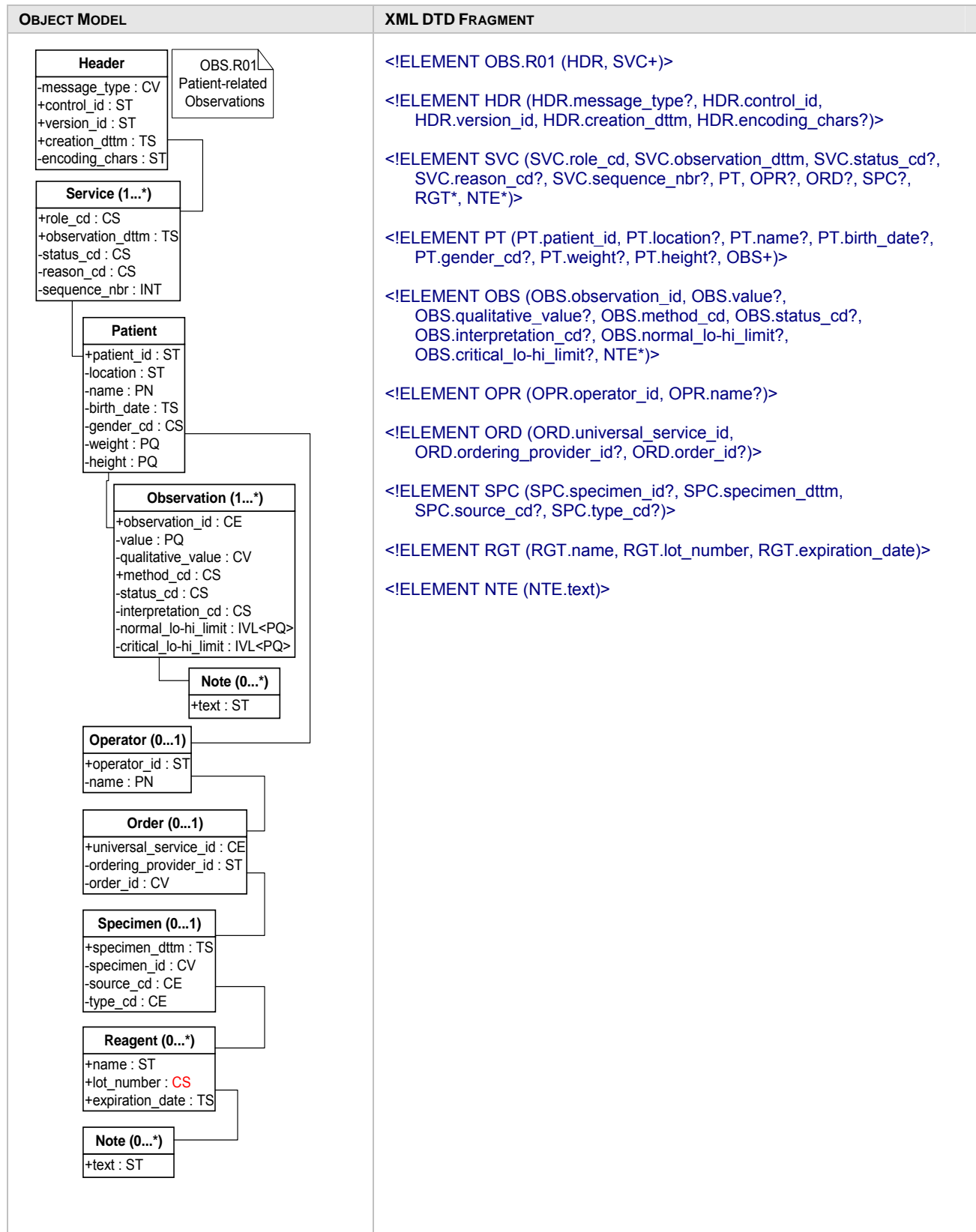

Figure 44. Patient-related Observation Message Model

The nonpatient-related observation message structure is illustrated in Figure 45.

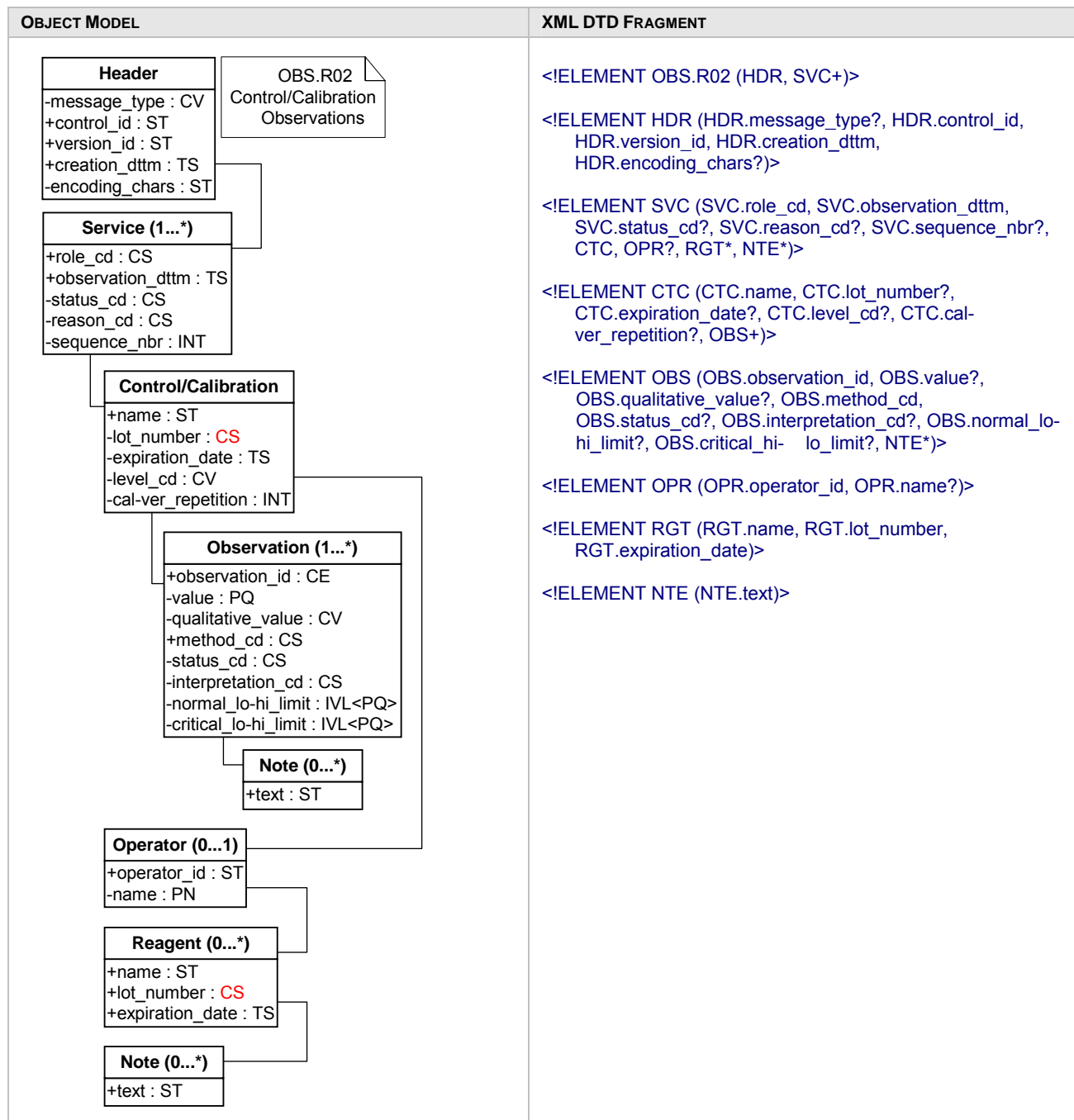

Figure 45. Nonpatient-related Observation Message Model

Observation Message Rules and Notes:

- (1) The cardinality of the Service object is one-or-more; therefore, a Device could send all of its stored results in a single Observation message containing multiple Service records. Alternatively, the Device could send only a fixed number of results in each Observation message, and use multiple Observation messages to communicate the entire result set. This specification provides no guidance regarding the tradeoff between message size and number of messages, as this decision is most appropriately an engineering, implementation, and deployment issue.

- (2) The Specimen object supports observation tracking and traceability. It contains fields sufficient to positively identify the source of the sample that the measurement was made on. As not all fields in the object will be available in all settings, only the specimen\_dttm field is required. Depending on the setting and institutional rules, other fields may be required to support tracking and traceability.

### 6.11 Operator List Message (OPL.R01, OPL.R02)

If a Device indicates (through the Device Static Capabilities object, Table 19) that it can manage operator lists, the Observation Reviewer will use Operator List messages to update the Device.

There are two types of Operator List messages, depending on whether the Device indicates that it can handle incremental updates. If the Device cannot accept incremental updates, the Observation Reviewer must use only the “Complete Update” form of the Operator List message model. However, if the Device indicates that it can handle incremental updates, the Observation Reviewer may use either the “Complete” or the “Incremental” form for the Operator List message.

The type of this message is OPL. The Complete update message uses trigger R01 (i.e., “OPL.R01”), and the Incremental update message uses the R02 trigger (i.e., “OPL.R02”).

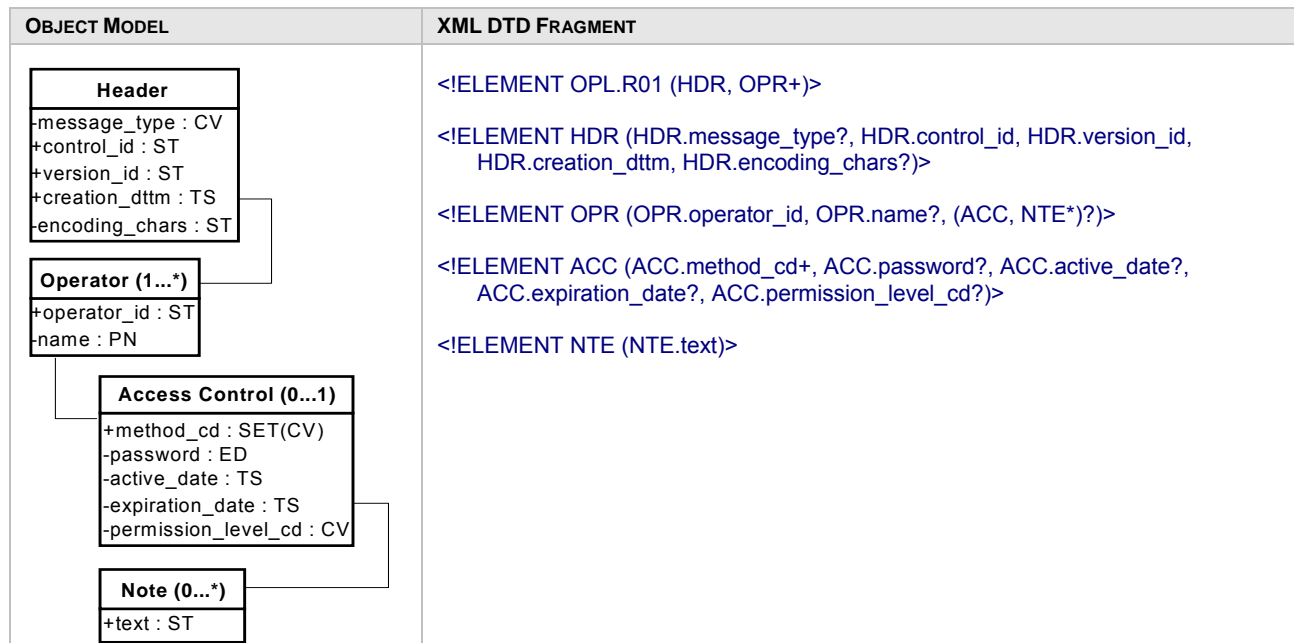

Figure 46. Operator List Complete Update Message Model

| OBJECT MODEL  | XML DTD FRAGMENT   |
|---|--|
| <pre> classDiagram     class Header {         -message_type : CV         +control_id : ST         +version_id : ST         +creation_dttm : TS         -encoding_chars : ST     }     class UpdateAction["Update Action (1...*)"] {         +action_cd : CS     }     class Operator["Operator (1...*)"] {         +operator_id : ST         -name : PN     }     class AccessControl["Access Control (0...1)"] {         +method_cd : SET(CV)         -password : ED         -active_date : TS         -expiration_date : TS         -permission_level_cd : CV     }     class Note["Note (0...*)"] {         +text : ST     }     UpdateAction --&gt; Operator     AccessControl --&gt; Note             </pre> | <pre> &lt;!ELEMENT OPL.R02 (HDR, UPD*)&gt; &lt;!ELEMENT HDR (HDR.message_type?, HDR.control_id, HDR.version_id, HDR.creation_dttm, HDR.encoding_chars?)&gt; &lt;!ELEMENT UPD (UPD.action_cd, OPR+)&gt; &lt;!ELEMENT OPR (OPR.operator_id, OPR.name?, (ACC, NTE*)?)&gt; &lt;!ELEMENT ACC (ACC.method_cd+, ACC.password?, ACC.active_date?, ACC.expiration_date?, ACC.permission_level_cd?)&gt; &lt;!ELEMENT NTE (NTE.text)&gt;             </pre> |

Figure 47. Operator List Incremental Update Message Model

At the discretion of the Observation Reviewer, operator list updates may be transmitted as a series of Operator List messages. For example, if 36 changes occurred since the last update, the Observation Reviewer might choose to send these updates in three messages, each containing 12 updates. Under all circumstances, the Device must acknowledge receipt of each Operator List message.

### 6.12 Patient List Message (PTL.R01, PTL.R02)

If a Device is capable of managing lists of valid patients, the Observation Reviewer may send the Device updated patient lists using the Patient List message. This type of message is PTL. The complete update message uses trigger R01 (i.e., “PTL.R01”), and the Incremental update message uses the R02 trigger (i.e., “PTL.R02”).

| OBJECT MODEL  | XML DTD FRAGMENT   |
|---|--|
| <pre> classDiagram     class Header {         -message_type : CV         +control_id : ST         +version_id : ST         +creation_dttm : TS         -encoding_chars : ST     }     class Patient["Patient (1...*)"] {         +patient_id : ST         -location : ST         -name : PN         -birth_date : TS         -gender_cd : CS         -weight : PQ         -height : PQ     }     Header -- Patient             </pre> | <pre> &lt;!ELEMENT PTL.R01 (HDR, PT+)&gt; &lt;!ELEMENT HDR (HDR.message_type?, HDR.control_id, HDR.version_id, HDR.creation_dttm, HDR.encoding_chars?)&gt; &lt;!ELEMENT PT (PT.patient_id, PT.location?, PT.name?, PT.birth_date?, PT.gender_cd?, PT.weight?, PT.height?)&gt;             </pre> |

Figure 48. Patient List Complete Update Message Model

| OBJECT MODEL   | XML DTD FRAGMENT  |
|--|---|
| <pre> classDiagram     class Header {         -message_type : CV         +control_id : ST         +version_id : ST         +creation_dttm : TS         -encoding_chars : ST     }     class UpdateAction["Update Action (1...*)"] {         +action_cd : CS     }     class Patient["Patient (1...*)"] {         +patient_id : ST         -location : ST         -name : PN         -birth_date : TS         -gender_cd : CS         -weight : PQ         -height : PQ     }     Header -- UpdateAction     UpdateAction -- Patient </pre> | <pre> &lt;!ELEMENT PTL.R02 (HDR, UPD+)&gt; &lt;!ELEMENT HDR (HDR.message_type?, HDR.control_id, HDR.version_id, HDR.creation_dttm, HDR.encoding_chars?)&gt; &lt;!ELEMENT UPD (UPD.action_cd, PT+)&gt; &lt;!ELEMENT PT (PT.patient_id, PT.location?, PT.name?, PT.birth_date?, PT.gender_cd?, PT.weight?, PT.height?)&gt; </pre> |

**Figure 49. Patient List Incremental Update Message Model**

Like the Operator List message (see Section 6.11), the Patient List message model takes different forms depending on whether or not the Device can accept incremental updates. If the Device does not report that it can handle incremental updates, the Patient List message takes the “Complete Update” form shown in Figure 46. If the Device advertises that it can manage incremental updates, the Observation Reviewer may transmit the list using either the “Complete” or the “Incremental” forms of the message model.

### 6.13 Request Messages (REQ.R01)

The Observation Reviewer uses Request messages to prompt the Device to begin transferring data. These Request messages are:

- Request Observations – prompts the Device to send all new observations using Observations messages;
- Request Device Events – prompts the Device to send all new Device events using Device Events messages; and
- Request Vendor-specific – prompts the Device to send data to fulfill a vendor-specific request.

These request messages all use the same simple message model (Figure 50). This type of message is REQ, and the trigger is R01 (i.e., “REQ.R01”).

| OBJECT MODEL  | XML DTD FRAGMENT  |
|---|---|
| <pre> classDiagram     class Header {         -message_type : CV         +control_id : ST         +version_id : ST         +creation_dttm : TS         -encoding_chars : ST     }     class Request {         +request_cd : CV     }     Header -- Request </pre> | <pre> &lt;!ELEMENT REQ.R01 (HDR, REQ)&gt; &lt;!ELEMENT HDR (HDR.message_type?, HDR.control_id, HDR.version_id, HDR.creation_dttm, HDR.encoding_chars?)&gt; &lt;!ELEMENT REQ (REQ.request_cd)&gt; </pre> |

**Figure 50. Request Messages Model**

This message contains only a Request object. The value of the **Request.request\_cd** field determines the type of request. Refer to Table 45 for a list of Request message codes defined by POCT1.

### 6.14 Terminate Message (END.R01)

Either conversation participant may send a Terminate message when it wants to end the current conversation. The type of this message is END.R01.

This message contains only a Termination object. This object contains a code indicating the reason the conversation has been terminated, as well as an optional message that the recipient may choose to display or log.

| OBJECT MODEL   | XML DTD FRAGMENT  |
|--|---|
| <div style="border: 1px solid black; padding: 5px;"> <p style="text-align: center;"><b>Header</b></p> <p>-message_type : CV<br/>                     +control_id : ST<br/>                     +version_id : ST<br/>                     +creation_dttm : TS<br/>                     -encoding_chars : ST</p> </div> <div style="border: 1px solid black; padding: 5px; margin-top: 10px;"> <p style="text-align: center;"><b>Termination</b></p> <p>+reason_cd : CV<br/>                     -note_txt : ST</p> </div> | <pre>&lt;!ELEMENT END.R01 (HDR, TRM)&gt; &lt;!ELEMENT HDR (HDR.message_type?, HDR.control_id, HDR.version_id, HDR.creation_dttm, HDR.encoding_chars?)&gt; &lt;!ELEMENT TRM (TRM.reason_cd, TRM.note_txt?)&gt;</pre> |

**Figure 51. Terminate Message Model**

## 7 Extending the Device Messaging Layer

This specification cannot standardize all manner and type of dialogs that must occur between Devices and Observation Reviewers. This document mentions several approaches for extending this specification to accommodate these vendor-specific needs. This section describes each approach in more detail, and presents some of the implementation issues that may guide the selection of one approach over another.

An important objective is to ensure that a Device or an Observation Reviewer that supports an extension will always transparently work with a Device or Observation Reviewer that does not implement the given extension.

### 7.1 Custom Directive Messages

A vendor may define a new Directive to communicate data from the Observation Reviewer to the Device. The basic structure of a Directive message is a command code, optionally followed by parameter elements. Vendors are free to define new command codes and to specify appropriate parameter sets for these new commands. This specification predefines several common Directive messages (see Section 6.5), which should be used if appropriate.

The Custom Directive approach works best when sending a small amount of data from the Observation Reviewer to the Device. Because the Device may only send an Acknowledgement message in response to successfully receiving and parsing a Directive, these messages are not useful for retrieving data from a Device to the vendor’s data management service.

A variation on this scheme that addresses these data transfer limitations involves sending a Directive that causes the Device to establish a separate communication link after termination of the current Conversation. For example, a vendor’s Data Manager might use a Directive message to inform a Device



that a firmware update is available and that it should connect to a particular named resource to download the update as soon as the current Conversation is complete. While this approach is very flexible and works well for exchanging binary data, it does require vendors to establish a separate communication channel and resource-naming scheme.

Introducing a different Directive response message type is **not** allowed. It might be tempting to extend the message flow to allow a Device to respond to a Directive with a message type other than Acknowledge; however, this approach would break compatibility between participants that did and did not support the Directive with the new response type. Thus, it is not allowed.

### 7.1.1 Interoperability With the Basic Profile

Devices and Observation Reviewers whose functionality is extended using Custom Directive messages will seamlessly interoperate with systems that do not implement the extensions.

If a 'standard' Device receives a custom Directive message from an 'extended' Observation Reviewer, it will reply with an Error Acknowledgement message (see Section 4.1.12.1).

A 'standard' Observation Reviewer will never send a custom Directive to an 'extended' Device, so no interoperability issues arise in this case.

## 7.2 Custom Message Topics, Types, and Models

This approach involves creating new message types, models, and flows to enable vendor-specific data exchange. Three rules apply to the creation of these messages and flows:

- All messages must use the general message structure illustrated in Figure 52. Specifically, all messages must start with a Header object, followed by zero or more message objects.

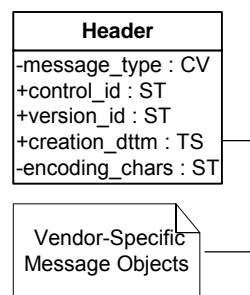

**Figure 52. Vendor-specific Message Model**

- In the Header Object, the string content of field V in the message\_type CV attribute (see Section 8.4) shall indicate the vendor-specific content and/or purpose of the message. It may also indicate the vendor name. For messages differing in their internal structure (i.e., composition of objects) different names shall be used. Field SN shall contain the coded Vendor Identifier (see Appendix F, Table 115), if defined.
- Vendor-specific exchanges shall be designed in terms of Topics, with a clear message indicating the end of the current Topic (e.g., an Acknowledgement or End of Topic message). Thus, each vendor-specific message flow is 'bounded' (i.e., the vendor-specific flow has a well-defined start and end).

Though this approach is more complicated than using custom Directive messages, it provides a flexible and extensible framework for bidirectional data exchange. Refer to Section 11.8 for an example of a Vendor-specific Topic.

Unlike the Directive-based approach, custom messages can be used to efficiently transfer data from a Device to a point-of-care data management application. For example, a vendor could implement a custom message Topic to download vendor-specific inventory management information from a Device. The first message of this Topic would be a request message indicating the type of information the Device should supply. The following message(s) would contain the requested information. The Topic would conclude with either an Acknowledgement message from the Observation Reviewer (if the Device requires only one message to send the requested information) or an End of Topic message from the Device (if multiple messages are required for the transfer).

### 7.2.1 Interoperability With the Basic Profile

Devices and Observation Reviewers whose functionality is extended in this manner are seamlessly interoperable with systems that do not implement the extensions.

If an 'extended' Device or Observation Reviewer sends a custom message to a 'standard' Receiver, the Receiver will reply with an Escape message (see Section 4.1.12.2). This will cause the Sender to terminate the current vendor-specific Topic.

## 8 Annex A. Device Messaging Layer Data Types (Normative)

The data types used by elements of the DML messages are derived from the data types being developed for version 3 of the HL7 specification. In particular, the data types referenced and used by this specification are based on the HL7 document, *Health and Clinical Management, Release 1, HL7 Version 3 Standard, Committee Ballot #1*. Details of these types may change in the final balloted version of this document; however, for the purposes of the POCT1 standard, these definitions are normative.

The following table provides an overview of the data types used by the POCT1 Device Messaging Layer.

Table 58. Device Messaging Layer Data Type Descriptions<sup>PP</sup>

| NAME                       | SYMBOL  | DESCRIPTION  |
|----------------------------|---------|--|
| Encapsulated Data          | ED      | Data that is primarily intended for human interpretation or for further machine processing outside the scope of this specification. This includes unformatted or formatted written language, multimedia data, or structured information as defined by a different standard (e.g., XML-signatures). Instead of the data itself, an ED may contain only a reference (e.g., a URL or other type of network resource name). Note that the ST data type is a specialization of the ED data type when the ED media type is text/plain. |
| Character String           | ST      | Text data, primarily intended for machine processing (e.g., sorting, querying, indexing, etc.). Used for names, symbols, and formal expressions). Note that the ST data type is a specialization of the ED data type when the ED media type is text/plain.   |
| Coded Simple Value         | CS      | Coded data, consists of a code and display name. The code system and code system version is fixed by the context in which the CS value occurs. CS is used for coded attributes that have a single HL7-defined value set.   |
| Coded Value                | CV      | Coded data, consists of a code, display name, code system, and original text. Used when a single code value must be sent.  |
| Coded With Equivalents     | CE      | Coded data, consists of a coded value (CV) and, optionally, coded value(s) from other coding systems that identify the same concept. Used when alternative codes may exist.  |
| Person Name                | PN      | A name of a person. Person names usually consist of several name parts that can be classified as given, family, nickname etc. PN is a restriction of EN.   |
| Organization Name          | ON      | A name of an organization. ON name parts are typically not distinguished, but may distinguish the suffix for the legal standing of an organization (e.g., "Inc.," "Co.," "B.V.," "GmbH," etc.) from the name itself. ON is a restriction of EN.  |
| Integer Number             | INT     | Positive and negative whole numbers, typically the results of counting and enumerating. The standard imposes no bounds on the size of integer numbers.   |
| Real Number                | REAL    | Fractional numbers. Typically used whenever quantities are measured, estimated, or computed from other real numbers. The typical representation is decimal, where the number of significant decimal digits is known as the precision.  |
| Physical Quantity          | PQ      | A dimensioned quantity expressing the result of measurement. It consists of a real number value and a physical unit. Physical quantities are often constrained to a certain dimension by specifying a unit representing the dimension (e.g., m, kg, s, kcal/d, etc.) However, physical quantities should not be constrained to any particular unit (e.g., should not be constrained to centimeter instead of meter or inch).   |
| Point in Time              | TS      | A time stamp.  |
| Physical Quantity Interval | IVL<PQ> | A set of continuous values of an ordered quantity, with units. POCT1 imposes some restrictions on the allowed IVL<PQ> representations, in order to simplify parsing logic.   |
| Set Collection             | SET<T>  | An unordered collection of unique values of any type T.  |

The POCT1 standard relies on the HL7 version 3 (Committee Level Ballot #1) rules for encoding these data types as XML elements. In this scheme, values are encoded using XML elements that have attributes drawn from a common set. For example, the ST type can use the 'V,' 'VT,' and 'PROB' attributes, while the CS type can use the 'V,' 'DN,' 'VT,' and 'PROB' attributes. For illustration, consider the following examples:

The string, "This is a string value" would be encoded in an ST data element as follows:

```
<someST V="This is the string value"/>
```

<sup>PP</sup> Referenced from *Health and Clinical Management, Release 1, HL7 Version 3 Standard, Committee Ballot #1*.

The simple code ‘10001,’ which represents the ‘Set Time’ concept, would be encoded in a CS type as follows:

```
<someCS V="10001" DN="Set Time"/>
```

To ensure consistency of implementation and interpretation, the following subsections describe the attributes that can be used with each data type. Each section includes an example usage of the data type drawn from the sample messages (see Appendix F). Where appropriate, notes on expected implementation are included.

Every data type contains two optional fields, described in the following table. These fields may be used when appropriate. They are not explicitly included in the following type definitions for clarity and brevity.

**Table 59. Common Data Type Attributes**

| FIELD | REQUIRED | USE   |
|-------|----------|---|
| VT    | No       | Specifies the time interval during which this value is valid. |
| PROB  | No       | Qualifies this value with a probability factor.               |

## 8.1 Encapsulated Data (ED)

The ED data type allows plain text, compressed, encrypted, or binary data to be conveyed in the **ACC.password** and **DCP.vendor\_specific** fields of POCT1 messages. The attributes this data type may use are described in the following table.

**Table 60. ED Data Type Attributes**

| FIELD | REQUIRED | USE   |
|-------|----------|---|
| ENC   | No       | Specifies the encoding of the data value. This field can be either “B64” or “TXT” (default is “TXT”). “TXT” indicates that the value can be interpreted directly, while “B64” indicates that the value was <i>base-64</i> encoded and must be decoded to recover the original data. |
| COMP  | No       | Specifies compression scheme used for the Value, if any.  |
| IC    | No       | Specifies a checksum value or other integrity check.  |
| MT    | No       | Specifies the MIME type for the encoded data. The default value is “text/plain.”  |

Unlike many of the other data types, the ED type contains its value in the element node text, so the only required data is the element data. The following XML fragment illustrates the use of an ED data type field (**ACC.password**) to communicate a user password key.

```
<ACC.password>ff129087feab</ACC.password>
```

The following example illustrates how a vendor-specific message (Biochemtronix firmware update) could use the ED type to upload new firmware to a Device. In this example, the firmware data has been compressed with Gzip and base-64 encoded.

```
<BCHMX.firmware ENC="B64" COMPN="GZ">
  omSJUEdmde9j44zmMiromSJUEdmde9j44zmMirdMDSsWdlJdkslJR3373jeu83
  6edjzMMljdMDSsWdlJdkslJR3373jeu83MNYD83jmMdomSJUEdmde9j44zmMir
  ...
  MNYD83jmMdomSJUEdmde9j44zmMir6edjzMMljdMDSsWdlJdkslJR3373jeu83
  4zmMir6edjzMMljdMDSsWdlJdkslJR3373jeu83==
</BCHMX.firmware>
```

## 8.2 Character String (ST)

The ST data type communicates a simple string value in its ‘V’ attribute. The attributes this data type may use are described in the following table.

**Table 61. ST Data Type Attributes**

| FIELD | REQUIRED | USE                       |
|-------|----------|---------------------------|
| V     | Yes      | Contains the string value |

ST elements may also contain element text, which could hold an alternate representation value. The POCT1 standard requires the use of the ‘V’ attribute, and allows optional use of the text node to contain an alternate value.

The following XML fragment illustrates the use of an ST data type field (**PT.location**).

```
<PT.location V="ICU-Bed3"/>
```

## 8.3 Coded Simple Value (CS)

The CS data type communicates a coded value from a fixed list of options. The attributes this data type may use are described in the following table.

**Table 62. CS Data Type Attributes**

| FIELD | REQUIRED | USE                                 |
|-------|----------|-------------------------------------|
| V     | Yes      | Contains the value code             |
| DN    | No       | A string value intended for display |

The following XML fragment illustrates the use of a CS data type field (**PT.gender\_cd**).

```
<PT.gender_cd V="M" DN="Male"/>
```

## 8.4 Coded Value (CV)

The CV data type enhances the CS data type, allowing communication of not only a coded value but also the code set where the value is defined. The attributes this data type may use are described in the following table.

**Table 63. CV Data Type Attributes**

| FIELD | REQUIRED | USE  |
|-------|----------|--|
| V     | Yes      | Contains the value code                                      |
| DN    | No       | A string value intended for display                          |
| S     | No       | An OID denoting the authority this code set is registered to |
| SN    | No       | The name of the registering authority for this code set      |
| SV    | No       | The version of this code set                                 |

The S/SN/SV attributes are used to specify the code set from which the value contained in the ‘V’ attribute is drawn. If none of these coding system attributes (i.e., S, SN, SV) are specified, the code set is assumed to be this standard, “POCT1.”

If the coding system is not “POCT1,” the SN attribute must contain the name of the system used. This standard defines the following values for the SN attribute.

**Table 64. SN Attribute Values for the CV Data Type**

| VALUE                          | DESCRIPTION   |
|--------------------------------|---|
| LN                             | The LOINC coding system                               |
| Any code value from Appendix F | CLSI-registered codes for organizations and companies |

The following XML fragment illustrates the use of a CV data type field (**DTV.command\_cd**) to communicate the “SET\_TIME” code value from the default (POCT1) code set.

```
<DTV.command_cd V="SET_TIME"/>
```

The following XML fragment illustrates how the **DTV.command\_cd** field can also contain a coded value, “LQC\_SETUP”, from an alternate coding system (“BCHMX,” version 1.0).

```
<DTV.command_cd V="LQC_SETUP" SN="BCHMX" SV="1.0"/>
```

## 8.5 Coded With Equivalent (CE)

The CE data type ‘enhances’ the CV data type, allowing communication of codes from several different coding schemes, all of which reference the identical concept. The attributes this data type may use are described in the following table.

**Table 65. CE Data Type Attributes**

| FIELD | REQUIRED | USE  |
|-------|----------|--|
| V     | Yes      | Contains the value code                                      |
| DN    | No       | A string value intended for display                          |
| S     | No       | An OID denoting the authority this code set is registered to |
| SN    | No       | The name of the registering authority for this code set      |
| SV    | No       | The version of this code set                                 |

The CE type's attributes are used in exactly the same way as the CV type's attributes (Section 8.4). The principal or preferred coded representation should be expressed using these attributes. The CE type allows alternate representations to be communicated using one or more TRANSLTN child elements.

The following XML fragment illustrates how the **OBS.observation\_id** communicates two possible encodings for the same concept.

```
<OBS.observation_id V="2703-7" SN="LN" DN="OXYGEN">
  <TRANSLTN V="pO2" SN="BCHMX" SV="1.0"/>
```

The first (preferred) coding comes from the LOINC system, and the second coding references the vendor-specific Biochemtronix coding set.

## 8.6 Person Name (PN)

The PN data type is used to communicate the elements of an individual's name. The attributes this data type may use are described in the following table.

**Table 66. PN Data Type Attributes**

| FIELD | REQUIRED | USE  |
|-------|----------|--|
| V     | Yes      | Contains a formatted-for-display version of the name |

A PN element may contain a number of optional child elements that identify the particular components of the name. These component elements are described in the following table.

**Table 67. PN Data Type Child Elements**

| ELEMENT | USE   |
|---------|---|
| GIV     | The given name component                          |
| MID     | The middle name component                         |
| FAM     | The family name component                         |
| PFX     | A prefix component (e.g., "Dr.")                  |
| SFX     | A suffix component (e.g., "Ph.D")                 |
| DEL     | A delimiter character used to separate components |

The following XML fragment illustrates how the **OPR.name** field can be used to encode the operator "Dr. John Ebert."

```
<OPR.name V="Dr. John Ebert">
  <FAM V="Ebert"/>
  <GIV V="John"/>
  <PFX V="Dr."/>
  <SFX V="MD"/>
</OPR.name>
```

## 8.7 Organization Name (ON)

The ON data type is used to communicate the elements of an organization's name. The attributes this data type may use are described in the following table.

**Table 68. ON Data Type Attributes**

| FIELD | REQUIRED | USE                                   |
|-------|----------|---------------------------------------|
| V     | Yes      | Contains the name of the organization |

The following XML fragment illustrates how the ON type is used in the DEV.manufacturer\_name field to encode the fictional “Biochemtronix” organization.

```
<DEV.organization_name V="Biochemtronix"/>
```

## 8.8 Integer Number (INT)

The INT data type is used to communicate an integer number. The attributes this data type may use are described in the following table. Either the ‘V’ or the ‘NULL’ attribute must be specified.

**Table 69. INT Data Type Attributes**

| FIELD | REQUIRED | USE   |
|-------|----------|---|
| V     | No       | Contains the string representation of the value                 |
| NULL  | No       | Indicates one of the values from the following table (Table 70) |

**Table 70. Null Code Values**

| FIELD | USE               |
|-------|-------------------|
| NI    | No Information    |
| NA    | Not Applicable    |
| UNK   | Unknown           |
| NASK  | Not Asked         |
| ASKU  | Asked But Unknown |
| NAV   | Not Available     |
| OTH   | Other             |
| PINF  | Positive Infinity |
| NINF  | Negative Infinity |

The following XML fragment illustrates how the INT type is used in the DST.new\_observations\_qty field to indicate that there are 54 new observations to report.

```
<DST.new_observations_qty V="54"/>
```

The following XML fragment illustrates how a device could indicate that it has no upper limit (i.e., the limit equals positive infinity) on the size of messages it can handle.

```
<DSC.max_message_sz NULL="PINF"/>
```



## 8.9 Real Number (REAL)

The REAL data type is used to communicate a real number. The attributes this data type may use are described in the following table.

**Table 71. REAL Data Type Attributes**

| FIELD | REQUIRED | USE   |
|-------|----------|---|
| V     | No       | Contains the string representation of the value |
| NULL  | No       | Indicates one of the values from Table 70       |

Trailing zeros may be used in the ‘V’ attribute to indicate precision.

**NOTE:** The following XML fragment illustrates how a device could indicate that it will use an application timeout value of 5.5 seconds.

```
<DSC.application_timeout V="5.5"/>
```

## 8.10 Physical Quantity (PQ)

The PQ data type is used to communicate a measured value, with the units of measure. The attributes this data type may use are described in the following table. Either the ‘V’ and the ‘U’ attributes or the ‘NULL’ attribute must be specified.

**Table 72. PQ Data Type Attributes**

| FIELD | REQUIRED | USE  |
|-------|----------|--|
| V     | No       | Contains the string representation of the value — Note (1) |
| U     | No       | Indicates the units of measure for the value — Note (2)    |
| NULL  | No       | Indicates one of the values from Table 70                  |

(1) Trailing zeros may be used in the ‘V’ attribute to indicate precision.

(2) The HL7 “ISO+” units code set, defined in a section of the HL7 v2.4 specification,<sup>99</sup> comprises the default values for the PQ units attribute. This specification defines an abbreviation for a single case unit (ISO 2955-83) plus extensions that do not collide with ISO abbreviations.

The following XML fragment illustrates how a device could communicate a pCO<sub>2</sub> value of 71.1 mmHg.

```
<OBS.value V="71.1" U="mmHg"/>
```

## 8.11 Point in Time (TS)

The TS data type is used to communicate a point in time. The attributes this data type may use are described in the following table. Either the ‘V’ or the ‘NULL’ attribute must be specified.

<sup>99</sup> At this time, the section number for the ISO+ code set reference in the final HL7 version 3 Standard is unknown; thus, the ISO+ definition contained in the version 2.4.1 specification is considered normative for POCT1.

**Table 73. TS Data Type Attributes**

| FIELD | REQUIRED | USE   |
|-------|----------|---|
| V     | No       | Contains the string representation of the Time <sup>a</sup> |
| NULL  | No       | Indicates one of the values from Table 70                   |

**Note:**

<sup>a</sup> The string form of the date-time value uses the HL7 encoding rules. Schematically, this format can be illustrated as follows:

YYYY-MM-DDTHH:MM:SS.SSxOH:OM

where:

YYYY = four-digit year;

MM = two-digit month of the year;

DD = two-digit day of the month;

HH = 24-hour representation of the hour;

MM = minute;

SS.SS = second (optional decimal digits may follow the '.' separator);

x = '+' if time is GMT *plus* offset; '-' if time is GMT *minus* offset;

OH = hours offset from GMT; and

OM = minutes offset from GMT.

**NOTE:** Use of variable precision (right to left truncation) is allowed and separator characters are required.

The following XML fragment illustrates how a device could communicate that an observation was made on November 1, 2001 at 5:09:10 PM, in a time zone that is eight hours behind GMT.

`<SVC.observation_dttm V="2001-11-01T17:09:10-08:00"/>`

**8.12 Physical Quantity Interval (IVL<PQ>)**

The IVL<PQ> data type is used to communicate a range of values with the same units. The attributes that this data type may use are described in the following table. Either the 'V' attribute (with an optional 'U' attribute) or the 'NULL' attribute must be specified.

**Table 74. IVL<PQ> Data Type Attributes**

| FIELD | REQUIRED | USE  |
|-------|----------|--|
| V     | No       | Contains the string representation of the interval |
| U     | No       | Indicates the unit of measure for the interval     |
| NULL  | No       | Indicates one of the values from Table 70          |

The *HL7 Version 3 Data Types, Draft Revision 1.3* document defines five different forms for the literal; however, to simplify implementation complexity, POCT1 allows only one form to be used. Referring to the names given these forms by the HL7 draft, POCT1 only supports the use of the "interval" form. POCT1 further restricts this form by requiring that the same units of measure be used for both the high

and low bounds, and that these units be communicated only in the ‘U’ attribute (i.e., POCT1 does not permit the units to be mixed with the literal values in the ‘V’ attribute).

The IVL<PQ> type is used to communicate the **normal\_lo-hi\_limit** and the **critical\_lo-hi\_limit** for an observation. The following subsection illustrates the use of the interval form.

### 8.12.1 Interval Form

The interval form uses a semicolon to separate the low and high limits and square brackets to indicate whether the boundary values are open or closed. POCT1 requires that both the low- and high-boundary values be provided. The following table illustrates the possible intervals this form can express.

**Table 75. Interval Form Literal Encoding**

| LITERAL      | LOW    |     | HIGH   |      | RANGE           |
|--------------|--------|-----|--------|------|-----------------|
|              | CLOSED | LOW | CLOSED | HIGH |                 |
| [3.5;5.0]    | Yes    | 3.5 | Yes    | 5.0  | 3.5 <= x <= 5.0 |
| [3.5;5.0[    | Yes    | 3.5 | No     | 5.0  | 3.5 <= x < 5.0  |
| ]3.5;5.0]    | No     | 3.5 | Yes    | 5.0  | 3.5 < x <= 5.0  |
| ] -inf; 5.0] | No     | -∞  | Yes    | 5.0  | -∞ < x <= 5.0   |
| [3.5; +inf[  | Yes    | 3.5 | No     | +∞   | 3.5 <= x < +∞   |

The special boundary values, ‘-inf’ and ‘+inf’, can be used to indicate plus/minus infinity.

The following example illustrates how an IVL<PQ> can be used to express that the normal range for a glucose measurement is between 80 and 120 mg/dL, inclusive.

```
<OBS.normal_lo-hi_limit V="[80;120]" U="mg/dL"/>
```

The following example illustrates encoding of a measurement limit less than 88 mg/dL.

```
<OBS.normal_lo-hi_limit V="]-inf;88[" U="mg/dL"/>
```

### 8.13 Set (SET<V>)

The SET data type is used to communicate an unordered collection of related values. This type is represented as a repeating element of the given type.

The following example illustrates the use of sets of CV types in the Device Static Capabilities object. In this example, the **DSC.topics\_supported\_cd** and **DSC.directives\_supported\_cd** fields contain a set of Coded Values.

```
<DSC>
  <DSC.connection_profile_cd V="SA"/>
  <DSC.topics_supported_cd V="DTV"/>
  <DSC.topics_supported_cd V="OP_LST"/>
  <DSC.directives_supported_cd V="SET_TIME"/>
  <DSC.directives_supported_cd V="LOCK"/>
  <DSC.directives_supported_cd V="UNLOCK"/>
  <DSC.max_message_sz V="800"/>
</DSC>
```

## 9 Annex B. Asynchronous Observation Acknowledgements (Normative)

This annex specifies a communication optimization called ‘asynchronous acknowledgement’ that is *optional* for POCT Devices. This optimization may only be used during the Observations Topic, and is designed to maintain high communication throughput while providing an individual acknowledgement of each Observations message. This optimization *requires* a transport layer that provides end-to-end flow control, such as that provided by TinyTP and TCP/IP.

### 9.1 Synchronous and Asynchronous Acknowledgements

The Device Messaging Layer typically uses *synchronous* acknowledgements for messages. This approach provides the simplest way to deliver reliable messaging, over and above the reliable transport layers provided by the lower layers (e.g., TinyTP and TCP/IP, as described in the *Device and Access Point* document). The basic flow is shown in the ‘synchronous’ section of Figure 53, where the Device sends message  $M_k$  and waits for the acknowledgement  $a_k$  from the Observation Reviewer before sending the next message  $M_{k+1}$ .

The throughput of the *synchronous* protocol will be reduced, however, if the round-trip network and Observation Reviewer delay is comparable or longer than the duration of a typical message. For example, if the duration of each message is 500 msec (corresponding to a ‘simple’ glucose report sent at 9.6 KBd) and the total round-trip network and Observation Reviewer delay is also 500 msec, then the throughput of the link is reduced by 50%. If the round-trip delay were longer (which would be the likely case for a busy hospital intranet or extranet), or if an Observation Reviewer must service several access points at the same time the overall throughput would be reduced even further.

#### Synchronous

Message sent by Device

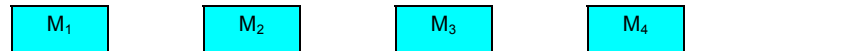

Acknowledgements sent by Observation Reviewer

#### Asynchronous

Message sent by Device

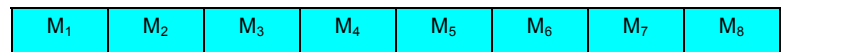

Acknowledgements sent by Observation Reviewer

**Figure 53. Synchronous vs. Asynchronous Acknowledgements**

In contrast, a Device messaging protocol that uses *asynchronous* acknowledgements can effectively use 100% of the network bandwidth, even though the acknowledgements are delayed. Back-to-back message transmission is possible if the Device is capable of sending message  $M_{i>k}$  before it receives acknowledgement  $a_k$ .

#### 9.1.1 Design Considerations for a Device

In this section, it is assumed that the transport layer provides end-to-end flow control. If the transport layer does *not* support end-to-end flow control, the Device must operate in *synchronous* mode by waiting for acknowledgement  $a_k$  before sending message  $M_{k+1}$ .

**Permitted Device Optimization: Asynchronous Observation Acknowledgements**

During the POCT1 Observation phase only, a Device is permitted to send message  $M_{k+1}$  and subsequent messages (up to and including the End of Topic) before the receiving acknowledgement  $a_k$ ,<sup>a</sup> subsequent to any flow-control exercised by the Observation Reviewer. A Device may switch between *synchronous* and *asynchronous* mode at any time.<sup>b</sup>

**Notes:**

<sup>a</sup> The assumption here is that the Device can process delayed acknowledgements; otherwise, *synchronous* mode must be used at all times. A Device that operates in *synchronous* acknowledgement mode simply waits for acknowledgement  $a_k$  before sending message  $M_{k+1}$ .

<sup>b</sup> For example, a Device may send the first message *synchronously* to ensure that the Observation Reviewer can accept its Observation messages, and subsequent messages can be sent *asynchronously* to efficiently use the communication link.

**9.1.2 Design Considerations for the Observation Reviewer**

It should be noted that the use of *asynchronous* acknowledgements does not affect the content of the data streams going from the Device to Observation Reviewer and vice-versa. The content and order of the messages and acknowledgements within each stream are identical to the *synchronous* case.

**Requirements for an Observation Reviewer (Normative)**

The Observation Reviewer shall expeditiously send Acknowledgements to the Device, using the TCP/IP ‘push’ operation.<sup>a</sup> The Device is permitted to send subsequent messages without having received ACK messages for previous messages, but the Observation Reviewer can always invoke TCP/IP and TinyTP flow-control if it cannot accept data from the Device. The order of messages and acknowledgements shall be preserved within their respective communication streams.<sup>b</sup>

**Notes:**

<sup>a</sup> The TCP/IP ‘push’ operation would be required to support efficient ‘synchronous’ operation in any case.

<sup>b</sup> This requirement may simplify some Device implementations.

One may ask whether it is possible for the Device to ‘flood’ an Observation Reviewer with messages, but the Observation Reviewer can always invoke the flow-control provided by TCP/IP and TinyTP by simply not accepting messages from the Device until it is ready to do so. At some point all of the communication buffers along the TCP/IP and TinyTP communication path will be filled and TinyTP will ‘block’ at the Device until the Observation Reviewer can begin to accept data again.

**10 Annex C. ‘SET\_TIME’ Time Stamp and Time Zone Information**

This annex provides additional background information regarding the ‘SET\_TIME’ directive and its parameters.

**Objectives**

- Provide a standard method by which Observation Reviewers can automatically set and synchronize the date and time in POC Devices.
- Use time stamps traceable to Coordinated Universal Time (UTC) so that the ‘absolute’ time is always known, even though the time zone of the Observation Reviewer and/or Device may not be known. Practically all Internet, radio, and satellite time sources provide time stamps traceable to UTC,

making this an attractive method for distributing and synchronizing time on Observation Reviewers and POC Devices.

- Provide ‘local’ time zone and Daylight Savings Time information to the POC Device, if known, so that it can automatically maintain correct local time.
- Provide cumulative ‘leap-second’ information for POC Devices that may wish to use the Internet ‘Simple Network Time Protocol’ for more precise time synchronization.

### ***Observation Reviewer Time Stamp [TM.dttm]***

Time stamps sent by the Observation Reviewer are *required* to include a *timezone\_offset* (e.g., “2001-02-12T10:00:00-8:00”). This ensures that the Device at least knows the absolute time, traceable to UTC, regardless of the time zone where the Device is used or where the Observation Reviewer is located. The basic requirements for time stamps sent by the Observation Reviewer are summarized below.

**Time stamps sent by the Observation Reviewer shall include a *timezone\_offset*<sup>a</sup> that is ultimately traceable to Coordinated Universal Time (UTC). The Device may assume that the *combined* time and offset are correct, at least to within the latency of the Observation Reviewer and communication infrastructure. The Device shall not assume that the offset is appropriate for the location where the Device is used, and the Device is permitted to use a different *timezone\_offset*.<sup>b</sup>**

#### **Notes:**

<sup>a</sup> The *timezone\_offset* provided by the Observation Reviewer typically would correspond to its physical location and not necessarily to that of the Device.

<sup>b</sup> A Device could be configured to override the *timezone\_offset* provided by the Observation Reviewer as well as automatically handle Daylight Savings Time changes.

### ***Observation Reviewer Time Stamp Accuracy [TM.accy]***

Time stamps sent by the Observation Reviewer are qualified by their ‘accuracy,’ which is defined as the maximum error relative to a primary reference clock source such as a GPS, radio, or atomic clock, in seconds. The accuracy is a positive decimal number (e.g. ‘10.’, ‘5.’, ‘0.5,’ etc.) and does *not* include the communication latency between the Observation Reviewer and the Device.

The accuracy of Observation Reviewer clocks that are synchronized by the Internet ‘Network Time Protocol’ (RFC-1305) or ‘Simple Network Time Protocol’ (RFC-2030) can be estimated using the following relationship:

$$\text{TM.accy} = \text{‘root dispersion’} + \frac{1}{2} \text{‘root delay’}$$

Alternative estimates for **TM.accy** may be used if other synchronization protocols or methods are employed. **TM.accy** shall not be reported, however, if the Observation Reviewer’s clock has not been synchronized to a time source ultimately traceable to UTC.

**TM.accy** specifies the ‘inherited accuracy’ of time stamps sent by the Observation Reviewer, and is one of several factors that allow the Device to determine the degree by which it should update its clock and to estimate the accuracy of its own time stamps.

The errors reflected in the time stamp accuracy reported by the Observation Reviewer include:

- *the accuracy and precision of the time stamps used to synchronize the Observation Reviewer;*
- *communication and processing latency;*
- *whether or not the Observation Reviewer's time was manually set, which could imply an inaccuracy of several minutes; and*
- *the Observation Reviewer's clock drift since it was last synchronized.*

Similar errors will contribute to inaccuracy in setting and synchronizing the Device clock and characterizing its accuracy. For example, the accuracy for a Device clock whose time has been manually set or adjusted should be initially set to several minutes to reflect the large uncertainty. Similarly, the accuracy for an unsynchronized Device clock should be increased by roughly one to ten seconds per day, depending on the accuracy and drift of its time-of-day clock oscillator. The Device can compare the estimate of its internal clock accuracy with the accuracy of the time stamps received from the Observation Reviewer to (a) determine whether or not to update its clock; and (b) characterize the accuracy of the time stamps it sends to the Observation Reviewer.

At the time of this writing, a Device clock and time stamp accuracy of one minute ( $\pm 60$  seconds) would be considered acceptable for the majority of POC tests performed today, and represents a significant improvement over many existing point-of-care timekeeping implementations. An accuracy of  $\pm 15$  seconds would be appropriate for time-critical POC measurements in the OR or ICU, and an accuracy of  $\pm 5$  seconds would be appropriate for POC measurements that contribute to a patient alarm.

#### **Example message for the Observation Reviewer's TIME $\pm$ ACCY:**

```
<TM.dttm V="2001-02-12T10:00:00-6:00"/>
<TM.accy V="0.5"/>
```

#### ***Device Local Time Zone [TZ]***

Although a time stamp with `timezone_offset` provides an unambiguous indication of an absolute instant of time, it does not provide the information required for the display of 'local' time if the Device is used in a different time zone than the Observation Reviewer. Thus, it is *recommended* that the Observation Reviewer provide time zone information corresponding to the physical location where the Device (or Access Point) is used, if it is known.

The parameter **TZ.offset** is the Device's local time zone offset, using the format '+hh:mm' or '+hh' for locations east of Greenwich Mean Time (GMT) and '-hh:mm' or '-hh' for locations west of GMT. In the example shown below, the Access Point and/or Device is located in Eastern Indiana, which is on Eastern Standard Time (EST) (UTC-05:00) for the entire year. The optional parameter **TZ.label** is the time zone label.

```
<TZ.offset V="-05"/>
<TZ.label V="EST"/>
```

An Observation Reviewer may send country-specific time zone labels to geographic areas that have the same time zone offset. For example, the time zone labels below have the same numeric offset `<TZ.offset V="+09"/>` but different country-specific labels:

```
<TZ.label V="JST"/>    for Japan,
<TZ.label V="KST"/>    for Korea, and
<TZ.label V="EIT"/>    for eastern Indonesia.
```

In the next example, the Access Point and/or Device are located in an Eastern time zone that uses Daylight Savings Time. The parameter **TZ.new\_dttm** specifies the transition date and time (2AM is the default if none is specified) and **TZ.new\_offset** and **TZ.new\_label** are the numeric offset and label for the time zone after the transition date.

```
<TZ.offset V="-05"/>
<TZ.label V="EST"/>
<TZ.new_dttm V="2001-04-01"/>
<TZ.new_offset V="-04"/>
<TZ.new_label V="EDT"/>
```

After the transition (to Daylight Savings Time), the Observation Reviewer would then provide the date and time for the next transition (back to Standard Time):

```
<TZ.offset V="-04"/>
<TZ.label V="EDT"/>
<TZ.new_dttm V="2001-10-28"/>
<TZ.new_offset V="-05"/>
<TZ.new_label V="EST"/>
```

The **TZ** parameters provide the time zone information in an easy-to-use format that eliminates the need for the Device to process complex Daylight Savings Time ‘rules’ traditionally used by PCs and workstations. This allows the ‘local’ displayed time on the Device to be correct at all times, even when the Device is not connected to an Access Point when the Daylight Savings Time transitions occur.

Supporting this capability will help promote time stamp consistency between manually and electronically recorded measurements, and will largely eliminate the chore and potential errors due to manually setting and maintaining the date and time.

### *Determining the Device’s ‘Local’ Time Zone*

There are several methods by which Observation Reviewer can determine the time zone that the Access Point and/or Device are used:

1. All Devices are used in the same time zone as the Observation Reviewer.

*This would apply to the vast majority of POC Devices used in a single hospital or hospitals located in the same time zone.*

2. Use the area code from incoming modem Caller ID information.
3. Use the IP source address for a networked access point.

*Methods #2 and #3 rely on the communications infrastructure to identify the location of the Access Point and/or Device. A look-up table based on area code and/or IP source address is used to determine the time zone.*

4. Use the Device or Access Point EUI-64 or other identifying information, obtained by using the DML protocol.

*Information provided by the Device Messaging Layer (DML) protocol can be used to identify the location of the Access Point and/or Device, prior to sending the time zone information to the Device.*

In situations where the Observation Reviewer cannot ascertain the Device’s time zone information, time zone information would not be sent to the Device. The Observation Reviewer would still be *required* to



include its time zone offset in time stamps it sends to the Device so that the absolute UTC time of the measurement would be known.

Finally, the following option is always available to the Device:

5. Manually configure the Device with the correct date, time, time zone, and Daylight Savings Time information. The Device would always have the option of overriding the time zone information provided by the Observation Reviewer.

### ***Synopsis of Time Zone Messaging***

*The essentials of the time zone messaging are summarized below:*

#### **The Observation Reviewer (aka Data Manager) ...**

... *must* send TS+tz<sub>DM</sub> (traceable to UTC time) if tz<sub>DM</sub> is *known*;  
otherwise, use tz<sub>DM</sub> = tz<sub>Z</sub> (UTC time, available from many sources).

... *should* send local time information tz<sub>DEV</sub> if the time zone of the Device (or Access Point) is *known*; otherwise, local time zone information is not sent.

#### **The Device, if local time zone tz<sub>DEV</sub> is *unknown or not displayed to the user* ...**

... *must* send time stamps consistent with TS+tz<sub>DM</sub> (traceable to UTC time).

#### **The Device, if local time zone tz<sub>DEV</sub> is *known and displayed to the user* ...**

... *must* send TS+tz<sub>DEV</sub> (traceable to UTC time).

*where:*

tz<sub>DM</sub> is the time zone offset of the Data Manager;  
tz<sub>DEV</sub> is the time zone offset of the Device (or its Access Point); and  
tz<sub>Z</sub> is UTC Time, with an implicit time zone offset of 00:00.

### ***Leap-seconds [LS]***

Devices that have direct network connections may use the Internet ‘Network Time Protocol’ (NTP, RFC-1305) or ‘Simple Network Time Protocol’ (SNTP, RFC-2030) as an alternative method of synchronizing their clocks. NTP and SNTP measure the round-trip network delay using UDP/IP datagrams and are capable of providing synchronization accuracy on the order of one to ten milliseconds for Devices continuously connected to the network. NTP and SNTP are supported on many platforms, and provide robust, reliable, and accurate time synchronization for Devices, servers, hospital networks, and intranets, as well as the global Internet.

Furthermore, ISO/IEEE 11073-30200 provides an optional SNTP service using TinyTP ‘TTP\_UData’ frames and can support accurate waveform synchronization for Devices that are connected to different networked Access Points. Although present-day POC diagnostic applications do not require this level of time stamp accuracy, future POC diagnostic tests may, especially if the results are used in time-critical situations or contribute to the generation of a patient alarm.

Devices that use NTP and SNTP to obtain UTC will need to deal with ‘leap-seconds’ that are typically inserted every 18 months to correct for the Earth’s rotation with respect to International Atomic Time

(TAI). Although NTP provides a leap-second warning flag, it is only valid for the minute prior to the leap-second adjustment and essentially requires that the Device be continuously connected to the network. Also, keeping the leap-second offset separate from NTP seconds facilitates conversion between UTC time and NTP time and comparisons using the strictly monotonic NTP time.

For these reasons, the Device Messaging Layer protocol sends leap-second information as a single cumulative value, or as a pair of cumulative values with a transition date:

For the calendar year 2001:

<LS.cumulative V="+32"/>

For the most recent positive leap-second that was inserted at the *end* of the day on December 31, 1998, UTC time (1998-12-31T23:59:59Z), we have:

<LS.cumulative V="+31"/>  
 <LS.new\_dttm V="1998-12-31"/>  
 <LS.new\_cumulative V="+32"/>

The relationship  $UTC\ seconds = NTP\ seconds - LS.cumulative\ seconds$  may be used to determine the number of UTC seconds, relative to 1900-01-01T00:00:00Z (UTC).

The following table shows the UTC time for various ‘leap-second’ transitions:

| No Leap-Second Adjustment<br>(last minute has 60 seconds) | Leap-Second Insertion<br>(last minute has 61 seconds) | Leap-Second Deletion<br>(last minute has 59 seconds) |
|---|---|--|
| 2001-06-30T23:59:58Z                                      | 1998-12-31T23:59:58Z                                  | XXXX-06-30T23:59:58Z                                 |
| 2001-06-30T23:59:59Z                                      | 1998-12-31T23:59:59Z                                  | XXXX-07-01T00:00:00Z                                 |
| 2001-07-01T00:00:00Z                                      | 1998-12-31T23:59:60Z                                  | XXXX-07-01T00:00:01Z                                 |
| 2001-07-01T00:00:01Z                                      | 1999-01-01T00:00:00Z                                  |  |
|   | 1999-01-01T00:00:01Z                                  | <i>Note: this has never happened!</i>                |

**References for Annex C**

Mills, David. Network Time Protocol (Version 3) Specification, Implementation and Analysis. Network Working Group Report RFC-1305. University of Delaware; March 1992. 113 pp.

RFC-1305 is available at <http://www.faqs.org/ftp/rfc/rfc1305.pdf>.

Additional information about NTP is available at <http://www.eecis.udel.edu/~ntp/>.

Mills, David. Simple Network Time Protocol (SNTP) Version 4 for IPv4, IPv6 and OSI. Network Working Group Report RFC-2030. University of Delaware; October 1996.

RFC-2030 is available at <http://www.faqs.org/ftp/rfc/rfc2030.txt>.

**11 Annex D. Example Messages (Informative)**

This annex documents how XML is used to encode the POCT1 messages. At the lowest level, the messages are built from the basic data types developed for HL7 version 3. Specifically, this Annex relies on work contained in *XML Health and Clinical Management, Release 1, HL7 Version 3 Standard, Committee Ballot #1*. Although the content of this HL7 document may change in the final balloted version, the current data type definitions are sufficient for the purposes of the POCT1 Device Messaging

Layer. Thus, the definitions contained in this draft version are normative for the purpose of the POCT1 Device Messaging Layer standard.

This annex contains two types of examples: (1) XML-encoded POCT1 messages, and (2) XML Document Type Definition (DTD) files that can be used to validate the XML-encoded messages. Since DTDs are used only for validation of message format and content, they are not required parts of a POCT1 messaging conversation. Instead, they are useful during device and system development and deployment testing as an interoperability test.

## 11.1 POCT1 XML Message Examples

The examples in this annex build from an illustration of a simple glucose result report to more complex device-data manager exchanges. The following subsections provide examples of each of the POCT1 Device Messaging Layer messages.

- complete message dialog illustrating reporting a single glucose test result (Section 11.1.1);
- an Observation message that communicates a blood gas measurement (Section 11.2);
- an Observation message that communicates control/calibration results (Section 11.3);
- a message series to communicate device events (Section 11.4);
- a message series to communicate a list of valid operators (Section 11.5);
- a message series to communicate a list of patients (Section 11.6);
- a Basic Directive message (Section 11.7.1);
- a Set Time Directive message (Section 11.7.2);
- several examples of vendor-specific Directive messages (Section 11.7.3); and
- a vendor-specific Topic (Section 11.8).

### 11.1.1 Simple Glucose Result Exchange

From Appendix B, Table 7, the messages in the following table represent the minimal set required to support the exchange of a measurement.

**Table 76. Required Messages for Simple Glucose Example**

|    | DEVICE SEND,<br>OBSERVATION REVIEWER RECEIVE | DEVICE RECEIVE,<br>OBSERVATION REVIEWER SEND |
|----|--|--|
| 1  | Hello [HEL.R01]                              |  |
| 2  |  | Acknowledgement [ACK.R01]                    |
| 3  | Device Status [DST.R01]                      |  |
| 4  |  | Acknowledgement [ACK.R01]                    |
| 5  |  | Request Observations [REQ.R01]               |
| 6  | Observations [OBS.R01]                       |  |
| 7  |  | Acknowledgement [ACK.R01]                    |
| 8  | End of Topic [EOT.R01]                       |  |
| 9  |  | Terminate [END.R01]                          |
| 10 | Acknowledgement [ACK.R01]                    |  |

Schematically, the following figure describes the message flow between the Device and the Observation Reviewer.

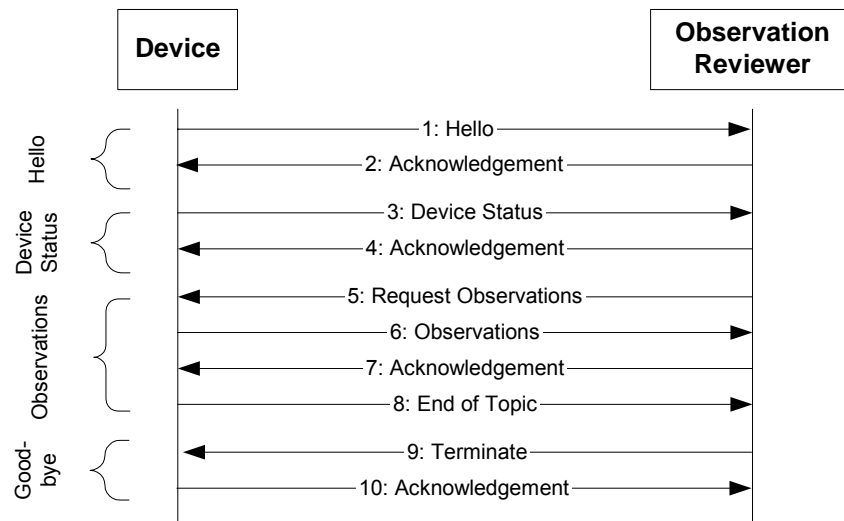

**Figure 54. Simple Glucose Example Message Flow**

The data values shown in the following table will be used in the sample messages.

**Table 77. Simple Glucose Example Message Details**

| #  | MESSAGE | CONTROL ID | MESSAGE DTTM            |
|----|---------|------------|-------------------------|
| 1  | HEL.R01 | 10001      | 11/1/2001 16:30:00-0800 |
| 2  | ACK.R01 | 4001       | 11/1/2001 16:30:01-0800 |
| 3  | DST.R01 | 10002      | 11/1/2001 16:30:03-0800 |
| 4  | ACK.R01 | 4003       | 11/1/2001 16:30:04-0800 |
| 5  | REQ.R01 | 4004       | 11/1/2001 16:30:05-0800 |
| 6  | OBS.R01 | 10003      | 11/1/2001 16:30:06-0800 |
| 7  | ACK.R01 | 4005       | 11/1/2001 16:30:07-0800 |
| 8  | EOT.R01 | 10004      | 11/1/2001 16:30:08-0800 |
| 9  | END.R01 | 4006       | 11/1/2001 16:30:09-0800 |
| 10 | ACK.R01 | 10005      | 11/1/2001 16:30:10-0800 |

The entries in the following table detail the messages sent between the Device and the Observation Reviewer.

**Table 78. Simple Glucose Example Messages**

| DEVICE  | OBSERVATION REVIEWER   |
|---|--|
| <pre> &lt;HEL.R01&gt;   &lt;HDR&gt;     &lt;HDR.control_id V="10001"/&gt;     &lt;HDR.version_id V="POCT1"/&gt;     &lt;HDR.creation_dttm V="2001-11-01T16:30:00-08:00"/&gt;   &lt;/HDR&gt;   &lt;DEV&gt;     &lt;DEV.device_id V="0A-00-19-00-00-23-84"/&gt;     &lt;DEV.vendor_id V="BCHMX"/&gt;     &lt;DEV.model_id V="8000A"/&gt;     &lt;DEV.serial_id V="42367C"/&gt;     &lt;DEV.manufacturer_name V="Biochemtronix"/&gt;     &lt;DEV.hw_version V="8000A-C"/&gt;     &lt;DEV.sw_version V="2001-10-04"/&gt;     &lt;DEV.device_name V="ICU-4 Glucose"/&gt;     &lt;DCP&gt;       &lt;DCP.application_timeout V="60"/&gt;     &lt;/DCP&gt;     &lt;DSC&gt;       &lt;DSC.connection_profile_cd V="SA"/&gt;       &lt;DSC.topics_supported_cd V="DTV"/&gt;       &lt;DSC.topics_supported_cd V="OP_LST"/&gt;       &lt;DSC.directives_supported_cd V="SET_TIME"/&gt;       &lt;DSC.directives_supported_cd V="LOCK"/&gt;       &lt;DSC.directives_supported_cd V="UNLOCK"/&gt;       &lt;DSC.max_message_sz V="800"/&gt;     &lt;/DSC&gt;   &lt;/DEV&gt;   &lt;AP&gt;     &lt;AP.ap_id V="00-10-9D-FF-FF-23-45-67"/&gt;     &lt;AP.port_nbr V="0"/&gt;   &lt;/AP&gt; &lt;/HEL.R01&gt; </pre> | <p>The Conversation starts when a Device sends a "Hello" message to the Data Manager. This message identifies the Device, as well as the Access Point the Device has connected through.</p> <p>Both the Device and Access Point IDs use the EUI-64 identifier scheme (DEV.device_id, AP.ap_id).</p> <p>In the Device Static Capabilities (DSC) object, the Device informs the Data Manager that it supports only the Synchronous Acknowledgement (SA) connection profile. It also informs the Data Manager that it supports the Operator List Topic, and the Set Time, Lock and Unlock Directives.</p> <p>Finally, the Device reports that it is connected through port zero on the Access Point with the ID 00-10-9D-FF-FF-23-45-67. The Device may learn this information through services provided by the Device and Access Point (DAP) interface (See Appendix A).</p> |

| DEVICE   | OBSERVATION REVIEWER  |
|--|---|
| <p>The Data Manager replies to the Hello message with an Acknowledgement, which indicates to the Device that the Data Manager is prepared to conduct a Conversation with this particular Device.</p>   | <pre>&lt;ACK.R01&gt;   &lt;HDR&gt;     &lt;HDR.control_id V="4001"/&gt;     &lt;HDR.version_id V="POCT1"/&gt;     &lt;HDR.creation_dttm V="2001-11-01T16:30:01-0800"/&gt;   &lt;/HDR&gt;   &lt;ACK&gt;     &lt;ACK.type_cd V="AA"/&gt;     &lt;ACK.ack_control_id V="10001"/&gt;   &lt;/ACK&gt; &lt;/ACK.R01&gt;</pre>  |
| <pre>&lt;DST.R01&gt;   &lt;HDR&gt;     &lt;HDR.control_id V="10002"/&gt;     &lt;HDR.version_id V="POCT1"/&gt;     &lt;HDR.creation_dttm V="2001-11-01T16:30:03-08:00"/&gt;   &lt;/HDR&gt;   &lt;DST&gt;     &lt;DST.status_dttm V="2001-11-01T16:30:03-07:00"/&gt;     &lt;DST.new_observations_qty V="1"/&gt;     &lt;DST.new_events_qty V="5"/&gt;     &lt;DST.condition_cd V="R" SN="POCT1" SV="1"/&gt;     &lt;DST.observations_update_dttm V="2001-11-01T08:12:51-08:00"/&gt;     &lt;DST.events_update_dttm V="2001-11-01T08:13:00-08:00"/&gt;     &lt;DST.operators_update_dttm V="2001-10-05T10:27:38-08:00"/&gt;     &lt;DST.patients_update_dttm V="2001-10-31T13:45:56-08:00"/&gt;   &lt;/DST&gt; &lt;/DST.R01&gt;</pre> | <p>The Device sends a Device Status message, which indicates how many observations (new_observations_qty = 1) it is prepared to upload to the Data Manager.</p>   |
| <p>The Data Manager acknowledges the receipt and successful interpretation of the data in the Device Status message.</p>   | <pre>&lt;ACK.R01&gt;   &lt;HDR&gt;     &lt;HDR.control_id V="4003"/&gt;     &lt;HDR.version_id V="POCT1"/&gt;     &lt;HDR.creation_dttm V="2001-11-01T16:30:04-08:00"/&gt;   &lt;/HDR&gt;   &lt;ACK&gt;     &lt;ACK.type_cd V="AA"/&gt;     &lt;ACK.ack_control_id V="10002"/&gt;   &lt;/ACK&gt; &lt;/ACK.R01&gt;</pre>   |
| <p>The Data Manager now requests that the Device transmit its stored observations.</p>   | <pre>&lt;REQ.R01&gt;   &lt;HDR&gt;     &lt;HDR.control_id V="4004"/&gt;     &lt;HDR.version_id V="POCT1"/&gt;     &lt;HDR.creation_dttm V="2001-11-01T16:30:05-08:00"/&gt;   &lt;/HDR&gt;   &lt;REQ&gt;     &lt;REQ.request_cd V="ROBS"/&gt;   &lt;/REQ&gt; &lt;/REQ.R01&gt;</pre>  |
| <pre>&lt;OBS.R01&gt;   &lt;HDR&gt;     &lt;HDR.control_id V="10003"/&gt;     &lt;HDR.version_id V="POCT1"/&gt;     &lt;HDR.creation_dttm V="2001-11-01T16:30:06-08:00"/&gt;   &lt;/HDR&gt;   &lt;SVC&gt;     &lt;SVC.role_cd V="OBS"/&gt;     &lt;SVC.observation_dttm V="2001-11-01T16:29:54-08:00"/&gt;     &lt;SVC.status_cd V="NRM"/&gt;     &lt;SVC.reason_cd V="NEW"/&gt;     &lt;SVC.sequence_nbr V="2524"/&gt;   &lt;PT&gt;     &lt;PT.patient_id V="PT222-55-7777"/&gt;</pre>   | <p>The Device responds to the Request from the Data Manager with a message containing the data from the single clinical observation it has recorded.</p> <p>This Observation message contains information about the service performed, the patient the test was performed on, and the value of the measured parameter.</p> <p>If the Device had stored more than one measurement, this message could contain a series of repeating &lt;SVC&gt; elements – one for each measurement.</p> |

| DEVICE  | OBSERVATION REVIEWER  |
|---|---|
| <pre> &lt;PT.location V="ICU-4"/&gt; &lt;PT.name V="Jan Patient"&gt;   &lt;GIV V="Janet"/&gt;   &lt;FAM V="Patient"/&gt; &lt;/PT.name&gt; &lt;PT.birth_date V="1960-08-29"/&gt; &lt;PT.gender_cd V="F"/&gt; &lt;PT.weight V="110" U="lbs"/&gt; &lt;PT.height V="66" U="inches"/&gt; &lt;OBS&gt;   &lt;OBS.observation_id V="1517-2" SN="LN" DN="Glucose"/&gt;   &lt;OBS.value V="85" U="mg/dL"/&gt;   &lt;OBS.method_cd V="M"/&gt;   &lt;OBS.status_cd V="A"/&gt;   &lt;OBS.interpretation_cd V="N"/&gt;   &lt;OBS.normal_lo-hi_limit V="[80;120]" U="mg/dL"/&gt;   &lt;OBS.critical_lo-hi_limit V="[30;160]" U="mg/dL"/&gt;   &lt;NTE&gt;     &lt;NTE.text V="Temp warning"/&gt;   &lt;/NTE&gt; &lt;/OBS&gt; &lt;/PT&gt; &lt;OPR&gt;   &lt;OPR.operator_id V="OP777-88-9999"/&gt;   &lt;OPR.name V="Pat Operator"&gt;     &lt;GIV V="Patrick"/&gt;     &lt;FAM V="Operator"/&gt;   &lt;/OPR.name&gt; &lt;/OPR&gt; &lt;SPC&gt;   &lt;SPC.specimen_dttm V="2001-11-01T16:27:00-08:00"/&gt; &lt;/SPC&gt; &lt;RGT&gt;   &lt;RGT.name V="GlucoseControl"/&gt;   &lt;RGT.lot_number V="123456" /&gt;   &lt;RGT.expiration_date V="2002-05-31"/&gt; &lt;/RGT&gt; &lt;NTE&gt;   &lt;NTE.text V="New strip"/&gt; &lt;/NTE&gt; &lt;NTE&gt;   &lt;NTE.text V="Repeat test"/&gt; &lt;/NTE&gt; &lt;/SVC&gt; &lt;/OBS.R01&gt; </pre> |   |
| <p><i>The Data Manager acknowledges the receipt and successful interpretation of the data in the Observation message.</i></p>   | <pre> &lt;ACK.R01&gt;   &lt;HDR&gt;     &lt;HDR.control_id V="4005"/&gt;     &lt;HDR.version_id V="POCT1"/&gt;     &lt;HDR.creation_dttm V="2001-11-01T16:30:07-08:00"/&gt;   &lt;/HDR&gt;   &lt;ACK&gt;     &lt;ACK.type_cd V="AA"/&gt;     &lt;ACK.ack_control_id V="10003"/&gt;   &lt;/ACK&gt; &lt;/ACK.R01&gt; </pre> |
| <pre> &lt;EOT.R01&gt;   &lt;HDR&gt;     &lt;HDR.control_id V="10004"/&gt;     &lt;HDR.version_id V="POCT1"/&gt;     &lt;HDR.creation_dttm V="2001-11-01T16:30:08-08:00"/&gt;   &lt;/HDR&gt; &lt;EOT&gt;   &lt;EOT.topic_cd V="OBS" SN="POCT1" SV="1"/&gt; &lt;/EOT&gt; &lt;/EOT.R01&gt; </pre>  | <p><i>The Device indicates that it has no further measurement data to communicate with Observation messages.</i></p>  |

| DEVICE   | OBSERVATION REVIEWER  |
|--|---|
| <p>The Data Manager informs the Device that it is ready to terminate the Conversation.</p>   | <pre>&lt;END.R01&gt; &lt;HDR&gt;   &lt;HDR.control_id V="4006"/&gt;   &lt;HDR.version_id V="POCT1"/&gt;   &lt;HDR.creation_dttm V="2001-11-01T16:30:09-0800"/&gt; &lt;/HDR&gt; &lt;TRM&gt;   &lt;TRM.reason_cd V="NRM"/&gt; &lt;/TRM&gt; &lt;/END.R01&gt;</pre> |
| <pre>&lt;ACK.R01&gt; &lt;HDR&gt;   &lt;HDR.control_id V="10005"/&gt;   &lt;HDR.version_id V="POCT1"/&gt;   &lt;HDR.creation_dttm V="2001-11-01T16:30:10-0800"/&gt; &lt;/HDR&gt; &lt;ACK&gt;   &lt;ACK.type_cd V="AA"/&gt;   &lt;ACK.ack_control_id V="4006"/&gt; &lt;/ACK&gt; &lt;/ACK.R01&gt;</pre> | <p>The Device acknowledges the request to terminate the conversation.</p> <p>After this message has been transmitted, the Device and the Data Manager may tear down the low-level protocols that connect them.</p>  |

### 11.2 Example Blood Gas Observation

The following table illustrates how the Observation message can be used to contain more than one measured result. In this example, the Observation message communicates the values shown in the following table.

**Table 79. Example Blood Gas Message Values**

| MEASUREMENT | VALUE      | MEASUREMENT | VALUE       |
|-------------|------------|-------------|-------------|
| pO2         | 110 mmHg   | pH(T)       | 7.5         |
| pCO2        | 33.2 mmHg  | pCO2(T)     | 30.5 mmHg   |
| pH          | 7.474      | Base Excess | 0.8 mmol/L  |
| K+          | 3.7 mmol/L | Bicarbonate | 25.6 mmol/L |
| tHb         | 13.6 g/dL  | Hematocrit  | 35.7%       |
| RHb         | 1.3%       | pO2(T)      | 101 mmHg    |
| COHb        | 0.75%      | P50(act)    | 24.15 mmHg  |
| O2Hb        | 96.9%      | AaDpO2      | 59.1 mmHg   |
| COHb        | 0.75%      | AaDpO2, T   | 72.0 mmHg   |
| MetHb       | 0.6%       | tO2         | 15.9%       |
| Body Temp   | 35.3 deg C | RI          | 54%         |
| FIO2        | 30%        |             |             |

**Table 80. Example Blood Gas Message**

```
<OBS.R01>
<HDR>
  <HDR.control_id V="1000023"/>
  <HDR.version_id V="POCT1"/>
  <HDR.creation_dttm V="2001-08-15T10:34:35+1:00"/>
</HDR>
```



```

<SVC>
  <SVC.role_cd V="OBS"/>
  <SVC.observation_dttm V="2001-08-15T10:34:35+1:00"/>
  <SVC.status_cd V="NRM"/>
  <SVC.reason_cd V="NEW"/>
  <SVC.sequence_nbr V="4567"/>
  <PT>
    <PT.patient_id V="MR12345678"/>
    <PT.location V="ICU-Bed3"/>
    <PT.name V="Pat Patient">
      <GIV V="Patrick"/>
      <FAM V="Patient"/>
    </PT.name>
    <PT.birth_date V="1956-01-12"/>
    <PT.gender_cd V="M"/>
    <PT.weight V="80" U="kg"/>
    <PT.height V="175" U="cm"/>
    <OBS>
      <OBS.observation_id V="2703-7" SN="LN" DN="OXYGEN">
        <TRANSLTN V="pO2" SN="BCHMX" SV="1.0"/>
      </OBS.observation_id>
      <OBS.value V="110" U="mmHg"/>
      <OBS.method_cd V="M"/>
      <OBS.status_cd V="A"/>
      <OBS.interpretation_cd V="H"/>
      <OBS.normal_lo_hi_limit V="[83;108]" U="mmHg"/>
      <OBS.critical_lo_hi_limit V="[40;130]" U="mmHg"/>
      <NTE>
        <NTE.text V="Stat"/>
      </NTE>
      <NTE>
        <NTE.text V="Measured value above reference range but within the critical limits"/>
      </NTE>
    </OBS>
    <OBS>
      <OBS.observation_id V="11557-6" SN="LN" DN="CARBON DIOXIDE">
        <TRANSLTN V="pCO2" SN="BCHMX" SV="1.0"/>
      </OBS.observation_id>
      <OBS.value V="33.2" U="mmHg"/>
      <OBS.method_cd V="M"/>
      <OBS.status_cd V="A"/>
      <OBS.interpretation_cd V="L"/>
      <OBS.normal_lo_hi_limit V="[35.0;48.0]" U="mmHg"/>
      <OBS.critical_lo_hi_limit V="[20.0;60.0]" U="mmHg"/>
      <NTE>
        <NTE.text V="Stat"/>
      </NTE>
      <NTE>
        <NTE.text V="Measured value below reference range but within the critical limits"/>
      </NTE>
    </OBS>
    <OBS>
      <OBS.observation_id V="11558-4" SN="LN" DN="PH">
        <TRANSLTN V="pH" SN="BCHMX" SV="1.0"/>
      </OBS.observation_id>
      <OBS.value V="7.474"/>
      <OBS.method_cd V="M"/>
      <OBS.status_cd V="A"/>
      <OBS.interpretation_cd V="H"/>
      <OBS.normal_lo_hi_limit V="[7.350;7.450]" U="mmHg"/>
      <OBS.critical_lo_hi_limit V="[7.000;7.600]" U="mmHg"/>
      <NTE>
        <NTE.text V="Stat"/>
      </NTE>
      <NTE>
        <NTE.text V="Measured value above reference range but within the critical limits"/>
      </NTE>
    </OBS>
    <OBS>
      <OBS.observation_id V="6298-4" SN="LN" DN="POTASSIUM">
        <TRANSLTN V="K+" SN="BCHMX" SV="1.0"/>
      </OBS.observation_id>

```

```

<OBS.value V="3.7" U="mmol/L"/>
<OBS.method_cd V="M"/>
<OBS.status_cd V="A"/>
<OBS.interpretation_cd V="N"/>
<OBS.normal_lo-hi_limit V="[3.5;5.0]" U="mmol/L"/>
</OBS>
<OBS>
  <OBS.observation_id V="14775-1" SN="LN" DN="HEMOGLOBIN">
    <TRANSLTN V="tHb" SN="BCHMX" SV="1.0"/>
  </OBS.observation_id>
  <OBS.value V="13.6" U="g/dL"/>
  <OBS.method_cd V="M"/>
  <OBS.status_cd V="A"/>
  <OBS.interpretation_cd V="N"/>
  <OBS.normal_lo-hi_limit V="[13.5;17.5]" U="g/dL"/>
</OBS>
<OBS>
  <OBS.observation_id V="4536-9" SN="LN"
    DN="DEOXYHEMOGLOBIN/HEMOGLOBIN.TOTAL">
    <TRANSLTN V="RHb" SN="BCHMX" SV="1.0"/>
  </OBS.observation_id>
  <OBS.value V="1.3" U="%"/>
  <OBS.method_cd V="M"/>
  <OBS.status_cd V="A"/>
  <OBS.interpretation_cd V="N"/>
  <OBS.normal_lo-hi_limit V="[0.0;2.0]" U="%"/>
</OBS>
<OBS>
  <OBS.observation_id V="O2Hb" SN="BCHMX" SV="1.0"/>
  <OBS.value V="96.9" U="%"/>
  <OBS.method_cd V="M"/>
  <OBS.status_cd V="A"/>
  <OBS.interpretation_cd V="N"/>
  <OBS.normal_lo-hi_limit V="[94.0;99.0]" U="%"/>
</OBS>
<OBS>
  <OBS.observation_id V="20563-3" SN="LN"
    DN="CARBON MONOXIDE.HEMOGLOBIN">
    <TRANSLTN V="COHb" SN="BCHMX" SV="1.0"/>
  </OBS.observation_id>
  <OBS.value V="0.75" U="%"/>
  <OBS.method_cd V="M"/>
  <OBS.status_cd V="A"/>
  <OBS.interpretation_cd V="N"/>
  <OBS.normal_lo-hi_limit V="[0.00;0.80]" U="%"/>
</OBS>
<OBS>
  <OBS.observation_id V="2614-6" SN="LN"
    DN="METHEMOGLOBIN/HEMOGLOBIN.TOTAL">
    <TRANSLTN V="MetHb" SN="BCHMX" SV="1.0"/>
  </OBS.observation_id>
  <OBS.value V="0.6" U="%"/>
  <OBS.method_cd V="M"/>
  <OBS.status_cd V="A"/>
  <OBS.interpretation_cd V="N"/>
  <OBS.normal_lo-hi_limit V="[0.2;0.6]" U="%"/>
</OBS>
<OBS>
  <OBS.observation_id V="20092-3" SN="LN" DN="BODY TEMPERATURE">
    <TRANSLTN V="T" SN="BCHMX" SV="1.0"/>
  </OBS.observation_id>
  <OBS.value V="35.3" U="Cel"/>
  <OBS.method_cd V="I"/>
  <OBS.status_cd V="A"/>
  <OBS.interpretation_cd V="N"/>
</OBS>
<OBS>
  <OBS.observation_id V="19994-3" SN="LN" DN="OXYGEN/INSPIRED GAS.SETTING">
    <TRANSLTN V="FIO2" SN="BCHMX" SV="1.0"/>
  </OBS.observation_id>
  <OBS.value V="30" U="%"/>
  <OBS.method_cd V="I"/>

```

```

    <OBS.status_cd V="A"/>
    <OBS.interpretation_cd V="N"/>
  </OBS>
  <OBS>
    <OBS.observation_id V="pH(T)" SN="BCHMX" SV="1.0"/>
    <OBS.value V="7.5"/>
    <OBS.method_cd V="C"/>
    <OBS.status_cd V="A"/>
    <OBS.interpretation_cd V="N"/>
  </OBS>
  <OBS>
    <OBS.observation_id V="pCO2(T)" SN="BCHMX" SV="1.0"/>
    <OBS.value V="30.5" U="mmHg"/>
    <OBS.method_cd V="C"/>
    <OBS.status_cd V="A"/>
    <OBS.interpretation_cd V="N"/>
  </OBS>
  <OBS>
    <OBS.observation_id V="19235-1" SN="LN" DN="BASE EXCESS-STANDARD">
      <TRANSLTN V="SBE" SN="BCHMX" SV="1.0"/>
    </OBS.observation_id>
    <OBS.value V="0.8" U="mmol/L"/>
    <OBS.method_cd V="C"/>
    <OBS.status_cd V="A"/>
    <OBS.interpretation_cd V="N"/>
  </OBS>
  <OBS>
    <OBS.observation_id V="19230-2" SN="LN" DN="BICARBONATE-STANDARD">
      <TRANSLTN V="SBC" SN="BCHMX" SV="1.0"/>
    </OBS.observation_id>
    <OBS.value V="25.6" U="mmol/L"/>
    <OBS.method_cd V="C"/>
    <OBS.status_cd V="A"/>
    <OBS.interpretation_cd V="N"/>
  </OBS>
  <OBS>
    <OBS.observation_id V="20570-8" SN="LN" DN="HEMATOCRIT">
      <TRANSLTN V="Hct" SN="BCHMX" SV="1.0"/>
    </OBS.observation_id>
    <OBS.value V="35.7" U=""/>
    <OBS.method_cd V="C"/>
    <OBS.status_cd V="A"/>
    <OBS.interpretation_cd V="N"/>
  </OBS>
  <OBS>
    <OBS.observation_id V="19254-2" SN="LN"
      DN="OXYGEN-ADJUSTED TO PATIENTS ACTUAL TEMPERATURE">
      <TRANSLTN V="pO2(T)" SN="BCHMX" SV="1.0"/>
    </OBS.observation_id>
    <OBS.value V="101" U="mmHg"/>
    <OBS.method_cd V="C"/>
    <OBS.status_cd V="A"/>
    <OBS.interpretation_cd V="N"/>
  </OBS>
  <OBS>
    <OBS.observation_id V="19214-6" SN="LN"
      DN="OXYGEN-SATURATION ADJUSTED TO 0.5">
      <TRANSLTN V="p50(act)" SN="BCHMX" SV="1.0"/>
    </OBS.observation_id>
    <OBS.value V="24.15" U="mmHg"/>
    <OBS.method_cd V="E"/>
    <OBS.status_cd V="A"/>
    <OBS.interpretation_cd V="N"/>
  </OBS>
  <OBS>
    <OBS.observation_id V="AaDpO2" SN="BCHMX" SV="1.0"/>
    <OBS.value V="59.1" U="mmHg"/>
    <OBS.method_cd V="E"/>
    <OBS.status_cd V="A"/>
    <OBS.interpretation_cd V="N"/>
  </OBS>
  <OBS>

```

```

<OBS.observation_id V="AaDpO2,T" SN="BCHMX" SV="1.0"/>
<OBS.value V="72.0" U="mmHg"/>
<OBS.method_cd V="E"/>
<OBS.status_cd V="A"/>
<OBS.interpretation_cd V="N"/>
</OBS>
<OBS>
<OBS.observation_id V="19218-7" SN="LN" DN="OXYGEN CONTENT">
  <TRANSLTN V="tO2" SN="BCHMX" SV="1.0"/>
</OBS.observation_id>
<OBS.value V="15.9" U="%"/>
<OBS.method_cd V="C"/>
<OBS.status_cd V="A"/>
<OBS.interpretation_cd V="N"/>
</OBS>
<OBS>
<OBS.observation_id V="RI" SN="BCHMX" SV="1.0"/>
<OBS.value V="54" U="%"/>
<OBS.method_cd V="E"/>
<OBS.status_cd V="A"/>
<OBS.interpretation_cd V="N"/>
</OBS>
</PT>
<OPR>
<OPR.operator_id V="User9876"/>
<OPR.name V="Patty Operator">
  <GIV V="Patty"/>
  <FAM V="Operator"/>
</OPR.name>
</OPR>
<ORD>
<ORD.universal_service_id V="BG-OXI-ELECT"/>
<ORD.ordering_provider_id V="Facility1"/>
<ORD.order_id V="AN0108150034"/>
</ORD>
<SPC>
<SPC.specimen_dttm V="2001-08-15T10:20:00+1:00"/>
<SPC.source_cd V="LLFA"/>
<SPC.type_cd V="BLDA"/>
</SPC>
<NTE>
<NTE.text V="Battery approved by JAG"/>
</NTE>
<NTE>
<NTE.text V="Dr. G. John notified of result"/>
</NTE>
</SVC>
</OBS.R01>

```

### 11.3 Example Nonpatient-related Observation Message

The example in the following table illustrates the use of the OBS.R02 message to communicate control/calibration results. The results in this example pertain to the hypothetical Biochemtronix “LiquidPlus” control reagent, lot number 27498, which expires on June 30, 2002.

**Table 81. Control/Calibration Observation Example Message**

```

<OBS.R02>
  <HDR>
    <HDR.control_id V="10015"/>
    <HDR.version_id V="POCT1"/>
    <HDR.creation_dttm V="2001-11-01T17:23:14-08:00"/>
  </HDR>
  <SVC>
    <SVC.role_cd V="LQC"/>
    <SVC.observation_dttm V="2001-11-01T17:09:10-08:00"/>
    <SVC.status_cd V="NRM"/>

```

```

<SVC.reason_cd V="NEW"/>
<SVC.sequence_nbr V="539"/>
<CTC>
  <CTC.name V="LiquidPlus"/>
  <CTC.lot_number V="27498" />
  <CTC.expiration_date V="2002-06-30"/>
  <CTC.level_cd V="1" SN="BCHMX" SV="1.0"/>
  <OBS>
    <OBS.observation_id V="pH" SN="BCHMX" SV="1.0"/>
    <OBS.value V="7.149" />
    <OBS.method_cd V="M"/>
    <OBS.status_cd V="A"/>
    <OBS.interpretation_cd V="N"/>
    <OBS.normal_lo-hi_limit V="[7.143;7.174]"/>
  </OBS>
  <OBS>
    <OBS.observation_id V="pCO2" SN="BCHMX" SV="1.0"/>
    <OBS.value V="71.1" U="mmHg"/>
    <OBS.method_cd V="M"/>
    <OBS.status_cd V="A"/>
    <OBS.interpretation_cd V="N"/>
    <OBS.normal_lo-hi_limit V="[64.9;74.9]" U="mmHg"/>
  </OBS>
  <OBS>
    <OBS.observation_id V="pO2" SN="BCHMX" SV="1.0"/>
    <OBS.value V="64.5" U="mmHg"/>
    <OBS.method_cd V="M"/>
    <OBS.status_cd V="A"/>
    <OBS.interpretation_cd V="N"/>
    <OBS.normal_lo-hi_limit V="[52.3;66.3]" U="mmHg"/>
  </OBS>
  <OBS>
    <OBS.observation_id V="Na+" SN="BCHMX" SV="1.0"/>
    <OBS.value V="115.4" U="mmol/L"/>
    <OBS.method_cd V="M"/>
    <OBS.status_cd V="A"/>
    <OBS.interpretation_cd V="N"/>
    <OBS.normal_lo-hi_limit V="[110.1;120.1]" U="mmol/L"/>
  </OBS>
  <OBS>
    <OBS.observation_id V="K+" SN="BCHMX" SV="1.0"/>
    <OBS.value V="2.83" U="mmol/L"/>
    <OBS.method_cd V="M"/>
    <OBS.status_cd V="A"/>
    <OBS.interpretation_cd V="N"/>
    <OBS.normal_lo-hi_limit V="[2.19;3.19]" U="mmol/L"/>
  <NTE>
    <NTE.text V="Failed Westgard 2-2s rule"/>
  </NTE>
  <OBS>
    <OBS.observation_id V="Ca--" SN="BCHMX" SV="1.0"/>
    <OBS.value V="1.67" U="mmol/L"/>
    <OBS.method_cd V="M"/>
    <OBS.status_cd V="A"/>
    <OBS.interpretation_cd V="N"/>
    <OBS.normal_lo-hi_limit V="[1.51;1.71]" U="mmol/L"/>
  </OBS>
  <OBS>
    <OBS.observation_id V="Cl-" SN="BCHMX" SV="1.0"/>
    <OBS.value V="82" U="mmol/L"/>
    <OBS.method_cd V="M"/>
    <OBS.status_cd V="A"/>
    <OBS.interpretation_cd V="N"/>
    <OBS.normal_lo-hi_limit V="[75;85]" U="mmol/L"/>
  </OBS>
  <OBS>
    <OBS.observation_id V="tHb" SN="BCHMX" SV="1.0"/>
    <OBS.value V="7.5" U="g/dL"/>
    <OBS.method_cd V="M"/>
    <OBS.status_cd V="A"/>
    <OBS.interpretation_cd V="N"/>

```

```

    <OBS.normal_lo-hi_limit V="[7.4;8.8]" U="g/dL"/>
  </OBS>
  <OBS>
    <OBS.observation_id V="O2Hb" SN="BCHMX" SV="1.0"/>
    <OBS.value V="15.6" U="%"/>
    <OBS.method_cd V="M"/>
    <OBS.status_cd V="A"/>
    <OBS.interpretation_cd V="N"/>
    <OBS.normal_lo-hi_limit V="[9.1;16.6]" U="%"/>
  </OBS>
  <OBS>
    <OBS.observation_id V="COHb" SN="BCHMX" SV="1.0"/>
    <OBS.value V="34.0" U="%"/>
    <OBS.method_cd V="M"/>
    <OBS.status_cd V="A"/>
    <OBS.interpretation_cd V="N"/>
    <OBS.normal_lo-hi_limit V="[33.2;43.2]" U="%"/>
  </OBS>
  <OBS>
    <OBS.observation_id V="MetHb" SN="BCHMX" SV="1.0"/>
    <OBS.value V="47.3" U="%"/>
    <OBS.method_cd V="M"/>
    <OBS.status_cd V="A"/>
    <OBS.interpretation_cd V="N"/>
    <OBS.normal_lo-hi_limit V="[42.3;52.3]" U="%"/>
  </OBS>
  <OBS>
    <OBS.observation_id V="HHb" SN="BCHMX" SV="1.0"/>
    <OBS.value V="2.4" U="%"/>
    <OBS.method_cd V="M"/>
    <OBS.status_cd V="A"/>
    <OBS.interpretation_cd V="N"/>
    <OBS.normal_lo-hi_limit V="[2.2;7.4]" U="%"/>
  </OBS>
</CTC>
<OPR>
  <OPR.operator_id V="OP777-88-9999"/>
  <OPR.name V="Pat Operator">
    <GIV V="Patrick"/>
    <FAM V="Operator"/>
  </OPR.name>
</OPR>
<NTE>
  <NTE.text V="Re-run required"/>
</NTE>
</SVC>
</OBS.R02>

```

## 11.4 Device Events Topic

A Device may report that it has events to communicate by returning a nonzero value in the **DST.new\_events\_qty** field of the Device Status message. If the Observation Reviewer decides to retrieve these new events, it will do so by instigating the Device Events Topic at an appropriate point in the Conversation (see Section 4.1 for message flow details).

The following table illustrates a complete Device Events topic, beginning with a Request message from the Observation Reviewer, and ending with an End of Topic message from the Device.

Table 82. Example Device Events Topic

| DEVICE   | OBSERVATION REVIEWER   |
|--|--|
| <p>The Device Events Topic starts when the Observation Reviewer sends a Request message to the Device that contains the "RDEV" request code.</p>   | <pre>&lt;REQ.R01&gt; &lt;HDR&gt;   &lt;HDR.control_id V="4020"/&gt;   &lt;HDR.version_id V="POCT1"/&gt;   &lt;HDR.creation_dttm V="2001-11-01T16:35:45-08:00"/&gt; &lt;/HDR&gt; &lt;REQ&gt;   &lt;REQ.request_cd V="RDEV"/&gt; &lt;/REQ&gt; &lt;/REQ.R01&gt;</pre>   |
| <pre>&lt;EVS.R01&gt; &lt;HDR&gt;   &lt;HDR.control_id V="10010"/&gt;   &lt;HDR.version_id V="POCT1"/&gt;   &lt;HDR.creation_dttm V="2001-11-01T16:35:49-08:00"/&gt; &lt;/HDR&gt; &lt;EVT&gt;   &lt;EVT.description V="battery low"/&gt;   &lt;EVT.event_dttm V="2001-11-01T07:45:13-08:00"/&gt;   &lt;EVT.severity_cd V="W"/&gt;   &lt;OPR&gt;     &lt;OPR.operator_id V="AUTO"/&gt;   &lt;/OPR&gt; &lt;/EVT&gt; &lt;EVT&gt;   &lt;EVT.description V="battery replaced"/&gt;   &lt;EVT.event_dttm V="2001-11-01T08:10:46-08:00"/&gt;   &lt;EVT.severity_cd V="N"/&gt;   &lt;OPR&gt;     &lt;OPR.operator_id V="OP666-77-8888"/&gt;     &lt;OPR.name V="John Smith"&gt;       &lt;FAM V="Smith"/&gt;       &lt;GIV V="John"/&gt;     &lt;/OPR.name&gt;   &lt;/OPR&gt; &lt;/EVT&gt; &lt;EVT&gt;   &lt;EVT.description V="unrecognized operator"/&gt;   &lt;EVT.event_dttm V="2001-11-01T10:11:46-08:00"/&gt;   &lt;EVT.severity_cd V="N"/&gt;   &lt;OPR&gt;     &lt;OPR.operator_id V="007"/&gt;   &lt;/OPR&gt; &lt;/EVT&gt; &lt;EVT&gt;   &lt;EVT.description V="temperature high"/&gt;   &lt;EVT.event_dttm V="2001-11-01T10:27:25-08:00"/&gt;   &lt;EVT.severity_cd V="W"/&gt;   &lt;OPR&gt;     &lt;OPR.operator_id V="AUTO"/&gt;   &lt;/OPR&gt; &lt;/EVT&gt; &lt;EVT&gt;   &lt;EVT.description V="memory checksum error"/&gt;   &lt;EVT.event_dttm V="2001-11-01T14:51:19-08:00"/&gt;   &lt;EVT.severity_cd V="C"/&gt;   &lt;OPR&gt;     &lt;OPR.operator_id V="AUTO"/&gt;   &lt;/OPR&gt; &lt;/EVT&gt; &lt;/EVS.R01&gt;</pre> | <p>The Device responds to the Request message with one or more EVS.R01 messages containing the new Device Events it has stored.</p> <p>In this example, the Device communicates 5 events (battery low, battery replaced, unrecognized operator, temperature high, memory checksum error) in one message. Alternatively, the Device could choose to package these events in several EVS.R01 messages. In this latter case, the Device would wait until the Observation Reviewer returned an Acknowledgement before sending the next EVS.R01 message.</p> <p>Note that in several cases, the operator is unknown or not applicable. In these cases, the OPR object contains one of the standard operator identifiers ("AUTO," in this case).</p> |

| DEVICE   | OBSERVATION REVIEWER  |
|--|---|
| <p>Once the Observation Reviewer has received (and optionally validated) the Device Events message, it responds with an Acknowledgement message.</p> <p>Once the Device receives this Acknowledgement, it may release the storage committed to save the events just communicated.</p>              | <pre>&lt;ACK.R01&gt;   &lt;HDR&gt;     &lt;HDR.control_id V="4021"/&gt;     &lt;HDR.version_id V="POCT1"/&gt;     &lt;HDR.creation_dttm V="2001-11-01T16:35:50-08:00"/&gt;   &lt;/HDR&gt;   &lt;ACK&gt;     &lt;ACK.type_cd V="AA"/&gt;     &lt;ACK.ack_control_id V="10010"/&gt;   &lt;/ACK&gt; &lt;/ACK.R01&gt;</pre> |
| <pre>&lt;EOT.R01&gt;   &lt;HDR&gt;     &lt;HDR.control_id V="10011"/&gt;     &lt;HDR.version_id V="POCT1"/&gt;     &lt;HDR.creation_dttm V="2001-11-01T16:35:53-08:00"/&gt;   &lt;/HDR&gt;   &lt;EOT&gt;     &lt;EOT.topic_cd V="EVS" SN="POCT1" SV="1"/&gt;   &lt;/EOT&gt; &lt;/EOT.R01&gt;</pre> | <p>When the Device has no additional events to communicate, it signals that the Device Events (EVS) Topic is complete by sending an End of Topic message.</p>   |

### 11.5 Operator List Topic

This section illustrates how the POCT1 messaging scheme can be used to upload a list of valid operators from an Observation Reviewer to a Device. The general message flow used in this example is illustrated in the following figure.

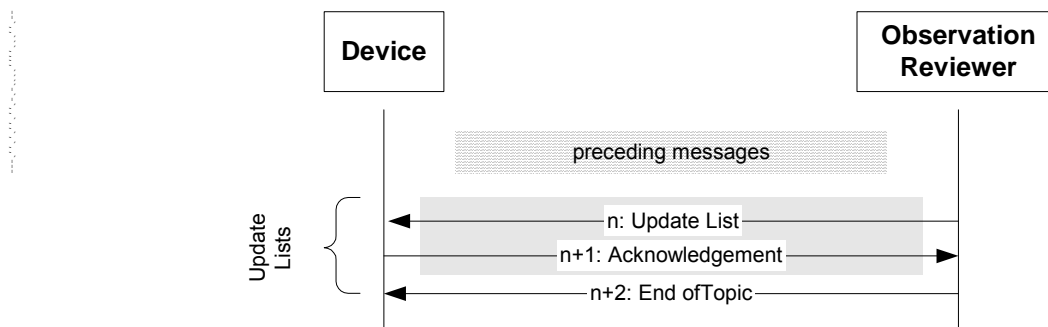

**Figure 55. General Update List Message Flow**

As described in Section 4.1.7, lists may be updated using either a ‘complete’ or an ‘incremental’ update scheme. Table 83 illustrates use of the complete operator list update message (OPL.R01), while Table 84 shows an example of the incremental operator list update message (OPL.R02).



Table 83. Complete Operator List Message Example

| DEVICE  | OBSERVATION REVIEWER  |
|---|---|
| <p>The observation reviewer starts the operator list topic by sending one of the operator list messages (i.e. OPL.R01 or OPL.R02) to the device.</p> <p>This OPL. ROL message illustrates the observation reviewer uploading a very short (7 operator) list to a device. The operators in this message are granted different levels of authority:</p> <p style="padding-left: 40px;">“John Ebert” – granted full ‘supervisor’ access</p> <p>“Joan Nightingale” – allowed to perform only blood gas and coagulation measurements</p> <p style="padding-left: 40px;">“Frank Tech” – granted ‘service’ level access</p> <p>“Dolly Siskel” – Granted ‘Trusteduser’ access to all measurements</p> <p>“Jane Doe” – “Sussy Quatro”, and “Hal Kayak” – granted ‘user’ access to all measurements</p> | <pre> &lt;OPL.R01&gt; &lt;HDR&gt;   &lt;HDR.control_id V="40054"/&gt;   &lt;HDR.version_id V="POCT1"/&gt;   &lt;HDR.creation_dttm V="2001-11-12T10:34:35+1:00"/&gt; &lt;/HDR&gt; &lt;OPR&gt;   &lt;OPR.operator_id V="op123"/&gt;   &lt;OPR.name V="John Ebert"&gt;     &lt;FAM V="Ebert"/&gt;     &lt;GIV V="John"/&gt;   &lt;/OPR.name&gt; &lt;/OPR&gt; &lt;ACC&gt;   &lt;ACC.method_cd V="ALL"/&gt;   &lt;ACC.password&gt;ff129087feab&lt;/ACC.password&gt;   &lt;ACC.active_date V="2001-11-13T00:00:00+1:00"/&gt;   &lt;ACC.permission_level_cd V="1"/&gt; &lt;/ACC&gt; &lt;NTE&gt;   &lt;NTE.text V="Operator allowed to perform all analysis types on instrument"/&gt; &lt;/NTE&gt; &lt;/OPR&gt; &lt;OPR&gt;   &lt;OPR.operator_id V="nurse"/&gt;   &lt;OPR.name V="Joan Nightingale"&gt;     &lt;FAM V="Nightingale"/&gt;     &lt;GIV V="Joan"/&gt;   &lt;/OPR.name&gt; &lt;/OPR&gt; &lt;ACC&gt;   &lt;ACC.method_cd V="BGMEAS" SN="BCHMX" SV="1.0"/&gt;   &lt;ACC.method_cd V="COAGMEAS" SN="BCHMX" SV="1.0"/&gt;   &lt;ACC.password&gt;ea009087feab&lt;/ACC.password&gt;   &lt;ACC.active_date V="2001-11-13T00:00:00+1:00"/&gt;   &lt;ACC.expiration_date V="2002-12-31T00:00:00 +1:00"/&gt;   &lt;ACC.permission_level_cd V="4"/&gt; &lt;/ACC&gt; &lt;NTE&gt;   &lt;NTE.text V="Operator allowed to perform BG and Coagulation measurements"/&gt; &lt;/NTE&gt; &lt;/OPR&gt; &lt;OPR&gt;   &lt;OPR.operator_id V="servicetech"/&gt;   &lt;OPR.name V="Frank Tech"&gt;     &lt;FAM V="Tech"/&gt;     &lt;GIV V="Frank"/&gt;   &lt;/OPR.name&gt; &lt;/OPR&gt; &lt;ACC&gt;   &lt;ACC.method_cd V="ALL"/&gt;   &lt;ACC.password&gt;010adeadbeef&lt;/ACC.password&gt;   &lt;ACC.active_date V="2001-11-13T00:00:00+1:00"/&gt;   &lt;ACC.permission_level_cd V="5"/&gt; &lt;/ACC&gt; &lt;/OPR&gt; &lt;OPR&gt;   &lt;OPR.operator_id V="labresp"/&gt;   &lt;OPR.name V="Dolly Siskel"&gt;     &lt;FAM V="Siskel"/&gt;     &lt;GIV V="Dolly"/&gt;   &lt;/OPR.name&gt; </pre> |

```

<ACC>
  <ACC.method_cd V="ALL"/>
  <ACC.password>891234BEbeef</ACC.password>
  <ACC.active_date V="2001-11-13T00:00:00+1:00"/>
  <ACC.expiration_date V="2002-12-31T00:00:00+1:00"/>
  <ACC.permission_level_cd V="3"/>
</ACC>
</OPR>
<OPR>
  <OPR.operator_id V="nurse1CU"/>
  <OPR.name V="Jane Doe">
    <FAM V="Doe"/>
    <GIV V="Jane"/>
  </OPR.name>
  <ACC>
    <ACC.method_cd V="ALL"/>
    <ACC.password>76bb9087feab</ACC.password>
    <ACC.active_date V="2001-11-13T00:00:00+1:00"/>
    <ACC.expiration_date V="2002-12-31T00:00:00+1:00"/>
    <ACC.permission_level_cd V="4"/>
  </ACC>
</OPR>
<OPR>
  <OPR.operator_id V="nurseEU"/>
  <OPR.name V="Sussy Quatro">
    <FAM V="Quatro"/>
    <GIV V="Sussy"/>
  </OPR.name>
  <ACC>
    <ACC.method_cd V="ALL"/>
    <ACC.password>ea559087feab</ACC.password>
    <ACC.active_date V="2001-11-13T00:00:00+1:00"/>
    <ACC.expiration_date V="2002-12-31T00:00:00+1:00"/>
    <ACC.permission_level_cd V="4"/>
  </ACC>
</OPR>
<OPR>
  <OPR.operator_id V="nursePD"/>
  <OPR.name V="Hal Kayak ">
    <FAM V="Kayak"/>
    <GIV V="Hal"/>
  </OPR.name>
  <ACC>
    <ACC.method_cd V="ALL"/>
    <ACC.password>1234567890ab</ACC.password>
    <ACC.active_date V="2001-11-13T00:00:00+1:00"/>
    <ACC.expiration_date V="2002-12-31T00:00:00+1:00"/>
    <ACC.permission_level_cd V="4"/>
  </ACC>
</OPR>
</OPL.R01>

```

```

<ACK.R01>
  <HDR>
    <HDR.control_id V="4041"/>
    <HDR.version_id V="POCT1"/>
    <HDR.creation_dttm V="2001-11-12T10:35:00+1:00"/>
  </HDR>
  <ACK>
    <ACK.type_cd V="AA"/>
    <ACK.ack_control_id V="40054"/>
  </ACK>
</ACK.R01>

```

After receiving and processing the operator list, the Device responds with an Acknowledgement message.

|   |   |
|---|---|
| <p>If the Observation Reviewer had more operators to send, it could send another OPL.R01 message at this point. In this example, it communicated the entire list in the first message, so it sends an End of Topic message to indicate that the Operator List Update Topic is complete.</p> | <pre>&lt;EOT.R01&gt; &lt;HDR&gt;   &lt;HDR.control_id V="40054"/&gt;   &lt;HDR.version_id V="POCT1"/&gt;   &lt;HDR.creation_dttm V="2001-11-12T10:35:30+1:00"/&gt; &lt;/HDR&gt; &lt;EOT&gt;   &lt;EOT.topic_cd V="OPL" SN="BCHMX" SV="1.0"/&gt; &lt;/EOT&gt; &lt;/EOT.R01&gt;</pre> |
|---|---|

The following table illustrates the use of an incremental Operator List message (OPL.R02). An Observation Reviewer could send this message if a Device reported that it supported incremental list updates (see Section 6.11). This OPL.R02 message would be sent in lieu of the OPL.R01 message in the preceding flow example (Table 83).

**Table 84. Incremental Operator List Update Message Example**

| DEVICE   | OBSERVATION REVIEWER   |
|--|--|
| <p>The Observation Reviewer would use this incremental Operator List Update message to remove one user and add a new user.</p> <p>The first update removes "Joan Nightingale" from the list of authorized users.</p> <p>The second update adds "Nancy Ratchet," with 'user' level permission for all operations on the device.</p> | <pre>&lt;OPL.R02&gt; &lt;HDR&gt;   &lt;HDR.control_id V="40054"/&gt;   &lt;HDR.version_id V="POCT1"/&gt;   &lt;HDR.creation_dttm V="2001-11-12T13:10:35+1:00"/&gt; &lt;/HDR&gt; &lt;UPD&gt;   &lt;UPD.action_cd V="D"/&gt;   &lt;OPR&gt;     &lt;OPR.operator_id V="nurse"/&gt;     &lt;OPR.name V="Joan Nightingale"&gt;       &lt;FAM V="Nightingale"/&gt;       &lt;GIV V="Joan"/&gt;     &lt;/OPR.name&gt;   &lt;/OPR&gt; &lt;/UPD&gt; &lt;UPD&gt;   &lt;UPD.action_cd V="I"/&gt;   &lt;OPR&gt;     &lt;OPR.operator_id V="nurse123"/&gt;     &lt;OPR.name V="Nancy Ratchet"&gt;       &lt;FAM V="Ratchet"/&gt;       &lt;GIV V="Nancy"/&gt;     &lt;/OPR.name&gt;   &lt;ACC&gt;     &lt;ACC.method_cd V="ALL"/&gt;     &lt;ACC.password&gt;ea009087feab&lt;/ACC.password&gt;     &lt;ACC.active_date V="2002-01-03T00:00:00+1:00"/&gt;     &lt;ACC.expiration_date V="2002-12-31T00:00:00+1:00"/&gt;     &lt;ACC.permission_level_cd V="4"/&gt;   &lt;/ACC&gt; &lt;/OPR&gt; &lt;/UPD&gt; &lt;/OPL.R02&gt;</pre> |

## 11.6 Patient List Topic

The Update Patient List Topic is conducted exactly, as is the Operator List Topic (Section 11.5). Like the Operator List update operations, the Observation Reviewer either may send a completely new list of patients to the Device, or may instruct the Device to add/remove particular patients from the Device's list (if the Device supports incremental updates).

Table 85 illustrates a complete Patient List message (OPL.R01). The following table, Table 86, illustrates an incremental patient list update (OPL.R02).

Table 85. Complete Patient List Message Example

| DEVICE   | OBSERVATION REVIEWER  |
|--|---|
| <p>The Observation Reviewer uses this complete Update Patient List message (PTL.R01) to configure the Device to accept the following five patients:</p> <p>Allan Larsen<br/>                     Jegvan Petersen<br/>                     Hilda Bigum<br/>                     Lars P. Krarup<br/>                     Art Blakely</p> | <pre> &lt;PTL.R01&gt; &lt;HDR&gt;   &lt;HDR.control_id V="40055"/&gt;   &lt;HDR.version_id V="POCT1"/&gt;   &lt;HDR.creation_dttm V="2001-11-12T15:00:35+1:00"/&gt; &lt;/HDR&gt; &lt;PT&gt;   &lt;PT.patient_id V="CPR-1712645657"/&gt;   &lt;PT.location V="SengeICU1"/&gt;   &lt;PT.name V="Allan Larsen"&gt;     &lt;FAM V="Larsen"/&gt;     &lt;GIV V="Allan"/&gt;   &lt;/PT.name&gt;   &lt;PT.birth_date V="1964-12-17"/&gt;   &lt;PT.gender_cd V="M"/&gt;   &lt;PT.weight V="67" U="kg"/&gt;   &lt;PT.height V="159" U="cm"/&gt; &lt;/PT&gt; &lt;PT&gt;   &lt;PT.patient_id V="CPR-1712645657"/&gt;   &lt;PT.location V="SengeICU2"/&gt;   &lt;PT.name V="Jegvan Petersen"&gt;     &lt;FAM V="Petersen"/&gt;     &lt;GIV V="Jegvan"/&gt;   &lt;/PT.name&gt;   &lt;PT.birth_date V="1973-04-02"/&gt;   &lt;PT.gender_cd V="M"/&gt;   &lt;PT.weight V="98" U="kg"/&gt;   &lt;PT.height V="193" U="cm"/&gt; &lt;/PT&gt; &lt;PT&gt;   &lt;PT.patient_id V="CPR-0206581234"/&gt;   &lt;PT.location V="SengeICU3"/&gt;   &lt;PT.name V="Hilda Bigum"&gt;     &lt;FAM V="Bigum"/&gt;     &lt;GIV V="Hilda"/&gt;   &lt;/PT.name&gt;   &lt;PT.birth_date V="1958-06-02"/&gt;   &lt;PT.gender_cd V="F"/&gt; &lt;/PT&gt; &lt;PT&gt;   &lt;PT.patient_id V="CPR-0204785454"/&gt;   &lt;PT.location V="SengeICU4"/&gt;   &lt;PT.name V="Lars P. Krarup"&gt;     &lt;FAM V="Krarup"/&gt;     &lt;GIV V="Lars"/&gt;   &lt;/PT.name&gt;   &lt;PT.birth_date V="1978-04-02"/&gt;   &lt;PT.gender_cd V="M"/&gt;   &lt;PT.weight V="75" U="kg"/&gt;   &lt;PT.height V="175" U="cm"/&gt; &lt;/PT&gt; &lt;PT&gt;   &lt;PT.patient_id V="CPR-3006222345"/&gt;   &lt;PT.location V="SengeICU5"/&gt;   &lt;PT.name V="Art Blakely"&gt;     &lt;FAM V="Blakely"/&gt;     &lt;GIV V="Art"/&gt;   &lt;/PT.name&gt;   &lt;PT.birth_date V="1922-06-30"/&gt;   &lt;PT.gender_cd V="M"/&gt; &lt;/PT&gt; &lt;/PTL.R01&gt; </pre> |

**Table 86. Incremental Patient List Message Example**

| DEVICE   | OBSERVATION REVIEWER   |
|--|--|
| <p>The Observation Reviewer uses this incremental Update Patient List message (PTL.R02) to remove one patient and add one patient to the Device's current patient list.</p> <p>The first update removes the patient with the id "CPR-1712645657" (Allan Larsen, from the previous example).</p> <p>The second update adds a new patient ("Liz Kingston," medical record number CPR-2709543659) to the Device's list of known patients.</p> | <pre> &lt;PTL.R02&gt;   &lt;HDR&gt;     &lt;HDR.control_id V="40065"/&gt;     &lt;HDR.version_id V="POCT1"/&gt;     &lt;HDR.creation_dttm V="2001-11-12T23:00:00+1:00"/&gt;   &lt;/HDR&gt;   &lt;UPD&gt;     &lt;UPD.action_cd V="D"/&gt;     &lt;PT&gt;       &lt;PT.patient_id V="CPR-1712645657"/&gt;     &lt;/PT&gt;   &lt;/UPD&gt;   &lt;UPD&gt;     &lt;UPD.action_cd V="I"/&gt;     &lt;PT&gt;       &lt;PT.patient_id V="CPR-2709543659"/&gt;       &lt;PT.location V="SengelCU1"/&gt;       &lt;PT.name V="Liz Kingston "&gt;         &lt;FAM V="Kingston"/&gt;         &lt;GIV V="Elizabeth"/&gt;       &lt;/PT.name&gt;       &lt;PT.birth_date V="1954-09-27"/&gt;       &lt;PT.gender_cd V="M"/&gt;       &lt;PT.weight V="34" U="kg"/&gt;       &lt;PT.height V="205" U="cm"/&gt;     &lt;/PT&gt;   &lt;/UPD&gt; &lt;/PTL.R02&gt; </pre> |

## 11.7 Directives Topic

As described in Section 6.5, a Directive message may take one of three forms. The simplest form (the Basic Directive) consists of a Header followed by a single <DTV> object, which contains a command code. The second standard form (the Complex Directive) consists of a Header followed by one or more 'custom' objects, which are comprised of elements constructed from the basic data types. The Set Time message is the only example of a Complex Directive that is defined by the POCT1 standard. Vendor-specific Directives constitute the final message form. These messages are comprised of a Header, followed either by objects constructed from the basic data types (like the Set Time Directive) or by any valid XML constructs.

These Directive forms are illustrated in the following subsections:

- Basic Directive: Section 11.7.1;
- Set Time Directive: Section 11.7.2;
- Vendor-specific Directive (using basic data types): Section 11.7.3; and
- Vendor-specific Directive (using any valid XML): Section 11.7.3.

### 11.7.1 Basic Directive Example

The following table illustrates the use of the START\_CONTINUOUS Basic Directive to transition the Conversation to the Continuous Profile (Section 4.2). In this example, the Device refuses the Directive,

returning an Escape that explains the reason for the refusal (the Device is in the process of shutting down).

**Table 87. Basic Directive Example Message**

| DEVICE   | OBSERVATION REVIEWER  |
|--|---|
| <p><i>The Observation Reviewer sends this Basic Directive message to attempt to transition the Conversation to the Continuous Profile (Section 4.2).</i></p>   | <pre>&lt;DTV.R01&gt; &lt;HDR&gt;   &lt;HDR.control_id V="4054"/&gt;   &lt;HDR.version_id V="POCT1"/&gt;   &lt;HDR.creation_dttm V="2001-11-01T16:32:47-8:00"/&gt; &lt;/HDR&gt; &lt;DTV&gt;   &lt;DTV.command_cd V="START_CONTINUOUS"/&gt; &lt;/DTV&gt; &lt;/DTV.R01&gt;</pre> |
| <pre>&lt;ESC.R01&gt; &lt;HDR&gt;   &lt;HDR.control_id V="4054"/&gt;   &lt;HDR.version_id V="POCT1"/&gt;   &lt;HDR.creation_dttm V="2001-11-01T16:33:00-8:00"/&gt; &lt;/HDR&gt; &lt;ESC&gt;   &lt;ESC.esc_control_id V="4054"/&gt;   &lt;ESC.detail_cd V="OTH"/&gt;   &lt;ESC.note_txt V="Device is shutting down"/&gt; &lt;/ESC&gt; &lt;/ESC.R01&gt;</pre> | <p><i>In this example, the Device refuses to accept the Start Continuous Directive, because it is currently being shutdown.</i></p>   |

**11.7.2 Set Time Directive Example**

The following table illustrates the Set Time Directive message that an Observation Reviewer uses to set a Device’s internal clock.

**Table 88. Set Time Directive Example Message**

| DEVICE   | OBSERVATION REVIEWER  |
|--|---|
| <p>The Observation Reviewer sends this Set Time Directive message (DTV.R02) to set the Device's time to 4:32:45 PM on November 1, 2001. The Device is also informed that is accurate to ½ second.</p> <p>The &lt;TZ&gt; object instructs the Device that it is currently on Pacific Standard Time (PST), which is 8 hours before Greenwich Mean Time. On April 7, 2002, the Device should adjust to use daylight time (PDT), which is only 7 hours before GMT.</p> | <pre>&lt;DTV.R02&gt; &lt;HDR&gt;   &lt;HDR.control_id V="4050"/&gt;   &lt;HDR.version_id V="POCT1"/&gt;   &lt;HDR.creation_dttm V="2001-11-01T16:32:45-8:00"/&gt; &lt;/HDR&gt; &lt;DTV&gt;   &lt;DTV.command_cd V="SET_TIME"/&gt; &lt;/DTV&gt; &lt;TM&gt;   &lt;TM.dttm V="2001-11-01T16:32:45-8:00"/&gt;   &lt;TM.accy V="0.5"/&gt; &lt;/TM&gt; &lt;TZ&gt;   &lt;TZ.offset V="-08"/&gt;   &lt;TZ.label V="PST"/&gt;   &lt;TZ.new_dttm V="2002-04-07"/&gt;   &lt;TZ.new_offset V="-07"/&gt;   &lt;TZ.new_label V="PDT"/&gt; &lt;/TZ&gt; &lt;LS&gt;   &lt;LS.cumulative V="+32"/&gt;   &lt;LS.new_dttm V="2001-12-31"/&gt;   &lt;LS.new_cumulative V="+32"/&gt; &lt;/LS&gt; &lt;/DTV.R02&gt;</pre> |
| <pre>&lt;ACK.R01&gt; &lt;HDR&gt;   &lt;HDR.control_id V="1001"/&gt;   &lt;HDR.version_id V="POCT1"/&gt;   &lt;HDR.creation_dttm V="2001-11-01T16:32:46-8:00"/&gt; &lt;/HDR&gt; &lt;ACK&gt;   &lt;ACK.type_cd V="AA"/&gt;   &lt;ACK.ack_control_id V="4050"/&gt; &lt;/ACK&gt; &lt;/ACK.R01&gt;</pre>  | <p>The Device responds that it can successfully adjust its clock by returning this positive Acknowledgement message.</p>  |

### 11.7.3 Vendor-specific Directive Examples

The following tables illustrate Vendor-specific Directive messages. For all examples, please note the naming of the message (for naming conventions see Section 6.5.3). The first example employs the approach that uses the basic data types. This message contains information to set up liquid QC parameters on the hypothetical Biochemtronix analyzer.

Table 89. Vendor-specific Directive Example (Standard Data Types)

| XML MESSAGE  | DOCUMENT TYPE DEFINITION  |
|--|---|
| <pre> &lt;DTV.BCHMX.LQCSET&gt;   &lt;HDR&gt;     &lt;HDR.message_type V="DTV.BCHMX.LQCSET"       SN="BCHMX" SV="1.0"/&gt;     &lt;HDR.control_id V="4010"/&gt;     &lt;HDR.version_id V="POCT1"/&gt;     &lt;HDR.creation_dttm       V="2001-11-01T16:32:43-08:00"/&gt;   &lt;/HDR&gt; &lt;/DTV&gt;   &lt;DTV.command_cd V="LQC_SETUP"     SN="BCHMX" SV="1.0"/&gt; &lt;/DTV&gt; &lt;LQC_SETUP&gt;   &lt;material&gt;     &lt;name V="GlucoseControl"/&gt;     &lt;level_cd V="H" SN="BCHMX" SV="1.0"/&gt;     &lt;lot_number V="123456"       /&gt;     &lt;expiration_date V="2002-01-31"/&gt;     &lt;expected_range&gt;       &lt;parameter&gt;         &lt;observation_id V="Glucose"           SN="BCHMX" SV="1.0"/&gt;         &lt;normal_lo-hi_limit V="[79;114]"           U="mg/dL"/&gt;       &lt;/parameter&gt;     &lt;/expected_range&gt;   &lt;/material&gt;   &lt;material&gt;     &lt;name V="GlucoseControl"/&gt;     &lt;level_cd V="L" SN="BCHMX" SV="1.0"/&gt;     &lt;lot_number V="567890"       /&gt;     &lt;expiration_date V="2002- 02-31"/&gt;     &lt;expected_range&gt;       &lt;parameter&gt;         &lt;observation_id V="Glucose"           SN="BCHMX" SV="1.0"/&gt;         &lt;normal_lo-hi_limit V="[47;74]"           U="mg/dL"/&gt;       &lt;/parameter&gt;     &lt;/expected_range&gt;   &lt;/material&gt; &lt;/LQC_SETUP&gt; &lt;/DTV.BCHMX.LQCSET&gt; </pre> | <pre> &lt;!ENTITY % POCT1_MessageElements SYSTEM   "POCT1_MessageElements.dtd"&gt; &lt;!ENTITY % POCT1_DataTypes SYSTEM   "POCT1_DataTypes.dtd"&gt; %POCT1_MessageElements;  &lt;!-- ===== Directive Message Definition --&gt; &lt;!ELEMENT DTV.BCHMX.LQCSET (HDR, DTV,   LQC_SETUP)&gt;  &lt;!-- ===== Directive Object Definitions --&gt; &lt;!ELEMENT HDR (HDR.message_type?, HDR.control_id,   HDR.version_id, HDR.creation_dttm,   HDR.encoding_chars?)&gt;  &lt;!ELEMENT DTV (DTV.command_cd)&gt;  &lt;!ELEMENT LQC_SETUP (material+)&gt;  &lt;!ELEMENT material (name, level_cd, lot_number,   expiration_date, expected_range)&gt;  &lt;!ELEMENT name %ST-cont.model;&gt; &lt;!ATTLIST name   %ST-attrib.list; &gt; &lt;!ELEMENT level_cd %CE-cont.model;&gt; &lt;!ATTLIST level_cd   %CE-attrib.list; &gt; &lt;!ELEMENT lot_number %CS-cont.model;&gt; &lt;!ATTLIST lot_number   %CV-attrib.list; &gt; &lt;!ELEMENT expiration_date %TS-cont.model;&gt; &lt;!ATTLIST expiration_date   %TS-attrib.list; &gt; &lt;!ELEMENT expected_range (parameter+)&gt; &lt;!ELEMENT parameter (observation_id, normal_lo-hi_limit)&gt; &lt;!ELEMENT observation_id %CV-cont.model;&gt; &lt;!ATTLIST observation_id   %CV-attrib.list; &gt; &lt;!ELEMENT normal_lo-hi_limit %IVL_PQ-cont.model;&gt; &lt;!ATTLIST normal_lo-hi_limit   %IVL_PQ-attrib.list; &gt; </pre> |

The following, second, example of a Vendor-specific Directive uses the approach that allows any valid XML content to follow the message Header object. This message contains information to set up and configure the hypothetical Biochemtronix analyzer.



Table 90. Vendor-specific Directive Example (Any Valid XML)

| XML MESSAGE   | DOCUMENT TYPE DEFINITION   |
|---|--|
| <pre> &lt;DTV.BCHMX.DVCSET&gt;   &lt;HDR&gt;     &lt;HDR.message_type V="DTV.BCHMX.DVCSET"       SN="BCHMX" SV="1.0"/&gt;     &lt;HDR.control_id V="4011"/&gt;     &lt;HDR.version_id V="POCT1"/&gt;     &lt;HDR.creation_dttm       V="2001-11-01T16:33:45-08:00"/&gt;   &lt;/HDR&gt;   &lt;DTV&gt;     &lt;DTV.command_cd V="DEVICE_SETUP"       SN="BCHMX" SV="1.0"/&gt;   &lt;/DTV&gt;   &lt;DEVICE_SETUP&gt;     &lt;operator_id&gt;       &lt;oid_char_count format="Alpha-numeric"         16       &lt;/oid_char_count&gt;       &lt;oid_actions invalid="Warn"/&gt;     &lt;/operator_id&gt;     &lt;patient_id&gt;       &lt;pid_char_count format="Numeric"         20       &lt;/pid_char_count&gt;       &lt;pid_actions invalid="Deny"/&gt;     &lt;/patient_id&gt;     &lt;date_time_format date="MMDDYYYY"       time="24-hour"/&gt;   &lt;/DEVICE_SETUP&gt; &lt;/DTV.BCHMX.DVCSET&gt; </pre> | <pre> &lt;!ENTITY % POCT1_MessageElements SYSTEM   "POCT1_MessageElements.dtd"&gt; %POCT1_MessageElements; &lt;!-- ===== Directive Message Definition --&gt; &lt;!ELEMENT DTV.BCHMX.DVCSET (HDR, DTV,   DEVICE_SETUP)&gt; &lt;!-- ===== Directive Object Definitions --&gt; &lt;!ELEMENT HDR (HDR.message_type?, HDR.control_id,   HDR.version_id, HDR.creation_dttm, HDR.encoding_chars?)&gt; &lt;!ELEMENT DTV (DTV.command_cd)&gt; &lt;!ELEMENT DEVICE_SETUP (operator_id?, patient_id?,   date_time_format?)&gt; &lt;!ELEMENT operator_id (oid_char_count, oid_actions)&gt; &lt;!ELEMENT oid_char_count (#PCDATA)&gt; &lt;!ATTLIST oid_char_count   format (Alpha   Numeric   Alpha-numeric) "Alpha" &gt; &lt;!ELEMENT oid_actions EMPTY&gt; &lt;!ATTLIST oid_actions   invalid (Ignore   Warn   Deny) "Deny" &gt; &lt;!ELEMENT patient_id (pid_char_count, pid_actions)&gt; &lt;!ELEMENT pid_char_count (#PCDATA)&gt; &lt;!ATTLIST pid_char_count   format (Alpha   Numeric   Alpha-numeric) "Numeric" &gt; &lt;!ELEMENT pid_actions (#PCDATA)&gt; &lt;!ATTLIST pid_actions   invalid (Ignore   Warn   Deny) "Deny" &gt; &lt;!ELEMENT date_time_format EMPTY&gt; &lt;!ATTLIST date_time_format   date (DDMMYYYY   MMDDYYYY   YYYYMMDD)   "DDMMYYYY"   time (24-hour   12-hour) "24-hour" &gt; </pre> |

## 11.8 Vendor-specific Topic Example

Vendors may also extend the messaging scheme by adding new Conversation Topics (Section 7.2). The following example illustrates how the hypothetical Biochemtronix analyzer might extend the messaging scheme to accommodate a Service Request Topic. Please note the naming of the message (for naming conventions, see Section 7.2).

Table 91. Vendor-specific Topic Example

| DEVICE   | OBSERVATION REVIEWER  |
|--|---|
| <p>The Observation Reviewer begins this vendor-specific topic with a Request message that asks the Biochemtronix Device to report its Service status.</p> <p>The SN and SV attributes of the REQ.request_cd field indicate that this request, "SVC," belongs to the code set managed by the "BCHMX" organization.</p>  | <pre>&lt;REQ.R01&gt; &lt;HDR&gt;   &lt;HDR.control_id V="4030"/&gt;   &lt;HDR.version_id V="POCT1"/&gt;   &lt;HDR.creation_dttm V="2001-11-01T18:39:26-08:00"/&gt; &lt;/HDR&gt; &lt;REQ&gt;   &lt;REQ.request_cd V="SVC" SN="BCHMX" SV="1.0"/&gt; &lt;/REQ&gt; &lt;/REQ.R01&gt;</pre> |
| <pre>&lt;BCHMX.SVC&gt; &lt;HDR&gt;   &lt;HDR.message_type V="SVC" SN="BCHMX" SV="1.0"/&gt;   &lt;HDR.control_id V="10030"/&gt;   &lt;HDR.version_id V="POCT1"/&gt;   &lt;HDR.creation_dttm V="2001-11-01T18:39:33-08:00"/&gt; &lt;/HDR&gt; &lt;OP_STATUS&gt;   &lt;sensors&gt;     &lt;parameter name="pH"/&gt;     &lt;cal_state diagnostic="OK"/&gt;     &lt;smp_state diagnostic="OK"/&gt;     &lt;qc_state scheduled_qc="overdue"/&gt;   &lt;/sensors&gt;   &lt;sensors&gt;     &lt;parameter name="pCO2"/&gt;     &lt;cal_state diagnostic="1PT_DRIFT"/&gt;     &lt;smp_state diagnostic="OK"/&gt;     &lt;qc_state scheduled_qc="overdue"/&gt;   &lt;/sensors&gt;   &lt;sensors&gt;     &lt;parameter name="pO2"/&gt;     &lt;cal_state diagnostic="OK"/&gt;     &lt;smp_state diagnostic="OK"/&gt;     &lt;qc_state scheduled_qc="overdue"/&gt;   &lt;/sensors&gt;   &lt;sensors&gt;     &lt;parameter name="Na"/&gt;     &lt;cal_state diagnostic="OK"/&gt;     &lt;smp_state diagnostic="OK"/&gt;     &lt;qc_state scheduled_qc="overdue"/&gt;   &lt;/sensors&gt;   &lt;sensors&gt;     &lt;parameter name="K"/&gt;     &lt;cal_state diagnostic="OK"/&gt;     &lt;smp_state diagnostic="OK"/&gt;     &lt;qc_state scheduled_qc="overdue"/&gt;   &lt;/sensors&gt;   &lt;sensors&gt;     &lt;parameter name="Ca"/&gt;     &lt;cal_state diagnostic="OK"/&gt;     &lt;smp_state diagnostic="OK"/&gt;     &lt;qc_state scheduled_qc="overdue"/&gt;   &lt;/sensors&gt;   &lt;sensors&gt;     &lt;parameter name="Cl"/&gt;     &lt;cal_state diagnostic="1PT_DRIFT"/&gt;     &lt;smp_state diagnostic="OK"/&gt;     &lt;qc_state scheduled_qc="overdue"/&gt;   &lt;/sensors&gt;   &lt;hardware&gt;     &lt;power level="50_CHARGED"/&gt;     &lt;barcode status="OK"&gt;HIBCCODE128&lt;/barcode&gt;     &lt;memory status="OK"&gt;16Mbytes&lt;/memory&gt;     &lt;electronics status="D302"/&gt;   &lt;/hardware&gt; &lt;/OP_STATUS&gt; &lt;/BCHMX.SVC&gt;</pre> | <p>The Biochemtronix Device that understands and can fulfill the vendor-specific Request message responds with the appropriate "Service" response message.</p> <p>Table 92 contains an example of the DTD which could describe this Biochemtronix "SVC" message.</p>                  |

| DEVICE  | OBSERVATION REVIEWER  |
|---|---|
| <pre> &lt;/hardware&gt; &lt;/OP_STATUS&gt; &lt;INVENTORY&gt;   &lt;meas_cartridge&gt;     &lt;serial_number&gt;576982&lt;/serial_number&gt;     &lt;expiration_date&gt;2002-01-31&lt;/expiration_date&gt;     &lt;samples_remaining&gt;200&lt;/samples_remaining&gt;   &lt;/meas_cartridge&gt;   &lt;aqc_cartridge&gt;     &lt;serial_number&gt;543920&lt;/serial_number&gt;     &lt;expiration_date&gt;2002-03-31&lt;/expiration_date&gt;     &lt;samples_remaining&gt;300&lt;/samples_remaining&gt;   &lt;/aqc_cartridge&gt; &lt;/INVENTORY&gt; &lt;/BCHMX.SVC&gt; </pre> |   |
| <p>After receiving and successfully parsing "SVC" message from the Device, the Observation Reviewer responds with a Positive Acknowledgement message. After receiving this Acknowledgement, the Device is allowed to free any persistent storage dedicated to saving the Service data just communicated.</p> <p>This Acknowledgement message also indicates to the Device that the Observation Reviewer is ready to receive another set of Service data.</p>  | <pre> &lt;ACK.R01&gt;   &lt;HDR&gt;     &lt;HDR.control_id V="4031"/&gt;     &lt;HDR.version_id V="POCT1"/&gt;     &lt;HDR.creation_dttm V="2001-11-01T18:39:44-08:00"/&gt;   &lt;/HDR&gt;   &lt;ACK&gt;     &lt;ACK.type_cd V="AA"/&gt;     &lt;ACK.ack_control_id V="10010"/&gt;   &lt;/ACK&gt; &lt;/ACK.R01&gt; </pre>   |
| <pre> &lt;EOT.R01&gt;   &lt;HDR&gt;     &lt;HDR.control_id V="10031"/&gt;     &lt;HDR.version_id V="POCT1"/&gt;     &lt;HDR.creation_dttm V="2001-11-01T18:39:46-08:00"/&gt;   &lt;/HDR&gt;   &lt;EOT&gt;     &lt;EOT.topic_cd V="SVC" SN="BCHMX" SV="1.0"/&gt;   &lt;/EOT&gt; &lt;/EOT.R01&gt; </pre>  | <p>Since the Device has no further Service data to communicate in this example, it responds to the Observation Reviewer's Acknowledgement message with an End of Topic message, indicating that the Biochemtronix "Service" Topic is complete.</p> <p>After receiving this End of Topic message, the Observation Reviewer is free either to begin another Topic or to terminate the Conversation.</p> |

For illustration, a possible DTD for the Biochemtronix Request Service Response message is shown in the following table.

**Table 92. Biochemtronix Service Request Response Example DTD**

| DOCUMENT TYPE DEFINITION   |
|--|
| <pre> &lt;?xml version="1.0" encoding="UTF-8"?&gt; &lt;ENTITY % POCT1.BCHMX.SVC.1 "-//HL7//DTD DML 1.0//EN"&gt; &lt;ENTITY % POCT1_MessageElements SYSTEM "POCT1_MessageElements.dtd"&gt; %POCT1_MessageElements; &lt;!-- ===== Service Message Definition --&gt; &lt;ELEMENT BCHMX.SVC (HDR, OP_STATUS, INVENTORY)&gt; &lt;!-- ===== Service Object Definitions --&gt; &lt;ELEMENT HDR (HDR.message_type?, HDR.control_id, HDR.version_id, HDR.creation_dttm, HDR.encoding_chars?)&gt; &lt;ELEMENT OP_STATUS (sensors+, hardware)&gt; &lt;ELEMENT sensors (parameter, cal_state, smp_state, qc_state)&gt; &lt;ELEMENT parameter (#PCDATA)&gt; &lt;!ATTLIST parameter   name (pH   pCO2   pO2   Na   K   Ca   Cl) #REQUIRED &gt; &lt;ELEMENT cal_state (#PCDATA)&gt; &lt;!ATTLIST cal_state   diagnostic (OK   1PT_DRIFT   2PT_DRIFT   SLOPE_ERROR   OFFSET_ERROR) "OK" &gt; &lt;ELEMENT smp_state (#PCDATA)&gt; &lt;!ATTLIST smp_state   diagnostic (OK   TEMP_ERROR   OUT_OF_RANGE   QUESTIONABLE_RESULT) "OK" &gt; &lt;ELEMENT qc_state (#PCDATA)&gt; &lt;!ATTLIST qc_state   scheduled_qc (OK   pending   overdue   failed) "OK" &gt; &lt;ELEMENT maintenance (task, task_state)&gt; &lt;ELEMENT task EMPTY&gt; &lt;!ATTLIST task   replace (meas_cartridge   aqc_cartridge   sample_probe   tubing) #REQUIRED   clean (filter   touch_screen   sample_probe) #REQUIRED &gt; &lt;ELEMENT task_state EMPTY&gt; &lt;!ATTLIST task_state   due (pending   overdue) #REQUIRED &gt; &lt;ELEMENT hardware (power, barcode, memory, electronics)&gt; &lt;ELEMENT power (#PCDATA)&gt; &lt;!ATTLIST power   level (FULLY_CHARGED   75_CHARGED   50_CHARGED   25_CHARGED   CRITICAL) #REQUIRED &gt; &lt;ELEMENT barcode (#PCDATA)&gt; &lt;!ATTLIST barcode   status (OK   FAILURE) #REQUIRED &gt; &lt;ELEMENT memory (#PCDATA)&gt; &lt;!ATTLIST memory   status (OK   checksum_error) #REQUIRED &gt; &lt;ELEMENT electronics EMPTY&gt; &lt;!ATTLIST electronics   status (OK   D302   D305) #REQUIRED &gt; &lt;ELEMENT INVENTORY (meas_cartridge, aqc_cartridge)&gt; &lt;ELEMENT meas_cartridge (serial_number, expiration_date, samples_remaining)&gt; &lt;ELEMENT aqc_cartridge (serial_number, expiration_date, samples_remaining)&gt; &lt;ELEMENT serial_number (#PCDATA)&gt; &lt;ELEMENT expiration_date (#PCDATA)&gt; &lt;ELEMENT samples_remaining (#PCDATA)&gt; </pre> |

## 12 Annex E. POCT1 Messaging DTDs (Normative)

In general, the POCT1 messages are composed of objects, which are constructed from the basic data types defined for HL7 v3. To enable the reuse of these type, element, and object definitions, the POCT1 Messaging DTDs are broken into a three-layer hierarchy, illustrated in Figure 56.

At the lowest level, the HL7 v3 Data Types DTD describes the basic type building blocks that the POCT1 messages are constructed from. This file defines such types as Coded Values, Strings, Real Numbers, and Time Stamps.

The next level in the hierarchy, the Message Objects DTD, uses these basic data type definitions to define the elements of the POCT1 messages. For example, this file defines that the Reagent Expiration Date field uses the Time Stamp data type.

The individual Message DTDs exist at the highest level in the hierarchy. There is one of these DTD files for each POCT1 message. These DTDs build on the message elements defined in the Message Objects DTD to specify the composition, hierarchical ordering, and optionality of the objects and elements within a POCT1 message.

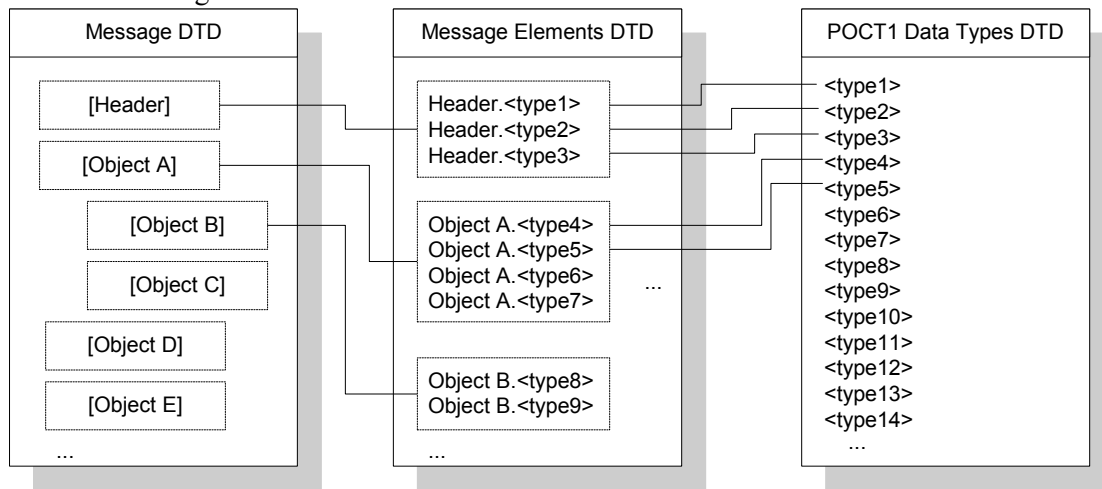

**Figure 56. Message DTD Definition Hierarchy**

The three levels in this hierarchy are described in more detail in the following subsections.

### 12.1 Individual Message DTDs

Every POCT1 message has a unique DTD that defines its structure and content. The normative versions of these DTDs are contained in the tables of Section 6, side-by-side with the associated message model figure.

For illustration, the complete DTD for the ACK.R01 message is shown in the following table.

**Table 93. Acknowledgement (ACK.R01) Message DTD**

| ACK.R01 DTD   |
|---|
| <pre> &lt;?xml version="1.0" encoding="UTF-8"?&gt; &lt;ENTITY % POCT1.ACK.R01.1 "-//POCT1//DTD DML 1.0//EN"&gt; &lt;ENTITY % POCT1_MessageElements.dtd SYSTEM "POCT1_MessageElements.dtd"&gt; %POCT1_MessageElements.dtd;  &lt;!-- ===== Acknowledgement Message--&gt; &lt;ELEMENT ACK.R01 (HDR, ACK)&gt;  &lt;!-- ===== Object Definitions for Acknowledgement Message--&gt; &lt;ELEMENT HDR (HDR.message_type?, HDR.control_id, HDR.version_id, HDR.creation_dttm, HDR.encoding_chars?)&gt; &lt;ELEMENT ACK (ACK.type_cd, ACK.ack_control_id, ACK.note_txt?, ACK.error_detail_cd?)&gt;                     </pre> |

## 12.2 Message Element DTDs

All of the individual message DTDs are built from elements defined in the Message Elements DTD (POCT1\_MessageElements.dtd). This DTD contains definitions for all of the message elements needed by the POCT1 messages. In turn, this DTD relies on the Data Types DTD for definitions of the message elements' basic data types.

The entire POCT1 Message Elements DTD is listed in Table 94.

**Table 94. DML Message Elements DTD**

| DML MESSAGE ELEMENTS DTD  |
|---|
| <pre> &lt;?xml version="1.0" encoding="UTF-8"?&gt; &lt;ENTITY % POCT1_MessageElements.3 "-//POCT1//DTD DML 1.1//EN"&gt; &lt;ENTITY % POCT1_DataTypes SYSTEM "POCT1_DataTypes.dtd"&gt; %POCT1_DataTypes; &lt;!-- ===== AccessControl Element Definitions --&gt; &lt;ELEMENT ACC.method_cd %CV-cont.model;&gt; &lt;!ATTLIST ACC.method_cd     %CV-attrib.list; &gt; &lt;ELEMENT ACC.password %ED-cont.model;&gt; &lt;!ATTLIST ACC.password     %ED-attrib.list; &gt; &lt;ELEMENT ACC.active_date %TS-cont.model;&gt; &lt;!ATTLIST ACC.active_date     %TS-attrib.list; &gt; &lt;ELEMENT ACC.expiration_date %TS-cont.model;&gt; &lt;!ATTLIST ACC.expiration_date     %TS-attrib.list; &gt; &lt;ELEMENT ACC.permission_level_cd %CV-cont.model;&gt; &lt;!ATTLIST ACC.permission_level_cd     %CV-attrib.list; &gt; &lt;!-- ===== AccessPoint Element Definitions --&gt; &lt;ELEMENT AP.ap_id %ST-cont.model;&gt; &lt;!ATTLIST AP.ap_id     %ST-attrib.list; &gt; &lt;ELEMENT AP.port_nbr %INT-cont.model;&gt; &lt;!ATTLIST AP.port_nbr     %INT-attrib.list; &gt; &lt;!-- ===== Acknowledgement Element Definitions --&gt; &lt;ELEMENT ACK.type_cd %CS-cont.model;&gt; &lt;!ATTLIST ACK.type_cd                     </pre> |

| DML MESSAGE ELEMENTS DTD   |
|--|
| <pre> %CS-attrib.list; &gt; &lt;IELEMENT ACK.ack_control_id %ST-cont.model;&gt; &lt;!ATTLIST ACK.ack_control_id   %ST-attrib.list; &gt; &lt;IELEMENT ACK.note_txt %ST-cont.model;&gt; &lt;!ATTLIST ACK.note_txt   %ST-attrib.list; &gt; &lt;IELEMENT ACK.error_detail_cd %CV-cont.model;&gt; &lt;!ATTLIST ACK.error_detail_cd   %CV-attrib.list; &gt; &lt;!-- ===== Control/Calibration Element Definitions--&gt; &lt;IELEMENT CTC.name %ST-cont.model;&gt; &lt;!ATTLIST CTC.name   %ST-attrib.list; &gt; &lt;IELEMENT CTC.lot_number %CV-cont.model;&gt; &lt;!ATTLIST CTC.lot_number   %CV-attrib.list; &gt; &lt;IELEMENT CTC.expiration_date %TS-cont.model;&gt; &lt;!ATTLIST CTC.expiration_date   %TS-attrib.list; &gt; &lt;IELEMENT CTC.level_cd %CV-cont.model;&gt; &lt;!ATTLIST CTC.level_cd   %CV-attrib.list; &gt; &lt;IELEMENT CTC.cal-ver_repetition %INT-cont.model;&gt; &lt;!ATTLIST CTC.cal-ver_repetition   %INT-attrib.list; &gt; &lt;!-- ===== Device Element Definitions --&gt; &lt;IELEMENT DEV.device_id %ST-cont.model;&gt; &lt;!ATTLIST DEV.device_id   %ST-attrib.list; &gt; &lt;IELEMENT DEV.vendor_id %ST-cont.model;&gt; &lt;!ATTLIST DEV.vendor_id   %ST-attrib.list; &gt; &lt;IELEMENT DEV.model_id %ST-cont.model;&gt; &lt;!ATTLIST DEV.model_id   %ST-attrib.list; &gt; &lt;IELEMENT DEV.serial_id %ST-cont.model;&gt; &lt;!ATTLIST DEV.serial_id   %ST-attrib.list; &gt; &lt;IELEMENT DEV.manufacturer_name %ON-cont.model;&gt; &lt;!ATTLIST DEV.manufacturer_name   %ON-attrib.list; &gt; &lt;IELEMENT DEV.hw_version %ST-cont.model;&gt; &lt;!ATTLIST DEV.hw_version   %ST-attrib.list; &gt; &lt;IELEMENT DEV.sw_version %ST-cont.model;&gt; &lt;!ATTLIST DEV.sw_version   %ST-attrib.list; &gt; &lt;IELEMENT DEV.device_name %ST-cont.model;&gt; &lt;!ATTLIST DEV.device_name   %ST-attrib.list; &gt; &lt;IELEMENT DEV.vmd_name %ST-cont.model;&gt; &lt;!ATTLIST DEV.vmd_name </pre> |

| DML MESSAGE ELEMENTS DTD  |
|---|
| <pre> %ST-attrib.list; &gt; &lt;IELEMENT DEV.vmd_id %ST-cont.model;&gt; &lt;!ATTLIST DEV.vmd_id   %ST-attrib.list; &gt; &lt;!-- ===== DeviceCapabilities Element Definitions --&gt; &lt;IELEMENT DCP.application_timeout %REAL-cont.model;&gt; &lt;!ATTLIST DCP.application_timeout   %REAL-attrib.list; &gt; &lt;IELEMENT DCP.vendor_specific %ED-cont.model;&gt; &lt;!ATTLIST DCP.vendor_specific   %ED-attrib.list; &gt; &lt;!-- ===== DeviceStaticCapabilities Element Definitions --&gt; &lt;IELEMENT DSC.connection_profile_cd %CS-cont.model;&gt; &lt;!ATTLIST DSC.connection_profile_cd   %CS-attrib.list; &gt; &lt;IELEMENT DSC.topics_supported_cd %CV-cont.model;&gt; &lt;!ATTLIST DSC.topics_supported_cd   %CV-attrib.list; &gt; &lt;IELEMENT DSC.directives_supported_cd %CV-cont.model;&gt; &lt;!ATTLIST DSC.directives_supported_cd   %CV-attrib.list; &gt; &lt;IELEMENT DSC.max_message_sz %INT-cont.model;&gt; &lt;!ATTLIST DSC.max_message_sz   %INT-attrib.list; &gt; &lt;!-- ===== Device Event Element Definitions --&gt; &lt;IELEMENT EVT.description %ST-cont.model;&gt; &lt;!ATTLIST EVT.description   %ST-attrib.list; &gt; &lt;IELEMENT EVT.event_dttm %TS-cont.model;&gt; &lt;!ATTLIST EVT.event_dttm   %TS-attrib.list; &gt; &lt;IELEMENT EVT.severity_cd %CS-cont.model;&gt; &lt;!ATTLIST EVT.severity_cd   %CS-attrib.list; &gt; &lt;!-- ===== Device Status Element Definitions --&gt; &lt;IELEMENT DST.status_dttm %TS-cont.model;&gt; &lt;!ATTLIST DST.status_dttm   %TS-attrib.list; &gt; &lt;IELEMENT DST.new_observations_qty %INT-cont.model;&gt; &lt;!ATTLIST DST.new_observations_qty   %INT-attrib.list; &gt; &lt;IELEMENT DST.new_events_qty %INT-cont.model;&gt; &lt;!ATTLIST DST.new_events_qty   %INT-attrib.list; &gt; &lt;IELEMENT DST.condition_cd %CV-cont.model;&gt; &lt;!ATTLIST DST.condition_cd   %CV-attrib.list; &gt; &lt;IELEMENT DST.observations_update_dttm %TS-cont.model;&gt; &lt;!ATTLIST DST.observations_update_dttm   %TS-attrib.list; &gt; &lt;IELEMENT DST.events_update_dttm %TS-cont.model;&gt; &lt;!ATTLIST DST.events_update_dttm   %TS-attrib.list; &gt; </pre> |



| DML MESSAGE ELEMENTS DTD  |
|---|
| <pre> &lt;IELEMENT DST.operators_update_dttm %TS-cont.model;&gt; &lt;!ATTLIST DST.operators_update_dttm     %TS-attrib.list; &gt; &lt;IELEMENT DST.patients_update_dttm %TS-cont.model;&gt; &lt;!ATTLIST DST.patients_update_dttm     %TS-attrib.list; &gt; &lt;!-- ===== Directive Element Definitions --&gt; &lt;IELEMENT DTV.command_cd %CV-cont.model;&gt; &lt;!ATTLIST DTV.command_cd     %CV-attrib.list; &gt; &lt;!-- ===== End Of Topic Element Definitions --&gt; &lt;IELEMENT EOT.topic_cd %CV-cont.model;&gt; &lt;!ATTLIST EOT.topic_cd     %CV-attrib.list; &gt; &lt;IELEMENT EOT.version_stamp %ST-cont.model;&gt; &lt;!ATTLIST EOT.version_stamp     %ST-attrib.list; &gt; &lt;IELEMENT EOT.update_dttm %TS-cont.model;&gt; &lt;!ATTLIST EOT.update_dttm     %TS-attrib.list; &gt; &lt;!-- ===== Escape Element Definitions --&gt; &lt;IELEMENT ESC.esc_control_id %ST-cont.model;&gt; &lt;!ATTLIST ESC.esc_control_id     %ST-attrib.list; &gt; &lt;IELEMENT ESC.detail_cd %CS-cont.model;&gt; &lt;!ATTLIST ESC.detail_cd     %CS-attrib.list; &gt; &lt;IELEMENT ESC.note_txt %ST-cont.model;&gt; &lt;!ATTLIST ESC.note_txt     %ST-attrib.list; &gt; &lt;!-- ===== Header Element Definitions --&gt; &lt;IELEMENT HDR.message_type %CV-cont.model;&gt; &lt;!ATTLIST HDR.message_type     %CV-attrib.list; &gt; &lt;IELEMENT HDR.control_id %ST-cont.model;&gt; &lt;!ATTLIST HDR.control_id     %ST-attrib.list; &gt; &lt;IELEMENT HDR.version_id %ST-cont.model;&gt; &lt;!ATTLIST HDR.version_id     %ST-attrib.list; &gt; &lt;IELEMENT HDR.creation_dttm %TS-cont.model;&gt; &lt;!ATTLIST HDR.creation_dttm     %TS-attrib.list; &gt; &lt;IELEMENT HDR.encoding_chars %ST-cont.model;&gt; &lt;!ATTLIST HDR.encoding_chars     %ST-attrib.list; &gt; &lt;!-- ===== Note Element Definitions --&gt; &lt;IELEMENT NTE.text %ST-cont.model;&gt; &lt;!ATTLIST NTE.text     %ST-attrib.list; &gt; &lt;!-- ===== Observation Element Definitions --&gt; &lt;IELEMENT OBS.observation_id %CE-cont.model;&gt; &lt;!ATTLIST OBS.observation_id     %CE-attrib.list; &gt; &lt;IELEMENT OBS.value %PQ-cont.model;&gt; </pre> |

| DML MESSAGE ELEMENTS DTD  |
|---|
| <pre> &lt;!ATTLIST OBS.value   %PQ-attrib.list; &gt; &lt;IELEMENT OBS.qualitative_value %CV-cont.model;&gt; &lt;!ATTLIST OBS.qualitative_value   %CV-attrib.list; &gt; &lt;IELEMENT OBS.method_cd %CS-cont.model;&gt; &lt;!ATTLIST OBS.method_cd   %CS-attrib.list; &gt; &lt;IELEMENT OBS.status_cd %CS-cont.model;&gt; &lt;!ATTLIST OBS.status_cd   %CS-attrib.list; &gt; &lt;IELEMENT OBS.interpretation_cd %CS-cont.model;&gt; &lt;!ATTLIST OBS.interpretation_cd   %CS-attrib.list; &gt; &lt;IELEMENT OBS.normal_lo-hi_limit %IVL_PQ-cont.model;&gt; &lt;!ATTLIST OBS.normal_lo-hi_limit   %IVL_PQ-attrib.list; &gt; &lt;IELEMENT OBS.critical_lo-hi_limit %IVL_PQ-cont.model;&gt; &lt;!ATTLIST OBS.critical_lo-hi_limit   %IVL_PQ-attrib.list; &gt; &lt;!-- ===== Operator Element Definitions --&gt; &lt;IELEMENT OPR.operator_id %ST-cont.model;&gt; &lt;!ATTLIST OPR.operator_id   %ST-attrib.list; &gt; &lt;IELEMENT OPR.name %PN-cont.model;&gt; &lt;!ATTLIST OPR.name   %PN-attrib.list; &gt; &lt;!-- ===== Order Element Definitions --&gt; &lt;IELEMENT ORD.universal_service_id %CE-cont.model;&gt; &lt;!ATTLIST ORD.universal_service_id   %CE-attrib.list; &gt; &lt;IELEMENT ORD.ordering_provider_id %ST-cont.model;&gt; &lt;!ATTLIST ORD.ordering_provider_id   %ST-attrib.list; &gt; &lt;IELEMENT ORD.order_id %CV-cont.model;&gt; &lt;!ATTLIST ORD.order_id   %CV-attrib.list; &gt; &lt;!-- ===== Patient Element Definitions --&gt; &lt;IELEMENT PT.patient_id %ST-cont.model;&gt; &lt;!ATTLIST PT.patient_id   %ST-attrib.list; &gt; &lt;IELEMENT PT.location %ST-cont.model;&gt; &lt;!ATTLIST PT.location   %ST-attrib.list; &gt; &lt;IELEMENT PT.name %PN-cont.model;&gt; &lt;!ATTLIST PT.name   %PN-attrib.list; &gt; &lt;IELEMENT PT.birth_date %TS-cont.model;&gt; &lt;!ATTLIST PT.birth_date   %TS-attrib.list; &gt; &lt;IELEMENT PT.gender_cd %CS-cont.model;&gt; &lt;!ATTLIST PT.gender_cd   %CS-attrib.list; &gt; </pre> |

| DML MESSAGE ELEMENTS DTD   |
|--|
| <pre> &lt;IELEMENT PT.weight %PQ-cont.model;&gt; &lt;!ATTLIST PT.weight   %PQ-attrib.list; &gt; &lt;IELEMENT PT.height %PQ-cont.model;&gt; &lt;!ATTLIST PT.height   %PQ-attrib.list; &gt; &lt;!-- ===== Reagent Element Definitions --&gt; &lt;IELEMENT RGT.name %ST-cont.model;&gt; &lt;!ATTLIST RGT.name   %ST-attrib.list; &gt; &lt;IELEMENT RGT.lot_number %CV-cont.model;&gt; &lt;!ATTLIST RGT.lot_number   %CV-attrib.list; &gt; &lt;IELEMENT RGT.expiration_date %TS-cont.model;&gt; &lt;!ATTLIST RGT.expiration_date   %TS-attrib.list; &gt; &lt;!-- ===== Request Element Definitions --&gt; &lt;IELEMENT REQ.request_cd %CV-cont.model;&gt; &lt;!ATTLIST REQ.request_cd   %CV-attrib.list; &gt; &lt;!-- ===== Service Element Definitions --&gt; &lt;IELEMENT SVC.role_cd %CS-cont.model;&gt; &lt;!ATTLIST SVC.role_cd   %CS-attrib.list; &gt; &lt;IELEMENT SVC.observation_dttm %TS-cont.model;&gt; &lt;!ATTLIST SVC.observation_dttm   %TS-attrib.list; &gt; &lt;IELEMENT SVC.status_cd %CS-cont.model;&gt; &lt;!ATTLIST SVC.status_cd   %CS-attrib.list; &gt; &lt;IELEMENT SVC.reason_cd %CS-cont.model;&gt; &lt;!ATTLIST SVC.reason_cd   %CS-attrib.list; &gt; &lt;IELEMENT SVC.sequence_nbr %INT-cont.model;&gt; &lt;!ATTLIST SVC.sequence_nbr   %INT-attrib.list; &gt; &lt;!-- ===== Specimen Element Definitions --&gt; &lt;IELEMENT SPC.specimen_id %CV-cont.model;&gt; &lt;!ATTLIST SPC.specimen_id   %CV-attrib.list; &gt; &lt;IELEMENT SPC.specimen_dttm %TS-cont.model;&gt; &lt;!ATTLIST SPC.specimen_dttm   %TS-attrib.list; &gt; &lt;IELEMENT SPC.source_cd %CE-cont.model;&gt; &lt;!ATTLIST SPC.source_cd   %CE-attrib.list; &gt; &lt;IELEMENT SPC.type_cd %CE-cont.model;&gt; &lt;!ATTLIST SPC.type_cd   %CE-attrib.list; &gt; &lt;!-- ===== Termination Element Definitions --&gt; &lt;IELEMENT TRM.reason_cd %CV-cont.model;&gt; &lt;!ATTLIST TRM.reason_cd   %CV-attrib.list; &gt; &lt;IELEMENT TRM.note_txt %ST-cont.model;&gt; &lt;!ATTLIST TRM.note_txt </pre> |

| DML MESSAGE ELEMENTS DTD   |
|--|
| <pre> %ST-attrib.list; &gt; &lt;!-- ===== Update Element Definitions --&gt; &lt;IELEMENT UPD.action_cd %CS-cont.model;&gt; &lt;!ATTLIST UPD.action_cd     %CS-attrib.list; &gt; &lt;!-- ===== Time Element Definitions --&gt; &lt;IELEMENT TM.dttm %TS-cont.model;&gt; &lt;!ATTLIST TM.dttm     %TS-attrib.list; &gt; &lt;IELEMENT TM.accy %REAL-cont.model;&gt; &lt;!ATTLIST TM.accy     %REAL-attrib.list; &gt; &lt;!-- ===== Time Zone Element Definitions --&gt; &lt;IELEMENT TZ.offset %ST-cont.model;&gt; &lt;!ATTLIST TZ.offset     %ST-attrib.list; &gt; &lt;IELEMENT TZ.label %ST-cont.model;&gt; &lt;!ATTLIST TZ.label     %ST-attrib.list; &gt; &lt;IELEMENT TZ.new_dttm %TS-cont.model;&gt; &lt;!ATTLIST TZ.new_dttm     %TS-attrib.list; &gt; &lt;IELEMENT TZ.new_offset %ST-cont.model;&gt; &lt;!ATTLIST TZ.new_offset     %ST-attrib.list; &gt; &lt;IELEMENT TZ.new_label %ST-cont.model;&gt; &lt;!ATTLIST TZ.new_label     %ST-attrib.list; &gt; &lt;!-- ===== Leap Second Element Definitions --&gt; &lt;IELEMENT LS.cumulative %INT-cont.model;&gt; &lt;!ATTLIST LS.cumulative     %INT-attrib.list; &gt; &lt;IELEMENT LS.new_dttm %TS-cont.model;&gt; &lt;!ATTLIST LS.new_dttm     %TS-attrib.list; &gt; &lt;IELEMENT LS.new_cumulative %INT-cont.model;&gt; &lt;!ATTLIST LS.new_cumulative     %INT-attrib.list; &gt; </pre> |

### 12.3 POCT1 Data Types DTD

The POCT1 Data Types DTD rests at the lowest layer of the DTD hierarchy. This file defines the basic data types that are by the POCT1 messages.

These data types definitions are referenced with permission from the *HL7 Version 3 Data Types – Ballot Draft II (revision 1.3)* document. Although the final HL7 v3 standard may contain changes to this document, this data type DTD is normative for the POCT1 standard.

**POCT1 DATA TYPES DTD**

```
<!ENTITY % POCT1_DataTypes.1 "-//HL7//DTD V3DT 1.0//EN">
<!--
    Typical usage within a DTD for an HMD or the PRA...

    <!ENTITY % V3DT PUBLIC
        "-//HL7//DTD V3DT 1.0//EN"
        "http://www.hl7.org/XXX/v3dt.dtd">
    %V3DT;
```

The URI used as a system identifier with the public identifier allows the user agent to download the DTD as needed.

The FPI for the V3DT DTD is:

```
"//HL7//DTD V3DT 1.0//EN"
```

and its URI is:

```
http://www.hl7.org/XXX/v3dt.dtd
```

The URI given for this DTD includes the path XXX, since at this time the path where it will be archived has yet to be determined. Once a general policy for archival storage of HL7 DTD has been determined, XXX will be replaced with the proper path.

-->  
<!--

the following type declarations are in the order they are specified in the abstract document (except for some of the "subsidiary" types, such as ADXP for AD, which are defined before their "principle" type)

-->  
<!--

Each datatype definition contains "HL7 Processing Rules", which are statements of required application level validity checks over and above what the DTD expresses. The rules are written as XPath expressions. The intention is that the set of rules for each datatype will be embedded in a fixed attribute and a receiving application could then evaluate them and if any fail the receiving application would know that the instance wasn't legal. At present, some of the rules are still expressed in the syntax that was used for this purpose for the HIMSS demo.

-->  
<!-- ..... Code Set null.code.set.....

|      |                   |
|------|-------------------|
| NI   | no information    |
| NA   | not applicable    |
| UNK  | unknown           |
| NASK | not asked         |
| ASKU | asked but unknown |
| NAV  | not available     |
| OTH  | other             |
| PINF | positive infinity |
| NINF | negative infinity |

Note: NP (not present) does not appear in this list, because it should never be sent in an instance. The ITS layer should give the application layer a null flavor of NP for all XML elements/attributes not present in the instance

-->  
<!ENTITY % null.code.set '(NI|NA|UNK|NASK|ASKU|NAV|OTH|PINF|NINF)'>  
<!-- ===== Boolean (BL) =====

\*\*\*\*\* HL7 Processing Rules \*\*\*\*\*

```
@NULL or @V
@PROB >= 0 and @PROB <= 1
*****
```

```
<someBL V="true"/>
<someOtherBL V="false"/>
```

**POCT1 DATA TYPES DTD**

Note: the boolean literals have changed (from T and F) to conform with the lexical space of the XML Schema boolean datatype.

```

===== -->
<!-- ..... Code Set boolean.code.set..... -->
      true   TRUE
      false  FALSE
-->
<!ENTITY % boolean.code.set '(true|false)'>
<!ENTITY % BL-cont.model '(NOTE?, CONFID?)>
<!ENTITY % BL-attr.list '
T      NMTOKEN #FIXED "BL"
NULL   %null.code.set; #IMPLIED
V      %boolean.code.set; #IMPLIED
V-T    NMTOKEN #FIXED "BL"
V-HL7_NAME CDATA #FIXED "value"
VT     CDATA #IMPLIED
VT-T   NMTOKEN #FIXED "IVL_TS"
VT-HL7_NAME CDATA #FIXED "validTime"
PROB   CDATA #IMPLIED
PROB-T NMTOKEN #FIXED "REAL"
PROB-HL7_NAME CDATA #FIXED "probability"
'>
<!--
===== Binary Data (BIN) =====
The XML ITS does not need to define this datatype, since the
only use of it is within the ED datatype, and a complete definition
of the datatype is not needed for that purpose
=====
-->
<!--
===== Encapsulated Data (ED) =====

***** HL7 Processing Rules *****

@V or child::REF
@NULL or @MT
THUMBNAIL[not(child::THUMBNAIL) or child::THUMBNAIL/@NULL]
@T='BIN' and string-length(@V)>0
not(@IAC) or @IA
@PROB >= 0 and @PROB <= 1
@T='ST' and (not(@COMPN) or not(child::REF) or not(child::THUMBNAIL))
*****

<someED>cellulitis of the left foot</someED>
<someED MT="image/png"
  IC="aA5mb7c8TXtu392KMsaSa2MKkAwL5LKAo2d99azAs3MdUdw">
  <REF V="http://radiology.iuinc.edu/xrays/128s8d9ej229se32s.jpg"
    VT="200007200845-0820845" />
  <THUMBNAIL MT="image/jpeg" ENC="B64">
    MNYD83jmMdomSJUEdmde9j44zmMir6edjzMMljdMDSsWdIJdkslJR3373jeu83
    6edjzMMljdMDSsWdIJdkslJR3373jeu83MNYD83jmMdomSJUEdmde9j44zmMir
    ...
    omSJUEdmde9j44zmMiromSJUEdmde9j44zmMirdMDSsWdIJdkslJR3373jeu83
    4zmMir6edjzMMljdMDSsWdIJdkslJR3373jeu83==
  </THUMBNAIL>
</someED>
<someED MT="application/msword" ENC="B64" COMPN="GZ">
  omSJUEdmde9j44zmMiromSJUEdmde9j44zmMirdMDSsWdIJdkslJR3373jeu83
  6edjzMMljdMDSsWdIJdkslJR3373jeu83MNYD83jmMdomSJUEdmde9j44zmMir
  ...
  MNYD83jmMdomSJUEdmde9j44zmMir6edjzMMljdMDSsWdIJdkslJR3373jeu83
  4zmMir6edjzMMljdMDSsWdIJdkslJR3373jeu83==
</someED>

uses xml:lang for the language property

When applicable, the value of the charset property should be
obtained from the encoding pseudo attribute of the XML declaration
...if the XML declaration or the encoding pseudo attribute is not
present in the instance, then the charset is assumed to be UTF-8

```

| POCT1 DATA TYPES DTD  |
|---|
| <p>(as per the XML 1.0 Rec)</p> <p>Declares the xml namespace as a fixed attribute, which is in scope for this element and its children</p> <p>If present, the value of the IA attribute shall be base64 encoded</p> <p>See note below on the declaration of THUMBNAIL, regarding inherited values for ED properties</p> <p>if @IC is valued, then we know that integrityCheckAlgorithm is "SHA-1"</p> <p>value is text() node ONLY if that text() node is the first child<br/>only 1st occurrence of REF, THUMBNAIL, NOTE and CONFID are significant</p> <p>@ENC does not correspond to any property<br/>===== --&gt;</p> <pre> &lt;!ENTITY % ED-cont.model'(#PCDATA   REF   THUMBNAIL   NOTE   CONFID)*&gt; &lt;!ENTITY % ED-attrib.list' T          (ST ED) "ED" NULL      %null.code.set; #IMPLIED ENC       (B64 TXT) "TXT" MT        CDATA "text/plain" MT-T      NMTOKEN #FIXED "CS" MT-DOMAIN NMTOKEN #FIXED "2.16.840.1.113883.6.10" MT-HL7_NAME CDATA #FIXED "type" xml:lang  NMTOKEN #IMPLIED xml:lang-T NMTOKEN #FIXED "CS" xml:lang-HL7_NAME CDATA #FIXED "language" COMPN     (DF GZ ZL Z) #IMPLIED COMPN-T   NMTOKEN #FIXED "CS" COMPN-HL7_NAME CDATA #FIXED "compression" COMPN-DOMAIN NMTOKEN #FIXED "2.16.840.1.113883.5.1009" IC        CDATA #IMPLIED IC-T      NMTOKEN #FIXED "BIN" IC-HL7_NAME CDATA #FIXED "integrityCheck" VT        CDATA #IMPLIED VT-T      NMTOKEN #FIXED "IVL_TS" VT-HL7_NAME CDATA #FIXED "validTime" PROB      CDATA #IMPLIED PROB-T    NMTOKEN #FIXED "REAL" PROB-HL7_NAME CDATA #FIXED "probability" &gt; &lt;!-- ===== String (ST) =====  ***** HL7 Processing Rules *****  @NULL or length(@V)&gt;0 @PROB &gt;= 0 and @PROB &lt;= 1 *****  &lt;someST V="required ST"/&gt;  The value of the charset property should be obtained from the encoding pseudo attribute of the XML declaration ...if the XML declaration or the encoding pseudo attribute is not present in the instance, then the CHARSET is assumed to be UTF-8 (as per the XML 1.0 Rec)  Declares the xml namespace as a fixed attribute, which is in scope for this element and its children  uses xml:lang for the language property ===== --&gt;                 </pre> <pre> &lt;!ENTITY % ST-cont.model'(#PCDATA   NOTE   CONFID)*&gt; &lt;!ENTITY % ST-attrib.list' T          CDATA #FIXED "ST" NULL      %null.code.set; #IMPLIED V         CDATA #IMPLIED V-T       NMTOKEN #FIXED "BIN" V-HL7_NAME CDATA #FIXED "value"                 </pre> |

```

POCT1 DATA TYPES DTD

MT          CDATA #FIXED "text/plain"
MT-T        NMTOKEN #FIXED "CS"
MT-HL7_NAME CDATA #FIXED "type"
  xml:lang  NMTOKEN #IMPLIED
xml:lang-T  NMTOKEN #FIXED "CS"
xml:lang-HL7_NAME CDATA #FIXED "language"
VT          CDATA #IMPLIED
VT-T        NMTOKEN #FIXED "IVL_TS"
VT-HL7_NAME CDATA #FIXED "validTime"
PROB        CDATA #IMPLIED
PROB-T      NMTOKEN #FIXED "REAL"
PROB-HL7_NAME CDATA #FIXED "probability"
'>
<!-- ===== Concept Descriptor (CD) =====

***** HL7 Processing Rules *****

@NULL or @V
not(@S) or @V
not(@V) or @DN
not(@ORIGTXT) or not(child::ORIGTXT)
@PROB >= 0 and @PROB <= 1
*****

<someCD T="CD" V="10.3" S="ICD" SV="99" DN="The meaning of the code"/>

Rather than have a "code" attribute, simply uses the V attribute
(but V-HL7_NAME is still "code")

When S and SV appear in a containing element, they are the default
coding system and version for subordinate codes.

You can have EITHER an ORIGTXT child element OR an ORIGTXT attribute,
but not both. If @ORIGTXT is present, then its value is assumed to
be the ID of some other element in the current message/document, in
which case the value of the originalText property is the PCDATA content
of that element. If @ORIGTXT is present, but doesn't resolve to
the ID of some element or the element it resolves to has no PCDATA content,
then the value of the originalText property is NULL with the
default flavor. Note: with this mechanism, @ORIGTXT can only
point to originalText that, essentially, has a media type of
"text/plain".

===== -->
<!ENTITY % CD-cont.model '(TRANSLTN*, ORIGTXT?, MODIFIER*, NOTE?, CONFID?)>
<!ENTITY % CD-attrib.list '
T          (CD|CE|CV|CS) "CD"
NULL      %null.code.set; #IMPLIED
V          CDATA #IMPLIED
V-T       NMTOKEN #FIXED "ST"
V-HL7_NAME CDATA #FIXED "code"
DN        CDATA #IMPLIED
DN-T      NMTOKEN #FIXED "ST"
DN-HL7_NAME CDATA #FIXED "displayName"
S         CDATA #IMPLIED
S-T       NMTOKEN #FIXED "OID"
S-HL7_NAME CDATA #FIXED "codeSystem"
SN        CDATA #IMPLIED
SN-T      NMTOKEN #FIXED "ST"
SN-HL7_NAME CDATA #FIXED "codeSystemName"
SV        CDATA #IMPLIED
SV-T      NMTOKEN #FIXED "ST"
SV-HL7_NAME CDATA #FIXED "codeSystemVersion"
ORIGTXT   IDREF #IMPLIED
ORIGTXT-T NMTOKEN #FIXED "ST"
ORIGTXT-HL7_NAME CDATA #FIXED "originalText"
VT        CDATA #IMPLIED
VT-T      NMTOKEN #FIXED "IVL_TS"
VT-HL7_NAME CDATA #FIXED "validTime"
PROB      CDATA #IMPLIED
PROB-T    NMTOKEN #FIXED "REAL"

```



```

POCT1 DATA TYPES DTD

  PROB-HL7_NAME  CDATA #FIXED "probability"
>
<!-- ===== Concept Role (CR) =====

***** HL7 Processing Rules *****

  @NULL or child::VALUE
  @PROB >= 0 and @PROB <= 1
*****

  As suggested in the abstract doc, the default value for the
  inverted property is "false"

  CR is modeled essentially as an extension of CD which
  adds the name and inverse properties (but the ITS restricts
  the use of @S, @SN and @SV)
===== -->
<!ENTITY % CR-cont.model '(NAME?, %CD-cont.model;)>
<!ENTITY % CR-attrib.list '
  T          NMTOKEN #FIXED "CR"
  NULL      %null.code.set; #IMPLIED
  V          CDATA #IMPLIED
  V-T       NMTOKEN #FIXED "ST"
  V-HL7_NAME CDATA #FIXED "code"
  DN        CDATA #IMPLIED
  DN-T      NMTOKEN #FIXED "ST"
  DN-HL7_NAME CDATA #FIXED "displayName"
  ORIGTXT   IDREF #IMPLIED
  ORIGTXT-T NMTOKEN #FIXED "ST"
  ORIGTXT-HL7_NAME CDATA #FIXED "originalText"
  INV       %boolean.code.set; "false"
  INV-T     NMTOKEN #FIXED "BL"
  INV-HL7_NAME CDATA #FIXED "inverted"
  VT        CDATA #IMPLIED
  VT-T      NMTOKEN #FIXED "IVL_TS"
  VT-HL7_NAME CDATA #FIXED "validTime"
  PROB      CDATA #IMPLIED
  PROB-T    NMTOKEN #FIXED "REAL"
  PROB-HL7_NAME CDATA #FIXED "probability"
>
<!-- ===== Coded Simple Value (CS) =====

***** HL7 Processing Rules *****

  @NULL or @V
  @PROB >= 0 and @PROB <= 1
*****

  Rather than have a "code" attribute, simply uses the V attribute

===== -->
<!ENTITY % CS-cont.model '(NOTE?, CONFID?)>
<!ENTITY % CS-attrib.list '
  T          NMTOKEN #FIXED "CS"
  NULL      %null.code.set; #IMPLIED
  V          CDATA #IMPLIED
  V-T       NMTOKEN #FIXED "ST"
  V-HL7_NAME CDATA #FIXED "code"
  DN        CDATA #IMPLIED
  DN-T      NMTOKEN #FIXED "ST"
  DN-HL7_NAME CDATA #FIXED "displayName"
  VT        CDATA #IMPLIED
  VT-T      NMTOKEN #FIXED "IVL_TS"
  VT-HL7_NAME CDATA #FIXED "validTime"
  PROB      CDATA #IMPLIED
  PROB-T    NMTOKEN #FIXED "REAL"
  PROB-HL7_NAME CDATA #FIXED "probability"
>
<!-- ===== Coded Value (CV) =====

***** HL7 Processing Rules *****

```

**POCT1 DATA TYPES DTD**

@NULL or @V  
 not(@S) or @V  
 child::ORIGTXT[@MT='text/plain']  
 @PROB >= 0 and @PROB <= 1  
 \*\*\*\*\*

Rather than have a "code" attribute, simply uses the V attribute

When S and SV appear in a containing element, they are the default coding system and version for subordinate codes.

You can have EITHER an ORIGTXT child element OR an ORIGTXT attribute, but not both. If @ORIGTXT is present, then its value is assumed to be the ID of some other element in the current message/document, in which case the value of the originalText property is the PCDATA content of that element. If @ORIGTXT is present, but doesn't resolve to the ID of some element or the element it resolves to has no PCDATA content, then the value of the originalText property is NULL with the default flavor. Note: with this mechanism, @ORIGTXT can only point to originalText that, essentially, has a media type of "text/plain".

===== -->

```
<!ENTITY % CV-cont.model '(ORIGTXT?, NOTE?, CONFID?)>
<!ENTITY % CV-attrib.list '
T          (CS|CV) "CV"
NULL      %null.code.set; #IMPLIED
V          CDATA #IMPLIED
V-T       NMTOKEN #FIXED "ST"
V-HL7_NAME CDATA #FIXED "code"
DN        CDATA #IMPLIED
DN-T      NMTOKEN #FIXED "ST"
DN-HL7_NAME CDATA #FIXED "displayName"
S         CDATA #IMPLIED
S-T       NMTOKEN #FIXED "OID"
S-HL7_NAME CDATA #FIXED "codeSystem"
SN        CDATA #IMPLIED
SN-T      NMTOKEN #FIXED "ST"
SN-HL7_NAME CDATA #FIXED "codeSystemName"
SV        CDATA #IMPLIED
SV-T      NMTOKEN #FIXED "OID"
SV-HL7_NAME CDATA #FIXED "codeSystemVersion"
ORIGTXT   IDREF #IMPLIED
ORIGTXT-T NMTOKEN #FIXED "ST"
ORIGTXT-HL7_NAME CDATA #FIXED "originalText"
VT        CDATA #IMPLIED
VT-T      NMTOKEN #FIXED "IVL_TS"
VT-HL7_NAME CDATA #FIXED "validTime"
PROB      CDATA #IMPLIED
PROB-T    NMTOKEN #FIXED "REAL"
PROB-HL7_NAME CDATA #FIXED "probability"
'>
<!-- ===== Coded With Equivalents (CE) =====

***** HL7 Processing Rules *****

@NULL or @V
not(@S) or @V
child::TRANSTN[@T='CV' or @T='CS']
@PROB >= 0 and @PROB <= 1
*****

Rather than have a "code" attribute, simply uses the V attribute

When S and SV appear in a containing element, they are the default coding system and version for subordinate codes.

You can have EITHER an ORIGTXT child element OR an ORIGTXT attribute, but not both. If @ORIGTXT is present, then its value is assumed to be the ID of some other element in the current message/document, in
```

| POCT1 DATA TYPES DTD |   |
|----------------------|---|
|                      | <p>which case the value of the originalText property is the PCDATA content of that element. If @ORIGTXT is present, but doesn't resolve to the ID of some element or the element it resolves to has no PCDATA content, then the value of the originalText property is NULL with the default flavor. Note: with this mechanism, @ORIGTXT can only point to originalText that, essentially, has a media type of "text/plain".</p> <p>===== --&gt;</p> <pre>&lt;!ENTITY % CE-cont.model '(ORIGTXT?, TRANSLTN*, NOTE?, CONFID?)&gt; &lt;!ENTITY % CE-attrib.list ' T          (CS CV CE) "CE" NULL      %null.code.set; #IMPLIED V          CDATA #IMPLIED V-T       NMTOKEN #FIXED "ST" V-HL7_NAME CDATA #FIXED "code" DN        CDATA #IMPLIED DN-T      NMTOKEN #FIXED "ST" DN-HL7_NAME CDATA #FIXED "displayName" S         CDATA #IMPLIED S-T       NMTOKEN #FIXED "OID" S-HL7_NAME CDATA #FIXED "codeSystem" SN        CDATA #IMPLIED SN-T      NMTOKEN #FIXED "ST" SN-HL7_NAME CDATA #FIXED "codeSystemName" SV        CDATA #IMPLIED SV-T      NMTOKEN #FIXED "OID" SV-HL7_NAME CDATA #FIXED "codeSystemVersion" ORIGTXT   IDREF #IMPLIED ORIGTXT-T NMTOKEN #FIXED "ST" ORIGTXT-HL7_NAME CDATA #FIXED "originalText" VT        CDATA #IMPLIED VT-T      NMTOKEN #FIXED "IVL_TS" VT-HL7_NAME CDATA #FIXED "validTime" PROB     CDATA #IMPLIED PROB-T   NMTOKEN #FIXED "REAL" PROB-HL7_NAME CDATA #FIXED "probability" &gt; &lt;!-- ===== ISO Object Identifier (OID) ===== no need for a separate OID type, since it is never used by itself, but only as the type of property of some other type, in which case it is also used just as a CDATA attribute ===== --&gt; &lt;!-- ===== Instance Identifier (II) =====  ***** HL7 Processing Rules *****  @NULL or @RT @PROB &gt;= 0 and @PROB &lt;= 1 *****  &lt;someII V="optional ST" RT="required OID" ANN="optional ST" VT='2000-06-23-2000-07-24'/&gt;  ===== --&gt; &lt;!ENTITY % II-cont.model '(TYPE?, NOTE?, CONFID?)&gt; &lt;!ENTITY % II-attrib.list ' T          NMTOKEN #FIXED "II" NULL      %null.code.set; #IMPLIED EX        CDATA #IMPLIED EX-T      NMTOKEN #FIXED "ST" EX-HL7_NAME CDATA #FIXED "extension" RT        CDATA #IMPLIED RT-T      NMTOKEN #FIXED "OID" RT-HL7_NAME CDATA #FIXED "root" AAN       CDATA #IMPLIED AAN-T     NMTOKEN #FIXED "ST" AAN-HL7_NAME CDATA #FIXED "assigningAuthorityName" VT        CDATA #IMPLIED VT-T      NMTOKEN #FIXED "IVL_TS" VT-HL7_NAME CDATA #FIXED "validTime" PROB     CDATA #IMPLIED</pre> |

```

POCT1 DATA TYPES DTD

PROB-T      NMTOKEN #FIXED "REAL"
PROB-HL7_NAME CDATA #FIXED "probability"
>
<!-- ===== Uniform Resource Locator (URL) =====
no need for a separate URL type, since it is never used
by itself, but only as the type of property of some other type,
in which case it is also used just as a CDATA attribute

===== -->
<!-- ===== telecommunication address (TEL) =====

***** HL7 Processing Rules *****

@NULL or @V
@PROB >= 0 and @PROB <= 1
*****

<someTEL V="http://example.com/somePath" USE="WP"/>
<someTEL V="tel:(358)555-1234" USE="HP EC"/>

===== -->
<!ENTITY % TEL-cont.model '(NOTE?, CONFID?)>
<!ENTITY % TEL-attrib.list '
T      NMTOKEN #FIXED "TEL"
NULL   %null.code.set; #IMPLIED
V      CDATA #IMPLIED
V-T    NMTOKEN #FIXED "URL"
V-HL7_NAME CDATA #FIXED "value"
USE     NMTOKENS #IMPLIED
USE-T   NMTOKEN #FIXED "SET_CS"
USE-DOMAIN CDATA #FIXED "2.16.840.1.113883.5.1011"
USE-HL7_NAME CDATA #FIXED "use"
VT      CDATA #IMPLIED
VT-T    NMTOKEN #FIXED "GTS"
VT-HL7_NAME CDATA #FIXED "validTime"
PROB    CDATA #IMPLIED
PROB-T  NMTOKEN #FIXED "REAL"
PROB-HL7_NAME CDATA #FIXED "probability"
>
<!-- ===== address part (ADXP) =====
address part type codes are represented by sub-element GIs in the
enclosing AD
===== -->
<!ENTITY % ADXP-cont.model '(NOTE?, CONFID?)>
<!ENTITY % ADXP-attrib.list '
T      NMTOKEN #FIXED "ADXP"
NULL   %null.code.set; #IMPLIED
V      CDATA #IMPLIED
V-T    NMTOKEN #FIXED "ST"
V-HL7_NAME CDATA #FIXED "value"
VT      CDATA #IMPLIED
VT-T    NMTOKEN #FIXED "IVL_TS"
VT-HL7_NAME CDATA #FIXED "validTime"
PROB    CDATA #IMPLIED
PROB-T  NMTOKEN #FIXED "REAL"
PROB-HL7_NAME CDATA #FIXED "probability"
>
<!-- ===== Postal and Residential Address (AD) =====

***** HL7 Processing Rules *****

@NULL or child::LIT or child::DEL or child::CNT etc.
@PROB >= 0 and @PROB <= 1
*****

<someAD USE="PST"/>
<HNR V="970"/>
<STR V="Post St"/>
<DIR V="NE"/>
<CTY V="Alameda"/>
<STA V="CA"/>
    
```

| POCT1 DATA TYPES DTD   |
|--|
| <pre> &lt;ZIP V="94501"/&gt; &lt;/someAD&gt;  Formatted property is represented as @V  ===== --&gt; &lt;!ENTITY % AD-cont.model '((LIT DEL CNT STA CTY ZIP STR HNR DIR ADL POB)*, NOTE?, CONFID?)&gt; &lt;!ENTITY % AD-attrib.list ' T          NMTOKEN #FIXED "AD" NULL      %null.code.set; #IMPLIED V          CDATA #IMPLIED V-T       NMTOKEN #FIXED "ST" V-HL7_NAME CDATA #FIXED "formatted" USE       NMTOKENS #IMPLIED USE-T     NMTOKEN #FIXED "SET_CS" USE-DOMAIN CDATA #FIXED "2.16.840.1.113883.5.1012" USE-HL7_NAME CDATA #FIXED "use" VT        CDATA #IMPLIED VT-T     NMTOKEN #FIXED "GTS" VT-HL7_NAME CDATA #FIXED "validTime" PROB      CDATA #IMPLIED PROB-T    NMTOKEN #FIXED "REAL" PROB-HL7_NAME CDATA #FIXED "probability" &gt; &lt;!-- ===== Person Name Part (PNXP) =====  ***** HL7 Processing Rules *****  @NULL or @V *****  name part type codes are represented by sub-element GIs in the enclosing PN  ===== --&gt; &lt;!ENTITY % PNXP-cont.model '(NOTE?, CONFID?)&gt; &lt;!ENTITY % PNXP-attrib.list ' T          NMTOKEN #FIXED "PNXP" NULL      %null.code.set; #IMPLIED V          CDATA #IMPLIED V-T       NMTOKEN #FIXED "ST" V-HL7_NAME CDATA #FIXED "value" QUAL      NMTOKENS #IMPLIED QUAL-T    NMTOKEN #FIXED "SET_CS" QUAL-DOMAIN CDATA #FIXED "2.16.840.1.113883.5.1014" QUAL-HL7_NAME CDATA #FIXED "qualifier" VT        CDATA #IMPLIED VT-T     NMTOKEN #FIXED "IVL_TS" VT-HL7_NAME CDATA #FIXED "validTime" PROB      CDATA #IMPLIED PROB-T    NMTOKEN #FIXED "REAL" PROB-HL7_NAME CDATA #FIXED "probability" &gt; &lt;!-- ===== Person Name (PN) =====  ***** HL7 Processing Rules *****  The order in which the name parts are sent should represent the natural order for displaying the name. It is not required to break names down using all of the elements, although individual nations may require specific elements. Displaying a name depends on the white space rules included in the V3DT report. It may be necessary to preserve white space in certain elements.  @PROB &gt;= 0 and @PROB &lt;= 1 ***** &lt;somePN NOTE="This is an example of 'Wesley Rishel'"&gt;   &lt;FAM V="Rishel" QUAL="BR RE"/&gt;   &lt;GIV V="Wesley" QUAL="BR RE"/&gt; &lt;/somePN&gt;  &lt;somePN NOTE="This is an example of 'Irma Corine Jongeneel-de Haas'"&gt; </pre> |

```

POCT1 DATA TYPES DTD

<GIV V="Irma" QUAL="RE"/>
<GIV V="Corine" QUAL="RE"/>
<FAM V="Jongeneel" QUAL="RE SP"/>
<DEL V="-"/>
<FAM V="de Haas" QUAL="RE BR"/>
</somePN>

uses @V to represent the formatted property
===== -->
<!ENTITY % PN-cont.model '((GIV|MID|FAM|PFX|SFX|DEL)*, NOTE?, CONFID?)>
<!ENTITY % PN-attrib.list '
T          NMTOKEN #FIXED "PN"
NULL      %null.code.set; #IMPLIED
V          CDATA #IMPLIED
V-T       NMTOKEN #FIXED "ST"
V-HL7_NAME CDATA #FIXED "formatted"
VT        CDATA #IMPLIED
VT-T      NMTOKEN #FIXED "IVL_TS"
VT-HL7_NAME CDATA #FIXED "validTime"
PROB      CDATA #IMPLIED
PROB-T    NMTOKEN #FIXED "REAL"
PROB-HL7_NAME CDATA #FIXED "probability"
'>
<!-- ===== Organization Name (ON) =====

***** HL7 Processing Rules *****

@NULL or @V
@PROB >= 0 and @PROB <= 1
*****

<someON TYPE="optional CS" V="optional ST"/>

===== -->
<!ENTITY % ON-cont.model '(NOTE?, CONFID?)>
<!ENTITY % ON-attrib.list '
T          NMTOKEN #FIXED "ON"
NULL      %null.code.set; #IMPLIED
V          CDATA #IMPLIED
V-T       NMTOKEN #FIXED "ST"
V-HL7_NAME CDATA #FIXED "value"
VT        CDATA #IMPLIED
VT-T      NMTOKEN #FIXED "IVL_TS"
VT-HL7_NAME CDATA #FIXED "validTime"
PROB      CDATA #IMPLIED
PROB-T    NMTOKEN #FIXED "REAL"
PROB-HL7_NAME CDATA #FIXED "probability"
'>
<!-- ===== Quantity (QTY) =====

***** HL7 Processing Rules *****

@NULL or @V
###not xpath### INT|REAL|TS ::= V or PQ|MO ::= V, U?
not(@T='PQ' or @T='MO' or @T='TS') or @U ### I think does the HL7-PR above
@PROB >= 0 and @PROB <= 1
*****

<someQTY T="INT|REAL|PQ|MO" V="123.75" U="mg/dL"/>

Unless @T=TS, @CAL is meaningless and should be ignored

The cardinality/default value for QTY is defined as a param entity
whose starting value is "#IMPLIED". We do it this way so that the
NUM and DENOM properties of RTO can take on the default value
"1" as specified in the abstract ballot.

===== -->
<!ENTITY % QTY-cont.model '(NOTE?, CONFID?)>
<!ENTITY % QTY-default.value #IMPLIED'>
<!ENTITY % QTY-attrib.list '

```

| POCT1 DATA TYPES DTD |  |
|----------------------|--|
| T                    | (INT REAL PQ MO TS) "INT"  |
| NULL                 | %null.code.set; #IMPLIED   |
| V                    | CDATA %QTY-default.value;  |
| V-T                  | NMTOKEN #FIXED "ST"  |
| V-HL7_NAME           | CDATA #FIXED "value"   |
| U                    | CDATA #IMPLIED   |
| U-T                  | NMTOKEN #FIXED "CS"  |
| U-HL7_NAME           | CDATA #FIXED "unit"  |
| VT                   | CDATA #IMPLIED   |
| VT-T                 | NMTOKEN #FIXED "IVL_TS"  |
| VT-HL7_NAME          | CDATA #FIXED "validTime"   |
| PROB                 | CDATA #IMPLIED   |
| PROB-T               | NMTOKEN #FIXED "REAL"  |
| PROB-HL7_NAME        | CDATA #FIXED "probability"   |
| >                    |  |
| <!--                 | ===== Integer (INT) =====  |
|                      | ***** HL7 Processing Rules *****   |
|                      | @NULL or @V  |
|                      | @PROB >= 0 and @PROB <= 1  |
|                      | *****  |
|                      | <someINT V="required ST"/>   |
|                      | The "exceptional" values positive and negative infinity are represented as null flavors  |
|                      | ===== -->  |
| <!ENTITY %           | INT-cont.model '(NOTE?, CONFID?)>  |
| <!ENTITY %           | INT-attr.list '  |
| T                    | NMTOKEN #FIXED "INT"   |
| NULL                 | %null.code.set; #IMPLIED   |
| V                    | CDATA #IMPLIED   |
| V-T                  | NMTOKEN #FIXED "ST"  |
| V-HL7_NAME           | CDATA #FIXED "value"   |
| VT                   | CDATA #IMPLIED   |
| VT-T                 | NMTOKEN #FIXED "IVL_TS"  |
| VT-HL7_NAME          | CDATA #FIXED "validTime"   |
| PROB                 | CDATA #IMPLIED   |
| PROB-T               | NMTOKEN #FIXED "REAL"  |
| PROB-HL7_NAME        | CDATA #FIXED "probability"   |
| >                    |  |
| <!--                 | ===== Real Number (REAL) =====   |
|                      | ***** HL7 Processing Rules *****   |
|                      | @NULL or @V  |
|                      | @PROB >= 0 and @PROB <= 1  |
|                      | *****  |
|                      | <someREAL V="required REAL"/>  |
|                      | The "exceptional" values positive and negative infinity are represented as null flavors  |
|                      | Note: XML Schema currently allows trailing zeros in its literals of type decimal, hence we will be able to get the precision property from the literals. |
|                      | ===== -->  |
| <!ENTITY %           | REAL-cont.model '(NOTE?, CONFID?)>   |
| <!ENTITY %           | REAL-attr.list '   |
| T                    | NMTOKEN #FIXED "REAL"  |
| NULL                 | %null.code.set; #IMPLIED   |
| V                    | CDATA #IMPLIED   |
| V-T                  | NMTOKEN #FIXED "ST"  |
| V-HL7_NAME           | CDATA #FIXED "value"   |
| VT                   | CDATA #IMPLIED   |
| VT-T                 | NMTOKEN #FIXED "IVL_TS"  |
| VT-HL7_NAME          | CDATA #FIXED "validTime"   |
| PROB                 | CDATA #IMPLIED   |
| PROB-T               | NMTOKEN #FIXED "REAL"  |

```

POCT1 DATA TYPES DTD

  PROB-HL7_NAME  CDATA #FIXED "probability"
  >
  <!-- ===== Ratio of Quantities (RTO) =====

  ***** HL7 Processing Rules *****

  @NULL or (child::NUM and not(child::NUM/@NULL))
  @NULL or (child::DENOM[@V!=0] and not(child::DENOM/@NULL))
  @PROB >= 0 and @PROB <= 1
  *****

  <someRTO>
    <NUM T="INT|REAL|PQ|MO" V="123.75" U="mg/dL"/>
    <DENOM T="INT|REAL|PQ|MO" V="123.75" U="mg/dL"/>
  </someRTO>

  ===== -->
  <!ENTITY % RTO-cont.model '((NUM, DENOM)?, NOTE?, CONFID?)>
  <!ENTITY % RTO-attr.list '
  T          NMTOKEN #FIXED "RTO"
  NULL      %null.code.set; #IMPLIED
  VT        CDATA #IMPLIED
  VT-T      NMTOKEN #FIXED "IVL_TS"
  VT-HL7_NAME CDATA #FIXED "validTime"
  PROB      CDATA #IMPLIED
  PROB-T    NMTOKEN #FIXED "REAL"
  PROB-HL7_NAME CDATA #FIXED "probability"
  >
  <!-- ===== Physical Quantity (PQ) =====

  ***** HL7 Processing Rules *****

  @NULL or (@V and @U)
  @PROB >= 0 and @PROB <= 1
  *****

  <somePQ V="1123.37" U="cm"/>

  ===== -->
  <!ENTITY % PQ-cont.model '(NOTE?, CONFID?)>
  <!ENTITY % PQ-attr.list '
  T          NMTOKEN #FIXED "PQ"
  NULL      %null.code.set; #IMPLIED
  V          CDATA #IMPLIED
  V-T       NMTOKEN #FIXED "REAL"
  V-HL7_NAME CDATA #FIXED "value"
  U          CDATA #IMPLIED
  U-T       NMTOKEN #FIXED "CS"
  U-HL7_NAME CDATA #FIXED "unit"
  VT        CDATA #IMPLIED
  VT-T      NMTOKEN #FIXED "IVL_TS"
  VT-HL7_NAME CDATA #FIXED "validTime"
  PROB      CDATA #IMPLIED
  PROB-T    NMTOKEN #FIXED "REAL"
  PROB-HL7_NAME CDATA #FIXED "probability"
  >
  <!-- ===== Monetary Amount (MO) =====

  ***** HL7 Processing Rules *****

  @NULL or (@V and @U)
  @PROB >= 0 and @PROB <= 1
  *****

  <someMO V="1123.37" U="USD"/>

  ===== -->
  <!ENTITY % MO-cont.model '(NOTE?, CONFID?)>
  <!ENTITY % MO-attr.list '
  T          NMTOKEN #FIXED "MO"
  
```



```

POCT1 DATA TYPES DTD

NULL      %null.code.set; #IMPLIED
V         CDATA #IMPLIED
V-T      NMTOKEN #FIXED "REAL"
V-HL7_NAME CDATA #FIXED "value"
U         CDATA #IMPLIED
U-T      NMTOKEN #FIXED "CS"
  U-DOMAIN CDATA #FIXED "2.16.840.1.113883.6.9"
U-HL7_NAME CDATA #FIXED "currency"
VT        CDATA #IMPLIED
VT-T     NMTOKEN #FIXED "IVL_TS"
VT-HL7_NAME CDATA #FIXED "validTime"
PROB      CDATA #IMPLIED
PROB-T   NMTOKEN #FIXED "REAL"
PROB-HL7_NAME CDATA #FIXED "probability"
>
<!-- ===== Point in Time (TS) =====

***** HL7 Processing Rules *****

@NULL or @V
@PROB >= 0 and @PROB <= 1
*****

<someTS V="19990924162403-0800"/>

  The time zone property is conveyed as part of value (V)
  instead of as a separate property

  offset is not represented at all
  ===== -->
<ENTITY % TS-cont.model '(NOTE?, CONFID?)>
<ENTITY % TS-attr.list '
  T      NMTOKEN #FIXED "TS"
  NULL   %null.code.set; #IMPLIED
  V      CDATA #IMPLIED
  V-T    NMTOKEN #FIXED "ST"
  V-HL7_NAME CDATA #FIXED "value"
  VT     CDATA #IMPLIED
  VT-T   NMTOKEN #FIXED "IVL_TS"
  VT-HL7_NAME CDATA #FIXED "validTime"
  PROB   CDATA #IMPLIED
  PROB-T NMTOKEN #FIXED "REAL"
  PROB-HL7_NAME CDATA #FIXED "probability"
>
<!-- We do not need SET<T> for all T -->
<!-- We do not need LIST<T> for all T -->
<!-- We do not need BAG<T> for all T -->
<!-- ===== interval of physical quantities (IVL_PQ) =====

  To avoid redundancy and difficulty in processing we factor the
  units from both bounds into one unit of the interval. This
  requires both low and high bound to have a common unit. Width,
  however must have its own unit, since in difference-scale
  quantities the width may be of a different unit.

***** HL7 Processing Rules *****

The following combinations of components are valid:

@NULL or @V
@PROB >= 0 and @PROB <= 1
*****

<someIVL_PQ LOW="optional REAL" LOW_CLOSED="optional BL" HIGH="optional REAL"
  HIGH_CLOSED="optional BL" UNIT="optional CV" WID="optional PQ"/>

  The XML ITS does not support promotion of a PQ into an IVL_PQ,
  although demotion of IVL_PQ to PQ is supported (using @V and @U)
  ===== -->
<ENTITY % IVL_PQ-cont.model "(NOTE?, CONFID?)>
<ENTITY % IVL_PQ-attr.list "

```

| POCT1 DATA TYPES DTD          |   |
|-------------------------------|---|
| T                             | (IVL_PQ PQ) 'IVL_PQ'  |
| NULL                          | %null.code.set; #IMPLIED  |
| V                             | CDATA #IMPLIED  |
| V-T                           | NMTOKEN #FIXED 'REAL'   |
| V-HL7_NAME                    | CDATA #FIXED 'value'  |
| U                             | CDATA #IMPLIED  |
| U-T                           | NMTOKEN #FIXED 'CS'   |
| U-HL7_NAME                    | CDATA #FIXED 'unit'   |
| VT                            | CDATA #IMPLIED  |
| VT-T                          | NMTOKEN #FIXED 'IVL_TS'   |
| VT-HL7_NAME                   | CDATA #FIXED 'validTime'  |
| PROB                          | CDATA #IMPLIED  |
| PROB-T                        | NMTOKEN #FIXED 'REAL'   |
| PROB-HL7_NAME                 | CDATA #FIXED 'probability'  |
| ">                            |   |
| <!--                          | ===== interval of points in time (IVL_TS) =====   |
|                               | ***** HL7 Processing Rules *****  |
|                               | The following combinations of components are valid:   |
|                               | *****   |
|                               | Note that DIF_TS is just an alias for PQ with a dimensional constraint on the unit (PQ in the dimension of time.)               |
|                               | The XML ITS does not support promotion of a PQ into an IVL_PQ, although demotion of IVL_PQ to PQ is supported (using @V and @U) |
|                               | Literals (e.g., values of @V) follow literal form from section 7.4.3 of abstract ballot   |
|                               | ===== -->   |
| <!ENTITY % IVL_TS-cont.model  | "(NOTE?, CONFID?)">   |
| <!ENTITY % IVL_TS-attrib.list | "   |
| T                             | NMTOKEN #FIXED 'IVL_TS'   |
| NULL                          | %null.code.set; #IMPLIED  |
| V                             | CDATA #IMPLIED  |
| V-T                           | NMTOKEN #FIXED 'TS'   |
| V-HL7_NAME                    | CDATA #FIXED 'value'  |
| VT                            | CDATA #IMPLIED  |
| VT-T                          | NMTOKEN #FIXED 'IVL_TS'   |
| VT-HL7_NAME                   | CDATA #FIXED 'validTime'  |
| PROB                          | CDATA #IMPLIED  |
| PROB-T                        | NMTOKEN #FIXED 'REAL'   |
| PROB-HL7_NAME                 | CDATA #FIXED 'probability'  |
| ">                            |   |
| <!--                          | ===== Periodic Interval of Time (PIVL) =====  |
|                               | No need for a separate PIVL type, since it is never used by itself, but only to define the semantics of GTS                     |
|                               | ===== -->   |
| <!--                          | ===== Event-Related Periodic Interval of Time (EIVL) =====  |
|                               | No need for a separate EIVL type, since it is never used by itself, but only to define the semantics of GTS                     |
|                               | ===== -->   |
| <!--                          | ===== General Timing Specification (GTS) =====  |
|                               | ***** HL7 Processing Rules *****  |
|                               | The following combinations of components are valid:   |
|                               | @NULL or @V   |
|                               | @PROB >= 0 and @PROB <= 1   |
|                               | *****   |
|                               | The values of @V follow the Literal Form in section 8.3.1.3 of the abstract ballot  |
|                               | ===== -->   |
| <!ENTITY % GTS-cont.model     | '(NOTE?, CONFID?)">   |
| <!ENTITY % GTS-attrib.list    | '   |
| T                             | NMTOKEN #FIXED "GTS"  |
| NULL                          | %null.code.set; #IMPLIED  |

```

POCT1 DATA TYPES DTD

V      CDATA #IMPLIED
V-T    NMTOKEN #FIXED "GTS"
V-HL7_NAME CDATA #FIXED "value"
VT     CDATA #IMPLIED
VT-T   NMTOKEN #FIXED "IVL_TS"
VT-HL7_NAME CDATA #FIXED "validTime"
PROB   CDATA #IMPLIED
PROB-T NMTOKEN #FIXED "REAL"
PROB-HL7_NAME CDATA #FIXED "probability"
'>
<!-- ===== ANT<T> =====
No need for ANT<T> since all types defined for the XML ITS
already include an optional note property
===== -->
<!-- ===== HIST<T> =====
No need for HIST<T> since all types defined for the XML ITS
already include an optional validTime property (and hence, are HXIT<T>),
and HIST<T> is simply an optionally repeating HXIT<T>
===== -->
<!-- ===== Uncertain Value-Narrative (UVN<T>) =====
No need for UVN<T> since all types defined for the XML ITS
already include an optional confidence property
===== -->
<!-- ===== Uncertain Value-Probabilistic (UVP<T>) =====
No need for UVP<T> since all types defined for the XML ITS
already include an optional probability property
===== -->
<!-- ===== Non-Parametric Probability Distribution (NPPD<T>) =====
No need for NPPD<T> since all types defined for the XML ITS
already include an optional probability property (and hence,
are already UVP<T>) and NPPD<T> is simply an optionally
repeating UVP<T>
===== -->
<!-- ===== PPD<QTY> =====

***** HL7 Processing Rules *****

@NULL or @V
*****

The XML ITS does not support promoting a QTY to a PPD<QTY>
===== -->
<ENTITY % PPD_QTY-cont.model '(NOTE?, CONFID?)>
<ENTITY % PPD_QTY-attr.list '
T      (PPD_INT|PPD_REAL|PPD_PQ|PPD_MO|PPD_TS) "PPD_INT"
NULL   %null.code.set; #IMPLIED
V      CDATA #IMPLIED
V-T    NMTOKEN #FIXED "REAL"
V-HL7_NAME CDATA #FIXED "value"
U      CDATA #IMPLIED
U-T    NMTOKEN #FIXED "ST"
U-HL7_NAME CDATA #FIXED "unit"
SD     CDATA #IMPLIED
SD-T   NMTOKEN #FIXED "REAL"
SD-HL7_NAME CDATA #FIXED "standardDeviation"
SDU    CDATA #IMPLIED
SDU-T  NMTOKEN #FIXED "CS"
SDU-HL7_NAME CDATA #FIXED "standardDeviation unit"
TY     (U|N|LN|G|E|X2|T|F|B) #IMPLIED
TY-T   NMTOKEN #FIXED "CS"
TY-DOMAIN CDATA #FIXED "2.16.840.1.113883.5.1019"
TY-HL7_NAME CDATA #FIXED "type"
VT     CDATA #IMPLIED
VT-T   NMTOKEN #FIXED "IVL_TS"
VT-HL7_NAME CDATA #FIXED "validTime"
PROB   CDATA #IMPLIED
PROB-T NMTOKEN #FIXED "REAL"
PROB-HL7_NAME CDATA #FIXED "probability"
'>
<!-- ===== PPD<REAL> =====
    
```

```

POCT1 DATA TYPES DTD

***** HL7 Processing Rules *****

@NULL or @V
*****

The XML ITS does not support promoting a REAL to a PPD<REAL>
===== -->
<ENTITY % PPD_REAL-cont.model '(NOTE?, CONFID?)>
<ENTITY % PPD_REAL-attrib.list '
T      NMTOKEN #FIXED "PPD_REAL"
NULL   %null.code.set; #IMPLIED
V      CDATA #IMPLIED
V-T    NMTOKEN #FIXED "REAL"
V-HL7_NAME CDATA #FIXED "value"
SD     CDATA #IMPLIED
SD-T   NMTOKEN #FIXED "REAL"
SD-HL7_NAME CDATA #FIXED "standardDeviation"
TY     (U|N|LN|G|E|X2|T|F|B) #IMPLIED
TY-T   NMTOKEN #FIXED "CS"
TY-DOMAIN CDATA #FIXED "2.16.840.1.113883.5.1019"
TY-HL7_NAME CDATA #FIXED "type"
VT     CDATA #IMPLIED
VT-T   NMTOKEN #FIXED "IVL_TS"
VT-HL7_NAME CDATA #FIXED "validTime"
PROB   CDATA #IMPLIED
PROB-T NMTOKEN #FIXED "REAL"
PROB-HL7_NAME CDATA #FIXED "probability"
>
<!-- ===== PPD<QTY> =====

***** HL7 Processing Rules *****

@NULL or @V
*****

The XML ITS does not support promoting a PQ to a PPD<PQ>
===== -->
<ENTITY % PPD_PQ-cont.model '(NOTE?, CONFID?)>
<ENTITY % PPD_PQ-attrib.list '
T      NMTOKEN #FIXED "PPD_PQ"
NULL   %null.code.set; #IMPLIED
V      CDATA #IMPLIED
V-T    NMTOKEN #FIXED "REAL"
V-HL7_NAME CDATA #FIXED "value"
U      CDATA #IMPLIED
U-T    NMTOKEN #FIXED "ST"
U-HL7_NAME CDATA #FIXED "unit"
SD     CDATA #IMPLIED
SD-T   NMTOKEN #FIXED "REAL"
SD-HL7_NAME CDATA #FIXED "standardDeviation"
SDU    CDATA #IMPLIED
SDU-T  NMTOKEN #FIXED "CS"
SDU-HL7_NAME CDATA #FIXED "standardDeviation unit"
TY     (U|N|LN|G|E|X2|T|F|B) #IMPLIED
TY-T   NMTOKEN #FIXED "CS"
TY-DOMAIN CDATA #FIXED "2.16.840.1.113883.5.1019"
TY-HL7_NAME CDATA #FIXED "type"
VT     CDATA #IMPLIED
VT-T   NMTOKEN #FIXED "IVL_TS"
VT-HL7_NAME CDATA #FIXED "validTime"
PROB   CDATA #IMPLIED
PROB-T NMTOKEN #FIXED "REAL"
PROB-HL7_NAME CDATA #FIXED "probability"
>
<!-- ===== PPD<TS> =====

***** HL7 Processing Rules *****

@NULL or @V
*****
    
```

| POCT1 DATA TYPES DTD  |
|---|
| <p>The XML ITS does not support promoting a TS to a PPD&lt;TS&gt;<br/> ===== --&gt;</p> <pre> &lt;!ENTITY % PPD_TS-cont.model '(NOTE?, CONFID?)&gt; &lt;!ENTITY % PPD_TS-attrib.list '   T          NMTOKEN #FIXED "PPD_TS"   NULL      %null.code.set; #IMPLIED   V          CDATA #IMPLIED   V-T       NMTOKEN #FIXED "REAL"   V-HL7_NAME CDATA #FIXED "value"   SD        CDATA #IMPLIED   SD-T      NMTOKEN #FIXED "REAL"   SD-HL7_NAME CDATA #FIXED "standardDeviation"   SDU       CDATA #IMPLIED   SDU-T     NMTOKEN #FIXED "CS"   SDU-HL7_NAME CDATA #FIXED "standardDeviation unit"   TY        (U N LN G E X2 T F B) #IMPLIED   TY-T      NMTOKEN #FIXED "CS"   TY-DOMAIN CDATA #FIXED "2.16.840.1.113883.5.1019"   TY-HL7_NAME CDATA #FIXED "type"   VT        CDATA #IMPLIED   VT-T      NMTOKEN #FIXED "IVL_TS"   VT-HL7_NAME CDATA #FIXED "validTime"   PROB      CDATA #IMPLIED   PROB-T    NMTOKEN #FIXED "REAL"   PROB-HL7_NAME CDATA #FIXED "probability" &gt; &lt;!--   elements required for ANT&lt;T&gt; --&gt; &lt;!ELEMENT NOTE %CE-cont.model;&gt; &lt;!ATTLIST NOTE   %CE-attrib.list;   HL7_NAME CDATA #FIXED "note" &gt; &lt;!--   elements required for UVN&lt;T&gt; --&gt; &lt;!ELEMENT CONFID %CV-cont.model;&gt; &lt;!ATTLIST CONFID   %CV-attrib.list;   HL7_NAME CDATA #FIXED "confidence" &gt; &lt;!--   elements required for ED properties --&gt; &lt;!ELEMENT REF %TEL-cont.model;&gt; &lt;!ATTLIST REF   %TEL-attrib.list;   HL7_NAME CDATA #FIXED "reference" &gt; &lt;!--   Following the ITS note in the abstract ballot, any properties   of the THUMBNAIL not specified in the instance are to be "inherited"   from the enclosing ED element. --&gt; &lt;!ELEMENT THUMBNAIL %ED-cont.model;&gt; &lt;!ATTLIST THUMBNAIL   %ED-attrib.list;   HL7_NAME CDATA #FIXED "thumbnail" &gt; &lt;!--   elements required for CD properties (and related types) --&gt; &lt;!ELEMENT ORIGTXT %ED-cont.model;&gt; &lt;!ATTLIST ORIGTXT   %ED-attrib.list;   HL7_NAME CDATA #FIXED "originalText" &gt; &lt;!ELEMENT MODIFIER %CR-cont.model;&gt; </pre> |

| POCT1 DATA TYPES DTD   |
|--|
| <pre> &lt;!ATTLIST MODIFIER   %CR-attrib.list;   HL7_NAME CDATA #FIXED "modifier" &gt; &lt;!ELEMENT TRANSLTN %CD-cont.model;&gt; &lt;!ATTLIST TRANSLTN   %CD-attrib.list;   HL7_NAME CDATA #FIXED "translation" &gt; &lt;!-- elements required for CR properties --&gt; &lt;!ELEMENT NAME %CV-cont.model;&gt; &lt;!ATTLIST NAME   %CV-attrib.list;   HL7_NAME CDATA #FIXED "name" &gt; &lt;!-- elements required for II properties --&gt; &lt;!ELEMENT TYPE %CV-cont.model;&gt; &lt;!ATTLIST TYPE   %CV-attrib.list;   HL7_NAME CDATA #FIXED "type" &gt; &lt;!-- elements required for AD properties --&gt; &lt;!ELEMENT LIT %ADXP-cont.model;&gt; &lt;!ATTLIST LIT   %ADXP-attrib.list;   HL7_NAME CDATA #FIXED "literal" &gt; &lt;!ELEMENT DEL %ADXP-cont.model;&gt; &lt;!ATTLIST DEL   %ADXP-attrib.list;   HL7_NAME CDATA #FIXED "delimiter" &gt; &lt;!ELEMENT CNT %ADXP-cont.model;&gt; &lt;!ATTLIST CNT   %ADXP-attrib.list;   HL7_NAME CDATA #FIXED "country" &gt; &lt;!ELEMENT CTY %ADXP-cont.model;&gt; &lt;!ATTLIST CTY   %ADXP-attrib.list;   HL7_NAME CDATA #FIXED "city" &gt; &lt;!ELEMENT STA %ADXP-cont.model;&gt; &lt;!ATTLIST STA   %ADXP-attrib.list;   HL7_NAME CDATA #FIXED "state" &gt; &lt;!ELEMENT ZIP %ADXP-cont.model;&gt; &lt;!ATTLIST ZIP   %ADXP-attrib.list;   HL7_NAME CDATA #FIXED "postal code" &gt; &lt;!ELEMENT STR %ADXP-cont.model;&gt; &lt;!ATTLIST STR   %ADXP-attrib.list;   HL7_NAME CDATA #FIXED "street name" &gt; &lt;!ELEMENT HNR %ADXP-cont.model;&gt; &lt;!ATTLIST HNR   %ADXP-attrib.list;   HL7_NAME CDATA #FIXED "house number" &gt; &lt;!ELEMENT DIR %ADXP-cont.model;&gt; &lt;!ATTLIST DIR </pre> |

| POCT1 DATA TYPES DTD  |
|---|
| <pre> %ADXP-attrib.list; HL7_NAME CDATA #FIXED "direction" &gt; &lt;!ELEMENT ADL %ADXP-cont.model;&gt; &lt;!ATTLIST ADL   %ADXP-attrib.list;   HL7_NAME CDATA #FIXED "address locator" &gt; &lt;!ELEMENT POB %ADXP-cont.model;&gt; &lt;!ATTLIST POB   %ADXP-attrib.list;   HL7_NAME CDATA #FIXED "post office box" &gt; &lt;!-- elements required for PN properties --&gt; &lt;!ELEMENT FAM %PNXP-cont.model;&gt; &lt;!ATTLIST FAM   %PNXP-attrib.list;   HL7_NAME CDATA #FIXED "family" &gt; &lt;!ELEMENT GIV %PNXP-cont.model;&gt; &lt;!ATTLIST GIV   %PNXP-attrib.list;   HL7_NAME CDATA #FIXED "given" &gt; &lt;!ELEMENT MID %PNXP-cont.model;&gt; &lt;!ATTLIST MID   %PNXP-attrib.list;   HL7_NAME CDATA #FIXED "middle" &gt; &lt;!ELEMENT PFX %PNXP-cont.model;&gt; &lt;!ATTLIST PFX   %PNXP-attrib.list;   HL7_NAME CDATA #FIXED "prefix" &gt; &lt;!ELEMENT SFX %PNXP-cont.model;&gt; &lt;!ATTLIST SFX   %PNXP-attrib.list;   HL7_NAME CDATA #FIXED "suffix" &gt; &lt;!ELEMENT PN.DEL %PNXP-cont.model;&gt; &lt;!ATTLIST PN.DEL   %PNXP-attrib.list;   HL7_NAME CDATA #FIXED "delimiter" &gt; &lt;!-- elements required for RTO properties --&gt; &lt;!ELEMENT NUM %QTY-cont.model;&gt; &lt;!ENTITY % QTY-default.value '1'&gt; &lt;!ATTLIST NUM   %QTY-attrib.list;   HL7_NAME CDATA #FIXED "numerator" &gt; &lt;!ELEMENT DENOM %QTY-cont.model;&gt; &lt;!ATTLIST DENOM   %QTY-attrib.list;   HL7_NAME CDATA #FIXED "denominator" &gt; &lt;!ENTITY % QTY-default.value #IMPLIED'&gt; &lt;!-- </pre> |

---

 END OF THE DEVICE MESSAGING LAYER SPECIFICATION

**This page is intentionally left blank.**



## APPENDIX C. OBSERVATION REPORTING INTERFACE (ORI) SPECIFICATION

Wayne Mullins and Jeff Perry

Observation Reporting Interface Working Group

Rodney Kugizaki and Wayne Mullins, EDI Team Co-chairs, and  
Bryan Allen, Nils Graversen, Allan Soerensen, Bob Uleski

---

A standard for global application developed through the CLSI consensus process.



(Formerly NCCLS)





**Contents**

|       |   |     |
|-------|---|-----|
| 1     | Scope and Introduction .....  | 203 |
| 2     | Use Case Descriptions .....   | 203 |
| 2.1   | Use Case #1: Unordered Observation - Recipient Should Place Order .....         | 204 |
| 2.2   | Use Case #2: New Observation - Recipient Should Search for Existing Order ..... | 204 |
| 2.3   | Use Case #3: Preordered Observation With Order Information .....                | 204 |
| 2.4   | Quality Control Information .....   | 205 |
| 3     | Message Profile.....  | 205 |
| 4     | HL7 Message Definition.....   | 208 |
| 4.1   | Messages and Triggers.....  | 208 |
| 4.1.1 | ORU^R30 – Unordered Observation - Place an Order.....                           | 208 |
| 4.1.2 | ORU^R31 – New Observation – Search for an Order.....                            | 209 |
| 4.1.3 | ORU^R32 – Preordered Observation .....  | 209 |
| 4.1.4 | ACK^R33 – Acknowledgement, With Accession Number.....                           | 210 |
| 4.1.5 | Error Handling.....   | 210 |
| 4.1.6 | “Authoritative Use Statement” .....   | 211 |
| 4.2   | HL7 Abstract Message Definition .....   | 211 |
| 4.3   | Message Segments .....  | 211 |
| 4.3.1 | Notation .....  | 211 |
| 4.3.2 | MSA – General Acknowledgement Segment.....                                      | 212 |
| 4.3.3 | MSH – Message Header Segment .....  | 213 |
| 4.3.4 | NTE – Notes and Comments Segment .....  | 214 |
| 4.3.5 | OBR – Observation Request Segment.....  | 215 |
| 4.3.6 | OBX – Observation Result Segment .....  | 219 |
| 4.3.7 | ORC – Common Order Segment.....   | 220 |
| 4.3.8 | PID – Patient Identification Segment .....                                      | 222 |
| 5     | Sample Messages .....   | 223 |
| 5.1   | Sample #1: Preordered Test With Single-Valued Result.....                       | 223 |
| 5.2   | Sample #2: Unordered Single-Valued Result, Create New Order .....               | 224 |
| 5.3   | Sample #3: New Multivalued Result, Search for an Order.....                     | 225 |
| 5.4   | Sample #4: Unordered Blood Gas Result, Create New Order .....                   | 226 |
| 5.5   | General Notes .....   | 227 |
| 5.6   | Values for Sample Messages .....  | 227 |
| 5.7   | Sample Message Exchanges (ER Encoding) .....                                    | 228 |
| 5.7.1 | Sample #1, Preordered Test With Single-Valued Result.....                       | 228 |
| 5.7.2 | Sample #2, Unordered Single-Valued Result – Create New Order.....               | 229 |
| 5.7.3 | Sample #3, New Multivalued Result – Search for an Order .....                   | 230 |
| 5.7.4 | Sample #4, Unordered Blood Gas Result – Create New Order.....                   | 231 |
| 5.8   | HL7 v2.x Equivalent XML Syntax .....  | 232 |
| 5.9   | Sample Message Exchange (XML Encoding).....                                     | 232 |
| 5.9.1 | Sample #1, Preordered Test With Single-Valued Result.....                       | 232 |
| 5.9.2 | Sample #2, Unordered Test With Single-Valued Result .....                       | 236 |
| 5.9.3 | Sample #3, Unordered Test With Multivalued Result (ORU^R31) .....               | 240 |
| 5.9.4 | Sample #4, Unordered Test With Multivalued Result (ORU^R30) .....               | 242 |

**Contents (Continued)**

**Figures**

Figure 57. Scope of the Observation Reporting Interface.....203  
 Figure 58. Sample #1 Message Flow.....224  
 Figure 59. Sample #2 Message Flow.....225  
 Figure 60. Sample #3 Message Flow .....226  
 Figure 61. Sample #4 Message Flow .....227

**Tables**

Table 95. Message Profile .....205  
 Table 96. Predefined Observation Comment Values.....208  
 Table 97. Point-of-Care Observation Message Definition.....211  
 Table 98. Abstract Message Syntax.....211  
 Table 99. Sample Message Segment Definition .....211  
 Table 100. Segment Table Column Abbreviations .....212  
 Table 101. Field-level Optionality Abbreviations .....212  
 Table 102. MSA Segment.....212  
 Table 103. MSH Segment.....213  
 Table 104. Format of Header Encoding Characters String .....213  
 Table 105. NTE Segment.....214  
 Table 106. OBR Segment .....215  
 Table 107. Specimen Type Field Values .....216  
 Table 108. Specimen Source Field Values .....218  
 Table 109. Specimen Role Field Values .....218  
 Table 110. OBX Segment .....219  
 Table 111. ORC Segment .....220  
 Table 112. PID Segment .....222  
 Table 113. Sample Message Summary .....223  
 Table 114. Sample Message Participants .....227

## 1 Scope and Introduction

This document defines the POCT1 Observation Reviewer Interface. This interface handles the communication of test result and ordering information between an Observation Reviewer (e.g., point-of-care Data Manager) and an Observation Recipient (e.g., LIS or HIS).

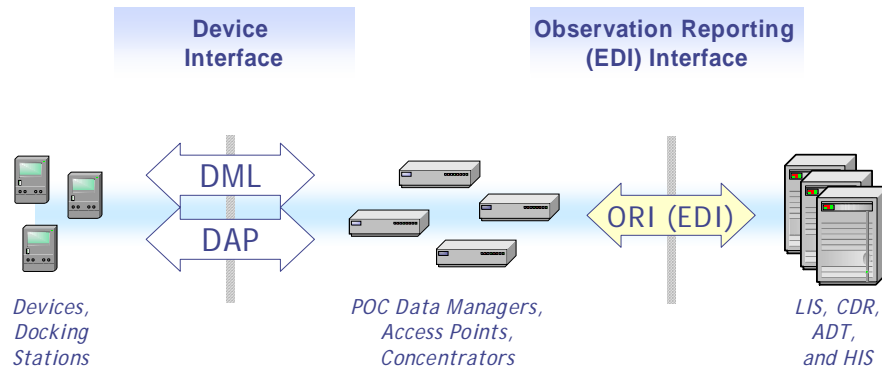

**Figure 57. Scope of the Observation Reporting Interface**

This specification is an implementation guide for using Health Level 7 (HL7) version 2.4 messaging to support this communication. The message flows and content specified in this document support basic reporting of point-of-care results and orders.

This specification does not define new segments or fields – it simply prescribes how the existing HL7 messages, segments, and fields should be used to communicate test result and ordering information. Four new triggers defined for the HL7 **ORU** message are not found in the HL7 v2.5 specification. The HL7 Architecture Review Board has issued an “authoritative use statement” specifying the use of these four triggers in v2.4.x messaging. Please refer to Section 4.1 - Messages and Triggers for more information about these new triggers.

Individual institutions or deployments may have additional requirements beyond those addressed by this specification. Message fields not defined for use by this specification may be used to support these site-specific requirements. As long as the final implementation uses the messages and fields defined in this document, the resulting interface is compliant with the POCT1 Observation Reporting Interface specification.

## 2 Use Case Descriptions

The messages defined in this document are designed to handle three use cases for Observation Reviewers transmitting observations to Observation Recipients:

1. test results for which Observation Recipient should place an order;
2. test results for which the Observation Recipient should search for an existing order; and
3. test results with information about a previously placed order.

Note that in Use Case #1 and Use Case #2, the Observation Reviewer is not expected to *specifically* know whether an order exists for the associated result set. Rather, the Observation Reviewer may employ an institutionally defined algorithm to determine whether to instruct the Observation Recipient to search for an existing associated order or to place a new order. For example, possible heuristics the Observation Reviewer might employ include:

- All results without orders are reported using only one of the use cases (i.e., all are Use Case #1 or all are Use Case #2)
- The Use Case is determined by a test parameter

For example, Device ID – orders have been created for all tests performed by the coagulation unit with ID 0x99553300 (Use Case #2)

- The Use Case is determined by a combination of test parameters

For example, Device location and test type – all glucose results from 'ICU-4' require that a new order be created (Use Case #1).

## 2.1 Use Case #1: Unordered Observation — Recipient Should Place Order

In this use case, a test is performed under implicit ordering conditions. Upon receipt of the observation, the Observation Recipient should place an order for the associated results.

Common examples of this use case include testing performed:

- Under “standing orders” for the Patient, or
- Under “as needed orders” for the Patient, or
- As a result of a request from a physician or notification by another means (e.g., message from the HIS) that the test is to be performed at a specified time.

To allow the Observation Reviewer to correlate every result with its associated order, the Observation Recipient will return the newly created Order ID to the Observation Reviewer.

## 2.2 Use Case #2: New Observation — Recipient Should Search for Existing Order

In this use case, the Observation Reviewer does not have order information to communicate with an observation and does not know whether an order has been previously placed. In this case, the Observation Reviewer asks the Observation Recipient to search for an existing order that matches the supplied observation. If the Observation Recipient finds a matching order, the observation should be resultted against that order. If no matching order is found, the Observation Recipients' behavior should be guided by the business rules of the institution. Possible outcomes in this situation would be for the Observation Recipient (a) to place a new order to result the observation against (as in Use Case #1), (b) to not report the result at all and instead report an exception.

If the Observation Recipient either finds a matching order or creates a new order, it should return the newly created Order ID to the Observation Reviewer. This information allows the Observation Reviewer to correlate every result with its associated order.

## 2.3 Use Case #3: Preordered Observation With Order Information

This use case parallels the most common situation found in laboratory-based testing. In this case, an order is placed prior to the test being performed. The Observation Reviewer is aware of this order, and it reports both the observation results and the order ID to the Observation Recipient. The order information may be reported either as an order ID or as an accession number.

## 2.4 Quality Control Information

The messages described in this implementation guide do not include Quality Control (QC) information. At the time this specification was developed, the CIC was unable to find and develop use cases that included communication of QC information to the Observation Recipient (LIS or HIS system). So, instead, the CIC focused on defining QC messages between the Device and the Observation Reviewer. If, over time, the LIS and HIS systems also assume responsibility for the Observation Reviewer role, the QC messages defined by the Device Interface Upper-Layer specification should be used.

## 3 Message Profile

Table 95 presents a profile of the essential elements of the Observation Report message. This profile describes the objects and attributes that comprise an Observation Report message as well as summary information about how these fields are to be encoded in HL7 v2.5 messages.

**Table 95. Message Profile**

| CLASS    | ATTRIBUTE                              | MIN. CARD | MAX. CARD | CODING STAND.                 | COMMENTS   | SEGMENT                                |
|----------|--|-----------|-----------|-------------------------------|--|--|
| Device   |  | 1         | 1         |                               |  |  |
|          | Identifier<br>(see note (1))           | 1         | 1         | IEEE<br>EUI-64<br>(Preferred) | EUI-64 Device ID or Device Type / Serial number / GUID - could also be the name of a manual test.  | OBX-18                                 |
| Operator |  | 1         | 1         |                               |  |  |
|          | Identifier                             | 1         | 1         |                               | Could be empty. Though desired in the US, it is not in other countries (see note (2)).   | OBX-16                                 |
| Patient  |  | 1         | 1         |                               |  |  |
|          | Identifier<br>(see note (3))           | 1         | 1         |                               | Use Case #1, #2: Patient ID.<br>Use Case #3: Patient ID, if available. Order ID if no Patient ID available.  | PID-3                                  |
|          | Account Number<br>(see note (4))       | 1         | 1         |                               | Primarily intended for Use Case #1, #2. May be required at some sites to uniquely identify visit along with Patient ID.  | PID-18                                 |
| Specimen |  | 1         | 1         |                               |  |  |
|          | Identifier                             | 1         | 1         |                               | Use Case #1, #2: Not available.<br>Use Case #3: Order identifier or similar (see note (5)).  | ORC-2                                  |
|          | Role                                   | 1         | 1         | HL7                           | Identifies observation as a patient test result.   | OBR-15                                 |
|          | Type                                   | 1         | 1         | HL7                           | Identifies sample – venous, capillary, etc.  | OBR-15                                 |
| Service  |  | 1         | 1         |                               |  |  |
|          | Identifier                             | 1         | 1         |                               | An external key to this service record in the Observation Reviewer.  | ORC-3                                  |
|          | Analysis Date & Time<br>(see note (6)) | 1         | 1         | HL7                           | CCYYMMDDHHMMSS plus optional time zone information (see note (7)).   | OBX-19                                 |
|          | Comments<br>(see note (8))             | 1         | 1         |                               | Describes conditions, events or circumstances that may need to be considered when using the observation.<br>Up to 3 comments may be associated with a single NTE segment by using the " repeat separator in NTE-3 field. | NTE-3<br>- Follows related OBR segment |

Table 95. (Continued)

| CLASS       | ATTRIBUTE                         | MIN. CARD | MAX. CARD | CODING STAND.   | COMMENTS   | SEGMENT                                |
|-------------|-----------------------------------|-----------|-----------|-----------------|--|--|
| Order       |                                   | 1         | 1         |                 |  |  |
|             | Service Identifier                | 1         | 1         | LOINC or custom | Identifies the type of service performed. The preferred format is a LOINC value, however, other coding systems or local names may be used.<br><br>If this message contains multiple parameters or sample values, this field's value may refer to a package or profile identifier.              | OBR-4                                  |
| Order       | Ordering Physician (see note (4)) | 1         | 1         |                 | Primarily intended for Use Case #1 and #2. May be required at some sites to Order test: e.g., 12345^Smith^John^J^Dr.   | OBR-16                                 |
| Observation |                                   | 1         | *         |                 |  |  |
|             | Service Identifier                | 1         | 1         | LOINC or custom | Identifies the type of service performed. The preferred format is a LOINC value; however, other coding systems or local names may be used. For observations that cannot be identified by a LOINC code the alternate coding system components of OBX-3 can be used to identify the observation. | OBX-3                                  |
|             | Value                             | 0         | 1         |                 | Examples: "150," "<50," ">550" If not provided, the Nonspecific value (OBX-8) is used to specify the observation value.  | OBX-5                                  |
|             | Nonspecific value                 | 0         | 1         |                 | May be used in lieu of Value.<br>Example: "N" for Normal.<br><br>For results where a numeric value is provided in OBX-5, this field may be used to provide interpretation information regarding the numeric value, <i>HL7 Section 7.3.2.8.</i>   | OBX-8                                  |
|             | Units                             | 1         | 1         |                 | Units of measurement, <i>HL7 Section 7.3.2.6, Table 7.18.4.</i>  | OBX-6                                  |
|             | Value Flag                        | 0         | 1         |                 | Any flags or alarms associated with result. Temp error, expired strip, etc.  | NTE-3<br>- Follows related OBX segment |

- (1) The Device Identifier should be globally unique. The Device Interface specifies that the IEEE EUI-64 identifier scheme be used for future Devices (e.g., "12-34-56-78-90-AB-CD-EF"). To accommodate legacy systems, this field may contain one of the following three formats: 1) EUI-64 (preferred); 2) concatenation of vendor\_id, model\_id, and serial\_id fields from the device object of the DML using the ^ as a delimiter; or 3) a legacy identifier string. Any vendor-specified format shall be distinguishable from EUI-64 format and should be distinguishable from the format of the vendor\_id. Refer to the *POCT1 Device Messaging Layer* specification for more information about the expected format of this field.
- (2) The identifier values for the Operator ID field may be left blank, if unknown or unspecified.
- (3) Several issues are important to note regarding the use of the Patient Identifier field:
  - This field must contain an identifier that the Observation Recipient can use to identify the patient. Examples of such identifiers include medical record numbers and order identifiers (e.g., order IDs or accession numbers, as they uniquely relate to a patient).



- Typically, POC Devices can record, at most, one identifier. When patient identification is not available from the Device due to such restricted input, the Observation Reviewer may deduce and provide an appropriate identifier on the Device's behalf.
  - If no Patient ID is available, the Observation Reviewer should duplicate the value in the Specimen Identifier field. This allows the Observation Recipient to reference one field to identify the patient, regardless of whether the value is a patient identifier or an order identifier.
  - The issue of which type of identifier is acceptable under what circumstances involves vendor implementation matters and customer business rules. For example, if in a given institution no heuristic exists that can reliably map an accession number to a patient identifier, an Observation Recipient will not be able to accept an Order ID as patient identification. In such a case, the institution might require that a medical record number be provided as the Patient Identifier in all point-of-care use cases.
- (4) Field is optional. May be required at some sites.
  - (5) The Specimen Identifier field contains a value that represents an external key for referencing order information stored by the Observation Recipient. This key may take several different forms, such as an order identifier, an accession number, or other such external database key. Throughout this document, the term Order ID is defined to refer to such an external key.
  - (6) Time zone qualification of the date/time is optional. If the time zone is omitted from the message, 'local time' (time zone where the Device is located) is assumed.
  - (7) One-second resolution is felt to be adequate for POCT result reports.
  - (8) Table 96 predefines several standard comment strings and their associated use cases. Where appropriate, these standard comment values should be used to qualify Observations in this NTE segment. Vendors are allowed to extend this table to accommodate use cases beyond the scope of those currently described.

**Table 96. Predefined Observation Comment Values**

| VALUE                 | USE CASES  | FUNCTION   |
|-----------------------|--|--|
| "Procedural Error"    | Used whenever the testing personnel feel the result should not be posted against the patient's record.                             | Stops the processing of the sample, interrupts autoverification without discarding the record.                           |
| "Correlation Samples" | Used when a test is performed to validate the meter readings against the central lab testing.                                      | Used primarily to remove charges from correlation testing. Useful in States with frequent correlation requirements (NJ). |
| "Postexercise"        | Added when activity level prior to testing may have influenced result.   | Amends the result to assist in subsequent interpretation.  |
| "Premeal"             | Used when dietary status may have influenced result.   | Amends the result to assist in subsequent interpretation.  |
| "Postmeal"            | Used when dietary status may have influenced result.   | Amends the result to assist in subsequent interpretation.  |
| "Results Rechecked"   | Used whenever protocol calls for a result to be repeated for verification.   | Identifies duplicate testing to eliminate duplicate charges.   |
| "Premeds"             | Used when the results precede a medication dose that may affect subsequent measurements.   | Amends the result to assist in subsequent interpretation.  |
| "Postmeds"            | Used when the results follow a medication dose that may have affected the measurement.   | Amends the result to assist in subsequent interpretation.  |
| "Confirm to Lab"      | Used to indicate a sample has been sent to the central lab to confirm result (usually when result exceeds meter technical limits). | Identifies a duplicate confirmation test to eliminate duplicate charges without eliminating test record.                 |
| "Called to Provider"  | Used to document the notification of the result to the responsible provider.   | Amends result to document notification.  |

## 4 HL7 Message Definition

The following sections describe how to implement the Message Profile described above, using either the HL7v2.x ER syntax or the XML encoding. The XML encoding described herein uses the rules defined in the informative document, *HL7 Recommendation: Using XML as a Supplementary Messaging Syntax for HL7 Version 2.3.1*.

### 4.1 Messages and Triggers

Point-of-care workflow for measurement and ordering is quite complex, dynamic, and flexible. However, most scenarios may be reduced to three use cases (described also in Section 2):

1. a test is performed without an order and the Observation Recipient should place an order;
2. a test is performed which may or may not have an order previously placed; and
3. a test is performed that was previously ordered.

These three use cases all rely on the **ORU** message to communicate the appropriate mix of result and order information. Currently, the **ORU** message has no trigger event appropriate for the common POC Use Cases. Four new trigger events are required to distinguish between the **ORU** messages that support these three use cases. The HL7 organization has issued an Authoritative Use Statement (Section 4.1.6) permitting the use of the new triggers: **R30**, **R31** and **R32**, in advance of being balloted by HL7 for a future version of the standard. The following sections describe these triggers and their use in more detail.

#### 4.1.1 ORU^R30 – Unordered Observation—Place an Order

This use case employs the **ORU** message with the **R30** trigger. One example of this use case occurs when a Doctor verbally instructs a nurse to perform a test. Looking at this use case from an information

management perspective, one might expect that, the nurse would enter an order into the LIS/ORD system before performing the test. However, there usually isn't time for order entry in these use cases. In fact, it is highly desirable for the POC measurement process to become automated so that the only action a user needs to take is to make a measurement on the POC Device, with all other processes for generating an order and tying it in to the observation handled by the “machines.”

The main motivation for the **R30** trigger is to instruct the Observation Recipient to create a new order for the observation(s) contained in the **ORU** message.

To allow the Observation Reviewer to correlate every result with its associated order, the Observation Recipient will return the newly created Order ID in the application-level acknowledgement to this **ORU^R30** message. If desired, this acknowledgement message may also contain information returned from the Observation Recipient, such as the name of the patient corresponding to the order and result placed.

#### 4.1.2 **ORU^R31 – New Observation—Search for an Order**

This use case employs the **ORU** message with the **R31** trigger. In this case, the Observation Reviewer does not know if an order has been placed. This message and trigger instruct the Observation Recipient to search for an existing order for the associated results. If the Observation Recipient finds an existing order, it should return the Order ID to the Observation Reviewer in the Acknowledgement message.

The institution's business rules will determine what the Observation Recipient does if it can't find a matching order. Possibilities include automatically placing an order (as in use case 1), or logging an exception rather than recording the result.

The main motivation for the **R31** trigger is to inform the Observation Recipient to search for an existing order for the results supplied in the **ORU** message.

If the Observation Recipient either finds a matching order or creates a new order, it should return the newly created Order ID to the Observation Reviewer in the application-level acknowledgement to this **ORU^R31** message. This information allows the Observation Reviewer to correlate every result with its associated order. If desired, this acknowledgement message may also contain information returned from the Observation Recipient, such as the name of the patient corresponding to the order and result placed.

#### 4.1.3 **ORU^R32—Preordered Observation**

This use case employs the **ORU** message with the **R32** trigger. From a traditional central laboratory perspective, this use case is probably the predominant (if not exclusive) one. However, in the POC environment, it is actually uncommon to have an order already generated when a test is done. It does happen sometimes, though. In these cases order information is provided by either of the following schemes:

- The user enters an accession number (to identify the order) at the POC Device when performing the test.
- If the Device doesn't support that input capability or the accession number isn't known at the point-of-care, the Observation Reviewer (e.g., POC Data Manager) retrospectively determines the appropriate order to match to the test result.<sup>††</sup>

<sup>††</sup> How exactly the Observation Reviewer determines this information is outside the scope of this specification. The task may involve a separate query interface to an ordering system.

In either case, the Observation Recipient receives a message containing both the result and the associated order information.

The main motivation for the **R32** trigger is to instruct the Observation Recipient to place the result with the order information included in the **ORU** message.

#### 4.1.4 ACK^R33 – Acknowledgement, With Accession Number

This trigger event supports the use case of a response to any of the three **ORU** trigger events, communicating an accession number if appropriate. This current implementation guide relies on returning an accession number in the first field of the **ACK^R01** message's NTE segment. Because HL7 does not in general support communicating structured information in NTE segments, the **ACK^R33** message trigger has been reserved to accommodate this use case in future versions of the HL7 specification.

#### 4.1.5 Error Handling

Proper usage of the **R30** and **R31** triggers requires the Observation Reviewer to know something about the state of the Observation Recipient (i.e., whether or not an order has been placed). Such a situation violates general principles for robust messaging system design. However, it is required to support the nonregimented workflow that describes the clinical use model for most point-of-care Devices.

Strictly speaking, the Observation Reviewer does not really 'know' whether an order has been previously submitted to the Observation Recipient. Rather, the Observation Reviewer may employ various heuristics to 'guess' whether an order exists. Examples of possible heuristics are described in some detail in Section 2. Briefly, they include:

- Simple rules: All tests reported as Use Case #1 or all reported as Use Case #2.
- The Use Case is determined by a test parameter (e.g., Device ID).
- The Use Case is determined by a combination of test parameters (e.g., Device location and test type).

Consequently, it is possible for the Observation Reviewer to transmit erroneous information. The following sections discuss the most common possible sources for these errors and suggest system behavior to deal with these errors. These examples are provided for informative purposes and are not normative.

- *A Result plus Order is submitted with incorrect order information*—In this case, the Observation Recipient should generate an exception, returned in the **ACK** message. The Observation Reviewer is responsible for displaying these exceptions. In a typical hospital POC environment, one of the responsibilities of the Point-of-Care Coordinator (POCC) is to review these exception lists and try to resolve the problem and resubmit the Result and Order.
- *An ordered test is submitted as a Result without order*—This case represents a failure of the Order-Result matching heuristics. To identify these cases, an Observation Reviewer could log all results that were placed without order information. The POC Coordinator could review this log to determine if any of these results actually had an associated order. Once identified, the cause of the Order-Result matching algorithm's failure can be identified and fixed.

### 4.1.6 “Authoritative Use Statement”

**NOTE:** The final version of this proposal will include the formal wording of the HL7 “Authoritative Use Statement” here. This statement describes the use of the three new **ORU** triggers (herein referred to as **R30**, **R31** and **R32**) to accommodate use cases 1, 2, and 3.

## 4.2 HL7 Abstract Message Definition

The Abstract Message Syntax in HL7 can be used to specify the arrangement of segments within a message.

Table 97 describes the Observation message using this abstract message syntax.

**Table 97. Point-of-Care Observation Message Definition**

| POINT-OF-CARE OBSERVATION |   |
|---------------------------|---|
| MSH                       | Message Header  |
| PID                       | Patient Identification  |
| ORC                       | Common Order information  |
| OBR                       | Observation Request   |
| [NTE]                     | Notes or Comments for order/result, zero or one per message             |
| {                         |   |
| OBX                       | Observation Results, one per reported value                             |
| [NTE]                     | Notes or Comments for individual result, zero or one per reported value |
| }                         |   |

The brackets and braces have the following meaning:

**Table 98. Abstract Message Syntax**

| HL7 ABSTRACT MESSAGE SYNTAX | OCCURRENCE   |
|-----------------------------|--------------|
| []                          | Zero or one  |
| {}                          | One or more  |
| HL7 ABSTRACT MESSAGE SYNTAX | OCCURRENCE   |
| {[]} = [{}]                 | Zero or more |
| - no bracket or brace -     | One exactly  |

## 4.3 Message Segments

The following subsections define the segments and fields that comprise the Point-of-Care Observation Message.

### 4.3.1 Notation

The following subsections use tables to define message segments and their fields. These tables are of the general form shown below.

**Table 99. Sample Message Segment Definition**

| SEQ | LEN | DT | OPT | HL7 SEGMENT FIELD NAME | NOTES ON POCT1 USE             |
|-----|-----|----|-----|------------------------|--------------------------------|
| 1   | 1   | ST | R   | Field Separator        | “ ” unless otherwise specified |

The abbreviations used in the table columns are defined as follows:

**Table 100. Segment Table Column Abbreviations**

| COLUMN | DESCRIPTION   |
|--------|---|
| SEQ    | The given field's sequence number within the segment. This number should monotonically increase across the segment. |
| LEN    | The maximum character length for values in a given field.   |
| DT     | The data type of the field. Refer to Chapter 2 of the HL7 v2.x specification for detailed data type definitions.    |
| OPT    | The 'optionality' of this field. Refer to the table below for definitions of the values used in this column.        |

**Table 101. Field-level Optionality Abbreviations**

| CODE | MEANING   |
|------|---|
| R    | Required.   |
| RE   | Required, but may be empty.   |
| O    | Optional.   |
| C    | Conditional on the trigger event or on some other field(s). The descriptive text following the segment definition table should specify the algorithm that defines the conditionality for this field.    |
| CE   | Conditional on some other field. This field may also be empty. The descriptive text following the segment definition table should specify the algorithm that defines the conditionality for this field. |
| X    | Not used.   |

**4.3.2 MSA – General Acknowledgement Segment**

**Table 102. MSA Segment**

| SEQ | LEN | DT | OPT | HL7 SEGMENT FIELD NAME       | DESCRIPTION AND POCT1 USE                      |
|-----|-----|----|-----|------------------------------|--|
| 1   | 2   | ID | R   | Acknowledgement Code         | "CA," "CE," "CR," "AA," "AE," "AR"<br>Note (1) |
| 2   | 20  | ST | R   | Message Control ID           | From MSH-10 of associated message              |
| 3   | 80  | ST | O   | Text Message                 | Note (2)                                       |
| 4   | 15  | NM | X   | Expected Sequence Number     |  |
| 5   | 1   | ID | X   | Delayed Acknowledgement Type |  |
| 6   | 100 | CE | O   | Error Condition              | Coded Error, Note (3)                          |

Any fields defined beyond Sequence 6 are ignored by this specification.

(1) Values defined in HL7 *Table 0008 – Acknowledgement code*:

“CA,” “CE,” “CR”: Accept/Commit Level Acknowledge, Error, or Rejected.

- “AA,” “AE,” “AR”: Application Level Acknowledge, Error, or Rejected.

Use of CE vs. CR and AE vs. AR is vendor/site specific.

(2) – “CA”: Should be empty

“AA”: The ACK^R33 acknowledgements of ORU^R30 and ORU^R31 messages must return an Order ID<sup>ss</sup> as the first component of this field. The Observation Recipient may return comments (e.g., Patient name or demographics) by appending them after the Order ID component, using the appropriate separator character between each component. The formal format of this field is as follows:

<Order ID>^<comment text>~<comment text>~...

See Section 5.7.2 for an example of comment text returned with an Order ID in an ACK^R33 message.

<sup>ss</sup> Refer to the note referenced by the Specimen Identifier property in Table 95, Message Profile, for detailed information about types of order identifier values that can be expected.

“CE,” “CR,” “AE,” “AR”: Must specify detailed error message

(3) Coded error condition corresponding to MSA-3, if any.

### 4.3.3 MSH – Message Header Segment

**Table 103. MSH Segment**

| SEQ | LEN | DT | OPT | HL7 SEGMENT FIELD NAME           | NOTES ON POCT1 USE  |
|-----|-----|----|-----|----------------------------------|---|
| 1   | 1   | ST | R   | Field Separator                  | “ ” unless otherwise specified                            |
| 2   | 4   | ST | R   | Encoding Characters              | Note (1)  |
| 3   | 180 | HD | RE  | Sending Application              | Vendor/Site Specific                                      |
| 4   | 180 | HD | RE  | Sending Facility                 | Vendor/Site Specific                                      |
| 5   | 180 | HD | RE  | Receiving Application            | Vendor/Site/ Specific                                     |
| 6   | 180 | HD | RE  | Receiving Facility               | Vendor/Site Specific                                      |
| 7   | 26  | TS | R   | Date/Time Of Message             | CCYYMMDDHHMMSS  |
| 8   | 40  | ST | X   | Security                         |   |
| 9   | 7   | CM | R   | Message Type                     | i.e., ORU^R30, ORU^R31, ORU^R32, ACK^R33, ACK<br>Note (2) |
| 10  | 20  | ST | R   | Message Control ID               | Vendor Specific, Note (3)                                 |
| 11  | 3   | PT | R   | Processing ID                    | “T”/“D”/“P” (Training, Debug, Production)                 |
| 12  | 8   | ID | R   | Version ID                       | 2.4   |
| 13  | 15  | NM | X   | Sequence Number                  |   |
| 14  | 180 | ST | X   | Continuation Pointer             |   |
| 15  | 2   | ID | R   | Accept Acknowledgement Type      | “AL,” “NE” Note (4)                                       |
| 16  | 2   | ID | R   | Application Acknowledgement Type | “AL,” “NE” Note (5)                                       |
| 17  | 2   | ID | RE  | Country Code                     | Empty for USA   |

Any fields defined beyond Sequence 17 are ignored by this specification.

(1) This field takes the form of a four-character string. The default value for the string is “^~\&.” The format and meaning of this string is borrowed from *HL7 v2.4 Section 2.8 – Message Delimiters* and shown in following table.

**Table 104. Format of Header Encoding Characters String**

| POSITION | DEFAULT | USAGE  |
|----------|---------|--|
| 1        | ^       | Separates adjacent components of data fields.    |
| 2        | ~       | Separates multiple occurrences of a field.       |
| 3        | \       | Escape character.                                |
| 4        | &       | Separates adjacent subcomponents of data fields. |

(2) - **ORU^R30** for Observation without an order where the recipient should place the order,  
 - **ORU^R31** for where an order may or may not have been placed and the Observation Recipient should search for an order,  
 - **ORU^R32** for Observations with order information,  
 - **ACK^R33** for Application acknowledgement to **ORU** messages,  
 - **ACK** for all Accept/Commit Level acknowledgements.

(3) Message Control ID format is vendor specific. Receiver must be prepared to accept at least 32 characters and must return the identical Message Control ID in MSA-2 for both Accept/Commit Level and Application Level acknowledgements.

(4) All source messages (**ORU**, **ACK^R33**) should specify “AL” - Always Accept/Commit Acknowledge. Accept/Commit Acknowledgements (**ACK**) should specify “NE.”

(5) - For Enhanced Acknowledge Mode: all Order/Result messages (**ORU**) will specify “AL” – Always Application Acknowledge.

-All Acknowledgement Messages (**ACK^R33**, **ACK**) must specify “NE” – Never Application Acknowledge.

**4.3.4 NTE – Notes and Comments Segment**

**Table 105. NTE Segment**

| SEQ | LEN | DT | OPT | ELEMENT NAME      |                               |
|-----|-----|----|-----|-------------------|-------------------------------|
| 1   | 4   | SI | X   | Set ID – NTE      |                               |
| 2   | 8   | ID | X   | Source of Comment | Application specific          |
| 3   | 64k | FT | RE  | Comment           | Comment 1-Comment 2-Comment 3 |

Any fields defined beyond Sequence 3 are ignored by this specification.



## 4.3.5 OBR – Observation Request Segment

Table 106. OBR Segment

| SEQ | LEN | DT  | OPT | HL7 SEGMENT FIELD NAME              | NOTES ON POCT1 USE   |
|-----|-----|-----|-----|-------------------------------------|--|
| 1   | 4   | SI  | O   | Set ID – OBR                        | Optional. Set ID Sequence Number   |
| 2   | 75  | EI  | X   | Placer Order Number                 | See ORC-2  |
| 3   | 75  | EI  | X   | Filler Order Number                 | See ORC-3  |
| 4   | 200 | CE  | R   | Universal Service ID                | e.g., 1-2345^GLU^LN for single valued result. Note (1)   |
| 5   | 2   | ID  | X   | Priority                            |  |
| 6   | 26  | TS  | X   | Requested Date/Time                 |  |
| 7   | 26  | TS  | X   | Observation Date/Time               |  |
| 8   | 26  | TS  | X   | Observation End Date/Time           |  |
| 9   | 20  | CQ  | X   | Collection Volume                   |  |
| 10  | 60  | XCN | X   | Collector Identifier                |  |
| 11  | 1   | ID  | R   | Specimen Action Code                | “O” (Specimen obtained by service other than Lab)  |
| 12  | 60  | CE  | X   | Danger Code                         |  |
| 13  | 300 | ST  | X   | Relevant Clinical Info.             |  |
| 14  | 26  | TS  | X   | Specimen Received Date/Time         |  |
| 15  | 300 |     | O   | Specimen Source                     | e.g., BLDA^^LLFA^^P (Patient test from arterial blood taken from left lower forearm). Note (3) |
|     |     | SPS |     |                                     |  |
| 16  | 80  | XCN | O   | Ordering Provider                   | e.g., Smith^John^J^Dr - Note (4)   |
| 17  | 40  | XTN | X   | Order Callback Phone Number         |  |
| 18  | 60  | ST  | X   | Placer Field 1                      |  |
| 19  | 60  | ST  | X   | Placer Field 2                      |  |
| 20  | 60  | ST  | X   | Filler Field 1                      |  |
| 21  | 60  | ST  | X   | Filler Field 2                      |  |
| 22  | 26  | TS  | X   | Results Rpt/Status Chng – Date/Time |  |
| 23  | 40  | CM  | X   | Charge to Practice                  |  |
| 24  | 10  | ID  | X   | Diagnostic Serv Sect ID             |  |
| 25  | 1   | ID  | X   | Result Status                       |  |
| 26  | 400 | CM  | X   | Parent Result                       |  |
| 27  | 200 | TQ  | X   | Quantity/Timing                     |  |
| 28  | 150 | XCN | X   | Result Copies To                    |  |
| 29  | 150 | CM  | X   | Parent                              |  |
| 30  | 20  | ID  | X   | Transportation Mode                 |  |
| 31  | 300 | CE  | X   | Reason for Study                    |  |
| 32  | 200 | CM  | X   | Principal Result Interpreter        |  |
| 33  | 200 | CM  | X   | Assistant Result Interpreter        |  |
| 34  | 200 | CM  | X   | Technician                          |  |
| 35  | 200 | CM  | X   | Transcriptionist                    |  |
| 36  | 26  | TS  | X   | Scheduled Date/Time                 |  |

Any fields defined beyond Sequence 16 are ignored by this specification.

- (1) The Universal Service ID is identical to the Service ID in the OBX segment for a single-valued result. For multivalued results, this field will identify a Package/Profile/Panel name that is vendor/site specific (e.g., BG-OXI-ELECT for a panel that is to include Blood-Gas, Oximetry (Hemoglobin and derivatives) and electrolytes).
- (2) Specimen source is a seven-component field. For the POCT1 protocol, only the following components are required:

- The 1<sup>st</sup> – specimen type, from Table 107
- The 4<sup>th</sup> – location, from Table 108
- The 7<sup>th</sup> – sample role, Table 109

Use of the other fields is vendor/site specific.

- (3) Ordering Provider or Responsible Physician may be required at some sites to place an Order. Optional elsewhere.
- (4) Table 107 and Table 108 reference tables defined in the HL7 v2.5 specification. These tables will be updated in future versions of this specification to track additions and changes to the original source HL7 tables.

**Table 107. Specimen Type Field Values<sup>tt</sup>**

| CODE  | DESCRIPTION           |
|-------|-----------------------|
| BS    | Abscess               |
| AMN   | Amniotic fluid        |
| ASP   | Aspirate              |
| BPH   | Basophils             |
| BIFL  | Bile fluid            |
| BLDA  | Blood arterial        |
| BBL   | Blood bag             |
| BLDC  | Blood capillary       |
| BLMV  | Blood mixed venous    |
| BPU   | Blood product unit    |
| BLDV  | Blood venous          |
| BON   | Bone                  |
| BRTH  | Breath (use EXHLD)    |
| BRO   | Bronchial             |
| BRN   | Burn                  |
| CALC  | Calculus (=Stone)     |
| CDM   | Cardiac muscle        |
| CNL   | Cannula               |
| CTP   | Catheter tip          |
| CSF   | Cerebral spinal fluid |
| CVM   | Cervical mucus        |
| CVX   | Cervix                |
| COL   | Colostrum             |
| BLDCO | Cord blood            |
| CNJT  | Conjunctiva           |
| CUR   | Curettage             |
| CYST  | Cyst                  |
| DIAF  | Dialysis fluid        |

| CODE | DESCRIPTION                       |
|------|-----------------------------------|
| MAR  | Marrow                            |
| MEC  | Meconium                          |
| MBLD | Menstrual blood                   |
| MLK  | Milk                              |
| MILK | Breast milk                       |
| NAIL | Nail                              |
| NOS  | Nose (nasal passage)              |
| ORH  | Other                             |
| PAFL | Pancreatic fluid                  |
| PAT  | Patient                           |
| PRT  | Peritoneal fluid/ascites          |
| PLC  | Placenta                          |
| PLAS | Plasma                            |
| PLB  | Plasma bag                        |
| PLR  | Pleural fluid (thoracentesis fld) |
| PMN  | Polymorphonuclear neutrophils     |
| PPP  | Platelet poor plasma              |
| PRP  | Platelet rich plasma              |
| PUS  | Pus                               |
| RT   | Route of medicine                 |
| SAL  | Saliva                            |
| SMN  | Seminal fluid                     |
| SER  | Serum                             |
| SKN  | Skin                              |
| SKM  | Skeletal muscle                   |
| SPRM | Spermatozoa                       |
| SPT  | Sputum                            |
| SPTC | Sputum - coughed                  |

<sup>tt</sup> Referenced from HL7 v2.4, Chapter 7 - HL7 Table 0070 - Specimen source codes, with the addition of BLMV – Blood mixed venous.

Table 107. (Continued)

|                                   |                        |
|-----------------------------------|------------------------|
| DOSE                              | Dose med or substance  |
| DRN                               | Drain                  |
| DUFL                              | Duodenal fluid         |
| EAR                               | Ear                    |
| EARW                              | Ear wax (cerumen)      |
| ELT                               | Electrode              |
| ENDC                              | Endocardium            |
| ENDM                              | Endometrium            |
| EOS                               | Eosinophils            |
| RBC                               | Erythrocytes           |
| EYE                               | Eye                    |
| EXG                               | Exhaled gas (=breath)  |
| FIB                               | Fibroblasts            |
| FLT                               | Filter                 |
| FIST                              | Fistula                |
| FLU                               | Body fluid, unsp       |
| GAS                               | Gas                    |
| GAST                              | Gastric fluid/contents |
| GEN                               | Genital                |
| GENC                              | Genital cervix         |
| GENL                              | Genital lochia         |
| GENV                              | Genital vaginal        |
| HAR                               | Hair                   |
| IHG                               | Inhaled Gas            |
| IT                                | Intubation tube        |
| ISLT                              | Isolate                |
| LAM                               | Lamella                |
| WBC                               | Leukocytes             |
| LN                                | Line                   |
| LNA                               | Line arterial          |
| LNV                               | Line venous            |
| LIQ                               | Liquid NOS             |
| LYM                               | Lymphocytes            |
| MAC                               | Macrophages            |
| Continued in right-hand column... |                        |

|       |                              |
|-------|------------------------------|
| SPTT  | Sputum - tracheal aspirate   |
| STON  | Stone (use CALC)             |
| STL   | Stool = Fecal                |
| SWT   | Sweat                        |
| SNV   | Synovial fluid (Joint fluid) |
| TEAR  | Tears                        |
| THRT  | Throat                       |
| THRB  | Thrombocyte (platelet)       |
| TISS  | Tissue                       |
| TISG  | Tissue gall bladder          |
| TLGI  | Tissue large intestine       |
| TLNG  | Tissue lung                  |
| TISPL | Tissue placenta              |
| TSMI  | Tissue small intestine       |
| TISU  | Tissue ulcer                 |
| TUB   | Tube NOS                     |
| ULC   | Ulcer                        |
| UMB   | Umbilical blood              |
| UMED  | Unknown medicine             |
| URTH  | Urethra                      |
| UR    | Urine                        |
| URC   | Urine clean catch            |
| URT   | Urine catheter               |
| URNS  | Urine sediment               |
| USUB  | Unknown substance            |
| VITF  | Vitreous Fluid               |
| VOM   | Vomitus                      |
| BLD   | Whole blood                  |
| BDY   | Whole body                   |
| WAT   | Water                        |
| WICK  | Wick                         |
| WND   | Wound                        |
| WNDA  | Wound abscess                |
| WNDE  | Wound exudate                |
| WNDD  | Wound drainage               |

**Table 108. Specimen Source Field Values<sup>uu</sup>**

| CODE                              | DESCRIPTION             | CODE  | DESCRIPTION              |
|-----------------------------------|-------------------------|-------|--------------------------|
| BE                                | Bilateral Ears          | LVL   | Left Vastus Lateralis    |
| OU                                | Bilateral Eyes          | NB    | Nebulized                |
| BN                                | Bilateral Nares         | PA    | Perianal                 |
| BU                                | Buttock                 | PERIN | Perineal                 |
| CT                                | Chest Tube              | RA    | Right Arm                |
| LA                                | Left Arm                | RAC   | Right Anterior Chest     |
| LAC                               | Left Anterior Chest     | RACF  | Right Antecubital Fossa  |
| LACF                              | Left Antecubital Fossa  | RD    | Right Deltoid            |
| LD                                | Left Deltoid            | RE    | Right Ear                |
| LE                                | Left Ear                | REJ   | Right External Jugular   |
| LEJ                               | Left External Jugular   | OD    | Right Eye                |
| OS                                | Left Eye                | RF    | Right Foot               |
| LF                                | Left Foot               | RG    | Right Gluteus Medius     |
| LG                                | Left Gluteus Medius     | RH    | Right Hand               |
| LH                                | Left Hand               | RIJ   | Right Internal Jugular   |
| LIJ                               | Left Internal Jugular   | RLAQ  | Rt Lower Abd Quadrant    |
| LLAQ                              | Left Lower Abd Quadrant | RLFA  | Right Lower Forearm      |
| LLFA                              | Left Lower Forearm      | RMFA  | Right Mid Forearm        |
| LMFA                              | Left Mid Forearm        | RN    | Right Naris              |
| LN                                | Left Naris              | RPC   | Right Posterior Chest    |
| LPC                               | Left Posterior Chest    | RSC   | Right Subclavian         |
| LSC                               | Left Subclavian         | RT    | Right Thigh              |
| LT                                | Left Thigh              | RUA   | Right Upper Arm          |
| LUA                               | Left Upper Arm          | RUAQ  | Right Upper Abd Quadrant |
| LUAQ                              | Left Upper Abd Quadrant | RUFA  | Right Upper Forearm      |
| LUFA                              | Left Upper Forearm      | RVL   | Right Vastus Lateralis   |
| LVG                               | Left Ventragluteal      | RVG   | Right Ventragluteal      |
| Continued in right-hand column... |                         |       |                          |

**Table 109. Specimen Role Field Values<sup>vv</sup>**

| VALUE | DESCRIPTION                                |
|-------|--|
| P     | Patient (default if blank component value) |
| Q     | Control specimen                           |
| C     | Calibrator                                 |
| B     | Blind Sample                               |
| R     | Replicate (of patient sample as a control) |

<sup>uu</sup> Referenced from HL7 v2.4, Chapter 7 - HL7 Table 0163 - Body site.

<sup>vv</sup> Referenced from HL7 v2.4, Chapter 4 - User-defined Table 0369 - Specimen role.

## 4.3.6 OBX – Observation Result Segment

Table 110. OBX Segment

| SEQ | LEN   | DT  | OPT | HL7 SEGMENT FIELD NAME           | NOTES ON POCT1 USE   |
|-----|-------|-----|-----|----------------------------------|--|
| 1   | 10    | SI  | O   | Set ID                           | Optional. Provided by some Devices.  |
| 2   | 2     | ID  | R   | Value Type                       | All POCT1 values are "ST" (string).  |
| 3   | 590   | CE  | R   | Observation Identifier           | e.g., ^^AaDpO2,T&E - a mnemonic identifying the parameter along with a subcomponent specifying the type of observation, in this case [E]stimated). |
| 4   | 20    | ST  | X   | Observation Sub-ID               |  |
| 5   | 65536 | *   | CE  | Observation Value                | e.g., "150," "<50," "HI," "LO" - Note (1), Note (2).   |
| 6   | 60    | CE  | CE  | Units                            | "mg/dL" or similar- Note (2), Note (3).  |
| 7   | 10    | ST  | O   | References Range                 | Note (4).  |
| 8   | 40    | ID  | RE  | Abnormal Flags                   | Note (5).  |
| 9   | 5     | NM  | X   | Probability                      |  |
| 10  | 2     | ID  | X   | Nature of Abnormal Test          |  |
| 11  | 1     | ID  | R   | Result Status                    | Usually "F" (final result). Note (6).  |
| 12  | 26    | TS  | X   | Date Last Observed Normal Values |  |
| 13  | 20    | ST  | X   | User Defined Access Checks       |  |
| 14  | 26    | TS  | O   | Date/Time of the Observation     | Format is CCYYMMDDHHMMSS[+/-ZZZZ]. Note (7).   |
| 15  | 60    | CE  | X   | Producer's ID                    |  |
| 16  | 80    | XCN | O   | Responsible Observer             | POC User ID^optional Last^First name<br>Note (8).  |
| 17  | 60    | CE  | O   | Observation Method               |  |
| 18  | 22    | EI  | O   | Equipment Instance Identifier    | IEEE EUI-64 format. Note (8), Note (9).  |
| 19  | 26    | TS  | O   | Date/Time of Analysis            | The time stamp when the Device performed the test. Format is CCYYMMDDHHMMSS[+/-ZZZZ]. Note (7), Note (8).  |

Any fields defined beyond Sequence 19 are ignored by this specification.

- (1) Some Devices can record "HI" or "LO" or similar as the result value when beyond the range of the instrument. In addition, some sites wish to have values outside site defined ranges to be specified in the form "< 50" or ">550." The Observation Reviewer may also convert these values to some reference range limit at the Hospital's request.
- (2) This field may be empty if OBX-8 is used.
- (3) May be empty if no units apply, e.g., pH. See HL7 v2.4 Chapter 7, Section 7.3.2.6, Figure 7-9 - Common ISO derived units & ISO+ extensions, for standard unit type representations.
- (4) The reference range values are encoded using the following scheme:

- If both lower (lo) and upper (hi) limit are known:

lo\_value^lo\_units-hi\_value^hi\_units (e.g., 70^mg/dl-105^mg/dl)

- If only the lower limit is known:

>lo\_value^lo\_units (e.g., >70^mg/dl)

- If only the upper limit is known:

<hi\_value^hi\_units (e.g., <105^mg/dl)

- (5) This field may be used, in lieu of OBX-5, to indicate a relative result such as High (H), Low (L), or Normal (N). See HL7 Chapter 7, *Table 0078 – Abnormal Flags* for code values.
- (6) Coded values for this field may be found in HL7 *Table 0085 - Observation result status codes interpretation*.
- (7) OBX-14 (Date/Time of Observation) is the physiologically most relevant date-time. In some cases, this time will be the same as that in OBX-19 (Date/Time of Analysis). In other cases, this time may be the time a sample is drawn. If OBX-14 contains the same value as OBX-19 (i.e., the Observation time is the same as Analysis time), it may duplicate the value in OBX-19 or may be omitted.
- (8) For multivalued results from the same Device, this field is required only in the first OBX segment.
- (9) The Device Interface specification requires that every Device be identified by a universally unique identifier in the format specified by IEEE for the EUI-64 identifier. To allow the Observation Reporting interface to be employed with ‘legacy’ Devices, this field may also be populated by a combination of Device name and serial number. If the EUI-64 identifier is available, it should be recorded in the ‘universal ID’ component of this field. If it is not available, the manufacturer’s Device identifier (e.g., serial number) should be recorded in ‘universal ID’ component, with the Device or manufacturer name in ‘universal ID type’ component.

### 4.3.7 ORC– Common Order Segment

Table 111. ORC Segment

| SEQ | LEN | DT  | OPT | HL7 SEGMENT NAME          | NOTES ON POCT1 USE   |
|-----|-----|-----|-----|---------------------------|--|
| 1   | 2   | ID  | R   | Order Control             | Use Case #1, #2: “NW.” Use Case #3: “RE.” Note (1).                          |
| 2   | 22  | EI  | C   | Placer Order Number       | Use Case #3 Only: Order ID.  |
| 3   | 22  | EI  | O   | Filler Order Number       | External identifier for these results in the Observation Reviewer. Note (2). |
| 4   | 22  | EI  | X   | Placer Group Number       |  |
| 5   | 2   | ID  | X   | Order Status              |  |
| 6   | 1   | ID  | X   | Response Flag             |  |
| 7   | 200 | TQ  | X   | Quantity/Timing           |  |
| 8   | 200 | CM  | X   | Parent                    |  |
| 9   | 26  | TS  | X   | Date/Time of Transaction  |  |
| 10  | 120 | XCN | X   | Entered By                |  |
| 11  | 120 | XCN | X   | Verified By               |  |
| 12  | 120 | XCN | X   | Ordering Provider         |  |
| 13  | 80  | PL  | X   | Enterer’s Location        |  |
| 14  | 40  | XTN | X   | Call Back Phone Number    |  |
| 15  | 26  | TS  | X   | Order Effective Date/Time |  |
| 16  | 200 | CE  | X   | Order Control Code Reason |  |
| 17  | 60  | CE  | X   | Entering Organization     |  |
| 18  | 60  | CE  | X   | Entering Device           |  |

Any fields defined beyond Sequence 3 are ignored by this specification.

- (1) “NW” – New Order for ORU^R30. “RE” – Observations Follow for ORU^R31 and ORU^R32
- (2) The Observation Reviewer may supply an external identifier in this field that other systems can use to reference this result set. This specification places no restrictions on the format or content of this field’s value. For example, some Observation Reviewers might expose a database key in this field while others might use a combination of Device name, serial number and the time stamp of the result as the unique external identifier.

4.3.8 PID– Patient Identification Segment

Table 112. PID Segment

| SEQ | LEN | DT  | OPT | HL7 SEGMENT FIELD NAME            | NOTES ON POCT1 USE  |
|-----|-----|-----|-----|-----------------------------------|---|
| 1   | 4   | SI  | O   | Set ID - Patient ID               | Optional. Set ID Sequence Number.   |
| 2   | 20  | CX  | X   | Patient ID                        |   |
| 3   | 20  | CX  | R   | Patient Identifier List           | Use Case #1, #2 Patient ID required. Note (1).<br>Use Case #3: Patient ID, if available. When not available, value duplicates Specimen ID field.<br>Note (2). |
| 4   | 20  | CX  | X   | Alternate Patient ID – PID        |   |
| 5   | 48  | XP  | X   | Patient Name                      |   |
| 6   | 48  | XP  | X   | Mother's Maiden Name              |   |
| 7   | 26  | TS  | X   | Date/Time of Birth                |   |
| 8   | 1   | IS  | X   | Administrative Sex                |   |
| 9   | 48  | XP  | X   | Patient Alias                     |   |
| 10  | 1   | IS  | X   | Race                              |   |
| 11  | 106 | XAD | X   | Patient Address                   |   |
| 12  | 4   | IS  | RE  | Country Code                      | Empty for USA.  |
| 13  | 40  | XTN | X   | Phone Number – Home               |   |
| 14  | 40  | XTN | X   | Phone Number – Business           |   |
| 15  | 60  | CE  | X   | Primary Language                  |   |
| 16  | 1   | IS  | X   | Marital Status                    |   |
| 17  | 3   | IS  | X   | Religion                          |   |
| 18  | 20  | CX  | O   | Patient Account Number            | Account number, if available. Note (3).   |
| 19  | 16  | ST  | X   | SSN Number – Patient              |   |
| 20  | 25  | DLN | X   | Driver's License Number - Patient |   |
| 21  | 250 | CX  | X   | Mother's Identifier               |   |
| 22  | 250 | CE  | X   | Ethnic Group                      |   |
| 23  | 250 | ST  | X   | Birth Place                       |   |
| 24  | 1   | ID  | X   | Multiple Birth Indicator          |   |
| 25  | 2   | NM  | X   | Birth Order                       |   |
| 26  | 250 | CE  | X   | Citizenship                       |   |
| 27  | 250 | CE  | X   | Veterans Military Status          |   |
| 28  | 250 | CE  | X   | Nationality                       |   |
| 29  | 26  | TS  | X   | Patient Death Date and Time       |   |
| 30  | 1   | ID  | X   | Patient Death Indicator           |   |
| 31  | 1   | ID  | X   | Identity Unknown Indicator        |   |
| 32  | 20  | IS  | X   | Identity Reliability Code         |   |
| 33  | 26  | TS  | X   | Last Update Date/Time             |   |
| 34  | 40  | HD  | X   | Last Update Facility              |   |
| 35  | 250 | CE  | X   | Species Code                      |   |
| 36  | 250 | CE  | X   | Breed Code                        |   |
| 37  | 80  | ST  | X   | Strain                            |   |
| 38  | 250 | CE  | X   | Production Class Code             |   |



Any fields defined beyond Sequence 18 are ignored by this specification.

- (1) The Patient Identifier List field (PID-3) can be used for either patient or order identification, depending on the messaging Use Case. In Use Case #3, this field should contain a patient ID if available and the contents of the Specimen ID field if patient ID is not available. In Use Case #1 and #2, an order identifier will not be available, so PID-3 must contain a patient identifier. If a patient account number is supplied in PID-3, it should be duplicated in PID-18.
- (2) The issue of which type of identifier is acceptable under what circumstances involves vendor implementation matters and customer business rules. For example, if no heuristic exists in a given institution that can reliably map an accession number to a patient identifier, an Observation Recipient will not be able to accept an Order ID as patient identification. In such a case, the institution might require that a medical record number be provided in PID-3 for all point-of-care use cases.
- (3) Account Number may be required to identify visit at some facilities.

## 5 Sample Messages

The following sections contain example messages that illustrate the three use cases for the Observation Reporting interface.

These messages are encoded in both the traditional HL7 ER syntax as well as XML syntax. The XML messages were developed from the ER message structure using the document, *HL7 Recommendation: Using XML as a Supplementary Messaging Syntax to HL7 Version 2.3.1*.

Table 113 summarizes the use cases and messaging properties that the four sample messages illustrate.

**Table 113. Sample Message Summary**

| SAMPLE | OBSERVATION   | ORDER                 | USE CASE    | MESSAGE |
|--------|---------------|-----------------------|-------------|---------|
| #1     | Single-valued | Supplied              | Use Case #3 | ORU^R32 |
| #2     | Single-valued | Not supplied - Create | Use Case #1 | ORU^R30 |
| #3     | Multivalued   | Not supplied - Search | Use Case #2 | ORU^R31 |
| #4     | Multivalued   | Not supplied - Create | Use Case #1 | ORU^R30 |

These sample message scenarios are described in more detail in the following subsections.

### 5.1 Sample #1: Preordered Test With Single-Valued Result

This sample message illustrates the transfer of a patient test result from a generic single-measurement Device. The test is performed by a Nurse or Med Tech at or near a patient. The test has already been ordered under “standing orders” or other hospital protocol and is identified to the Device by an accession number or order ID.

Optional fields in this sample message include:

- Patient ID;
- Patient Account Number; and
- Ordering Physician ID.

This sample message uses the **ORU^R32** message.

Figure 58 shows the high-level message flow for this sample exchange.

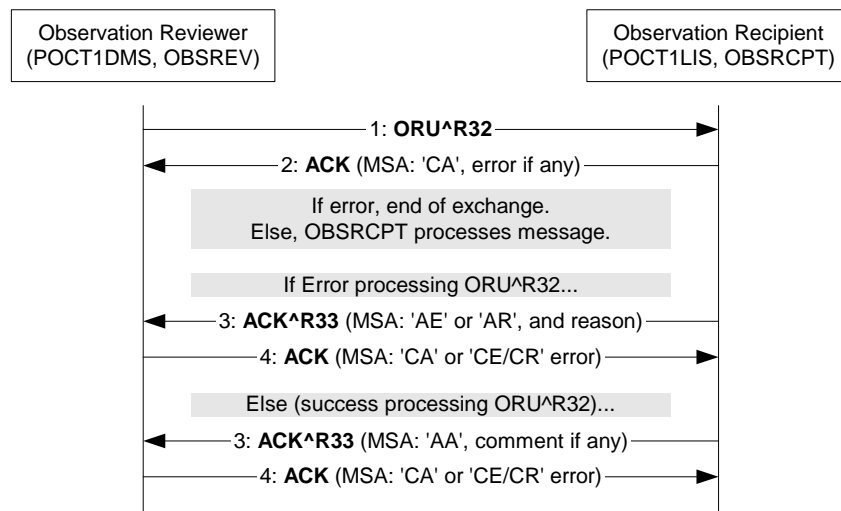

**Figure 58. Sample #1 Message Flow**

### 5.2 Sample #2: Unordered Single-Valued Result, Create New Order

This sample illustrates transmission of a patient test result from a generic single-valued Device. In this case, an order has not been placed for this service. The Observation Recipient is instructed to automatically place an order for this result. For example, automatic ordering of the test could occur under the following circumstances:

- Under “standing orders” for the Patient, or
- Under “as needed orders” for the Patient, or
- As a result of a request from a physician or notification by another means (e.g., message from the HIS) that the test is to be performed at a specified time.

A Nurse or Med Tech performs the test on a patient who is identified to the Device by a Patient identifier. Optional fields in this sample message include:

- Patient Account Number; and
- Ordering Physician ID.

The Device communicates the observation to an Observation Reviewer, which in turn transfers the observation to an Observation Recipient using the Observation Reporting Interface protocol. In this case, the Observation Recipient will place an order for the test and immediately result the test contained in the message.

This sample message uses the **ORU^R30** message.

Figure 59 illustrates the high-level message flow for this sample exchange.

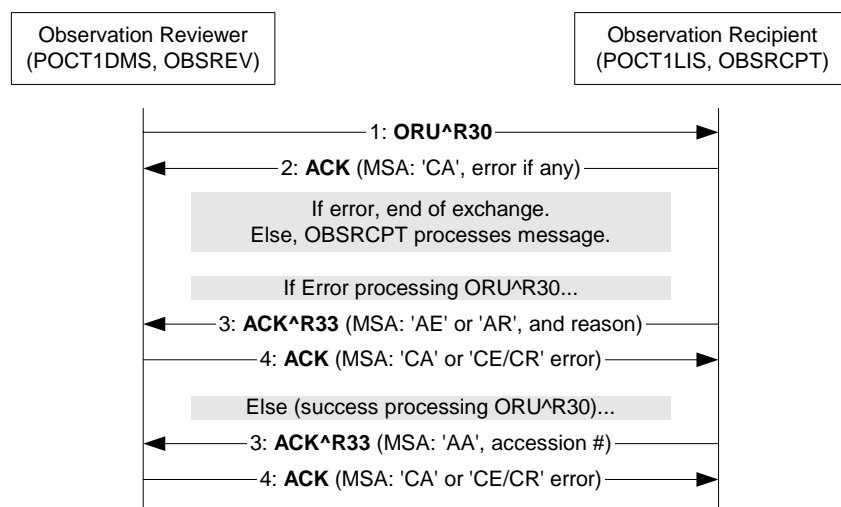

**Figure 59. Sample #2 Message Flow**

If the Observation Recipient successfully creates a new order and records the result, it should return the accession number of the newly created order to the Observation Reviewer in the **ACK^R33** acknowledgement message (#3, in figure above). This return value allows the Observation Reviewer to correlate every result with its associated order information. If the Observation Recipient wants to return additional comments to the Observation Recipient, they may also be included in the **ACK^R33** message.

### 5.3 Sample #3: New Multivalued Result, Search for an Order

This sample illustrates transmission of a patient test result from a generic multianalyte analyzer where the test has not already been ordered. Automatic ordering of the test is allowed under the rules specified for the previous use case.

The Device communicates the observation to an Observation Reviewer, which in turn transfers the observation to an Observation Recipient using the Observation Reporting protocol. In this case, the Observation Recipient will search for an existing order matching the 'profile' or 'package' of results contained in the message. If the Observation Recipient finds a matching order, it will immediately commit the observation values contained in the message. Institutional guidelines will govern what the Observation Recipient does if no matching order is found.

Optional fields in this sample message include:

- Patient Account Number; and
- Ordering Physician ID.

This sample message uses the **ORU^R31** message. Figure 60 illustrates the high-level message flow for this sample exchange.

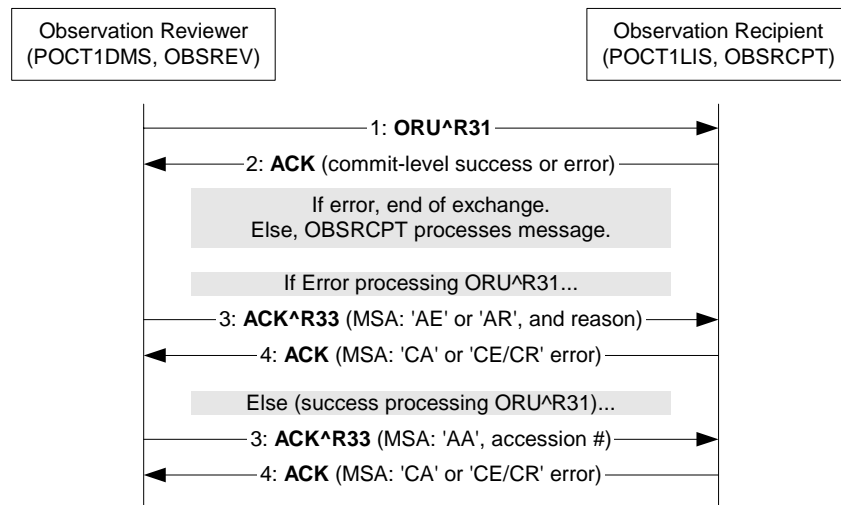

Figure 60. Sample #3 Message Flow

If the Observation Recipient finds a matching order or creates a new order, it should return the accession number of the order to the Observation Reviewer in the **ACK^R33** acknowledgement message (#3, in figure above). This return value allows the Observation Reviewer to correlate every result with its associated order information. If the Observation Recipient wants to return additional comments to the Observation Recipient, they may also be included in the **ACK^R33** message.

#### 5.4 Sample #4: Unordered Blood Gas Result, Create New Order

This sample illustrates transmission of a patient test from a typical blood-gas analyzer where the test has not already been ordered. As in Sample #2, the Observation Recipient is instructed to create a new order. This use case illustrates:

- the results from a typical Blood Gas Analyzer;
- identification of multivalued results via a single service ID (battery or panel);
- identification of the specimen source;
- additional attribution provided by the Observation Reviewer. Abnormal flags are added to each result after analyzing the values with respect to accepted normal and critical ranges; and
- use of the Set ID field as a sequence number that is counted up for each OBX segment sent.

Optional fields in this sample message include:

- Patient Account Number; and
- Ordering Physician ID.

Automatic ordering of the test proceeds as described in Sample #2. In this case, the Observation Reviewer requests that the LIS/HIS place an Order for the “profile” or “package” of and immediately submits the test results in the same message (using individual OBX segments for each value).

This sample message uses the **ORU^R30** message. Figure 61 illustrates the high-level message flow for this sample exchange.

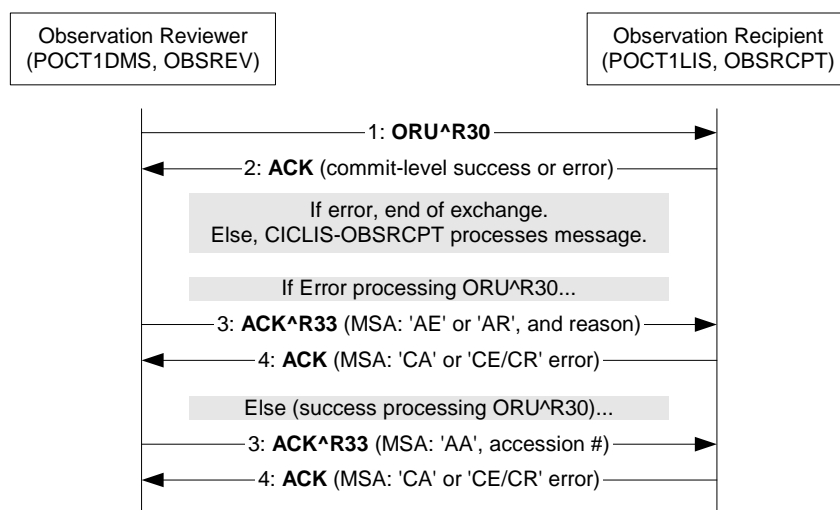

**Figure 61. Sample #4 Message Flow**

When the Observation Recipient successfully creates a new order and records the result, it should return the accession number of the newly created order to the Observation Reviewer in the **ACK^R33** acknowledgement message (#3, in figure above). This return value allows the Observation Reviewer to correlate every result with its associated order information. If the Observation Recipient wants to return additional comments to the Observation Recipient, they may also be included in the **ACK^R33** message.

## 5.5 General Notes

In the following examples the point-of-care Device, Observation Reporter and Observation Reviewer are identified using generic POCT1 system names:

**Table 114. Sample Message Participants**

| ROLE                              | SAMPLE NAME                           |
|-----------------------------------|---------------------------------------|
| Observation Reviewer Facility     | OBSREV                                |
| Observation Reviewer Application  | POCT1DMS                              |
| Observation Recipient Facility    | OBSRCPT                               |
| Observation Recipient Application | POCT1LIS                              |
| Single-analyte POC Device         | POCT1DEV-111^SINGRES <sup>ww</sup>    |
| Multianalyte POC Device           | 12-34-56-78-90-AB-CD-EF <sup>ww</sup> |

## 5.6 Values for Sample Messages

The following values are used in the sample messages:

- Device Identifier (globally unique identifier – IEEE EUI-64 format — preferred);
- User ID (“User9876”);
- Patient (“Pat Patient,” medical record number “MR12345678” at ‘Facility1’);

<sup>ww</sup> Devices are identified in the sample messages by both a ‘legacy’ manufacturer identifier (single-analyte example) and by the IEEE EUI-64 format identifier specified by the Device Interface (multianalyte example).

- ID of the ordered test (“OrdIDA24680”);
- Test Date and Time (06/09/2000 10:21:35 AM);
- Comment Codes or Text (“Stat” and “Physician Notified”);
- Service ID (“1234-5^GLU^LN” for Glucose);
- Test Result in mg/dL (105 mg/dL);
- Value Flag (empty);
- Account Number (“ActID135792468” at Facility 1), required at some sites, is shown here for completeness; and
- Ordering Physician, (“Dr. John J. Smith,” identifier “5555”), required at some sites to order, is shown here for completeness.

**5.7 Sample Message Exchanges (ER Encoding)**

**NOTE:** In the following samples the designations <VT>, <CR>, and <FS> represent the ASCII characters 11, 13, and 28 and not literal strings. Individual segments are placed on separate lines for readability; this does not imply the presence of a <CR>, <LF>, or other end of line designation unless explicitly expressed.

**5.7.1 Sample #1, Preordered Test With Single-Valued Result**

**ORU^R32** – Observation Result Message from POCT1DMS-OBSREV to POCT1LIS-OBSRCPT LIS sent 6/10/00 1:03:55

```
<VT>
MSH|^~\&|POCT1DMS|OBSREV|POCT1LIS|OBSRCPT|20000610010355||ORU^R32|20000610010355:023|P|2.4|||AL|AL<CR>
PID|||MR12345678^^^Facility1|||||||ActID135792468^^^1<CR>
ORC|RE|OrdIDA24680<CR>
OBR|||1234-5^GLU^LN|||0|||5555^Smith^John^J^Dr<CR>
OBX||ST|1234-5^GLU^LN|120|mg/dl|||F|||User9876|POCT1DEV-111^SINGRES|20000609102135<CR>
NTE||Stat~Physician Notified<CR>
<FS><CR>
```

POCT1LIS must reply immediately with a Commit **ACK** specifying either ‘CA’ (accept), ‘CE’ (error), or ‘CR’ (reject). POCT1LIS generates its own Message Control ID and uses the Message Control ID field from the received message for MSA-2. For success:

```
<VT>
MSH|^~\&|POCT1LIS|OBSRCPT|POCT1DMS|OBSREV|20000610010356||ACK|20000610010356CA|P|2.4|||NE|NE<CR>
MSA|CA|20000610010355:023<CR>
<FS><CR>
```

Otherwise, for a Commit error:

```
<VT>
MSH|^~\&|POCT1LIS|OBSRCPT|POCT1DMS|OBSREV|20000610010356||ACK|20000610010356CE|P|2.4|||NE|NE<CR>
MSA|CE|20000610010355:023|TCP Comm Error, Invalid HL7 Message|||3214<CR>
<FS><CR>
```

POCT1LIS must send an **ACK^R33** message as an Application Acknowledgement. This message is similar to the Commit Acknowledgement except that the Message Type is **ACK^R33** rather than **ACK**, with an acknowledgement code of 'AA' (accept), 'AE' (error), or 'AR' (reject).

If POCT1LIS accepts both the order and the result, it will send an **ACK^R33** with the acknowledgement code 'AA.' If POCT1LIS wishes to return a comment, it may include the comment in the acknowledgement message text field (MSA-3).

If POCT1LIS is unable to accept both the order and the result, no order or result should be placed and an error should be returned in the MSA error field of the **ACK^R33** message. This allows the Observation Reviewer to retransmit the entire message, with possible modifications, without order duplication.

For success:

```
<VT>
MSH|^~\&|POCT1LIS|OBSRCPT|POCT1DMS|OBSREV|20000610010400||ACK^R33|20000610010400AA|P|2.4|||AL|NE<CR>
MSA|AA|20000610010355:023<CR>
<FS><CR>
```

Otherwise, for an error:

```
<VT>
MSH|^~\&|POCT1LIS|OBSRCPT|POCT1DMS|OBSREV|20000610010401||ACK^R33|20000610010400AE|P|2.4|||AL|NE<CR>
MSA|AE|20000610010355:023|Invalid Patient ID|||5634<CR>
<FS><CR>
```

Finally, POCT1DMS-OBSREV will send a commit-level acknowledgement (**ACK**) message in response to the POCT1LIS **ACK^R33** message.

```
<VT>
MSH|^~\&|POCT1DMS|OBSREV|POCT1LIS|OBSRCPT|20000502010401||ACK|20000610010401CA|P|2.4|||NE|NE<CR>
MSA|CA|20000610010400AA<CR>
<FS><CR>
```

## 5.7.2 Sample #2, Unordered Single-Valued Result – Create New Order

**ORU^R30** - General Order Message from POCT1DMS-OBSREV to POCT1LIS-OBSRCPT LIS sent 6/10/00 1:03:55

```
<VT>
MSH|^~\&|POCT1DMS|OBSREV|POCT1LIS|OBSRCPT|20000610010355||ORU^R30|20000610010355:023|P|2.4|||AL|AL<CR>
PID|||MR12345678^^^Facility1|||||ActID135792468^^^1<CR>
ORC|NW<CR>
OBR|||1234-5^GLU^LN|||||O||||5555^Smith^John^J^Dr<CR>
OBX||ST|1234-5^GLU^LN|120|mg/dl||||F||||User9876||POCT1DEV-111^SINGRES|20000609102135<CR>
NTE|||Stat~Physician Notified<CR>
<FS><CR>
```

POCT1LIS must reply immediately with either a Commit **ACK** specifying CA, CE, or CR. POCT1LIS generates its own Message Control ID and uses the Message Control ID field from the received message for MSA-2. This reply is identical to that given in Sample #1.

The LIS must send an **ACK^R33** message as an Application Acknowledgement. This message is similar to the Commit Acknowledgement except that the Message Type is **ACK^R33** rather than **ACK**, with an acknowledgement code of 'AA' (accept), 'AE' (error), or 'AR' (reject).

This **ACK^R33** message will return either the Accession Number/Order ID of the ordered test or an application level error description. If POCT1LIS accepts both the order and the result and wishes to return a comment (such as patient demographic information), it may include the comment in the acknowledgement message text field (MSA-3) as an additional component after the Order ID.

If POCT1LIS is unable to accept the result, an error should be returned in the MSA error field of the **ACK^R33** message. This allows the Observation Reviewer to retransmit the entire message, with possible modifications, without result duplication.

For success:

```
<VT>
MSH|^~\&|POCT1LIS|OBSRCPT|POCT1DMS|OBSREV|20000610010400||ACK^R33|20000610010400AA|P|2.4||AL|NE<CR>
MSA|AA|20000610010355:023|OrdIDA24680^Pat Patient<CR>
<FS><CR>
```

Otherwise, for an error:

```
<VT>
MSH|^~\&|POCT1LIS|OBSRCPT|POCT1DMS|OBSREV|20000610010401||ACK^R33|20000610010400AE|P|2.4||AL|NE<CR>
MSA|AE|20000610010355:023|Invalid Patient ID||5634<CR>
<FS><CR>
```

Finally, POCT1DMS-OBSREV will send a commit-level acknowledgement (ACK) message in response to the POCT1LIS **ACK^R33** message.

```
<VT>
MSH|^~\&|POCT1DMS|OBSREV|POCT1LIS|OBSRCPT|20000502010401||ACK|20000610010401CA|P|2.4||NE|NE<CR>
MSA|CA|20000610010400AA<CR>
<FS><CR>
```

### 5.7.3 Sample #3, New Multivalued Result – Search for an Order

**ORU^R31** - Observation Result Message from POCT1DMS-OBSREV to POCT1LIS-OBSRCPT LIS sent 6/10/00 1:03:55

```
<VT>
MSH|^~\&|POCT1DMS|OBSREV|POCT1LIS|OBSRCPT|20000610010355||ORU^R31|20000610010355:023|P|2.4||AL|AL<CR>
PID||MR12345678^^^Facility1|||||||ActID135792468^^^1<CR>
ORC|NW<CR>
OBR|||Urine Panel 2|||||o|||||5555^Smith^John^J^Dr<CR>
OBX|ST|L5678^pH||5.2|||||F|||||User9876||12-34-56-78-90-AB-CD-EF|20000609102135<CR>
OBX|ST|L2412^Ketone|||||N|||||F|||||User9876||12-34-56-78-90-AB-CD-EF|20000609102135<CR>
<FS><CR>
```

The POCT1LIS replies and POCT1DMS-OBSREV CA acknowledgements are all identical to Use Case #1.

The POCT1LIS will respond to the ORU^R31 message with an Application Acknowledgement message (**ACK^R33**). This message will return either the Accession Number/Order ID of the ordered test or an application level error description. If POCT1LIS accepts both the order and the result and wishes to return a comment, it may include the comment in the acknowledgement message text field (MSA-3) as an additional component after the accession number.



If an error occurs which is associated with only one Device value, the offending value should be identified in the **ACK** error field (MSA-3) in the message returned by POCT1LIS.

If POCT1LIS is unable to accept the results, the POCT1LIS should reply with an **ACK^R33** message indicating the reason in the error field (MSA-3). This allows the Observation Reviewer to retransmit the entire message, with possible modifications, without result duplication.

#### 5.7.4 Sample #4, Unordered Blood Gas Result – Create New Order

**ORU^R30** - Observation Result Message from POCT1-OBSREP to POCT1-OBSREV LIS sent 6/10/00 1:03:55.

```
MSH|^~\&|POCT1DMS|OBSREV|POCT1LIS|OBSRCPT|20000610010355||ORU^R30|20000610010355:023|P|2.4||AL|AL<CR>
PID|1||MR12345678^^^Facility1||Patient^Pat||M|||||||ActID135792468^^^1<CR>
ORC|NW<CR>
OBR|1||BG-OXI-ELECT|||||O||||BLDA^^^LLFA|5555^Smith^John^J^Dr||8024^Sample #<CR>
NTE|1||Battery approved by JAG~Dr. G. John notified of result<CR>
OBX|1|ST|2703-7^^LN^pO2&M||110|mmHg||H|||F||||User9876||12-34-56-78-90-AB-CD-EF|20000609102135<CR>
NTE|1||Stat~Measured value above reference range but within the critical limits<CR>
OBX|2|ST|11557-6^^LN^pCO2&M||33.2|mmHg||L|||F<CR>
NTE|1||Stat~Measured value below reference range but within the critical limits<CR>
OBX|3|ST|11558-4^pH^LN^pH&M||7.474||H|||F<CR>
NTE|1||Stat~Measured value above reference range but within the critical limits<CR>
OBX|4|ST|6298-4^POTASSIUM^LN^K+&M||3.7|mmol/L||N|||F<CR>
OBX|5|ST|14775-1^HEMOGLOBIN^LN^tHb&M||11.6|g/dL||N|||F<CR>
OBX|6|ST|4536-9^DEOXYHEMOGLOBIN/HEMOGLOBIN.TOTAL^LN^RHb&M||1.3||N|||F<CR>
OBX|7|ST|^O2Hb&M||96.9||N|||F<CR>
OBX|8|ST|20563-3^CARBON MONOXIDE.HEMOGLOBIN^LN^COHb&M||1.2||N|||F<CR>
OBX|9|ST|2614-6^METHEMOGLOBIN/HEMOGLOBIN.TOTAL^LN^MetHb&M||0.6||N|||F<CR>
OBX|10|ST|20092-3^BODY TEMPERATURE^LN^T&I||35.3|Cel|||||F<CR>
OBX|11|ST|19994-3^^LN^FIO2&I||30.0||N|||F<CR>
OBX|12|ST|^pH(T)&C||7.500|||||F<CR>
OBX|13|ST|^pCO2(T)&C||30.5|mmHg|||||F<CR>
OBX|14|ST|19235-1^^LN^SBE&C||0.8|mmol/L|||||F<CR>
OBX|15|ST|19230-2^^LN^SBC&C||25.6|mmol/L|||||F<CR>
OBX|16|ST|20570-8^^LN^Hct&C||35.7||N|||F<CR>
OBX|17|ST|19254-2^^LN^pO2(T)&C||101|mmHg|||||F<CR>
OBX|18|ST|19214-6^^LN^p50(act)&E||24.15|mmHg|||||F<CR>
OBX|19|ST|^AaDpO2&E||59.1|mmHg|||||F<CR>
OBX|20|ST|^AaDpO2,T&E||72.0|mmHg|||||F<CR>
OBX|21|ST|^tO2&C||15.9|Vol%|||||F<CR>
OBX|22|ST|^RI&E||54||N|||F<CR>
```

The POCT1LIS reply messages and the POCT1DMS-OBSREV commit-level acknowledgements are all identical to Sample #2.

If POCT1LIS is unable to commit both the order and all of the observations documented in the OBX segments, no order or result should be placed. The POCT1LIS should reply with an **ACK^R33** message, identifying the offending value(s) in the MSA-3 error field. This allows the Observation Reviewer to retransmit the entire message, with possible modifications, without order duplication.

## 5.8 HL7 v2.x Equivalent XML Syntax

The HL7 Abstract Message syntax for the simple test result message describes the structure for the elements of the XML-encoded message. Recall that the Abstract Message syntax is as follows:

| POINT-OF-CARE OBSERVATION |  |
|---------------------------|--|
| MSH                       | Message Header                                       |
| PID                       | Patient Identification                               |
| ORC                       | Common Order information                             |
| OBR                       | Observation Request                                  |
| [ NTE ]                   | Comment attached to entire result                    |
| {                         |  |
| OBX                       | Observation Result                                   |
| [ NTE ]                   | Note or Comments attached to each observation result |
| }                         |  |

Using the HL7 v2.3.1 Document Type Definitions (DTDs) and the message values from the previous example, the XML-encoded message would look like the following:

## 5.9 Sample Message Exchange (XML Encoding)

**Note:** In the following samples the designations <VT>, <CR>, and <FS> represent the ASCII characters 11, 13, and 28 and not XML Tags. Individual segments are placed on separate lines for readability; this does not imply the presence of a <CR>, <LF>, or other end of line designation unless explicitly expressed.

### 5.9.1 Sample #1, Preordered Test With Single-Valued Result

**ORU^R32** - Observation Result Message from POCT1DMS-OBSREV to POCT1LIS-OBSRCPT LIS sent 6/10/00 1:03:55.

```
<!DOCTYPE ORU_R32 SYSTEM "hl7_v231.dtd">
<ORU_R32>
  <MSH>                                     <!-- MESSAGE HEADER SEGMENT -->
    <MSH.1>|</MSH.1>                       <!--Field separator -->
    <MSH.2>^~\&amp;</MSH.2>                   <!--Encoding characters -->
    <MSH.3>                                     <!--Sending Application -->
      <HD.1>POCT1DMS</HD.1>
    </MSH.3>
    <MSH.4>                                     <!--Sending Facility -->
      <HD.1>OBSREV</HD.1>
    </MSH.4>
    <MSH.5>                                     <!--Receiving Application -->
      <HD.1>POCT1LIS</HD.1>
    </MSH.5>
    <MSH.6>                                     <!--Receiving Facility -->
      <HD.1>OBSRCPT</HD.1>
    </MSH.6>
    <MSH.7>20000610010355</MSH.7>           <!--Date/Time of message -->
    <MSH.9>                                     <!--Message type -->
      <CM_MSG_TYPE.1>ORU</CM_MSG_TYPE.1>
      <CM_MSG_TYPE.2>R32</CM_MSG_TYPE.2>
    </MSH.9>
    <MSH.10>20000610010355:023</MSH.10>    <!--Message control ID -->
    <MSH.11>                                     <!--Processing ID (T/D/P)-->
      <PT.1>P</PT.1>
```

```

</MSH.11>                                <!--Processing ID (Train/Debug/Prod)-->
<MSH.12>                                <!--Version ID-->
    <VID.1>2.4</VID.1>
</MSH.12>
<MSH.15>AL</MSH.15>                      <!--Accept Acknowledgement type, Always -->
<MSH.16>AL</MSH.16>                      <!--Application Acknowledgement type, Always -->
</MSH>

<PID>                                     <!--PATIENT IDENTIFICATION SEGMENT -->
    <PID.3>                                <!--Patient ID (internal) -->
        <CX.1>MR12345678</CX.1>
        <CX.4>Facility1</CX.4>
    </PID.3>
    <PID.18>                               <!--Account Number, if required -->
        <CX.1>ActID135792468</CX.1>
        <CX.4>1</CX.4>
    </PID.18>
</PID>

<ORC>                                     <!-- COMMON ORDER SEGMENT -->
    <ORC.1>RE</ORC.1>                     <!--Order Control, Observations Follow -->
    <ORC.2>
        <EI.1>OrdIDA24680</EI.1>         <!--Accession Number/Order ID of Test -->
    </ORC.2>
</ORC>

<OBR>                                     <!-- OBSERVATION REQUEST SEGMENT -->
    <OBR.4>                                <!--Universal service ID -->
        <CE.1>L12345</CE.1>             <!--LOINC Code -->
        <CE.2>GLU</CE.2>               <!--Mnemonic Code -->
    </OBR.4>
    <OBR.11>0</OBR.11>                    <!--Specimen Type -->
    <OBR.16>                                <!--Ordering Provider, if required -->
        <XCN.1>555</XCN.1>             <!--Doctor's ID -->
        <XCN.2>Smith</XCN.2>           <!--Doctor's Name -->
        <XCN.3>John</XCN.3>
        <XCN.4>J</XCN.4>
        <XCN.5>Dr</XCN.5>
    </OBR.16>
</OBR>

<OBX>                                     <!-- OBSERVATION RESULT SEGMENT -->
    <OBX.2>ST</OBX.2>                     <!--Value type (ST=string) -->
    <OBX.3>                                <!--Observation ID -->
        <CE.1>L12345</CE.1>             <!--LOINC Code -->
        <CE.2>GLU</CE.2>               <!--Mnemonic Code -->
    </OBX.3>
    <OBX.5>120</OBX.5>                    <!--Observation value -->
    <OBX.6>                                <!--Observation units -->
        <CE.1>mg/dl</CE.1>
    </OBX.6>
    <OBX.11>F</OBX.11>                    <!--Observation result status (F=final)-->

```

```

    <OBX.16>                                <!--Responsible observer (user id) -->
      <XCN.1>User9876</XCN.1>
    </OBX.16>
    <OBX.18>20000609102135</OBX.18>         <!--Equipment instance identifier-->
    <OBX.19>                                <!--Date/Time of the analysis-->
      <CE.1>12-34-56-78-90-AB-CD-EF</CE.1>
    </OBX.19>
  </OBX>

  <NTE>                                     <!--NOTES AND COMMENTS SEGMENT -->
    <NTE.3>Stat~Physician notified</NTE.3>  <!--Use "~" to separate comments -->
  </NTE>
</ORU_R32>

```

POCT1LIS must reply immediately with either a Commit **ACK** specifying CA, CE, or CR. POCT1LIS generates its own Message Control ID and uses the Message Control ID field from the received message for MSA-2. For success:

```

<!DOCTYPE ACK SYSTEM "hl7_v231.dtd">
<ACK>
  <MSH>                                     <!-- Message Header Segment -->
    <MSH.1>|</MSH.1>                       <!-- Field separator -->
    <MSH.2>^~\&amp;</MSH.2>                 <!-- Encoding characters -->
    <MSH.3>
      <HD.1>POCT1LIS</HD.1>
    </MSH.3>                                <!--Sending Application -->
    <MSH.4>
      <HD.1>OBSRCPT</HD.1>
    </MSH.4>                                <!--Sending Facility -->
    <MSH.5>
      <HD.1>POCT1DMS</HD.1>
    </MSH.5>                                <!--Receiving Application -->
    <MSH.6>
      <HD.1>OBSREV</HD.1>
    </MSH.6>                                <!--Receiving Facility -->
    <MSH.7>20000610010356</MSH.7>         <!-- Date/Time of message -->
    <MSH.9>                                <!--Message type -->
      <CM_MSG_TYPE.1>ACK</CM_MSG_TYPE.1>
    </MSH.9>
    <MSH.10>20000610010356CA</MSH.10>     <!--Message control ID -->
    <MSH.11>
      <PT.1>P</PT.1>
    </MSH.11>                               <!--Processing ID (Train/Debug/Prod)-->
    <MSH.12>
      <VID.1>2.4</VID.1>
    </MSH.12>                               <!--Version ID -->
    <MSH.15>NE</MSH.15>                   <!--Accept Acknowledgement type -->
    <MSH.16>NE</MSH.16>                   <!--Application Acknowledgement type -->
  </MSH>

  <MSA>                                     <!-- Message Acknowledge Segment -->
    <MSA.1>CA</MSA.1>                     <!--Ack code (CA=commit accept) -->
    <MSA.2>20000610010355:023</MSA.2>    <!--Msg control ID (from MSH.10) -->
  </MSA>

</ACK>

```

Once the LIS has processed the **ORU** message's contents, it must send an Application Acknowledgement message. This message is similar to the Commit Acknowledgement except that the Message Type is **ACK^R33** rather than **ACK**, and the acknowledgement code is AA, AE, or AR.

If the POCT1LIS-OBSRCPT is able to commit the order and the observation result, it will send the following **ACK^R33** message:

```
<!DOCTYPE ACK_R33 SYSTEM "hl7_v231.dtd">
<ACK_R33>
  <MSH>                                     <!-- Message Header Segment -->
    <MSH.1>|</MSH.1>                       <!--Field separator -->
    <MSH.2>^~\&#38;</MSH.2>                 <!--Encoding characters -->
    <MSH.3>
      <HD.1>POCT1LIS</HD.1>
    </MSH.3>                                 <!--Sending Application -->
    <MSH.4>
      <HD.1>OBSRCPT</HD.1>
    </MSH.4>                                 <!--Sending Facility -->
    <MSH.5>
      <HD.1>POCT1DMS</HD.1>
    </MSH.5>                                 <!--Receiving Application -->
    <MSH.6>
      <HD.1>OBSREV</HD.1>
    </MSH.6>                                 <!--Receiving Facility -->
    <MSH.7>20000610010400</MSH.7>          <!--Date/Time of message -->
    <MSH.9>
      <CM_MSG_TYPE.1>ACK</CM_MSG_TYPE.1>
      <CM_MSG_TYPE.2>R33</CM_MSG_TYPE.2>
    </MSH.9>
    <MSH.10>20000610010400AAA</MSH.10>     <!--Message control ID -->
    <MSH.11>
      <PT.1>P</PT.1>
    </MSH.11>                                <!--Processing ID (Train/Debug/Prod)-->
    <MSH.12>
      <VID.1>2.4</VID.1>
    </MSH.12>                                <!--Version ID -->
    <MSH.15>AL</MSH.15>                     <!--Accept Acknowledgement type -->
    <MSH.16>NE</MSH.16>                     <!--Application Acknowledgement type -->
  </MSH>

  <MSA>                                     <!-- Message Acknowledge Segment -->
    <MSA.1>AA</MSA.1>                       <!--Ack code (AA=application accept) -->
    <MSA.2>20000610010355:023</MSA.2>     <!--Msg control ID (from MSH.10) -->
  </MSA>

</ACK_R33>
```

In response, POCT1DMS-OBSREV will send a commit-level acknowledgement message (**ACK**) in response to the **ACK^R33** message.

```
<!DOCTYPE ACK SYSTEM "hl7_v231.dtd">
<ACK>
  <MSH>                                     <!-- Message Header Segment -->
    <MSH.1>|</MSH.1>                       <!--Field separator -->
    <MSH.2>^~\&#38;</MSH.2>                 <!--Encoding characters -->
```

```

<MSH.3>
  <HD.1>POCT1DMS</HD.1>
</MSH.3>                                <!--Sending Application -->
<MSH.4>
  <HD.1>OBSREV</HD.1>
</MSH.4>                                <!--Sending Facility -->
<MSH.5>
  <HD.1>POCT1LIS</HD.1>
</MSH.5>                                <!--Receiving Application -->
<MSH.6>
  <HD.1>OBSRCPT</HD.1>
</MSH.6>                                <!--Receiving Facility -->
<MSH.7>20000610010401</MSH.7>         <!--Date/Time of message -->
<MSH.9>                                <!--Message type -->
  <CM_MSG_TYPE.1>ACK</CM_MSG_TYPE.1>
</MSH.9>
<MSH.10>20000610010401CA</MSH.10>    <!--Message control ID -->
<MSH.11>
  <PT.1>P</PT.1>
</MSH.11>                              <!--Processing ID (Train/Debug/Prod)-->
<MSH.12>
  <VID.1>2.4</VID.1>
</MSH.12>                              <!--Version ID -->
<MSH.15>NE</MSH.15>                  <!--Accept Acknowledgement type -->
<MSH.16>NE</MSH.16>                  <!--Application Acknowledgement type -->
</MSH>

<MSA>                                <!-- Message Acknowledge Segment -->
  <MSA.1>CA</MSA.1>                  <!--Ack code (CA=commit accept) -->
  <MSA.2>20000610010400AA</MSA.2>    <!--Msg control ID (from MSH.10) -->
</MSA>

</ACK>

```

### 5.9.2 Sample #2, Unordered Test With Single-Valued Result

ORU^R30 - General Order Message from POCT1DMS-OBSREV to POCT1LIS-OBSRCPT LIS sent 6/10/00 1:03:55.

```

<!DOCTYPE ORU_R30 SYSTEM "hl7_v231.dtd">
<ORU_R30>
  <MSH>                                <!-- MESSAGE HEADER SEGMENT -->
    <MSH.1>|</MSH.1>                <!--Field separator -->
    <MSH.2>^~\&amp;</MSH.2>          <!--Encoding characters -->
    <MSH.3>
      <HD.1>POCT1DMS</HD.1>
    </MSH.3>                          <!--Sending Application -->
    <MSH.4>
      <HD.1>OBSREV</HD.1>
    </MSH.4>                          <!--Sending Facility -->
    <MSH.5>
      <HD.1>POCT1LIS</HD.1>
    </MSH.5>                          <!--Receiving Application -->
    <MSH.6>
      <HD.1>OBSRCPT</HD.1>
    </MSH.6>                          <!--Receiving Facility -->
    <MSH.7>20000610010355</MSH.7>    <!--Date/Time of message -->
    <MSH.9>                            <!--Message type -->

```

```

    <CM_MSG_TYPE.1>ORU</CM_MSG_TYPE.1>
    <CM_MSG_TYPE.2>R30</CM_MSG_TYPE.2>
  </MSH.9>
  <MSH.10>20000610010355:023</MSH.10>    <!--Message control ID -->
  <MSH.11>                                <!--Processing ID (T/D/P)-->
    <PT.1>P</PT.1>
  </MSH.11>                                <!--Processing ID (Train/Debug/Prod)-->
  <MSH.12>                                <!--Version ID-->
    <VID.1>2.4</VID.1>
  </MSH.12>
  <MSH.15>AL</MSH.15>                    <!--Accept Acknowledgement type, Always -->
  <MSH.16>AL</MSH.16>                    <!--Application Acknowledgement type, Always -->
</MSH>

<PID>                                     <!--PATIENT IDENTIFICATION SEGMENT -->
  <PID.3>                                  <!--Patient ID (internal) -->
    <CX.1>MR12345678</CX.1>
    <CX.4>Facility1</CX.4>
  </PID.3>
  <PID.18>                                  <!--Account Number, if required -->
    <CX.1>ActID135792468</CX.1>
    <CX.4>1</CX.4>
  </PID.18>
</PID>

<ORC>                                     <!-- COMMON ORDER SEGMENT -->
  <ORC.1>NW</ORC.1>                       <!--Order Control, Observations Follow -->
</ORC>

<OBR>                                     <!-- OBSERVATION REQUEST SEGMENT -->
  <OBR.4>                                   <!--Universal service ID -->
    <CE.1>L12345</CE.1>                   <!--LOINC Code -->
    <CE.2>GLU</CE.2>                     <!--Mnemonic Code -->
  </OBR.4>
  <OBR.11>O</OBR.11>                      <!--Specimen Type -->
  <OBR.16>                                  <!--Ordering Provider, if required -->
    <XCN.1>555</XCN.1>                   <!--Doctor's ID -->
    <XCN.2>Smith</XCN.2>                 <!--Doctor's Name -->
    <XCN.3>John</XCN.3>
    <XCN.4>J</XCN.4>
    <XCN.5>Dr</XCN.5>
  </OBR.16>
</OBR>

<OBX>                                     <!-- OBSERVATION RESULT SEGMENT -->
  <OBX.2>ST</OBX.2>                       <!--Value type (ST=string) -->
  <OBX.3>                                   <!--Observation ID -->
    <CE.1>L12345</CE.1>                   <!--LOINC Code -->
    <CE.2>GLU</CE.2>                     <!--Mnemonic Code -->
  </OBX.3>
  <OBX.5>120</OBX.5>                     <!--Observation value -->

```

```

<OBX.6>                                <!--Observation units -->
  <CE.1>mg/dl</CE.1>
</OBX.6>
<OBX.11>F</OBX.11>                     <!--Observation result status (F=final)-->
<OBX.16>                                <!--Responsible observer (user id) -->
  <XCN.1>User9876</XCN.1>
</OBX.16>
<OBX.18>20000609102135</OBX.18>       <!--Equipment instance identifier-->
<OBX.19>                                <!--Date/Time of the analysis-->
  <CE.1>77777</CE.1>
  <CE.2>LifeScan SureStep</CE.2>
</OBX.19>    </OBX>

<NTE>                                    <!--NOTES AND COMMENTS SEGMENT -->
  <NTE.3>Stat~Physician notified</NTE.3>  <!--Use "~" to separate comments -->
</NTE>
</ORU_R30>

```

POCT1LIS must reply immediately with either a Commit **ACK** specifying CA, CE, or CR. POCT1LIS generates its own Message Control ID and uses the Message Control ID field from the received message for MSA-2. This **ACK** message is identical to that in Sample #1.

Later, the LIS must send an **ACK** message as an Application Acknowledgement. This message is created similar to the Commit Acknowledgement except that the Message Type is **ACK^R33** rather than **ACK** and the acknowledgement code is AA, AE, or AR. This message will also return either the Accession Number/Order ID of the ordered test (for success) or an application level Error description (for failure).

For success:

```

<!DOCTYPE ACK_R33 SYSTEM "hl7_v231.dtd">
<ACK_R33>
  <MSH>                                    <!-- Message Header Segment -->
    <MSH.1>|</MSH.1>                       <!--Field separator -->
    <MSH.2>^~\&amp;</MSH.2>                 <!--Encoding characters -->
    <MSH.3>
      <HD.1>POCT1LIS</HD.1>
    </MSH.3>                                <!--Sending Application -->
    <MSH.4>
      <HD.1>OBSRCPT</HD.1>
    </MSH.4>                                <!--Sending Facility -->
    <MSH.5>
      <HD.1>POCT1DMS</HD.1>
    </MSH.5>                                <!--Receiving Application -->
    <MSH.6>
      <HD.1>OBSREV</HD.1>
    </MSH.6>                                <!--Receiving Facility -->
    <MSH.7>20000610010400</MSH.7>         <!--Date/Time of message -->
    <MSH.9>                                <!--Message type -->
      <CM_MSG_TYPE.1>ACK</CM_MSG_TYPE.1>
      <CM_MSG_TYPE.2>R33</CM_MSG_TYPE.2>
    </MSH.9>
    <MSH.10>20000610010400AAA</MSH.10>    <!--Message control ID -->
    <MSH.11>
      <PT.1>P</PT.1>

```



```

</MSH.11>                                <!--Processing ID (Train/Debug/Prod)-->
<MSH.12>
  <VID.1>2.4</VID.1>
</MSH.12>                                <!--Version ID -->
<MSH.15>AL</MSH.15>                       <!--Accept Acknowledgement type -->
<MSH.16>NE</MSH.16>                       <!--Application Acknowledgement type -->
</MSH>

<MSA>                                       <!-- Message Acknowledge Segment -->
  <MSA.1>AA</MSA.1>                         <!--Ack code (AA=application accept) -->
  <MSA.2>20000610010355:023</MSA.2>       <!--Msg control ID (from MSH.10) -->
  <MSA.3>OrdIDA24680</MSA.3>               <!--Accession Number/Order ID of Test -->
</MSA>
</ACK_R33>

```

Otherwise, for an error:

```

<!DOCTYPE ACK_R33 SYSTEM "hl7_v231.dtd">
<ACK_R33>
  <MSH>                                       <!--Message Header Segment -->
    <MSH.1>|</MSH.1>                         <!--Field separator -->
    <MSH.2>^~\&#38;</MSH.2>                 <!--Encoding characters -->
    <MSH.3>
      <HD.1>POCT1LIS</HD.1>
    </MSH.3>                                  <!--Sending Application -->
    <MSH.4>
      <HD.1>OBSRCPT</HD.1>
    </MSH.4>                                  <!--Sending Facility -->
    <MSH.5>
      <HD.1>POCT1DMS</HD.1>
    </MSH.5>                                  <!--Receiving Application -->
    <MSH.6>
      <HD.1>OBSREV</HD.1>
    </MSH.6>                                  <!--Receiving Facility -->
    <MSH.7>20000610010400</MSH.7>          <!--Date/Time of message -->
    <MSH.9>
      <CM_MSG_TYPE.1>ACK</CM_MSG_TYPE.1>
      <CM_MSG_TYPE.2>R33</CM_MSG_TYPE.2>
    </MSH.9>
    <MSH.10>20000610010400AAA</MSH.10>     <!--Message control ID -->
    <MSH.11>
      <PT.1>P</PT.1>
    </MSH.11>                                <!--Processing ID (Train/Debug/Prod)-->
    <MSH.12>
      <VID.1>2.4</VID.1>
    </MSH.12>                                <!--Version ID -->
    <MSH.15>AL</MSH.15>                       <!--Accept Acknowledgement type -->
    <MSH.16>NE</MSH.16>                       <!--Application Acknowledgement type -->
  </MSH>

  <MSA>                                       <!--Message Acknowledge Segment -->
    <MSA.1>AE</MSA.1>                         <!--Ack code (AE=application error) -->
    <MSA.2>20000610010355:023</MSA.2>       <!--Msg control ID (from MSH.10) -->
    <MSA.3>Invalid Patient</MSA.3>          <!--Text Error Message -->

```

```

    <MSA.6>                                     <!--Error Code, optional description -->
      <CE.1>3129</CE.1>
    </MSA.6>
  </MSA>
</ACK_R33>

```

In response, POCT1DMS-OBSREV will send a commit-level acknowledgement message (**ACK**) in response to the **ACK^R33** message. This **ACK** message is identical to that shown in Sample #1.

### 5.9.3 Sample #3, Unordered Test With Multivalued Result (ORU^R31)

**ORU^R31** - General Order Message from POCT1DMS-OBSREV to POCT1LIS-OBSRCPT LIS sent 6/10/00 1:03:55

```

<!DOCTYPE ORU_R31 SYSTEM "hl7_v231.dtd">
<ORU_R31>
  <MSH>                                     <!-- MESSAGE HEADER SEGMENT -->
    <MSH.1>|</MSH.1>                       <!--Field separator -->
    <MSH.2>^~\&amp;</MSH.2>                   <!--Encoding characters -->
    <MSH.3>
      <HD.1>POCT1DMS</HD.1>
    </MSH.3>                                 <!--Sending Application -->
    <MSH.4>
      <HD.1>OBSREV</HD.1>
    </MSH.4>                                 <!--Sending Facility -->
    <MSH.5>
      <HD.1>POCT1LIS</HD.1>
    </MSH.5>                                 <!--Receiving Application -->
    <MSH.6>
      <HD.1>OBSRCPT</HD.1>
    </MSH.6>                                 <!--Receiving Facility -->
    <MSH.7>20000610010355</MSH.7>          <!--Date/Time of message -->
    <MSH.9>
      <CM_MSG_TYPE.1>ORU</CM_MSG_TYPE.1>
      <CM_MSG_TYPE.2>R31</CM_MSG_TYPE.2>
    </MSH.9>
    <MSH.10>20000610010355:023</MSH.10>    <!--Message control ID -->
    <MSH.11>
      <PT.1>P</PT.1>
    </MSH.11>                                <!--Processing ID (T/D/P)-->
    <MSH.12>
      <VID.1>2.4</VID.1>
    </MSH.12>                                <!--Processing ID (Train/Debug/Prod)-->
    <MSH.15>AL</MSH.15>                     <!--Version ID-->
    <MSH.16>AL</MSH.16>                     <!--Accept Acknowledgement type, Always -->
    <MSH.16>AL</MSH.16>                     <!--Application Acknowledgement type, Always -->
  </MSH>

  <PID>                                     <!--PATIENT IDENTIFICATION SEGMENT -->
    <PID.3>
      <CX.1>MR12345678</CX.1>
      <CX.4>Facility1</CX.4>
    </PID.3>
    <PID.18>
      <CX.1>ActID135792468</CX.1>
    </PID.18>                                <!--Patient ID (internal) -->
    <CX.1>ActID135792468</CX.1>           <!--Account Number, if required -->

```

```

    <CX.4>1</CX.4>
  </PID.18>
</PID>

<ORC>                                <!-- COMMON ORDER SEGMENT -->
  <ORC.1>NW</ORC.1>                  <!--Order Control, Observations Follow -->
</ORC>

<OBR>                                <!-- OBSERVATION REQUEST SEGMENT -->
  <OBR.4>                              <!--Universal service ID -->
    <CE.1>Urine Panel 2</CE.1>        <!--Local Panel Identifier -->
  </OBR.4>
  <OBR.11>0</OBR.11>                  <!--Specimen Type -->
  <OBR.16>                              <!--Ordering Provider, if required -->
    <XCN.1>555</XCN.1>                <!--Doctor's ID -->
    <XCN.2>Smith</XCN.2>              <!--Doctor's Name -->
    <XCN.3>John</XCN.3>
    <XCN.4>J</XCN.4>
    <XCN.5>Dr</XCN.5>
  </OBR.16>
</OBR>

<OBX>                                <!-- OBSERVATION RESULT SEGMENT (pH)-->
  <OBX.2>ST</OBX.2>                  <!--Value type (ST=string) -->
  <OBX.3>                              <!--Observation ID -->
    <CE.1>L5678</CE.1>                <!--LOINC Code -->
    <CE.2>pH</CE.2>                    <!--Mnemonic Code -->
  </OBX.3>
  <OBX.5>5.2</OBX.5>                  <!--Observation value (no units)-->
  <OBX.11>F</OBX.11>                  <!--Observation result status (F=final)-->
  <OBX.16>                              <!--Responsible observer (user id) -->
    <XCN.1>User9876</XCN.1>
  </OBX.16>
  <OBX.18>20000609102135</OBX.18>    <!--Equipment instance identifier-->
  <OBX.19>                              <!--Date/Time of the analysis-->
    <CE.1>888888</CE.1>
    <CE.2>CliniTek 50</CE.2>
  </OBX.19>
</OBX>

<OBX>                                <!-- OBSERVATION RESULT SEGMENT (Ketones) -->
  <OBX.2>ST</OBX.2>                  <!--Value type (ST=string) -->
  <OBX.3>                              <!--Observation ID -->
    <CE.1>L2412</CE.1>                <!--LOINC Code -->
    <CE.2>Ketones</CE.2>              <!--Mnemonic Code -->
  </OBX.3>
  <OBX.8>N</OBX.8>                    <!--Normal Result (flags vs. value) -->
  <OBX.11>F</OBX.11>                  <!--Observation result status (F=final)-->
  <OBX.16>                              <!--Responsible observer (user id) -->
    <XCN.1>User9876</XCN.1>
  </OBX.16>

```

```

<OBX.18>20000609102135</OBX.18>      <!--Equipment instance identifier-->
<OBX.19>                                <!--Date/Time of the analysis-->
  <CE.1>888888</CE.1>
  <CE.2>CliniTek 50</CE.2>
</OBX.19>
</OBX>
</ORU_R31>

```

The POCT1LIS **ACK^R33** messages, as well as POCT1DMS-OBSREV **ACK** message, are identical to those shown in Sample #2.

The POCT1LIS must accept the entire order and result combination or must fail the combination without placing any order.

#### 5.9.4 Sample #4, Unordered Test With Multivalued Result (ORU^R30)

**ORU^R30** - General Order Message from POCT1DMS-OBSREV to POCT1LIS-OBSRCPT LIS sent 6/10/00 1:03:55

```

<!DOCTYPE ORU_R30 SYSTEM "hl7_v231.dtd">
<ORU_R30>
  <MSH>                                <!-- MESSAGE HEADER SEGMENT -->
    <MSH.1>|</MSH.1>                  <!--Field separator -->
    <MSH.2>^~\&amp;</MSH.2>             <!--Encoding characters -->
    <MSH.3>
      <HD.1>POCT1DMS</HD.1>
    </MSH.3>                            <!--Sending Application -->
    <MSH.4>
      <HD.1>OBSREV</HD.1>
    </MSH.4>                            <!--Sending Facility -->
    <MSH.5>
      <HD.1>POCT1LIS</HD.1>
    </MSH.5>                            <!--Receiving Application -->
    <MSH.6>
      <HD.1>OBSRCPT</HD.1>
    </MSH.6>                            <!--Receiving Facility -->
    <MSH.7>20000610010355</MSH.7>     <!--Date/Time of message -->
    <MSH.9>                             <!--Message type -->
      <CM_MSG_TYPE.1>ORU</CM_MSG_TYPE.1>
      <CM_MSG_TYPE.2>R30</CM_MSG_TYPE.2>
    </MSH.9>
    <MSH.10>20000610010355:023</MSH.10> <!--Message control ID -->
    <MSH.11>                             <!--Processing ID (T/D/P)-->
      <PT.1>P</PT.1>
    </MSH.11>                           <!--Processing ID (Train/Debug/Prod)-->
    <MSH.12>                             <!--Version ID-->
      <VID.1>2.4</VID.1>
    </MSH.12>
    <MSH.15>AL</MSH.15>                 <!--Accept Acknowledgement type, Always -->
    <MSH.16>AL</MSH.16>                 <!--Application Acknowledgement type, Always -->
  </MSH>
  <PID>                                <!--PATIENT IDENTIFICATION SEGMENT -->

```

```

<PID.1>1</PID.1>          <!--SET ID sequence number of segment -->
<PID.3>                    <!--Patient ID (internal) -->
    <CX.1>MR12345678</CX.1>
    <CX.4>Facility1</CX.4>
</PID.3>
<PID.5>                    <!--Patient lastname, firstname -->
    <XPN.1>Patient</XPN.1>
    <XPN.2>Pat</XPN.2>
</PID.5>
<PID.8>M</PID.8>          <!--Sex ('M'ale,'F'emale,'U'known) -->
<PID.18>                   <!--Account Number, if required -->
    <CX.1>ActID135792468</CX.1>
    <CX.4>1</CX.4>
</PID.18>
</PID>

<ORC>                      <!-- COMMON ORDER SEGMENT -->
    <ORC.1>NW</ORC.1>      <!--Order Control, Observations Follow -->
</ORC>

<OBR>                      <!-- OBSERVATION REQUEST SEGMENT -->
    <OBR.1>1</OBR.1>      <!--SET ID sequence number of segment -->
    <OBR.4>                <!--Universal service ID -->
        <CE.1>BG-OXI-ELECT</CE.1> <!--Local Panel Identifier -->
    </OBR.4>
    <OBR.11>0</OBR.11>    <!--Specimen Action Code-->
    <OBR.15>               <!--Specimen Source -->
        <CM.1>BLDA</CM.1>        <!--Blood Arterial -->
        <CM.4>LLFA</CM.4>        <!--Lower left forearm -->
    </OBR.15>
    <OBR.16>               <!--Ordering Provider, if required -->
        <XCN.1>5555</XCN.1>      <!--Doctor's ID -->
        <XCN.2>Smith</XCN.2>     <!--Doctor's Name -->
        <XCN.3>John</XCN.3>
        <XCN.4>J</XCN.4>
        <XCN.5>Dr</XCN.5>
    </OBR.16>
    <OBR.18>               <!--Local sample # (assigned by DMS or POC Device-->
        <EI.1>8024</EI.1>
        <EI.2>Sample #</EI.2>
    </OBR.18>
</OBR>

<NTE>                      <!-- NOTES AND COMMENTS SEGMENT dealing with battery of results-->
    <NTE.1>1</NTE.1>      <!--SET ID sequence number of segment -->
<NTE.3>Battery approved by JAG-Dr. G. John notified of result</NTE.3>
        <!--comment (who approved result + extra comments) -->
</NTE>

<OBX>                      <!-- OBSERVATION RESULT SEGMENT (p02)-->
    <OBX.1>1</OBX.1>      <!--SET ID sequence number of segment -->

```

```

<OBX.2>ST</OBX.2>                                <!--Value type (ST=string) -->
<OBX.3>                                           <!--Observation ID -->
  <CE.1>2703-1</CE.1>                             <!--LOINC Code -->
  <CE.3>LN</CE.3>                                 <!--Identity of Coding system = LOINC -->
  <CE.4>
    <CE.4.1>pO2</CE.4.1>                           <!--Alternate service ID (mnemonic) -->
    <CE.4.2>M</CE.4.2>                             <!--Alternate service ID (type = measured) -->
  </CE.4>
</OBX.3>
<OBX.5>110</OBX.5>                                <!--Observation value-->
<OBX.6>mmHg</OBX.6>                              <!--Observation units-->
<OBX.8>H</OBX.8>                                  <!--Abnormal Flag ('H'igh)-->
<OBX.11>F</OBX.11>                               <!--Observation result status (F=final)-->
<OBX.16>                                           <!--Responsible observer (user id) (INCLUDED ONLY IN 1ST OBX)-->
  <XCN.1>User9876</XCN.1>
</OBX.16>
<OBX.18>20000609102135</OBX.18>                 <!--Equipment instance identifier-->
<OBX.19>                                           <!--Date/Time of the analysis-->
  <CE.1>222</CE.1>
  <CE.2>12-34-56-78-90-AB-CD-EF</CE.2>
</OBX.19>
</OBX>

<NTE>                                           <!--NOTES AND COMMENTS SEGMENT-->
  <NTE.1>1</NTE.1>                                <!--SET ID sequence number of segment -->
  <NTE.3>Stat-Measured value above reference range but within the critical limits</NTE.3>
  <!--comment (application error code) -->
</NTE>

<OBX>                                           <!-- OBSERVATION RESULT SEGMENT (pCO2)-->
  <OBX.1>2</OBX.1>                                <!--SET ID sequence number of segment -->
  <OBX.2>ST</OBX.2>                                <!--Value type (ST=string) -->
  <OBX.3>                                           <!--Observation ID -->
    <CE.1>11557-6</CE.1>                           <!--LOINC Code -->
    <CE.3>LN</CE.3>                                 <!--Identity of Coding system = LOINC -->
    <CE.4>
      <CE.4.1>pCO2</CE.4.1>                           <!--Alternate service ID (mnemonic) -->
      <CE.4.2>M</CE.4.2>                             <!--Alternate service ID (type = measured) -->
    </CE.4>
  </OBX.3>
  <OBX.5>33.2</OBX.5>                              <!--Observation value-->
  <OBX.6>mmHg</OBX.6>                              <!--Observation units-->
  <OBX.8>L</OBX.8>                                  <!--Abnormal Flag ('L'ow)-->
  <OBX.11>F</OBX.11>                              <!--Observation result status (F=final)-->
</OBX>

<NTE>                                           <!--NOTES AND COMMENTS SEGMENT-->
  <NTE.1>1</NTE.1>                                <!--SET ID sequence number of segment -->
  <NTE.3>Stat-Measured value below reference range but within the critical limits</NTE.3>
  <!--comment (application error code) -->
</NTE>

```

```

<OBX>                                <!-- OBSERVATION RESULT SEGMENT (pH)-->
  <OBX.1>3</OBX.1>                    <!--SET ID sequence number of segment -->
  <OBX.2>ST</OBX.2>                    <!--Value type (ST=string) -->
  <OBX.3>                                <!--Observation ID -->
    <CE.1>11558-4</CE.1>              <!--LOINC Code -->
    <CE.2>pH</CE.2>
    <CE.3>LN</CE.3>                    <!--Identity of Coding system = LOINC -->
    <CE.4>
      <CE.4.1>pH</CE.4.1>              <!--Alternate service ID (mnemonic) -->
      <CE.4.2>M</CE.4.2>              <!--Alternate service ID (type = measured) -->
    </CE.4>
  </OBX.3>
  <OBX.5>7.474</OBX.5>                <!--Observation value-->
  <OBX.8>H</OBX.8>                    <!--Abnormal Flag ('H'igh)-->
  <OBX.11>F</OBX.11>                 <!--Observation result status (F=final)-->
</OBX>

<NTE>                                <!--NOTES AND COMMENTS SEGMENT-->
  <NTE.1>1</NTE.1>                    <!--SET ID sequence number of segment -->
  <NTE.3>Stat-Measured value above reference range but within the critical limits</NTE.3>
                                     <!--comment (application error code) -->
</NTE>

<OBX>                                <!-- OBSERVATION RESULT SEGMENT (K+)-->
  <OBX.1>4</OBX.1>                    <!--SET ID sequence number of segment -->
  <OBX.2>ST</OBX.2>                    <!--Value type (ST=string) -->
  <OBX.3>                                <!--Observation ID -->
    <CE.1>6298-4</CE.1>              <!--LOINC Code -->
    <CE.2>POTASSIUM</CE.2>
    <CE.3>LN</CE.3>                    <!--Identity of Coding system = LOINC -->
    <CE.4>
      <CE.4.1>K+</CE.4.1>              <!--Alternate service ID (mnemonic) -->
      <CE.4.2>M</CE.4.2>              <!--Alternate service ID (type = measured) -->
    </CE.4>
  </OBX.3>
  <OBX.5>3.7</OBX.5>                  <!--Observation value-->
  <OBX.6>mmol/L</OBX.6>               <!--Observation units-->
  <OBX.8>N</OBX.8>                    <!--Abnormal Flag ('N'ormal)-->
  <OBX.11>F</OBX.11>                 <!--Observation result status (F=final)-->
</OBX>

<OBX>                                <!-- OBSERVATION RESULT SEGMENT (tHb)-->
  <OBX.1>5</OBX.1>                    <!--SET ID sequence number of segment -->
  <OBX.2>ST</OBX.2>                    <!--Value type (ST=string) -->
  <OBX.3>                                <!--Observation ID -->
    <CE.1>14775-1</CE.1>              <!--LOINC Code -->
    <CE.2>HEMOGLOBIN</CE.2>
    <CE.3>LN</CE.3>                    <!--Identity of Coding system = LOINC -->
    <CE.4>
      <CE.4.1>tHb</CE.4.1>            <!--Alternate service ID (mnemonic) -->
    </CE.4>
  </OBX.3>

```

```

    <CE.4.2>M</CE.4.2>                                <!--Alternate service ID (type = measured) -->
  </CE.4>
</OBX.3>
<OBX.5>11.6</OBX.5>                                  <!--Observation value-->
<OBX.6>g/dL</OBX.6>                                  <!--Observation units-->
<OBX.8>N</OBX.8>                                     <!--Abnormal Flag ('N'ormal)-->
<OBX.11>F</OBX.11>                                  <!--Observation result status (F=final)-->
</OBX>

<OBX>                                                  <!-- OBSERVATION RESULT SEGMENT (RHb)-->
  <OBX.1>6</OBX.1>                                    <!--SET ID sequence number of segment -->
  <OBX.2>ST</OBX.2>                                   <!--Value type (ST=string) -->
  <OBX.3>                                              <!--Observation ID -->
    <CE.1>4536-9</CE.1>                               <!--LOINC Code -->
    <CE.2>DEOXYHEMOGLOBIN/HEMOGLOBIN.TOTAL</CE.2>
    <CE.3>LN</CE.3>                                   <!--Identity of Coding system = LOINC -->
    <CE.4>
      <CE.4.1>RHb</CE.4.1>                             <!--Alternate service ID (mnemonic) -->
      <CE.4.2>M</CE.4.2>                             <!--Alternate service ID (type = measured) -->
    </CE.4>
  </OBX.3>
  <OBX.5>1.3</OBX.5>                                  <!--Observation value-->
  <OBX.6>%</OBX.6>                                    <!--Observation units-->
  <OBX.8>N</OBX.8>                                   <!--Abnormal Flag ('N'ormal)-->
  <OBX.11>F</OBX.11>                                  <!--Observation result status (F=final)-->
</OBX>

<OBX>                                                  <!-- OBSERVATION RESULT SEGMENT (O2Hb)-->
  <OBX.1>7</OBX.1>                                    <!--SET ID sequence number of segment -->
  <OBX.2>ST</OBX.2>                                   <!--Value type (ST=string) -->
  <OBX.3>                                              <!--Observation ID -->
    <CE.4>
      <CE.4.1>O2Hb</CE.4.1>                             <!--Alternate service ID (mnemonic) -->
      <CE.4.2>M</CE.4.2>                             <!--Alternate service ID (type = measured) -->
    </CE.4>
  </OBX.3>
  <OBX.5>96.9</OBX.5>                                  <!--Observation value-->
  <OBX.6>%</OBX.6>                                    <!--Observation units-->
  <OBX.8>N</OBX.8>                                   <!--Abnormal Flag ('N'ormal)-->
  <OBX.11>F</OBX.11>                                  <!--Observation result status (F=final)-->
</OBX>

<OBX>                                                  <!-- OBSERVATION RESULT SEGMENT (COHb)-->
  <OBX.1>8</OBX.1>                                    <!--SET ID sequence number of segment -->
  <OBX.2>ST</OBX.2>                                   <!--Value type (ST=string) -->
  <OBX.3>                                              <!--Observation ID -->
    <CE.1>20563-3</CE.1>                               <!--LOINC Code -->
    <CE.2>CARBON MONOXIDE.HEMOGLOBIN</CE.2>
    <CE.3>LN</CE.3>                                   <!--Identity of Coding system = LOINC -->
    <CE.4>
      <CE.4.1>COHb</CE.4.1>                             <!--Alternate service ID (mnemonic) -->

```



```

    <CE.4.2>M</CE.4.2>                                <!--Alternate service ID (type = measured) -->
  </CE.4>
</OBX.3>
<OBX.5>1.2</OBX.5>                                    <!--Observation value-->
<OBX.6>%</OBX.6>                                      <!--Observation units-->
<OBX.8>N</OBX.8>                                      <!--Abnormal Flag ('N'ormal)-->
<OBX.11>F</OBX.11>                                   <!--Observation result status (F=final)-->
</OBX>

<OBX>                                                  <!-- OBSERVATION RESULT SEGMENT (MetHb)-->
  <OBX.1>9</OBX.1>                                    <!--SET ID sequence number of segment -->
  <OBX.2>ST</OBX.2>                                    <!--Value type (ST=string) -->
  <OBX.3>                                              <!--Observation ID -->
    <CE.1>2614-6</CE.1>                                <!--LOINC Code -->
    <CE.2>METHEMOGLOBIN/HEMOGLOBIN.TOTAL</CE.2>
    <CE.3>LN</CE.3>                                    <!--Identity of Coding system = LOINC -->
    <CE.4>
      <CE.4.1>MetHb</CE.4.1>                            <!--Alternate service ID (mnemonic) -->
      <CE.4.2>M</CE.4.2>                                <!--Alternate service ID (type = measured) -->
    </CE.4>
  </OBX.3>
  <OBX.5>0.6</OBX.5>                                    <!--Observation value-->
  <OBX.6>%</OBX.6>                                      <!--Observation units-->
  <OBX.8>N</OBX.8>                                      <!--Abnormal Flag ('N'ormal)-->
  <OBX.11>F</OBX.11>                                   <!--Observation result status (F=final)-->
</OBX>

<OBX>                                                  <!-- OBSERVATION RESULT SEGMENT (Temp)-->
  <OBX.1>10</OBX.1>                                    <!--SET ID sequence number of segment -->
  <OBX.2>ST</OBX.2>                                    <!--Value type (ST=string) -->
  <OBX.3>                                              <!--Observation ID -->
    <CE.1>20092-3</CE.1>                                <!--LOINC Code -->
    <CE.2>BODY TEMPERATURE</CE.2>
    <CE.3>LN</CE.3>                                    <!--Identity of Coding system = LOINC -->
    <CE.4>
      <CE.4.1>T</CE.4.1>                                <!--Alternate service ID (mnemonic) -->
      <CE.4.2>I</CE.4.2>                                <!--Alternate service ID (type = input) -->
    </CE.4>
  </OBX.3>
  <OBX.5>35.3</OBX.5>                                    <!--Observation value-->
  <OBX.6>Cel</OBX.6>                                    <!--Observation units-->
  <OBX.11>F</OBX.11>                                   <!--Observation result status (F=final)-->
</OBX>

<OBX>                                                  <!-- OBSERVATION RESULT SEGMENT (FIO2)-->
  <OBX.1>11</OBX.1>                                    <!--SET ID sequence number of segment -->
  <OBX.2>ST</OBX.2>                                    <!--Value type (ST=string) -->
  <OBX.3>                                              <!--Observation ID -->
    <CE.1>19994-3</CE.1>                                <!--LOINC Code -->
    <CE.3>LN</CE.3>                                    <!--Identity of Coding system = LOINC -->
    <CE.4>

```

```

    <CE.4.1>FIO2</CE.4.1>          <!--Alternate service ID (mnemonic) -->
    <CE.4.2>I</CE.4.2>             <!--Alternate service ID (type = input) -->
  </CE.4>
</OBX.3>
<OBX.5>30.0</OBX.5>              <!--Observation value-->
<OBX.6>%</OBX.6>                 <!--Observation units-->
<OBX.11>F</OBX.11>              <!--Observation result status (F=final)-->
</OBX>

<OBX>                              <!-- OBSERVATION RESULT SEGMENT (pH(T))-->
  <OBX.1>12</OBX.1>              <!--SET ID sequence number of segment -->
  <OBX.2>ST</OBX.2>              <!--Value type (ST=string) -->
  <OBX.3>                          <!--Observation ID -->
    <CE.4>
      <CE.4.1>pH(T)</CE.4.1>      <!--Alternate service ID (mnemonic) -->
      <CE.4.2>C</CE.4.2>         <!--Alternate service ID (type = calculated) -->
    </CE.4>
  </OBX.3>
  <OBX.5>7.500</OBX.5>          <!--Observation value-->
  <OBX.11>F</OBX.11>           <!--Observation result status (F=final)-->
</OBX>

<OBX>                              <!-- OBSERVATION RESULT SEGMENT (pCO2(T))-->
  <OBX.1>13</OBX.1>              <!--SET ID sequence number of segment -->
  <OBX.2>ST</OBX.2>              <!--Value type (ST=string) -->
  <OBX.3>                          <!--Observation ID -->
    <CE.4>
      <CE.4.1>pCO2(T)</CE.4.1>    <!--Alternate service ID (mnemonic) -->
      <CE.4.2>C</CE.4.2>         <!--Alternate service ID (type = calculated) -->
    </CE.4>
  </OBX.3>
  <OBX.5>30.5</OBX.5>          <!--Observation value-->
  <OBX.6>mmHg</OBX.6>          <!--Observation units-->
  <OBX.11>F</OBX.11>           <!--Observation result status (F=final)-->
</OBX>

<OBX>                              <!-- OBSERVATION RESULT SEGMENT (SBE)-->
  <OBX.1>14</OBX.1>              <!--SET ID sequence number of segment -->
  <OBX.2>ST</OBX.2>              <!--Value type (ST=string) -->
  <OBX.3>                          <!--Observation ID -->
    <CE.1>19235-1</CE.1>         <!--LOINC Code -->
    <CE.3>LN</CE.3>              <!--Identity of Coding system = LOINC -->
    <CE.4>
      <CE.4.1>SBE</CE.4.1>       <!--Alternate service ID (mnemonic) -->
      <CE.4.2>C</CE.4.2>         <!--Alternate service ID (type = calculated) -->
    </CE.4>
  </OBX.3>
  <OBX.5>0.8</OBX.5>           <!--Observation value-->
  <OBX.6>mmol/L</OBX.6>        <!--Observation units-->
  <OBX.11>F</OBX.11>           <!--Observation result status (F=final)-->
</OBX>

```

```

<OBX>
  <OBX.1>15</OBX.1>
  <OBX.2>ST</OBX.2>
  <OBX.3>
    <CE.1>19230-2</CE.1>
    <CE.3>LN</CE.3>
    <CE.4>
      <CE.4.1>SBC</CE.4.1>
      <CE.4.2>C</CE.4.2>
    </CE.4>
  </OBX.3>
  <OBX.5>25.6</OBX.5>
  <OBX.6>mmol/L</OBX.6>
  <OBX.11>F</OBX.11>
</OBX>

<OBX>
  <OBX.1>16</OBX.1>
  <OBX.2>ST</OBX.2>
  <OBX.3>
    <CE.1>20570-8</CE.1>
    <CE.3>LN</CE.3>
    <CE.4>
      <CE.4.1>Hct</CE.4.1>
      <CE.4.2>C</CE.4.2>
    </CE.4>
  </OBX.3>
  <OBX.5>35.7</OBX.5>
  <OBX.6>%</OBX.6>
  <OBX.11>F</OBX.11>
</OBX>

<OBX>
  <OBX.1>17</OBX.1>
  <OBX.2>ST</OBX.2>
  <OBX.3>
    <CE.1>19254-2</CE.1>
    <CE.3>LN</CE.3>
    <CE.4>
      <CE.4.1>pO2(T)</CE.4.1>
      <CE.4.2>C</CE.4.2>
    </CE.4>
  </OBX.3>
  <OBX.5>101</OBX.5>
  <OBX.6>mmHg</OBX.6>
  <OBX.11>F</OBX.11>
</OBX>

<OBX>
  <OBX.1>18</OBX.1>
  <OBX.2>ST</OBX.2>
  <OBX.3>
    <OBX.3.1>19230-2</OBX.3.1>
    <OBX.3.2>LN</OBX.3.2>
    <OBX.3.4>
      <OBX.3.4.1>SBC</OBX.3.4.1>
      <OBX.3.4.2>C</OBX.3.4.2>
    </OBX.3.4>
  </OBX.3>
  <OBX.5>25.6</OBX.5>
  <OBX.6>mmol/L</OBX.6>
  <OBX.11>F</OBX.11>
</OBX>

<!-- OBSERVATION RESULT SEGMENT (SBC)-->
<!--SET ID sequence number of segment -->
<!--Value type (ST=string) -->
<!--Observation ID -->
<!--LOINC Code -->
<!--Identity of Coding system = LOINC -->
<!--Alternate service ID (mnemonic) -->
<!--Alternate service ID (type = calculated) -->
<!--Observation value-->
<!--Observation units-->
<!--Observation result status (F=final)-->

<!-- OBSERVATION RESULT SEGMENT (Hct)-->
<!--SET ID sequence number of segment -->
<!--Value type (ST=string) -->
<!--Observation ID -->
<!--LOINC Code -->
<!--Identity of Coding system = LOINC -->
<!--Alternate service ID (mnemonic) -->
<!--Alternate service ID (type = calculated) -->
<!--Observation value-->
<!--Observation units-->
<!--Observation result status (F=final)-->

<!-- OBSERVATION RESULT SEGMENT (pO2(T))-->
<!--SET ID sequence number of segment -->
<!--Value type (ST=string) -->
<!--Observation ID -->
<!--LOINC Code -->
<!--Identity of Coding system = LOINC -->
<!--Alternate service ID (mnemonic) -->
<!--Alternate service ID (type = calculated) -->
<!--Observation value-->
<!--Observation units-->
<!--Observation result status (F=final)-->

<!-- OBSERVATION RESULT SEGMENT (p50(act))-->
<!--SET ID sequence number of segment -->
<!--Value type (ST=string) -->

```

```

<OBX.3>                                <!--Observation ID -->
  <CE.1>19214-6</CE.1>                 <!--LOINC Code -->
  <CE.3>LN</CE.3>                       <!--Identity of Coding system = LOINC -->
  <CE.4>
    <CE.4.1>p50(act)</CE.4.1>           <!--Alternate service ID (mnemonic) -->
    <CE.4.2>E</CE.4.2>                 <!--Alternate service ID (type = estimated) -->
  </CE.4>
</OBX.3>
<OBX.5>24.15</OBX.5>                   <!--Observation value-->
<OBX.6>mmHg</OBX.6>                   <!--Observation units-->
<OBX.11>F</OBX.11>                     <!--Observation result status (F=final)-->
</OBX>
<OBX>                                    <!-- OBSERVATION RESULT SEGMENT (AaDpO2)-->
  <OBX.1>19</OBX.1>                     <!--SET ID sequence number of segment -->
  <OBX.2>ST</OBX.2>                     <!--Value type (ST=string) -->
  <OBX.3>                                <!--Observation ID -->
    <CE.4>
      <CE.4.1>AaDpO2</CE.4.1>           <!--Alternate service ID (mnemonic) -->
      <CE.4.2>E</CE.4.2>                 <!--Alternate service ID (type = estimated) -->
    </CE.4>
  </OBX.3>
  <OBX.5>59.1</OBX.5>                   <!--Observation value-->
  <OBX.6>mmHg</OBX.6>                   <!--Observation units-->
  <OBX.11>F</OBX.11>                     <!--Observation result status (F=final)-->
</OBX>
<OBX>                                    <!-- OBSERVATION RESULT SEGMENT (AaDpO2,T)-->
  <OBX.1>20</OBX.1>                     <!--SET ID sequence number of segment -->
  <OBX.2>ST</OBX.2>                     <!--Value type (ST=string) -->
  <OBX.3>                                <!--Observation ID -->
    <CE.4>
      <CE.4.1>AaDpO2,T</CE.4.1>         <!--Alternate service ID (mnemonic) -->
      <CE.4.2>E</CE.4.2>                 <!--Alternate service ID (type = estimated) -->
    </CE.4>
  </OBX.3>
  <OBX.5>72.0</OBX.5>                   <!--Observation value-->
  <OBX.6>mmHg</OBX.6>                   <!--Observation units-->
  <OBX.11>F</OBX.11>                     <!--Observation result status (F=final)-->
</OBX>
<OBX>                                    <!-- OBSERVATION RESULT SEGMENT (tO2)-->
  <OBX.1>21</OBX.1>                     <!--SET ID sequence number of segment -->
  <OBX.2>ST</OBX.2>                     <!--Value type (ST=string) -->
  <OBX.3>                                <!--Observation ID -->
    <CE.4>
      <CE.4.1>tO2</CE.4.1>               <!--Alternate service ID (mnemonic) -->
      <CE.4.2>C</CE.4.2>                 <!--Alternate service ID (type = calculated) -->
    </CE.4>
  </OBX.3>
  <OBX.5>15.9</OBX.5>                   <!--Observation value-->
  <OBX.6>Vol%</OBX.6>                   <!--Observation units-->
  <OBX.11>F</OBX.11>                     <!--Observation result status (F=final)-->
</OBX>

```

```

<OBX>                                <!-- OBSERVATION RESULT SEGMENT (RI)-->
  <OBX.1>22</OBX.1>                  <!--SET ID sequence number of segment -->
  <OBX.2>ST</OBX.2>                   <!--Value type (ST=string) -->
  <OBX.3>                              <!--Observation ID -->
    <CE.4>
      <CE.4.1>RI</CE.4.1>             <!--Alternate service ID (mnemonic) -->
      <CE.4.2>E</CE.4.2>             <!--Alternate service ID (type = estimated) -->
    </CE.4>
  </OBX.3>
  <OBX.5>54</OBX.5>                   <!--Observation value-->
  <OBX.6>%</OBX.6>                   <!--Observation units-->
  <OBX.11>F</OBX.11>                 <!--Observation result status (F=final)-->
</OBX>
</ORU_R30>

```

The POCT1LIS **ACK^R33** messages, as well as the POCT1DMS-OBSREV **ACK** message, are identical to those shown in Sample #2.

The POCT1LIS must accept the entire order and result combination or must fail the combination without placing any order.

---

END OF THE OBSERVATION REPORTING INTERFACE SPECIFICATION

**This page is intentionally left blank.**

---

## APPENDIX D. POINT-OF-CARE REQUIREMENTS

Teresa Prego, CIC Requirements Team Chair

CIC Provider Review Committee

James Nichols, Chair

Jim Fisher, William Ganschow, Dr. Lutz Heinemann, Doug Hirst, Ellis Jacobs, Jay Jones,  
Brent Lowensohn, Debra Russel, Paula Santrach

---

A standard for global application developed through the CLSI consensus process.



(Formerly NCCLS)







**Contents**

|        |  |     |
|--------|--|-----|
| 1      | Requirements .....                                   | 257 |
| 1.1    | General Principles.....                              | 257 |
| 1.1.1  | Use Existing Infrastructure .....                    | 257 |
| 1.1.2  | Security .....                                       | 258 |
| 1.1.3  | International Needs .....                            | 259 |
| 1.1.4  | Individualized Data Access .....                     | 260 |
| 1.2    | Must Haves.....                                      | 261 |
| 1.2.1  | Bidirectional Connectivity .....                     | 261 |
| 1.2.2  | Standardized Device Connections, Plug and Play ..... | 261 |
| 1.2.3  | Use Existing Infrastructure .....                    | 262 |
| 1.2.4  | Conservation of IP Addresses.....                    | 262 |
| 1.2.5  | Ability to Meet Regulatory Guidelines.....           | 262 |
| 1.2.6  | Compatibility With LIS Order Generation .....        | 263 |
| 1.2.7  | Interoperability With Commercial Software .....      | 263 |
| 1.2.8  | Security .....                                       | 263 |
| 1.2.9  | Connectivity Doesn't Impede a Timely Result.....     | 264 |
| 1.2.10 | Easy to Use .....                                    | 264 |
| 1.3    | Other Objectives .....                               | 265 |
| 1.3.1  | Seamless Download.....                               | 265 |
| 1.3.2  | Configurable User Model .....                        | 265 |
| 1.3.3  | Instrument Dock LIS Integration .....                | 266 |
| 1.3.4  | Ability to Force a Download .....                    | 266 |
| 1.3.5  | Ability to Qualify Results .....                     | 267 |
| 1.4    | Future Requirements.....                             | 267 |
| 1.4.1  | RF Wireless Issues.....                              | 268 |
| 1.4.2  | Other Issues .....                                   | 268 |



## 1 Requirements

Widespread concern among healthcare providers about the lack of standard, low-cost point-of-care connectivity solutions drove the formation of the CIC. The first clear expression of this concern came from a 1998 survey conducted by the American Association of Clinical Chemistry (AACC) Point-of-Care Testing Division. In this survey, point-of-care customers highlighted the lack of acceptable connectivity and information management solutions as the most significant problem with point-of-care product offerings.

In July 1999, at a day-long focus group hosted by Agilent Technologies, clinicians and clinical laboratorians from leading healthcare institutions developed and prioritized a list of connectivity requirements. Over the lifetime of the Consortium, the Provider Review Committee (PRC) has refined and elaborated on these requirements in order to help guide the technical development efforts.

The end result of this process is that the objectives and design of the CIC Specification have been driven by requirements provided by leading users of point-of-care products. The following sections describe each user requirement and discuss how it has shaped the CIC Specification.

The requirements are grouped into the following general categories:

- **General Principles** – Overarching principles that should guide all aspects of the CIC Specification (four principles).
- **Must Haves** – Specific requirements that products based on the CIC Specification must be able to support (ten requirements).
- **Other Objectives** – Additional important issues that products based on the CIC Specification should be able to support (five objectives).
- **Future Requirements** – Requirements that will be essential attributes of point-of-care information management systems in the near future (seven requirements).

### 1.1 General Principles

#### 1.1.1 Use Existing Infrastructure

##### 1.1.1.1 Point-of-Care User's Issue

*The connectivity standards should utilize the existing communication infrastructure, e.g., phone, Internet, etc. Requiring major rewiring and renovations to install the connectivity standard at a user site will deter widespread acceptance of the standard.*

##### 1.1.1.2 CIC Approach

Both interface specifications formally address this requirement.

The 'Device and Access Point Interface' proposal specifies a low-cost Access Point infrastructure that can support CIC POC and ISO/IEEE 11073 Devices, and can be extended to support hand-held PDAs such as the Palm™ and Pocket PC™ as well. Since this infrastructure can be shared by all Devices, the connectivity costs for each Device are reduced. *Networked* Access Points are specified to use the existing TCP/IP LAN infrastructure already available at most user sites.

The Observation Reporting Interface requires only a network connection between the Observation Recipient and the Observation Reviewer. Any standard, existing network protocol (e.g., TCP/IP) will suffice. Since the participants in this interface are commonly network-connected, the CIC Specification introduces no additional infrastructure requirements. Also, since the interface is built on industry-standard HL7 messaging, it introduces no new protocols or interface technologies.

## 1.1.2 Security

### 1.1.2.1 Point-of-Care User's Issue

*Maintaining the security of data and access is essential. POCT data contains confidential patient information. Encryption should be further considered, particularly with communication outside the user's intranet and wide area network. Using the same security that LIS vendors do should be adequate.*

### 1.1.2.2 CIC Approach

Both CIC technical teams actively discussed several security approaches. However, two situations conspired to make it difficult for the CIC to develop a complete specification for point-of-care connectivity security at this time. First, the HIPAA<sup>xx</sup> regulations, which mandate levels and responsibilities for data security, were under active development during the Consortium's lifetime. These proposed rules had still not been ratified at the Consortium's sunset, making it impossible for the Consortium to use them for more than very general guidance.

Secondly, a system is only as secure as its weakest link. Thus, data security is a systems and solutions issue, not a particular technology issue.<sup>yy</sup> To ensure security, one has to provide end-to-end protection for the entire data management system. As the CIC interfaces may be employed in a wide range of settings over a diverse set of infrastructures, no single security approach could fit the requirements of all solutions that incorporate these interfaces.

Therefore, the Consortium's approach ensures that several security and encryption approaches can be used to safeguard data transmission over the CIC interfaces. Vendors may pick the most appropriate approach(es) from among the following, based on user, system engineering and deployment requirements:

#### 1. Device message-layer encryption:

The HL7 v3 message structure provides 'hooks' to encrypt message contents. If the additional Device processing power required by encryption algorithms is not an issue, each message between the Device and the Observation Reviewer may be encrypted.

#### 2. Device lower-layer encryption:

In the future, the Access Point specification could be extended to include a secure lower-layer protocol. Possibilities include Secure Sockets Layer (SSL) and next generation of wireless (Bluetooth<sup>TM</sup>, IEEE 802.11) and Internet protocols (IPv6).

<sup>xx</sup> HIPAA = Healthcare Insurance Portability and Accountability Act. See <http://aspe.os.dhhs.gov/admsimp> for detailed information.

<sup>yy</sup> Even the security of particular technologies must be questioned, as illustrated by recently detected flaws in the security layers of the Wireless Access Protocol (WAP), Bluetooth<sup>TM</sup>, and the Wireless Equivalent Privacy (WEP) scheme of the IEEE 802.11b radio-frequency network standard.

### 3. Secure lower-layer Observation Reporting transport:

A secure transmission protocol could be used to safeguard the transmission of the Observation Reporting messages.

Features of the Access Point specification that contribute to securing communications include:

#### 1. Secure Device to Access Point connection:

The link between a Device and an Access point is a short-range, point-to-point infrared or cabled connection. This approach physically secures this stage of the communication.<sup>zz</sup>

#### 2. Access Point limits access:

The Access Point exposes only the specific services required for POC data management, not general access to the hospital network. Thus, a hostile individual could not use an Access Point to gain wide access to the 'back-end' network.

#### 3. Device Authentication:

An important aspect of secure communication is ensuring the identity of the participants. The Device Messaging Layer prescribes the use of an IEEE EUI-64 identifier, which can be used to globally and uniquely identify each Device.

### 1.1.3 International Needs

#### 1.1.3.1 Point-of-Care User's Issue

*International needs must be considered, as they may be less stringent in regulatory aspects such as QC lockout and report generation than the United States. Additionally, standards of communication differ across the globe. For the CIC standard to gain widespread acceptance, development should consider how the standard would be accepted in different countries.*

#### 1.1.3.2 CIC Approach

Most of the commercial members of the Consortium manufacture and sell point-of-care solutions for international markets. Thus, this issue is of keen concern to all. The Consortium has taken several approaches to address this issue:

##### 1. Use vendor's international product development experience:

The Consortium was able to rely on the experience that many vendors have developing products for international markets.

##### 2. Build on existing international standards:

The CIC Specification is built on several standards that enjoy worldwide acceptance: HL7, IrDA, and TCP/IP. For example, the CIC Access Point Interface leverages the ISO/IEEE 11073-30200 for 'cable-connected' medical Devices. Nowhere did the CIC employ a US-only technology or approach.

<sup>zz</sup> While there are techniques for 'eavesdropping' on infrared communications, these approaches require close proximity and a line-of-site view of the exchange. In practice, this is seldom reasonable. Thus, point-to-point infrared is regarded as a reasonably secure physical transport.

3. Actively solicit input and participation from European healthcare providers:

The CIC has hosted several events in Europe to introduce the Consortium's approach to the point-of-care users outside the US. These events include:

- a. November 1999 – Düsseldorf, Germany: CIC Briefing at the Medica conference.
  - b. September 2000 – Milan, Italy: CIC-hosted *European POC Users Focus Group*, in conjunction with the *Computing in the Clinical Laboratory Conference*.
  - c. October 2000 – Italy: Several presentations at the *International Council for Science – Committee on Data for Science and Technology (CODATA)* conference.
  - d. November 2000 – Düsseldorf, Germany: CIC Briefing at the *Medica 2000* conference.
  - e. November 2000 – England: Several presentations at *EuroLab Automation 2000*.
4. Establish a point-of-care European Round Table (ERT) – a core group of influential European point-of-care users who can influence the direction of connectivity standardization in Europe, as well as provide input to the future evolution of the CIC Specification.
5. Provide a path for international standardization of the CIC Specification:

The CIC has initiated discussions with several international standards development organizations to ensure that the CIC Specification will have worldwide visibility. Technical Committee 215 (TC215) of the International Organization for Standardization (ISO) already publishes several of the standards the CIC Specification leverages (ISO/IEEE 11073 and HL7). This committee represents the most likely avenue for international recognition of connectivity standards derived from the CIC's work.

In addition, the CIC Device and Access Point (DAP) specification has been largely adopted as an ISO standard, ISO/IEEE 11073-30300:2004(E). This will ensure a universal lower-layer connectivity standard for medical Devices and instruments.

#### 1.1.4 Individualized Data Access

##### 1.1.4.1 Point-of-Care User's Issue

*Access to data and communications should be multilevel (hierarchy of those involved in POCT, nurse operator, POCT coordinator, director) and user-defined (the ability to individualize data access and summary).*

##### 1.1.4.2 CIC Approach

Similar to the case with the security requirement, this issue must be addressed by the vendors supplying point-of-care information management solutions. However, the CIC Specification provides several features to enable building these solutions:

##### 1. Operator List management:

The Device Interface provides a means to upload certified operator lists to Devices.

## 2. Access Control messages:

The Device Messaging Layer specification also includes messages to communicate operator access control restrictions. Observation Reviewers may send lists of access permissions to Devices that support operator access control. Devices may use this information to restrict individual operator's access to certain instrument functions.

### 1.2 Must Haves

In addition to the general requirements discussed previously, the Provider Review Committee identified ten 'must have' requirements for standardized point-of-care connectivity solutions. The following subsections describe these requirements and discuss how the CIC Specification addresses them.

#### 1.2.1 Bidirectional Connectivity

##### 1.2.1.1 Point-of-Care User's Issue

*The point-of-care Device should be able to seamlessly communicate with the results database, and the database should be able to communicate with the Device, transferring data in both directions.*

##### 1.2.1.2 CIC Approach

This requirement is met completely as both the Device Interface and the Observation Reporting Interface provide for bidirectional data flow.

#### 1.2.2 Standardized Device Connections, Plug and Play

##### 1.2.2.1 Point-of-Care User's Issue

*Any Device should be able to connect to any database/LIS/HIS system. All Devices should be able to use common docks, ports, and wiring for communications.*

##### 1.2.2.2 CIC Approach

The CIC Specification makes the solution to this requirement straightforward. The two CIC interfaces provide the infrastructure end-to-end connectivity. All Devices Access Points and Observation Reviewers that use the CIC Device Interface will be able to connect without employing additional hardware wiring or software. Likewise, the Observation Reporting Interface ensures interoperability connectivity between Observation Reviewers and Observation Recipients.

The Access Point specification describes a low-cost Access Point infrastructure that can support *cable-connected* Devices using ISO/IEEE 11073-30200 and *IrDA infrared* which is currently being standardized as ISO/IEEE 11073-30300. This infrastructure can be *shared* by CIC POC and ISO/IEEE 11073 Devices and can be extended to support hand-held PDAs such as the Palm™ and Pocket PC™ as well. The CIC 'lower-layers' infrastructure can also support proprietary upper-layer Device protocols as well the standard CIC 'Device Messaging Layer' making it possible for Devices that use proprietary or standard protocols to coexist on the same communications infrastructure. The CIC lower-layer standard also supports the ability of any POC Device to select any proprietary or CIC-compatible POC Data Manager using a networked Access Point on a TCP/IP network.

### 1.2.3 Use Existing Infrastructure

#### 1.2.3.1 Point-of-Care User's Issue

*Connectivity standards should be able to use commonly existing communications infrastructures. They should not require new hardware to install the standards; phone, Internet, etc.*

#### 1.2.3.2 CIC Approach

The CIC Specification does not introduce any new networking or communication protocols unique to the point-of-care environment. Instead, the CIC Specification leverages several existing communication and messaging standards such as IrDA and TCP/IP. Thus, solutions built on the CIC Specification will be able to use commonly found networking and communication infrastructures.

Although it will be necessary to add networked Access Points, the resulting CIC-compatible connectivity infrastructure will be able to support CIC POC and ISO/IEEE 11073 Devices and can be extended to support hand-held PDAs such as the Palm™ and Pocket PC™ as well. Since this infrastructure can be shared by all Devices, the connectivity cost for each Device is reduced. *Networked* Access Points are specified to use the existing TCP/IP LAN infrastructure already available at most user sites.

### 1.2.4 Conservation of IP Addresses

#### 1.2.4.1 Point-of-Care User's Issue

*Hospitals, Physician's Offices, Clinics and Homes have limited ability to add additional Internet Protocol (IP) addresses. Communication standards should utilize existing hardware and IP addresses.*

#### 1.2.4.2 CIC Approach

The Access Point specification does not require that each Device have an IP address. Instead, the Access Point systems bear the responsibility of being network aware. Thus, only Access Points will need to have IP addresses. Since there are many more Devices than Access Points, this approach minimizes the impact on healthcare institutions' IP address spaces.

In addition, the Access Point specification endorses the use of the Dynamic Host Configuration Protocol (DHCP) to assign IP addresses to Access Points on hospital networks that already use DHCP. This helps 'conserve' and 'recycle' IP addresses at sites that have a limited number of globally valid IP addresses. Since Access Point IP addresses do not in general need to be globally valid, private IP addresses could be used.

### 1.2.5 Ability to Meet Regulatory Guidelines

#### 1.2.5.1 Point-of-Care User's Issue

*Communication standards should minimally provide a means of meeting CAP, JCAHO, State, COLA, and other regulatory guidelines.*

#### 1.2.5.2 CIC Approach

At a minimum, all Devices are required to support reporting Status and Observation messages. These messages are sufficient to communicate Device identification patient test results and quality test results. Thus, they form the core of systems to manage the essential processes of observation reporting and QC/QA management.



## 1.2.6 Compatibility With LIS Order Generation

### 1.2.6.1 Point-of-Care User's Issue

*Point-of-care test results and orders should be linked. The connectivity standards should support the most common point-of-care ordering situations and the typical LIS order generation processes.*

### 1.2.6.2 CIC Approach

The Observation Reporting Interface manages the linkage between results and orders. This interface supports the three most common result-and-order scenarios:

1. Preordered Observation, with order information.
2. Unordered Observation, LIS should place order.
3. New Observation, LIS should search for order.

The Observation Reporting interface also supports the documentation and communication of errors if results and orders can't be matched.

## 1.2.7 Interoperability With Commercial Software

### 1.2.7.1 Point-of-Care User's Issue

*The connectivity standard should be compatible with available software from both POCT Device manufacturers as well as LIS, HIS, and other commercial database vendors.*

### 1.2.7.2 CIC Approach

One of the CIC's most important objectives was to ensure that existing Devices and systems could be easily brought into compliance with the CIC Specification. As a result, the CIC focused on using technologies and approaches compatible with existing systems, rather than requiring manufacturers to develop and introduce completely new technologies.

Building the Observation Reporting interface on existing HL7 messaging technology ensures that all LIS and other hospital information system vendors can easily support this interface.

The Access Point specification mandates that the IrDA protocol be used, which is built-in to many operating systems and available to POC Device vendors from several vendors.

The CIC 'Device Messaging Layer' leverages existing work done by the Health Level 7 (HL7) organization and uses XML, which has enjoyed widespread adoption by commercial vendors as the primary mechanism for exchanging machine-readable information on the Internet.

## 1.2.8 Security

### 1.2.8.1 Point-of-Care User's Issue

*The connectivity standard should utilize encryption and other means of ensuring the confidentiality of sensitive patient data, particularly outside intranet and wide area network. It should be adequate to use the same security as LIS vendors.*

### 1.2.8.2 CIC Approach

As mentioned in the discussion of security in the General Principles above, the CIC was unable to describe a security technology or approach that would meet the requirements of the under-development HIPAA standards as well as all possible point-of-care connectivity topologies. Instead, the CIC Specification provides a foundation on which appropriate security technologies may be applied, including:

- Device message-layer encryption;
- Device lower-layer encryption; and
- Secure lower-layer Observation Reporting transport.

Each of these approaches is described in more detail in the Security discussion in Section 1.1, General Principles.

## 1.2.9 Connectivity Doesn't Impede a Timely Result

### 1.2.9.1 Point-of-Care User's Issue

*A principle advantage of point-of-care testing is the speed with which a result can be produced. Clinical users will not accept connectivity solutions that impede the delivery of a timely result.*

### 1.2.9.2 CIC Approach

The CIC Specification does not interfere with a Device's generation of a result. Devices do not require CIC-connectivity to perform a test. Rather, Devices (and the other elements of a point-of-care information management solution) use CIC connectivity to send information to Devices prior to the testing process and to retrieve patient test and quality information from Devices after the testing process is complete.

At a simple level, Devices that are unavailable because they are 'docked' and performing lengthy downloads cannot produce timely results. The CIC spent some effort to optimize the Device Interface messaging for performance. However, the CIC had to trade-off performance against flexibility, extensibility, and ease of implementation. If speed and performance of docking synchronization is of paramount importance, vendors may use proprietary protocols for optimal communication efficiency. Such Devices may still be part of a CIC-compliant solution, as long as other elements of the system translate between the high-performance proprietary protocol and the CIC Device Interface protocol.

Finally, the widespread deployment of a universal 'Common Access Point' infrastructure within the hospital will lead to more frequent downloads of POCT data and more timely (and accurate) reporting of POCT results.

## 1.2.10 Easy to Use

### 1.2.10.1 Point-of-Care User's Issue

*The Connectivity standard should be intuitive and functionally simple to operate.*

### 1.2.10.2 CIC Approach

Design issues not related to connectivity will determine a large part of a Device's usability. The CIC Specification does not introduce any complex or difficult processes to the Device design problem.

The IrDA infrared communication technology used by the Device Interface was designed for the general consumer market where robustness and ease-of-use are paramount concerns. Specifically, this technology offers the following advantages in the POC environment:

- IrDA infrared provides a low-cost *cable-free* and *easy-to-use* short-range wireless connectivity solution that is well suited for 'point-and-shoot' data delivery.
- The IrDA protocol provides a lightweight directory mechanism that *eliminates any need to configure a POC Device*, at least for communicating with a CIC Observation Reviewer. This eliminates the configuration issues that typically plague traditional serial-line communication interfaces.

Finally, the approach described in the Access Point specification eliminates the need for multiple proprietary and mutually incompatible communication infrastructures, *providing a true 'plug-and-play' experience for clinicians*.

### 1.3 Other Objectives

The Provider Review Committee also identified the following issues as connectivity objectives. While they felt that these issues were also significant, they determined that these issues were less important than those identified as “Must Have” objectives.

#### 1.3.1 Seamless Download

##### 1.3.1.1 Point-of-Care User's Issue

*The ultimate goal is to have transparent point-of-care testing communication totally automatic and without requiring operator interaction.*

##### 1.3.1.2 CIC Approach

A totally automatic download requires an ‘always on’ network connection. Only radio-frequency (RF) wireless technology can support this requirement. This technology comes in several ‘flavors’ such as Bluetooth™ or IEEE 802.11. These technologies provide very different capabilities and address different customer problems. At this time, it is simply too early to select a particular RF wireless communication standard. It does appear that the IEEE 802.11 RF LAN standards would be a sensible choice based on its rapid adoption and deployment. This issue is currently being explored by the ISO/IEEE 11073 Medical Information Bus committee.

It should be noted that the CIC 'Device Messaging Layer' is designed to operate above any reliable connection-oriented communication link and can be easily adapted to run above one or more RF LAN communication infrastructures.

#### 1.3.2 Configurable User Model

##### 1.3.2.1 Point-of-Care User's Issue

*Most point-of-care consumer has different sites, and point-of-care Devices can be utilized in many ways (i.e., carrying Device to bedside, carrying sample to a stationary Device, placing Device on portable carts, mobile helicopters and other transportation vehicles, etc.). The Connectivity standard should allow different use models or situations within the same health system.*

### 1.3.2.2 CIC Approach

This requirement was one of the motivations for designing flexibility and extensibility into the Device Messaging Layer. As a result, this interface can support Devices deployed in a variety of situations, with many different use models. Some of these include:

- home-base testing (patient-operated, very simple communication and control);
- highly-regulated hospital testing (operator certification, patient certification, extensive QC/QA processes and reporting); and
- out-of-hospital testing (every possibility between case number one and number two).

The Device Interface dialog can be tailored on a per-Device basis; so different Devices from the same vendor can be employed in a variety of environments with many different use models.

## 1.3.3 Instrument Dock LIS Integration

### 1.3.3.1 Point-of-Care User's Issue

*For use scenarios having a docking station for point-of-care communication (Device is dropped into a dock for communicating data with a database) the communication should occur directly with the database, not requiring intervening steps like a laptop, file conversion, etc.*

### 1.3.3.2 CIC Approach

The two CIC interfaces do not require any human interaction to operate. Thus, a system built on these interfaces can provide a seamless Device-to-LIS download experience.

In addition, sufficiently capable Devices may directly expose the Observation Reporting Interface, bypassing the Device Interface. These Devices could then communicate directly with an LIS.

## 1.3.4 Ability to Force a Download

### 1.3.4.1 Point-of-Care User's Issue

*Communication needs to support a POCT Device lockout if Device does not communicate with a database in a defined time.*

### 1.3.4.2 CIC Approach

Because Devices are not connected with an 'always on' infrastructure, there is no way for Observation Reviewers to directly 'force' Devices to download data. However, the CIC Device Interface does support this user requirement to some extent by communicating several update times to Devices:

- Observations update time – the date and time of last successful test result download.
- Operator List update time – the date and time of the last successful upload of operator list information to the Device (if supported).
- Patient List update time – the date and time of the last successful upload of patient list information to the Device (if supported).

Device designers may use these update times to implement the desired ‘forced download’ application-level behavior (e.g., by locking out testing capabilities a certain period after the most recent observation download).

### 1.3.5 Ability to Qualify Results

#### 1.3.5.1 Point-of-Care User’s Issue

*It is important to be able to annotate some results (i.e., finger stick, venous draw, difficult stick, insulin dose, clinical action, error codes, results outside Device linearity, critical action limits exceeded, QC performed on Device, cleaned Device, reran control, etc.). Types of notes can vary by institution and location but can span clinical action, maintenance, and quality control to preanalytical issues.*

#### 1.3.5.2 CIC Approach

The Device Message Layer provides several mechanisms to communicate the annotations and notes described above. These include:

1. User-supplied notes in the Observation message:

The Observation message provides several fields for user-supplied comments. Notes may be attached to each observation, as well as to each result within a panel of tests.

2. Device Event messages:

These messages are designed to allow Devices to communicate operational status, warning and error information. Vendors may extend the types of Device Event messages to include a myriad of maintenance and operational reports.

## 1.4 Future Requirements

The Provider Review Committee also submitted a ‘wish list’ of requirements for future systems. These requirements include:

- Real time verification of patient ID and operator ID;
- Real time communication of results;
- Wireless communication;
- PDA Compatibility;
- Security:

Radio-frequency wireless connections would provide a new need for standards to secure point-of-care Device communication;

- “Expert system” analysis:

Evaluation and interpretation of Device output based on contextual data from multiple sources - Wireless, real time communication allows the ability to analyze the POCT data immediately; and

- Locator capability:

POCT Devices are portable, and sometimes hard to find. Wireless communication provides the ability to locate lost Devices.

#### 1.4.1 RF Wireless Issues

In general, most of these requirements require the use of a transparent radio-frequency connectivity infrastructure for real-time, always-on Device connectivity. Several current technologies compete as possible solutions:

1. Bluetooth™ – short-range RF wireless network protocol
2. IEEE 802.11b – RF wireless LAN technology, sometimes referred to as ‘WiFi.’<sup>aaa</sup>

These technologies were designed to address slightly different problems, and thus they provide slightly different solutions. Bluetooth™ was designed to facilitate connections between Devices located within a few meters of each other (forming a ‘piconet’ of nodes). A typical scenario for Bluetooth™ communication involves an individual’s PDA and cell phone establishing a connection to synchronize the PDA’s calendar program’s data. By design, Bluetooth™ was intended to replace the myriad cables and connectors required to link personal computation Devices.

In contrast, 802.11b was designed to replace LAN cabling. A typical 802.11b use scenario involves an individual with a laptop using an 802.11b transceiver roaming around an office or factory while persistently and wirelessly connected to network resources (e.g., e-mail servers, file servers, printers, etc.).

Unfortunately, both of these technologies use the same radio frequency band (2.4 GHz). As a result, they are likely to conflict in situations where both are in use. Both technologies have significant industry and user support behind them. Currently, there are many more 802.11b networks deployed than there are Bluetooth™ Devices available. As Bluetooth™ becomes more popular and prevalent, the marketplace will have to sort out which technology gains supremacy in what environment. It seems prudent to wait until this apparent conflict has settled before developing one or more RF wireless Device Interface standard(s) for medical Devices.

#### 1.4.2 Other Issues

Some of these ‘future issues’ do not involve wireless communication infrastructures. Possible ‘evolutionary’ CIC approaches to these issues are as follows:

- **PDA Compatibility:**

One of the strengths of the Access Point specification is that it endorses the use of IrDA infrared, which is supported on practically every hand-held PDA made today, such as the Palm™ and Pocket PC™. At least one CIC member company that already makes IrDA infrared network access points for the Palm™ and Pocket PC™ plans to support the CIC ‘Device and Access Point Interface’ specification.

---

<sup>aaa</sup> WiFi is a compatibility certification for 802.11b products administered by the Wireless Ethernet Compatibility Alliance (WECA).

- **“Expert System” Analysis:**

The CIC Specification and other medical Device communication standards will help promote the development of "expert systems" by providing a foundation for universal medical Device connectivity – an essential first step in providing the data that these systems will need.

- **Locator Capability:**

The Access Point specification provides a zero-cost method of automatically noting when and where (by network access point and port number) a Device was last connected to the network. Vendors could build applications that would track this information to build a “map” of last known locations. This approach could be evolved to provide real-time Device location information, when a true, “always on” connectivity infrastructure with Device location capability becomes available.

END OF APPENDIX-D: REQUIREMENTS

---

**This page is intentionally left blank.**



## APPENDIX E. CONNECTIVITY ARCHITECTURE

Jack Harrington  
CIC Architecture Working Group  
Becky Clarke, Bill Fannon, Alan Greenburg, Brent Lowensohn, Chris Melo,  
Jeff Perry, Joe Rogers, Daniel Trainor, Imre Trefil, Bob Uleski, Carol Vernay

---

A standard for global application developed through the CLSI consensus process.



(Formerly NCCLS)





**Contents**

1 Architecture .....275

2 Principles .....275

    2.1 Leverage .....275

    2.2 Minimize Standardization.....275

    2.3 Focus on Services .....276

    2.4 Separate Specification From Implementation .....276

    2.5 Minimize Device Complexity .....276

    2.6 Facilitate Legacy Migration.....277

3 Approach.....277

4 Model .....278

**Figures**

Figure 62. Architectural Approach .....277

Figure 63. Architecture Deliverables .....278

.....

## 1 Architecture

The initial version of the CIC's architecture for point-of-care connectivity was developed over the first six weeks of the Consortium's lifetime. The Architecture workgroup, led by Jack Harrington (Agilent Technologies), accepted the following mission:

*To develop a draft Architecture statement that will be used to guide the technical team's design and development efforts. This workgroup will interact with the Requirements and Scope teams to produce a draft by the end of Phase 0. During the Consortium's lifetime, this team will refine and maintain the Architecture document.*

The team developed an architectural model, described using the Unified Modeling Language (UML). This modeling effort was closely coordinated with the parallel Scope and Requirements efforts. The Architecture team's deliverable, a model for point-of-care connectivity, formed the basis for the CIC's Technical Teams' development efforts.

During the remainder of the Consortium's timeline, the architecture model was updated to address issues identified during the development and prototyping phases.

## 2 Principles

The following principles guided the Architecture Working Group's effort:

- (1) Where possible leverage existing standards and architectural patterns.
- (2) Minimize what needs to be standardized.
- (3) Focus on services to enable interoperability of value added functionality.
- (4) Separate specification from implementation, allow for multiple physical realizations.
- (5) Minimize complexity of Device communications.
- (6) Facilitate migration of existing proprietary approaches.

The following sections discuss these principles in more detail.

### 2.1 Leverage

Where possible, the CIC aimed to reuse or leverage existing standards, rather than develop new ones. It would be impossible to develop substantial, completely new standard specifications within the Consortium's 12- to 15-month lifetime. The existence of several standards that addressed issues that are similar, though not identical to those faced in point-of-care encouraged the CIC to adopt this principle. The specification's use of components from the IrDA, ISO/IEEE 11073, and HL7 standards validates this approach.

### 2.2 Minimize Standardization

The Consortium's Architecture team sought to focus on the few areas for standardization that would provide the greatest benefit to the customer. In any complex system, it is possible to define a large number of standards to govern interactions and behaviors. However, it is likely that a few standards from the set of all possible standards provide the majority of the benefit. These 'core' standards generally address the major interfaces and data flows between system components. The Architecture team strove to

focus on these ‘core’ standards to minimize the complexity of the specification while maximizing the benefits for implementation.

### 2.3 Focus on Services

Rather than focusing on the ‘boxes and wires’ that comprise point-of-care information management systems, the Architecture team first identified the services that participate current connectivity solutions. With this service-focused view, the team then defined standard interfaces between the three major collections of services: Device, Observation Reviewer, and Observation Recipient. This approach allows vendors a great deal of implementation and deployment flexibility. For example, the collection of services that comprise the Observation Review could be implemented in any of the following ‘boxes’:

- a point-of-care Data Manager;
- a Laboratory Information System;
- a moderately complex point-of-care instrument; and
- a personal digital assistant, such as a Palm Pilot™ or Pocket PC™.

Although these implementations look very different, the Device and Observation Reporting Interfaces can be profitably employed in each situation. Interface standards developed using a more box-focused approach would be more fragile and more closely tied to historical system architectures and implementations.

### 2.4 Separate Specification From Implementation

Another principle the Architecture team adopted to avoid developing fragile standards was to keep specification and implementation details separate. A wide variety of product architectures and implementations are needed to meet the requirements of the point-of-care environment, which varies from the hospital to the clinic to the home. If the connectivity specification were too closely tied to particular implementation details, it would be unlikely to fit the connectivity needs across the continuum of point-of-care testing sites. In addition, such a specification would probably be difficult to adapt to new technologies unforeseen today.

As a consequence of the application of this principle, the connectivity standard is an interface-level specification. The standard describes the interfaces between systems, rather than the behaviors of the systems themselves. Wherever possible, the interface description attempts to be technology neutral, to avoid encumbering the standard with implementation and technology dependencies. For example, the Device Interface protocol may be implemented using several different physical connections in use today (cabled and infrared), and could easily be adapted to radio-frequency wireless infrastructures in the future.

### 2.5 Minimize Device Complexity

Two motivations drove the need to minimize the complexity of the implementation required for Devices:

- Limited Device resources and capabilities

Many point-of-care instruments have very limited user interface, processing and memory capabilities. A specification that placed heavy resource requirements on a Device could only be implemented on a fraction of the Device architectures on the market today.

- Device cost sensitivity

Point-of-care instrument vendors are very sensitive to the cost of engineering and manufacturing Devices. The bulk of these vendors' profits come from sales of the disposable test reagents, not from the sale of the instruments themselves. Since complexity generally equates with cost, minimizing Device complexity addresses these vendors' concerns about additional Device engineering cost reducing the profits from consumable sales.

Therefore, where possible, the architecture team strove to allow complexity to move from the Device to the 'up stream' connectivity systems, the Observation Reviewers and Observation Recipients.

## 2.6 Facilitate Legacy Migration

To allow vendors and customers to see immediate benefit from implementing the connectivity standard, the architecture strove to provide easy paths to migrate existing systems into compliance with the standard. Some point-of-care information management components, such as the software applications and interfaces, can be upgraded relatively easily to take advantage of the connectivity standards. On the other hand, other components, such as the instruments and other hardware-related systems, generally take longer to reengineer and bring to market. An important goal of the architecture was to allow existing 'nonstandard' versions of these less malleable components to participate in a standards-based connectivity solution.

## 3 Approach

The Architecture Working Group employed the Rational Unified Process (RUP) when developing the architecture model and deliverables. Figure 62 illustrates this process and identifies where the different groups (Architecture work group, Technical Teams, CIC) contributed to the final specification.

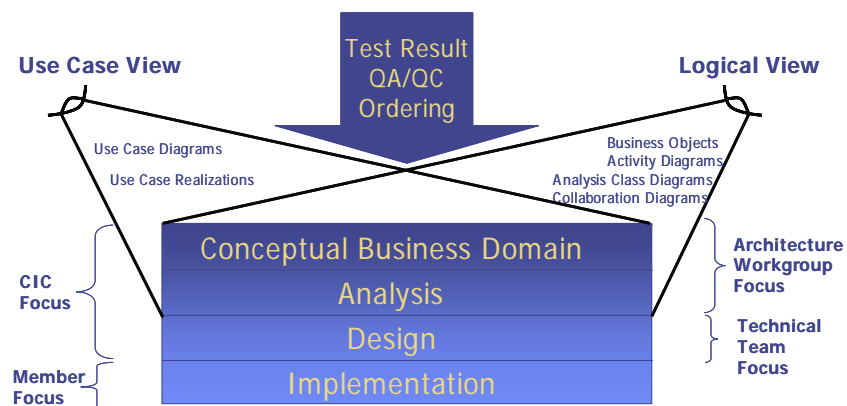

**Figure 62. Architectural Approach**

The Scope and Requirements workgroups identified three areas for the connectivity solution to address:

- Test result reporting;
- QA/QC process management; and
- Linking test results with associated orders.

During the initial months of the CIC's lifetime, the Architecture workgroup focused on decomposing these problem spaces into technology-neutral objects, such as "actors" and "interactions," using analyses

of relevant use case scenarios. The result of this process was a description of the services, interactions and activities that comprised the three point-of-care connectivity issues. Examining this model, it was clear that two interfaces presented opportunities for standardization: (1) the interface between the Device and the Observation Reviewer (Device Interface) and (2) the interface between the Observation Reviewer and the Observation Recipient (Observation Reporting Interface).

The CIC's technical teams took this direction and began to examine technologies and approaches that could be used to specify these interfaces. These teams developed the interface designs that are specified in this standard.

Except for prototyping and "proof of concept" efforts, the CIC's endeavors stopped short of actually implementing the interface designs. This implementation task is left to the Device and system vendors who adopt these standards.

## 4 Model

The Architecture Working Group's deliverable is a UML model expressed in three formats.

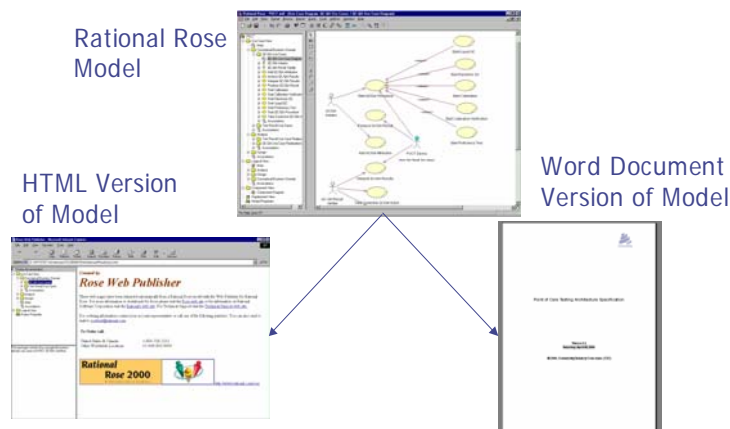

**Figure 63. Architecture Deliverables**

The UML model was developed using the Rose Modeler from Rational Corporation ([www.rational.com](http://www.rational.com)). This tool's native format is a 'petal' (".MDL") file. Two other versions of the model were derived from this petal file: a HTML expression for publication on a website, and a Microsoft Word 97 document.

All of these documents are available through CLSI.

END OF APPENDIX-E: ARCHITECTURE



## APPENDIX F. VENDOR CODES

---

A standard for global application developed through the CLSI consensus process.



(Formerly NCCLS)





**Contents**

1 Vendor Codes .....283  
    1.1 Vendor Code Extensions.....283

**Table**

Table 115. Coded Vendor Identifiers.....284

.....



## 1 Vendor Codes

Several messages, objects, and fields in the Device Messaging Layer (Appendix B) require the ability to uniquely identify the vendor associated with the message items (e.g., `vendor_id` in the device object). Also, the Device and Access Point Specification (Appendix A) permit Data Managers with vendor-specific enhancements to be specified. In both cases, an easily recognizable text string is required to identify the vendor.<sup>bbb</sup>

Table 115 contains identifiers, coded as strings, for the organizations involved in the development of the POCT1 standard. New organizations that need an identifier should contact CLSI to register a new coded identifier. When appropriate, it is recommended that the stock trading symbol be used, but other strings may be used provided that they do not conflict with stock trading symbols for any other company.

### 1.1 Vendor Code Extensions

It may be useful or desirable to “extend” the code to provide additional organizational information. To address such situations, the owner of a vendor code is allowed to append additional qualifying information to the ‘base’ code, using the prescribed field separator character ‘.’ to delineate additional organizational subfields.

For example, consider a code that indicates that the relevant DML data item or IAS service is qualified by ‘GE Healthcare.’ Since General Electric ‘owns’ the code “GE,” it is allowed to create a vendor code that starts with this string and then appending additional qualifying subfields. In this example, General Electric would employ the full code “GE.HC” where the period character ‘.’ is the defined field separator value.

---

<sup>bbb</sup> These text string codes are used *in addition* to the 24-bit numeric IEEE ‘Organizationally Unique Identifier.’

Table 115. Coded Vendor Identifiers

| ORGANIZATION                       | CODE    |
|------------------------------------|---------|
| Abaxis                             | ABAX    |
| Abbott Laboratories                | ABT     |
| Agilent Technologies               | A       |
| Avocet Medical                     | AVOCT   |
| Bayer Diagnostics                  | BAYER   |
| BD                                 | BDX     |
| Biochemtronics <sup>ccc</sup>      | BCHMX   |
| Cerner                             | CERN    |
| Clarinet Systems                   | CLAR    |
| Control Corporation                | CMTRL   |
| First Medical/Sigma Diagnostics    | FMSDG   |
| GE Healthcare                      | GE      |
| HemoCue                            | HMCUE   |
| HemoSense                          | HMSNS   |
| Instrumentation Laboratory         | IL      |
| InterComponentWare                 | ICW     |
| i-STAT Corporation                 | ISTAT   |
| ITC                                | ITC     |
| Lantronix                          | LTRX    |
| LifeScan/J&J                       | LFSCN   |
| Medical Automation Systems         | MAS     |
| Medtronic                          | MDT     |
| Motorola                           | MOT     |
| Nova Biomedical                    | NOVABIO |
| Orasure Technologies, Incorporated | OSUR    |
| Pharmacia Diagnostics              | PHADI   |
| Philips Medical Systems            | PMS     |
| Radiometer Medical                 | RAD     |
| Roche Diagnostics/AVL Scientific   | ROCHE   |
| Siemens                            | SIEM    |
| Sunquest                           | SUNQ    |
| TELCOR                             | TLCOR   |

---

END OF APPENDIX F: VENDOR CODES

---

<sup>ccc</sup> “Biochemtronics” is a hypothetical organization that is used throughout the POCT1 standard for illustration purposes.

**Clinical and Laboratory Standards Institute consensus procedures include an appeals process that is described in detail in Section 8 of the Administrative Procedures. For further information, contact the Executive Offices or visit our website at [www.clsi.org](http://www.clsi.org).**

## Summary of Comments and Subcommittee Responses

POCT1-A: *Point-of-Care Connectivity; Approved Standard*

### Appendix B, Section 5.1, Access Control Object

1. In implementing the POCT1-A standard, I have found the following inconsistency in the document and would like guidance from the POCT1-A subcommittee on how to handle operator information:

The operator Access Control object (Section 5.1) has a `permission_level_cd` attribute that is described as a "Code indicating what operations the user is allowed to perform." The default set of entries for this attribute are defined in Table 10, which has columns for Code, Value and Description. This information implies that the Code is communicated, not the Value.

The examples for Operator List Topic (Section 11.5) show communication of the Value. I would think that, as the `permission_level_cd` attribute is data type CV, the Code should be used and not the Value.

- **The Operator List Topic examples in Section 11.5, Operator List Topic, have been corrected to reflect the communication of the Code and not the Value.**

2. The `permission_level_cd` attribute in the operator Access Control object has both a Code field and a Value field:
 

|            |              |
|------------|--------------|
| e.g., Code | Value        |
| 1          | SUPERVISOR   |
| 2          | KEY OPERATOR |

The attribute type is CV which implies that the coded value should be communicated in the V= field. However, the message examples for Operator List Topic use Values instead of Codes.

In other examples, CV attributes use Codes - for example in the Device Status Message, the Device Status Object includes `condition_cd` which is type CV and the example has V="R", where R is the code for Ready.

I'm assuming that the Operator List Topic example is incorrect and for my implementation I should send "1", "2", etc. Am I correct?

- **The Operator List Topic examples in Section 11.5, Operator List Topic, have been corrected to reflect the communication of the Code and not the Value.**

### Appendix B, Section 5.4, Control/Calibration Object

3. Can the data type of `material_lot_number` fields (currently CV) be changed (to perhaps CS)? Third-party materials may well be from vendors that have not registered with the standard and therefore values will not be available for the SN and SV fields required with the CV type.

- **The data type of the `material_lot_number` fields has been changed to CS. The examples have been revised accordingly.**

### Appendix B, Section 5.5, Device Object

4. Can the `device_id` field of the Hello message's Device object use device name + serial number instead of the IEEE EUI-64 number? Observation Reporting Interface Specification implies that it can, but the Device

Messaging Layer Specification does not. Would it be better to have the device\_id be EUI-64 or vendor name^model^serial number and vendor\_id be registered company name (e.g., BAYER)?

- **The EUI-64 number shall be used to be consistent with IEEE 1073 recommendations for the Device Messaging Layer. The recommendations in Appendix B have not been revised; however, NOTE 1, found in Appendix C, Observation Reporting Interface, Section 3, Message Profile has been revised as follows:**
  - (1) **The Device Identifier should be globally unique. The Device Interface specifies that the IEEE EUI-64 identifier scheme be used for future Devices (e.g., "12-34-56-78-90-AB-CD-EF"). To accommodate legacy systems, this field may contain one of the following three formats: 1. EUI-64 (preferred) 2. concatenation of vendor\_id, model\_id, and serial\_id fields from the device object of the DML using the ^ as a delimiter, or 3. a legacy identifier string. Any vendor specified format shall be distinguishable from a EUI-64 format and should be distinguishable from the format of the vendor\_id. Refer to the *POCT1 Device Messaging Layer* specification for more information about the expected format of this field.**
- 5. Specification deprecates the use of encoding characters and then uses '^' in the vendor\_id field.
- **The use of '^' has been completely deprecated by creating two new attributes in the device object and redefining the vendor\_id.**

#### Appendix B, Section 5.7, Device Static Capabilities Object

6. The Device Static Capabilities object has a max\_message\_sz attribute that allows the device to limit the largest size message that it will receive. In defining the standard we forgot to indicate the units to be used and the only other reference in the standard is the fields used in an example, where '800' is used, without units. Is it characters, bytes, Kbytes, etc?
- **The characters should be in bytes. The max\_message\_sz is an Integer data type and therefore cannot have units included. The max\_message\_sz description in Table 19 has been revised as follows:**

**The maximum size message (in bytes) that the Device can handle.**

#### Appendix B, Section 8.11, Point in Time (TS)

7. The standard uses the HL7 version 3 Point in Time (TS) data type for all date/time values. The description given for this data type in the standard explains the different components (YYYY, MM, etc) but does not indicate that different precisions are allowed. However, in the examples we have 'complete' time stamps (such as observation\_dttm V= "2002-08-15T10:34:35+1.00") and 'incomplete' time stamps (such as expiration\_date V="2002-06-30"). Is the use of variable precision allowed under HL7 version 3 (and therefore the POCT1-A standard)? Also, are separators (hyphens, colons and 'T') required? I've seen examples in HL7 documents that use them and others that don't.
- **The HL7 V3 uses following definition of PointInTime as DATA TYPE:**  
**type PointInTime alias TS extends QTY {**  
**PQ offset;**  
**CS calendar;**  
**INT precision;**  
**PQ timezone;**  
**BL equals(TS x);**  
**TS plus(PQ x);**  
**PQ minus(TS x);**  
**literal ST;**  
**type PQ diff;}**

**The precision is defined as "the number of significant digits of the calendar expression representation."**

**In the HL7 V3 Implementation Technology Specification, e.g., the XML, the dateTime data type is used. The dateTime expression may be "truncated" from the right-hand-side to lower the precision, in case that full**



precision is not necessary. The CLSI POCT1-A Device Messaging Layer *requires* that the separator characters '-', 'T', ':' and '.' to be used in the time stamp, as well as '+' and '-' and 'Z' for the time-zone offset, if the latter is provided. The user should take into account the characteristics of the application. The following note has been added to Section 8.11 for clarification:

**NOTE:** Use of variable precision (right to left truncation) is allowed and separator characters are required.

.....

## The Quality System Approach

Clinical and Laboratory Standards Institute (CLSI) subscribes to a quality management system approach in the development of standards and guidelines, which facilitates project management; defines a document structure via a template; and provides a process to identify needed documents. The approach is based on the model presented in the most current edition of CLSI/NCCLS document HS1—*A Quality Management System Model for Health Care*. The quality management system approach applies a core set of “quality system essentials” (QSEs), basic to any organization, to all operations in any healthcare service’s path of workflow (i.e., operational aspects that define how a particular product or service is provided). The QSEs provide the framework for delivery of any type of product or service, serving as a manager’s guide. The quality system essentials (QSEs) are:

|  |  |   |  |
|--|--|---|--|
| Documents & Records<br>Organization<br>Personnel | Equipment<br>Purchasing & Inventory<br>Process Control | Information Management<br>Occurrence Management<br>Assessment | Process Improvement<br>Service & Satisfaction<br>Facilities & Safety |
|--|--|---|--|

POCT1-A2 addresses the quality system essentials (QSEs) indicated by an “X.” For a description of the other documents listed in the grid, please refer to the Related CLSI/NCCLS Publications section on the following page.

| Documents & Records        | Organization | Personnel                          | Equipment                   | Purchasing & Inventory | Process Control                           | Information Management | Occurrence Management | Assessment | Process Improvement | Service & Satisfaction | Facilities & Safety |
|----------------------------|--------------|------------------------------------|-----------------------------|------------------------|---|------------------------|-----------------------|------------|---------------------|------------------------|---------------------|
| AST4<br>C30<br>GP19<br>HS2 | AST2<br>GP19 | AST2<br>AST4<br>C30<br>GP19<br>HS2 | AST2<br>AST4<br>GP19<br>HS2 | GP19                   | AST2<br>AST4<br>C30<br>GP19<br>HS2<br>HS3 | X<br>GP19              | GP19                  |            | GP19                | GP19                   | AS52<br>GP19        |

Adapted from CLSI/NCCLS document HS1—*A Quality Management System Model for Health Care*.

## Path of Workflow

A path of workflow is the description of the necessary steps to deliver the particular product or service that the organization or entity provides. For example, CLSI/NCCLS document GP26—*Application of a Quality Management System Model for Laboratory Services* defines a clinical laboratory path of workflow which consists of three sequential processes: preexamination, examination, and postexamination. All clinical laboratories follow these processes to deliver the laboratory’s services, namely quality laboratory information.

POCT1-A2 addresses the clinical laboratory path of workflow steps indicated by an “X.” For a description of the other documents listed in the grid, please refer to the Related CLSI/NCCLS Publications section on the following page.

| Preexamination       |                    |                  |                           | Examination |                              |                | Postexamination                 |                   |
|----------------------|--------------------|------------------|---------------------------|-------------|------------------------------|----------------|---------------------------------|-------------------|
| Examination ordering | Sample collection  | Sample transport | Sample receipt/processing | Examination | Results review and follow-up | Interpretation | Results reporting and archiving | Sample management |
|                      | AST4<br>C30<br>HS2 | HS2              | HS2                       | AST4<br>HS2 | AST4<br>C30<br>HS2           | HS2            | X<br>C30<br>HS2                 |                   |

Adapted from CLSI/NCCLS document HS1—*A Quality Management System Model for Health Care*.

**Related CLSI/NCCLS Publications\***

- AST2-A**      **Point-of-Care *In Vitro* Diagnostics (IVD) Testing; Approved Guideline (1999).** This document contains guidelines to provide users of *in vitro* diagnostic (IVD) devices outside of the clinical laboratory with the guidance necessary to produce reliable results comparable to those obtained within the clinical laboratory.
- AST4-A2**      **Glucose Monitoring in Settings Without Laboratory Support; Approved Guideline—Second Edition (2005).** This document contains guidelines for performance of point-of-care (POC) glucose monitoring systems that stress quality control, training, and administrative responsibility.
- C30-A2**      **Point-of-Care Blood Glucose Testing in Acute and Chronic Care Facilities; Approved Guideline—Second Edition (2002).** This document contains guidelines for performance of point-of-care (POC) blood glucose testing that stress quality control, training, and administrative responsibility.
- GP19-A2**      **Laboratory Instruments and Data Management Systems: Design of Software User Interfaces and End-User Software Systems Validation, Operation, and Monitoring; Approved Guideline—Second Edition (2003).** This document identifies important factors that designers and laboratory managers should consider when developing new software-driven systems and selecting software user interfaces. Also included are simple rules to help prepare validation protocols for assessing the functionality and dependability of software.
- HS2-A**      **Provider-Performed Microscopy Testing; Approved Guideline (2003).** This guideline provides information on specimen collection, test methodologies, procedural steps, reporting of results, and the quality assurance aspects of provider-performed microscopy.
- HS3-A**      **Pulse Oximetry; Approved Guideline (2005).** Pulse oximetry is a widely used device for the clinical assessment of arterial oxygenation and pulse rate. The clinical applications, quality assessment, and limitations are discussed in this guideline.

---

\* Proposed- and tentative-level documents are being advanced through the CLSI consensus process; therefore, readers should refer to the most recent editions.

**Sustaining Members**

Abbott Laboratories  
American Association for Clinical Chemistry  
AstraZeneca Pharmaceuticals  
Bayer Corporation  
BD  
Beckman Coulter, Inc.  
bioMérieux, Inc.  
CLMA  
College of American Pathologists  
GlaxoSmithKline  
Ortho-Clinical Diagnostics, Inc.  
Pfizer Inc  
Roche Diagnostics, Inc.

**Professional Members**

AABB  
American Academy of Family Physicians  
American Association for Clinical Chemistry  
American Association for Laboratory Accreditation  
American Association for Respiratory Care  
American Chemical Society  
American Medical Technologists  
American Society for Clinical Laboratory Science  
American Society for Microbiology  
American Society of Hematology  
American Type Culture Collection, Inc.  
ASCP  
Associazione Microbiologi Clinici Italiani (AMCLI)  
British Society for Antimicrobial Chemotherapy  
Canadian Society for Medical Laboratory Science - Société Canadienne de Science de Laboratoire Médical  
Canadian Standards Association CISMEL-SIMel  
Clinical Laboratory Management Association  
COLA  
College of American Pathologists  
College of Medical Laboratory Technologists of Ontario  
College of Physicians and Surgeons of Saskatchewan  
ESCMD  
Hong Kong Accreditation Service Innovation and Technology Commission  
International Federation of Clinical Chemistry  
Italian Society of Clinical Biochemistry and Clinical Molecular Biology  
Japanese Committee for Clinical Laboratory Standards  
Joint Commission on Accreditation of Healthcare Organizations  
Minneapolis Medical Research Foundation  
National Academy of Clinical Biochemistry  
National Society for Histotechnology, Inc.  
Ontario Medical Association Quality Management Program-Laboratory Service  
RCPA Quality Assurance Programs PTY Limited  
SDS Pathology  
Sociedad Espanola de Bioquímica Clínica y Patología Molecular  
Sociedade Brasileira de Análises Clínicas  
Sociedade Brasileira de Patologia Clínica  
Taiwanese Committee for Clinical Laboratory Standards (TCCLS)  
Turkish Society of Microbiology  
World Health Organization

**Government Members**

Association of Public Health Laboratories  
BC Centre for Disease Control  
Caribbean Epidemiology Centre  
Centers for Disease Control and Prevention  
Centers for Medicare & Medicaid Services

Centers for Medicare & Medicaid Services/CLIA Program  
Chinese Committee for Clinical Laboratory Standards  
Department of Veterans Affairs  
Deutsches Institut für Normung (DIN)  
FDA Center for Biologics Evaluation and Research  
FDA Center for Devices and Radiological Health  
FDA Center for Veterinary Medicine  
Iowa State Hygienic Laboratory  
Massachusetts Department of Public Health Laboratories  
National Center of Infectious and Parasitic Diseases (Bulgaria)  
National Health Laboratory Service (South Africa)  
National Institute of Standards and Technology  
National Pathology Accreditation Advisory Council (Australia)  
New York State Department of Health  
Ontario Ministry of Health  
Pennsylvania Dept. of Health  
Saskatchewan Health-Provincial Laboratory  
Scientific Institute of Public Health; Belgium Ministry of Social Affairs, Public Health and the Environment

**Industry Members**

AB Biodisk  
Abbott Diabetes Care  
Abbott Laboratories  
Access Genetics  
Acrometrix Corporation  
AdvaMed  
Advancis Pharmaceutical Corporation  
Affymetrix, Inc.  
Agilent Technologies, Inc.  
Ammirati Regulatory Consulting  
Anna Longwell, PC  
Arpida Ltd  
A/S ROSCO  
AstraZeneca Pharmaceuticals  
Axis-Shield Diagnostics  
Axis-Shield POC AS  
Bayer Corporation – Tarrytown, NY  
Bayer Corporation - West Haven, CT  
Bayer HealthCare, LLC, Diagnostics Div. - Elkhart, IN  
BD  
BD Diabetes Care  
BD Diagnostic Systems  
BD VACUTAINER Systems  
Beckman Coulter, Inc.  
Beckman Coulter K.K. (Japan)  
Beth Goldstein Consultant (PA)  
Bio-Development S.r.l.  
Bio-Inova Life Sciences International  
Biomedica Laboratories SDN BHD  
bioMérieux (NC)  
bioMérieux, Inc. (IL)  
bioMérieux, Inc. (MO)  
Bio-Rad Laboratories, Inc.  
Bio-Rad Laboratories, Inc. – France  
Bio-Rad Laboratories, Inc. – Irvine, CA  
Bio-Rad Laboratories, Inc. – Plano, TX  
Black Coast Corporation – Health Care Systems Consulting  
Blaine Healthcare Associates, Inc.  
Cepheid  
Chen & Chen, LLC  
Chi Solutions, Inc.  
Chiron Corporation  
The Clinical Microbiology Institute  
Comprehensive Cytometric Consulting  
Control Lab  
Copan Diagnostics Inc.  
Cosmetic Ingredient Review  
Cubist Pharmaceuticals  
Cumbre Inc.  
Dade Behring Inc. - Cupertino, CA  
Dade Behring Inc. - Deerfield, IL  
Dade Behring Inc. - Glasgow, DE  
Dade Behring Inc. - Marburg, Germany  
Dade Behring Inc. - Sacramento, CA  
David G. Rhoads Associates, Inc.  
Diagnostic Products Corporation  
Digene Corporation

Eiken Chemical Company, Ltd.  
Elanco Animal Health  
Electa Lab s.r.l.  
Enterprise Analysis Corporation  
F. Hoffman-La Roche AG  
Focus Bio-Inova, Inc.  
Future Diagnostics B.V.  
Gavron Group, Inc.  
Gen-Probe  
Genaco Biomedical Products, Inc.  
Genomic Health, Inc.  
Gentris Corporation  
Genzyme Diagnostics  
GlaxoSmithKline  
Greiner Bio-One Inc.  
Immunicon Corporation  
Instrumentation Laboratory  
International Technidyne Corporation  
I-STAT Corporation  
Japan Assn. of Clinical Reagents Industries  
Johnson and Johnson Pharmaceutical Research and Development, L.L.C.  
K.C.J. Enterprises  
LabNow, Inc.  
LifeScan, Inc. (a Johnson & Johnson Company)  
Medical Device Consultants, Inc.  
Merck & Company, Inc.  
Micromyx, LLC  
MultiPhase Solutions, Inc.  
Nanogen, Point-of-Care Diagnostics Div.  
Nippon Becton Dickinson Co., Ltd.  
Nissui Pharmaceutical Co., Ltd.  
NovaBiotics (Aberdeen, UK)  
Novartis Institutes for Biomedical Research  
Olympus America, Inc.  
Optimer Pharmaceuticals, Inc.  
Ortho-Clinical Diagnostics, Inc. (Rochester, NY)  
Ortho-McNeil Pharmaceutical (Raritan, NJ)  
Oxoid Inc.  
Oxonica (UK)  
Paratek Pharmaceuticals  
Pathology Services Inc.  
PathWork Informatics  
Pfizer Animal Health  
Pfizer Inc  
Pfizer Italia Srl  
Phadia AB  
Powers Consulting Services  
PPD, Inc.  
Predicant Biosciences  
Procter & Gamble Pharmaceuticals, Inc.  
QSE Consulting  
Radiometer America, Inc.  
Radiometer Medical A/S  
Rapid Laboratories Microsystems  
Reliance Life Sciences  
Replidyne  
Roche Diagnostics GmbH  
Roche Diagnostics, Inc.  
Roche Diagnostics Shanghai Ltd.  
Roche Laboratories (Div. Hoffmann-La Roche Inc.)  
Roche Molecular Systems  
Sanofi Pasteur  
Sarstedt, Inc.  
Schering Corporation  
Schleicher & Schuell, Inc.  
Seneca Medical Lab, Inc.  
SFBC Anapharm  
Sphere Medical Holding  
Streck Laboratories, Inc.  
Sismex America, Inc. (Long Grove, IL)  
Sismex Corporation (Japan)  
TheraDoc  
Theravance Inc.  
Third Wave Technologies, Inc.  
Thrombodyne, Inc.  
THYMED GmbH  
Transasia Engineers  
Trek Diagnostic Systems, Inc.  
TrimGen Corporation  
Watin-Biolife Diagnostics and Medicals  
Wyeth Research  
XDX, Inc.  
YD Consultant  
YD Diagnostics (Seoul, Korea)

**Trade Associations**

AdvaMed  
Japan Association of Clinical Reagents Industries (Tokyo, Japan)

**Associate Active Members**

35 MDSS/SGSAL (APO)  
59<sup>th</sup> MDW/859 MDT/MTL (TX)  
78<sup>th</sup> Medical Group (GA)  
Academisch Ziekenhuis -VUB (Belgium)  
ACL Laboratories (IL)  
ACL Laboratories (WI)  
Alexandria Hospital (IL)  
All Children's Hospital (FL)  
Allina Health System (MN)  
Allina Labs  
Alton Memorial Hospital (MN)  
American University of Beirut Medical Center (NY)  
Anaheim Memorial Hospital (CA)  
Antwerp University Hospital (Belgium)  
Arnett Clinic, LLC (IN)  
Aspirus Wausau Hospital (WI)  
Associated Regional & University Pathologists (UT)  
Atlantic Health System (NJ)  
Avista Adventist Hospital Laboratory (CO)  
AZ Sint-Jan (Belgium)  
Azienda Ospedale Di Lecco (Italy)  
Barnes-Jewish Hospital (MO)  
Barnes-Jewish St. Peters (MO)  
Barnes-Jewish West County Hospital (MO)  
BayCare Health System (FL)  
Baystate Medical Center (MA)  
BC Biomedical Laboratories (Surrey, BC, Canada)  
Bedford Memorial Hospital (VA)  
Boone Hospital Center (MO)  
British Columbia Cancer Agency – Vancouver Cancer Center (BC, Canada)  
Broward General Medical Center (FL)  
Calgary Laboratory Services (Calgary, AB, Canada)  
California Pacific Medical Center  
Canterbury Health Laboratories (New Zealand)  
Capital Health System Fuld Campus (NJ)  
Capital Health System Mercer Campus (NJ)  
Carilion Consolidated Laboratory (VA)  
Carolinas Medical Center (NC)  
Central Baptist Hospital (KY)  
Central Ohio Primary Care Physicians  
Central Texas Veterans Health Care System  
Centura Laboratory (CO)  
Chang Gung Memorial Hospital (Taiwan)  
Children's Healthcare of Atlanta (GA)  
Children's Hospital Medical Center (Akron, OH)  
Children's Hospital of Pittsburgh (PA)  
Childrens Hospital of Wisconsin  
Christian Hospital/Northeast/Northwest (MO)  
Christus St. John Hospital (TX)  
City of Hope National Medical Center (CA)  
Clarian Health - Methodist Hospital (IN)  
Clendo Lab (PR)  
Clovis Community Hospital (CA)  
CLSI Laboratories (PA)  
Commonwealth of Kentucky Community Care 5 (OH)  
Community College of Rhode Island  
Covance Central Laboratory Services (IN)  
Creighton University Medical Center (NE)  
Danish Institute for Food and Veterinary Research (Denmark)  
DeKalb Memorial Hospital (IN)  
Detroit Health Department (MI)  
DFS/CLIA Certification (NC)  
Diagnofirm Med Labs  
Diagnósticos da América S/A (Sao Paulo)  
Dianon Systems (OK)  
Dr. Everett Chalmers Hospital (New Brunswick, Canada)  
East Kootenay Regional Hospital Laboratory (BC)  
Evangelical Community Hospital (PA)  
Faith Regional Health Services (NE)

FasTraQ Inc. (NV)  
 Firelands Regional Medical Center (OH)  
 Fisher-Titus Memorial Hospital (OH)  
 Fleury S.A. (Brazil)  
 Florida Hospital East Orlando  
 Fresno Community Hospital and Medical Center  
 Gamma Dynacare Medical Laboratories (Ontario, Canada)  
 Gamma-Dynacare Laboratories (Brampton, Ontario)  
 Geisinger Medical Center (Danville, PA)  
 Geisinger Wyoming Valley Medical Center (Wilkes-Barre, PA)  
 General Health System (LA)  
 Hamad Medical Corporation (Qatar)  
 Harris Methodist Fort Worth (TX)  
 Hartford Hospital (CT)  
 Health Network Lab (PA)  
 Health Partners Laboratories (VA)  
 High Desert Health System (CA)  
 Hoag Memorial Hospital Presbyterian (CA)  
 Holy Cross Hospital (MD)  
 Hôpital Maisonneuve - Rosemont (Montreal, Canada)  
 Hôpital Sainte - Justine (Quebec)  
 Hospital Albert Einstein (Brazil)  
 Hospital Consolidated Laboratories (MI)  
 Hospital for Sick Children (Toronto, ON, Canada)  
 Hôtel Dieu Grace Hospital (Windsor, ON, Canada)  
 Hunter Area Pathology Service (DE)  
 Hunterdon Medical Center (NJ)  
 Indiana University  
 Interior Health Authority  
 Island Hospital (WA)  
 Jackson Health System (FL)  
 Jackson South Community Hospital (FL)  
 Jacobi Medical Center (NY)  
 John C. Lincoln Hospital (AZ)  
 John H. Stroger, Jr. Hospital of Cook County (IL)  
 Johns Hopkins at Bayview (MD)  
 Johns Hopkins Howard County General Hospital (MD)  
 Johns Hopkins Medical Institutions (MD)  
 Kadlec Medical Center (WA)  
 Kaiser Permanente (CA)  
 Kaiser Permanente (MD)  
 Kantonsspital Aarau AG (Aarau, AG)  
 Karolinska University Hospital  
 Kelowna General Hospital Laboratory (BC)  
 King Abdulaziz Medical City – Jeddah (Jeddah, WR, Saudi Arabia)  
 King Fahad National Guard Hospital (Saudi Arabia)  
 King Faisal Specialist Hospital (Saudi Arabia)  
 Kootenay Boundary Regional Hospital Laboratory (BC)  
 Kosciusko Laboratory (IN)  
 LabCorp (NC)  
 Laboratoire de Santé Publique du Quebec (Canada)  
 Laboratory Alliance of Central New York (NY)  
 Laboratory Corporation of America (NJ)

Lewis-Gale Medical Center (VA)  
 L'Hotel-Dieu de Quebec (Quebec, PQ)  
 LifeCare Hospital Lab (PA)  
 Littleton Adventist Hospital Laboratory (CO)  
 Long Beach Memorial Medical Center (CA)  
 Long Island Jewish Medical Center (NY)  
 Magee Womens Hospital of UPMC (PA)  
 Magruder Memorial Hospital (OH)  
 Malmo University Hospital (Sweden)  
 Manipal Acunova Pvt., Ltd. (India)  
 Martin Luther King/Drew Medical Center (CA)  
 Massachusetts General Hospital (Microbiology Laboratory)  
 MDS Metro Laboratory Services (Burnaby, BC, Canada)  
 Mease Countryside Hospital (FL)  
 Mease Dunedin Hospital (FL)  
 Medical Centre Ljubljana (Slovinia)  
 Medical College of Virginia Hospital  
 Medical University of South Carolina (SC)  
 Memorial Hospital (OH)  
 Memorial Medical Center (Napoleon Avenue, New Orleans, LA)  
 Memorial Regional Hospital (FL)  
 Methodist Hospital (TX)  
 Missouri Baptist Medical Center (MO)  
 Montreal General Hospital (Canada)  
 Mount Sinai Hospital (NY)  
 Mountainside Hospital (NJ)  
 MRL Europe (Zaventem)  
 National Healthcare Group (Singapore)  
 National University Hospital (Singapore)  
 NB Department of Health & Wellness (New Brunswick, Canada)  
 NC State Lab of Public Health (NC)  
 The Nebraska Medical Center  
 New England Fertility Institute (CT)  
 New York University Medical Center  
 New Zealand Diagnostic Group  
 NHG Diagnostics (Singapore)  
 Nichols Institute Diagnostics (CA)  
 NorDx (ME)  
 North Bay Hospital  
 North Coast Clinical Laboratory (OH)  
 North Shore Hospital Laboratory (Auckland, New Zealand)  
 North Shore - Long Island Jewish Health System Laboratories (NY)  
 Northern Plains Laboratory (ND)  
 Northwestern Memorial Hospital (IL)  
 Ochsner Clinic Foundation (LA)  
 Orange Coast Memorial Medical Center (CA)  
 Orlando Regional Healthcare System (FL)  
 Overlook Hospital (NJ)  
 Parker Adventist Hospital Laboratory (CO)  
 Parkland Health Center (MO)  
 Pathology Associates Medical Laboratories (WA)  
 Pathology Associates of Boone (NC)

Pediatrics Screening Inc. (PA)  
 Penn State Hershey Medical Center (PA)  
 Penitentiary Regional Hospital Laboratory (BC)  
 The Permanente Medical Group (CA)  
 Piedmont Hospital (GA)  
 Pitt County Memorial Hospital (NC)  
 Porter Adventist Hospital Laboratory (CO)  
 PPD (KY)  
 Presbyterian Hospital of Dallas (TX)  
 Prince George Medical Lab (Prince George, BC)  
 Provincial Health Services Authority (Vancouver, BC, Canada)  
 Provincial Laboratory for Public Health (Edmonton, AB, Canada)  
 Quest Diagnostics, Inc (San Juan Capistrano, CA)  
 Quintiles Laboratories, Ltd. (GA)  
 Regions Hospital  
 Research Medical Center (MO)  
 Rhode Island Department of Health Laboratories  
 Riverview Hospital (BC, Canada)  
 Riyadh Armed Forces Hospital (Riyadh)  
 Royal Inland Hospital Laboratory (BC)  
 Rural Health Ventures (NE)  
 SAAD Specialist Hospital (Saudi Arabia)  
 SAE – Laboratorio Medico (Brazil)  
 St. Agnes Healthcare (MD)  
 St. Anthony Hospital Central Laboratory (CO)  
 St. Anthony Hospital North Laboratory (CO)  
 St. Anthony's Hospital (FL)  
 St. Barnabas Medical Center (NJ)  
 St. Christopher's Hospital for Children (PA)  
 St-Eustache Hospital (Quebec, Canada)  
 St. John Hospital and Medical Center (MI)  
 St. John Regional Hospital (St. John, NB, Canada)  
 St. Joseph's Hospital (FL)  
 St. Joseph's Hospital and Medical Center (AZ)  
 St. Joseph's Hospital-Marshfield Clinic (WI)  
 St. Jude Children's Research Hospital (TN)  
 St. Louis Children's Hospital (MO)  
 St. Margaret Memorial Hospital (PA)  
 St. Mary Corwin Regional Medical Center Laboratory (CO)  
 St. Michael's Hospital (Toronto, ON, Canada)  
 San Antonio Community Hospital (TX)  
 San Francisco General Hospital (CA)  
 Santa Clara Valley Medical Center (CA)  
 Shands at the University of Florida  
 SJRMC Plymouth Laboratory (IN)  
 Sonora Quest JV (AZ)  
 South Bend Medical Foundation (IN)  
 South Florida Baptist Hospital (FL)  
 South Texas Laboratory (TX)  
 South Western Area Pathology Service (Australia)  
 Specialty Laboratories, Inc. (CA)

Starke Memorial Hospital Laboratory (IN)  
 State of Washington Department of Health  
 Stormont-Vail Regional Medical Center (KS)  
 Sunnybrook & Women's College Health Sciences Centre (Toronto, Ontario)  
 Sunnybrook Health Science Center (ON, Canada)  
 Taiwan Society of Laboratory Medicine  
 Tan Tock Seng Hospital (Tan Tock Seng)  
 Temple Univ. Hospital - Parkinson Pav. (PA)  
 Texas Department of State Health Services (TX)  
 Timmins and District Hospital (Canada)  
 The Children's University Hospital (Ireland)  
 Tri-Cities Laboratory (WA)  
 Tripler Army Medical Center (HI)  
 Tuen Mun Hospital (Hong Kong)  
 Tuttle Army Health Clinic (GA)  
 UCSD Medical Center (CA)  
 UCSF Medical Center China Basin (CA)  
 UNC Hospitals (NC)  
 Union Clinical Laboratory (Taiwan)  
 Universita Campus Bio-Medico (Italy)  
 University Medical Center (CA)  
 University of Chicago Hospitals (IL)  
 University of Colorado Hospital  
 University of Debrecen Medical Health and Science Center (Hungary)  
 University of Illinois Medical Center (IL)  
 University of Maryland Medical System  
 University of MN Medical Center - Fairview  
 University of the Ryukyus (Japan)  
 University of Virginia Medical Center  
 University of Washington  
 UPMC Horizon Hospital (PA)  
 U.S. Army Health Clinic – Vicenza (APO)  
 US LABS, Inc. (CA)  
 USA MEDDAC-AK  
 UZ-KUL Medical Center (Belgium)  
 VA (Asheville) Medical Center (NC)  
 Valley Health (VA)  
 Vejle Hospital (VA)  
 Vernon Jubilee Hospital Laboratory  
 Virginia Beach General Hospital (VA)  
 Warren Hospital (NJ)  
 Washington Hospital Center (DC)  
 Waterford Regional Hospital (Ireland)  
 Wellstar Health Systems (GA)  
 West China Second University Hospital, Sichuan University (P.R. China)  
 William Beaumont Army Medical Center (TX)  
 William Beaumont Hospital (MI)  
 Winn Army Community Hospital (GA)  
 Women's Health Laboratory (TX)  
 Woodlawn Hospital (IN)  
 York Hospital (PA)

**OFFICERS**

Robert L. Habig, PhD,  
 President  
 Abbott Laboratories  
  
 Gerald A. Hoeltge, MD,  
 President-Elect  
 The Cleveland Clinic Foundation  
  
 Wayne Brinster,  
 Secretary  
 BD  
  
 W. Gregory Miller, PhD,  
 Treasurer  
 Virginia Commonwealth University  
  
 Thomas L. Hearn, PhD,  
 Immediate Past President  
 Centers for Disease Control and Prevention  
 Glen Fine, MS, MBA,

**BOARD OF DIRECTORS**

|  |  |
|--|--|
| Susan Blonshine, RRT, RPFT, FAARC<br>TechEd                            | Gary L. Myers, PhD<br>Centers for Disease Control and Prevention                   |
| Maria Carballo<br>Health Canada  | Valerie Ng, PhD, MD<br>Alameda County Medical Center/<br>Highland General Hospital |
| Russel K. Enns, PhD<br>Cepheid   | Klaus E. Stinshoff, Dr.rer.nat.<br>Digene (Switzerland) Sàrl                       |
| Mary Lou Gantzer, PhD<br>Dade Behring Inc.                             | James A. Thomas<br>ASTM International  |
| Lillian J. Gill, DPA<br>FDA Center for Devices and Radiological Health | Kiyooki Watanabe, MD<br>Keio University School of Medicine                         |
| Jeannie Miller, RN, MPH<br>Centers for Medicare & Medicaid Services    |  |

---

940 West Valley Road ▼ Suite 1400 ▼ Wayne, PA 19087 ▼ USA ▼ PHONE 610.688.0100

FAX 610.688.0700 ▼ E-MAIL: [customerservice@clsi.org](mailto:customerservice@clsi.org) ▼ WEBSITE: [www.clsi.org](http://www.clsi.org) ▼ ISBN 1-56238-616-6



(Formerly NCCLS)





---

---

**ICS 35.240.80**

Price based on 275 pages