**Earth-moving machinery — Machine
safety labels — General principles**

*Engins de terrassement — Étiquetage de sécurité de la machine —
Principes généraux*



Reference number
ISO 9244:2008(E)

© ISO 2008

PDF disclaimer

This PDF file may contain embedded typefaces. In accordance with Adobe's licensing policy, this file may be printed or viewed but shall not be edited unless the typefaces which are embedded are licensed to and installed on the computer performing the editing. In downloading this file, parties accept therein the responsibility of not infringing Adobe's licensing policy. The ISO Central Secretariat accepts no liability in this area.

Adobe is a trademark of Adobe Systems Incorporated.

Details of the software products used to create this PDF file can be found in the General Info relative to the file; the PDF-creation parameters were optimized for printing. Every care has been taken to ensure that the file is suitable for use by ISO member bodies. In the unlikely event that a problem relating to it is found, please inform the Central Secretariat at the address given below.



COPYRIGHT PROTECTED DOCUMENT

© ISO 2008

All rights reserved. Unless otherwise specified, no part of this publication may be reproduced or utilized in any form or by any means, electronic or mechanical, including photocopying and microfilm, without permission in writing from either ISO at the address below or ISO's member body in the country of the requester.

ISO copyright office
Case postale 56 • CH-1211 Geneva 20
Tel. + 41 22 749 01 11
Fax + 41 22 749 09 47
E-mail copyright@iso.org
Web www.iso.org

Published in Switzerland

Contents

Page

Foreword.....	viii
Introduction	ix
1 Scope	1
2 Normative references	1
3 Terms and definitions.....	1
4 Machine safety labels — Application, presentation and general requirements	4
4.1 Objectives	4
4.2 Location	4
4.3 Effective use	4
4.4 Operator's manuals	4
4.5 Formats	4
4.6 Hazard severity panel	7
4.7 Pictorials.....	7
4.8 Text in supplementary safety panel.....	9
4.9 Languages, translations and multi-language machine safety labels	9
5 Colours	10
5.1 Colour specifications	10
5.2 Hazard severity panels	11
5.3 Pictorials and safety signs	11
5.4 Supplementary safety information panels	11
5.5 Borders and panel separation lines.....	12
6 Dimensions.....	12
7 Examples of machine safety labels	16
7.1 With text.....	16
7.2 Without text	16
8 Graphical design of hazard pictorials.....	16
Annex A (informative) Examples of hazard description pictorials.....	17
Annex B (informative) Examples of hazard avoidance pictorials	30
Annex C (informative) Examples of machine safety labels without text	37
Annex D (informative) Principles and guidelines for graphic design of hazard and avoidance pictorials	55
Bibliography	71
Figure 1 — Two-panel combination machine safety label — With signal word	5
Figure 2 — Three-panel combination machine safety label — With signal word	6
Figure 3 — Two-panel combination machine safety label — Without signal word	6
Figure 4 — Meaning of hazard severity panels	7
Figure 5 — General prohibition sign.....	8
Figure 6 — STOP instruction.....	8
Figure 7 — Combined pictorial in single panel	8

Figure 8 — Safety shape for warning signs 9

Figure 9 — General warning sign 9

Figure 10 — Machine safety label without text — Read operator's manual 10

Figure 11 — Safety sign borders 12

Figure 12 — Recommended dimensions — Two-panel format 13

Figure 13 — Recommended dimensions — Three-panel format 14

Figure 14 — Recommended dimensions — Two-panel format 15

Figure A.1 — Poisonous fumes or toxic gases — Asphyxiation 17

Figure A.2 — Electrical shock/electrocution — General 17

Figure A.3 — Electrical shock/electrocution — Hand 18

Figure A.4 — Electrical shock/electrocution — Body 18

Figure A.5 — Electrical shock/electrocution — Loader 18

Figure A.6 — Electrical shock/electrocution — Excavator 18

Figure A.7 — Fall from high place 19

Figure A.8 — Fall from raised loader bucket 19

Figure A.9 — High pressure fluid — Injection into flesh 19

Figure A.10 — High pressure spray — Erosion of flesh 20

Figure A.11 — Hot surface — Burn to finger or hand 20

Figure A.12 — Hot fluid under pressure 20

Figure A.13 — Crushing of whole body — Force applied from above 21

Figure A.14 — Crushing of whole body — Force applied from behind 21

Figure A.15 — Crushing of whole body — Force applied from side 21

Figure A.16 — Crushing of whole body — Bidirectional force applied 21

Figure A.17 — Crushing of whole body — Loader bucket or lift arm 22

Figure A.18 — Crushing of whole body — Single directional pinned 22

Figure A.19 — Crushing of whole body — Excavator 22

Figure A.20 — Crushing of foot 22

Figure A.21 — Crushing of fingers or hand — Force applied from side 23

Figure A.22 — Crushing of fingers or hand — Force applied from above 23

Figure A.23 — Severing of fingers or hand — Impeller blade 23

Figure A.24 — Severing of fingers or hand — Engine fan 23

Figure A.25 — Severing of fingers or hand — Sharp object 24

Figure A.26 — Severing of foot 24

Figure A.27 — Severing of leg 24

Figure A.28 — Severing of head — Tool on rotating shaft 24

Figure A.29 — Hand and arm entanglement — Chain or toothed belt drive 25

Figure A.30 — Hand and arm entanglement — Belt drive 25

Figure A.31 — Hand and arm entanglement — Rotating gears 25

Figure A.32 — Hand and arm entanglement — Machinery 25

Figure A.33 — Hand and arm entanglement — Auger 26

Figure A.34 — Leg or foot entanglement — Auger	26
Figure A.35 — Full body entanglement — Machinery.....	26
Figure A.36 — Leg or foot entanglement or severing — Trencher.....	26
Figure A.37 — Thrown or flying objects — Face exposure.....	27
Figure A.38 — Thrown or flying objects — Full body exposure.....	27
Figure A.39 — Run-over.....	27
Figure A.40 — Machine rollover — Crush.....	28
Figure A.41 — Machine tip-over — Overload — Backhoe loader	28
Figure A.42 — Machine tip-over — Overload — Skid steer loader.....	28
Figure A.43 — Explosion (used, for example, with starter fluid)	29
Figure A.44 — Explosion of battery	29
Figure A.45 — Explosion of battery — Jump start.....	29
Figure B.1 — Read operator's manual.....	30
Figure B.2 — Read technical manual for proper service procedures	30
Figure B.3 — Stay safe distance from hazard — General	30
Figure B.4 — Stay safe distance from raised loader lift arm and bucket	31
Figure B.5 — Stay safe distance from electrical power lines.....	31
Figure B.6 — Stay safe distance from articulation area	31
Figure B.7 — Keep hands safe distance from hazard.....	31
Figure B.8 — Secure lifting cylinder with locking device before entering hazardous area.....	32
Figure B.9 — Attach support before entering hazardous area	32
Figure B.10 — Secure locking device before entering hazardous area. Read operator's manual.....	32
Figure B.11 — Insert safety lock before entering hazardous area	32
Figure B.12 — Wait until all machine components have completely stopped before touching them....	33
Figure B.13 — Do not jump start the engine.....	33
Figure B.14 — Shut off engine and remove key before performing maintenance or repair work	33
Figure B.15 — Do not ride on fender	34
Figure B.16 — Do not reach into crushing area	34
Figure B.17 — Do not stand under bucket.....	34
Figure B.18 — Do not loosen cap until cool	35
Figure B.19 — Do not step.....	35
Figure B.20 — No hands	35
Figure B.21 — No feet.....	35
Figure B.22 — No ether — Low temperature starting aid.....	36
Figure B.23 — Eye protection required	36
Figure B.24 — Face protection required	36
Figure B.25 — Wear seat belt	36
Figure C.1 — Stay safe distance from hazard — General	37
Figure C.2 — Crushing of whole body — Stay safe distance from raised loader lift arm and bucket	38

Figure C.3 — Crushing of whole body — Stay safe distance from articulation area..... 38

Figure C.4 — Crushing or pinning of whole body — Stay safe distance from hazard 39

Figure C.5 — Crushing of whole body — Stay safe distance from hazard 39

Figure C.6 — Thrown or flying objects — Stay safe distance from hazard 40

Figure C.7 — Crushing of whole body — Secure lift cylinder with locking device before entering hazardous area 40

Figure C.8 — Crushing of whole body — Attach support before entering hazardous area..... 41

Figure C.9 — Crushing of whole body — Insert safety lock before entering hazardous area..... 41

Figure C.10 — Crushing of whole body — Secure locking device before entering hazardous area — Read operator's manual 42

Figure C.11 — Crushing hazard — Run-over — Do not jump start engine..... 42

Figure C.12 — General safety alert — Shut off engine and remove key before performing maintenance or repair work 43

Figure C.13 — Electrical shock or electrocution — Stay safe distance from electrical power lines 43

Figure C.14 — Electrical shock or electrocution — Stay safe distance from electrical power source..... 44

Figure C.15 — Electrical shock or electrocution — Keep hands safe distance from electrical power source 44

Figure C.16 — Hot surface — Burn to finger or hand — Keep hands safe distance from hazard 45

Figure C.17 — High pressure fluid — Avoid fluid escaping under pressure — Read technical manual for proper service procedures 45

Figure C.18 — Explosion of battery — Read operator's manual..... 46

Figure C.19 — Explosion of battery — Jump start — Read operator's manual 46

Figure C.20 — Explosion hazard — No ether — Low temperature starting aid 47

Figure C.21 — Severing of fingers or hand — Keep hands safe distance from hazard 47

Figure C.22 — Severing of foot or leg — Keep feet and legs safe distance from hazard 48

Figure C.23 — Severing of foot — Keep feet safe distance from hazard 48

Figure C.24 — Severing of head — Read operator's manual 49

Figure C.25 — Arm or hand entanglement in auger — Keep hands and arms safe distance from hazard..... 49

Figure C.26 — Whole body entanglement in machinery — Stay safe distance from hazard..... 50

Figure C.27 — Leg or foot entanglement or severing — Stay safe distance from hazard 50

Figure C.28 — Crushing of feet — Keep feet safe distance from hazard 51

Figure C.29 — Crushing of fingers or hands — Keep hands safe distance from hazard..... 51

Figure C.30 — Crushing of whole body — Stay safe distance from raised loader lift arm and bucket..... 52

Figure C.31 — Crushing hazard due to machine rollover — Wear seat belt 52

Figure C.32 — Machine tip-over or overload — Read operator's manual..... 53

Figure C.33 — Tip-over or overload of skid steer loader — Read operator's manual 53

Figure C.34 — Avoid being run over — Do not ride on fender..... 54

Figure D.1 — Human figure unit system..... 56

Figure D.2 — Examples of human figure animation..... 57

Figure D.3 — Example of pictorial using both line and bold drawing human forms.....	58
Figure D.4 — Stationary, free-standing human figure	58
Figure D.5 — Examples of pictorials using head profile	59
Figure D.6 — Examples of pictorials showing upper torso.....	59
Figure D.7 — Full palm view hand	59
Figure D.8 — Adding hands to the human figure.....	60
Figure D.9 — Examples of pictorials using a human figure with hands.....	60
Figure D.10 — Examples of pictorials using hand profiles	61
Figure D.11 — Foot development.....	61
Figure D.12 — Adding feet to the human figure	62
Figure D.13 — Example of pictorial showing the human figure with feet.....	62
Figure D.14 — Examples of pictorials showing machine hazard	62
Figure D.15 — Examples of pictorials showing individual hazard-creating components	63
Figure D.16 — Arrow representing falling or flying objects and their direction of motion.....	64
Figure D.17 — Examples of pictorials with arrows representing falling or flying objects and their direction of motion	64
Figure D.18 — Arrow representing direction of motion of machine components.....	65
Figure D.19 — Example of pictorial with arrow representing direction of motion of machine components.....	65
Figure D.20 — Arrow representing direction of motion of entire machines.....	66
Figure D.21 — Example of pictorial representing direction of motion of entire machines.....	67
Figure D.22 — Arrow representing exertion of pressure or force	68
Figure D.23 — Examples of pictorials with arrows representing exertion of pressure or force	69
Figure D.24 — Arrow representing the idea of keeping a safe distance away from hazard	69
Figure D.25 — Examples of pictorials with arrows representing keeping a safe distance from a hazard	70
Figure D.26 — Example of pictorial using general prohibition sign to communicate prohibited action.....	70

Foreword

ISO (the International Organization for Standardization) is a worldwide federation of national standards bodies (ISO member bodies). The work of preparing International Standards is normally carried out through ISO technical committees. Each member body interested in a subject for which a technical committee has been established has the right to be represented on that committee. International organizations, governmental and non-governmental, in liaison with ISO, also take part in the work. ISO collaborates closely with the International Electrotechnical Commission (IEC) on all matters of electrotechnical standardization.

International Standards are drafted in accordance with the rules given in the ISO/IEC Directives, Part 2.

The main task of technical committees is to prepare International Standards. Draft International Standards adopted by the technical committees are circulated to the member bodies for voting. Publication as an International Standard requires approval by at least 75 % of the member bodies casting a vote.

Attention is drawn to the possibility that some of the elements of this document may be the subject of patent rights. ISO shall not be held responsible for identifying any or all such patent rights.

ISO 9244 was prepared by Technical Committee ISO/TC 127, *Earth-moving machinery*, Subcommittee SC 2, *Safety requirements and human factors*.

This second edition cancels and replaces the first edition (ISO 9244:1995), which has been technically revised.

Introduction

The purpose of this International Standard is to provide, for earth-moving machinery, general principles for the design and application of machine safety labels to alert persons to a hazard, describe the nature of that hazard, describe the consequences of potential injury from it, and instruct persons on how to avoid it. The continued growth in international trade and commerce has made it necessary to establish a universal communication method for conveying safety information.

This International Standard satisfies the global need to harmonize the system for conveying safety information using graphical means so that it relies as little as possible on the use of text messages. Machine safety labels that include text can be used when some of the necessary safety information cannot be communicated in graphical form.

Education is an essential part of any system that provides safety information. Although safety colours and signs are essential to any safety information system, they can be used only to supplement job site management practices such as proper working methods, instructions, accident prevention measures and training.

.....

Earth-moving machinery — Machine safety labels — General principles

1 Scope

This International Standard establishes general principles and gives requirements for the design and application of machine safety labels to be permanently affixed to earth-moving machinery as defined in ISO 6165. It outlines the objectives of signage, describes basic formats, specifies colours and provides guidance on developing the various panels that together constitute a label.

2 Normative references

The following referenced documents are indispensable for the application of this document. For dated references, only the edition cited applies. For undated references, the latest edition of the referenced document (including any amendments) applies.

ISO 6165, *Earth-moving machinery — Basic types — Identification and terms and definitions*

ISO 6750, *Earth-moving machinery — Operator's manual — Content and format*

3 Terms and definitions

For the purposes of this document, the following terms and definitions apply.

3.1

border

area between the edge of a sign and the panel

3.2

CAUTION

signal word used to indicate a potentially hazardous situation which, if not avoided, may result in minor or moderate injury

[ISO 3864-2]

3.3

combination machine safety label

combination of machine safety sign and/or supplementary safety information and/or hazard severity panel on one rectangular label

NOTE A combination machine safety label conveys one safety message.

NOTE Adapted from ISO 3864-2:2004, definition 3.2.

3.4
DANGER
signal word used to indicate an imminently hazardous situation which, if not avoided, will result in death or serious injury

[ISO 3864-2]

3.5
graphical symbol
visually perceptible figure with a particular meaning, used to transmit information independently of language

3.6
hazard
source of potential harm

[ISO 3864-2]

3.7
hazard avoidance pictorial
visual instruction for hazard avoidance

3.8
hazard description pictorial
visual description of the hazard and/or the consequences of not avoiding the hazard

3.9
hazard pictorial
visual description of the hazard, the consequences of not avoiding the hazard, and/or instructions for hazard avoidance

3.10
hazard severity panel
area of a combination or multiple machine safety label that communicates the category of risk associated with a hazard

NOTE 1 Adapted from ISO 3864-2:2004, definition 3.2.

3.11
label
sign carrier made from flexible material

3.12
machine safety label
label on a machine that informs the observer of one or more potential hazards and describes the safety precautions and/or actions required to avoid the hazard(s)

NOTE Adapted from ISO 17724:2003, definition 58.

NOTE It communicates a hazard, a hazardous situation, a precaution to avoid a hazard, and/or a result of not avoiding a hazard.

3.13
multiple machine safety label
machine safety label that contains two or more safety signs on the same rectangular label and, if used, the supplementary safety information and/or the hazard severity panel

NOTE 1 Adapted from ISO 3864-2:2004, definition 3.8.

3.14**panel**

component of a machine safety label that is clearly delineated by a line, border or margin

3.15**prohibition sign**

component of a machine safety label used to forbid a hazardous action

3.16**risk**

combination of the probability of occurrence of harm and the severity of that harm

[ISO/IEC Guide 51]

3.17**safety colour**

colour with special properties to which a safety meaning is attributed

[ISO 17724]

3.18**safety shape**

geometric shape to which a safety meaning is attributed

[ISO 7010]

3.19**safety sign**

sign which gives a general safety message, obtained by a combination of a colour and geometric shape and which, by the addition of a graphical symbol or hazard pictorial, gives a particular safety message

NOTE Adapted from ISO 3864-1:2002, definition 3.14.

3.20**signal word**

word that calls attention to a machine safety label and designates a category of risk

NOTE Adapted from ISO 3864-2:2004, definition 3.14.

3.21**supplementary safety information panel**

safety information symbol or safety information text whose main purpose is to provide additional clarification

NOTE A supplementary safety information panel typically communicates hazard consequence or hazard avoidance information.

[ISO 3864-2]

3.22**WARNING**

signal word used to indicate a potentially hazardous situation which, if not avoided, could result in death or serious injury

[ISO 3864-2]

4 Machine safety labels — Application, presentation and general requirements

4.1 Objectives

Machine safety labels are used

- a) to alert persons to a hazard,
- b) to describe the nature of the hazard,
- c) to explain the consequences of potential injury from the hazard, and
- d) to instruct persons how to avoid the hazard.

Machine safety labels without text can address requirements for multiple languages and the movement of machines from one country to another.

4.2 Location

Machine safety labels

- a) are located on the machine in the area near the hazards or in the control area from where the hazards can be prevented,
- b) are distinctive on the equipment,
- c) are placed in clearly visible locations,
- d) are protected to the greatest extent practicable from damage and obliteration, and
- e) have a reasonably long life expectancy considering environmental factors.

4.3 Effective use

Use machine safety labels that are relevant to the hazard. Care shall be taken to prevent excessive use of machine safety labels on the machine to avoid confusion. Their overuse can reduce their effectiveness.

4.4 Operator's manuals

Machine safety labels shall be repeated in operator's manuals according to ISO 6750 and in service and other technical manuals. Their application in manuals is not subject to the requirement against overuse given in 4.3.

4.5 Formats

A machine safety label shall be composed of a border surrounding two or more rectangular panels that convey information about hazards associated with the operation of a machine. Either a vertical or a horizontal configuration is acceptable. Final choice of format and configuration should be determined by the effective use of the available space. Machine safety labels may have either two or three panels, as shown in Figures 1 and 2. When more than one avoidance measure is applicable to a hazard, or when more than one hazard is applicable to an avoidance measure, additional panels may be added (multiple machine safety label). See 4.7.6.

4.5.1 Machine safety labels with signal word

Machine safety labels including a signal word (see 4.6.2) shall conform to one or the other of the following two basic types.

a) Two-panel combination machine safety label:

- 1) hazard severity panel;
- 2) supplementary safety information panel.

See Figure 1.

b) Three-panel combination machine safety label:

- 1) hazard severity panel;
- 2) safety sign;
- 3) supplementary safety information panel

See Figure 2.

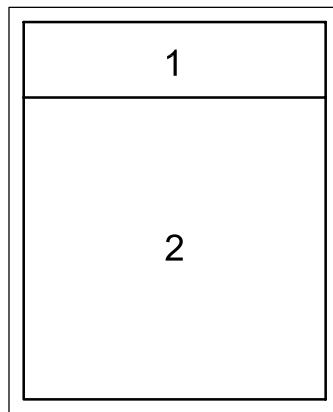

Key

- 1 hazard severity panel
- 2 supplementary safety information panel

Figure 1 — Two-panel combination machine safety label — With signal word

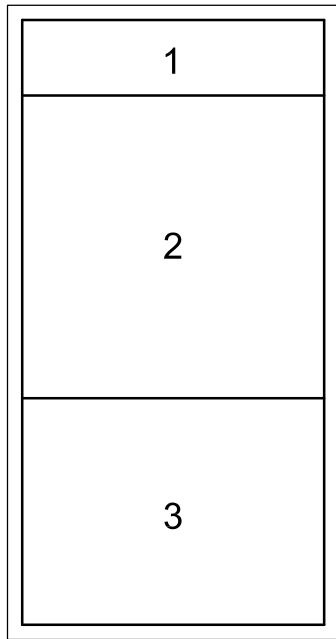

a) Vertical configuration

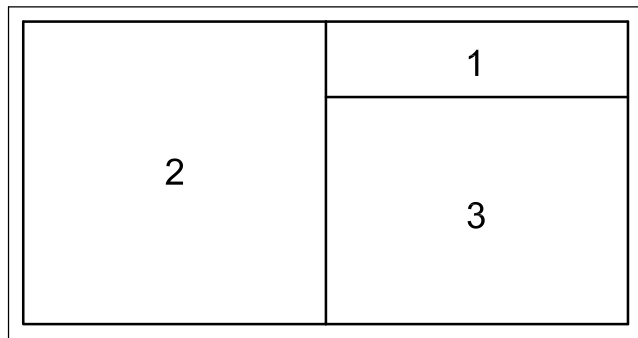

b) Horizontal configuration

Key

- 1 hazard severity panel
- 2 safety sign

- 3 supplementary safety information panel

Figure 2 — Three-panel combination machine safety label — With signal word

4.5.2 Machine safety labels without signal word

Those machine safety labels *without* a signal word shall consist only of two panels: a safety sign and a supplementary safety information panel. See Figure 3.

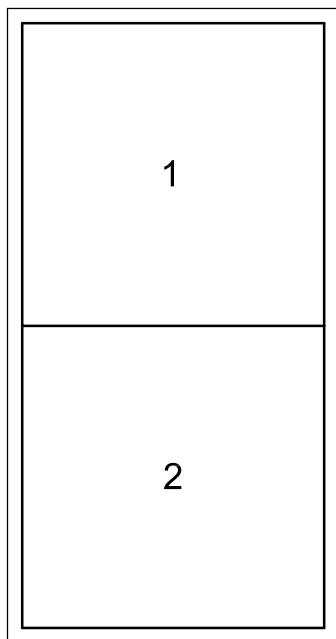

a) Vertical configuration

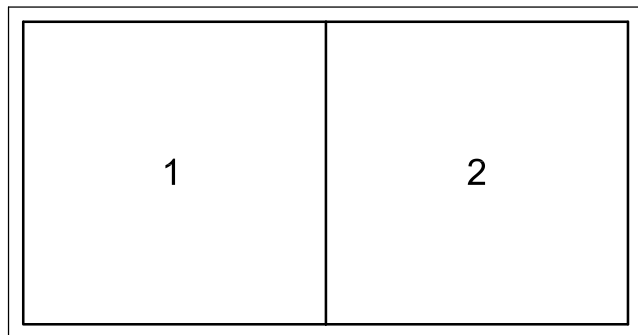

b) Horizontal configuration

Key

- 1 safety sign

- 2 supplementary safety information panel

Figure 3 — Two-panel combination machine safety label — Without signal word

4.6 Hazard severity panel

4.6.1 The hazard severity panel consists of a general warning sign followed by one of three signal words, as shown in Figure 4 (for colours, see 5.2).

4.6.2 The three signal words are DANGER, WARNING and CAUTION. Each alerts the viewer to the existence and relative seriousness of a hazard. They are reserved for personal injury hazards.

The signal word DANGER shall be used sparingly and only for those situations presenting the most serious hazards. Hazards identified by WARNING present a lesser degree of risk of injury or death than those identified by DANGER.

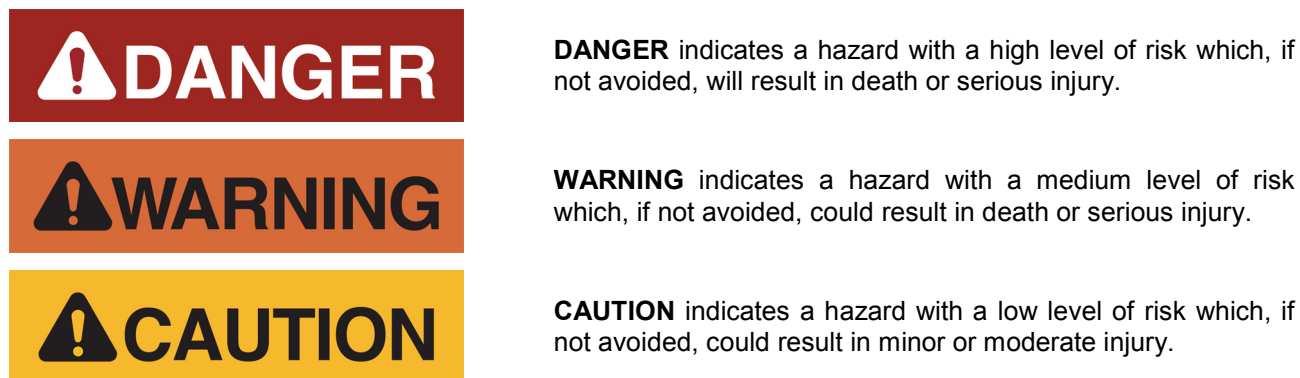

Figure 4 — Meaning of hazard severity panels

4.7 Pictorials

4.7.1 Hazard description pictorials

A hazard description pictorial clearly identifies the hazard and portrays the potential consequences of a failure to follow instructions. On machine safety labels without a signal word, the hazard description pictorial shall be in the safety sign panel. See Annex A for examples of suitable hazard description pictorials. Alternative hazard description pictorials, if used, should conform to the objectives and principles as stated in this International Standard.

4.7.2 Hazard avoidance pictorials

A hazard avoidance pictorial clearly identifies the actions necessary to avoid interaction of persons with the hazard. A hazard avoidance pictorial may be used to supplement or to replace a text message in the supplementary safety information panel. See Annex B for examples of suitable hazard avoidance pictorials. Alternative hazard avoidance pictorials, if used, should conform to the objectives and principles as stated in this International Standard.

4.7.3 General prohibition sign

4.7.3.1 Prohibition of an activity shall be indicated using the general prohibition sign (functional reference P001 according to ISO 7010), shown in Figure 5. See Annex D for further information.

4.7.3.2 Hazard avoidance pictorials often communicate the concept of a specific prohibited action, or that a person's presence in a specified location can be hazardous. A black graphical symbol or hazard pictorial inside a red circular band with a red diagonal bar defines a safety sign that indicates that an action shall not be taken or shall be stopped. Some examples of the general prohibition sign used with pictorials are shown in Annex C.

4.7.3.3 Sizing of the general prohibition sign depends on how it is used with a particular pictorial. It is important that it be sufficiently large to be easily recognized, but care shall be taken to avoid obscuring any important portion of the pictorial.



Figure 5 — General prohibition sign

4.7.4 STOP instruction

The word STOP may be used to convey the instruction to stop an activity. It shall be shown in red. See Figure 6.



Figure 6 — STOP instruction

4.7.5 Combined pictorials

In specific circumstances, a hazard description pictorial and a hazard avoidance pictorial may be combined in a single-panel safety sign. An example is shown in Figure 7.



Figure 7 — Combined pictorial in single panel

4.7.6 Multiple-hazard pictorials

In a few cases, a pictorial may address more than one hazard. In general, however, avoid addressing more than one hazard by a single pictorial unless the hazards are closely related.

4.7.7 Safety shape for warning signs

4.7.7.1 This triangle safety shape is shown in Figure 8. Use this with pictorials for warning signs without signal words. A black graphical symbol or hazard pictorial inside a yellow triangle with a black triangular band defines a safety sign that indicates a hazard. For examples, see Figure 9 and Annex C.



Figure 8 — Safety shape for warning signs

4.7.7.2 If pictorials are not used inside the safety shape, use the general warning sign (functional reference W001 according to ISO 7010), consisting of the triangle with an exclamation mark (see Figure 9), as the safety sign.



Figure 9 — General warning sign

4.8 Text in supplementary safety panel

Text used within the supplementary safety information panel shall convey the nature of the hazard, possible consequences and means of avoidance. One or more of these text elements may be deleted if its information is adequately communicated by a pictorial.

4.9 Languages, translations and multi-language machine safety labels

4.9.1 Machine safety labels containing a signal word and/or text message should be in one of the languages of the country where the machine is to be used.

4.9.2 Machine safety labels without text require no language translation; however, where used, they shall have both of the following:

- a) appropriate text messages, corresponding to the respective safety signs without text, printed in the operator's manual in the appropriate language;
- b) the general warning sign with a pictorial instructing the operator to read the operator's manual for an explanation of the safety signs applicable to that machine (see Figure 10).



Figure 10 — Machine safety label without text — Read operator's manual

5 Colours

5.1 Colour specifications

The colours used in machine safety labels shall be in accordance with Table 1. The permitted colours are red, orange, yellow, white and black.

Table 1 — Safety or background colours and contrast colours used in machine safety labels

Colour	Chromaticity coordinates of corner points determining the permitted colour area for standard illuminant D65 and CIE 2° standard observer				
		1	2	3	4
Red ^a	<i>x</i>	0,660	0,610	0,700	0,735
	<i>y</i>	0,340	0,340	0,250	0,265
Orange ^b	<i>x</i>	0,590	0,552	0,532	0,567
	<i>y</i>	0,410	0,398	0,418	0,432
Yellow ^a	<i>x</i>	0,494	0,470	0,493	0,522
	<i>y</i>	0,505	0,480	0,457	0,477
White ^c	<i>x</i>	0,350	0,305	0,295	0,340
	<i>y</i>	0,360	0,315	0,325	0,370
Black ^c	<i>x</i>	0,385	0,300	0,260	0,345
	<i>y</i>	0,355	0,270	0,310	0,395

For references from colour order systems, see ISO 3864-1:2002, Annex A.

^a Values taken from ISO 3864-1:2002, Table 3.



^b Values taken from ISO 3864-2:2004, Table 2.

^c Values taken from ISO 3864-1:2002, Table 2.

5.2 Hazard severity panels

The colours of the hazard severity panel, which shall be in accordance with Table 2, depend on the signal word used. The font used for the signal word may be one of the following or a font with similar legibility: Arial, Arial Bold, Helvetica, Helvetica Bold, Folio Medium, Franklin Gothic, Futura, News Gothic Bold, Meta Bold, or Univers.

Table 2 — General meaning and use of colours in hazard severity panels

Background colour of panel	Contrast colour	Meaning/Use	Hazard severity panel illustration
Red	White	DANGER hazard severity panel to identify a high level of risk	
Orange	Black	WARNING hazard severity panel to identify a medium level of risk	
Yellow	Black	CAUTION hazard severity panel to identify a low level of risk	

5.3 Pictorials and safety signs

5.3.1 Pictorials used in machine safety labels together with hazard severity panels shall be black on a white background.

5.3.2 Pictorials used in machine safety labels together with the triangular safety shape/general warning sign shall be black on a yellow background.

5.3.3 Other colours (e.g. red to indicate fire) may be used to emphasize specific aspects of a pictorial.

5.3.4 The general prohibition sign specified in 4.7.3, to be used with pictorials, shall be red, as shown in Figure 5. See Annex D for more information.

5.4 Supplementary safety information panels

5.4.1 The supplementary safety information panels of those machine safety labels that include a signal word shall have white letters on a black background or black letters on a white background.

5.4.2 The supplementary safety panels of those machine safety labels that do not include a signal word shall have black letters on a yellow or a white background.

5.5 Borders and panel separation lines

5.5.1 If necessary to differentiate a hazard severity panel from the colour of the surface on which it is affixed, a border in the corresponding contrast colour according to Table 2 may be used.

5.5.2 The borders of safety signs using the warning sign specified in 4.7.7 shall be yellow. If necessary to differentiate the safety sign from the colour of the surface on which it is affixed, a second outside border of white or black may be used. Examples are shown in Figure 11.

5.5.3 Panel separation lines shall be black.

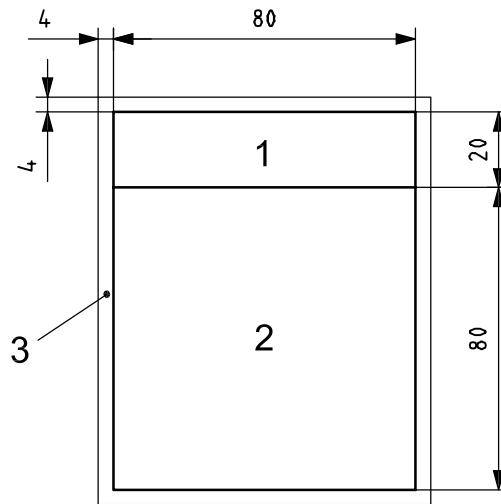

Figure 11 — Safety sign borders

6 Dimensions

The recommended dimensions of machine safety labels are shown in Figures 12 to 14. Smaller or larger sizes may be used as required. Proportions may be varied as necessary to provide a sufficiently large signal panel or to provide adequate space for the message panel to be set in a legible size type.

Dimensions in millimetres

**Key**

- 1 hazard severity panel
- 2 supplementary safety information panel
- 3 border

The corners of a machine safety label may have a small radius proportional in size to the label's dimensions. The line width of the border may be adjusted based on the size of the panels, background contrast and visual clarity.

Figure 12 — Recommended dimensions — Two-panel format

Dimensions in millimetres

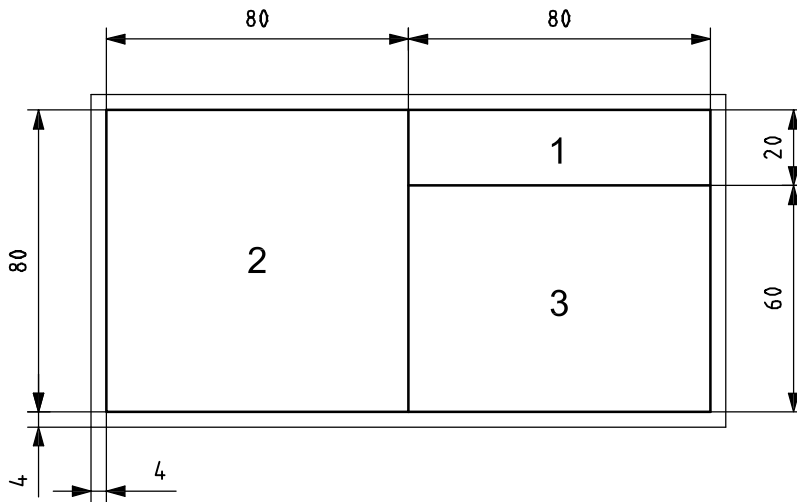

a) Horizontal configuration

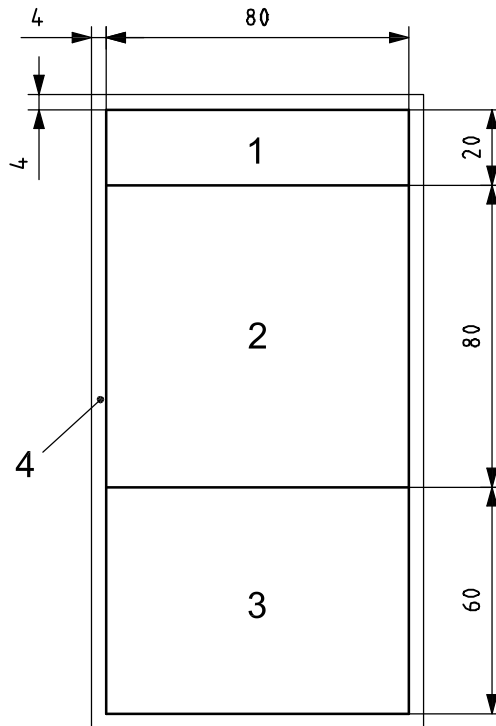

b) Vertical configuration

Key

- 1 hazard severity panel
- 2 safety sign
- 3 supplementary safety information panel
- 4 border

The corners of a machine safety label may have a small radius proportional in size to the label's dimensions. The line width of the border may be adjusted based on the size of the panels, background contrast and visual clarity.

Figure 13 — Recommended dimensions — Three-panel format

Dimensions in millimetres

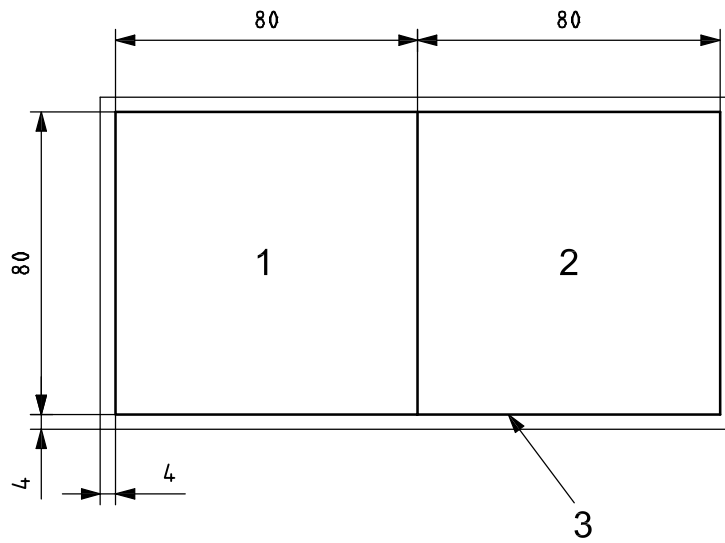

a) Horizontal configuration

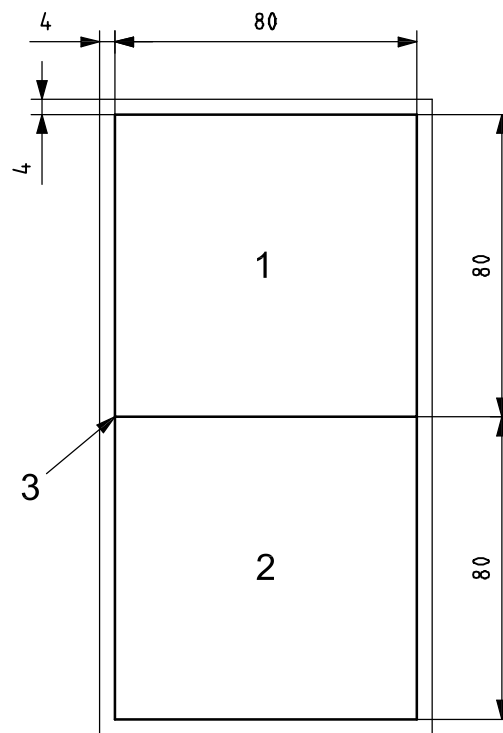

b) Vertical configuration

Key

- 1 safety sign
- 2 supplementary safety information panel
- 3 border

The corners of a machine safety label may have a small radius proportional in size to the label's dimensions. The line width of the border may be adjusted based on the size of the panels, background contrast and visual clarity.

Figure 14 — Recommended dimensions — Two-panel format

7 Examples of machine safety labels

7.1 With text

The signal word and text appropriate to a hazard depend upon a combination of highly variable factors. For this reason, no detailed examples of safety signs with text are presented in this International Standard. Where necessary, machine safety labels with text should be developed in accordance with the objectives and principles as stated in this International Standard.

7.2 Without text

Annex C presents examples of machine safety labels without text for a number of hazards. Alternative machine safety labels, if used, shall conform with the objectives and principles stated in this International Standard.

8 Graphical design of hazard pictorials

Annex D presents principles and guidelines for good graphic design of hazard pictorials as well as instructions for drawing the human figure and other pictorial elements. Consistent visual design is important for conveying the meaning of both hazard description pictorials and hazard avoidance pictorials.

Annex A (informative)

Examples of hazard description pictorials

A.1 General

This annex presents examples of hazard description pictorials intended for the safety signs of machine safety labels. Alternative hazard description pictorials, if used, should conform to the objectives and principles as stated in this International Standard.

A.2 Chemical (ingestion or burn) hazards

See Figure A.1.

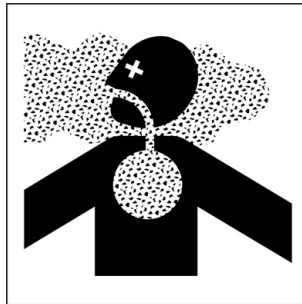

Figure A.1 — Poisonous fumes or toxic gases — Asphyxiation

A.3 Electrical (shock or burn) hazards — Electrical shock or electrocution

See Figures A.2 to A.6.

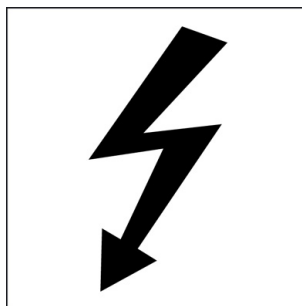

Figure A.2 — Electrical shock/electrocution — General



Figure A.3 — Electrical shock/electrocution — Hand



Figure A.4 — Electrical shock/electrocution — Body

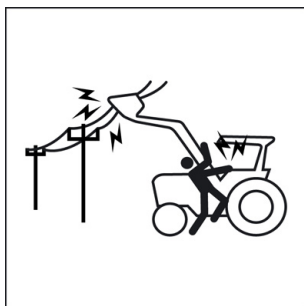

Figure A.5 — Electrical shock/electrocution — Loader

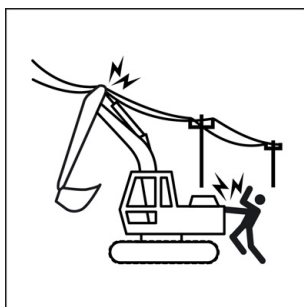

Figure A.6 — Electrical shock/electrocution — Excavator

A.4 Fall hazards

See Figures A.7 and A.8.



Figure A.7 — Fall from high place

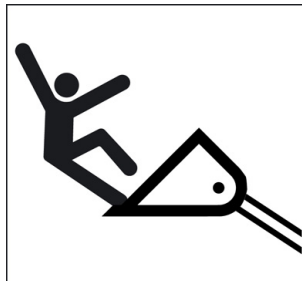

Figure A.8 — Fall from raised loader bucket

A.5 Fluid (injection, leak or spray) hazards

See Figures A.9 and A.10.

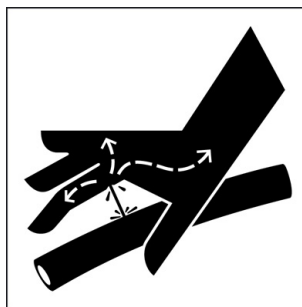

Figure A.9 — High pressure fluid — Injection into flesh



Figure A.10 — High pressure spray — Erosion of flesh

A.6 Thermal (burn or contact) hazards

See Figures A.11 and A.12.



Figure A.11 — Hot surface — Burn to finger or hand

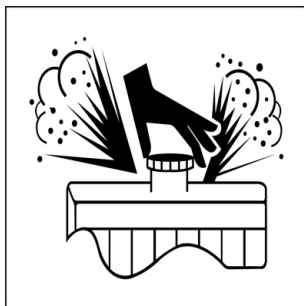

Figure A.12 — Hot fluid under pressure

A.7 Mechanical hazards — Crushing hazards

See Figures A.13 to A.22.



Figure A.13 — Crushing of whole body — Force applied from above



Figure A.14 — Crushing of whole body — Force applied from behind

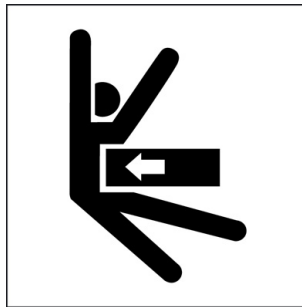

Figure A.15 — Crushing of whole body — Force applied from side

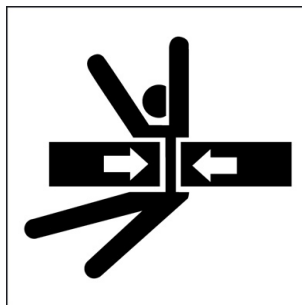

Figure A.16 — Crushing of whole body — Bidirectional force applied

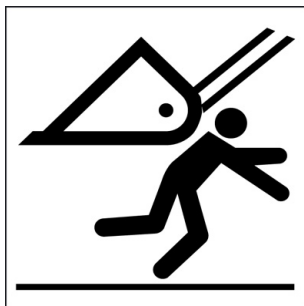

Figure A.17 — Crushing of whole body — Loader bucket or lift arm



Figure A.18 — Crushing of whole body — Single directional pinned

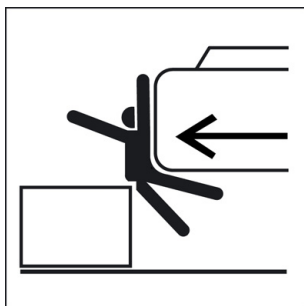

Figure A.19 — Crushing of whole body — Excavator

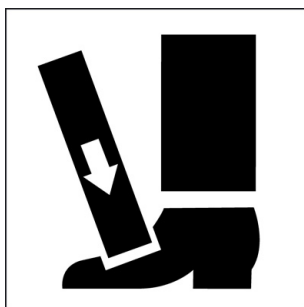

Figure A.20 — Crushing of foot

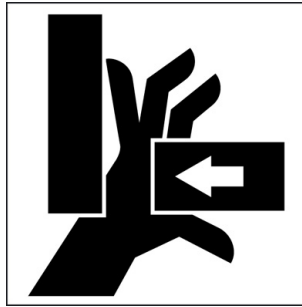

Figure A.21 — Crushing of fingers or hand — Force applied from side

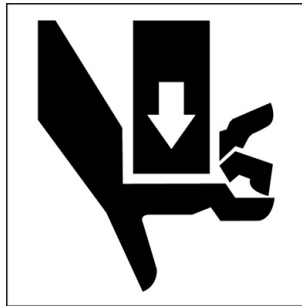

Figure A.22 — Crushing of fingers or hand — Force applied from above

A.8 Mechanical hazards — Cut hazards

See Figures A.23 to A.28.



Figure A.23 — Severing of fingers or hand — Impeller blade

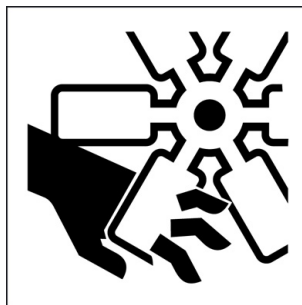

Figure A.24 — Severing of fingers or hand — Engine fan

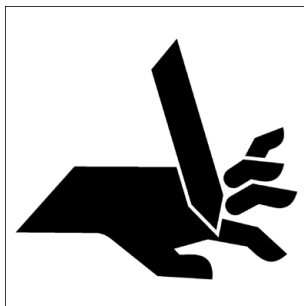

Figure A.25 — Severing of fingers or hand — Sharp object

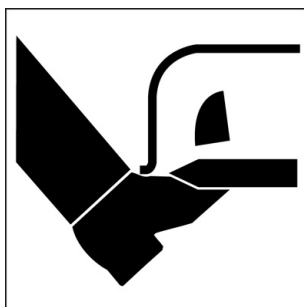

Figure A.26 — Severing of foot

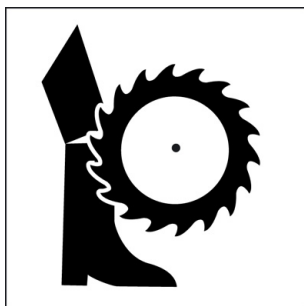

Figure A.27 — Severing of leg



Figure A.28 — Severing of head — Tool on rotating shaft

A.9 Mechanical — Entanglement hazards

See Figures A.29 to A.36.

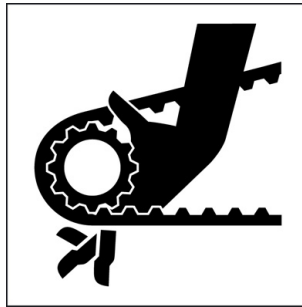

Figure A.29 — Hand and arm entanglement — Chain or toothed belt drive



Figure A.30 — Hand and arm entanglement — Belt drive

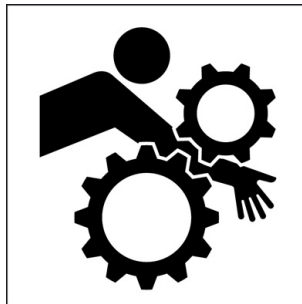

Figure A.31 — Hand and arm entanglement — Rotating gears



Figure A.32 — Hand and arm entanglement — Machinery



Figure A.33 — Hand and arm entanglement — Auger



Figure A.34 — Leg or foot entanglement — Auger



Figure A.35 — Full body entanglement — Machinery



Figure A.36 — Leg or foot entanglement or severing — Trencher

A.10 Mechanical hazards — Thrown or flying object hazards

See Figures A.37 and A.38.

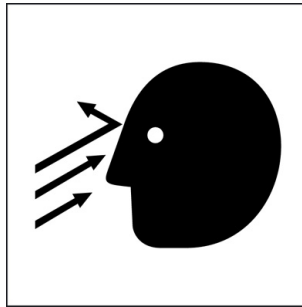

Figure A.37 — Thrown or flying objects — Face exposure



Figure A.38 — Thrown or flying objects — Full body exposure

A.11 Run-over and/or strike hazards

A.11.1 Run-over

See Figure A.39 a) and b). Other machine outlines are permitted.



a)



b)

Figure A.39 — Run-over

A.11.2 Stability

See Figures A.40 to A.42.

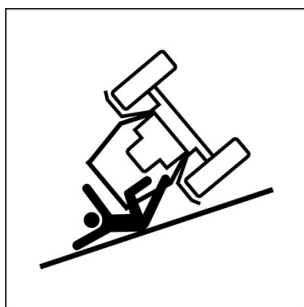

Figure A.40 — Machine rollover — Crush

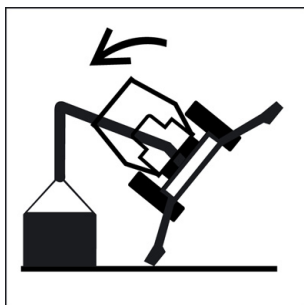

Figure A.41 — Machine tip-over — Overload — Backhoe loader

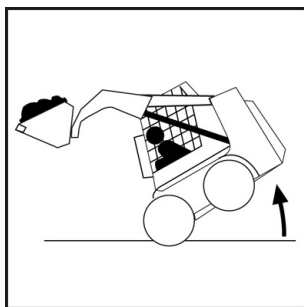

Figure A.42 — Machine tip-over — Overload — Skid steer loader

A.12 Thermal (combustion or explosion) hazards

See Figures A.43 to A.45.

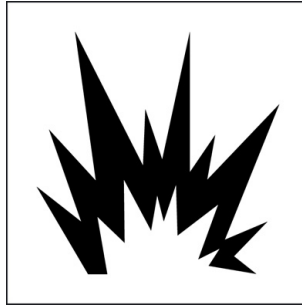

Figure A.43 — Explosion (used, for example, with starter fluid)

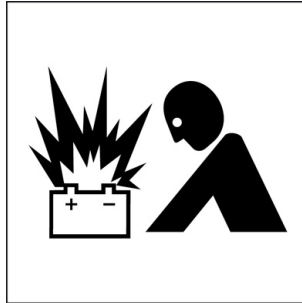

Figure A.44 — Explosion of battery

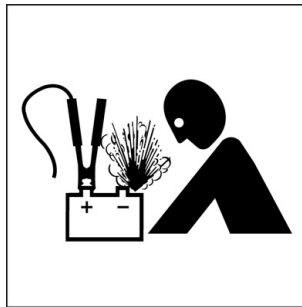

Figure A.45 — Explosion of battery — Jump start

Annex B (informative)

Examples of hazard avoidance pictorials

B.1 General

This annex presents examples of hazard avoidance pictorials intended for the supplementary safety information panels of machine safety labels. Alternative hazard avoidance pictorials, if used, should conform to the objectives and principles stated in this International Standard.

B.2 Read manuals

See Figures B.1 and B.2.

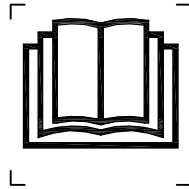

Figure B.1 — Read operator's manual

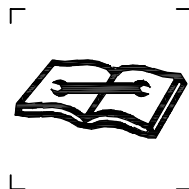

Figure B.2 — Read technical manual for proper service procedures

B.3 Stay safe distance from hazard

See Figures B.3 to B.7.

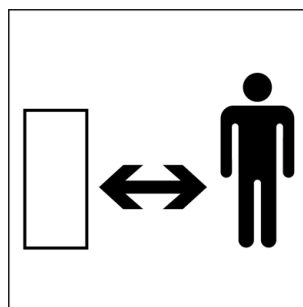

Figure B.3 — Stay safe distance from hazard — General

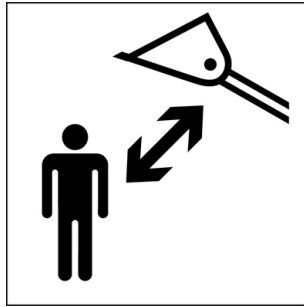

Figure B.4 — Stay safe distance from raised loader lift arm and bucket

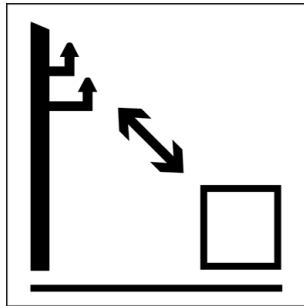

Figure B.5 — Stay safe distance from electrical power lines

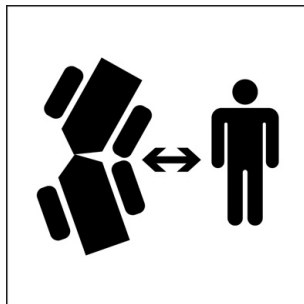

Figure B.6 — Stay safe distance from articulation area

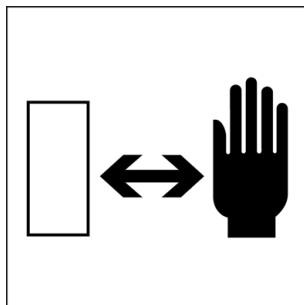

Figure B.7 — Keep hands safe distance from hazard

B.4 Secure lifting and/or locking device

See Figures B.8 to B.11.

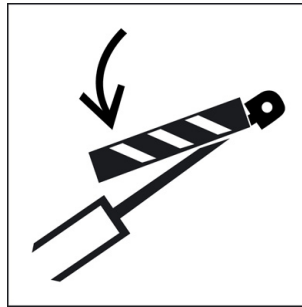

Figure B.8 — Secure lifting cylinder with locking device before entering hazardous area

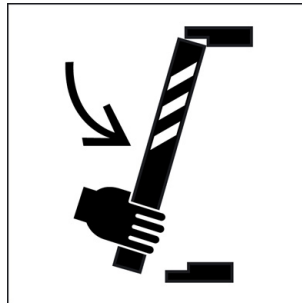

Figure B.9 — Attach support before entering hazardous area



Figure B.10 — Secure locking device before entering hazardous area. Read operator's manual.



Figure B.11 — Insert safety lock before entering hazardous area

B.5 Wait until all moving machine components have completely stopped

See Figure B.12.



Figure B.12 — Wait until all machine components have completely stopped before touching them

B.6 Do not jump start engine

See Figure B.13.



Figure B.13 — Do not jump start engine

B.7 Shut off engine and remove key before maintenance or repairs

See Figure B.14.

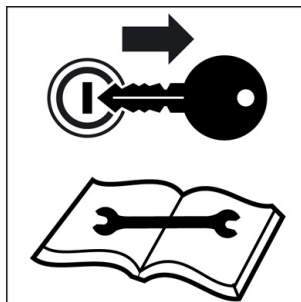

Figure B.14 — Shut off engine and remove key before performing maintenance or repair work

B.8 Do not ride on fender

See Figure B.15.



NOTE Riding on the machine is allowed only on a provided seat.

Figure B.15 — Do not ride on fender

B.9 Do not reach into, stand in, or loosen within hazardous area

See Figures B.16 to B.18.



Figure B.16 — Do not reach into crushing area



Figure B.17 — Do not stand under bucket



Figure B.18 — Do not loosen cap until cool

B.10 Prohibit

See Figures B.19 to B.22.



Figure B.19 — Do not step

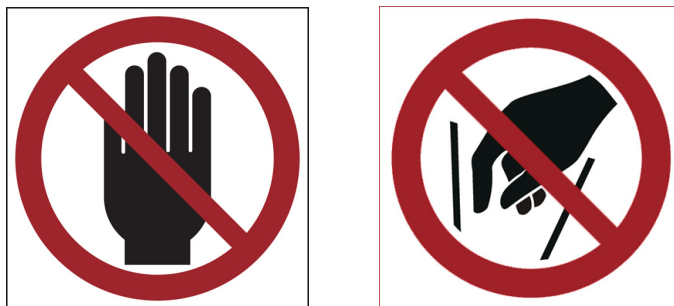

Figure B.20 — No hands



Figure B.21 — No feet



Figure B.22 — No ether — Low temperature starting aid

B.11 Thrown or flying objects

See Figures B.23 and B.24.

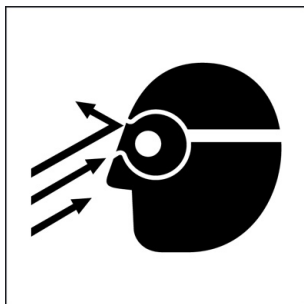

Figure B.23 — Eye protection required

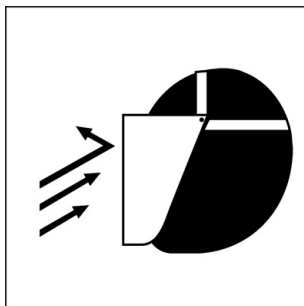

Figure B.24 — Face protection required

B.12 Wear seat belt

See Figure B.25.



Figure B.25 — Wear seat belt

Annex C (informative)

Examples of machine safety labels without text

C.1 General

This annex presents examples of machine safety labels, without text, for a number of hazards. These examples are in the vertical-configuration, two-panel format (see Figure 3).

The text description for each safety sign provides a sample of explanatory text appropriate for inclusion in the operator's manual. The operator's manual text may be expanded or otherwise adapted as required for the specific application.

C.2 Stay safe distance from hazard

See Figures C.1 to C.6.



Figure C.1 — Stay safe distance from hazard — General



Figure C.2 — Crushing of whole body — Stay safe distance from raised loader lift arm and bucket



Figure C.3 — Crushing of whole body — Stay safe distance from articulation area



Figure C.4 — Crushing or pinning of whole body — Stay safe distance from hazard

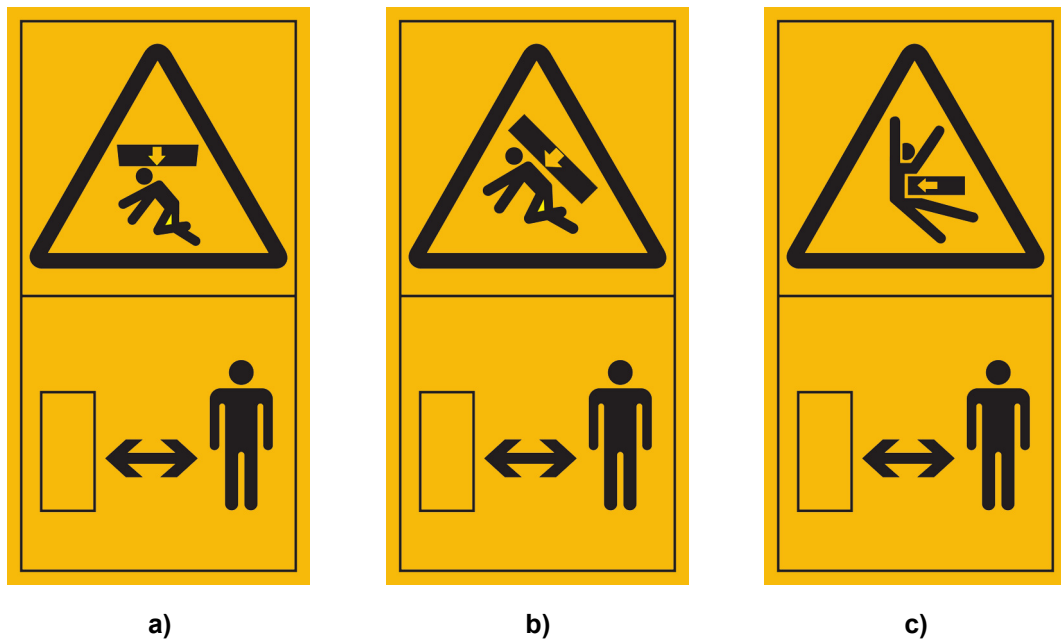

Figure C.5 — Crushing of whole body — Stay safe distance from hazard



Figure C.6 — Thrown or flying objects — Stay safe distance from hazard

C.3 Secure locking device

See Figures C.7 to C.10.



Figure C.7 — Crushing of whole body — Secure lift cylinder with locking device before entering hazardous area



Figure C.8 — Crushing of whole body — Attach support before entering hazardous area



Figure C.9 — Crushing of whole body — Insert safety lock before entering hazardous area



Figure C.10 — Crushing of whole body — Secure locking device before entering hazardous area — Read operator's manual

C.4 Start engine from operator seat

See Figure C.11.



Figure C.11 — Crushing hazard — Run-over — Do not jump start engine

C.5 Shut off engine

See Figure C.12.

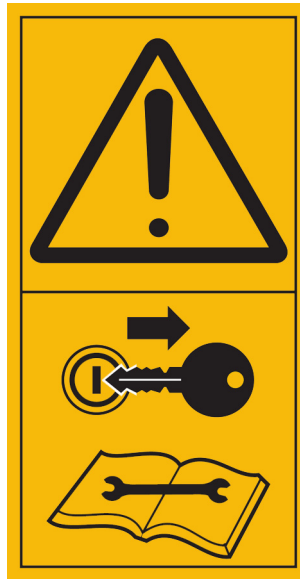

Figure C.12 — General safety alert — Shut off engine and remove key before performing maintenance or repair work

C.6 Stay safe distance from electrical power

See Figures C.13 to C.15.

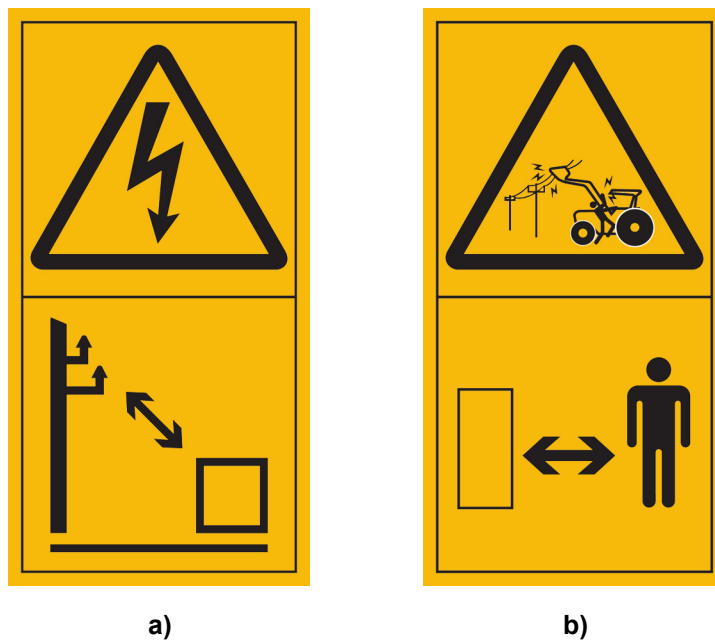

Figure C.13 — Electrical shock or electrocution — Stay safe distance from electrical power lines



Figure C.14 — Electrical shock or electrocution — Stay safe distance from electrical power source



Figure C.15 — Electrical shock or electrocution — Keep hands safe distance from electrical power source

C.7 Stay clear of hot surface

See Figure C.16.



Figure C.16 — Hot surface — Burn to finger or hand — Keep hands safe distance from hazard

C.8 Avoid fluid under pressure

See Figure C.17.



Figure C.17 — High pressure fluid — Avoid fluid escaping under pressure — Read technical manual for proper service procedures

C.9 Avoid explosion

See Figures C.18 to C.20.



Figure C.18 — Explosion of battery — Read operator's manual



Figure C.19 — Explosion of battery — Jump start — Read operator's manual



Figure C.20 — Explosion hazard — No ether — Low temperature starting aid

C.10 Avoid area that could sever limbs

See Figures C.21 to C.24.



Figure C.21 — Severing of fingers or hand — Keep hands safe distance from hazard

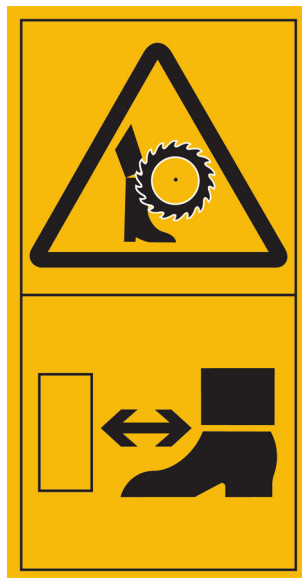

Figure C.22 — Severing of foot or leg — Keep feet and legs safe distance from hazard



Figure C.23 — Severing of foot — Keep feet safe distance from hazard



Figure C.24 — Severing of head — Read operator's manual

C.11 Avoid area of entanglement

See Figures C.25 to C.27.



Figure C.25 — Arm or hand entanglement in auger — Keep hands and arms safe distance from hazard



Figure C.26 — Whole body entanglement in machinery — Stay safe distance from hazard



Figure C.27 — Leg or foot entanglement or severing — Stay safe distance from hazard

C.12 Avoid crushing area

See Figures C.28 to C.31.



Figure C.28 — Crushing of feet — Keep feet safe distance from hazard

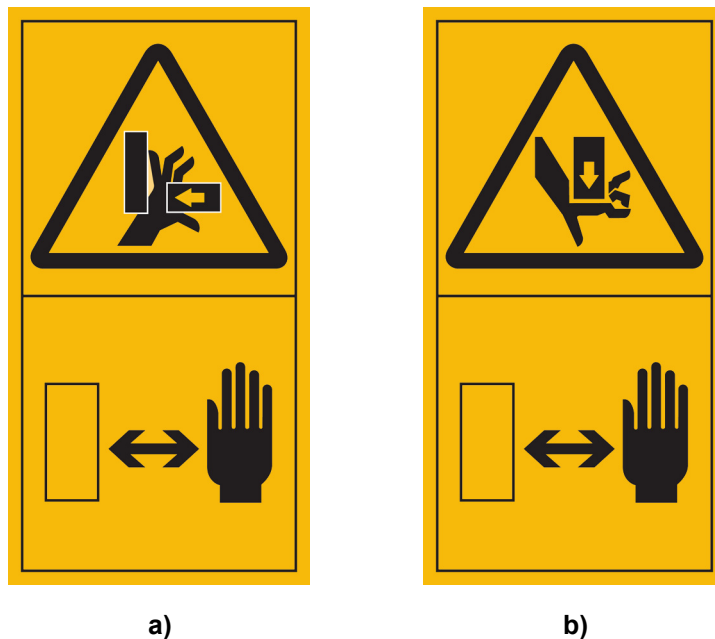

a)

b)

Figure C.29 — Crushing of fingers or hands — Keep hands safe distance from hazard



Figure C.30 — Crushing of whole body — Stay safe distance from raised loader lift arm and bucket



Figure C.31 — Crushing hazard due to machine rollover — Wear seat belt

C.13 Avoid tip-over

See Figures C.32 and C.33.



Figure C.32 — Machine tip-over or overload — Read operator's manual



Figure C.33 — Tip-over or overload of skid steer loader — Read operator's manual

C.14 Avoid being run over

See Figure C.34.



Riding on the machine is allowed only on a provided seat.

Figure C.34 — Avoid being run over — Do not ride on fender

www.iso.org

Annex D (informative)

Principles and guidelines for graphic design of hazard and avoidance pictorials

D.1 General

This annex provides principles and guidelines for good graphic design of hazard and avoidance pictorials, as well as instructions for drawing the human figure and other pictorial elements. Good consistent visual design is important for conveying the meaning of both hazard description and hazard avoidance pictorials.

D.2 Guidelines for creating pictorials

Although each safety sign and safety sign pictorial shall be considered on its own terms, a number of general guidelines for good pictorial design may be articulated.

- Use representational pictorials rather than abstract symbols.
- Use a solid graphical representation of human body elements or the full human figure. An outline representation may be used when depicting a person whose presence is necessary to complete the pictorial but who is not directly involved with the hazard.
- When objects, faces or the full human body are shown, use the view (generally front or side) that is most easily recognized.
- Use pictorials depicting dramatic action and showing the involvement of the human figure or body elements with the hazard.
- Use a simplified graphical representation of the machine elements that create the hazard. Use filled (solid) graphics of the hazardous machine elements, unless these filled areas detract from easy recognition of the human figure. Use outline graphics of complete machines or of substantial portions of machines to locate hazardous areas or machine elements in context.
- Be specific in depicting hazards, especially when the nature or location of the hazard is not readily apparent. Be generic in depicting hazards and hazardous situations only when generality is possible and adequately communicates the necessary information.
- Use arrows where necessary to show actual or potential movement. In some cases, movement of a machine component is implicit in the pictorial graphics and arrows need not be added. Be consistent in selecting and using alternative arrow graphics to represent different types of movement or spatial relationships: falling or flying objects, direction of motion of machine components, direction of motion of entire machines, the exertion of pressure or force, and keeping a safe distance away from a hazard. See D.8.
- Avoid using the prohibition symbols (diagonal cross, circle with diagonal bar) where the symbol would obscure identification of the prohibited action or where the meaning of the prohibition symbol is not explicitly clear.
- Do not use red to represent blood.

D.3 Human figure

D.3.1 Drawing the basic human figure

The human figure is frequently the main component in the pictorial. Depict it in a simple but believable form. For the greatest long-range benefit, it should always be pictured consistently. Interpretation should be instantaneous and not require the viewer to study the pictorial to determine which part of the body is involved or how it is involved. The human figure presented here was designed to satisfy these specific requirements. Therefore, it should not be distorted or repropotioned, except as noted in D.3.3. Its purposes are to alert persons who see the safety sign and to help avoid accidents, not to be an artistic presentation.

D.3.2 Human figure unit system

The standard pictorial figure is based on a grid system of squares of uniform size or “units”. The full human figure is 12 units tall, 2 units wide at the trunk, and has a circular head 1,75 units in diameter. The precise unit measurements for drawing the figure are shown in Figure D.1. The hands and feet end in semicircles.

Dimensions in units

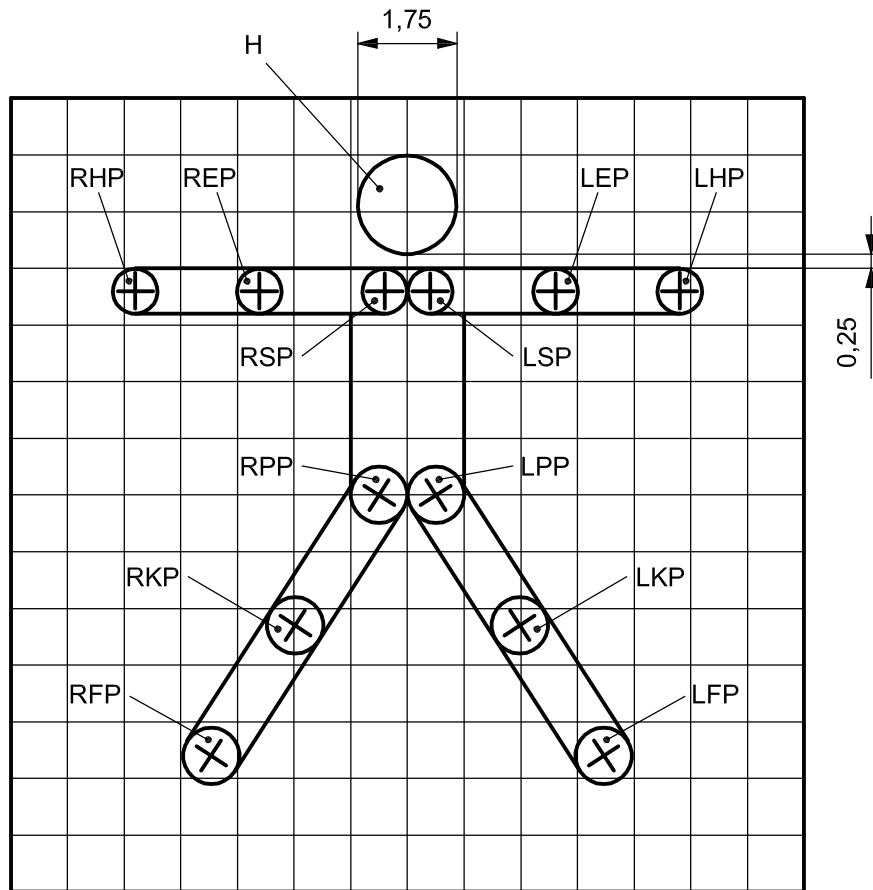

Key

- | | | | |
|-----|---------------------|-----|----------------------|
| H | head | RFP | right foot pivot |
| LEP | left elbow pivot | RKP | right knee pivot |
| LHP | left hand pivot | RPP | right hip pivot |
| LSP | left shoulder pivot | RSP | right shoulder pivot |
| LPP | left hip pivot | RHP | right hand pivot |
| LKP | left knee pivot | REP | right elbow pivot |
| LFP | left foot pivot | | |

Figure D.1 — Human figure unit system

D.3.3 Human figure animation

Action or movement of the figure can be depicted by using pivot points shown in Figure D.1. The unit proportions remain the same, except in situations where the overlapping of limbs causes a visual foreshortening of the limbs. When foreshortening occurs, it is compensated for by adding 0,5 unit to the limb. Figure D.2 shows the human figure in various positions. The position the figure will assume in the pictorial is usually determined by

- the nature of the hazard,
- the direction or orientation of the hazard,
- movements or positions resulting from involvement with the hazard,
- the type of injury caused by the hazard, and
- movements or positions involved in the operation of equipment.



Figure D.2 — Examples of human figure animation

D.3.4 Bold representation versus outline drawing of human figure

This bold representation of the human form is more effective than a line drawing of the same human form in focusing the observer's attention on the person whose potentially hazardous situation is the subject of the pictorial. However, if more than one human figure appears in the pictorial, a person not directly exposed to the hazard may be a line drawing.

EXAMPLE The driver of a machine in a run-over hazard pictorial or a falling rider hazard pictorial.

The line drawing of a human figure should be used

- only for representing persons not directly at risk in the hazardous situation, or
- only when, by being combined with the bold human form, the combination results in a pictorial that is easier to understand and communicates better.

Figure D.3 shows a pictorial in which both line and bold drawing human forms are used.

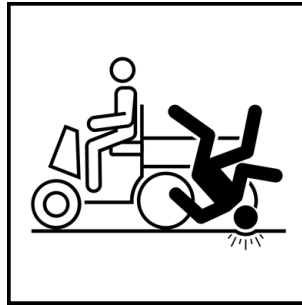

Figure D.3 — Example of pictorial using both line and bold drawing human forms

D.3.5 Stationary, free-standing human figure (viewed from front or rear)

The standard pictorial human figure is modified when the person is depicted in a stationary, free-standing position. The IEC symbol denoting “Heavy (obese) patient — For use on medical equipment” (IEC 60417 symbol number 5391) is used as the pictorial human figure in hazard avoidance pictorials that communicate the idea of keeping a safe distance away from a hazard (see D.8.6) and in some hazard avoidance pictorials that communicate the idea of keeping away from a hazardous location (see D.9). Figure D.4 shows the stationary, free-standing human figure.

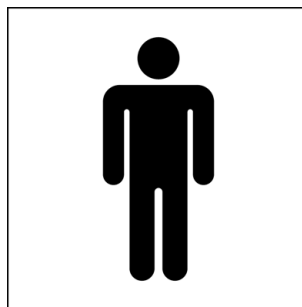

Figure D.4 — Stationary, free-standing human figure

D.3.6 Profile head

Whenever the head is involved with the hazard, the profile version is used facing either left or right. The profile head can also be used whenever the full figure or upper torso is to appear in profile to create an impression that the figure or torso itself is in the profile position. Figure D.5 gives examples of hazard pictorials that use the profile head.

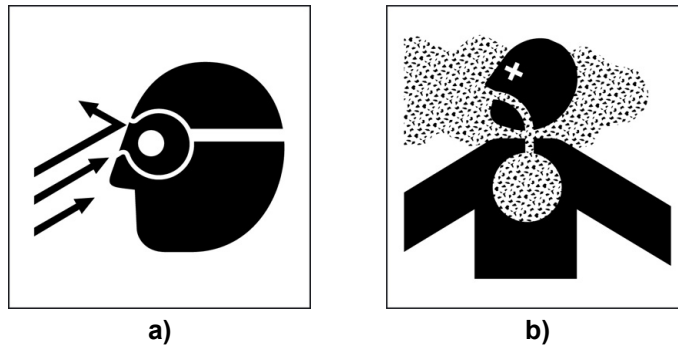

Figure D.5 — Examples of pictorials using head profile

D.4 Upper torso

Hazards that involve the arms, hands or head can best be dramatized by using the upper torso rather than the full torso. In most cases, the upper torso would appear in profile and the profile head would be used rather than the frontal or circular head. When depicted in a profile position, the upper torso can also be effective in conveying directional movement with the hazard. If hands are involved in the hazard, or if the depiction of hands would aid in visual dramatization, they should be added to the figure (see D.5.2). Figure D.6 gives examples of hazard pictorials that use the upper torso.

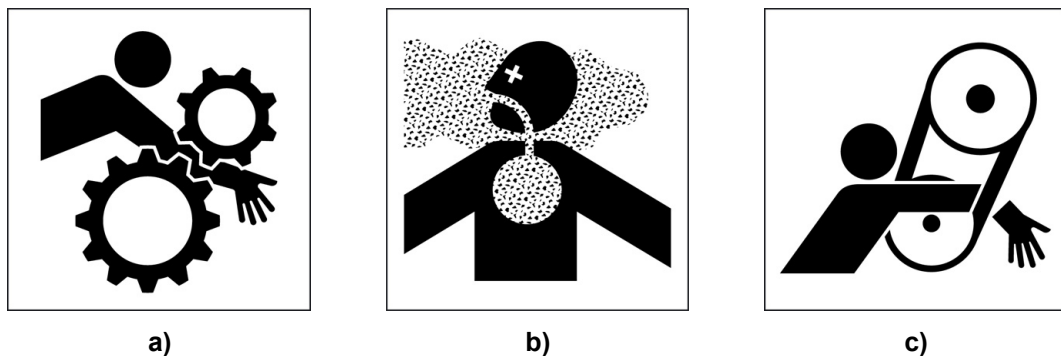

Figure D.6 — Examples of pictorials showing upper torso

D.5 Hands

D.5.1 Drawing the human hand and fingers

The complexity of the human hand and the many possible finger movements make hands one of the most difficult pictorial elements to work with. The design shown in Figure D.7 gives careful attention to the simplification of shape and form for easy recognition. In the full palm view, the fingers and thumb do not move to other positions. In other full-hand views, fingers may be spread.

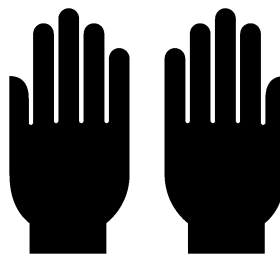

Figure D.7 — Full palm view hand

D.5.2 Adding hands to a human figure

When hazards involve the hands or arms, hands are added to the figure to increase the recognition value of the limb elements. Two basic hand positions are shown in Figure D.8:

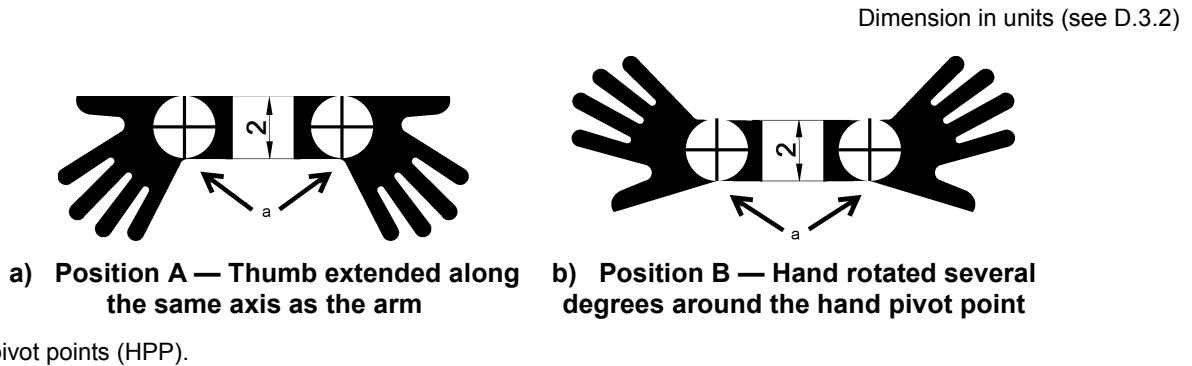

Figure D.8 — Adding hands to the human figure

D.5.3 Pictorials using a human figure with hands

Selection of position A versus position B (Figure D.8) should be based on which of the positions is judged to best dramatize the involvement with the hazard. For design consistency, hands are added to both arms (when both arms are shown) even when only one arm is involved with the hazard. See Figure D.9 for examples of hazard pictorials where hands have been added to the human figure.

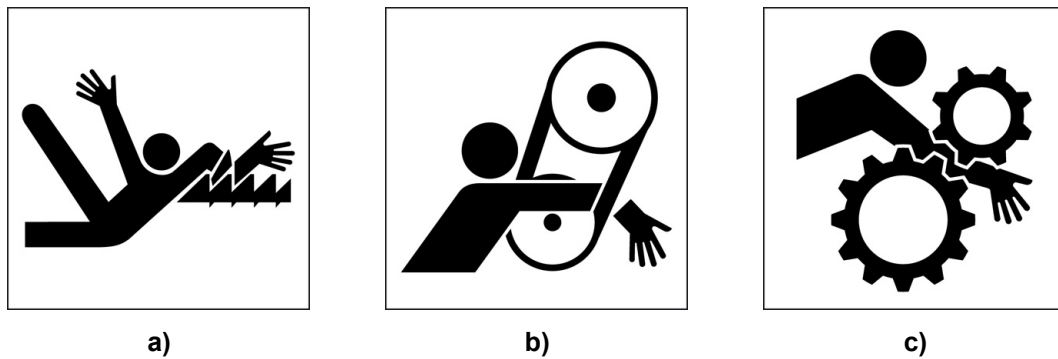

Figure D.9 — Examples of pictorials using a human figure with hands

D.5.4 Hand profiles

Hand profiles are used to convey a feeling of depth, which can add realism, dramatization and comprehensibility to the pictorial. Although the hand is not actually drawn in perspective, the positioning of the fingers can create a three-dimensional impression.

Hand profiles are the most difficult elements of the human figure to design. The hand profiles shown in Figure D.10 represent the design style to be used in pictorials to maintain visual consistency. Valuable time can be saved when creating hand profiles by taking existing pictorials and modifying or repositioning elements of the hand as necessary. Situations that require various finger movements can be depicted by selecting the hand closest to the desired position and modifying it. Note the finger treatment. The fingers are not tapered, although they may appear to be. Fingertips are created using a quarter circle. The profile view uses only three fingers plus the thumb.

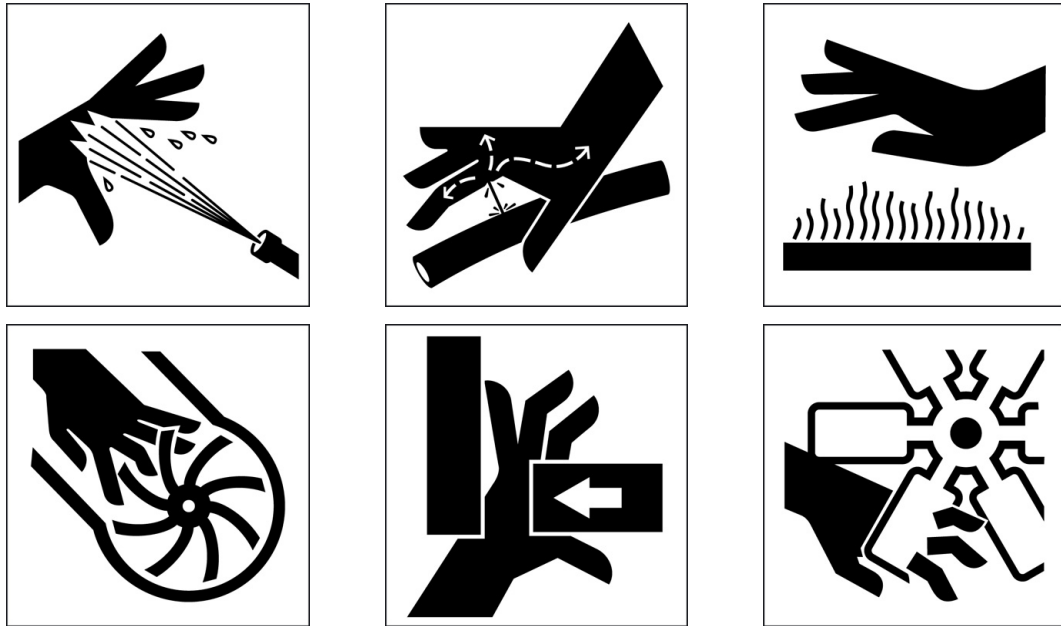

Figure D.10 — Examples of pictorials using hand profiles

D.6 Feet

D.6.1 Foot development

When a pictorial illustrates only the lower leg or foot, the stylized shoe or boot (foot) shown in Figure D.11 should be used. It can be used facing either left or right.

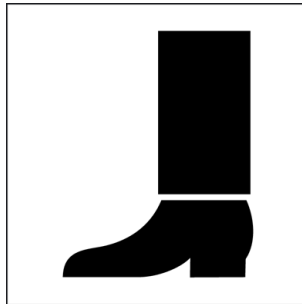
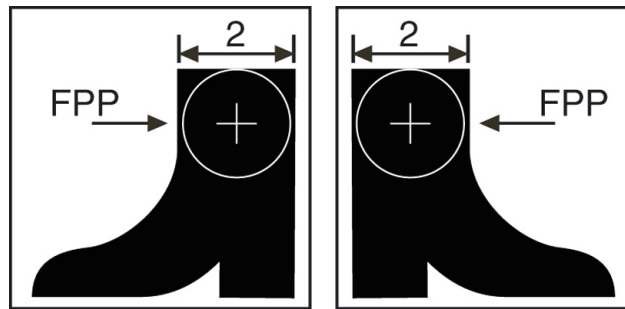

Figure D.11 — Foot development

D.6.2 Adding feet to the human figure

Some hazards that involve the feet or lower limbs are most effectively dramatized by using the full human figure: adding feet to the figure increases recognition value of the limb elements. For such pictorials, the feet shown in Figure D.12 should be added to the foot pivot points. For design consistency, they should not be altered or distorted. Figure D.13 gives an example of a hazard pictorial where feet have been added to the human figure.

Dimensions in units (see D.3.2)



Key
FPP foot pivot point

Figure D.12 — Adding feet to the human figure



Figure D.13 — Example of pictorial showing the human figure with feet

D.7 Representation of machines, equipment and components

In general, use outline representations for whole machines or substantial portions of machines. This is to avoid large filled (black) areas that may detract from recognition of the human figure relative to the machine or the hazard-creating component or equipment on the machine — especially relevant when the human figure is depicted in close proximity to the machine representation. Representations of individual components may be outline or filled, depending upon which alternative provides better visual recognition and graphical clarity. In general, filled areas result in the perception of greater mass and solidity; however, outlines of machines often encourage inclusion of enough graphical detail that the identity of actual components and the nature of the hazards they present can be discerned more easily. Smaller filled areas, or outlines using a wider line thickness, can assist in highlighting the hazard-creating component or equipment on a machine.

Figure D.14 gives examples of pictorials that use whole machines or major components of machines in their graphical description of hazards.

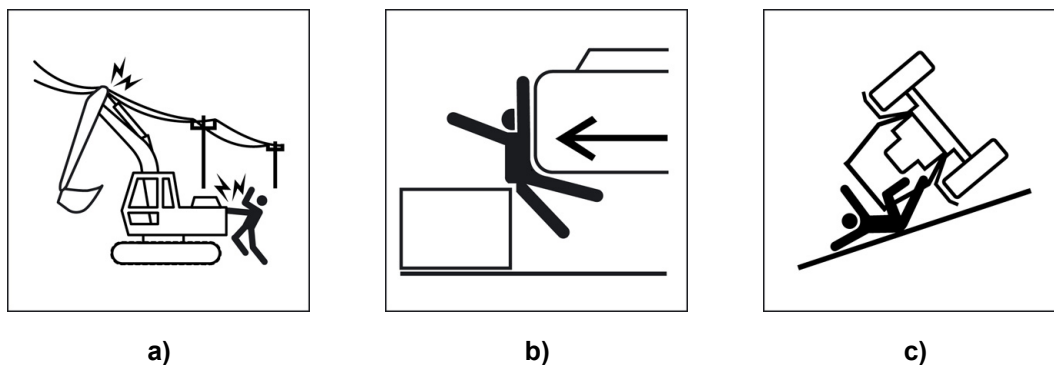

Figure D.14 — Examples of pictorials showing machine hazard

Figure D.15 gives examples of pictorials that use individual hazard-creating machine components, not in the context of their machine location, in their graphical description of hazards.

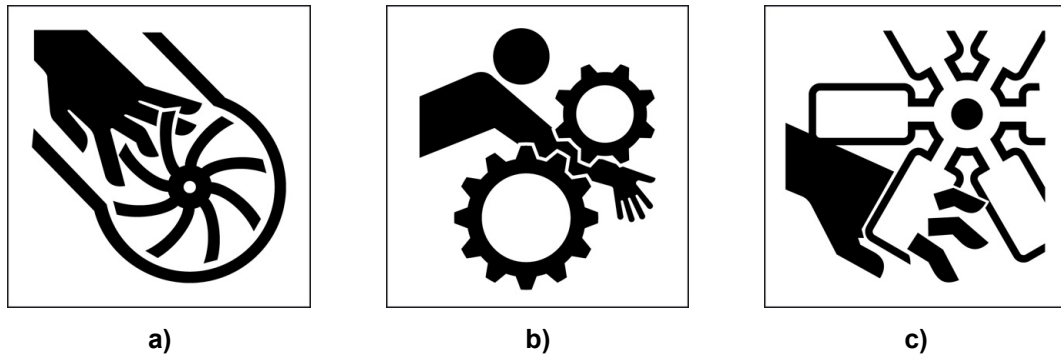

Figure D.15 — Examples of pictorials showing individual hazard-creating components

D.8 Arrows

D.8.1 Using arrows

In order to communicate basic safety sign information, use visual elements to represent a variety of things, conditions and ideas. Important among these are flying or falling objects and their direction of motion, the direction of motion of machine components, the direction of motion of entire machines, the exertion of pressure or force and the idea of keeping a safe distance away from a hazard. Five types of arrow design are used to denote these elements of pictorial communication.

D.8.2 Arrows representing falling or flying objects and their direction of motion

A black arrow on a white background (for safety signs with text) or a black arrow on a yellow background (for safety signs without text) is generally used. It can be straight, angled or curved. The tail of the arrow should appear solid when a single object or a few objects are involved; the tail should be broken when a continuous barrage of objects or particles is involved. The arrowhead has a 45° included angle. The length of the arrow shaft may be 7,65 units or lengthened as needed. See Figure D.16 for arrow dimensions. This arrow is normally sized in proportion to the size of the falling or flying object that it represents in a given pictorial. Figure D.17 gives examples of hazard pictorials that use this arrow to represent falling or flying objects and their direction of motion.

Dimensions in units (see D.3.2)

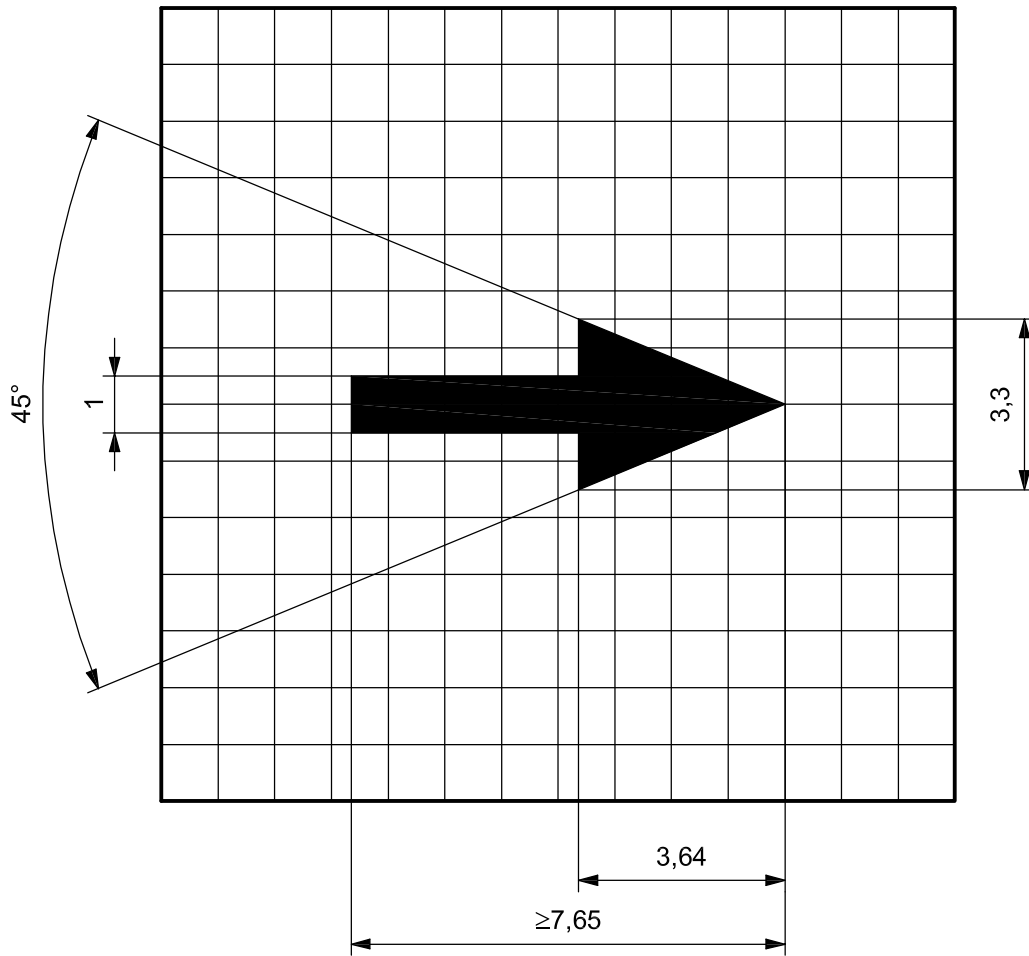

Figure D.16 — Arrow representing falling or flying objects and their direction of motion

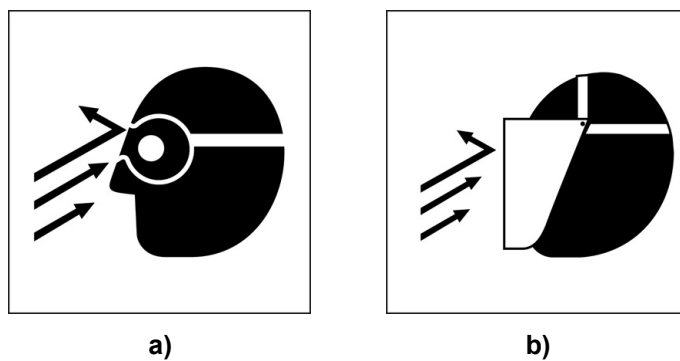

Figure D.17 — Examples of pictorials with arrows representing falling or flying objects and their direction of motion

D.8.3 Arrows representing direction of motion of machine components

A black arrow on a white background (for safety signs with text) or a black arrow on a yellow background (for safety signs without text) is generally used. It can be straight, angled or curved. See Figure D.18 for arrow dimensions. This arrow is normally used at 100 % of actual size as shown in Figure D.18, although it may be sized differently as appropriate to individual pictorials. The arrowhead has a 60° included angle. The length of

the arrow shaft may be 5,25 units or lengthened as needed. Figure D.19 gives an example of a hazard pictorial that uses this arrow to represent the direction of motion of machine components. Because relative line thickness is the only significant difference between the arrows in Figure D.18 and Figure D.20, situations may arise when the two arrows appear almost identical. When possible, however, use the arrow in Figure D.18 to represent the direction of motion of machine components and the arrow in Figure D.20 to represent the direction of motion of entire machines.

Dimensions in units (see D.3.2)

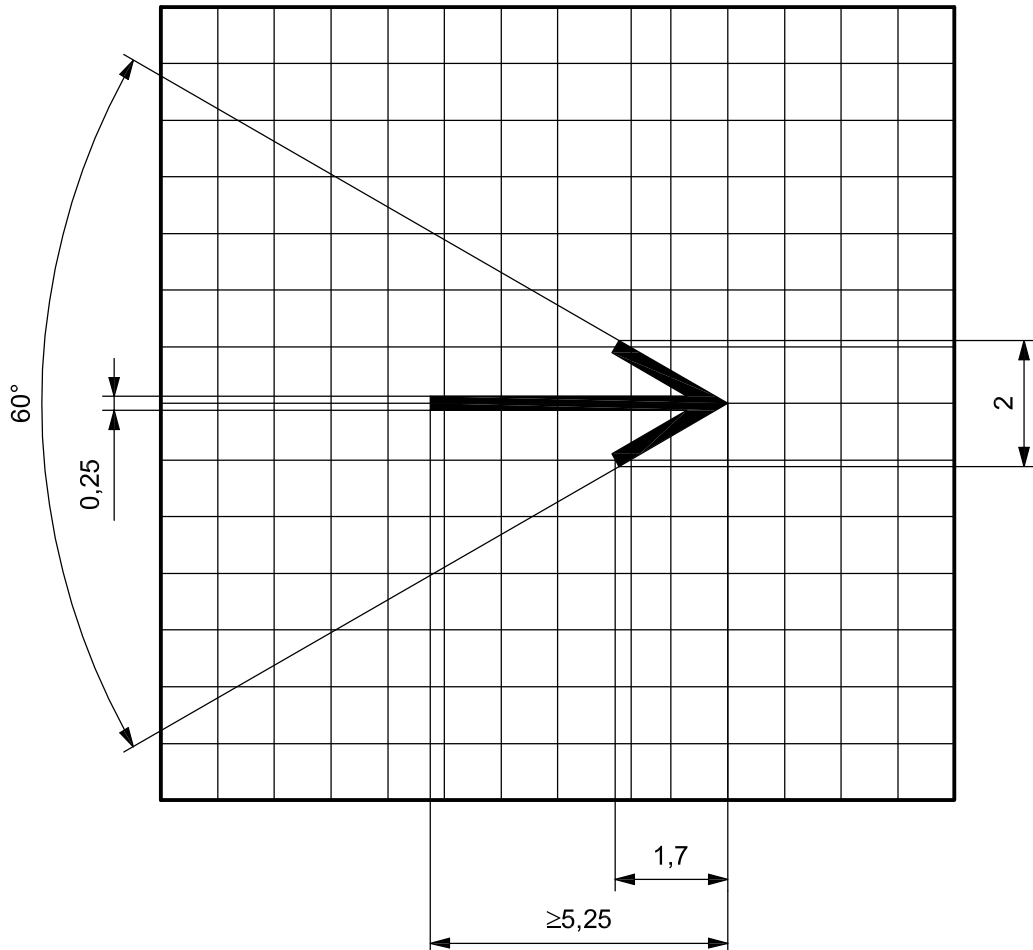

Figure D.18 — Arrow representing direction of motion of machine components

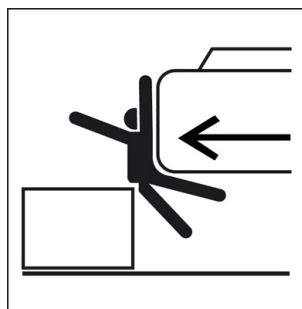

Figure D.19 — Example of pictorial with arrow representing direction of motion of machine components

D.8.4 Arrows representing direction of motion of entire machines

A black arrow on a white background (for safety signs with text) or a black arrow on a yellow background (for safety signs without text) is generally used. It can be straight, angled or curved. See Figure D.20 for arrow dimensions. This arrow is normally used at 100 % of the actual size as shown in Figure D.20, although it may be sized differently as appropriate to individual pictorials. The arrowhead has a 60° included angle. The length of the arrow shaft may be 5.25 units or lengthened as needed. Figure D.21 gives an example of a hazard pictorial that uses this arrow to represent the direction of motion of an entire machine. Because relative line thickness is the only significant difference between the arrow in Figure D.18 and the one in Figure D.20, situations may arise when the two arrows appear almost identical. Whenever possible, use the arrow in Figure D.18 to represent the direction of motion of machine components and the arrow in Figure D.20 to represent the direction of motion of entire machines.

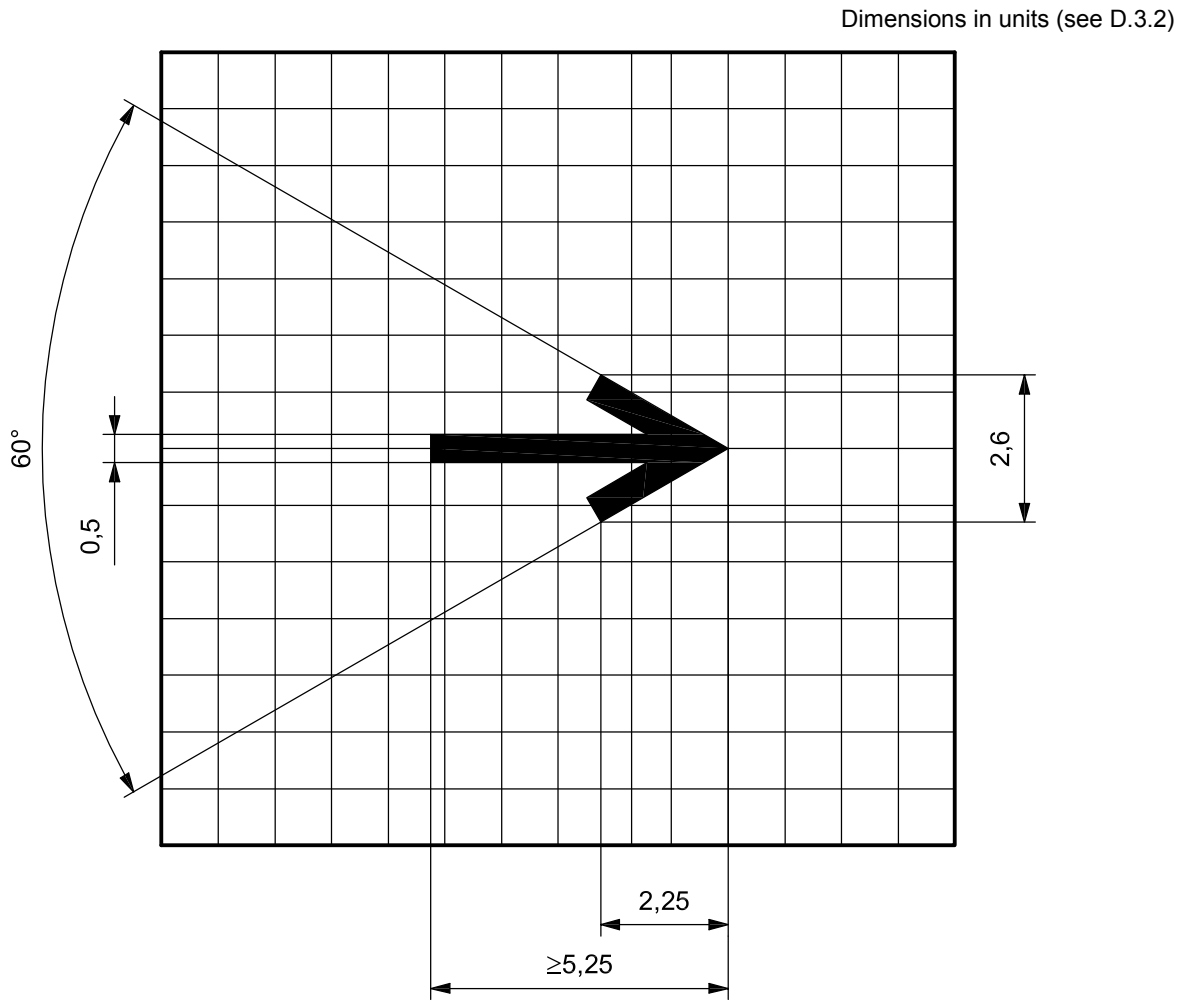

Figure D.20 — Arrow representing direction of motion of entire machines



Figure D.21 — Example of pictorial representing direction of motion of entire machines

D.8.5 Arrows representing exertion of pressure or force

A white arrow in a black silhouette representing the source of the force or pressure is generally used. It may also appear as a black arrow on a white background when the specific source of the force or pressure is depicted. See Figure D.22 for arrow dimensions. This arrow is normally used at 100 % of the actual size as shown in Figure D.22, although it may be sized differently as appropriate to individual pictorials. The arrowhead has an 84° included angle. The length of the arrow shaft may be 6,2 units or lengthened as needed. Figure D.23 gives examples of hazard pictorials that use a pressure or force arrow.

Dimensions in units (see D.3.2)

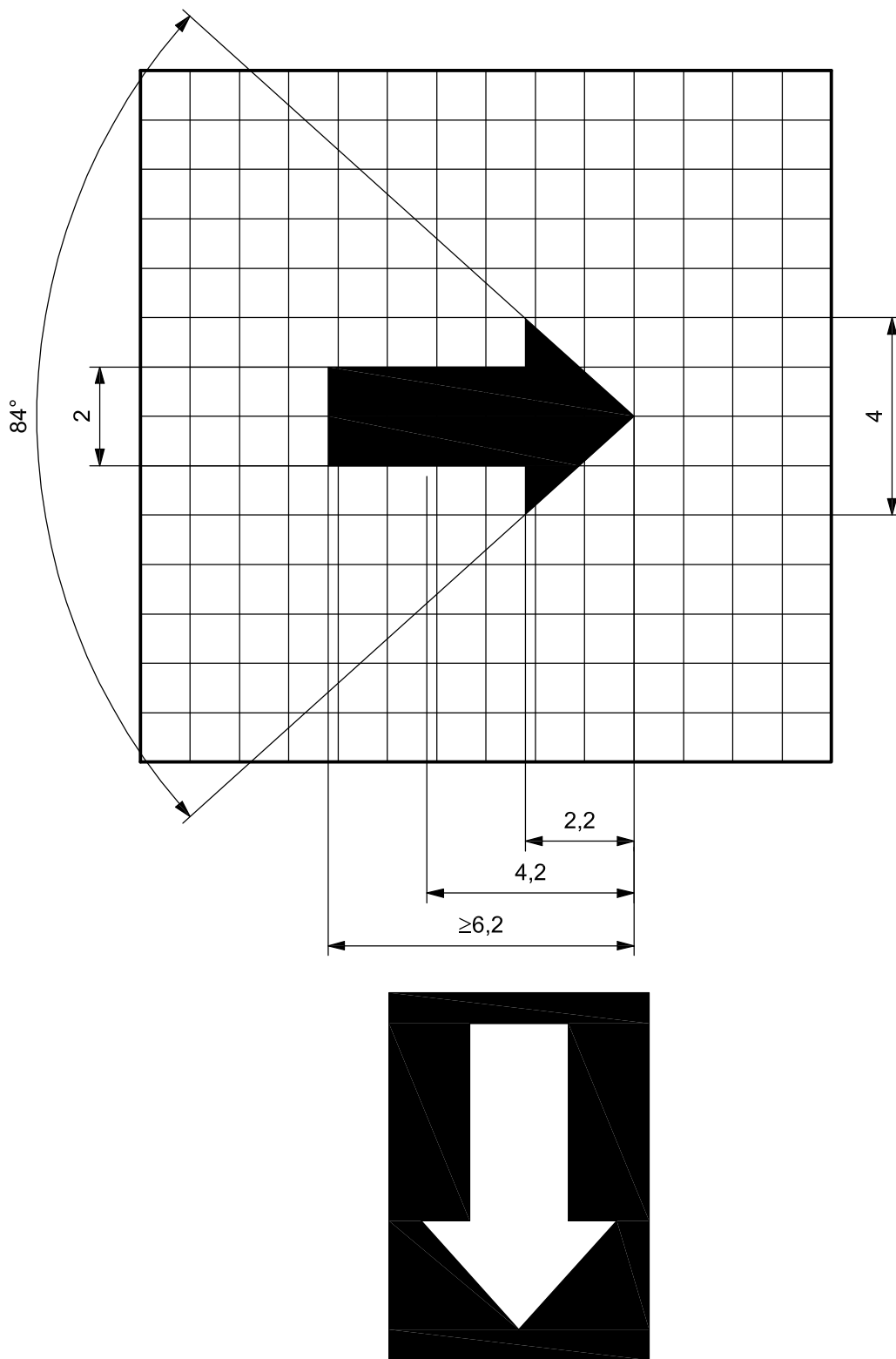

Figure D.22 — Arrow representing exertion of pressure or force

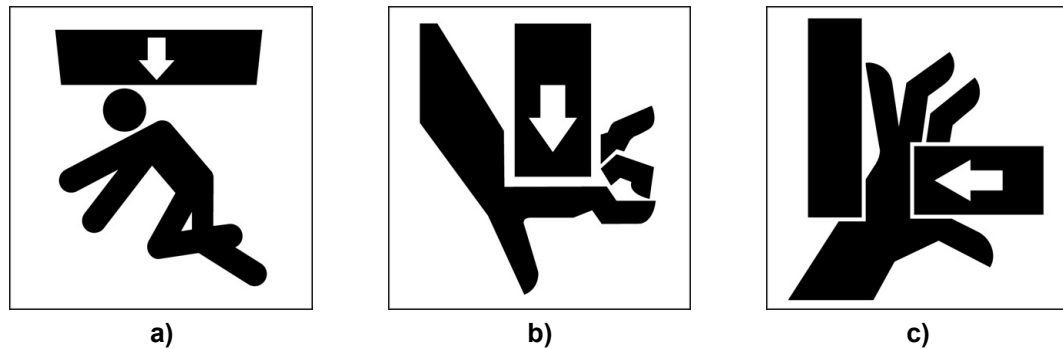

Figure D.23 — Examples of pictorials with arrows representing exertion of pressure or force

D.8.6 Arrows representing the concept of keeping a safe distance from the hazard

A black arrow on a white background (for safety signs with text) or a black arrow on a yellow background (for safety signs without text) is generally used. See Figure D.24 for arrow dimensions. This arrow is normally used at 60 % of the actual size shown in Figure D.24, although it may be sized differently as appropriate to individual pictorials. The arrowhead has an 84° included angle. Figure D.25 provides examples of pictorials that use this arrow to represent the idea of keeping a safe distance away from a hazard. The left portion of the arrow is a mirror image of the right portion.

Dimensions in units (see D.3.2)

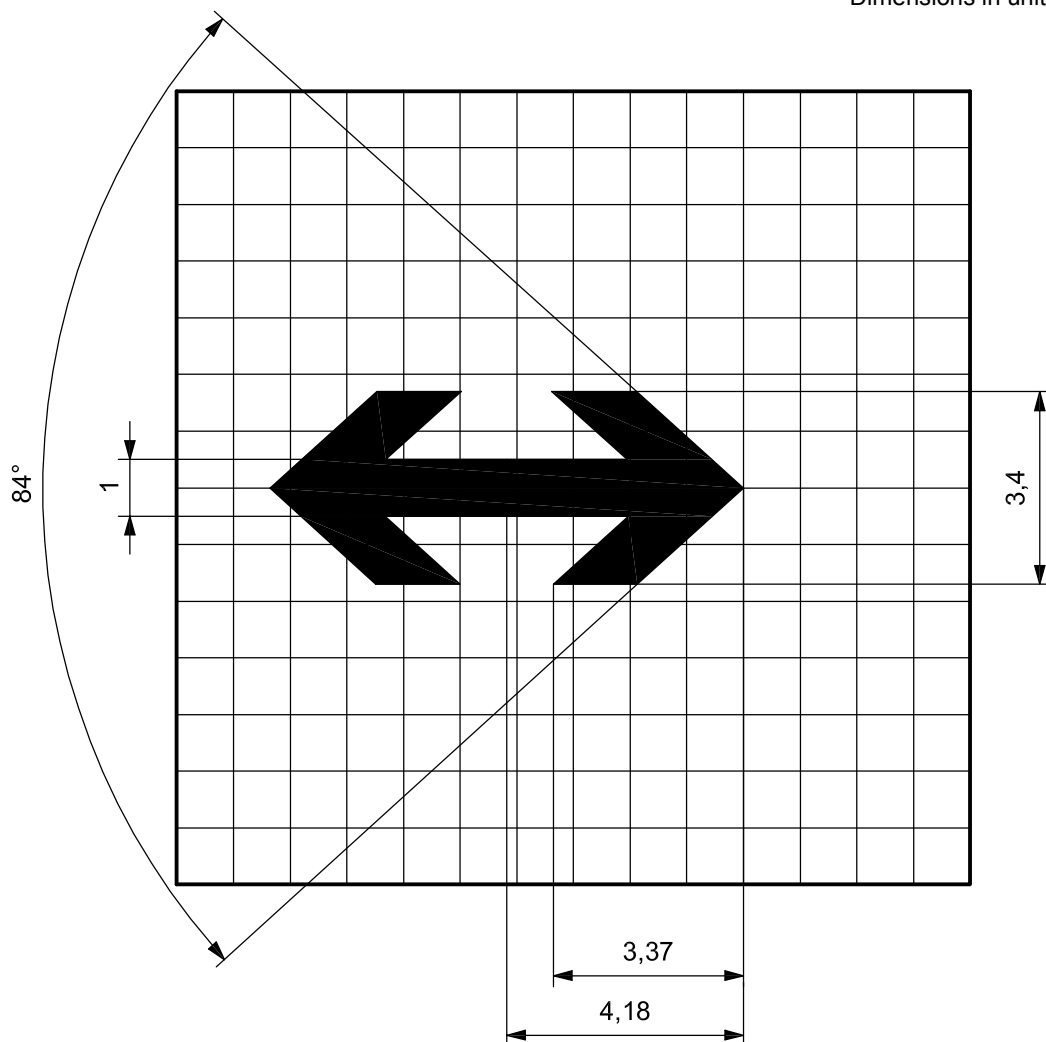

Figure D.24 — Arrow representing the idea of keeping a safe distance away from hazard

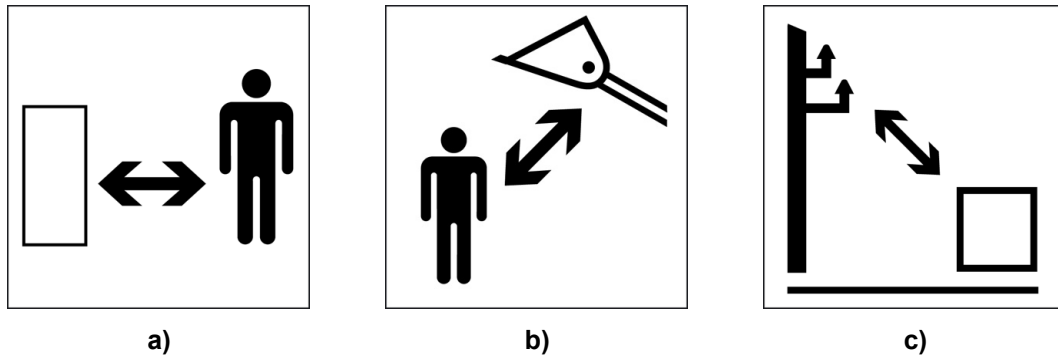

Figure D.25 — Examples of pictorials with arrows representing keeping a safe distance from a hazard

D.9 Communicating prohibition of an action or hazardous location

The general prohibition sign is used with pictorial elements to depict a prohibited action. The bar is always oriented from the upper left to the lower right of the circle; a 45° angle from the horizontal is standard, although this may be adjusted a few degrees more or less to avoid obscuring important pictorial information. Use the red circle with a diagonal bar only when its pictorial meaning is clear. Figure D.26 gives an example.



Figure D.26 — Example of pictorial using general prohibition sign to communicate prohibited action

Bibliography

- [1] ISO 3864-1:2002, *Graphical symbols — Safety colours and safety signs — Part 1: Design principles for safety signs in workplaces and public areas*
- [2] ISO 3864-2:2004, *Graphical symbols — Safety colours and safety signs — Part 2: Design principles for product safety labels*
- [3] ISO 3864-3, *Graphical symbols — Safety colours and safety signs — Part 3: Design principles for graphical symbols for use in safety signs*
- [4] ISO 6405-1, *Earth-moving machinery — Symbols for operator controls and other displays — Part 1: Common symbols*
- [5] ISO 6405-2, *Earth-moving machinery — Symbols for operator controls and other displays — Part 2: Specific symbols for machines, equipment and accessories*
- [6] ISO 7000, *Graphical symbols for use on equipment — Index and synopsis*
- [7] ISO 7010, *Graphical symbols — Safety colours and safety signs — Safety signs used in workplaces and public areas*
- [8] ISO 17724, *Graphical symbols — Vocabulary*
- [9] ISO 80416-2, *Basic principles for graphical symbols for use on equipment — Part 2: Form and use of arrows*
- [10] IEC 60417, *Graphical symbols for use on equipment*
- [11] ISO/IEC Guide 51, *Safety aspects — Guidelines for their inclusion in standards*

ICS 01.080.20; 53.100

Price based on 71 pages