

INTERNATIONAL STANDARD

ISO 9222-2

First edition
1989-07-15

Technical drawings — Seals for dynamic application —

Part 2 : Detailed simplified representation

*Dessins techniques — Joints d'étanchéité pour application dynamique —
Partie 2 : Représentation simplifiée particulière*



Reference number
ISO 9222-2 : 1989 (E)

ISO 9222-2 : 1989 (E)**Foreword**

ISO (the International Organization for Standardization) is a worldwide federation of national standards bodies (ISO member bodies). The work of preparing International Standards is normally carried out through ISO technical committees. Each member body interested in a subject for which a technical committee has been established has the right to be represented on that committee. International organizations, governmental and non-governmental, in liaison with ISO, also take part in the work. ISO collaborates closely with the International Electrotechnical Commission (IEC) on all matters of electrotechnical standardization.

Draft International Standards adopted by the technical committees are circulated to the member bodies for approval before their acceptance as International Standards by the ISO Council. They are approved in accordance with ISO procedures requiring at least 75 % approval by the member bodies voting.

International Standard ISO 9222-2 was prepared by Technical Committee ISO/TC 10, *Technical drawings*.

ISO 9222 consists of the following parts, under the general title *Technical drawings — Seals for dynamic application*:

- *Part 1: General simplified representation*
- *Part 2: Detailed simplified representation*

© ISO 1989

All rights reserved. No part of this publication may be reproduced or utilized in any form or by any means, electronic or mechanical, including photocopying and microfilm, without permission in writing from the publisher.

International Organization for Standardization
Case postale 56 • CH-1211 Genève 20 • Switzerland

Printed in Switzerland

Introduction

ISO 9222 provides rules for the simplified representation of seals.

The principle of drawing practice is to depict the object to scale using lines. In simplified representations, only essential features are shown, preferably in outline (in order to save time and effort).

The degree of simplification depends on the kind of object represented, the scale of the drawing and the purpose of the documentation. This means that either a general simplified representation or a detailed one may be used. A detailed representation shows more details of a seal, for example the configuration of lips.

In order to avoid misunderstandings, only one kind of simplification, either the general or the detailed simplified representation, should be used on a drawing.



Technical drawings — Seals for dynamic application —

Part 2:

Detailed simplified representation

1 Scope

This part of ISO 9222 specifies a detailed simplified representation for various seals. This representation should be used in cases where it is not necessary to show the exact shape and details of the seals, for example in assembly drawings.

2 Normative references

The following standards contain provisions which, through reference in this text, constitute provisions of this part of ISO 9222. At the time of publication, the editions indicated were valid. All standards are subject to revision, and parties to agreements based on this part of ISO 9222 are encouraged to investigate the possibility of applying the most recent editions of the standards indicated below. Members of IEC and ISO maintain registers of currently valid International Standards.

ISO 5597 : 1987, *Hydraulic fluid power — Cylinders — Housings for piston and rod seals in reciprocating applications — Dimensions and tolerances.*

ISO 6194-1 : 1982, *Rotary shaft lip seals — Part 1: Nominal dimensions and tolerances.*

ISO 6547 : 1981, *Hydraulic fluid power — Cylinders — Piston seal housings incorporating bearing rings — Dimensions and tolerances.*

ISO 9222-1 : 1989, *Technical drawings — Seals for dynamic application — Part 1: General simplified representation.*

3 Method of representation

3.1 General rules

See ISO 9222-1.

3.2 Elements of detailed simplified representation for seals

The elements of detailed simplified representation for seals are given in table 1.

Table 1 — Elements of detailed simplified representation for seals







No.	Element	Description	Application
1.1		Long continuous straight line (parallel to a generating line of the sealing surface)	The static (pressed in, fixed) element (seal or part of the seal or function)
1.2		Long continuous straight line (diagonal to the outlines) ¹⁾	The dynamic sealing element (lip) or function (part of the seal) In conjunction with symbol No. 1.1, it shows the position of the dynamic sealing side directed against fluids, gases and solid media
1.3		Short continuous straight line (diagonal to the outlines and at 90° to symbol No. 1.2) ¹⁾	In combination with symbol No. 1.2, dust lips, wipers, etc.
1.4.1		Short continuous angular line pointing to the centre point of the square ¹⁾	Sealing lips of U-cups, V-rings, packing sets, etc.

Table 1 (concluded)

No.	Element	Description	Application
1.4.2		Short continuous straight line pointing to the centre point of the square ¹⁾	Like 1.4.1 for U-cups, V-rings, packing sets, etc.
1.5		T (male)	Contactless seals, for example labyrinth seals
1.6		U (female)	

(T in U)

1) An arrowhead may be added to show the sealing direction.

ISO 9222-2 : 1989 (E)

3.3 Detailed simplified representation

The detailed simplified representations of seals are shown in tables 2 to 4.

NOTE — Seals shown in tables 2 to 4 are always depicted in the space above the axis.

Table 2 — Detailed simplified representation

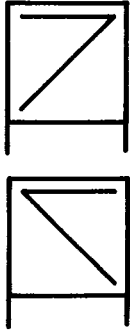
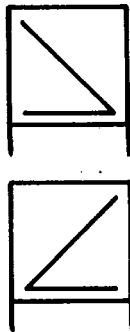
No.	Detailed simplified representation	Application	
		Seals subject to rotation	Relevant International Standard
2.1		Rotary shaft lip type seals without dust lip Mechanical seals	ISO 6194-1
2.2		Rotary shaft lip type seals without dust lip Mechanical seals	ISO 6194-1

1) This type of illustration is not commonly used in technical drawings, but is used conventionally in catalogues, users' handbooks, prospectuses, etc.



Application		Illustration 1)
Seals subject to translation	Relevant International Standard	
Piston rod seals without wiper	ISO 5597	<p>ISO 6194-1, type 1 – Rubber covered</p> 
		<p>ISO 6194-1, type 2 – Metal cased</p> 
		<p>ISO 6194-1, type 3 – Assembled</p> 
Piston rod seals without wiper	ISO 5597	

Table 2 (concluded)

No.	Detailed simplified representation	Application	
		Seals subject to rotation	Relevant International Standard
2.3		Rotary shaft lip type seals with dust lip	ISO 6194-1
2.4		Rotary shaft lip type seals with dust lip	ISO 6194-1
2.5		Rotary shaft lip type seals without dust lip, double-acting Mechanical seals	—
2.6		Rotary shaft lip type seals without dust lip, double-acting Mechanical seals	—

1) This type of illustration is not commonly used in technical drawings, but is used conventionally in catalogues, users' handbooks, prospectuses, etc.

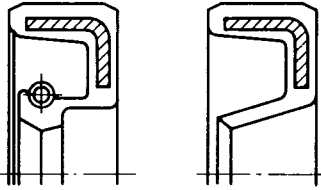
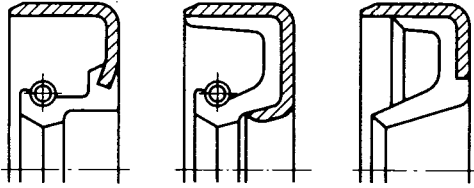
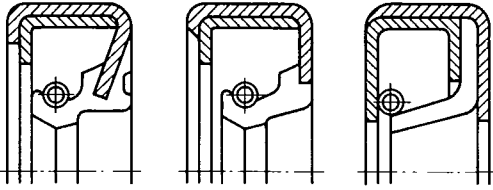
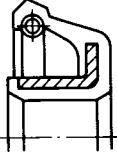
Application		Illustration 1)
Seals subject to translation	Relevant International Standard	
Piston rod seals with wiper	—	<p>ISO 6194-1, type 4 — Rubber covered with minor lip</p>  <p>ISO 6194-1, type 5 — Metal cased with minor lip</p>  <p>ISO 6194-1, type 6 — Assembled with minor lip</p> 
Piston rod seals with wiper	—	
Double-acting piston rod seals	—	<p>Metal cased, double lip</p>  <p>Rubber covered, double lip</p> 
Double-acting piston rod seals	ISO 6547	

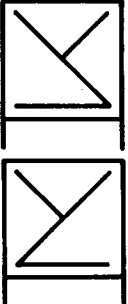
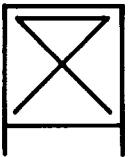
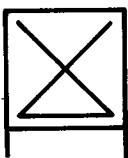
Table 3 — Detailed representation of U-cups, packing sets and V-rings



No.	Detailed simplified representation	Application
3.1		
3.2		
3.3		
3.4		
3.5		
3.6		
3.7		

Table 4 — Detailed simplified representation of labyrinth seals (irrespective of the number of labyrinths)

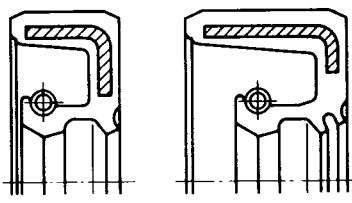
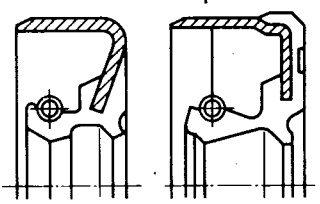
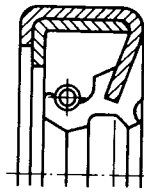
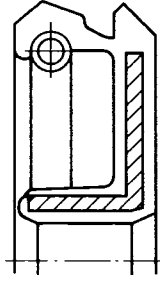
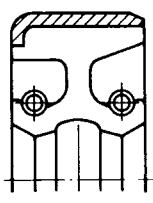
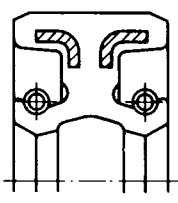
No.	Detailed simplified representation	Application
4.1		

4 Examples

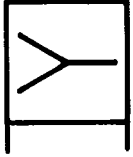
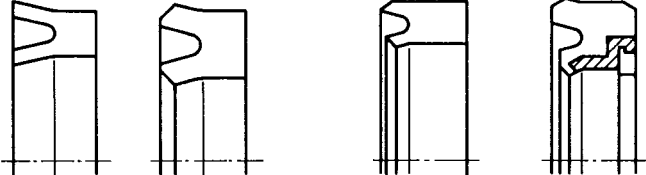
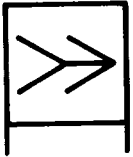
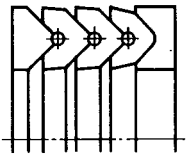
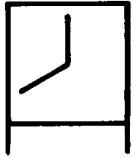
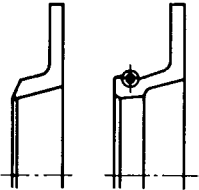
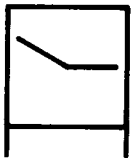
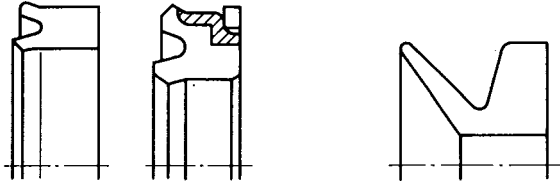
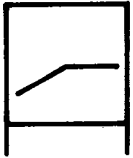
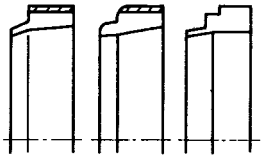
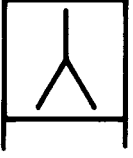
Examples showing the simplified representation of seals are given in figures 1 to 5.

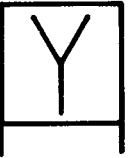
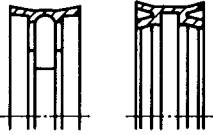
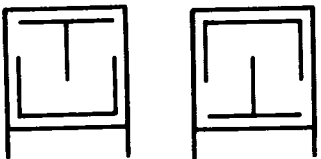
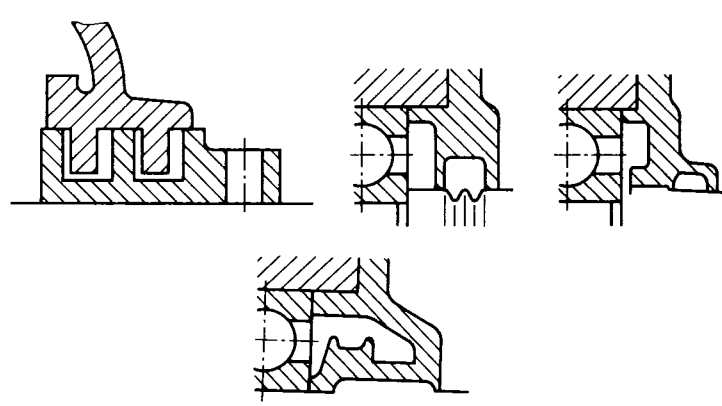
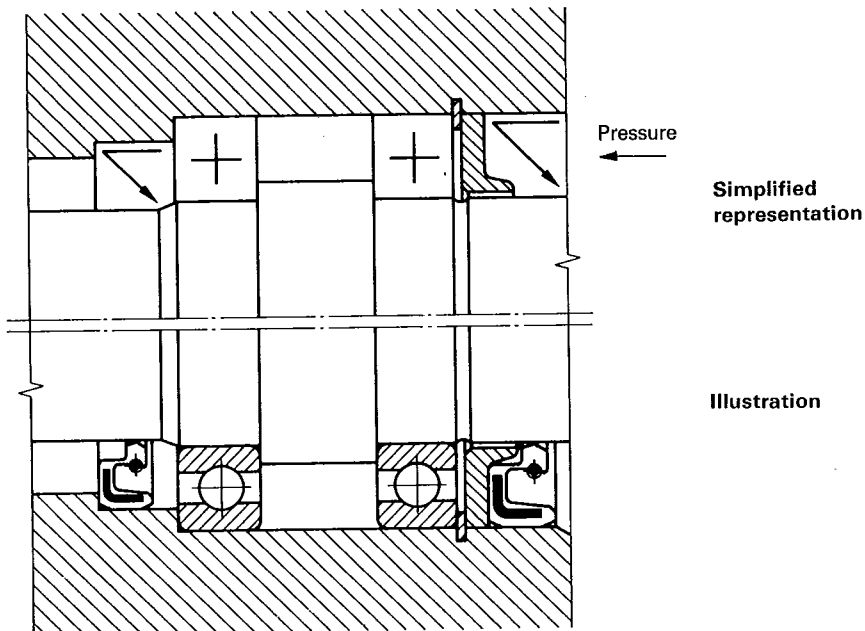

Figure 1 — Rotary shaft lip type seal (sealing against fluids)

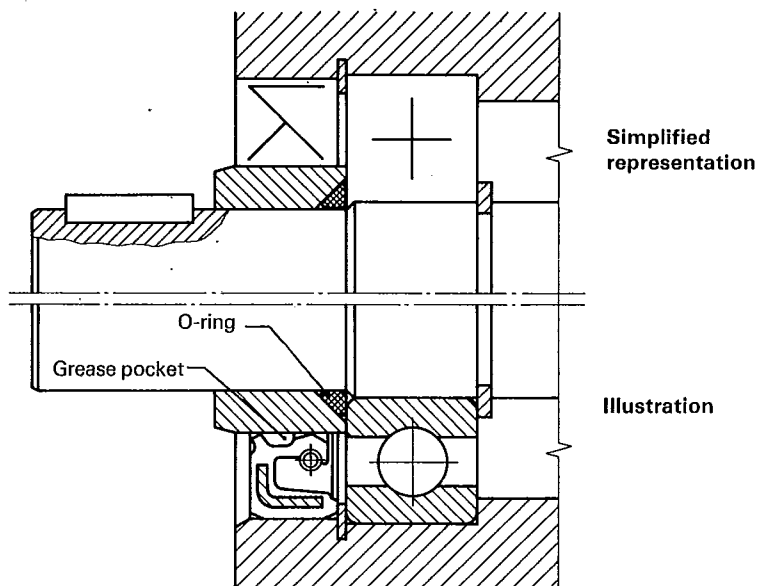

Figure 2 — Rotary shaft lip type seal with dust lip

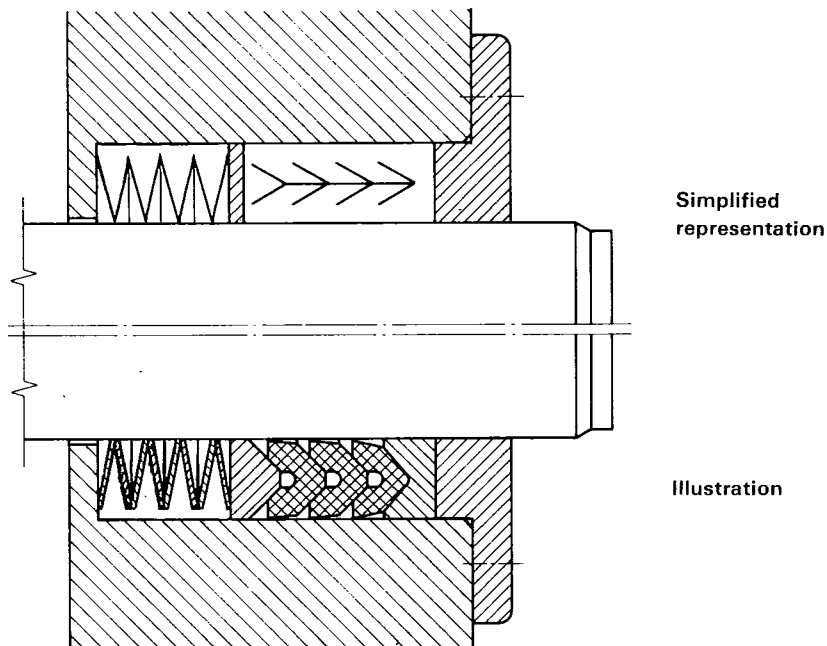

Figure 3 – Packing set

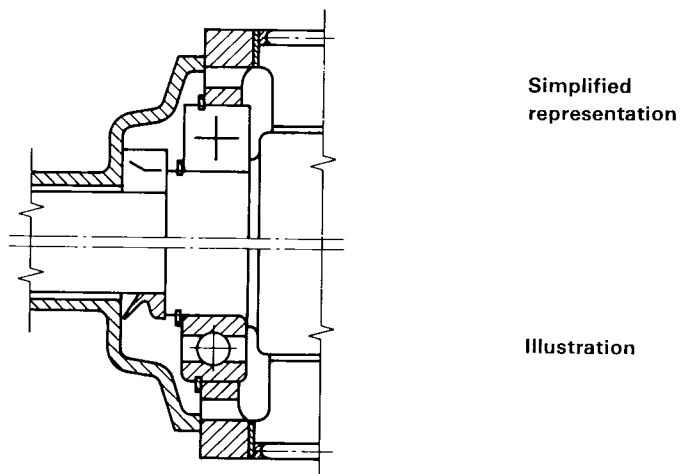

Figure 4 – V-ring

ISO 9222-2 : 1989 (E)

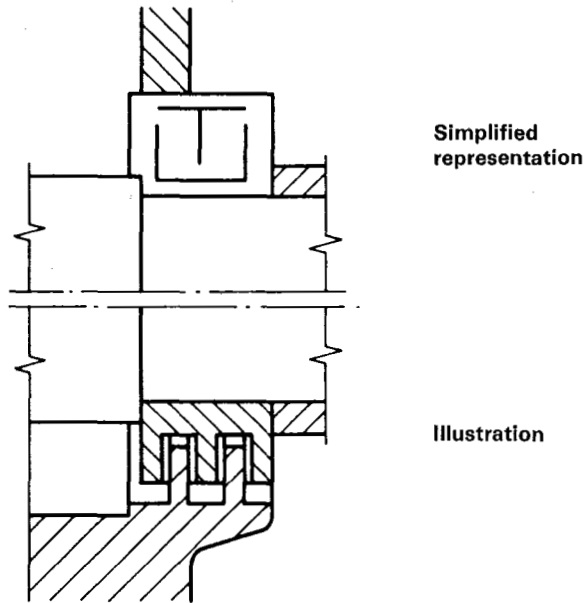

Figure 5 – Labyrinth seal

UDC 744.43 : 62-762.8

Descriptors : drawings, technical drawings, seals (stoppers), graphic methods.

Price based on 12 pages
