

INTERNATIONAL STANDARD

ISO 8847

Second edition
2004-05-01

Small craft — Steering gear — Cable and pulley systems

Petits navires — Appareils à gouverner — Systèmes à drosses et réas



Reference number
ISO 8847:2004(E)

© ISO 2004

PDF disclaimer

This PDF file may contain embedded typefaces. In accordance with Adobe's licensing policy, this file may be printed or viewed but shall not be edited unless the typefaces which are embedded are licensed to and installed on the computer performing the editing. In downloading this file, parties accept therein the responsibility of not infringing Adobe's licensing policy. The ISO Central Secretariat accepts no liability in this area.

Adobe is a trademark of Adobe Systems Incorporated.

Details of the software products used to create this PDF file can be found in the General Info relative to the file; the PDF-creation parameters were optimized for printing. Every care has been taken to ensure that the file is suitable for use by ISO member bodies. In the unlikely event that a problem relating to it is found, please inform the Central Secretariat at the address given below.

© ISO 2004

All rights reserved. Unless otherwise specified, no part of this publication may be reproduced or utilized in any form or by any means, electronic or mechanical, including photocopying and microfilm, without permission in writing from either ISO at the address below or ISO's member body in the country of the requester.

ISO copyright office
Case postale 56 • CH-1211 Geneva 20
Tel. + 41 22 749 01 11
Fax + 41 22 749 09 47
E-mail copyright@iso.org
Web www.iso.org

Published in Switzerland

Contents

Page

Foreword	iv
1 Scope	1
2 Normative references	1
3 Terms and definitions	1
4 Conditions of use	2
5 Constructional requirements	2
6 Gear marking	5
7 General installation requirements	5
8 Owner's manual	7
9 Installation manual	7

Foreword

ISO (the International Organization for Standardization) is a worldwide federation of national standards bodies (ISO member bodies). The work of preparing International Standards is normally carried out through ISO technical committees. Each member body interested in a subject for which a technical committee has been established has the right to be represented on that committee. International organizations, governmental and non-governmental, in liaison with ISO, also take part in the work. ISO collaborates closely with the International Electrotechnical Commission (IEC) on all matters of electrotechnical standardization.

International Standards are drafted in accordance with the rules given in the ISO/IEC Directives, Part 2.

The main task of technical committees is to prepare International Standards. Draft International Standards adopted by the technical committees are circulated to the member bodies for voting. Publication as an International Standard requires approval by at least 75 % of the member bodies casting a vote.

Attention is drawn to the possibility that some of the elements of this document may be the subject of patent rights. ISO shall not be held responsible for identifying any or all such patent rights.

ISO 8847 was prepared by Technical Committee ISO/TC 188, *Small craft*.

This second edition cancels and replaces the first edition (ISO 8847:1987), which has been technically revised.

Small craft — Steering gear — Cable and pulley systems

1 Scope

This International Standard specifies the minimum level of requirements for operation, construction and installation of cable and pulley steering systems on sailing craft of hull length up to 24 m, with or without an auxiliary engine.

This International Standard sets requirements for the design and construction of all components of a steering system from the wheel to, and including, the steering arm. It applies only to cable and pulley steering systems, whether for pedestal or bulkhead types.

The design and specifications for the rudder shaft and rudder blade are within the province of the naval architect and are assumed to be appropriate to the size and speed of the boat.

2 Normative references

The following referenced documents are indispensable for the application of this document. For dated references, only the edition cited applies. For undated references, the latest edition of the referenced document (including any amendments) applies.

ISO 2408:2004, *Steel wire ropes for general purposes — Minimum requirements*

3 Terms and definitions

For the purposes of this document, the following terms and definitions apply.

3.1

cable

a flexible mechanical means of transmitting tension forces from one location to another

NOTE This cable could be metallic or non-metallic.

3.2

cable and pulley steering system

system in which rotation of the steering-wheel positions the rudder blade by mechanical means including cable, pulleys and a steering arm quadrant fastened to the rudder shaft

3.3

steering arm

component fixed to the rudder shaft, with at least one groove for the cable, concentric to the shaft centre

NOTE The steering arm may be a wheel quadrant [see Figure 1 a)], a quadrant [see Figure 1 b)] or a tiller quadrant [see Figure 1 c)]

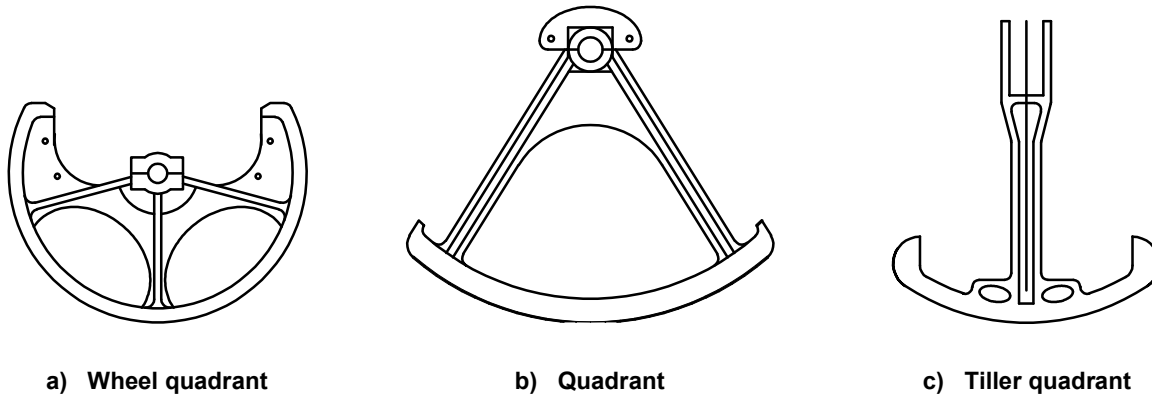

Figure 1 — Examples of steering arm types

3.4 cable load

force applied to the cable providing the necessary torque to move the rudder through the rudder shaft and steering arm while the boat is sailing

3.5 cable in conduit steering systems

system in which rotation of the steering-wheel positions the rudder blade by mechanical means including cable, conduits with or without pulleys, and a steering arm fastened to the rudder shaft

3.6 accessible

capable of being reached for inspection, removal or maintenance, without removal of a permanent element of the boat structure

4 Conditions of use

To ensure the proper operation of a steering system, all components shall be fastened securely to the structure of the boat, reinforced where necessary, especially at the bulkhead mounting, pedestal and at pulleys.

The steering arm connection to the rudder shaft shall also be capable of transmitting the steering torque to the rudder.

5 Constructional requirements

5.1 Strength

All components shall be of sufficient strength to transmit either the tangential force of 450 N on the rim of the wheel specified in 5.6.2, or the maximum torque necessary to steer the rudder.

5.2 Steering arm

The radius of the steering arm and the cable diameter shall be chosen such that the cable load is less than 25 % of the cable breaking load. The steering-arm radius shall be concentric with the shaft centre.

The radius at the end of the groove where the cable is led out shall be at least 5 times the diameter of the cable used. See Figure 2.

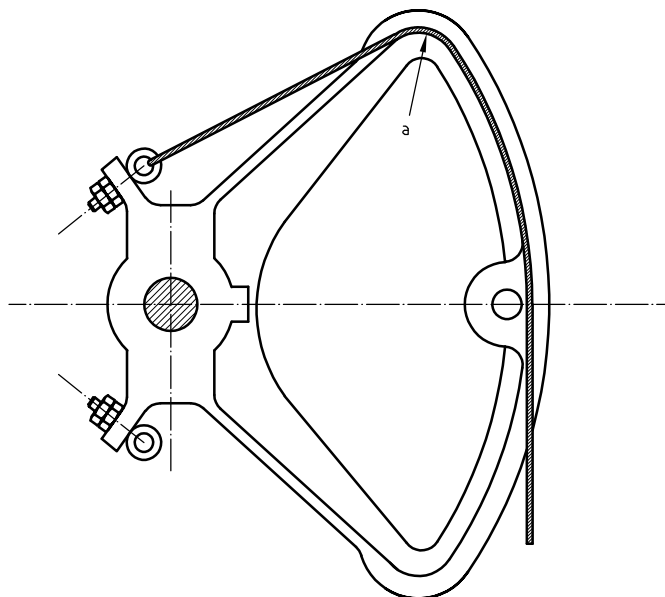

^a $r \geq 5 \times \text{cable diameter}$.

Figure 2 — Radius, r

5.3 Cables

Cables shall be of flexible construction.

Cables shall be suitable for its intended application (e.g. resistant to UV, salt water, hydrocarbons and ozone).

Wire-rope characteristics shall meet the specifications given in ISO 2408.

The tension shall be adjustable by means of an appropriate tensioner (e.g. a rigging screw) to minimize lost motion.

The cable shall be aligned with the grooves when leaving the steering arm.

The cable termination shall be appropriate to transfer the cable loads.

EXAMPLE Wire rope, thimble and two cable clamps; swaged terminals; splicing with thimble.

5.4 Pulleys

The sheave diameter shall be suitable for the cable used or recommended.

NOTE The generally accepted minimum diameter is 16 times the diameter of the cable (7×19).

If pulleys are of the swivel type, means shall be provided to secure them in the correct position.

Pulleys shall be fitted to guide the cable into and out of the sheave, and prevent it jamming against the pulley frame.

5.5 Conduit

The conduit shall be of sufficient flexibility to permit a minimum bend radius of 50 times the smallest diameter of the cable it is specified for. The conduit shall be finished at each end with a conduit fitting, which provides a method of clamping the conduit securely and permitting the assembly to be locked onto a plate, pulley or terminal unit, which connects the cable onto the chain assembly, intermediate sheave or steering arm (see Figures 3 and 4).

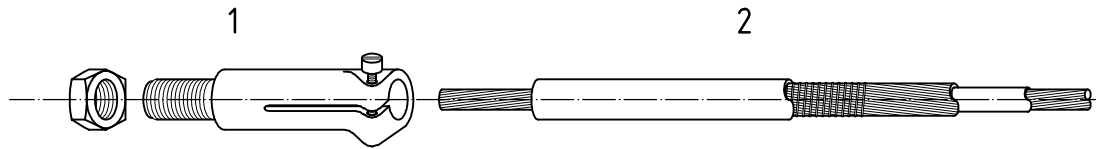

Key

- 1 conduit fitting
- 2 conduit

Figure 3 — Example of a conduit fitting

5.6 Steering-wheel

The steering-wheel shall be installed on a fixed shaft and shall withstand the axial load and tangential load test listed in 5.6.1 and 5.6.2.

5.6.1 Axial load test

Apply a 670 N single push-pull force F (see Figure 5) for 10 cycles of at least 5 s duration each at any single location on the outer wheel rim or the centre of the handgrip of an external spoke in a direction parallel to the centreline of the fixed shaft. Permanent deformation greater than 50 mm is a failure of the wheel.

5.6.2 Tangential load test

Apply a 450 N single push-pull force, F , in each direction (see Figure 6) for 10 cycles of at least 5 s duration each at any single location on the outer wheel rim or the centre of the handgrip of an external spoke of the steering-wheel without separation of the wheel.

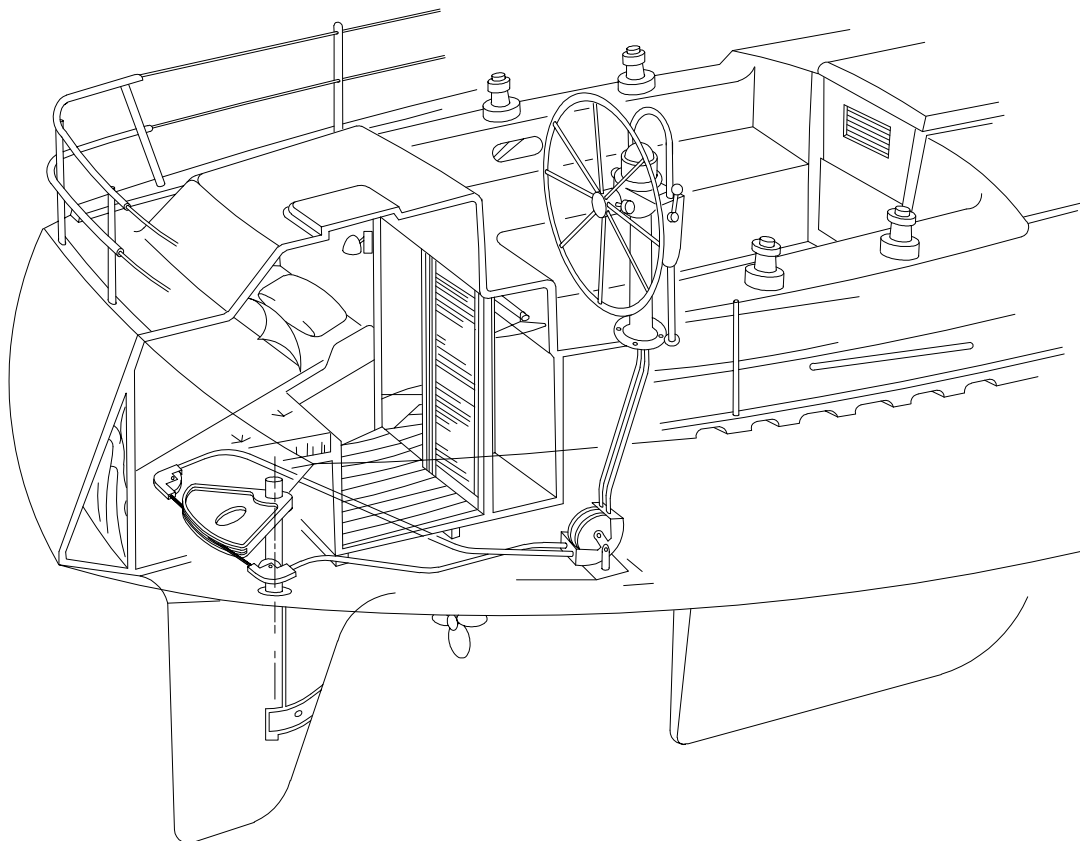

Figure 4 — Example of a cable in the conduit system

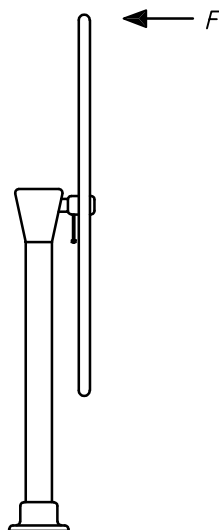

Figure 5 — Application of axial load

6 Gear marking

The wheel supporting system shall be marked with the largest diameter wheel acceptable for this gear.

7 General installation requirements

7.1 Steering system

The whole system shall withstand, without loss of steering, the loads resulting from the tests described in 7.1.1 and 7.1.2.

7.1.1 Axial load test

Apply a 670 N single push-pull load F (see Figure 5) for 10 cycles of 5 s each at any single location on the outer wheel rim or the centre of the handgrip of an external spoke in a direction parallel to the centreline of the wheel shaft.

7.1.2 Tangential load test

With the rudder shaft locked and not against a stop, apply a 450 N single push-pull load F (see Figure 6) for 10 cycles of 5 s each to the external rim or the centre of the handgrip of an external spoke of the steering-wheel.

7.2 Steering-arm rotation

One or two stops shall be suitably fixed to the structure of the craft to limit over-rotation of the steering arm (see Figure 7).

The positioning of the stops shall take into consideration the possible dynamic overloading due to shock.

No component, except the rudder stop, shall limit the rotation of the steering system.

7.3 Compass interference

Materials used in the various components of the steering system as supplied shall not affect the accuracy and reliability of a compass mounted on the pedestal, if used, whatever the steering angle may be.

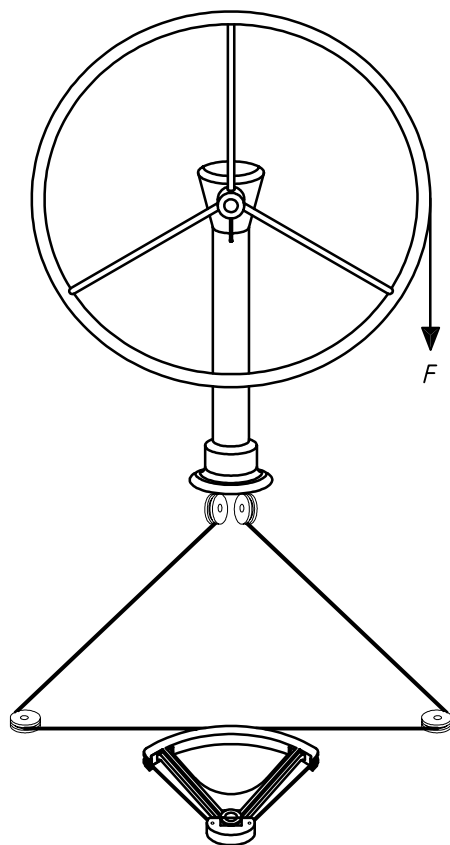

Figure 6 — Application of tangential load

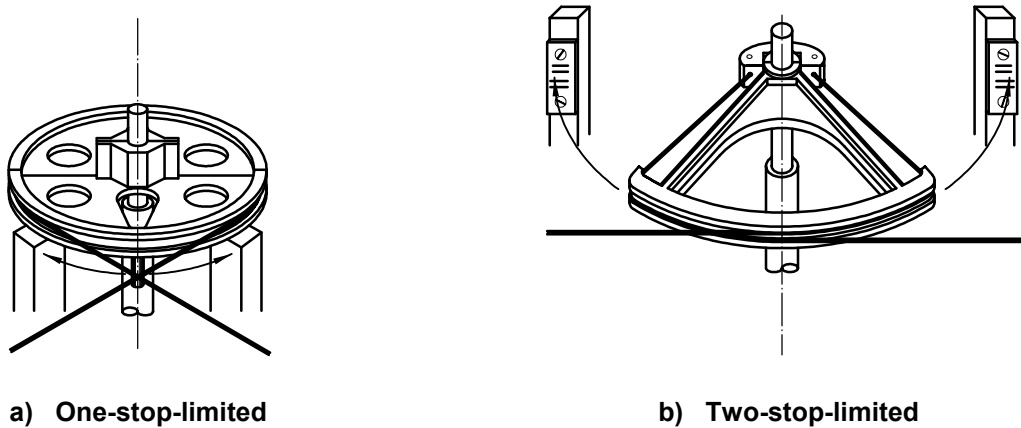

Figure 7 — Steering-arm rotation

7.4 Accessibility

The components of the steering system shall be accessible for inspection and maintenance.

8 Owner's manual

The following information shall be included in the boat owner's manual:

- routine maintenance procedures;
- specific precautions critical for correct operation, if relevant.

9 Installation manual

An installation manual shall be provided with the system. It shall include at least the following information:

- reference of the model type and identification of basic components;
- general description of operation and reference to specification of rating;
- maximum corresponding rudder torque;
- installation instructions;
- recommended installation test procedures;
- general description of installations of rudder stops in accordance with 7.2;
- maximum wheel diameter.

© ISO 2004. All rights reserved.

