**Pneumatic fluid power — Compressed air
pressure regulators and filter-regulators —**

Part 3:

**Alternative test methods for measuring
the flow-rate characteristics of pressure
regulators**

*Transmissions pneumatiques — Régulateurs de pression et filtre-
régulateurs pour air comprimé —*

*Partie 3: Méthodes d'essai alternatives pour mesurer les
caractéristiques de débit des régulateurs de pression*



Reference number
ISO 6953-3:2012(E)

© ISO 2012



COPYRIGHT PROTECTED DOCUMENT

© ISO 2012

All rights reserved. Unless otherwise specified, no part of this publication may be reproduced or utilized in any form or by any means, electronic or mechanical, including photocopying and microfilm, without permission in writing from either ISO at the address below or ISO's member body in the country of the requester.

ISO copyright office
Case postale 56 • CH-1211 Geneva 20
Tel. + 41 22 749 01 11
Fax + 41 22 749 09 47
E-mail copyright@iso.org
Web www.iso.org

Published in Switzerland

Contents

Page

Foreword	iv
Introduction	v
1 Scope	1
2 Normative references	1
3 Terms and definitions	2
4 Symbols and units	2
5 Test installation	2
5.1 Test circuit	2
5.2 General requirements	3
5.3 Isothermal tank (items 4 and 5)	4
5.4 Special requirements	4
6 Test procedures	5
6.1 Test conditions	5
6.2 Measuring procedures	5
6.3 Calculation of characteristics	8
7 Presentation of test results	11
8 Identification statement	11
Annex A (informative) Examples of test results	12
Annex B (informative) Various data processing methods	28
Annex C (informative) Visualization of data processing procedures	37
Annex D (informative) Illustrations of overshoot and undershoot on regulated pressure response and large variations on inlet pressure	40
Bibliography	45

Foreword

ISO (the International Organization for Standardization) is a worldwide federation of national standards bodies (ISO member bodies). The work of preparing International Standards is normally carried out through ISO technical committees. Each member body interested in a subject for which a technical committee has been established has the right to be represented on that committee. International organizations, governmental and non-governmental, in liaison with ISO, also take part in the work. ISO collaborates closely with the International Electrotechnical Commission (IEC) on all matters of electrotechnical standardization.

International Standards are drafted in accordance with the rules given in the ISO/IEC Directives, Part 2.

The main task of technical committees is to prepare International Standards. Draft International Standards adopted by the technical committees are circulated to the member bodies for voting. Publication as an International Standard requires approval by at least 75 % of the member bodies casting a vote.

Attention is drawn to the possibility that some of the elements of this document may be the subject of patent rights. ISO shall not be held responsible for identifying any or all such patent rights.

ISO 6953-3 was prepared by Technical Committee ISO/TC 131, *Fluid power systems*, Subcommittee SC 5, *Control products and components*.

ISO 6953 consists of the following parts, under the general title *Pneumatic fluid power — Compressed air pressure regulators and filter-regulators*:

- *Part 1: Main characteristics to be included in literature from suppliers and product-marking requirements*
- *Part 2: Test methods to determine the main characteristics to be included in literature from supplier*
- *Part 3: Alternative test methods for measuring the flow-rate characteristics of pressure regulators*

Introduction

This part of ISO 6953 defines alternative test methods for flow-rate characteristics of pneumatic pressure control valves. These alternative test methods do not use a flow meter but, instead, use an isothermal tank.

These methods measure the forward flow-rate characteristics by passing compressed air from a charged tank through the regulator under test, into an isothermal tank. Relief flow-rate characteristics are obtained by passing compressed air from an isothermal tank, through the regulator under test, and out to the atmosphere.

The test methods specified in this part of ISO 6953 have the following advantages over test methods specified in ISO 6953-2:

- a) an air source with a large flow-rate capacity is not required;
- b) components with larger flow-rate capacity can be tested more easily;
- c) air consumption is minimized; and
- d) test time is shortened.



Pneumatic fluid power — Compressed air pressure regulators and filter-regulators —

Part 3: Alternative test methods for measuring the flow-rate characteristics of pressure regulators

1 Scope

This part of ISO 6953 specifies alternative test methods for testing pneumatic fluid power components that use compressible fluids, i.e. gases. This part of ISO 6953 is applicable only to the decreasing flow rate part of the hysteresis curve of forward flow and relief flow characteristics. This method can be applied when:

- the pressure regulation dynamics of a component under test is rapid enough to be negligible, compared to the response of pressure changes during charge and discharge tests;
- the pressure response does not show any overshoot or any oscillating behaviour.

This part of ISO 6953 specifies requirements for the test installation, the test procedure and the presentation of results.

Examples of test results are given, as well as various data processing methods, and visualization of data processing procedures. Illustrations of overshoot and undershoot on regulated pressure response and large variations on inlet pressure are also given.

This part of ISO 6953 applies to the following components:

- compressed air pressure regulators and filter-regulators according to ISO 6953-1;
- electro-pneumatic pressure control valves according to ISO 10094;
- other components such as relief valves.

NOTE If pressure regulation characteristics are needed, ISO 6953-2 is applicable.

2 Normative references

The following referenced documents are indispensable for the application of this document. For dated references, only the edition cited applies. For undated references, the latest edition of the referenced document (including any amendments) applies.

ISO 5598, *Fluid power systems and components — Vocabulary*

ISO 6358-1, *Pneumatic fluid power — Determination of flow-rate characteristics of components — Part 1: General rules and test methods for steady-state flow*¹⁾

ISO 6358-2, *Pneumatic fluid power — Determination of flow-rate characteristics of components — Part 2: Alternative test methods*¹⁾

ISO 6953-1, *Pneumatic fluid power — Compressed air pressure regulators and filter-regulators — Part 1: Main characteristics to be included in literature from suppliers and product marking requirements*

1) To be published.

ISO 6953-2, *Pneumatic fluid power — Compressed air pressure regulators and filter-regulators — Part 2: Test methods to determine the main characteristics to be included in literature from suppliers*

ISO 10094-2, *Pneumatic fluid power — Electro-pneumatic pressure control valves — Part 2: Test methods to determine main characteristics to include in the supplier's literature*

3 Terms and definitions

For the purposes of this document, the terms and definitions given in ISO 5598, ISO 6358-1, ISO 6953-1 and ISO 10094-1 apply.

4 Symbols and units

4.1 The symbols and units shall be in accordance with ISO 6358-1 and ISO 6358-2, except for the pressure, p , given as the gauge stagnation pressure in this part of ISO 6953.

4.2 The subscripts to the symbols shall be in accordance with ISO 6358-1 and ISO 6358-2, except as given in Table 1.

Table 1 — Subscripts

Subscript	Meaning
1	Inlet conditions
2	Outlet conditions
3	Isothermal tank conditions
4	Relief conditions
a	Atmospheric conditions
u	Upstream conditions
d	Downstream conditions
f	Forward flow conditions
r	Relief flow conditions

4.3 The graphical symbols used in Figure 1 are in accordance with ISO 1219-1.

5 Test installation

5.1 Test circuit

A suitable test circuit as shown in Figure 1 shall be used. The key of Figure 1 defines the test circuit components.

NOTE Figure 1 illustrates the basic circuit which does not incorporate all of the safety devices necessary to protect against damage in the event of component failure. It is important that those responsible for carrying out the test give due consideration to safeguarding both personnel and equipment.

.....

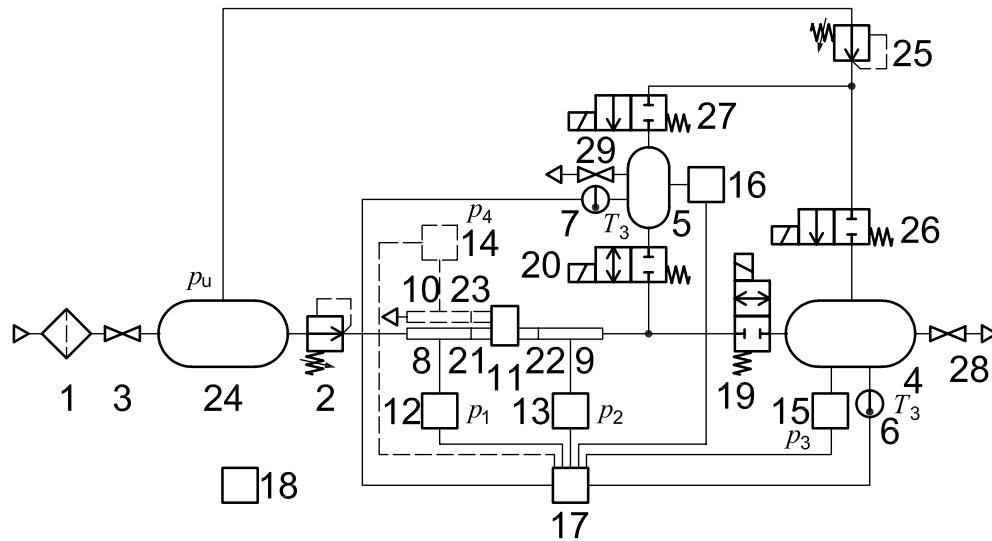
**Key**

1	compressed gas source and filter	24	tank
2	adjustable pressure regulator	25	adjustable pressure regulator
3	shut-off valve	26, 27	solenoid valve, or manual valve
4, 5	isothermal tank, in accordance with ISO 6358-2	28, 29	exhaust valve
6, 7	temperature-measuring instrument		
8, 9, 10	pressure-measuring tube, in accordance with ISO 6358-1	p_1	inlet pressure
11	component under test	p_2	outlet pressure
12, 13, 14, 15, 16	pressure transducer	p_3	pressure in the isothermal tank
17	digital recorder	p_4	relief pressure
18	barometer	p_u	supply pressure
19, 20	solenoid valve, bi-directional flow type shall be used	T_3	temperature in the isothermal tank
21, 22, 23	transition connector, in accordance with ISO 6358-1		

Figure 1 — Test circuit**5.2 General requirements**

5.2.1 The component under test shall be installed and operated in the test circuit in accordance with the manufacturer's operating instructions.

5.2.2 A filter shall be installed which provides a standard of filtration specified by the manufacturer of the component under test.

5.2.3 The test circuit of Figure 1 shall be constructed from the items listed in the key of Figure 1. Items 1, 2, 3, 4, 6, 8, 9, 11, 12, 13, 15, 17, 18, 19, 21, 22, 24, 25, 26 and 28 inclusive are essential, and the remaining items 5, 7, 10, 14, 16, 20, 23, 27 and 29 can be chosen in accordance with 5.2.4 and 5.2.13.

5.2.4 Items 10, 14, 23 are not required for a component under test that does not have a relief port, or when the mounting is not possible.

5.2.5 The sonic conductance of solenoid valve 19 shall be about four times as large as that of the component under test.

5.2.6 The sonic conductance of adjustable pressure regulator 2 shall be at least twice as large as the forward sonic conductance of the component under test. The upstream regulator 2 must be chosen to keep the inlet pressure, p_1 , in the range of ± 1 % of the pressure specified in 6.1.4.1. See 6.3.3 and Annex D.2.

5.2.7 The distance between pressure-measuring tube 9 and isothermal tanks 4 and 5 shall be as short as possible.

5.2.8 Pressure-measuring tubes 8, 9 and 10, and transition connectors 21, 22 and 23, shall be made in accordance with ISO 6358-1. It is not necessary to have a temperature-measuring connection in the pressure-measuring tubes because, in this test method, the temperature is measured in the isothermal tank.

5.2.9 Pressure transducer 12 shall be connected to the pressure tap of pressure-measuring tube 8.

5.2.10 Pressure transducer 13 shall be connected to the pressure tap of pressure-measuring tube 9.

5.2.11 Pressure transducer 14 shall be connected to the pressure tap of pressure-measuring tube 10.

5.2.12 solenoid valves 19 and 20 shall each have a rapid shifting time that ensures that test data collection starts after solenoid valves 19 and 20 each shift.

5.2.13 When the relief capacity of the component under test is very small, the size of components 5, 20 and 27 should be small in order to shorten the testing time. The sonic conductance of solenoid valve 20 shall be at least four times as large as the relief sonic conductance of the component under test.

5.2.14 The volume of the tank 24, or supply pressure from an air source should be determined to satisfy the following relation.

$$\frac{V_u}{V_d} > \frac{p_{2\max}}{p_u - p_1} \quad (1)$$

where

V_u is the volume of tank 24 (m^3);

V_d is the volume of tank 4 (m^3);

p_u is the supply pressure (Pa);

p_1 is the inlet pressure (Pa);

$p_{2\max}$ is the maximum value of regulated pressure (Pa).

5.2.15 For the places where liquid is collected, installation of a drain valve is preferred.

5.3 Isothermal tank (items 4 and 5)

The structure, stuffed material and volume shall be in accordance with ISO 6358-2.

5.4 Special requirements

The special requirements shall be in accordance with ISO 6358-1 and ISO 6358-2.

6 Test procedures

6.1 Test conditions

6.1.1 Gas supply

The gas supply shall conform to the requirements of ISO 6358-1.

6.1.2 Checks

The checks shall be in accordance with ISO 6358-1.

6.1.3 Test measurements

6.1.3.1 Measurement shall be started only after steady-state conditions of temperature and pressure in the isothermal tank have been reached.

6.1.3.2 Measurements shall be in conformance with Table 2 for the measurement accuracy and for the allowed test condition variation.

Table 2 — Measurement accuracy and allowed test condition variation of parameters

Parameter	Measurement accuracy	Allowed test condition variation
Volume	± 1 %	—
Time	± 1 %	—
Inlet pressure	$\pm 0,5$ %	± 1 %
Tank pressure	$\pm 0,5$ %	—
Regulated pressure	$\pm 0,5$ %	0 % overshoot for charge test 0 % undershoot for discharge test
Temperature	± 1 K	± 3 K

6.1.3.3 The phase lag between p_1 and p_3 shall be smaller than two sampling periods.

6.1.4 Inlet and set pressures

6.1.4.1 The inlet pressure used for testing shall be the lower of

- the maximum regulated pressure plus 200 kPa (2 bar), and
- the specified maximum inlet pressure.

6.1.4.2 The set pressure shall be in accordance with ISO 6953-2.

6.1.4.3 The flow-rate data shall be obtained while the inlet pressure, p_1 , is held within ± 1 %.

6.2 Measuring procedures

6.2.1 General

According to the design of the component under test, either or both of the procedures specified in 6.2.2 and 6.2.3 shall be followed.

6.2.2 Forward flow characteristics test

6.2.2.1 Close shut-off valve 3 and the solenoid valves 19 and 20 and install the component under test according to Figure 1 (make sure that its outlet pressure setting is at zero). Close solenoid valve 26 and open exhaust valve 28 and leave the isothermal tank 4 as it is until temperature and pressure in the tank reach steady-state conditions, then close exhaust valve 28.

6.2.2.2 Open shut-off valve 3 and set the inlet pressure, p_1 , using adjustable pressure regulator 2. Then adjust the component under test at the set pressure for the test. Measure the initial temperature, T_3 , using temperature measuring instrument 6 in isothermal tank 4 and the atmospheric pressure, p_a , using barometer 18.

6.2.2.3 Open solenoid valve 19 and allow compressed air to pass through the component under test into isothermal tank 4. Continuously record pressures for inlet (p_1) outlet (p_2), and isothermal tank (p_3) during this flow, using pressure transducers 12, 13 and 15 with digital recorder 17. Figure 2 is an idealized example of data recorded from a test run.

6.2.2.4 The temperature should be recorded to verify that the temperature variations are acceptable for an isothermal process during the charge test, using temperature measuring instrument 6 with digital recorder 17.

6.2.2.5 If the outlet pressure in Figure 2 shows an overshoot (see Annex D), the test data shall not be used to obtain the forward flow characteristics. The procedure of ISO 6953-2 should be used instead.

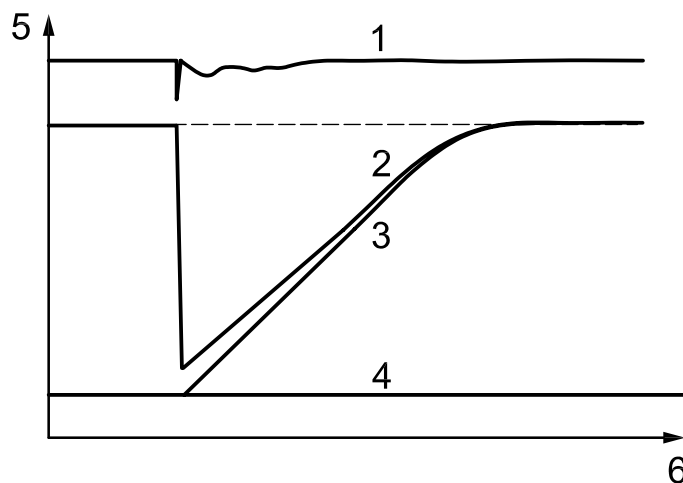

Key

- 1 inlet pressure
- 2 outlet pressure
- 3 pressure in the isothermal tank
- 4 atmospheric pressure
- 5 pressure scale
- 6 time scale

Figure 2 — Pressure response during charge

6.2.3 Relief flow characteristics test

6.2.3.1 Close solenoid valves 19, 20 and 27, open solenoid valve 26 and supply compressed air to isothermal tank 4 from adjustable pressure regulator 25. The supply pressure regulated by 25 shall be higher than the set pressure of the component under test by approximately 200 kPa. Leave isothermal tank 4 as it is until temperature and pressure in the tank reach steady-state conditions.

6.2.3.2 Close solenoid valve 26 and measure the initial temperature, T_3 , using temperature measuring instrument 6 in isothermal tank 4, and the atmospheric pressure, p_a , using barometer 18.

6.2.3.3 Open solenoid valve 19 and allow compressed air to pass from the isothermal tank 4 through the relief port of the component under test. Continuously record pressures for inlet (p_1), outlet (p_2), relief (p_4), and isothermal tank (p_3) during this flow using pressure transducers 12, 13, 15 and 14 with digital recorder 17. Figure 3 is an idealized example of data recorded from a test run.

6.2.3.4 The temperature should be recorded to verify that the temperature variations are acceptable for an isothermal process during a discharge test using temperature measuring instrument 6 with digital recorder 17.

6.2.3.5 If the outlet pressure in Figure 3 shows an undershoot (see Annex D), the test data shall not be used to obtain the relief flow characteristics. The procedure of ISO 6953-2 should be used instead.

6.2.3.6 When the relief capacity of the component under test is very small, items 5, 7, 16, 20, 27 and 29 should be used instead of items 4, 6, 15, 19, 26 and 28.

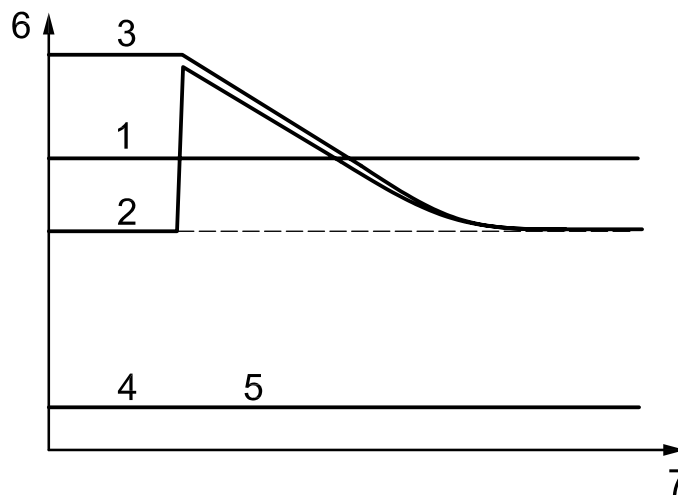

Key

- 1 inlet pressure
- 2 outlet pressure
- 3 pressure in the isothermal tank
- 4 relief pressure
- 5 atmospheric pressure
- 6 pressure scale
- 7 time scale

Figure 3 — Pressure response during discharge

6.2.4 Other set pressures

Repeat the above procedures at other outlet pressure set points. These set points shall be adjusted at no flow conditions, and should be made with an increase in the set pressure. If the set pressure is decreased, the pressure must be lowered well below the desired set point; then increased to the desired setting.

- For test components with only forward flow capability (such as non-relieving pressure regulators), repeat the procedures of 6.2.2 for other set pressures.
- For test components with only relief flow capability (such as relief valves), repeat the procedures of 6.2.3 for other set pressures.

— For test components with both forward flow and relief flow capabilities (such as relieving pressure regulators), repeat the procedures of 6.2.2 and 6.2.3 for other set pressures.

6.3 Calculation of characteristics

6.3.1 Calculation of flow rate

The characteristic curve is represented by the outlet pressure and flow rate, calculated from the pressure data in the isothermal tank. Data processing procedures are described in Annex C.

6.3.1.1 Data processing interval

Calculate the data processing interval for smoothing by the following equation:

$$\omega = \sqrt{n} \tag{2}$$

where

- n is the number of pressure response data points (square of an even number);
- ω is the data processing interval (even number).

6.3.1.2 Smoothing of outlet pressure data

Calculate to smooth the regulated pressure with the following moving average and median processing:

$$p'_{2(j)} = \frac{1}{\omega+1} \sum_{i=j-\frac{\omega}{2}}^{j+\frac{\omega}{2}} p_{2(i)} \tag{3}$$

$$p''_{2(k)} = \text{Median} \left(p'_{2\left(k-\frac{\omega}{2}\right)}, p'_{2\left(k-\frac{\omega}{2}+1\right)}, \dots, p'_{2\left(k+\frac{\omega}{2}\right)} \right) \tag{4}$$

where

- $p_{2(i)}$ is the outlet pressure (Pa) ($i = 1, 2, \dots, n-1, n$)
- $p'_{2(j)}$ is the outlet pressure after the moving average processing (Pa) ($j = \omega/2+1, \omega/2+2, \dots, n-\omega/2-1, n-\omega/2$)
- $p''_{2(k)}$ is the outlet pressure after the median processing (Pa) ($k = \omega+1, \omega+2, \dots, n-\omega-1, n-\omega$)

6.3.1.3 Smoothing of flow-rate data

Calculate the flow rate using Formula (6) after smoothing the pressure in the isothermal tank with the moving average using Formula (5) and smoothing the flow rate with median processing Formula (7).

$$p'_{3(j)} = \frac{1}{\omega+1} \sum_{i=j-\frac{\omega}{2}}^{j+\frac{\omega}{2}} p_{3(i)} \tag{5}$$

$$q_{v(j)} = \frac{V}{\rho_0 RT_3} \frac{p'_{3(j+1)} - p'_{3(j-1)}}{2\Delta t} \tag{6}$$

$$q'_{v(k)} = \text{Median} \left(q_v \left(k - \frac{\omega}{2} \right), q_v \left(k - \frac{\omega}{2} + 1 \right), \dots, q_v \left(k + \frac{\omega}{2} \right) \right) \quad (7)$$

where

- $p_{3(i)}$ is the pressure in the tank [Pa] ($i = 1, 2, \dots, n-1, n$);
- $p'_{3(j)}$ is the pressure in the tank after moving average processing [Pa] ($j = \omega/2+1, \omega/2+2, \dots, n-\omega/2-1, n-\omega/2$);
- $q_{v(j)}$ is the volumetric flow rate at standard reference atmosphere [$\text{m}^3/\text{s}(\text{ANR})$] ($j = \omega/2+2, \omega/2+3, \dots, n-\omega/2-2, n-\omega/2-1$);
- $q'_{v(k)}$ is the volumetric flow rate after median processing [$\text{m}^3/\text{s}(\text{ANR})$] ($k = \omega+2, \omega+3, \dots, n-\omega-2, n-\omega-1$);
- Δt is the sampling time for the pressure data [s];
- V is the isothermal tank volume [m^3];
- R is the gas constant [287 J/(kg·K) for air];
- T_3 is the absolute temperature in the tank [K];
- ρ_0 is the mass density of air at standard reference atmosphere [1,185 kg/ m^3].

6.3.2 Characteristic curve

The volumetric flow rate shall be indicated by curves on a graph as shown in Figure 4. Each curve describes the outlet pressure versus volumetric flow rate for given inlet pressure.

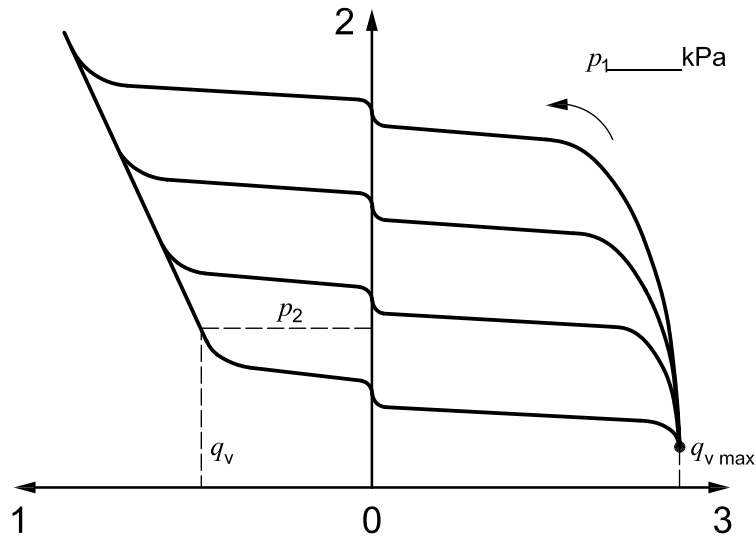

Key

- 1 relief flow rate
- 2 outlet pressure
- 3 forward flow rate
- p_1 inlet pressure
- p_2 outlet pressure
- q_v flow rate
- $q_{v \max}$ maximum flow rate

NOTE These curves correspond to the upper flow of the hysteresis characteristic curve of ISO 6953-1.

Figure 4 — Flow-rate characteristics

6.3.3 Forward sonic conductance

6.3.3.1 Graphically determine the maximum forward flow rate, $q_{v \max}$, as the intersection of an extension line of the forward flow characteristics curve obtained in 6.3.2 with the abscissa axis as shown in Figure 4. If all curves do not converge toward the same point, select the maximum forward flow rate as $q_{v \max}$.

6.3.3.2 Calculate the value of forward sonic conductance, C_f , by dividing this flow rate by the inlet pressure, p_1 , used in the test, from the following equation:

$$C_f = \frac{q_{v \max}}{(p_1 + p_a)} \sqrt{\frac{T_3}{T_0}} \tag{8}$$

6.3.4 Relief sonic conductance

6.3.4.1 Choose three points along the asymptotic part of the several relief flow characteristics curves in Figure 4. For each point, determine the pair of values for the flow rate, q_v , and regulated pressure, p_2 .

6.3.4.2 For each one of these points, calculate the corresponding relief sonic conductance, C_r , value by dividing the flow rate by pressure, p_2 , according to ISO 6358-1, using the following equation:

$$C_r = \frac{q_v}{(p_2 + p_a)} \sqrt{\frac{T_3}{T_0}} \tag{9}$$

6.3.4.3 Calculate relief sonic conductance by determining the average value of these three values.

7 Presentation of test results

7.1 Data graphs of forward flow and/or relief flow shall be presented in accordance with ISO 6953-1.

7.2 The following performance characteristics calculated in accordance with 6.3.3 and 6.3.4 shall be stated:

- a) forward sonic conductance, C_f ,
- b) relief sonic conductance, C_r .

7.3 All special conditions used in the test shall be indicated in the test report.

8 Identification statement

Use the following statement in test reports, catalogues and sales literature when electing to comply with this part of ISO 6953.

*“Test for the determination of flow-rate characteristics conforms to ISO 6953-3, *Pneumatic fluid power — Compressed air pressure regulators and filter-regulators — Part 3: Alternative test methods for measuring the flow-rate characteristics of pressure regulators.*”*

Annex A (informative)

Examples of test results

A.1 Test result of component (A)

Figure A.1 shows the structure of direct operated regulator (A) of a body size of G1/2 with the relieving mechanism.

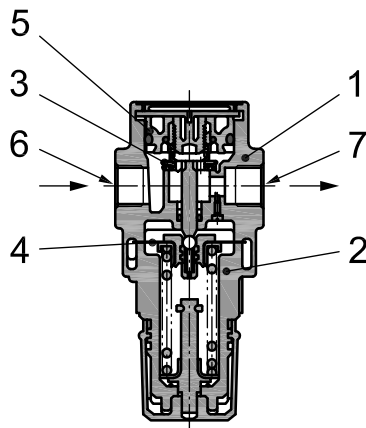

Key

- 1 body
- 2 bonnet
- 3 valve assembly
- 4 diaphragm assembly
- 5 valve guide assembly
- 6 in
- 7 out

Figure A.1 — Component (A)

Figure A.2 shows the pressure response when charging air to an isothermal tank of 134 dm³ by opening the solenoid valve after setting inlet pressure at 0,63 MPa and regulated pressure at 0,5 MPa.

Since component (A) has an extremely small relief flow capacity without port, the circuit is switched to the bypass discharge having an isothermal tank of 10 dm³ to shorten the testing time. The high-pressure supply line for relief is set at 0,75 MPa, and air is supplied to the small tank. The pressure response when discharging air to the atmosphere from component (A) is shown in Figure A.3.

Figure A.4 shows the flow-rate characteristics obtained both from the pressure response when setting component (A) at 0,16 MPa, 0,25 MPa, 0,4 MPa, and 0,5 MPa, and from the test results of the flow-rate measurement based on ISO 6953-2. The characteristics curves obtained by calculating are in good agreement with the results of the flow-rate measurement.

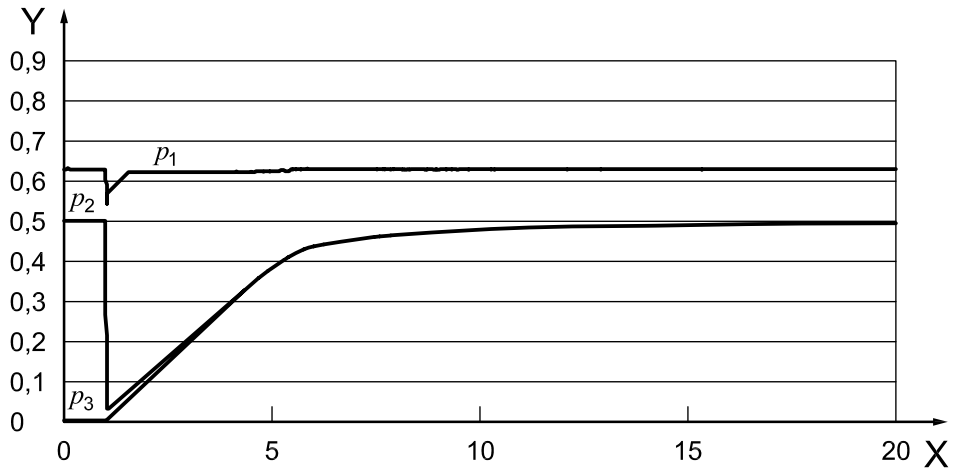

Key

X time [s]
 Y pressure [MPa]

Figure A.2 — Pressure response during charge – component (A)

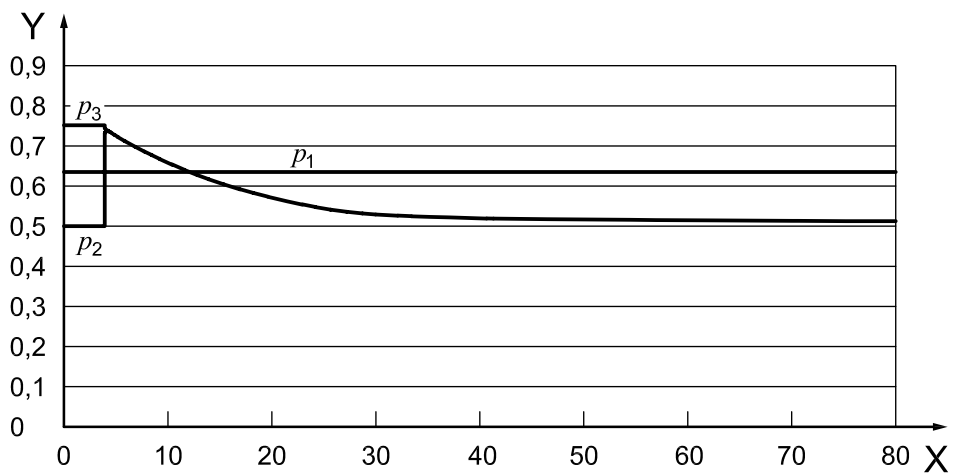

Key

X time [s]
 Y pressure [MPa]

Figure A.3 — Pressure response during discharge – component (A)

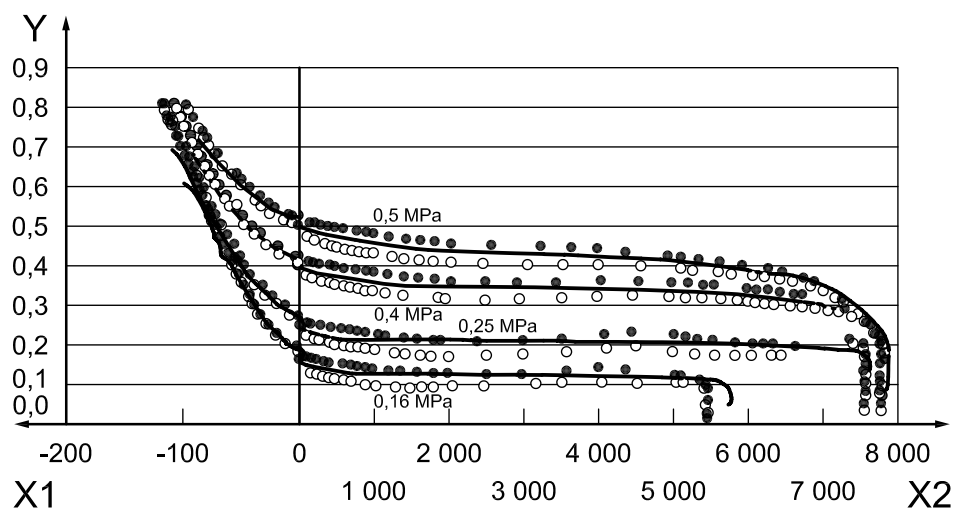

Key

X1 relief flow rate [dm³/min(ANR)]

X2 forward flow rate [dm³/min(ANR)]

Y regulated pressure, p_2 [MPa]

Flow-rate measurement by ISO 6953-2

○ 0 to max. flow rate

● max. flow rate to 0

— flow-rate calculation by ISO 6953-3

Inlet pressure $p_1 = 0,63$ MPa

Figure A.4 — Flow-rate characteristics of component (A)

A.2 Test result of component (B)

Figure A.5 shows the structure of the internal pilot type regulator (B) of a body size of G1/4 with a nozzle-flapper type relieving mechanism.

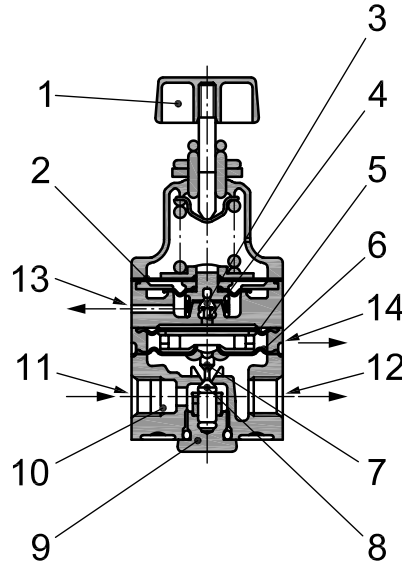

Key

1	setting knob	8	main valve
2	diaphragm (A)	9	valve guide
3	steel ball	10	damper
4	nozzle	11	SUP(1)
5	diaphragm (B)	12	out
6	diaphragm (C)	13	bleed
7	exhaust valve	14	exhaust

Figure A.5 — Component (B)

Figure A.6 shows the pressure response when charging air to an isothermal tank of 20 dm³ after setting inlet pressure at 0,63 MPa and regulated pressure at 0,5 MPa.

Figure A.7 shows the pressure response when air is discharged to the atmosphere from test component (B) without port after the high-pressure supply line for relief is set at 0,92 MPa, and air is supplied to an isothermal tank of 10 dm³.

Figure A.8 shows the flow-rate characteristics obtained both from the pressure response when setting regulator (B) at 0,16 MPa, 0,25 MPa, 0,4 MPa, and 0,5 MPa, and from the results of the flow-rate measurement based on ISO 6953-2. The characteristics curves for component (B) are in good agreement with the results of the flow-rate measurement.

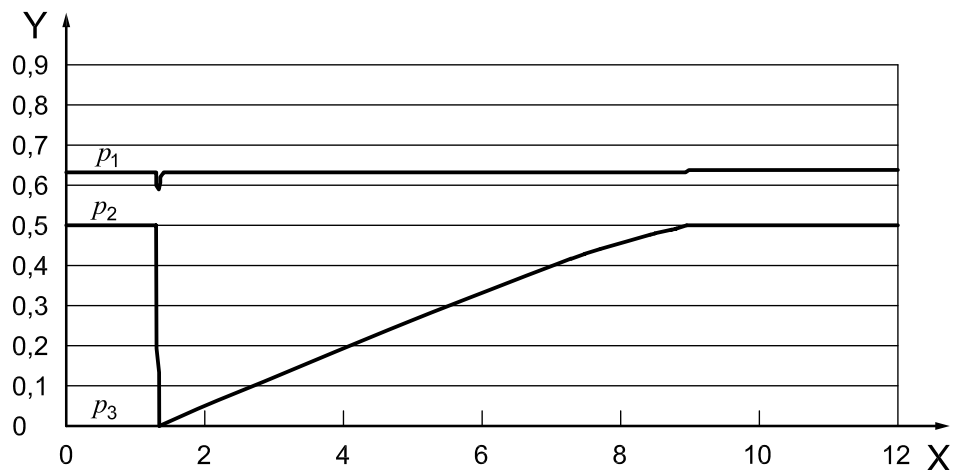

Key

X time [s]

Y pressure [MPa]

Figure A.6 — Pressure response during charge – component (B)

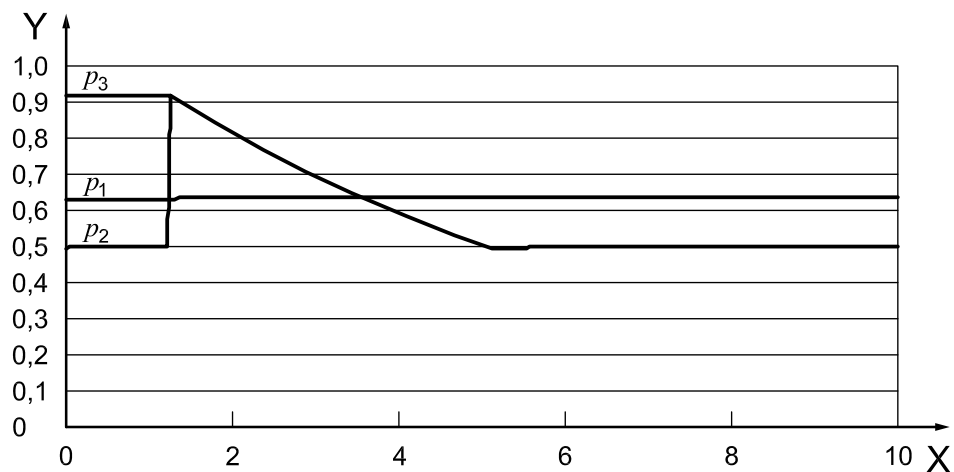

Key

X time [s]

Y pressure [MPa]

Figure A.7 — Pressure response during discharge – component (B)

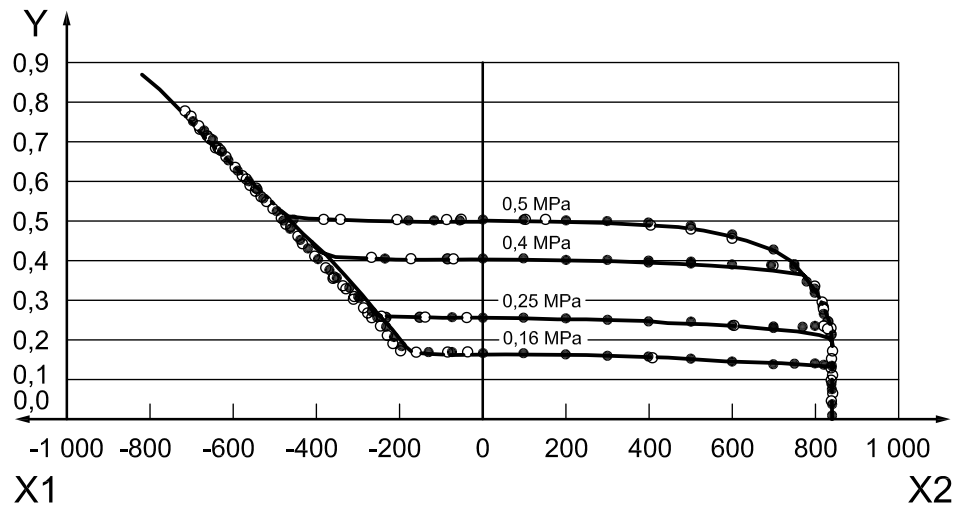
**Key**X1 relief flow rate [dm³/min(ANR)]X2 forward flow rate [dm³/min(ANR)]Y regulated pressure, p_2 [MPa]

Flow-rate measurement by ISO 6953-2

○ 0 to max. flow rate

● max. flow rate to 0

— flow-rate calculation by ISO 6953-3

Inlet pressure $p_1 = 0,63$ MPa**Figure A.8 — Flow-rate characteristics of component (B)**

A.3 Test result of component (C)

Figure A.9 shows the structure of the proportional solenoid type electro-pneumatic pressure control valve of a body size of G1/4.

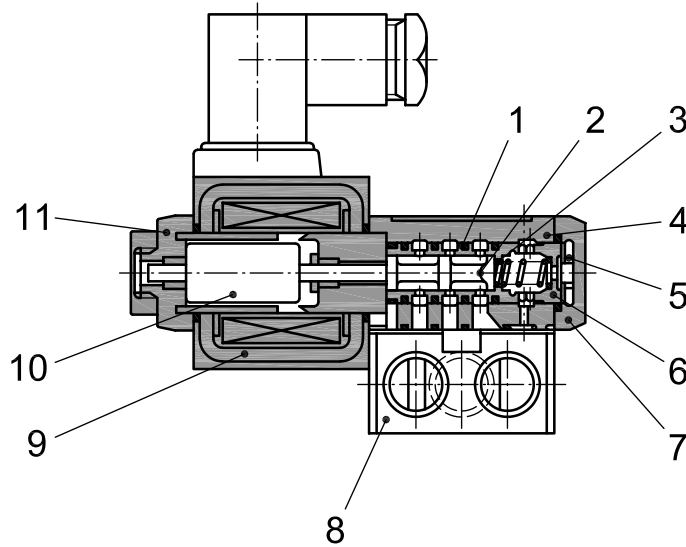

Key

- | | |
|---------------|--------------------------|
| 1 sleeve | 7 bush |
| 2 spool | 8 sub-plate |
| 3 spring | 9 mold coil |
| 4 body | 10 movable core assembly |
| 5 end cover | 11 solenoid cap assembly |
| 6 set bushing | |

Figure A.9 — Component (C)

Figure A.10 shows the pressure response when charging air to an isothermal tank of 20 dm³ after setting inlet pressure at 0,63 MPa and regulated pressure at 0,5 MPa.

Figure A.11 shows the pressure response when air is discharged to the atmosphere from component (C) after the high-pressure supply line for relief is set at 0,92 MPa and air is supplied to an isothermal tank of 10 dm³. Relief pressure, p_4 , is measured at the pressure-measuring tube.

Figure A.12 shows the flow-rate characteristics obtained both from the pressure response when setting component (C) at 0,16 MPa, 0,25 MPa, 0,4 MPa, and 0,5 MPa, and from the results of the flow-rate measurement based on ISO 6953-2. The characteristics curves for component (C) are in good agreement with the results of the flow-rate measurement.

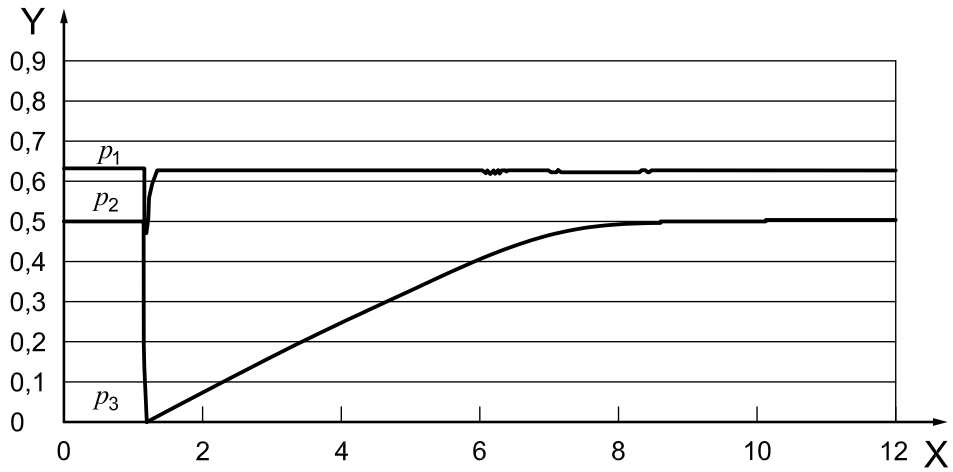

Key
 X time [s]
 Y pressure [MPa]

Figure A.10 — Pressure response during charge – component (C)

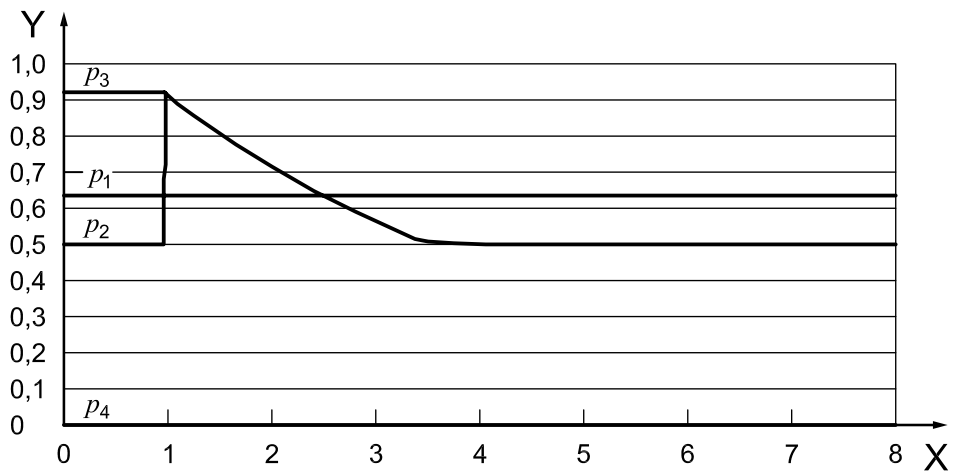

Key
 X time [s]
 Y pressure [MPa]

Figure A.11 — Pressure response during discharge – component (C)

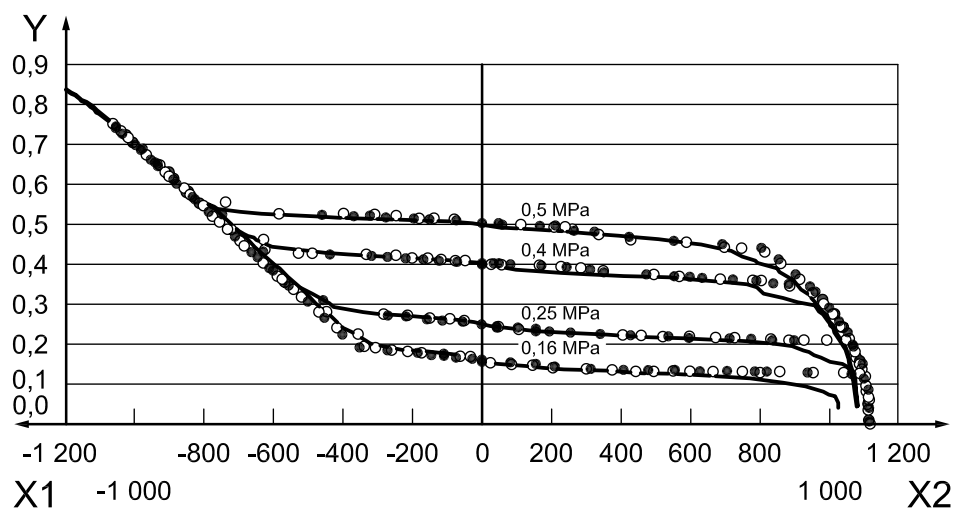

Key

- X1 relief flow rate [dm³/min(ANR)]
- X2 forward flow rate [dm³/min(ANR)]
- Y regulated pressure, p_2 [MPa]

Flow-rate measurement by ISO 6953-2

- 0 to max. flow rate
- max. flow rate to 0
- flow-rate calculation by ISO 6953-3

Inlet pressure $p_1 = 0,63$ MPa

Figure A.12 — Flow-rate characteristics of component (C)

A.4 Test result of component (D)

Figure A.13 shows the structure of the external pilot type regulator of a body size of G1/4 with the external pilot mechanism.

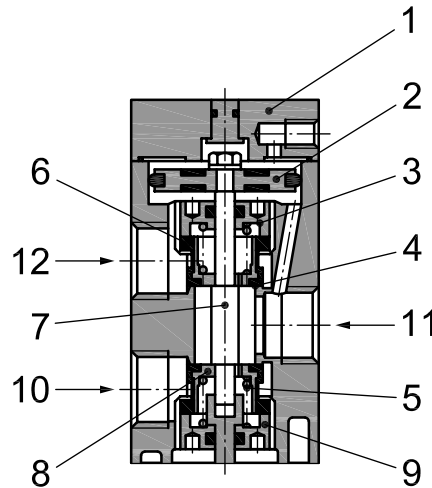

Key

1	body	7	shaft
2	regulation piston	8	poppet valve
3	valve guide	9	valve guide
4	poppet valve	10	inlet port
5	spring	11	outlet port
6	spring	12	relief port

Figure A.13 — Component (D)

Figure A.14 shows the pressure response when charging air to an isothermal tank of 20 dm³ after setting inlet pressure at 0,63 MPa and regulated pressure at 0,5 MPa.

Figure A.15 shows the pressure response when air is discharged to the atmosphere from component (D) after the high-pressure supply line for relief is set at 0,92 MPa and air is supplied to an isothermal tank of 20dm³. Relief pressure, p_4 , is measured at the pressure-measuring tube.

Figure A.16 shows the flow-rate characteristics obtained both from the pressure response when setting component (D) at 0,16 MPa, 0,25 MPa, 0,4 MPa, and 0,5 MPa, and from the results of the flow-rate measurement based on ISO 6953-2. The characteristics curves for component (D) are in good agreement with the results of the flow-rate measurement.

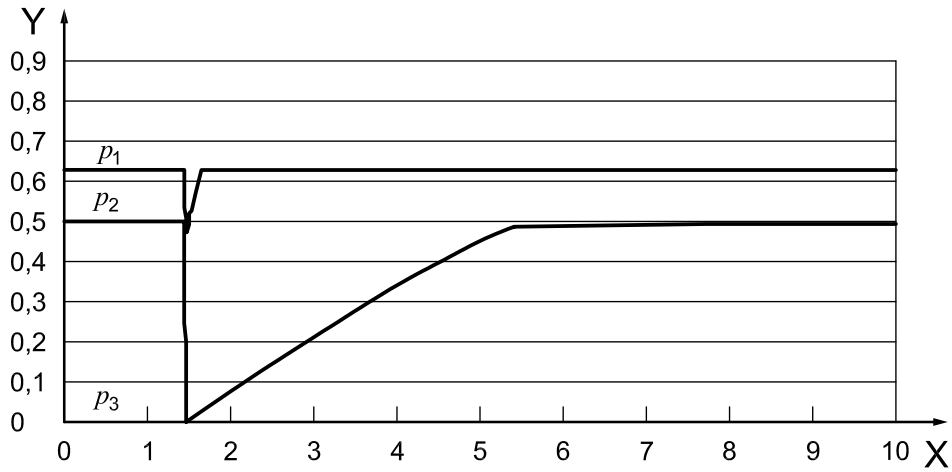

Key

X time [s]

Y pressure [MPa]

Figure A.14 — Pressure response during charge – component (D)

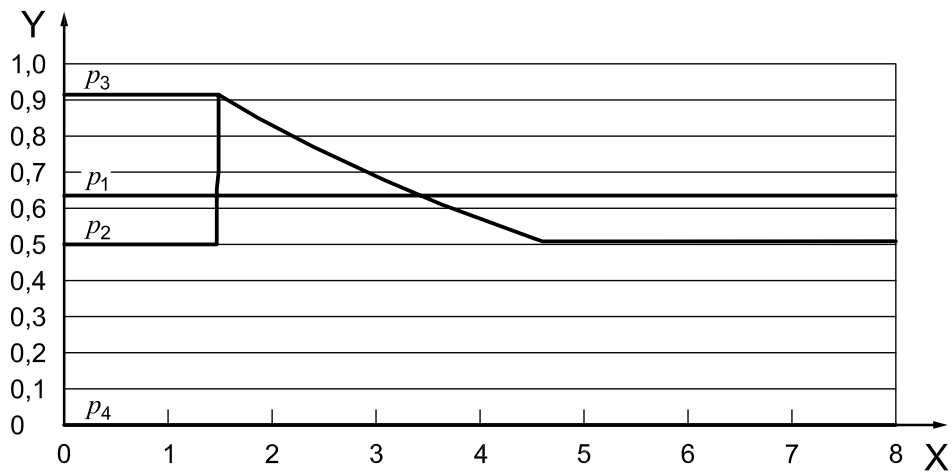

Key

X time [s]

Y pressure [MPa]

Figure A.15 — Pressure response during discharge – component (D)

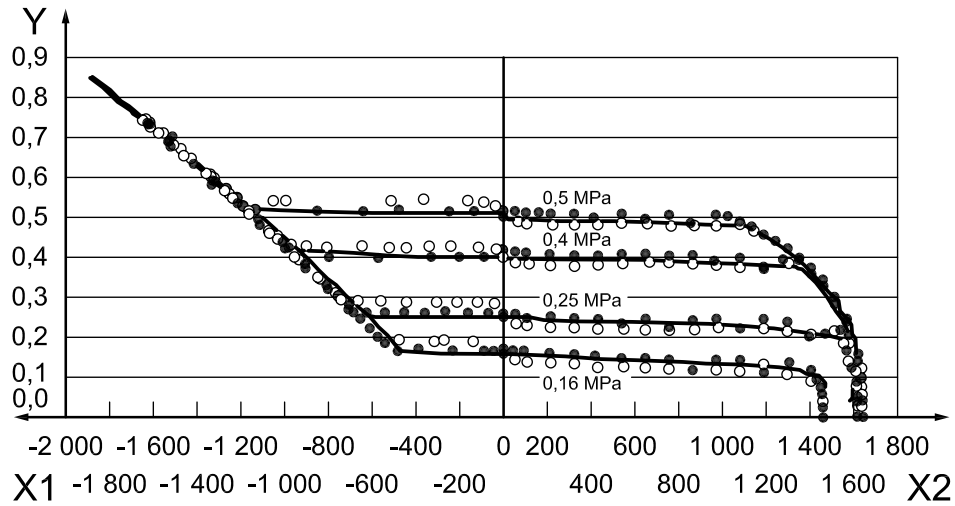

Key

- X1 relief flow rate [dm³/min(ANR)]
- X2 forward flow rate [dm³/min(ANR)]
- Y regulated pressure, p_2 [MPa]

Flow-rate measurement by ISO 6953-2

- 0 to max. flow rate
- max. flow rate to 0
- flow-rate calculation by ISO 6953-3

Inlet pressure $p_1 = 0,63$ MPa

Figure A.16 — Flow-rate characteristics of component (D)

A.5 Test result of component (E)

Figure A.17 shows the structure of direct operated filter-regulator (E) of a body size of G1/2 with the relieving mechanism.

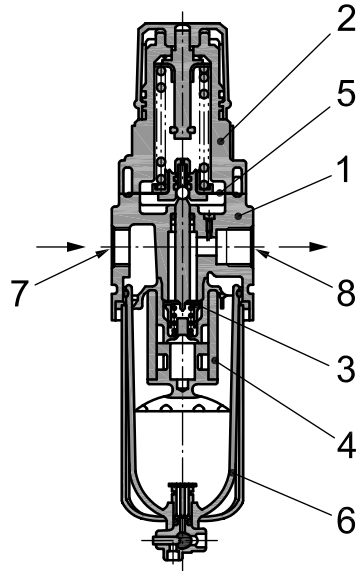

Key

- 1 body
- 2 bonnet
- 3 valve assembly
- 4 filter element
- 5 diaphragm assembly
- 6 bowl assembly
- 7 in
- 8 out

Figure A.17 — Component (E)

Figure A.18 shows the pressure response when charging air to an isothermal tank of 50 dm³ after setting inlet pressure at 0,63 MPa and regulated pressure at 0,5 MPa.

Figure A.19 shows the pressure response when discharging air to the atmosphere from component (E). Since component (E) has an extremely small relief flow capacity without port, the circuit is switched to the bypass discharge having an isothermal tank of 10 dm³ to shorten the testing time. The high-pressure supply line for relief is set at 0,8 MPa, and air is supplied to the small tank.

Figure A.20 shows the flow-rate characteristics obtained both from the pressure response when setting component (E) at 0,16 MPa, 0,25 MPa, 0,4 MPa, and 0,5 MPa, and from the results of the flow-rate measurement based on ISO 6953-2. The characteristics curves for component (E) are in good agreement with the results of the flow-rate measurement.

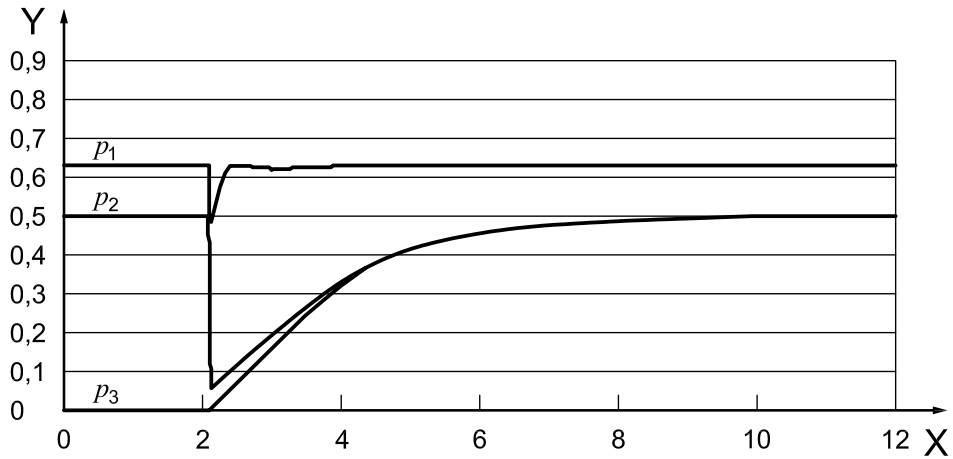

Key

X time [s]
 Y pressure [MPa]

Figure A.18 — Pressure response during charge – component (E)

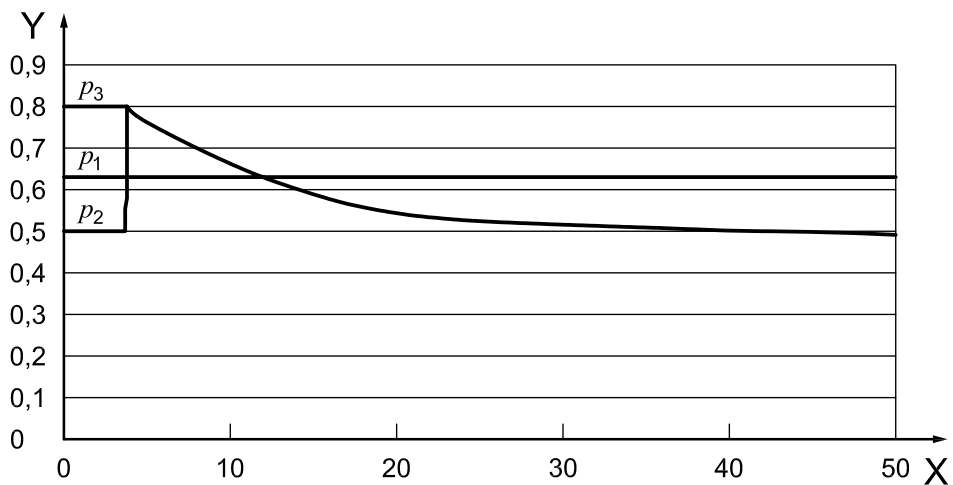

Key

X time [s]
 Y pressure [MPa]

Figure A.19 — Pressure response during discharge – component (E)

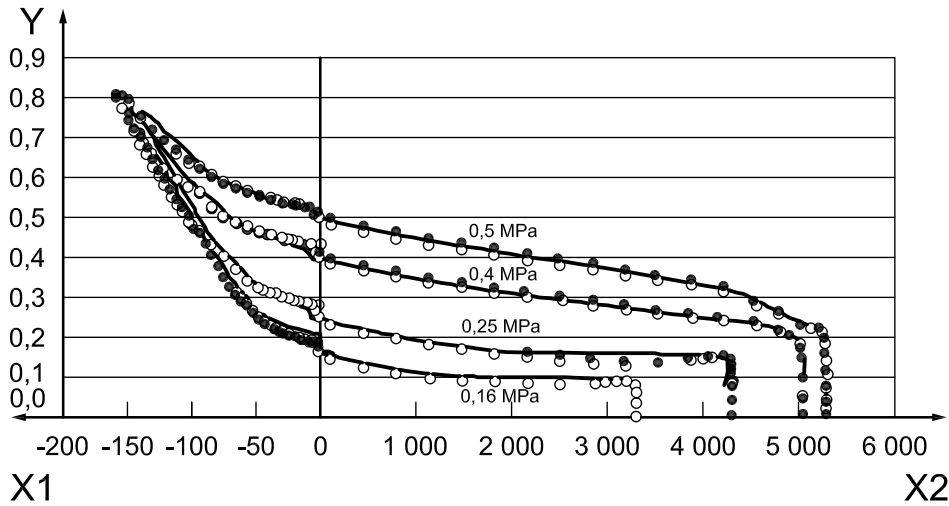

Key

- X1 relief flow rate [dm³/min(ANR)]
- X2 forward flow rate [dm³/min(ANR)]
- Y regulated pressure, p_2 [MPa]

Flow-rate measurement by ISO 6953-2

- 0 to max. flow rate
- max. flow rate to 0
- flow-rate calculation by ISO 6953-3

Inlet pressure $p_1 = 0,63$ MPa

Figure A.20 — Flow-rate characteristics of component (E)

A.6 Characteristics parameters

As shown in Figure A.21 when the forward flow-rate characteristics of the regulator are approximated to the regression lines L_1 and L_2 , and the relief flow-rate characteristics to the regression lines L_3 and L_4 , calculated characteristics parameters of the regulator are obtained as shown in Table A.1.

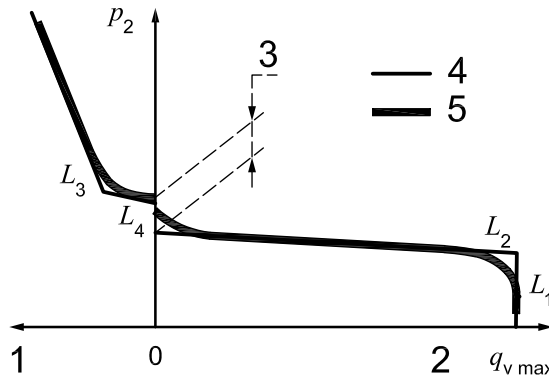

Key

- 1 relief flow rate
- 2 forward flow rate
- 3 dead zone
- 4 regression line
- 5 flow-rate characteristics

Figure A.21 — Definitions of the characteristics parameters

Table A.1 — Characteristics parameters of the regulators

Parameter	Component				
	(A)	(B)	(C)	(D)	(E)
Forward sonic conductance C_f dm ³ /(s·bar)(ANR)	17,8	1,92	2,49	3,70	12,1
Forward slope K_f (Gradient of regression L_2) kPa/dm ³ /min(ANR)	-0,0065	-0,020	-0,063	-0,014	-0,039
Relief sonic conductance C_r dm ³ /(s·bar)(ANR)	0,756	1,37	2,07	3,26	0,293
Relief slope K_r (Gradient of regression L_4) kPa/dm ³ /min(ANR)	1,08	0,0075	0,047	0,015	1,13
Dead zone P_b (Initial pressure difference between L_2 and L_4) kPa	78	3,5	4,6	4,4	25

The forward sonic conductance and relief sonic conductance represent the flow capacity of the regulator. The forward slope and relief slope represent the pressure regulating performance. The dead zone shows the initial pressure difference between the forward flow and relief flow. The components (A) and (E) are regulators for general purpose, which have extremely small relief flow capacity compared to the forward flow and have large dead zones. The component (B) is a regulator for a precision use, which has large relief capacity and extremely small dead zone.

A.7 Energy saving

The total testing time and the energy consumption — which covers the mounting of the component under test to the test installation, three repeated measurements, calculation, plotting, and removal of the component from the test installation — were measured. Compared to the ISO 6953-2 flow-rate measurement test, this test takes only one tenth the amount of time and consumes only one thirtieth the amount of air. It proves that this offers a time- and energy-saving test method.

Annex B (informative)

Various data processing methods

B.1 General

This annex shows examples of three kinds of data processing methods using the test results of the types of components under test. The third method yields the smoothest results in accordance with the flow-rate measurement results by ISO 6953-2. As a result, this method was adopted for 6.3.1.

B.2 Component (F): Direct operated pressure regulator

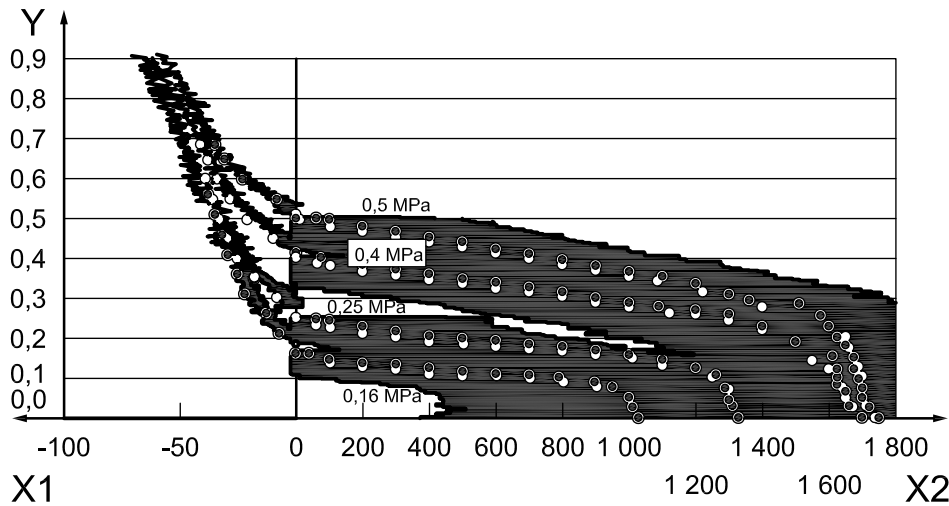

Key

- X1 relief flow rate [dm³/min(ANR)]
- X2 forward flow rate [dm³/min(ANR)]
- Y regulated pressure, p_2 [MPa]

Flow-rate measurement by ISO 6953-2

- 0 to max. flow rate
- max. flow rate to 0
- flow-rate calculation by ISO 6953-3

Inlet pressure $p_1 = 0,63$ MPa

Data processing conditions:

Processing data: Pressure in the isothermal tank p_3

Methods: Forward flow: 7 points moving average, Relief flow: 3 points moving average

Figure B.1 — Data processing example 1

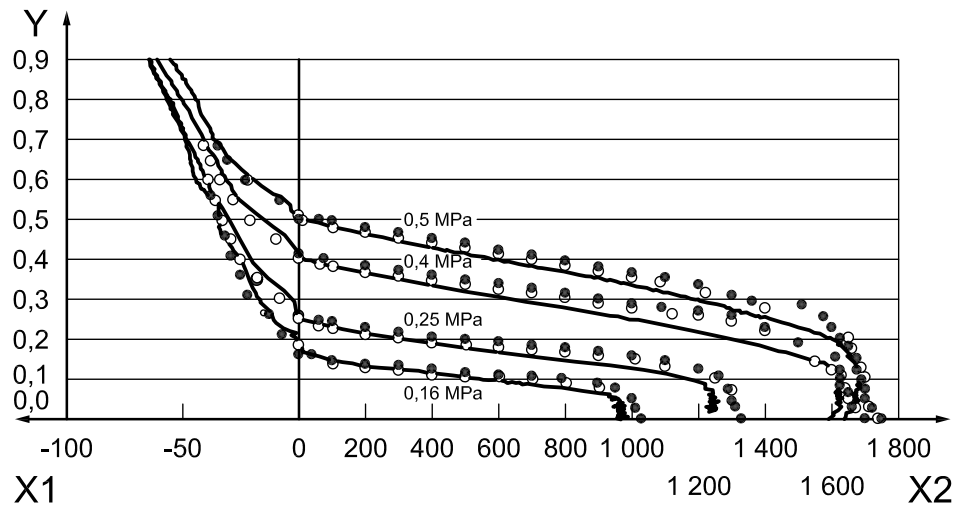
**Key**

- X1 relief flow rate [dm³/min(ANR)]
 X2 forward flow rate [dm³/min(ANR)]
 Y regulated pressure, p_2 [MPa]

Flow-rate measurement by ISO 6953-2

- 0 to max. flow rate
- max. flow rate to 0
- flow-rate calculation by ISO 6953-3

Inlet pressure $p_1 = 0,63$ MPa

Data processing conditions:

Processing data: Pressure in the isothermal tank p_3

Methods: Set pressures 0,16 MPa and 0,25 MPa – Forward flow: 25 points moving average, Relief flow: 10 points moving average

Set pressures 0,4 MPa and 0,5 MPa – Forward flow: 50 points moving average, Relief flow: 10 points moving average

Figure B.2 — Data processing example 2

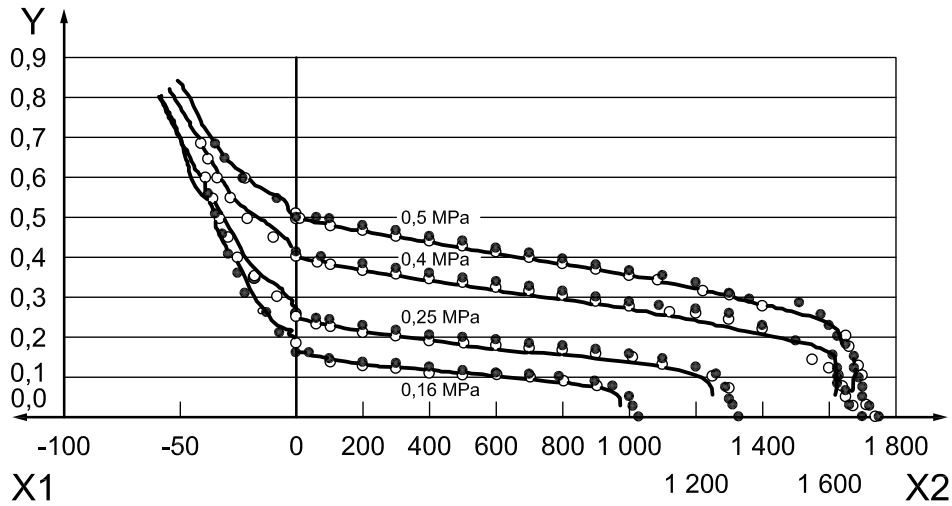

Key

- X1 relief flow rate [dm³/min(ANR)]
- X2 forward flow rate [dm³/min(ANR)]
- Y regulated pressure, p_2 [MPa]

Flow-rate measurement by ISO 6953-2

- 0 to max. flow rate
- max. flow rate to 0
- flow-rate calculation by ISO 6953-3

Inlet pressure $p_1 = 0,63$ MPa

Data processing conditions:

Processing data: Pressure in the isothermal tank p_3 , Regulated pressure p_2 , Flow rate q_v
 Method: In accordance with 6.3.1

Figure B.3 — Data processing in accordance with 6.3.1

B.3 Component (B): Internal pilot type pressure regulator

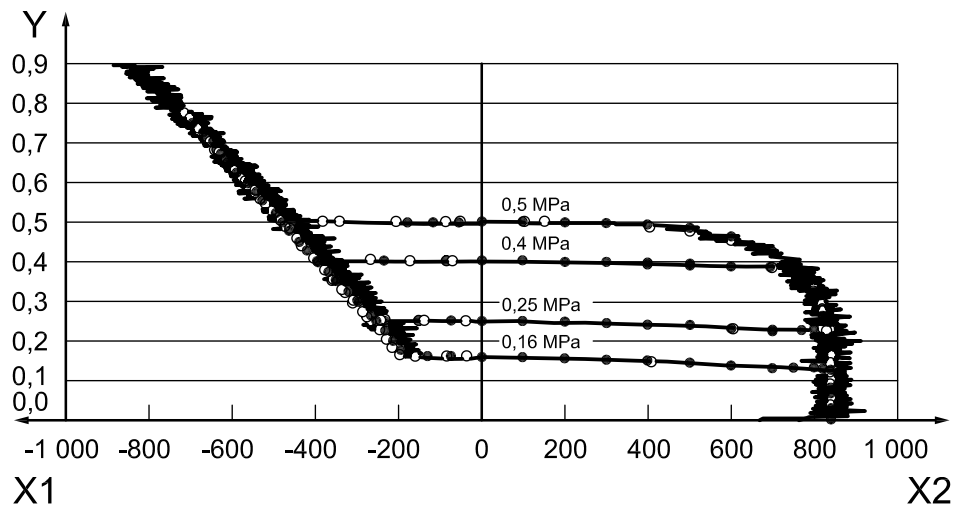

Key

- X1 relief flow rate [dm³/min(ANR)]
 X2 forward flow rate [dm³/min(ANR)]
 Y regulated pressure, p_2 [MPa]

Flow-rate measurement by ISO 6953-2

- 0 to max. flow rate
- max. flow rate to 0
- flow-rate calculation by ISO 6953-3

Inlet pressure $p_1 = 0,63$ MPa

Data processing conditions:

Processing data: Pressure in the isothermal tank p_3

Methods: Forward flow: 5 points moving average, Relief flow: 3 points moving average

Figure B.4 — Data processing example 1

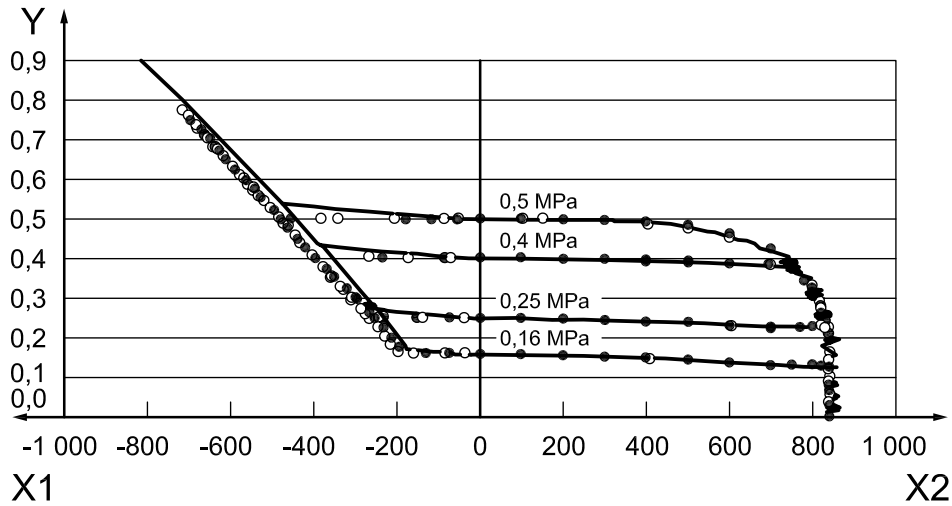

Key

- X1 relief flow rate [dm³/min(ANR)]
- X2 forward flow rate [dm³/min(ANR)]
- Y regulated pressure, p_2 [MPa]

Flow-rate measurement by ISO 6953-2

- 0 to max. flow rate
- max. flow rate to 0
- flow-rate calculation by ISO 6953-3

Inlet pressure $p_1 = 0,63$ MPa

Data processing conditions:

Processing data: Pressure in the isothermal tank p_3

Methods: Forward flow: 10 points moving average, Relief flow: 30 points moving average

Calculate by the following first-order lag filter after moving average processing:

$$f_{out}(i) = \exp\left(-\frac{\Delta t}{1/f_{cutoff}}\right) f_{out}(i-1) + \left(1 - \exp\left(-\frac{\Delta t}{1/f_{cutoff}}\right)\right) f_{in}(i)$$

Cut-off frequency $f_{cutoff} = 20$ Hz; sampling time $\Delta t = 0,02$ s

Figure B.5 — Data processing example 2

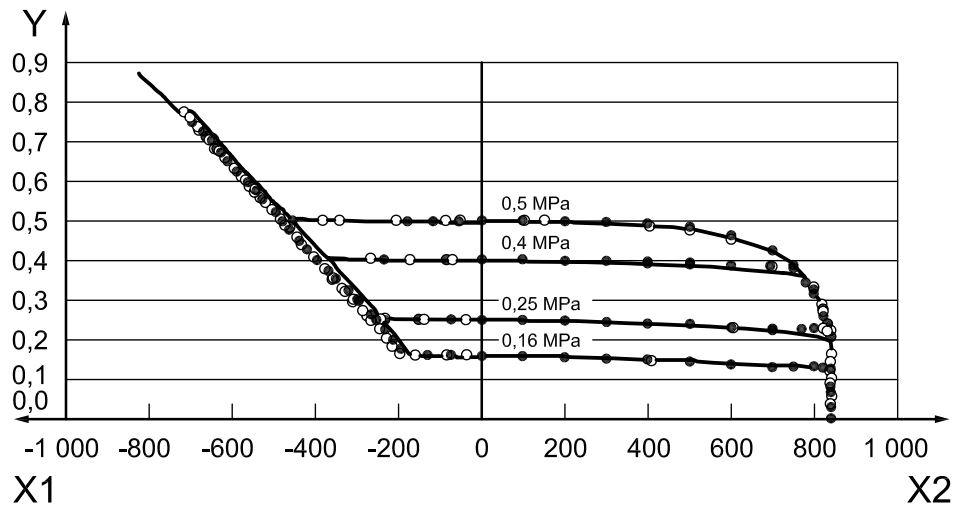
**Key**

- X1 relief flow rate [dm³/min(ANR)]
 X2 forward flow rate [dm³/min(ANR)]
 Y regulated pressure, p_2 [MPa]

Flow-rate measurement by ISO 6953-2

- 0 to max. flow rate
- max. flow rate to 0
- flow-rate calculation by ISO 6953-3

Inlet pressure $p_1 = 0,63$ MPa

Data processing conditions:

Processing data: Pressure in the isothermal tank p_3 , Regulated pressure p_2 , Flow rate q_v
 Method: In accordance with 6.3.1

Figure B.6 — Data processing in accordance with 6.3.1

B.4 Component (C): Electro-pneumatic pressure control valve

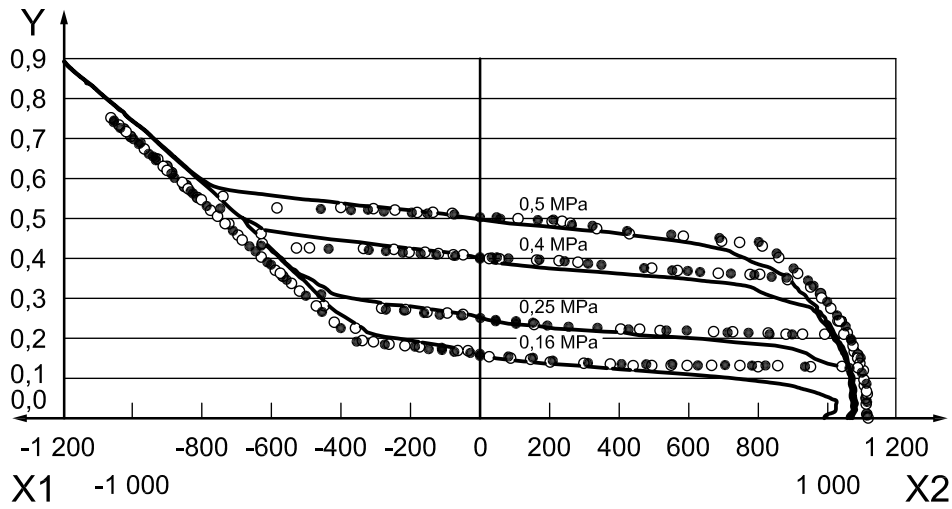

Key

- X1 relief flow rate [dm³/min(ANR)]
- X2 forward flow rate [dm³/min(ANR)]
- Y regulated pressure, p_2 [MPa]

Flow-rate measurement by ISO 6953-2

- 0 to max. flow rate
- max. flow rate to 0
- flow-rate calculation by ISO 6953-3

Inlet pressure $p_1 = 0,63$ MPa

Data processing conditions:

Processing data: Pressure in the isothermal tank p_3

Methods: Forward flow: 25 points moving average, Relief flow: 25 points moving average

Figure B.7 — Data processing example 1

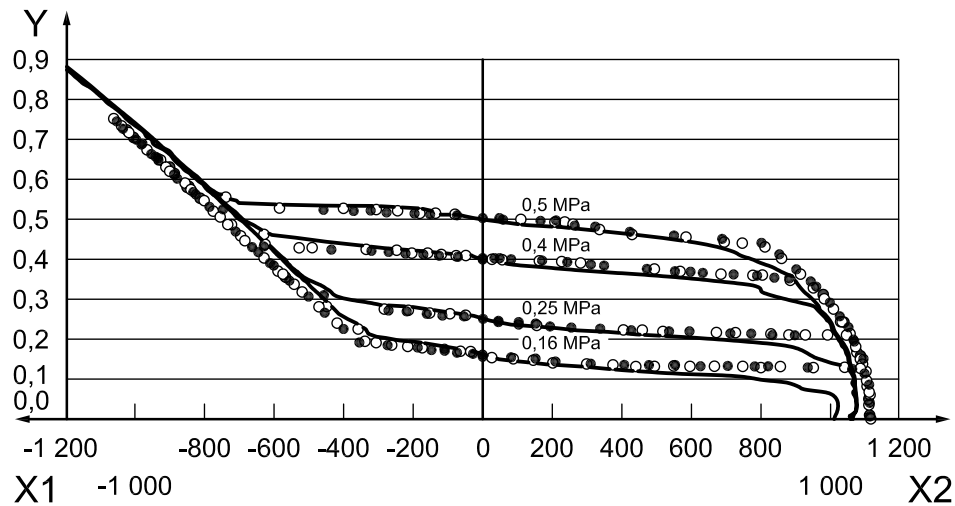

Key

- X1 relief flow rate [dm³/min(ANR)]
 X2 forward flow rate [dm³/min(ANR)]
 Y regulated pressure, p_2 [MPa]

Flow-rate measurement by ISO 6953-2

- 0 to max. flow rate
- max. flow rate to 0
- flow-rate calculation by ISO 6953-3

Inlet pressure $p_1 = 0,63$ MPa

Data processing conditions:

Processing data: Pressure in the isothermal tank p_3 , Flow rate q_v

Methods: p_3 : IIR filter phase compensation (Cut-off frequency $f_{cutoff} = 20$ Hz)

q_v : 21 points Moving average

NOTE IIR(Infinite Impulse Response) filter is the digital filter.

Figure B.8 — Data processing example 2

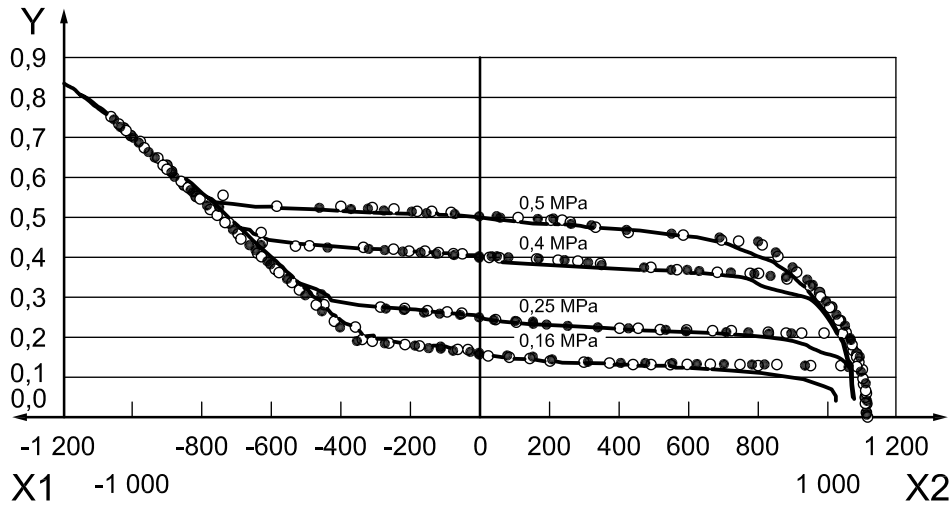

Key

- X1 relief flow rate [dm³/min(ANR)]
- X2 forward flow rate [dm³/min(ANR)]
- Y regulated pressure, p_2 [MPa]

Flow-rate measurement by ISO 6953-2

- 0 to max. flow rate
- max. flow rate to 0
- flow-rate calculation by ISO 6953-3

Inlet pressure $p_1 = 0,63$ MPa

Data processing conditions:

Processing data: Pressure in the isothermal tank p_3 , Regulated pressure p_2 , Flow rate q_v

Methods: In accordance with 6.3.1

Figure B.9 — Data processing in accordance with 6.3.1

Annex C (informative)

Visualization of data processing procedures

C.1 Data processing procedures

Figure C.1 shows data processing procedures in 6.3.1. This data processing is useful for smoothing the measurement data.

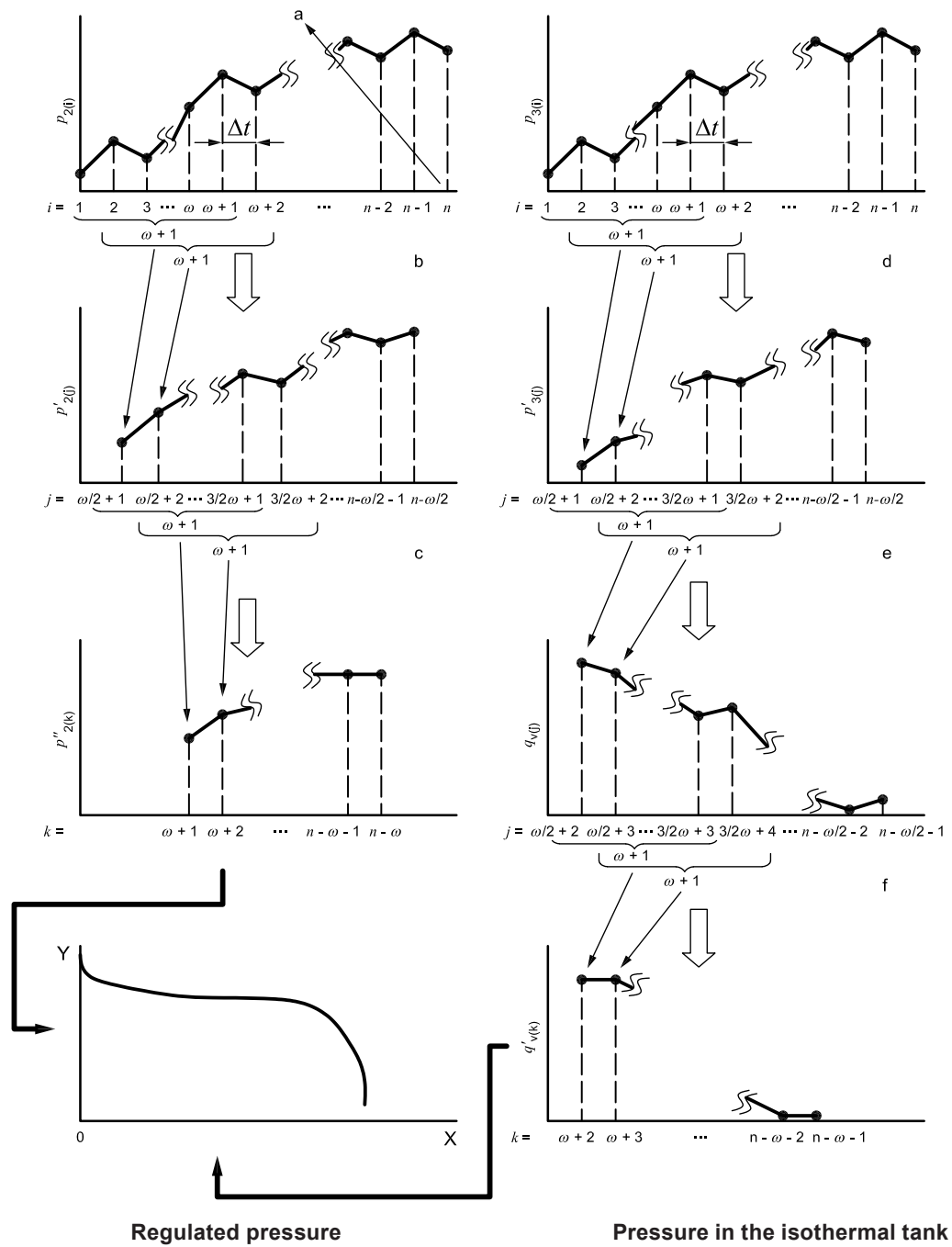

- a Formula (2) — Data processing interval.
- b Formula (3) — Moving average processing.
- c Formula (4) — Median processing.
- d Formula (5) — Moving average processing.
- e Formula (6) — Flow rate.
- f Formula (7) — Median processing.

Figure C.1 — Data processing procedures

C.2 Median processing

Median means a middle value when the values in an interval are arranged in ascending order. See Figure C.2.

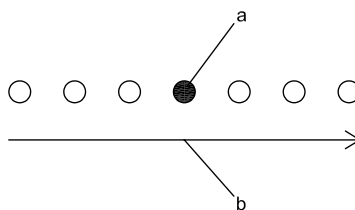

^a The median value is the middle value.

^b The values in the interval are arranged in ascending order, from the smallest to the largest.

Figure C.2 — Median processing

Annex D (informative)

Illustrations of overshoot and undershoot on regulated pressure response and large variations on inlet pressure

D.1 Illustration of overshoot and undershoot on regulated pressure response

Overshoot or undershoot on pressure response might occur when the component under test has a structure such that the pressure dynamics is slow.

Figure D.1 shows an example of a pressure response when charging air to an isothermal tank of 21 dm³ by opening the solenoid valve after setting inlet pressure at 0,8 MPa and regulated pressure at 0,63 MPa. The pressure response of the regulator under test shows an overshoot of the regulated pressure, p_2 .

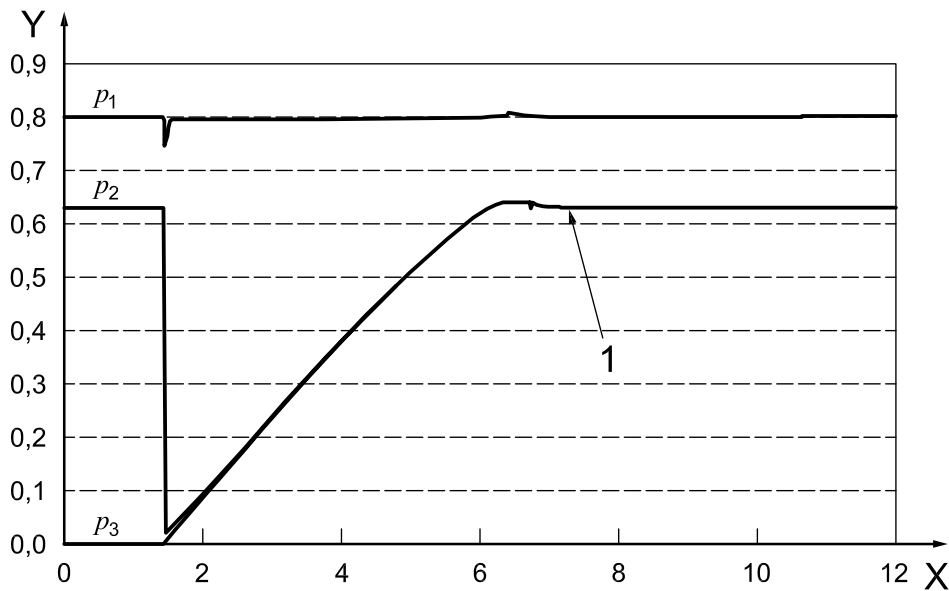

Key

- 1 overshoot
- X time [s]
- Y pressure [MPa]

Figure D.1 — Pressure response during charge

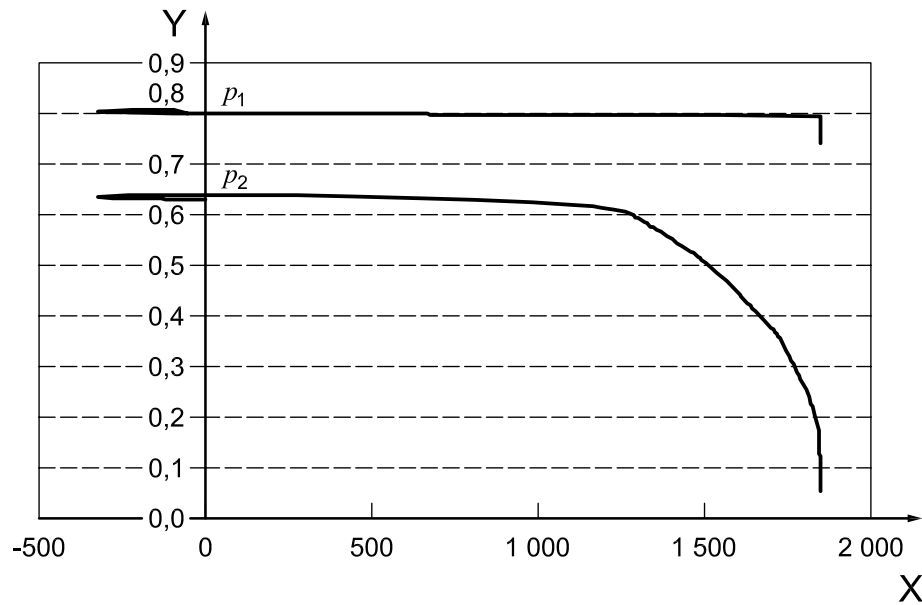
**Key**X flow rate [dm³/min(ANR)]

Y pressure [MPa]

Figure D.2 — Forward flow characteristics obtained from pressure response of Figure D.1

Figure D.2 is the corresponding forward flow characteristics obtained from the pressure response shown in Figure D.1. It shows clearly that if there is an overshoot on the regulated pressure time evolution, when the forward flow-rate equals 0 for the first time, the regulated pressure has not reached its steady-state value.

The pressure response when discharging air to the atmosphere from the component under test is shown in Figure D.3 for a set pressure of 0,5 MPa. This pressure response is oscillating.

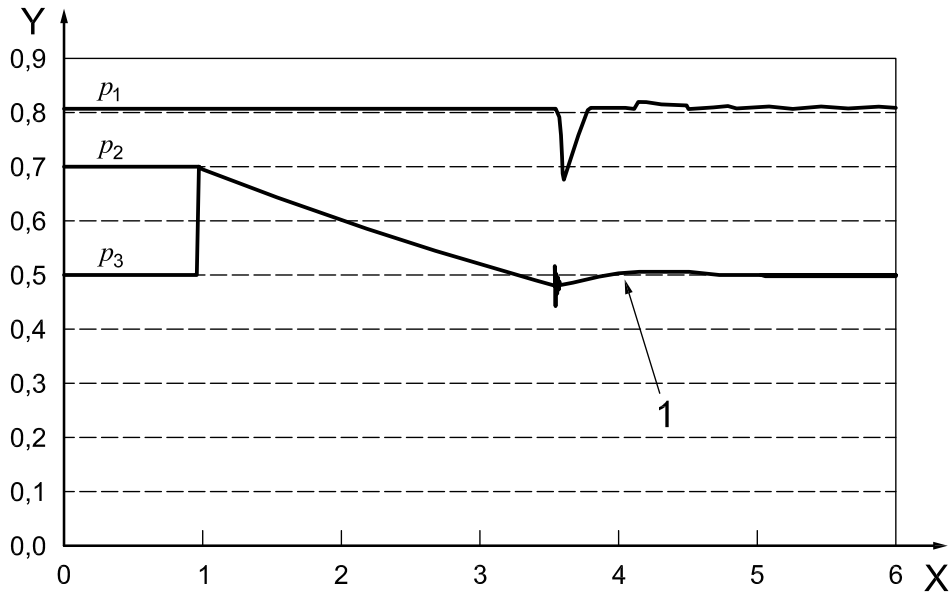

Key
 1 undershoot
 X time [s]
 Y pressure [MPa]

Figure D.3 — Pressure response during discharge

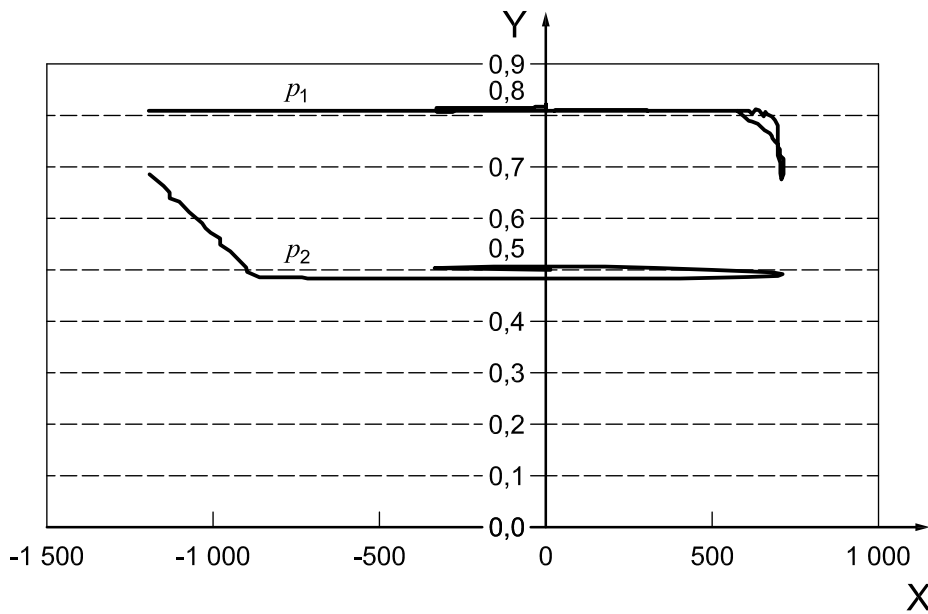

Key
 X flow rate [dm³/min(ANR)]
 Y pressure [MPa]

Figure D.4 — Relief flow characteristics obtained from pressure response of Figure D.3

Figure D.4 is the corresponding relief flow characteristics obtained from the pressure response shown in Figure D.3. It shows clearly that if there are oscillations on the regulated pressure time evolution, the phenomenon is increased.

It is thus very important that the regulated pressure evolution during charge or discharge test takes place without any overshoot or undershoot. Otherwise, the corresponding flow characteristics have no more meaning.

D.2 Illustration of not permissible variations on inlet pressure

According to 6.1.4.3, some data should be excluded because the variations of the inlet pressure, p_1 , exceed $\pm 1\%$ as required in Table 2.

Figure D.5 gives another example of a pressure response when charging air to an isothermal tank of 21 dm^3 by opening the solenoid valve after setting inlet pressure at $0,8 \text{ MPa}$ and regulated pressure at $0,63 \text{ MPa}$.

In this case, p_1 shows a large undershoot just after the opening of the solenoid valve. In this area, p_1 is out of the permissible variations of $\pm 1\%$ as required in Table 2. Figure D.6 shows that the use of all data does not give a correct forward flow characteristic because of the too large variations on inlet pressure.

Therefore, according to 6.1.4.3, some data of Figure D.6 should be excluded to obtain the forward flow-rate characteristic shown in Figure D.7 obtained from the only data for which p_1 is held within $\pm 1\%$.

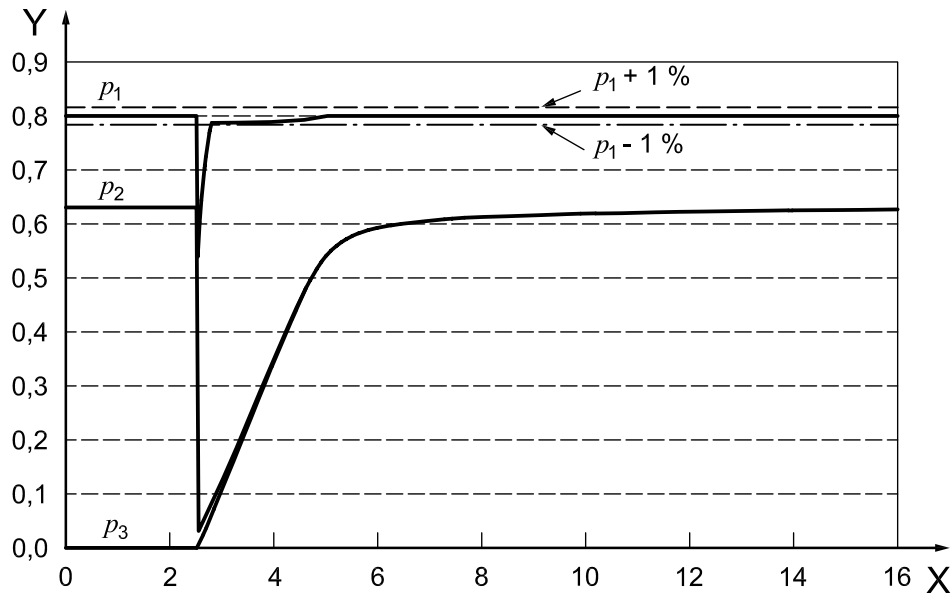

Key

X time [s]
Y pressure [MPa]

Figure D.5 — Pressure response during charge showing not permissible variations on the inlet pressure, p_1

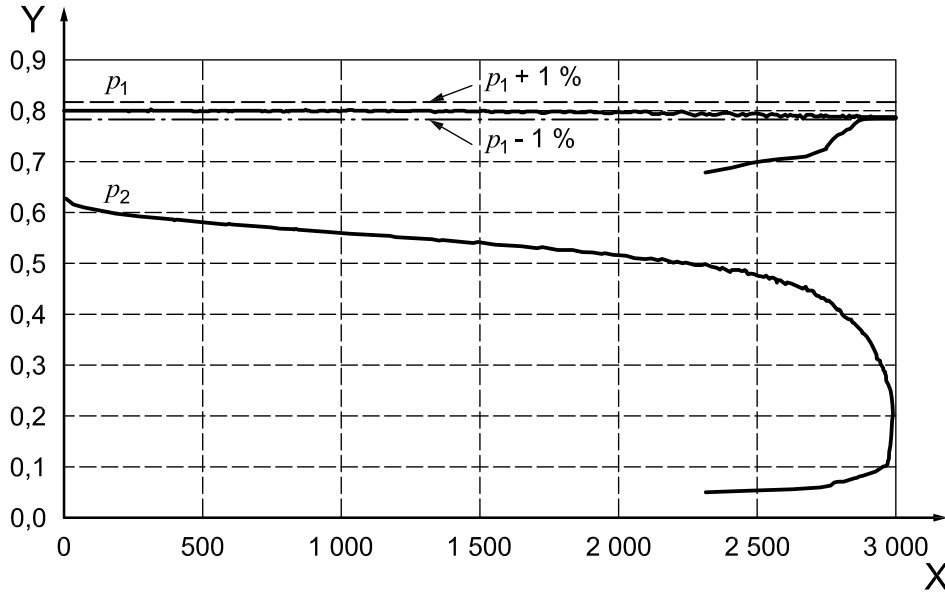

Key
 X flow rate [dm³/min(ANR)]
 Y pressure [MPa]

Figure D.6 — Forward flow rate characteristic obtained from pressure response of Figure D.5 using all data after the opening of the solenoid valve

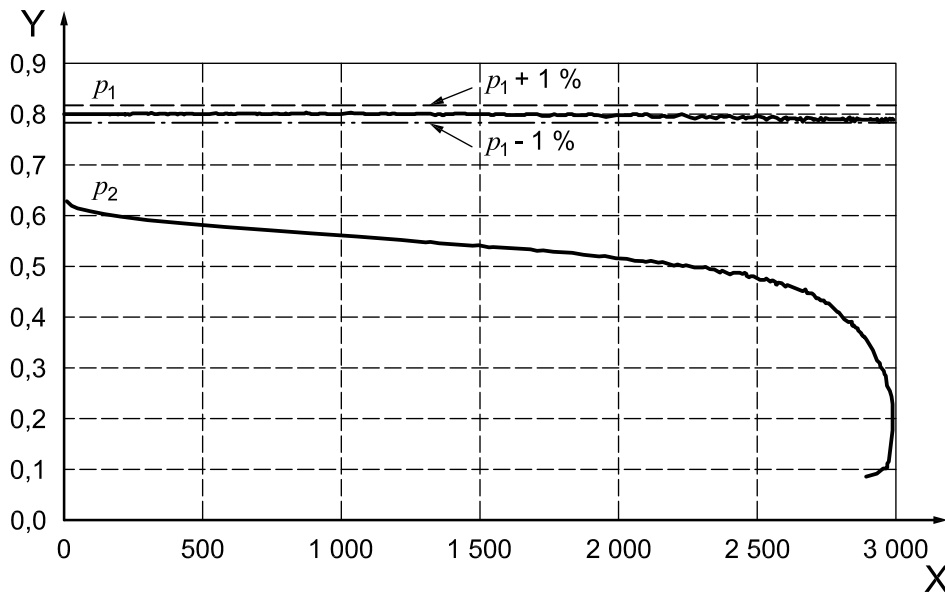

Key
 X flow rate [dm³/min(ANR)]
 Y pressure [MPa]

Figure D.7 — Forward flow-rate characteristic obtained from pressure response of Figure D.5 using the only data for which the inlet pressure, p_1 , is held within $\pm 1\%$ according to 6.1.4.3 and Table 2.

Bibliography

- [1] ISO 1219-1, *Fluid power systems and components — Graphic symbols and circuit diagrams — Part 1: Graphic symbols for conventional us and data-processing applications*

ICS 23.100.50

Price based on 45 pages