**Railway components — Technical
delivery requirements —**

**Part 2:
Non-alloy carbon steel baseplates**

*Éléments constitutifs de la voie ferrée — Spécifications techniques de
livraison —*

Partie 2: Selles en acier au carbone non allié



Reference number
ISO 6305-2:2007(E)

© ISO 2007

PDF disclaimer

This PDF file may contain embedded typefaces. In accordance with Adobe's licensing policy, this file may be printed or viewed but shall not be edited unless the typefaces which are embedded are licensed to and installed on the computer performing the editing. In downloading this file, parties accept therein the responsibility of not infringing Adobe's licensing policy. The ISO Central Secretariat accepts no liability in this area.

Adobe is a trademark of Adobe Systems Incorporated.

Details of the software products used to create this PDF file can be found in the General Info relative to the file; the PDF-creation parameters were optimized for printing. Every care has been taken to ensure that the file is suitable for use by ISO member bodies. In the unlikely event that a problem relating to it is found, please inform the Central Secretariat at the address given below.

© ISO 2007

All rights reserved. Unless otherwise specified, no part of this publication may be reproduced or utilized in any form or by any means, electronic or mechanical, including photocopying and microfilm, without permission in writing from either ISO at the address below or ISO's member body in the country of the requester.

ISO copyright office
Case postale 56 • CH-1211 Geneva 20
Tel. + 41 22 749 01 11
Fax + 41 22 749 09 47
E-mail copyright@iso.org
Web www.iso.org

Published in Switzerland

Contents

Page

Foreword.....	iv
1 Scope	1
2 Normative references	1
3 General requirements	1
3.1 Steelmaking process	1
3.2 Manufacture of baseplates	2
3.3 Freedom from defects	2
3.4 Drawings and working gauges	2
3.5 Finishing	2
3.6 Flatness	3
4 Technical requirements	3
4.1 Tensile properties	3
4.2 Properties of bend test	3
4.3 Dimensional tolerances	3
5 Acceptance testing	4
5.1 General	4
5.2 Number of tests	4
5.3 Dimensions and finish	5
5.4 Sampling for mechanical test	5
5.5 Dimensional checks	5
6 Test methods	5
6.1 Tensile test	5
6.2 Bend test	6
6.3 Retest	6
6.4 Interpretation of dimensional inspection	6
6.5 Alternative to dimensional inspection by selection from batches — Quality control cards	6
7 Marking	7
8 Information to be supplied by the purchaser	7
Annex A (normative) Checking of dimensions and tolerances	8
Annex B (normative) Progressive sampling plan — Wald method	10
Annex C (normative) Progressive sampling plan for inspection of resubmitted batches	12

Foreword

ISO (the International Organization for Standardization) is a worldwide federation of national standards bodies (ISO member bodies). The work of preparing International Standards is normally carried out through ISO technical committees. Each member body interested in a subject for which a technical committee has been established has the right to be represented on that committee. International organizations, governmental and non-governmental, in liaison with ISO, also take part in the work. ISO collaborates closely with the International Electrotechnical Commission (IEC) on all matters of electrotechnical standardization.

International Standards are drafted in accordance with the rules given in the ISO/IEC Directives, Part 2.

The main task of technical committees is to prepare International Standards. Draft International Standards adopted by the technical committees are circulated to the member bodies for voting. Publication as an International Standard requires approval by at least 75 % of the member bodies casting a vote.

Attention is drawn to the possibility that some of the elements of this document may be the subject of patent rights. ISO shall not be held responsible for identifying any or all such patent rights.

ISO 6305-2 was prepared by Technical Committee ISO/TC 17, *Steel*, Subcommittee SC 15, *Railway rails and their fasteners*.

This second edition cancels and replaces the first edition (ISO 6305-2:1983), which has been editorially revised.

ISO 6305 consists of the following parts, under the general title *Railway components — Technical delivery requirements*:

- *Part 1: Rolled steel fishplates*
- *Part 2: Non-alloy carbon steel baseplates*
- *Part 3: Steel sleepers*
- *Part 4: Untreated steel nuts and bolts and high-strength nuts and bolts for fishplates and fastenings*

Part 1 of ISO 6305 was withdrawn by systematic review in 2002.

Railway components — Technical delivery requirements —

Part 2: Non-alloy carbon steel baseplates

1 Scope

This part of ISO 6305 specifies the quality requirements of the product and the conditions of acceptance testing for rolled non-alloy carbon steel baseplates for use with flat-bottom railway rails.

2 Normative references

The following referenced documents are indispensable for the application of this document. For dated references, only the edition cited applies. For undated references, the latest edition of the referenced document (including any amendments) applies.

ISO 377, *Steel and steel products — Location and preparation of samples and test pieces for mechanical testing*

ISO 2859-1, *Sampling procedures for inspection by attributes — Part 1: Sampling schemes indexed by acceptance quality limit (AQL) for lot-by-lot inspection*

ISO 2859-2, *Sampling procedures for inspection by attributes — Part 2: Sampling plans indexed by limiting quality (LQ) for isolated lot inspection*

ISO 2859-3, *Sampling procedures for inspection by attributes — Part 3: Skip-lot sampling procedures*

ISO 2859-4, *Sampling procedures for inspection by attributes — Part 4: Procedures for assessment of declared quality levels*

ISO 6506-1, *Metallic materials — Brinell hardness test — Part 1: Test method*

ISO 6892, *Metallic materials — Tensile testing at ambient temperature*

ISO 7438, *Metallic materials — Bend test*

3 General requirements

3.1 Steelmaking process

The steelmaking process shall be the responsibility of the manufacturer of the baseplates. If requested by the purchaser at the time of enquiry or order, the manufacturer shall describe the steelmaking and casting processes employed. The manufacture shall not alter these without the agreement of the purchaser.

3.2 Manufacture of baseplates

The baseplates shall be manufactured by cutting to length a rolled section and finishing in accordance with drawings supplied by the purchaser.

3.3 Freedom from defects

The baseplates shall be free from defects adversely affecting their performance in service.

Slight defects outside the rail seating surface may be accepted by the receiving inspector if considered negligible.

Any operation carried out either in the cold or hot state, with the object of concealing a defect adversely affecting the performance of the baseplates in service is not permitted.

3.4 Drawings and working gauges

A copy of the final drawings shall be supplied to the manufacturer by the purchaser, together with the notification of approval of the order.

If stated in the order, the manufacturer, before starting production, shall make up two sets of maximum and minimum working gauges, incorporating the specified dimensional tolerances. If required by the purchaser, the working gauges shall be stamped after approval by the purchaser's representative.

Only these working gauges shall be valid for checking purposes.

One set of working gauges shall be made available to the receiving inspector for the period of acceptance testing.

The working gauges shall be provided at the manufacturer's expense. New working gauges need not be provided for items ordered in quantities of less than 10 000 at any one time.

When the working gauges have been approved by a purchaser, or by an outside testing agency, these shall be used for other purchasers, wherever possible.

3.5 Finishing

The rolling and baseplate finishing processes shall be the responsibility of the manufacturer. If requested by the purchaser at the time of enquiry or order, the manufacturer shall describe the rolling and baseplate finishing processes employed. The manufacturer shall not alter these without the agreement of the purchaser.

3.5.1 Baseplate length

The rolled bars used shall be cut to length by any suitable method which does not impair the section and the quality of the metal. Each cut shall be perpendicular to the axis, clean and free of burrs. Any projections shall be removed from the surfaces bearing on the rail. Hammering is not allowed.

Downward deformation of baseplate edges due to shearing is permissible up to a limit of 1,5 mm, over a width of 20 mm for parts less than 33 mm thick and to 3 mm for parts more than 33 mm thick.

3.5.2 Holing

One or more of the following methods shall be used for producing the holes:

- a) drilling;
- b) cold punching;
- c) hot punching;
- d) machining.

All precautions shall be taken to ensure that the rail bearing surface is not deformed or the steel impaired. The dimensions of the hole shall remain within the dimensional tolerances given in 4.3.

Burrs resulting from these operations shall be removed.

3.6 Flatness

The surfaces on which the rails bear shall not deviate from flatness by more than 0,5 mm. The purchaser shall specify in the order whether the surface may be convex or concave.

4 Technical requirements

4.1 Tensile properties

The steel used for the manufacture of baseplates shall be of one of the grades defined in Table 1 and as selected by the purchaser.

Table 1 — Mechanical properties of steel grades to be used

Tensile strength R_m N/mm ²	Minimum elongation %
380 to 480	24
480 to 620	18

Other steel grades may be used, subject to agreement in the order between the purchaser and the manufacturer.

4.2 Properties of bend test

The plate shall not show any sign of fracture when bent through an angle of 135°.

4.3 Dimensional tolerances

The methods and means of checking the principal dimensional tolerances are defined in Table 2.

If, for normal operations and by agreement between the manufacturer and the purchaser, gauges different from but equivalent to those given in 3.4 are used, only the latter shall be used in case of dispute.

Table 2 — Tolerances of baseplate dimensions

Dimension		Tolerances ^a mm	Checking methods in accordance with Annex A
Length <i>L</i>	Dimension parallel to the rail	± 4	Minimum/maximum gauge
Width <i>I</i>	Width of the rolled section	± 3	Minimum/maximum gauge
Thickness		± 1	The thickness shall be measured at the two extremities of the baseplate section
Deviation <i>e</i> of the lips		+1,5 0	Minimum/maximum gauge
End squareness		± 4	
Size of the fixing holes		For drilled holes: + 0,5 mm For punched holes: the above tolerances are increased by 0,10 times the thickness for the exit side of the punched hole.	
Position of the holes	The position of the holes shall enable the baseplate to be mounted on a gauge with pins placed at the specified spacing; the diameter/size of the pins shall be 1,5 mm less than that of the holes. The length of the working gauge shall be equal to the length of the baseplate plus the maximum tolerance. The baseplates shall be able to fit over the working gauge, the pins engaging simultaneously in the holes, and the ends not overlapping the working gauge.		Working gauge
Surface inclination		± 7/1 000	By difference of two thickness measurements taken as close as possible to the lips.

^a For high-speed tracks (as a guide ≥ 160 km/h), the question of tolerances shall be subject to agreement between the purchaser and the manufacturer.

5 Acceptance testing

5.1 General

The tests shall be carried out in the manufacturer's works; the preparation of the testpieces and the tests shall be at the manufacturer's expense.

5.2 Number of tests

One tensile test shall be carried out on one of each type of baseplate per cast for casts of 50 t or less. For casts greater than 50 t, two tests per cast shall be made.

5.3 Dimensions and finish

The inspection of dimensions covers the dimensions and measurements below:

- width of section (I);
- deviation between lips (e);
- diameter of holes;
- position of holes;
- surface inclination;
- flatness of the rail seat.

The other dimensions for which tolerances are specified in Table 2 may at any time be checked by the receiving inspector, but are not subject to the systematic inspection specified in 6.3.

5.4 Sampling for mechanical test

The parts shall be selected for sampling as directed by the receiving inspector.

The test pieces shall be cut in the rolling direction.

Samples for the preparation of tensile test pieces shall be taken in accordance with ISO 377.

Cutting and finishing shall be carried out entirely in the cold state, by means of machine tools and without any hammering, cold deformation, hardening or annealing.

If possible, the test pieces shall be cylindrical and have a diameter of 10 mm, i.e. a section of 78,5 mm². The gauge length shall be 50 mm, and the parallel length shall be between 60 and 70 mm.

Hardness measurements may be carried out by agreement with the purchaser, provided that such hardness measurements replace the tensile test.

Hardness tests in accordance with ISO 6506-1 may be agreed at the time of enquiry and order.

5.5 Dimensional checks

The parts selected for sampling shall be grouped in batches of the same kind. The samples shall be selected in such a way that they are representative of the batches submitted. The size of a batch shall be not less than 3 000 parts, and not more than 10 000 parts.

The receiving inspector has the right to break down or form batches for inspection purposes.

The parts selected for sampling shall be marked by the receiving inspector, and these marks shall be kept intact until the end of the acceptance testing operations.

6 Test methods

6.1 Tensile test

The tensile test shall be carried out in accordance with ISO 6892.

The steel tested shall meet the quality requirements corresponding to one of the grades shown in Table 1.

6.2 Bend test

Where requested, the bend test in accordance with ISO 7438 may be applied.

6.3 Retest

If, from the batch corresponding to a cast or part cast, the single part selected for the test does not satisfy the conditions laid down, two re-tests shall be carried out as directed by the receiving inspector. If one of these re-tests is not satisfactory, the corresponding batch shall be rejected.

6.4 Interpretation of dimensional inspection

Any baseplate which, on inspection, is found to have at least one measurement exceeding the tolerances, or which does not satisfy the finish specified in 5.3, shall be deemed not to conform.

Dimensional inspection shall be carried out by random sampling from batches of baseplates.

The statistical sampling programme to be used shall be agreed between the purchaser and the manufacturer. The agreement shall define the acceptable levels of quality and the risks, and the size of the batch and of the sample.

In the absence of such an agreement, the statistical sampling plan shall be carried out in accordance with the Wald diagram or in accordance with the corresponding table of ISO 2859-1, ISO 2859-2, ISO 2859-3 or ISO 2859-4, which involves the same risks for the manufacturer and the user of this diagram. The two control plans are essentially equivalent, but the sequential plan is much more economical.

The risks incurred in the plan represented by the Ward diagram (Figure B.1) are as follows:

- a 5 % maximum probability of the rejection of a batch containing no more than 5 % of faulty parts.
- a 5 % maximum probability of the acceptance of a batch containing not less than 15 % of faulty parts.

The test shall be terminated as soon as the point representing the progress of the check enters the acceptance or rejection area.

In the case of a rejection, the manufacturer shall be entitled to sort the parts of the faulty batch, at his own expense, and to resubmit the batch for acceptance.

For the purpose of this second submission, the inspection shall be carried out in accordance with the progressive sampling plan (Annex C) which provides a smaller risk for the purchaser.

6.5 Alternative to dimensional inspection by selection from batches — Quality control cards

When the manufacturer makes a regular practice of using a system of quality-control cards agreed by the purchaser for these products, the purchaser may arrange at his option the frequency of the dimensional inspection by sampling from batches. The results recorded on the quality-control cards shall then be considered as constituting an acceptance inspection.

The quality-control cards shall be retained at the receiving inspector's disposal, who shall be free, at any time, to inspect the correct application of the procedure, by any method chosen by the purchaser.

The quality-control cards shall contain any information necessary for the purpose of clearly identifying the product. They shall be retained by the manufacturer at least until 31 December of the year following the year shown on the parts.

7 Marking

The baseplates shall carry, in bold characters, at the position shown on the drawings compatible with the rolling requirements:

- the designation of the baseplate;
- the identification mark of the manufacturer;
- the last two figures of the year of manufacture.

8 Information to be supplied by the purchaser

The attention of users of this part of ISO 6305 is drawn to the fact that an invitation to tender should normally be accompanied by a definition of the conditions of use and other relevant documents for carrying out the order, and in particular those concerning the application of the clauses in this specification.

Annex A (normative)

Checking of dimensions and tolerances

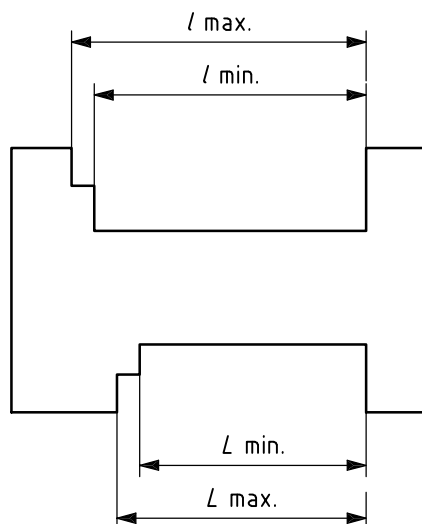

Figure A.1 — Gauge for checking length L and width l

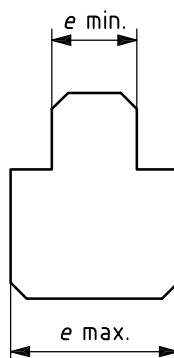
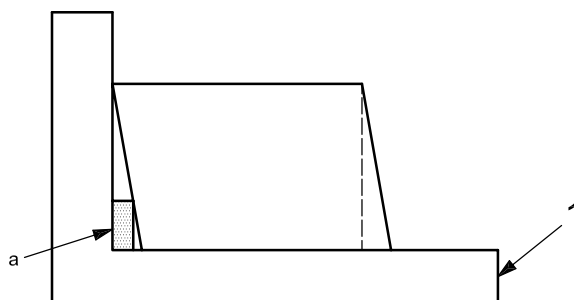

Figure A.2 — Gauge for checking deviation of lips e (rail seat width)



Key

- 1 square
- a The 4 mm slip gauge (key) shall not enter

Figure A.3 — Check for end squareness

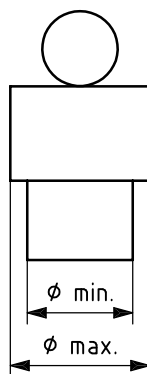
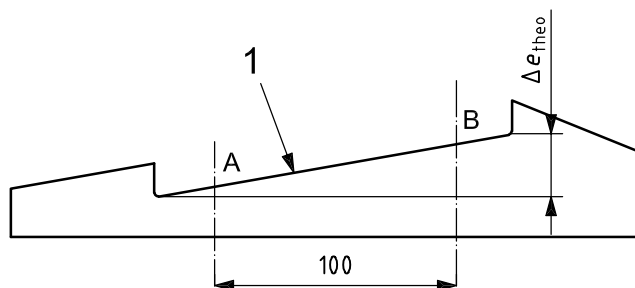

Figure A.4 — Gauge for checking diameter of holes

Dimensions in millimetres



Key

- 1 theoretical slope

The slope shall be with tolerances $\pm 7/1\ 000$ if the difference in thickness between points A and B situated as close as possible to the lips is within the tolerance $\Delta e_{theo} \pm 7/10$ mm.

Figure A.5 — Check for surface inclination

Annex B
(normative)

Progressive sampling plan — Wald method

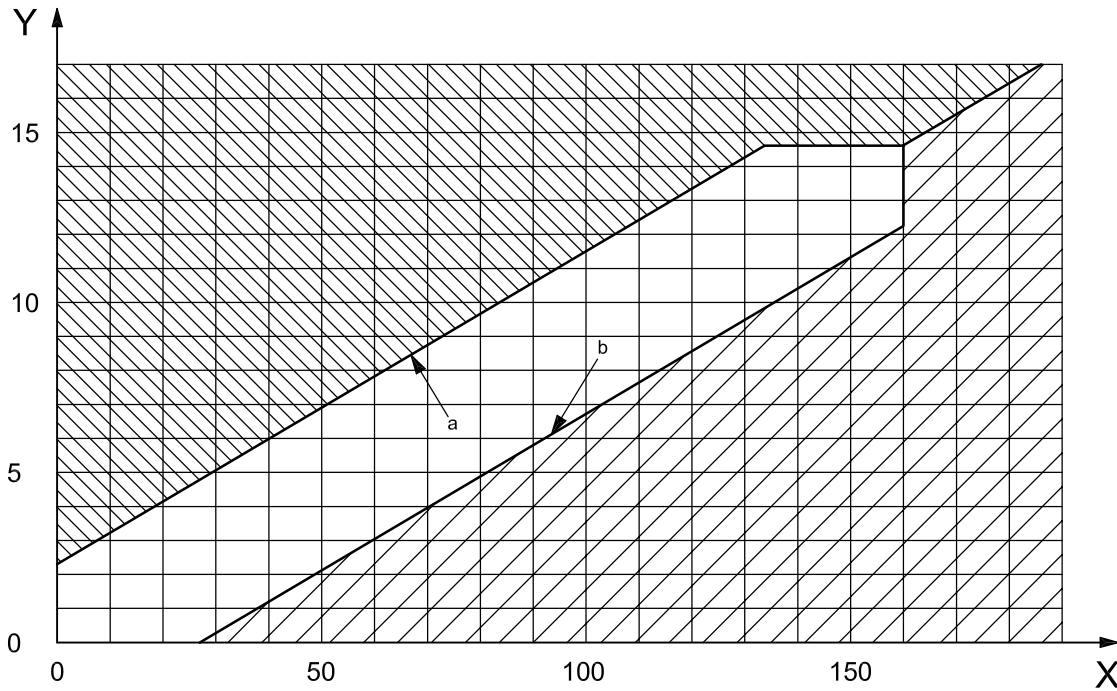

- Key**
- X Number of parts tested
 - Y Number of bad parts
 - a Reject
 - b Accept

Figure B.1 — Wald diagram

The following text concerns the use of the Wald diagram.

When a test is carried out, individual items are selected at random from the batch being checked. Each is checked and the result is recorded on the diagram before continuing.

A sample shall be deemed to conform if the test or check referred to in the diagram is satisfactory. It shall be deemed not to conform if the contrary is the case.

The results are represented by a point moving over the diagram. The starting position of the point is at zero. For each test, the point is moved by one unit parallel to the x-axis. For each non-conforming test, it is also moved by one unit parallel to the y-axis. The test is stopped as soon as the recording point has entered one of the areas marked “accept” or “reject”.

NOTE The x-axis and y-axis refer to horizontal and vertical directions individually.

Different kinds of test, forming a series, may be plotted on the same diagram.

The diagrams relating to each series of tests shall be appended to the acceptance report. They shall show each consecutive position of the recording point.

The purchaser may permit sampling to be carried out using groups of adjacent items, instead of randomly selected individual items. In this case

- a) the number of items in a group shall be constant throughout the test and be predetermined with a maximum number of 10;
- b) the position of the recording point shall be plotted on the diagram after all the items in the group have been checked; the recording point is replotted after each group, parallel to the x-axis, by as many units as there are items in the group, and parallel to the y-axis by a number of units equal to the number of non-conforming items found in the group.

© ISO 2007. All rights reserved.

Annex C (normative)

Progressive sampling plan for inspection of resubmitted batches

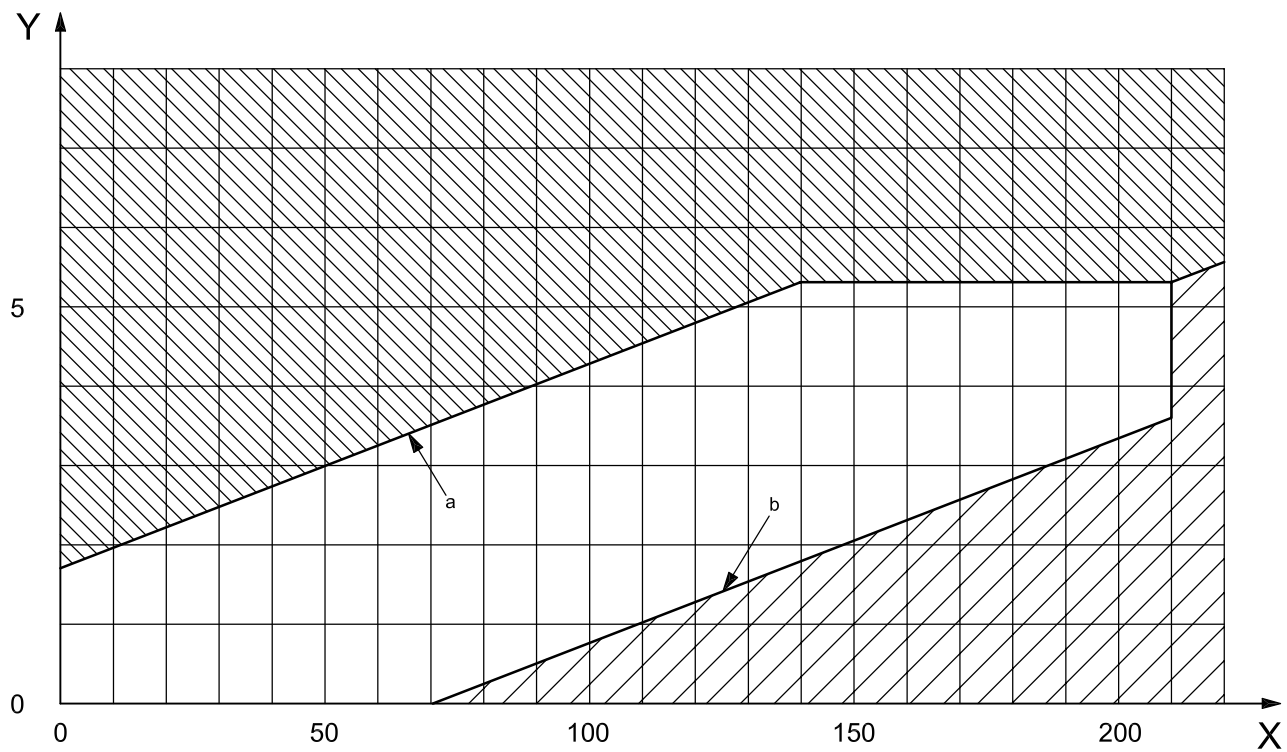

Key

- X Number of parts tested
- Y Number of bad parts
- a Reject
- b Accept

Figure C.1 — Wald diagram for inspection of resubmitted batches

See the text concerning the use of the Wald diagram in Annex B.

ICS 45.080

Price based on 12 pages