**Fire protection — Automatic sprinkler
systems —**

**Part 11:
Requirements and test methods for pipe
hangers**

*Protection contre l'incendie — Systèmes d'extinction automatiques du
type sprinkler —*

*Partie 11: Exigences et méthodes d'essai relatives aux dispositifs de
fixation des conduites*



PDF disclaimer

This PDF file may contain embedded typefaces. In accordance with Adobe's licensing policy, this file may be printed or viewed but shall not be edited unless the typefaces which are embedded are licensed to and installed on the computer performing the editing. In downloading this file, parties accept therein the responsibility of not infringing Adobe's licensing policy. The ISO Central Secretariat accepts no liability in this area.

Adobe is a trademark of Adobe Systems Incorporated.

Details of the software products used to create this PDF file can be found in the General Info relative to the file; the PDF-creation parameters were optimized for printing. Every care has been taken to ensure that the file is suitable for use by ISO member bodies. In the unlikely event that a problem relating to it is found, please inform the Central Secretariat at the address given below.

© ISO 2003

All rights reserved. Unless otherwise specified, no part of this publication may be reproduced or utilized in any form or by any means, electronic or mechanical, including photocopying and microfilm, without permission in writing from either ISO at the address below or ISO's member body in the country of the requester.

ISO copyright office
Case postale 56 • CH-1211 Geneva 20
Tel. + 41 22 749 01 11
Fax + 41 22 749 09 47
E-mail copyright@iso.org
Web www.iso.org

Published in Switzerland

Contents

Page

Foreword	iv
1 Scope	1
2 Normative references	1
3 Terms and definitions	1
4 Product consistency	4
5 Materials and rod sizes	4
6 Material thicknesses	4
7 Performance requirements	5
8 Test methods	7
9 Marking	9
Bibliography	13

Foreword

ISO (the International Organization for Standardization) is a worldwide federation of national standards bodies (ISO member bodies). The work of preparing International Standards is normally carried out through ISO technical committees. Each member body interested in a subject for which a technical committee has been established has the right to be represented on that committee. International organizations, governmental and non-governmental, in liaison with ISO, also take part in the work. ISO collaborates closely with the International Electrotechnical Commission (IEC) on all matters of electrotechnical standardization.

International Standards are drafted in accordance with the rules given in the ISO/IEC Directives, Part 2.

The main task of technical committees is to prepare International Standards. Draft International Standards adopted by the technical committees are circulated to the member bodies for voting. Publication as an International Standard requires approval by at least 75 % of the member bodies casting a vote.

Attention is drawn to the possibility that some of the elements of this document may be the subject of patent rights. ISO shall not be held responsible for identifying any or all such patent rights.

ISO 6182-11 was prepared by Technical Committee ISO/TC 21, *Equipment for fire protection and fire fighting*, Subcommittee SC 5, *Sprinkler and water spray extinguishing systems*.

ISO 6182 consists of the following parts, under the general title *Fire protection — Automatic sprinkler systems*:

- *Part 1: Requirements and test methods for sprinklers*
- *Part 2: Requirements and test methods for wet alarm valves, retard chambers and water motor alarms*
- *Part 3: Requirements and test methods for dry pipe valves*
- *Part 4: Requirements and test methods for quick-opening devices*
- *Part 5: Requirements and test methods for deluge valves*
- *Part 7: Requirements and test methods for early suppression fast response (ESFR) sprinklers*
- *Part 9: Requirements and test methods for water mist nozzles*
- *Part 11: Requirements and test methods for pipe hangers*

The following part is under preparation:

- *Part 10: Requirements and test methods for domestic sprinklers*

Fire protection — Automatic sprinkler systems —

Part 11: Requirements and test methods for pipe hangers

1 Scope

This part of ISO 6182 specifies performance requirements, test methods and marking requirements for pipe hangers.

2 Normative references

The following referenced documents are indispensable for the application of this document. For dated references, only the edition cited applies. For undated references, the latest edition of the referenced document (including any amendments) applies.

ISO 1460, *Metallic coatings — Hot dip galvanized coating on ferrous material — Gravimetric determination of the mass per unit area*

ISO 2064, *Metallic and other inorganic coatings — Definitions and conventions concerning the measurements of thickness*

ISO 2178, *Non-magnetic coatings on magnetic substrates — Measurement of coating thickness — Magnetic method*

ISO 3575:1996, *Continuous hot-dip zinc-coated carbon steel sheet of commercial, lock-forming and drawing qualities*

ISO 4998:1996, *Continuous hot-dip zinc-coated carbon steel sheet of structural quality*

ASTM B568, *Standard test method for measurement of coating thickness by X-ray spectrometry*

3 Terms and definitions

For the purposes of this document, the following terms and definitions apply.

3.1

band hanger

type of hanger that is adjustable and utilizes a band looped around the pipe

3.1.1

adjustable swivel band hanger

type of band hanger that is adjustable and swivels

3.2

bracket

cantilever-type hanger that is attached directly to a vertical surface of the building structure

3.3
building attachment component
support fixing

hanger component set into the wall or ceiling to support the hanger

NOTE A building attachment component can be either a driven fastener, expansion anchor, undercut anchor, or cast-in insert.

3.4
cast-in insert

type of building attachment component cast into the concrete at the time of pouring

NOTE Cast-in inserts can be channels, which take special threaded bolts, or internally threaded sockets, which accept conventional bolts.

3.5
ceiling flange

type of building attachment component hanger that is attached directly to an overhead surface of a building structure

3.6
clamp

type of building attachment that is rigidly attached to the flange of a steel structural member

3.6.1
beam clamp

clamp that is rigidly attached to both edges of the bottom flange of a structural member

3.6.3
C-clamp

building attachment component that grips a flange by means of a jaw and setscrew combination

3.6.4
riser clamp

type of pipe clamp used to support risers at various levels

3.6.5
top/bottom clamp

clamp that is rigidly attached to one edge of the top or bottom flange of a structural member

3.7
clevis attachment

type of split-ring pipe-attachment component

3.8
clip

pipe-attachment component, usually one piece and nonadjustable, that only partially embraces a pipe and that can be attached directly to a building structure

3.9
coupler

threaded element used to connect the building attachment component (support fixing) to the rod

NOTE Couplers can have male or female threads (usually female) and can be the same thread throughout or two different thread diameters to link fixings and rods of different sizes.

3.10**driven fastener**

type of building attachment component driven into solid concrete or structural steelwork by means of a special tool, usually powder actuated, and can have female or, usually, male thread linked to the rod by means of a coupler

3.11**expansion anchor**

type of building attachment component set into the ceiling or wall of the building structure in self-drilled or pre-drilled cylindrical holes; ceiling fixings usually “deformation-controlled” internally threaded socket anchors, which are expanded by driving an expander plug to the base of the shell or by driving the shell over the expander plug

NOTE Fixings for walls can be socket anchors or can be “torque-controlled” anchors, either through-bolts (where an expander clip is expanded by the tightening of the bolt) or sleeve anchors (where the sleeve is expanded by the tightening of the bolt).

3.13**hanger**

assembly of components used singly or in combination with other assemblies for supporting pipework

NOTE A hanger can comprise a building attachment component (support fixing), coupler, rod or equivalent and pipe attachment component as shown in Figure 2, or a simple bracket and building attachment component (support fixing) as indicated in Figure 3.

3.14**non-heat sensitive material**

material whose measured tensile strength at $(540 \pm 10) ^\circ\text{C}$ is at least 90 % of the value measured at $(20 \pm 5) ^\circ\text{C}$

3.15**pipe attachment component**

hanger component that is attached directly to the pipe

See Figures 2 and 3.

3.16**retaining strap**

building attachment component, usually made from steel strip, used in combination with a C-clamp to hold the C-clamp in place

3.17**ring**

pipe hanger that completely encircles a pipe without a positive gripping action

3.17.1**solid ring**

ring that has to be slipped onto the end of the pipe and cannot be opened in any way for attachment to the pipe after the pipe line is made up

3.17.2**split ring**

ring that can be opened in some way to allow it to be put on the pipe after the pipeline is made up

3.17.3**swivel ring**

solid or split ring that has a top swivel allowing the hanger to be connected to a rod after it has been installed on the pipe

3.18

undercut anchor

type of building attachment component set into the ceiling or wall of the building structure in self-drilled or pre-drilled undercut holes

NOTE The setting of the anchor, usually by hammering a sleeve over an outwardly tapered element, forces the sleeve out into the undercut shape forming a mechanical interlock with the base material. These anchors are intended for tension zones of concrete, i.e. cracked concrete.

4 Product consistency

It shall be the responsibility of the manufacturer to implement a quality control programme to ensure that production continuously meets the requirements of this part of ISO 6182 in the same manner as the originally tested samples.

5 Materials and rod sizes

5.1 Materials

Hangers and their components shall be made of ferrous or other non-heat-sensitive materials.

5.2 Rod sizes

5.2.1 Hangers and their components shall be provided with rod sizes in accordance with Table 1 unless otherwise stated in 5.2.2 to 5.2.4.

5.2.2 8-mm hanger rod sizes may be used in countries where permitted by National Standards for use with pipe sizes up to and including DN 50. 8-mm hanger rods shall meet the load requirements of Table 1 for a pipe size of DN 50.

5.2.3 Hanger rod sizes designated in Table 1 are the nominal diameters associated with machined threads. The diameter of a rod provided for with a rolled thread shall be not less than the root diameter of the thread.

5.2.4 Some hanger assemblies, such as powder-driven (pyrotechnic) fasteners and 6-mm and 8-mm size expansion shells require the use of an increaser coupling to attach to nominal 10-mm size rod. The increaser couplings provided by the manufacturer shall have sufficient strength to support the test loads applicable to the maximum permitted pipe size.

5.3 Ceiling flanges

Ceiling flanges for pipe sizes up to DN 50 shall have at least two supporting screw holes. For pipe sizes of up to DN 200 (NPS 8), no less than three supporting screw holes shall be provided.

6 Material thicknesses

6.1 Uncoated material thicknesses

6.1.1 Unprotected flat steel, no less than 3 mm thick, is acceptable for use as a clevis-type hanger, band hanger, adjustable swivel loop hanger and for other flat iron hangers, if the hanger is at least 25 mm wide and if the hanger exhibits strength values of at least 150 % of the required test load specified in Table 1.

6.1.2 A C-clamp formed of a double thickness, no less than 3 mm thick, unprotected steel so as to form a 6 mm thick section is acceptable if the clamp exhibits strength value of at least 150 % of the required test load specified in Table 1.

6.1.3 A pressed-steel concrete insert formed from unprotected steel, no less than 3 mm thick, is acceptable if it complies with all other requirements.

6.1.4 If a hanger or part of a hanger is made of flat iron or steel, the thickness of the metal shall be at least 4,8 mm.

6.2 Coated material thicknesses

A hanger or part of a hanger shall have a minimum thickness of 3 mm provided it has an acceptable protective coating. Acceptable coatings are as follows:

- a) a zinc coating having a minimum thickness of 12,7 µm on all outside surfaces and 7,6 µm on all inside surfaces; or
- b) a Z180 continuous hot-dip zinc-coated steel sheet coating as specified in ISO 4998:1996, Table 3, or ISO 3575:1996, Table 2; or
- c) any other metallic or non-metallic finish or combination of the two which, when subjected to comparative tests, provides corrosion protection equivalent to a) or b).

The coating thickness shall be determined in accordance with 8.1.

Coated flat steel material, no less than 1,5 mm in width, is acceptable for use as a clevis-type hanger, band hanger, adjustable swivel loop hanger and as part of other flat iron hangers for pipes 50 mm or less in size provided the hanger exhibits a strength value of at least 150 % of the required test load specified in Table 1.

Coated flat steel material, no less than 2,5 mm in width, is acceptable for use as a clevis-type hanger, band hanger, adjustable swivel loop hanger and as part of other flat iron hangers for pipes greater than 50 mm in size provided the hanger exhibits a strength value of at least 150 % of the required test load specified in Table 1.

7 Performance requirements

7.1 General

A pipe hanger or building attachment component shall be tested to the requirements of Table 1 using the values for the largest size of nominal piping that the hanger can accommodate or for the maximum load of the largest rod size to which it can be attached, whichever is larger.

7.2 Elongation and pull requirements

7.2.1 When tested in accordance with 8.2, a pipe hanger, after initially being preloaded, shall support the elongation test load selected from Table 1 for 1 min without exceeding an elongation of 5 mm.

Exception — No elongation is permitted for building attachment components that are not provided with a clip or retaining strap to maintain securement to the building member.

Table 1 — Pull test load requirements

Nominal pipe size DN	Pipe outside diameter mm	Minimum rod size mm	Pre-load N	Elongation test load ^a N	Required test load ^b N
20	26,7	10 or 8	100	1 700	3 400
25	33,4	10 or 8	150	1 700	3 400
32	42,2	10 or 8	200	1 700	3 400
40	48,3	10 or 8	250	1 700	3 400
50	60,3	10 or 8	350	1 700	3 400
65	76,1	10	539	2 084	4 168
80	88,9	10	785	2 354	4 707
90	101,6	10	883	2 795	5 590
100	114,3	10	1 128	3 334	6 669
125	139,7	12	1 569	4 462	8 924
150	168,3	12	2 109	5 884	10 000
200	219,2	12	3 334	9 022	17 000
250	273,1	16	5 002	13 019	20 000
300	323,9	16	6 816	17 481	35 158

^a Equivalent to 50 % of 5 times the weight of a 4,6 m span of water-filled Schedule 40 steel pipe plus a fixed mass of 115 kg.

^b Equivalent to 5 times the weight of a 4,6 m span of water-filled Schedule 40 steel pipe plus a fixed mass of 115 kg.

7.2.2 Following the elongation test, the pipe hanger shall then be subjected to the required test load specified in Table 1 for 1 min without rupture, pull out, or complete release.

7.3 Concrete inserts

When tested in accordance with 8.3, pipe hangers and building attachments intended for installation in concrete are to be installed in a manner duplicating their intended field installation in concrete blocks. They shall then be capable of supporting the required test load specified in Table 1 for 1 min without rupture, pull out, or complete release.

7.4 Vibration requirements

When tested in accordance with 8.4, expansion shells (cases, shields, or bases), powder-driven fasteners, welded studs, C-clamps not provided with a locknut or retaining strap, and any other hangers that may be subject to change in their ability to retain their installation holding power, are to be vibrated for a period of 100 h at a frequency of 35 Hz and an amplitude of $(0,825 \pm 0,05)$ mm and shall then comply with the elongation and pull requirements specified in 7.2.

7.5 Earthquake protection requirements

Hanger components required to be specially qualified for use in high-risk earthquake areas shall satisfy the test of 8.5.

8 Test methods

8.1 Metallic coating thickness test (see 6.2)

8.1.1 General

The conventions and definitions concerning the measurement of coating thickness given in ISO 2064 shall apply. The coating thickness may be determined by one of the methods given in 8.1.2 to 8.1.4. The method used shall be agreed by all parties; in cases of dispute the method given in 8.1.2 shall be used.

8.1.2 Gravimetric determination of the mass per area

The mass per unit area of the zinc coating shall be determined in accordance with the method described in ISO 1460.

8.1.3 Measurement of coating thickness by X-ray spectrometry

The coating thickness shall be determined in accordance with the method described in ASTM B568 or another equivalent method.

8.1.4 Magnetic determination of coating thickness

The coating thickness shall be determined in accordance with the methods described in ISO 2178. The instruments shall be handled and calibrated according to manufacturer's instructions.

8.1.5 Other methods

Other methods may be used providing they meet the general requirements given in 8.1.1.

8.2 Tests for rods and pipe attachments (see 7.2)

8.2.1 Sample rods and pipe attachments are to be installed in a tension-compression test apparatus in a manner duplicating their intended field installation.

8.2.2 The test machine is to be operated at a speed sufficient to produce an elongation of the test samples at the rate of 1,27 mm/min.

8.2.3 A hanger other than a riser clamp, whose holding power is dependent on the tightness of a bolt, nut, cap screw, lock nut, setscrew, or other machine or roll-threaded part, is to be installed in the test setup and subjected to test with the threaded members tightened to the values specified in Table 2.

8.2.4 A riser clamp is to be torqued to the manufacturer's specification prior to testing.

Table 2 — Applied torques for threaded parts

Thread size		Applied torque	
mm	in	N·m	lbf·in
8	1/4	4,52	40
8	5/16	5,65	50
10	3/8	6,78	60
12	7/16	10,2	90
12	1/2	14,1	125
16	9/16	20,3	180
16	5/8	28,2	250
20	3/4	45,2	400
20	7/8	75,1	665
24	1	111,9	990

8.3 Tests for building attachment components (support fixings) (see 7.3)

8.3.1 The concrete blocks specified in 7.3 shall be at least 350 mm × 350 mm × 200 mm in size, made from a mixture of one part Portland cement, two parts torpedo sand, and four parts crushed limestone or gravel, or of a mixture of these proportioned so that the 28-day compressive strength will be from 17,2 MPa to 20,7 MPa, and reinforced such as with the use of eight 6,4-mm steel rods. Four of the rods are to be placed in the concrete-block form in a plane 38 mm from and parallel with the top of the form. Each set of four rods is to be arranged in the form so that each of the four sides of the form has a rod placed 75 mm in from the side. (See 7.3).

8.3.2 Sample inserts shall be cast in the concrete blocks (one insert per block), and the blocks allowed to cure for at least 28 days. After this period, the concrete blocks with concrete inserts in place are to be assembled in the test machine and the inserts subjected to an increasing load until the required loading as specified in Table 1 is achieved. The test machine supports are to be no closer to the centreline of an anchor point than approximately ten diameters of the anchor rod.

8.3.3 Expansion shells (cases, shields, or bases) shall be installed for performance tests in the concrete blocks (one expansion shell per block), after the blocks have cured for at least 28 days. Each sample expansion shell is to be installed in the manner and at the depth specified by the manufacturer.

8.3.4 Following installation of test samples in the concrete blocks, each test setup shall be secured in place in the test machine and subjected to an increasing load until the required loading as specified in Table 1 is achieved.

8.3.5 Samples of fasteners, including powder-driven fasteners, designed for use in concrete are to be driven into concrete blocks, as previously described in 8.3.1, in accordance with the manufacturer's installation instructions.

8.3.6 Each test fastener for use in concrete is to be driven into the concrete to the full depth of the shank. The fastener is then to be subjected to an increasing load, by means of portable or other equipment, until the required loading as specified in Table 1 is achieved.

8.3.7 Samples of fasteners intended for use in steel are to be driven into steel strips of suitable width, having thicknesses of 8 mm, 10 mm, 12 mm, 16 mm and 20 mm, and having hardness values (Brinnell) of no less than 140, nor greater than 240. Each sample shall penetrate the full depth of the shank until the point protrudes approximately 3,2 mm beyond the surface of the underside of the steel plate. The fastener shall then be subjected to an increasing load until the required loading as specified in Table 1 is achieved.

8.3.8 Welding studs shall be attached to steel plates that are not less than 4,8 mm thick and having other dimensions suitable to installation in the strength-test machine. The samples shall be attached to the steel plate using the tools and methods recommended by the manufacturer. The test arrangement shall then be subjected to an increasing load until the required loading as specified in Table 1 is achieved.

8.4 Vibration tests (see 7.4)

8.4.1 For these tests, the amplitude is defined as the maximum displacement of sinusoidal motion from the position of rest or one-half of the total table displacement.

8.4.2 The test hanger shall consist of the smallest size of each type or series.

8.4.3 A hanger normally installed in concrete, such as an expansion case or a powder-driven fastener, is to be installed in a concrete block, such as that specified in 8.3.1, weighing approximately 60 kg. The hanger and block are to be mounted in the test fixture in a manner that will cause the concrete block to be the test load supported by the hanger.

8.4.4 A hanger normally driven into, welded, or otherwise attached to steel is to be installed on the vibration test fixture in its intended manner. A hanger rod supporting the 60 kg test load is to be attached to the hanger.

8.4.5 The test fixture, together with the hanger and its load, is to be mounted in a vertical position on a vibration-test apparatus and vibrated in a vertical direction.

8.5 Seismic qualification test

The hanger assembly shall be fixed to support a vertical load equal to the weight of 6 m of water-filled pipe of the maximum size for which the assembly is intended. For hanger types using rods or struts, the length is to be the maximum for which the assembly is intended. A load equal to 2 times the vertical load shall be applied to the assembly at the point of pipe load attachment on alternating sides through 100 cycles at the approximate natural frequency of a pendulum represented by the length of the hanger. The load shall be applied using a piston arrangement so as to result in a horizontal displacement if the load is not resisted. The amount of horizontal displacement shall be one-third of the length of the hanger. For hanger assemblies that are not axisymmetric, the test shall be repeated with the hanger assembly turned 90°. The hanger assembly shall resist or accommodate the movement without cracking or failure.

9 Marking

9.1 Hangers

Hanger rods need not be marked.

Hanger parts that are tested with the maximum size pipe they can accommodate need not be marked with the maximum pipe size.

Hanger parts other than those identified above shall be plainly marked with the name or trademark of the manufacturer and the maximum pipe size permitted.

The name or trademark for a product that cannot be adequately marked due to product size, material, or the like, shall be placed on the shipping carton or other type container if the product is packaged for shipment.

9.2 Factory marking

If a manufacturer produces pipe hanger equipment at more than one factory, each hanger shall have a distinctive marking to identify it as the product of a particular factory.

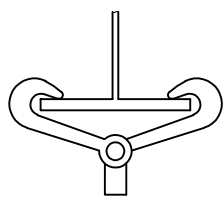

a) Beam clamp

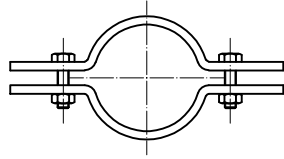

b) Riser clamp

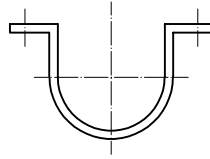

c) Clip

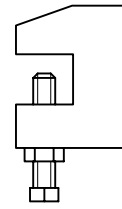

d) Universal top/bottom beam clamp

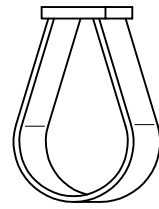

e) Adjustable swivel loop hanger clamp

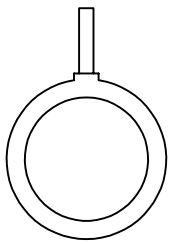

f) Solid swivel ring

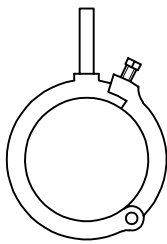

g) Split swivel ring

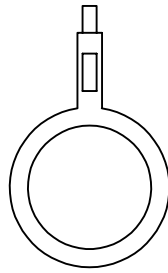

h) Solid clip ring

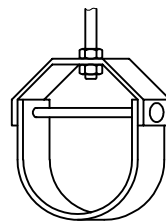

i) Clevis hanger

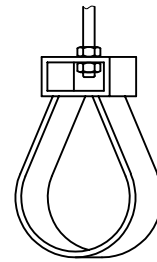

j) Band hanger

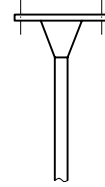

k) Ceiling flange

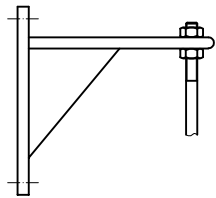

l) Bracket

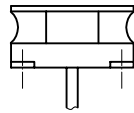

m) Insert



n) Expansion shell (case shield or base)



o) Driven fastener

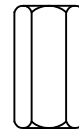

p) Coupling

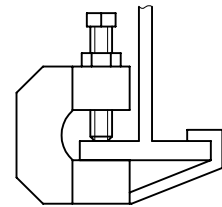

q) C-clamp with retaining strap or locknut

Figure 1 — Some common types of pipe hanger equipment

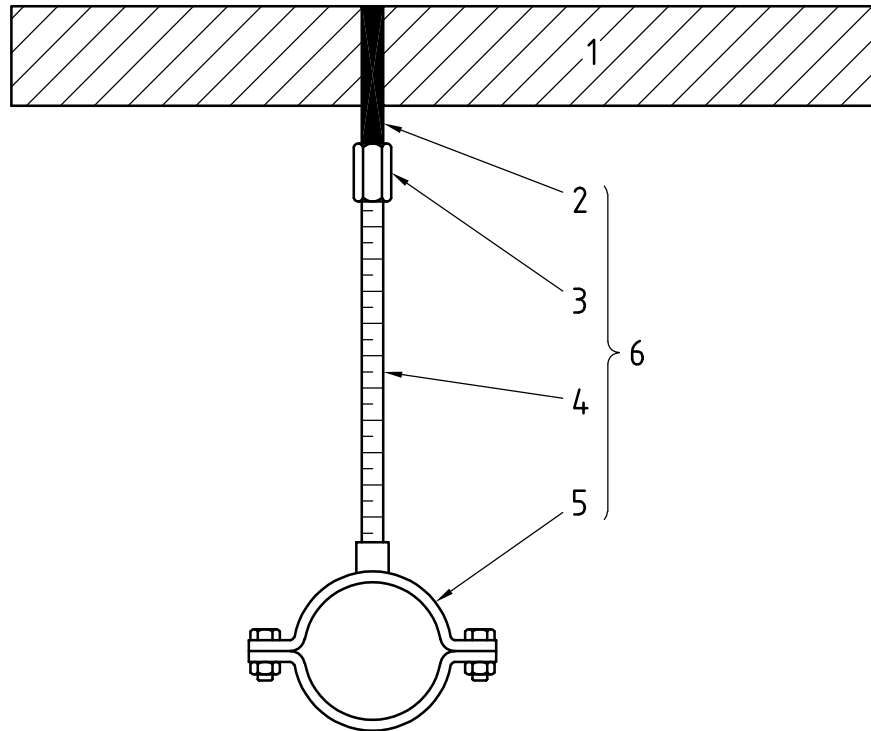

Key

- 1 ceiling
- 2 building attachment component (support fixing)
- 3 coupler
- 4 rod
- 5 pipe attachment component
- 6 hanger

Figure 2 — Pipe hanger attachments — Floor/wall attachment

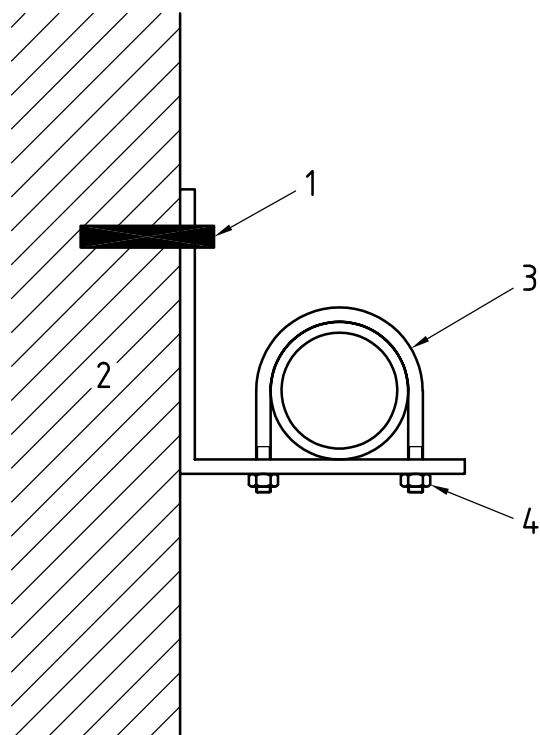

Key

- 1 bracket-type pipe attachment (support fixing)
- 2 wall
- 3 pipe attachment component
- 4 bracket

Figure 3 — Pipe hanger attachments — Wall attachment

Bibliography

- [1] ISO 7-1:1994, *Pipe threads where pressure-tight joints are made on the threads — Part 1: Dimensions, tolerances and designation*
- [2] ISO 49:1994, *Malleable cast iron fittings threaded to ISO 7-1*
- [3] ISO 65:1981, *Carbon steel tubes suitable for screwing in accordance with ISO 7-1*

© ISO 2003. All rights reserved.

ICS 13.220.20

Price based on 13 pages