Paints and varnishes — Evaluation of degradation of coatings — Designation of quantity and size of defects, and of intensity of uniform changes in appearance —

Part 8:

Assessment of degree of delamination and corrosion around a scribe or other artificial defect

Peintures et vernis — Évaluation de la dégradation des revêtements — Désignation de la quantité et de la dimension des défauts, et de l'intensité des changements uniformes d'aspect —

Partie 8: Évaluation du degré de décollement et de corrosion autour d'une rayure ou d'un autre défaut artificiel





COPYRIGHT PROTECTED DOCUMENT

© ISO 2012

All rights reserved. Unless otherwise specified, no part of this publication may be reproduced or utilized in any form or by any means, electronic or mechanical, including photocopying and microfilm, without permission in writing from either ISO at the address below or ISO's member body in the country of the requester.

ISO copyright office
Case postale 56 • CH-1211 Geneva 20
Tel. + 41 22 749 01 11
Fax + 41 22 749 09 47
E-mail copyright@iso.org
Web www.iso.org

Published in Switzerland

Foreword

ISO (the International Organization for Standardization) is a worldwide federation of national standards bodies (ISO member bodies). The work of preparing International Standards is normally carried out through ISO technical committees. Each member body interested in a subject for which a technical committee has been established has the right to be represented on that committee. International organizations, governmental and non-governmental, in liaison with ISO, also take part in the work. ISO collaborates closely with the International Electrotechnical Commission (IEC) on all matters of electrotechnical standardization.

International Standards are drafted in accordance with the rules given in the ISO/IEC Directives, Part 2.

The main task of technical committees is to prepare International Standards. Draft International Standards adopted by the technical committees are circulated to the member bodies for voting. Publication as an International Standard requires approval by at least 75 % of the member bodies casting a vote.

Attention is drawn to the possibility that some of the elements of this document may be the subject of patent rights. ISO shall not be held responsible for identifying any or all such patent rights.

ISO 4628-8 was prepared by Technical Committee ISO/TC 35, *Paints and varnishes*, Subcommittee SC 9, *General test methods for paints and varnishes*.

This second edition cancels and replaces the first edition (ISO 4628-8:2005). For this revision:

- a) the use of measurement and calculation to determine delamination and corrosion is preferred over the use of pictorial standards;
- b) artificial defects with shape other than a linear scribe mark are introduced.

ISO 4628 consists of the following parts, under the general title *Paints and varnishes — Evaluation of degradation of coatings — Designation of quantity and size of defects, and of intensity of uniform changes in appearance*:

- *Part 1: General introduction and designation system*
- *Part 2: Assessment of degree of blistering*
- *Part 3: Assessment of degree of rusting*
- *Part 4: Assessment of degree of cracking*
- *Part 5: Assessment of degree of flaking*
- *Part 6: Assessment of degree of chalking by tape method*
- *Part 7: Assessment of degree of chalking by velvet method*
- *Part 8: Assessment of degree of delamination and corrosion around a scribe or other artificial defect*
- *Part 10: Assessment of degree of filiform corrosion*

Introduction

ISO 4628-1^[1] defines a system for designating the quantity and size of defects and the intensity of uniform changes in appearance of coatings and outlines the general principles of the system. This system is intended to be used, in particular, for defects caused by ageing and weathering, and for uniform changes such as colour changes, for example yellowing.

The other parts of ISO 4628 provide pictorial standards or other means for evaluating particular types of defect. As far as possible, already existing evaluation schemes have been used as the basis.

After exposure of a coated test panel with a scribe or other artificial defect in a corrosive environment, one, or a combination of both of, the following phenomena can occur around the scribe or other artificial defect:

- delamination;
- corrosion.

Delamination and corrosion around the scribe or other artificial defect are evaluated separately to provide more detailed information about the performance of a coating system in corrosive environments.

In addition to the procedure specified in this part of ISO 4628, assessments of delamination and corrosion around the scribe or other artificial defect may be carried out using optical image processing.

Rating of other defects is described in other parts of ISO 4628.

Paints and varnishes — Evaluation of degradation of coatings — Designation of quantity and size of defects, and of intensity of uniform changes in appearance —

Part 8:

Assessment of degree of delamination and corrosion around a scribe or other artificial defect

1 Scope

This part of ISO 4628 specifies a method for assessing delamination and corrosion around a scribe or other artificial defect on a coated panel or other coated test specimen, caused by a corrosive environment.

This part of ISO 4628 does not cover evaluation of pitting corrosion or pit depth.

NOTE 1 Examples of corrosive environments are artificial atmospheres such as salt spray, as used in the test method specified in ISO 9227,^[7] and sea water immersion as used in the test method specified in ISO 15711.^[8] Natural environments can also be used.

NOTE 2 The extent of other defects can also be determined at the same time as delamination and corrosion. Methods are given as follows:

- blistering in accordance with ISO 4628-2;^[2]
- rusting in accordance with ISO 4628-3;^[3]
- cracking in accordance with ISO 4628-4;^[4]
- flaking in accordance with ISO 4628-5;^[5]
- filiform corrosion in accordance with ISO 4628-10.^[6]

2 Normative references

The following referenced documents are indispensable for the application of this document. For dated references, only the edition cited applies. For undated references, the latest edition of the referenced document (including any amendments) applies.

ISO 3270, *Paints and varnishes and their raw materials — Temperatures and humidities for conditioning and testing*

3 Terms and definitions

For the purposes of this document, the following terms and definitions apply.

3.1

holiday

absence of a paint film from certain areas of a coated substrate

3.2

artificial defect

holiday through a coating, deliberately introduced in order to expose the underlying metal substrate prior to exposure to a corrosive environment

3.3
circular defect
circular holiday through a coating, deliberately introduced in order to expose the underlying metal substrate prior to exposure in a corrosive environment

3.4
corroded area
area around a defect where the substrate has been attacked by corrosion

3.5
delaminated area
area around a defect where loss of adhesion of a coating from a substrate or an underlying coating has occurred

3.6
scribe
linear holiday through a coating, deliberately introduced in order to expose the underlying metal substrate prior to exposure in a corrosive environment

4 Principle

The delamination around a scribe or other artificial defect is assessed either directly at the end of the test period, immediately after removal of the test panel from a previous conditioning environment, or after conditioning for a specified period.

The corrosion around the scribe or other artificial defect is assessed either immediately after removal of the test panel from a previous conditioning environment or after removal of the coating.

Both the degree of delamination and the degree of corrosion are determined by measurement and calculation.

5 Procedure

5.1 General

The assessment of delamination shall be made immediately after removal of the panels from the conditioning environment (5.2.1) unless otherwise specified or agreed, in which case assessment may be made after a further conditioning period, during which adhesion might recover (5.2.2).

The assessment of corrosion may be made on the coated panel (5.3.1) or, if agreed or otherwise specified, after stripping off the coating (5.3.2).

If corrosion is to be assessed after stripping off the coating, this is carried out after any assessment of delamination.

Testing of at least three individual test panels is required unless otherwise specified or agreed.

5.2 Assessment of delamination

5.2.1 Directly at the end of the test period

Rinse the test panel with fresh tap water immediately after exposure, i.e. before the coating dries out, blow off residues of water from the surface using compressed air if necessary, and inspect for visible changes. Carefully remove loose coating using a knife blade held at an angle, positioning the blade at the coating/substrate interface and forcing the coating away from the substrate.

Depending upon the coating type and degree of delamination, some force might be necessary to remove the coating, but a boundary should be found where the coating becomes tightly adhered to the substrate, this being the limit of delamination. To be able to correctly determine where this boundary between weak and tight adhesion lies, it is necessary to assess the adhesion beyond the boundary.

If the adhesion of the coating to the substrate has deteriorated to the extent that no boundary can be found and the coating can be easily removed up to the edge of the test panel, this should be noted in the test report.

If desired, compressed air or an adhesive tape may be used instead of a knife blade. It is important to remove the loose coating completely.

If necessary, rinse the test panel again with fresh tap water.

Measure with a ruler, to the nearest 0,5 mm, the total width of delamination at a minimum of six points uniformly distributed along the scribe or around the artificial defect (see Figure 1, measurements *a* to *f*). Ignore delamination beyond the beginning and end of the original scribe.

If more accurate measurement is required, a magnifier with suitable scale may be used.

Delamination may be measured over more than six points if the test standard being followed requires, provided this information is included in the test report. Similarly, for a scribed line of length less than 50 mm, fewer than six measurements may be made, provided that each measurement is a minimum of 6 mm apart and information is included in the test report.

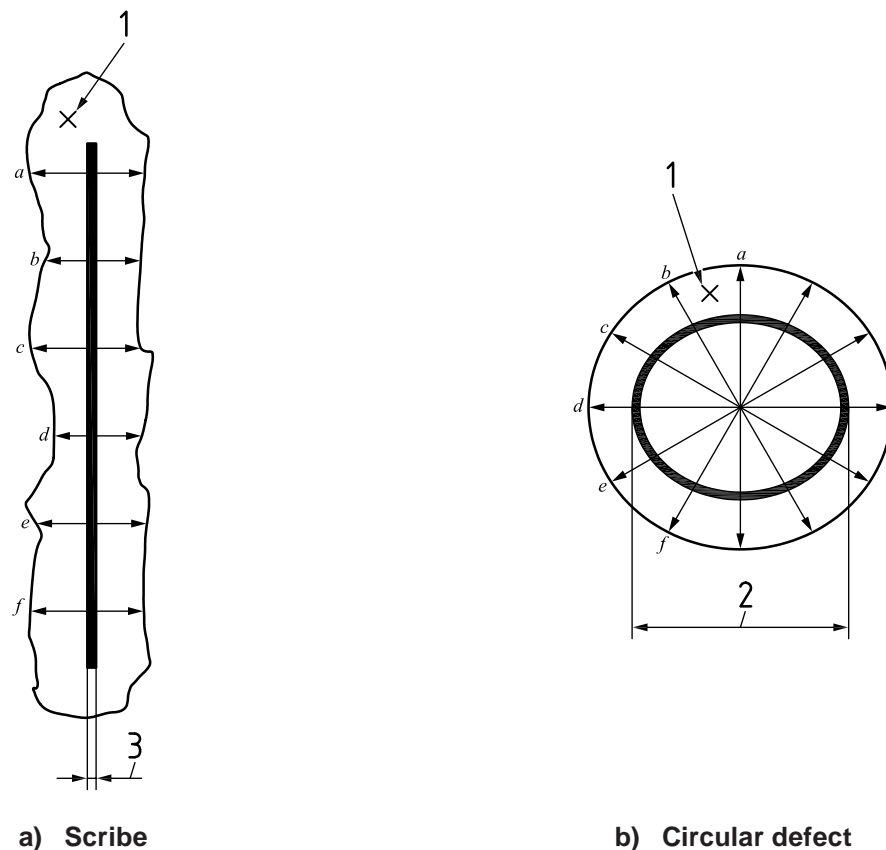

Key

- 1 corroded or delaminated area
- 2 width of original circular defect, w
- 3 width of original scribe, w

Figure 1 — Measurement of width of delamination or corrosion

5.2.2 After conditioning

Assess the delamination as specified in 5.2.1 after conditioning for 24 h at a temperature of $(23 \pm 2) ^\circ\text{C}$ and a relative humidity of $(50 \pm 5) \%$, as specified in ISO 3270.

5.3 Assessment of corrosion

5.3.1 Directly after the end of the test period

Rinse the test panel with fresh tap water immediately after exposure, i.e. before the coating dries out, blow off residues of water from the surface using compressed air if necessary, and inspect for visible changes. Carefully remove the loose coating using a knife blade held at an angle, positioning the blade at the coating/substrate interface and forcing the coating away from the substrate.

A suitable paint remover or other means, e.g. compressed air or an adhesive tape, may be used instead of a knife blade. It is important to remove the loose coating completely.

If necessary, rinse the test panel again with fresh tap water.

Measure with a ruler, to the nearest 0,5 mm, the width of corrosion at a minimum of six points uniformly distributed along the scribe or around the other artificial defect (see Figure 1). Ignore corrosion beyond the beginning and end of the original scribe.

If more accurate measurement is required, a magnifier with suitable scale may be used.

Corrosion may be measured over more than six points if the test standard being followed requires, provided this information is included in the test report. Similarly, for a scribed line of length less than 50 mm, fewer than six measurements may be made, provided that each measurement is a minimum of 6 mm apart and information is included in the test report.

NOTE The corrosion zone can normally be observed visually as a difference in colour compared to the uncorroded substrate.

5.3.2 Evaluation of corrosion on stripped test panels

Remove the coating carefully from the test panel, either with a suitable paint remover that does not exacerbate the corrosion or by mechanical means. Rinse the test panel rapidly with clean tap water, blow dry with compressed air and immediately coat completely with clear coating material such as an aerosol lacquer.

Measure the width of corrosion according to the method specified in 5.3.1.

5.4 Assessment using pictorial standards

Assessment by measurement and calculation is preferred. However, if specified between the interested parties, delamination and corrosion from a scribe may be assessed using the pictorial standards given in Figure 2.

NOTE These pictorial standards are based on the rating system defined in ISO 4628-1.^[1]

6 Calculation and expression of results

6.1 Delamination by measurement and calculation

Determine, to the nearest 0,5 mm, the mean overall width of delamination, d_1 , using Formula (1):

$$d_1 = \frac{a + b + c + d + e + f}{6} \quad (1)$$

Calculate the delamination, d , in millimetres, using Formula (2):

$$d = \frac{d_1 - w}{2} \quad (2)$$

where

- d_1 is the mean overall width of delamination, in millimetres;
 w is the width of the original scribe or other artificial defect, in millimetres;
 a, b, c, d, e, f are individual delamination measurements — see Figure 1.

If the delamination is non-uniform, increase the number of measuring points, i.e. bring the measurement points closer together, or calculate the delamination, d , in millimetres, using Formula (3) for a linear scribe or Formula (4) for a circular defect. Ignore delamination beyond the beginning and end of the original scribe. Determine the size of the area, for example by counting the corresponding squares of transparent millimetre grid paper laid over the area.

$$d = \frac{A_d - A_l}{2} \times \frac{1}{l} \quad (3)$$

$$d = \frac{1}{\sqrt{\pi}} (\sqrt{A_d} - \sqrt{A_l}) \quad (4)$$

where

- A_d is the delaminated area, including the scribe or other artificial defect area, in square millimetres;
 A_l is the area of the scribe or other artificial defect in the area evaluated, in square millimetres;
 l is the length of the scribe in the area evaluated, in millimetres.

Express the results as the mean overall width, to the nearest 0,5 mm, of delamination.

6.2 Corrosion by measurement and calculation

Determine, to the nearest 0,5 mm, the mean overall width of corrosion, w_c , using Formula (5):

$$w_c = \frac{a + b + c + d + e + f}{6} \quad (5)$$

Calculate the corrosion, c , in millimetres, using Formula (6):

$$c = \frac{w_c - w}{2} \quad (6)$$

where

- w_c is the mean overall width of corrosion, in millimetres;
 w is the width of the original scribe or other artificial defect, in millimetres;
 a, b, c, d, e, f are individual corrosion measurements — see Figure 1.

If the corrosion is non-uniform, increase the number of measuring points, i.e. bring the measurement points closer together, or calculate the corrosion, c , in millimetres, using Formula (7) for a linear scribe or Formula (8) for a circular defect. Ignore corrosion beyond the beginning and end of the original scribe. Determine the size of the area, for example by counting the corresponding squares of transparent millimetre grid paper laid over the area.

$$c = \frac{A_c - A_l}{2} \times \frac{1}{l} \quad (7)$$

$$c = \frac{1}{\sqrt{\pi}} (\sqrt{A_c} - \sqrt{A_l}) \quad (8)$$

where

A_c is the corroded area, including the scribe or other artificial defect area, in square millimetres;

A_l is the scribe or other artificial defect area in the area of evaluation, in square millimetres;

l is the evaluated scribe length in millimetres.

Express the results as the mean overall width, to the nearest 0,5 mm, of corrosion.

6.3 Assessment using pictorial standards

The numerical rating for delamination and corrosion around a scribe shall be given as indicated in the following example:

Delamination and corrosion around a scribe: corrosion grade 2; delamination grade 3.

7 Test report

The test report shall contain at least the following information:

- a) all information necessary for identification of the coating sample tested, including film thickness and number of coats;
- b) a reference to this part of ISO 4628 (ISO 4628-8:2012);
- c) number of replicate panels tested;
- d) details of the test conditioning including:
 - 1) a description of the corrosive environment,
 - 2) the duration of test in corrosive environment;
- e) details of the test procedure including:
 - 1) whether the coating was removed and the method of removal, if applicable,
 - 2) the type of scribe tool used or the method used to produce the other artificial defect,
 - 3) the shape and dimensions of the scribe or other artificial defect,
 - 4) whether assessment was made immediately at the end of the test period or after a period of conditioning, and a description of the conditioning period and environment;
- f) the results of the test, including the results of the individual assessments and their mean values, calculated in accordance with Clause 6;
- g) any deviations from the procedure specified;
- h) any unusual features (anomalies) observed during the test;
- i) the date of the test.







	Grade 1 — Very slight
	Grade 2 — Slight
	
	Grade 3 — Moderate
	
	Grade 4 — Considerable
	
	Grade 5 — Severe
	

Figure 2 — Pictorial standards for assessment of delamination and corrosion around a scribe (approximate scale 1:1)

Bibliography

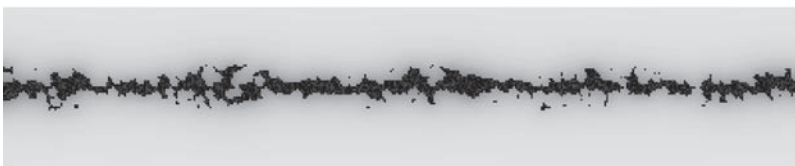
- [1] ISO 4628-1, *Paints and varnishes — Evaluation of degradation of coatings — Designation of quantity and size of defects, and of intensity of uniform changes in appearance — Part 1: General introduction and designation system*
- [2] ISO 4628-2, *Paints and varnishes — Evaluation of degradation of coatings — Designation of quantity and size of defects, and of intensity of uniform changes in appearance — Part 2: Assessment of degree of blistering*
- [3] ISO 4628-3, *Paints and varnishes — Evaluation of degradation of coatings — Designation of quantity and size of defects, and of intensity of uniform changes in appearance — Part 3: Assessment of degree of rusting*
- [4] ISO 4628-4, *Paints and varnishes — Evaluation of degradation of coatings — Designation of quantity and size of defects, and of intensity of uniform changes in appearance — Part 4: Assessment of degree of cracking*
- [5] ISO 4628-5, *Paints and varnishes — Evaluation of degradation of coatings — Designation of quantity and size of defects, and of intensity of uniform changes in appearance — Part 5: Assessment of degree of flaking*
- [6] ISO 4628-10, *Paints and varnishes — Evaluation of degradation of coatings — Designation of quantity and size of defects, and of intensity of uniform changes in appearance — Part 10: Assessment of degree of filiform corrosion*
- [7] ISO 9227, *Corrosion tests in artificial atmospheres — Salt spray tests*
- [8] ISO 15711, *Paints and varnishes — Determination of resistance to cathodic disbonding of coatings exposed to sea water*

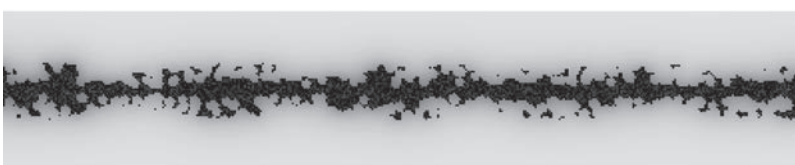
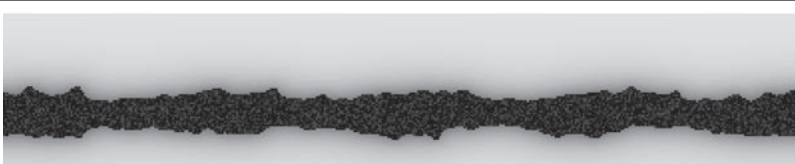
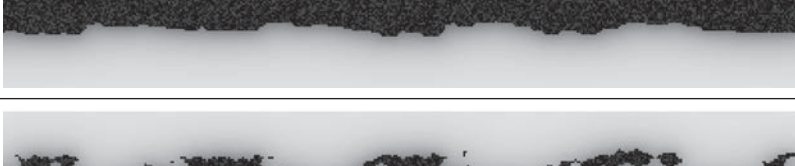