

INTERNATIONAL STANDARD

ISO 1302

Fourth edition
2002-02-01

Geometrical Product Specifications (GPS) — Indication of surface texture in technical product documentation

*Spécification géométrique des produits (GPS) — Indication des états de
surface dans la documentation technique de produits*



Reference number
ISO 1302:2002(E)

© ISO 2002

PDF disclaimer

This PDF file may contain embedded typefaces. In accordance with Adobe's licensing policy, this file may be printed or viewed but shall not be edited unless the typefaces which are embedded are licensed to and installed on the computer performing the editing. In downloading this file, parties accept therein the responsibility of not infringing Adobe's licensing policy. The ISO Central Secretariat accepts no liability in this area.

Adobe is a trademark of Adobe Systems Incorporated.

Details of the software products used to create this PDF file can be found in the General Info relative to the file; the PDF-creation parameters were optimized for printing. Every care has been taken to ensure that the file is suitable for use by ISO member bodies. In the unlikely event that a problem relating to it is found, please inform the Central Secretariat at the address given below.

© ISO 2002

All rights reserved. Unless otherwise specified, no part of this publication may be reproduced or utilized in any form or by any means, electronic or mechanical, including photocopying and microfilm, without permission in writing from either ISO at the address below or ISO's member body in the country of the requester.

ISO copyright office
Case postale 56 • CH-1211 Geneva 20
Tel. + 41 22 749 01 11
Fax + 41 22 749 09 47
E-mail copyright@iso.ch
Web www.iso.ch

Printed in Switzerland

Contents

Page

Foreword.....	iv
Introduction.....	v
1 Scope	1
2 Normative references	1
3 Terms and definitions	2
4 Graphical symbols for the indication of surface texture.....	3
5 Composition of complete graphical symbol for surface texture.....	5
6 Indication of surface texture parameters	6
7 Indication of manufacturing method or related information.....	11
8 Indication of the surface lay	12
9 Indication of machining allowance.....	14
10 Summarizing of indications of surface texture requirements and their values.....	14
11 Position on drawings and other technical product documentation.....	14
Annex A (normative) Proportions and dimensions of graphical symbols.....	20
Annex B (informative) Synoptive tables	23
Annex C (informative) Examples of indication of surface texture requirements	26
Annex D (informative) Minimum indications for unambiguous control of surface functions.....	30
Annex E (informative) Surface texture parameter designations	33
Annex F (informative) Evaluation length, l_n	36
Annex G (informative) Transmission band and sampling length.....	37
Annex H (informative) Consequences of new ISO surface texture standards	39
Annex I (informative) Former practice	41
Annex J (informative) Relation to the GPS matrix model	44
Bibliography.....	46

Foreword

ISO (the International Organization for Standardization) is a worldwide federation of national standards bodies (ISO member bodies). The work of preparing International Standards is normally carried out through ISO technical committees. Each member body interested in a subject for which a technical committee has been established has the right to be represented on that committee. International organizations, governmental and non-governmental, in liaison with ISO, also take part in the work. ISO collaborates closely with the International Electrotechnical Commission (IEC) on all matters of electrotechnical standardization.

International Standards are drafted in accordance with the rules given in the ISO/IEC Directives, Part 3.

The main task of technical committees is to prepare International Standards. Draft International Standards adopted by the technical committees are circulated to the member bodies for voting. Publication as an International Standard requires approval by at least 75 % of the member bodies casting a vote.

Attention is drawn to the possibility that some of the elements of this International Standard may be the subject of patent rights. ISO shall not be held responsible for identifying any or all such patent rights.

International Standard ISO 1302 was prepared by Technical Committee ISO/TC 213, *Dimensional and geometrical product specifications and verification*.

This fourth edition cancels and replaces the third edition (ISO 1302:1992), which has been technically revised.

Annex A forms a normative part of this International Standard. Annexes B, C, D, E, F, G, H, I and J are for information only.

Introduction

This International Standard is a geometrical product specification (GPS) standard and is to be regarded as a general GPS standard (see ISO/TR 14638). It influences link 1 of the chain of standards on roughness, waviness and primary profile.

For more detailed information of the relation of this International Standard to other standards and the GPS matrix model, see annex J.

This edition of ISO 1302 has been developed for use together with the new editions of the surface texture standards issued in 1996 and 1997, which introduce many radical changes compared with the content of the former surface texture standards issued in the 1980s. The changes are so radical that the drawing indications in some instances have a completely new interpretation. Annex H gives detailed information on these changes.

Drawing indications applied on technical drawings according to former editions of this International Standard refer to the rules given in the surface texture standards issued at the time of issue and can only be interpreted according to those surface texture standards. Annex I provides information on former practices.

The drawing indications given in this edition are to be used for the unambiguous reference to the new surface texture standards issued in 1996 and 1997.

Textual indications in this edition of ISO 1302 are under continuous development within ISO/TC 213 and a separate, detailed standard on this issue is under preparation. Consequently, the textual indications given may change in future editions of ISO 1302.

Geometrical Product Specifications (GPS) — Indication of surface texture in technical product documentation

1 Scope

This International Standard specifies the rules for the indication of surface texture in technical product documentation (e.g. drawings, specifications, contracts, reports) by means of graphical symbols and textual indications.

It is applicable to the indication of requirements for surfaces by means of

- a) profile parameters, according to ISO 4287, related to the
 - *R*-profile (roughness parameters),
 - *W*-profile (waviness parameters), and
 - *P*-profile (structural parameters),
- b) motif parameters, according to ISO 12085, related to the
 - roughness motif, and
 - waviness motif,
- c) parameters related to the material ratio curve according to ISO 13565-2 and ISO 13565-3.

NOTE For the indication of requirements for surface imperfections (pores, scratches etc.), which cannot be specified using surface texture parameters, reference is made to ISO 8785, which covers surface imperfections.

2 Normative references

The following normative documents contain provisions which, through reference in this text, constitute provisions of this International Standard. For dated references, subsequent amendments to, or revisions of, any of these publications do not apply. However, parties to agreements based on this International Standard are encouraged to investigate the possibility of applying the most recent editions of the normative documents indicated below. For undated references, the latest edition of the normative document referred to applies. Members of ISO and IEC maintain registers of currently valid International Standards.

ISO 129-1:—¹⁾, *Technical drawings — Indication of dimensions and tolerances — Part 1: General principles*

ISO 1101:—²⁾, *Geometrical Product Specifications (GPS) — Geometrical tolerancing — Tolerancing of form, orientation, location and run-out*

1) To be published. (Revision of ISO 129:1985)

2) To be published. (Revision of ISO 1101:1983)

ISO 1302:2002(E)

ISO 3098-2:2000, *Technical product documentation — Lettering — Part 2: Latin alphabet, numerals and marks*

ISO 3274:1996, *Geometrical Product Specifications (GPS) — Surface texture: Profile method — Nominal characteristics of contact (stylus) instruments*

ISO 4287:1997, *Geometrical product specifications (GPS) — Surface texture: Profile method — Terms, definitions and surface texture parameters*

ISO 4288:1996, *Geometrical product specifications (GPS) — Surface texture: Profile method — Rules and procedures for the assessment of surface texture*

ISO 8785:1998, *Geometrical product specifications (GPS) — Surface imperfections — Terms, definitions and parameters*

ISO 10135:—³⁾, *Technical drawings — Simplified representation of moulded, cast and forged parts*

ISO 10209-1:1992, *Technical product documentation — Vocabulary — Part 1: Terms relating to technical drawings: general and types of drawings*

ISO 11562:1996, *Geometrical Product Specifications (GPS) — Surface texture: Profile method — Metrological characteristics of phase correct filters*

ISO 12085:1996, *Geometrical product specifications (GPS) — Surface texture: Profile method — Motif parameters*

ISO 13565-1:1996, *Geometrical Product Specifications (GPS) — Surface texture: Profile method; Surfaces having stratified functional properties — Part 1: Filtering and general measurement conditions*

ISO 13565-2:1996, *Geometrical Product Specifications (GPS) — Surface texture: Profile method; Surfaces having stratified functional properties — Part 2: Height characterization using the linear material ratio curve*

ISO 13565-3:1998, *Geometrical Product Specifications (GPS) — Surface texture: Profile method; Surfaces having stratified functional properties — Part 3: Height characterization using the material probability curve*

ISO 14253-1:1998, *Geometrical Product Specifications (GPS) — Inspection by measurement of workpieces and measuring equipment — Part 1: Decision rules for proving conformance or non-conformance with specification*

ISO 14660-1:1999, *Geometrical Product Specifications (GPS) — Geometrical features — Part 1: General terms and definitions*

ISO 81714-1:1999, *Design of graphical symbols for use in the technical documentation of products — Part 1: Basic rules*

3 Terms and definitions

For the purposes of this International Standard, the terms and definitions given in ISO 3274, ISO 4287, ISO 4288, ISO 10209-1, ISO 11562, ISO 12085, ISO 13565-2, ISO 13565-3, ISO 14660-1 and the following apply.

3.1

basic graphical symbol

⟨surface texture⟩ graphical symbol indicating that a requirement for surface texture exists

See Figure 1.

3) To be published. (Revision of ISO 10135:1994)

3.2**expanded graphical symbol**

〈surface texture〉 expanded basic graphical symbol indicating that material is either to be removed or not removed in order to obtain the specified surface texture

See Figures 2 and 3.

3.3**complete graphical symbol**

〈surface texture〉 basic or expanded graphical symbol expanded in order to facilitate the addition of complementary surface texture requirements

See Figure 4.

3.4**surface (texture) parameter**

parameter expressing a micro-geometrical property of a surface

NOTE See annex E for examples of surface texture parameter designations.

3.5**(surface) parameter symbol**

symbol indicating the type of surface texture parameter

NOTE The parameter symbols consist of letters and numerical values (e.g. *Ra*, *Ramax*, *Wz*, *Wz1max*, *AR*, *Rpk*, *Rpq*).

4 Graphical symbols for the indication of surface texture**4.1 General**

Requirements for surface texture are indicated on technical product documentation by several variants of graphical symbols, each having its own significant meaning. The graphical symbols specified in 4.2 and 4.3 shall be supplemented with complementary surface texture requirements in the form of numerical values, graphical symbols and text (see also clauses 5, 6, 7 and 8). Attention is drawn to the fact that, in particular instances, the graphical symbols may be used alone to convey a special meaning on the technical drawing (see clause 11).

4.2 Basic graphical symbol

The basic graphical symbol shall consist of two straight lines of unequal length inclined at approximately 60° to the line representing the considered surface, as shown in Figure 1. The basic graphical symbol in Figure 1 should not be used alone (without complementary information). Its use shall be to provide collective indications as shown in Figures 23 and 26.

If the basic graphical symbol is used with complementary, supplemental information (see clause 5), then no further decision is required as to whether removal of material is necessary for obtaining the specified surface (see 4.3.1) or whether removal of material is not permitted for obtaining the specified surface (see 4.3.2).



Figure 1 — Basic graphical symbol for surface texture

4.3 Expanded graphical symbols

4.3.1 Removal of material required

If removal of material — for example, by machining — is required for obtaining the specified surface, a bar shall be added to the basic graphical symbol, as shown in Figure 2.

The expanded graphical symbol in Figure 2 should not be used alone (without complementary information).



Figure 2 — Expanded graphical symbol indicating removal of material required

4.3.2 Removal of material not permitted

If removal of material is not permitted for obtaining the specified surface, a circle shall be added to the basic graphical symbol, as shown in Figure 3. For special use of this expanded graphical symbol, see clause 10.

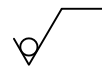
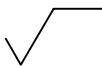

Figure 3 — Expanded graphical symbol indicating removal of material not permitted

4.4 Complete graphical symbol

When complementary requirements for surface texture characteristics have to be indicated (see clause 6), a line shall be added to the longer arm of any of the graphical symbols illustrated in Figures 1 to 3, as shown in Figure 4.

For use in the written text of — for example, reports or contracts — the textual indication for Figure 4, a) is APA⁴⁾, for b) it is MRR⁵⁾ and for c) NMR⁶⁾.



- a) any manufacturing process permitted
- b) material shall be removed
- c) material shall not be removed

Figure 4 — Complete graphical symbol

4.5 Graphical symbol for “all surfaces around a workpiece outline”

When the same surface texture is required on all surfaces around a workpiece outline (integral features), represented on the drawing by a closed outline of the workpiece, a circle shall be added to the complete graphical symbol illustrated in Figure 4, as shown in Figure 5.

Surfaces shall be indicated independently if any ambiguity may arise from the all around indication.

4) Any process allowed.
 5) Material removal required.
 6) No material removed.

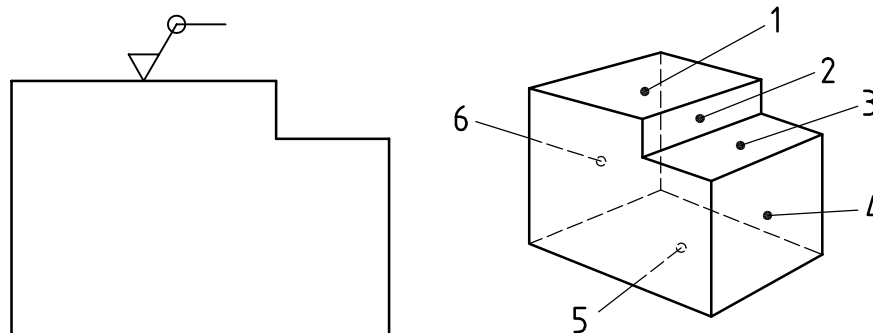

NOTE The outline on the drawing represents the six surfaces shown on the 3D-representation of the workpiece (the front and rear surfaces not included).

Figure 5 — Surface texture requirement for all six surfaces represented by outline on workpiece

5 Composition of complete graphical symbol for surface texture

5.1 General

In order to ensure that a surface texture requirement is unambiguous, it may be necessary, in addition to the indication of both a surface texture parameter and its numerical value, to specify additional requirements (e.g. transmission band or sampling length, manufacturing process, surface lay and its orientation and possible machining allowances). It may be necessary to set up requirements for several different surface texture parameters in order that the surface requirements ensure unambiguous functional properties of the surface. For more details see annex D.

5.2 Position of complementary surface texture requirements

The mandatory positions of the various surface texture requirements in the complete graphical symbol are shown in Figure 6.

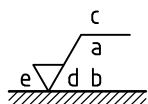

Figure 6 — Positions (a to e) for location of complementary requirements

The complementary surface texture requirements in the form of

- surface texture parameters,
- numerical values, and
- transmission band/sampling length,

shall be located at the specific positions in the complete graphical symbol in accordance with the following.

a) Position a — Single surface texture requirement

Indicate the surface texture parameter designation, the numerical limit value and the transmission band/sampling length according to clause 6. To avoid misinterpretation, a double space (double blank) shall be inserted between the parameter designation and the limit value.

Generally, the transmission band or sampling length shall be indicated followed by an oblique stroke (/), followed by the surface texture parameter designation, followed by its numerical value using one text string.

EXAMPLE 1 0,0025-0,8/Rz 6,8 (example with transmission band indicated).

EXAMPLE 2 -0,8/Rz 6,8 (example with only sampling length indicated).

Especially for the motif method, the transmission band shall be indicated, followed by an oblique stroke (/), followed by the value of the evaluation length, followed by another oblique stroke, followed by the surface texture parameter designation, followed by its numerical value.

EXAMPLE 3 0,008-0,5/16/R 10.

NOTE Generally, the transmission band is the wavelength range between two defined filters (see ISO 3274 and ISO 11562) and, for the motif method, the wavelength range between two defined limits (see ISO 12085).

b) Position a and b — Two or more surface texture requirements

Indicate the first surface texture requirement at position “a” as in a). Indicate the second surface texture requirement at position “b”. If a third requirement or more is to be indicated, the graphical symbol is to be enlarged accordingly in the vertical direction, to make room for more lines. The position “a” and “b” are to be moved upwards when the symbol is enlarged (see clause 6).

c) Position c — Manufacturing method

Indicate the manufacturing method, treatment, coatings or other requirements for the manufacturing process etc. to produce the surface, for example, turned, ground, plated (see also clause 7).

d) Position d — Surface lay and orientation

Indicate the symbol of the required surface lay and the orientation, if any, of the surface lay, for example, “=”, “X”, “M” (see also clause 8).

e) Position e — Machining allowance

Indicate the required machining allowance, if any, as a numerical value given in millimetres, see also clause 9.

6 Indication of surface texture parameters

6.1 General

The parameter designation and the associated numerical value, which shall be indicated, includes four items of information essential for the interpretation of the requirement. These are

- which of the three surface profiles (*R*, *W* or *P*) is indicated,
- which characteristic of the profile is indicated,
- how many sampling lengths make up the evaluation length, and
- how the indicated specification limit shall be interpreted.

Three principal groups of surface texture parameters have been standardized for use in connection with the complete symbol. The definitions of the parameters may be found in ISO 4287, ISO 12085, ISO 13565-2 and ISO 13565-3, in accordance with Table 1.

Table 1 — Overview of parameter types

	Parameters							
	Profile			Motif		Material ratio curve		
	<i>R</i>	<i>W</i>	<i>P</i>	<i>R</i>	<i>W</i>	linear	probability	
						<i>R</i>	<i>R</i>	<i>P</i>
Designation	See E.2	See E.2	See E.2	See E.3	See E.3	See E.4.2	See E.4.3	See E.4.3
Evaluation length	See F.2	See F.2	See F.2	See F.3	See F.3	See F.4	See F.4	See F.4
Tolerance limit	See 6.4							
Transmission band	See G.2	See G.2	See G.2	See G.3	See G.3	See G.4	See G.4	See G.4

6.2 Indication of parameter designations

See annex E. If the parameter designations are indicated as in annex E, without modifiers, this means that the default definition or the default interpretation of the specification limit ("16 %-rule", see 4.2 and 4.3 of ISO 4288:1996) is invoked. See 6.4 for an indication of the "max-rule" for the interpretation of the specification limit.

6.3 Indication of evaluation length, l_n

6.3.1 General

If the parameter designation is indicated as shown in annex E, without modifiers, this implies that the requirement is the default evaluation length, if it is defined in the pertinent standards.

In those cases where no default definition exists for the number of sampling lengths within the evaluation length, the number of sampling lengths shall be added to the parameter designation in order to obtain an unambiguous surface texture requirement.

6.3.2 Profile parameters (ISO 4287)

— *R*-profile

See F.2. If the number of sampling lengths within the evaluation length differs from the default number of five (see 4.4 of ISO 4288:1996), it shall be indicated adjacent to the relevant parameter designation.

EXAMPLE Rp3 or Rv3 or Rz3 or Rc3 or Rt3 or Ra3 or ..., RSm3, ... (if an evaluation length of three sampling lengths is desired).

— *W*-profile

See F.2. The number of sampling lengths shall always be indicated adjacent to the parameter designation of waviness.

EXAMPLE Wz5 or Wa3.

— *P*-profile

See F.2. The sampling length for *P* parameters is equivalent to the evaluation length (see 3.1.9 of ISO 4287:1997) and the evaluation length is equal to the length of the feature being measured (see 4.4 of ISO 4287:1997). Consequently, the indication of the number of sampling lengths in the parameter designation of structure parameters is not relevant.

6.3.3 Motif parameters (ISO 12085)

See F.3. If the evaluation length differs from the default number of 16 mm, it shall be indicated between two oblique strokes.

EXAMPLE 0,008-0,5/12/R 10

NOTE Attention is drawn to the fact that the evaluation length concept in the case of motif parameters has a meaning different from that of other surface texture parameters in that the sampling length concept does not exist. Consequently, indication of the number of sampling lengths in the parameter designation of motif parameters is not relevant.

6.3.4 Parameters based on material ratio curve (ISO 13565-2, ISO 13565-3)

— R-profile

See F.4. If the number of sampling lengths within the evaluation length differs from the default number of five (see clause 7 of ISO 13565-1:1996), it shall be indicated adjacent to the relevant parameter designation.

EXAMPLE Rk8, Rpk8, Rvk8, Rpq8, Rvq8, Rmq8 (if an evaluation length of eight sampling lengths is desired).

For the R-profile parameters based on the linear material ratio curve according to ISO 13565-2 and ISO 12085 — i.e. the parameters *Rke*, *Rpke*, *Rvke*, etc. — the indication of the evaluation length shall be according to 6.3.3.

— P-profile

See F.4. The sampling length for P parameters is equivalent to the evaluation length (see 3.1.9 of ISO 4287:1997) and the evaluation length is equal to the length of the feature being measured (see 4.4 of ISO 4287:1997). Consequently, the indication of the number of sampling lengths in the parameter designation of structure parameters is not relevant.

6.4 Indication of tolerance limits

6.4.1 General

There are two different ways of indicating and interpreting the specification limits of surface texture:

- a) the “16 % rule”;
- b) the “max-rule”.

See 5.2 and 5.3 of ISO 4288:1996, respectively.

The “16 %-rule” is defined as the default rule for all indications of surface texture requirements. This means that the “16 %-rule” applies to a surface texture requirement when a parameter designation as shown in Annex E is applied (see Figure 7). If the “max-rule” is to be applied to a surface texture requirement, “max” shall be added to the parameter designation (see Figure 8). The “max-rule” does not apply to motif parameters.

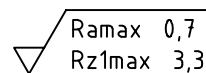

Figure 7 — Parameter indication where “16 %-rule” applies (default transmission band)

MRR R_{max} 0,7; R_{z1max} 3,3

a) in text

b) on drawing

Figure 8 — Parameter indication where “max-rule” applies (default transmission band)

6.4.2 Profile parameters (ISO 4287)

The “16 %-rule” and the “max-rule” are both applicable to profile parameters defined in ISO 4287.

6.4.3 Motif parameters (ISO 12085)

The motif parameters are defined using only the “16 %-rule” (see 5.4 of ISO 12085:1996).

6.4.4 Parameters based on material ratio curve (ISO 13565-2, ISO 13565-3)

The “16 %-rule” and the “max-rule” are both applicable to parameters related to the material ratio curve defined in ISO 13565-2 and ISO 13565-3.

6.5 Indication of transmission band and sampling length

6.5.1 General

Where no transmission band is indicated in connection with the parameter designation, the default transmission band applies to the surface texture requirement (see annex G for the definition of default transmission bands; see the surface texture requirements in Figures 7 and 8 for no transmission band indicated).

Certain surface texture parameters do not have a defined default transmission band, a default short-wave filter or a default sampling length (long-wave filter). Consequently, the surface texture indication shall specify transmission band, short-wave filter or long-wave filter to ensure that the surface texture requirement is unambiguous.

To provide assurance that the surface is controlled unambiguously by the surface texture requirement, the transmission band shall be indicated in front of the parameter designation separated from it by an oblique stroke (/).

The transmission band shall be indicated by the inclusion of the cut-off values of the filters (in millimetres), separated by a hyphen (“-”), the short-wave filter indicated first, and the long-wave filter second. See Figure 9.

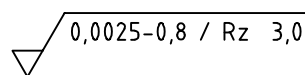
MRR 0,0025-0,8 / R_z 3,0

a) in text

b) on drawing

Figure 9 — Indication of transmission band in connection with surface texture requirement

In some cases, it may be relevant to indicate only one of the two filters in the transmission band. The second filter then has its default value, if it exists. If only one filter is indicated, the hyphen is maintained to indicate whether the indication is of the short-wave or the long-wave filter.

EXAMPLE 1 0,008- (short-wave filter indication).

EXAMPLE 2 -0,25 (long-wave filter indication).

6.5.2 Profile parameters (ISO 4287)

— **R-profile**

See G.2. In the event of the transmission band being indicated, it may only be necessary to indicate the long-wave filter λ_c (e.g. -0,8). The short-wave filter λ_s will then be as specified in 4.4 of ISO 3274:1996.

If control of both the short-wave filter and the long-wave filter in the transmission band for roughness parameters is required, both shall be indicated in connection with the parameter symbol.

EXAMPLE 0,008-0,8

— **W-profile**

See G.2. The transmission band shall always be indicated by both cut-off values to ensure an unambiguous requirement. The transmission band for waviness may be indicated, based on the default cut-off λ_c for surface roughness according to ISO 4288, for the same surface (see Figure 10), by the expression $\lambda_c - n \times \lambda_c$, where the number, n , is chosen by the designer.



Figure 10 — Transmission band for waviness based on default cut-off λ_c for surface roughness

— **P-profile**

See G.2. The cut-off value of the short-wave filter λ_s shall always be indicated to ensure an unambiguous requirement.

In the default case, P -parameters do not have any long-wave filters (sampling lengths). A long-wave filter (sampling length) may be indicated for P -parameters if required for the function of the workpiece.

EXAMPLE -25/Pz 225

6.5.3 Motif parameters (ISO 12085)

— **Roughness profile**

See G.3. It is not necessary to indicate the evaluation length if its value is taken from ISO 12085:1996, (Table 1) for the corresponding couple (λ_s, A). Nevertheless, the two oblique strokes shall be indicated.

If no limit for the short-wavelength is indicated, the default value is $\lambda_s = 0,008$ mm.

— **Waviness profile**

See G.3. Both limits A and B for the short-wavelength and the long-wavelength shall be indicated together.

It is not necessary to indicate the evaluation length if its value is issued from ISO 12085:1996, Table 1, for the corresponding couple (A, B). Nevertheless, the two oblique strokes shall be indicated.

If no limit is indicated, the default values are $A = 0,5$ mm and $B = 2,5$ mm.

6.5.4 Parameters based on the material ratio curve (ISO 13565-2, ISO 13565-3)

— *R*-profile

See G.4. Only the default and one non-default are standardized.

— *P*-profile

See G.4. If *P*-parameters are indicated according to ISO 13565-3, the short-wave filter λ_s shall be indicated in connection with the parameter designation to ensure an unambiguous requirement.

In the default case, *P*-parameters do not have any long-wave filters (sampling lengths). A long-wave filter (sampling length) can be indicated for *P*-parameters if required for the function of the workpiece.

6.6 Tolerance types — Unilateral or bilateral

6.6.1 General

The surface texture requirement shall be indicated as a unilateral or bilateral tolerance. The tolerance limits shall be expressed by indication of the parameter designation, the parameter value and the transmission band as described in 6.2, 6.3, 6.4 and 6.5.

6.6.2 Unilateral tolerance of a surface parameter

When the parameter designation, the parameter value and the transmission band are indicated, they shall be understood as a unilateral upper tolerance limit of the parameter in question (“16 %-rule” or “max-rule” limit).

If the parameter designation, the parameter value and the transmission band indicated are to be interpreted as a unilateral lower tolerance limit of the parameter in question (16 % or max. limit), then the parameter designation shall be preceded by the letter L.

EXAMPLE L Ra 0,32

6.6.3 Bilateral tolerance of a surface parameter

A bilateral tolerance shall be indicated in the complete symbol by placing the requirement for the two tolerance limits above each other, the upper specification limit (“16 %-rule” or “max-rule” limit) preceded by U being indicated over the lower specification limit preceded by L (see Figure 11). Where the upper and lower limits are expressed by the same parameter with different limit values, the U and L may be omitted provided the omission does not leave any doubt.

The upper and lower specification limits are not necessarily expressed by means of the same parameter designation and transmission band.

MRR U Rz 0,9; L Ra 0,3

a) in text

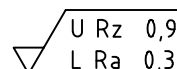

b) on drawing

Figure 11 — Bilateral surface specification

7 Indication of manufacturing method or related information

The surface texture parameter value of an actual surface is strongly influenced by the detailed form of the profile curve. A parameter designation, parameter value and transmission band — indicated solely as a surface texture requirement — do not therefore necessarily result in an unambiguous function of the surface. It is consequently

necessary in almost all cases to state the manufacturing process, as this process to some extent results in a particular detailed form of the profile curve.

There may also be other reasons for finding it appropriate to indicate the process.

The manufacturing process of the specified surface can be presented as text and added to the complete symbol as shown in Figures 12 and 13. The coating in Figure 13 is, as an example, indicated using the symbolic presentation in ISO 1456.



Figure 12 — Indication of machining process and requirement for roughness of resulting surface



Figure 13 — Indication of coating and roughness requirement

8 Indication of the surface lay

The surface lay and direction of the lay emanating from the manufacturing process (e.g. traces left by tools) may be indicated in the complete symbol by using the symbols shown in Table 2 and illustrated by the example in Figure 14. The indication of surface lay by the defined symbols (e.g. the perpendicularity symbol in Figure 14) is not applicable to textual indications.

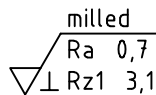

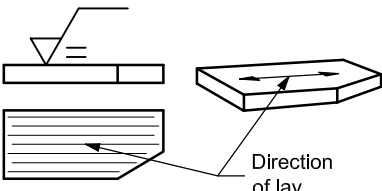

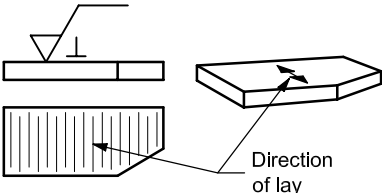

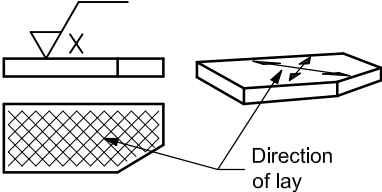

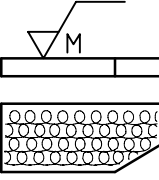

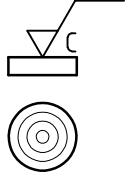

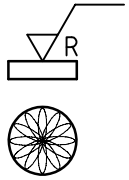

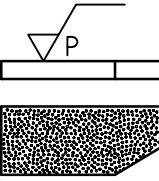

Figure 14 — Direction of lay of surface pattern indicated perpendicular to drawing plane

NOTE The direction of lay is the direction of the prevailing surface pattern, which is usually determined by the manufacturing process used.

The symbols in Table 2 indicate the lay and direction of lay in relation to the drawing plane containing the surface texture requirement.

Table 2 — Indication of surface lay

Graphical symbol	Interpretation and example	
	<p>Parallel to plane of projection of view in which symbol is used</p>	
	<p>Perpendicular to plane of projection of view in which symbol is used</p>	
	<p>Crossed in two oblique directions relative to plane of projection of view in which symbol is used</p>	
	<p>Multi-directional</p>	
	<p>Approx. circular relative to centre of surface to which symbol applies</p>	
	<p>Approx. radial relative to centre of surface to which symbol applies</p>	
	<p>Lay is particulate, non-directional, or protuberant</p>	
<p>If it is necessary to specify a surface pattern which is not clearly defined by these symbols, this shall be achieved by the addition of a suitable note to the drawing.</p>		

9 Indication of machining allowance

The machining allowance is generally indicated only in those cases where more process stages are shown in the same drawing. Machining allowances are therefore found (e.g. on drawings of raw cast and forged workpieces with the final workpiece being shown in the raw workpiece). For the definition and application of requirements for machining allowances, see ISO 10135. The indication of the machining allowance by the defined symbol is not applicable to textual indications.

When the machining allowance is indicated, it may occur that the requirement for the machining allowance is the only requirement added to the complete symbol. The machining allowance may also be indicated in connection with a normal surface texture requirement (see Figure 15).

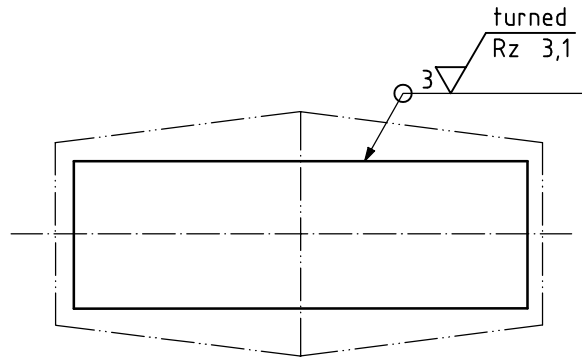

Figure 15 — Indication of surface texture requirements for “final” workpiece (including requirement for 3 mm machining allowance for all surfaces)

10 Summarizing of indications of surface texture requirements and their values

As a principle, surface texture requirements on a technical drawing shall consist of at least one of the symbols shown in Figures 1 to 5 and the relevant supplementary annotations described in clauses 5 to 9.

Graphical symbols used alone only have meaning as a surface texture requirement

- when used according to 11.3, or
- when the basic graphical symbol, shown in Figure 3, is used on a drawing concerning a manufacturing process.

In the case of the latter, the interpretation is as follows.

The specified surface shall be left in the state resulting from a preceding manufacturing process, whether or not the condition was obtained by removal of material or by other means.

Determination of whether a particular surface is in conformance or not with a given surface texture requirement shall be carried out in accordance with ISO 14253-1. Furthermore, the interpretation rules of this International Standard and the content of the relevant surface texture standards shall be taken into account.

11 Position on drawings and other technical product documentation

11.1 General

Surface texture requirements shall be indicated only once for a given surface and, if possible, on the same view where the size or location, or both, are indicated and toleranced.

Unless otherwise specified, the indicated surface texture requirements are applicable for the surface after machining, coating, etc. (see also annex C).

11.2 Position and orientation of graphical symbol and its annotation

11.2.1 General

The general rule is that the graphical symbol together with the complementary information shall be oriented so that they are readable from the bottom or right-hand side of the drawing, in accordance with ISO 129-1 (see Figure 16).

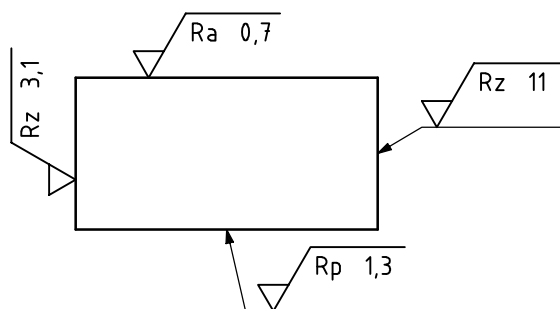

Figure 16 — Direction of reading of surface texture requirements

11.2.2 On outline or by reference line and leader line

The surface texture requirement (graphical symbol) shall touch the surface or be connected to it by means of a reference/leader line terminating in an arrowhead.

As a general rule, the graphical symbol, or the leader line terminating in an arrowhead (or other relevant terminator), shall point at the surface from outside the material of the workpiece — either to the outline (representing the surface) or the extension of it (see Figures 17 and 18).

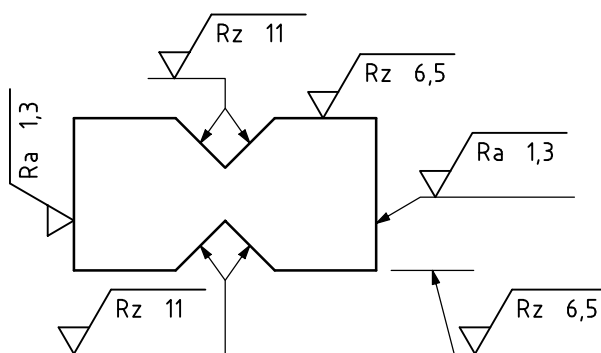

Figure 17 — Surface texture requirements on contour line representing surface

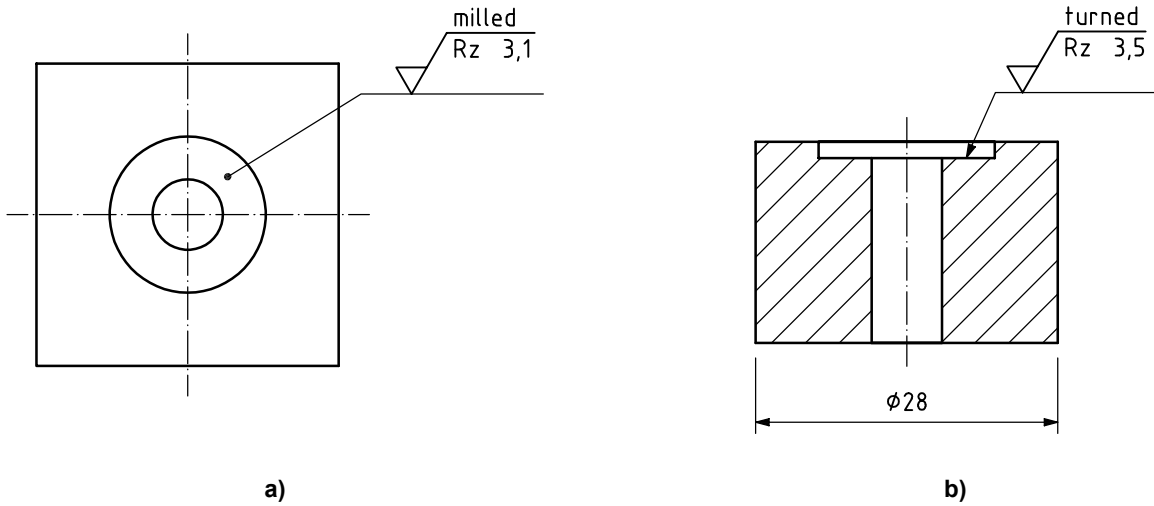

Figure 18 — Alternative use of reference lines and leader lines

11.2.3 On dimension line in connection with feature-of-size dimension

If there is no risk of misinterpretation, the surface texture requirement may be indicated in connection with the dimensions given, as shown in Figure 19.

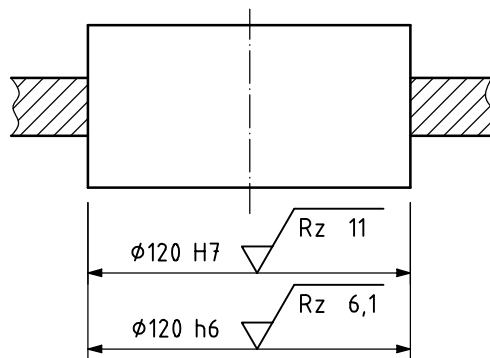

Figure 19 — Surface texture requirement — Feature-of-size dimension

11.2.4 On tolerance frame for geometrical tolerances

The surface texture requirement may be placed on top of the tolerance frame for geometrical tolerances (according to ISO 1101), as shown in Figure 20, a) and b).



Figure 20 — Surface texture requirement — Geometrical tolerances indication

11.2.5 On extension lines

The surface texture requirement may be directly placed on extension lines or be connected to it by a reference/leader line terminating in an arrowhead, as shown in Figures 17 and 21.

11.2.6 Cylindrical and prismatic surfaces

Cylindrical as well as prismatic surfaces may be specified only once if indicated by a centreline and if each prismatic surface has the same surface texture requirement (see Figure 21). However, each prismatic surface shall be indicated separately if different surface textures are required on the individual prismatic surfaces (see Figure 22).

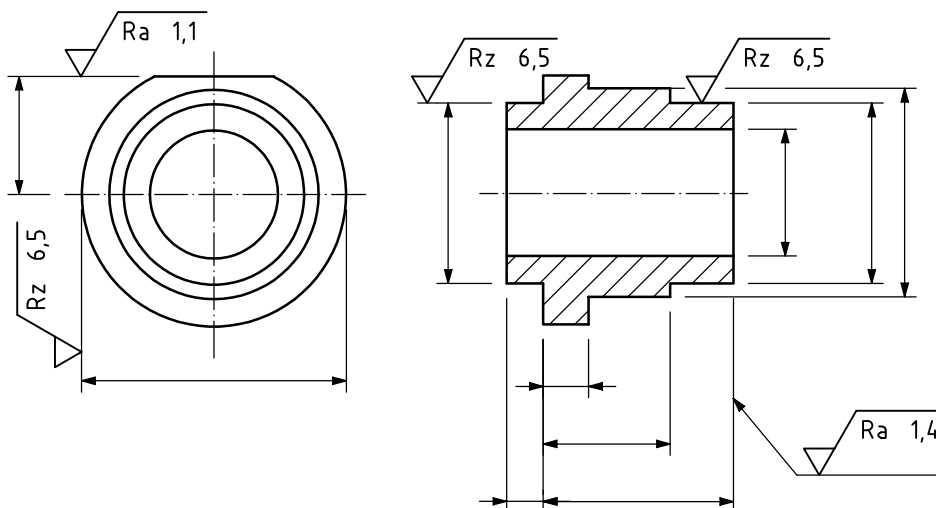

Figure 21 — Surface texture requirements — Extension lines of cylindrical features

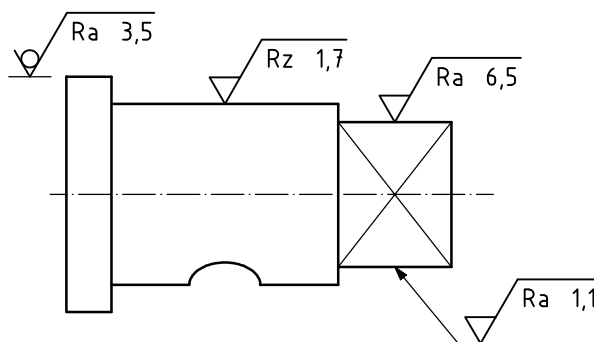

Figure 22 — Surface texture requirements — Cylindrical and prismatic surfaces

11.3 Simplified drawing indications of surface texture requirements

11.3.1 Majority of surfaces having same surface texture requirement

If the same surface texture is required on the majority of the surfaces of a workpiece, this surface texture requirement should be placed close to the title block of the drawing.

The general graphical symbol corresponding to this surface texture shall be followed by

— a basic symbol in parentheses without any other indication (see Figure 23), or

- the special deviating surface texture requirement or requirements in parentheses (see Figure 24), in order to indicate requirements that deviate from the general surface texture requirement.

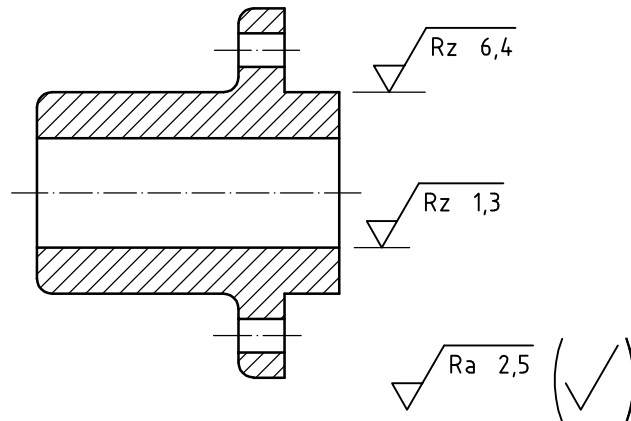

Figure 23 — Simplified indication — Majority of surfaces with same required surface texture

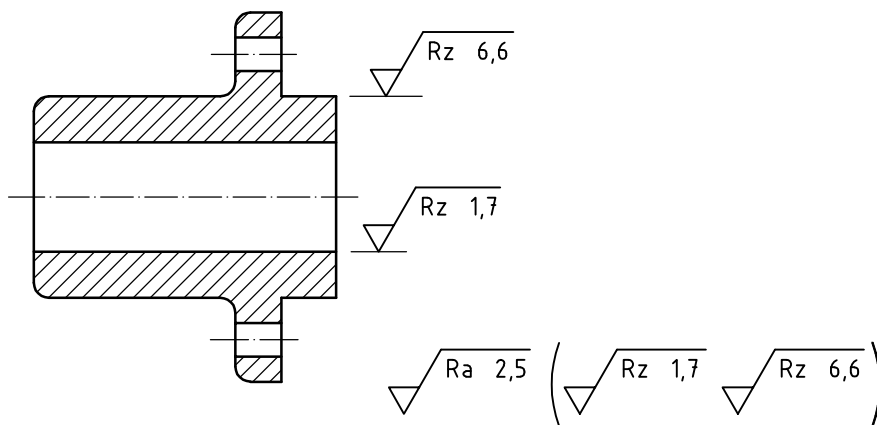

Figure 24 — Simplified indication — Majority of surfaces with same required surface texture

Surface texture requirements that deviate from the general surface texture requirement shall be indicated directly on the drawing in the same view of the particular surfaces in question (see Figures 23 and 24).

11.3.2 Common requirements on multiple surfaces

11.3.2.1 General

To avoid the necessity of repeating a complicated indication a number of times, or where space is limited, or if the same surface texture is required on a large number of surfaces of the workpiece, a simplified reference indication may be invoked as follows.

11.3.2.2 Indication by graphical symbol with letters

A simplified reference indication may be used on the surface provided that its meaning is explained near the workpiece in question, near the title block or in the space devoted to general notes (see Figure 25).

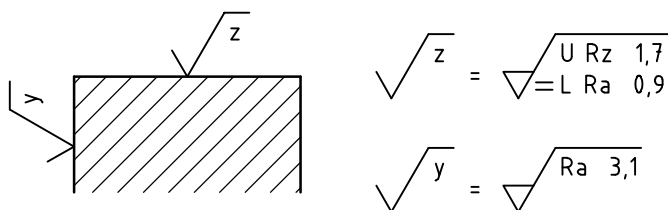

Figure 25 — Reference indication in case of minimal drawing space

11.3.2.3 Indication by graphical symbol alone

The corresponding graphical symbol shown in Figures 1, 2 or 3 may be used on the appropriate surface and its meaning given on the drawing as shown in Figures 26 to 28.

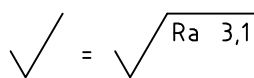

Figure 26 — Simplified indication of surface texture requirements — Unspecified manufacturing process

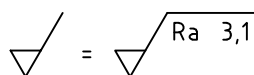

Figure 27 — Simplified indication of surface texture requirement — Removal of material required

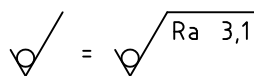

Figure 28 — Simplified indication of surface texture requirement — Removal of material not permitted

11.4 Indication of two or more manufacturing methods

If it is necessary to define surface texture both before and after treatment, this shall be explained in a note or in accordance with Figure 29 (for another example, see C.8).

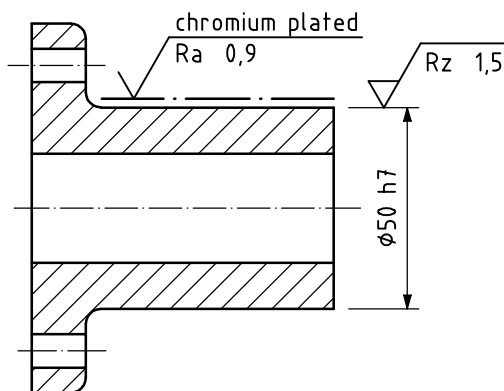

Figure 29 — Indication of surface texture requirement before and after treatment (in this case, coating)

Annex A (normative)

Proportions and dimensions of graphical symbols

A.1 General requirements

In order to harmonize the size of the symbols specified in this International Standard with those of other inscriptions on technical drawings (dimensions, geometrical tolerances, etc.) the rules given in ISO 81714-1 are applicable.

A.2 Proportions

The basic graphical symbol and its complements (see clause 4) shall be drawn in accordance with Figures A.1 to A.3. The shape of the symbols in Figure A.2, c) to g), is the same as that of the corresponding capital letter in ISO 3098-2:2000 (lettering B, vertical). For dimensions, see A.3. The length of the horizontal stroke of the symbol in Figure A.1 b) depends on the indication to be placed above and beneath it.

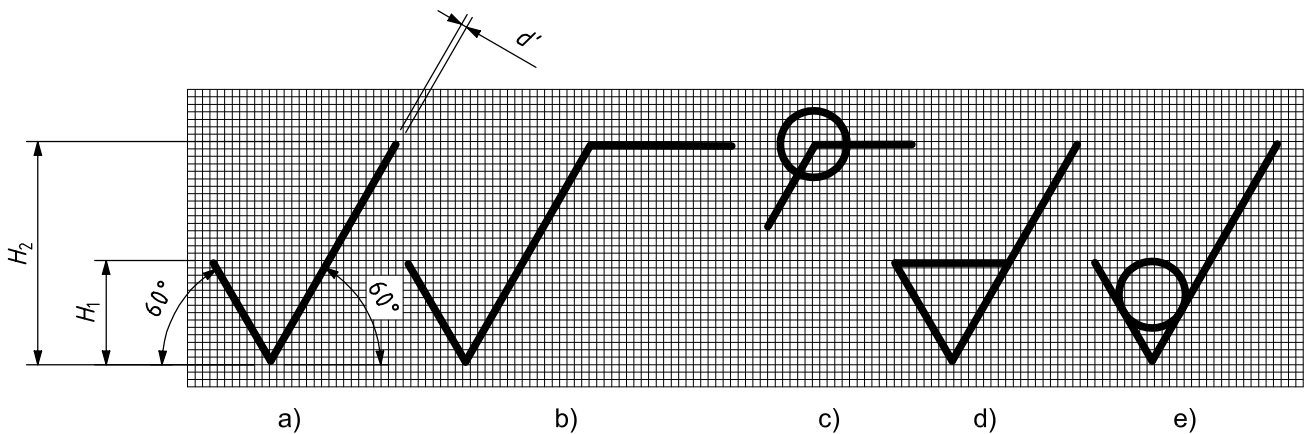

NOTE The graphical symbols carry the following registration numbers:

- a) Reg. No. 20002;
- b) Reg. No. 20003;
- c) Reg. No. 20004;
- d) Reg. No. 20005;
- e) Reg. No. 20006.

Figure A.1

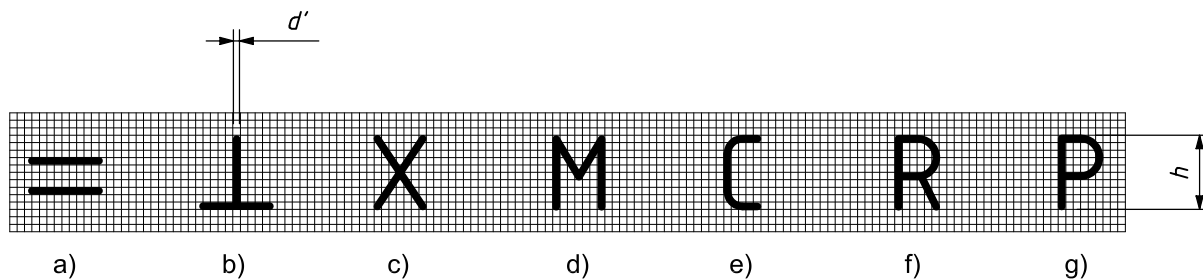

NOTE The graphical symbols carry the following registration numbers:

- a) Reg. No. 20007
- b) Reg. No. 20008
- c) Reg. No. 20009
- d) Reg. No. 20010
- e) Reg. No. 20011
- f) Reg. No. 20012
- g) Reg. No. 20013

Figure A.2

The height of all lettering in areas “a”, “b”, “d” and “e” in Figure A.3 shall be equal to h .

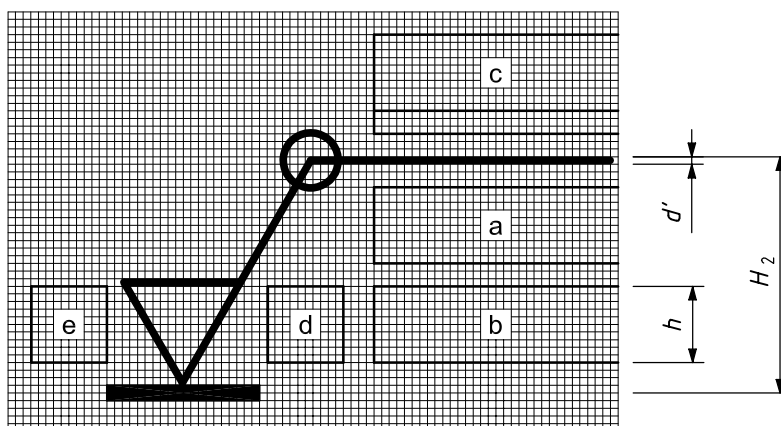

NOTE For the placing of surface texture specifications in positions “a” to “e”, see Figures 7 to 15.

Figure A.3

As the lettering in area c of Figure A.3 may comprise capital or lower-case letters or both, the height of this area may be greater than h to allow for tails of lower case-case letters.

A.3 Dimensions

The dimensions of the graphical symbols and additional indications shall be as specified in Table A.1.

Table A.1 — Dimensions

Dimensions in millimetres

Height of numerals and letters, h (see ISO 3098-2)	2,5	3,5	5	7	10	14	20
Line width for symbols, d'	0,25	0,35	0,5	0,7	1	1,4	2
Line width for lettering, d							
Height, H_1	3,5	5	7	10	14	20	28
Height, H_2 (minimum) ^a	7,5	10,5	15	21	30	42	60
^a H_2 depends on the number of lines of indication.							

Annex B (informative)

Synoptive tables

B.1 Graphical symbols without inscription

Reference No.	Symbol	Meaning
B.1.1		Basic graphical symbol: may only be used in isolation when its meaning is "the surface under consideration" or when explained by a note (see 4.2).
B.1.2		Expanded graphical symbol: machining surface with no indication of other details; in isolation, this expanded graphical symbol may only be used when its meaning is "a surface to be machined".
B.1.3		Expanded graphical symbol: surface from which removal of material is prohibited; this expanded graphical symbol may also be used in a drawing relating to a manufacturing process to indicate that a surface is to be left in the state resulting from a preceding manufacturing process, regardless of whether this state was achieved by removal of material or otherwise.

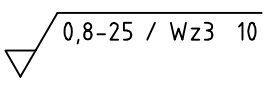
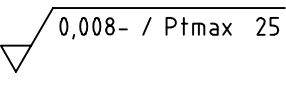
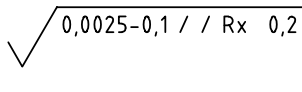
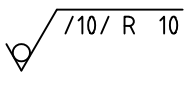
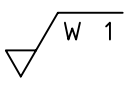
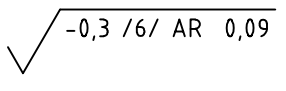

B.2 Graphical symbols with indication of surface texture

Reference No.	Symbol	Meaning/Explanation
B.2.1		The process is not permitted to remove material, unilateral upper specification limit, default transmission band, <i>R</i> -profile, maximum height of roughness 0,5 μm , evaluation length of five sampling lengths (default), "16 %-rule" (default).
B.2.2		The process shall remove material, unilateral upper specification limit, default transmission band, <i>R</i> -profile, maximum height of roughness 0,3 μm , evaluation length of five sampling lengths (default), "max-rule".
B.2.3		The process shall remove material, unilateral upper specification limit, transmission band 0,008-0,8 mm, <i>R</i> -profile, arithmetic mean deviation 3,1 μm , evaluation length of 5 sampling lengths (default), "16 %-rule" (default).
B.2.4		The process shall remove material, unilateral upper specification limit, transmission band: sampling length 0,8 mm (λ_s default 0,002 5 mm) according to ISO 3274, <i>R</i> -profile, arithmetic mean deviation 3,1 μm , evaluation length of three sampling lengths (default), "16 %-rule" (default).
B.2.5		The process is not permitted to remove material, double-sided upper and lower specification limits, default transmission band for both limits, <i>R</i> -profile, upper limit: arithmetic mean deviation 3,1 μm , evaluation length of five sampling lengths (default), "max-rule", lower limit: arithmetic mean deviation 0,9 μm , evaluation length of five sampling lengths (default), "16 %-rule" (default.)

Reference No.	Symbol	Meaning/Explanation
B.2.6		The process shall remove material, unilateral upper specification limit, transmission band 0,8 - 25 mm, <i>W</i> -profile, maximum height of waviness 10 µm, evaluation length of three sampling lengths, "16 %-rule" (default).
B.2.7		The process shall remove material, unilateral upper specification limit, transmission band λs = 0,008 mm, no long-wave filter, <i>P</i> -profile, total profile height 25 µm, evaluation length equal workpiece length (default), "max-rule".
B.2.8		Any manufacturing process, unilateral upper specification limit, transmission band λs = 0,002 5 mm; <i>A</i> = 0,1 mm, evaluation length 3,2 mm (default), roughness motif parameter, maximum depth of roughness motif 0,2 µm, "16 %-rule" (default).
B.2.9		The process is not permitted to remove material, unilateral upper specification limit, transmission band λs = 0,008 mm (default), <i>A</i> = 0,5 mm (default), evaluation length 10 mm, roughness motif parameter, mean depth of roughness motif 10 µm, "16 %-rule" (default).
B.2.10		The process shall remove material, unilateral upper specification limit, transmission band <i>A</i> = 0,5 mm (default), <i>B</i> = 2,5 mm (default), evaluation length 16 mm (default), waviness motif parameter, mean depth of waviness motif 1mm, "16 %-rule" (default).
B.2.11		Any manufacturing process, unilateral upper specification limit, transmission band λs = 0,008 mm (default); <i>A</i> = 0,3 mm, evaluation length 6 mm, roughness motif parameter, mean spacing of roughness motif 0,09 mm, "16 %-rule" (default).
NOTE Surface texture parameters, transmission bands/sampling lengths and parameter values and choice of symbols are given as examples only.		

B.3 Symbols with supplementary information

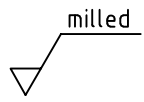
These indications may be used in combination with the appropriate graphical symbols from B.2.

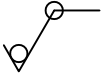
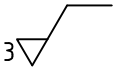
Reference No.	Symbol	Meaning
B.3.1		Manufacturing method: milled (see 5.2).
B.3.2		Surface pattern: direction of lay multidirectional (see clause 8).
B.3.3		Surface texture requirement applies to complete closed outline of the projection view (see 4.5).
B.3.4		Machining allowance 3 mm (see 5.2).
NOTE The manufacturing method, surface pattern and machining allowance are given as examples only.		

B.4 Simplified symbols

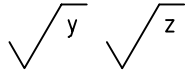
Reference No.	Symbol	Meaning
B.4.1		The meaning is defined by text added to the drawing (see 11.3.1 and 11.3.2.2).
B.4.2		

Annex C
(informative)

Examples of indication of surface texture requirements

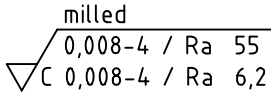
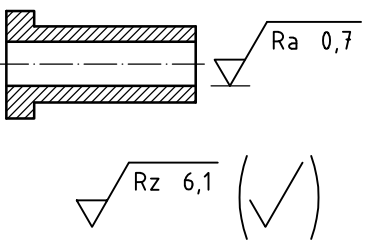
Reference No.	Requirement	Example
<p>C.1</p>	<p>Surface roughness:</p> <ul style="list-style-type: none"> — bilateral specification; — upper specification limit $Ra = 55 \mu\text{m}$, — lower specification limit $Ra = 6,2 \mu\text{m}$; — both "16 %-rule", default (ISO 4288); — both transmission band 0,008-4 mm; — default evaluation length ($5 \times 4 \text{ mm} = 20 \text{ mm}$) (ISO 4288); — surface lay approximately circular around the centre; — manufacturing process, milling. <p>NOTE U and L is not stated because there is no doubt.</p>	 <p>milled $\sqrt{C} \frac{0,008-4 / Ra \ 55}{0,008-4 / Ra \ 6,2}$</p>
<p>C.2</p>	<p>Surface roughness on all surfaces except one:</p> <ul style="list-style-type: none"> — one single, unilateral/upper specification limit — $Rz = 6,1 \mu\text{m}$; — "16 %-rule", default (ISO 4288); — default transmission band (ISO 4288 and ISO 3274); — default evaluation length ($5 \times \lambda_c$) (ISO 4288); — surface lay, no requirement; — manufacturing process shall remove material <p>The surface with a different requirement has a surface roughness:</p> <ul style="list-style-type: none"> — one single, unilateral/upper specification limit; — $Ra = 0,7 \mu\text{m}$; — "16 %-rule", default; — default transmission band (ISO 4288 and ISO 3274); — default evaluation length ($5 \times \lambda_c$) (ISO 4288); — surface lay, no requirement; — manufacturing process shall remove material. 	 <p>$Ra \ 0,7$ $Rz \ 6,1$ (✓)</p>

Normen-Download-Beuth-Altom Power Generation AG-KdNr.528 1078-LfNr.:2366107001-2004-04-16 16:25

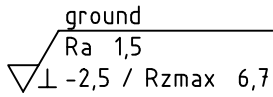
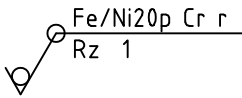
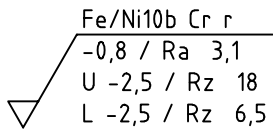
Reference No.	Requirement	Example										
<p>C.3</p>	<p>Surface roughness:</p> <ul style="list-style-type: none"> — two, unilateral/upper specification limits: <table style="width: 100%; border: none;"> <tr> <td style="width: 50%;">1) $R_a = 1,5 \mu\text{m}$;</td> <td style="width: 50%;">5) $R_z \text{ max} = 6,7 \mu\text{m}$;</td> </tr> <tr> <td>2) "16 %-rule", default (ISO 4288);</td> <td>6) max- rule;</td> </tr> <tr> <td>3) default transmission band (ISO 4288 and ISO 3274);</td> <td>7) transmission band – 2,5 mm (ISO 3274);</td> </tr> <tr> <td>4) default evaluation length ($5 \times \lambda_c$) (ISO 4288);</td> <td>8) evaluation length default ($5 \times 2,5 \text{ mm}$);</td> </tr> </table> — surface lay approximately perpendicular on the projection plane; — manufacturing process, grinding. 	1) $R_a = 1,5 \mu\text{m}$;	5) $R_z \text{ max} = 6,7 \mu\text{m}$;	2) "16 %-rule", default (ISO 4288);	6) max- rule;	3) default transmission band (ISO 4288 and ISO 3274);	7) transmission band – 2,5 mm (ISO 3274);	4) default evaluation length ($5 \times \lambda_c$) (ISO 4288);	8) evaluation length default ($5 \times 2,5 \text{ mm}$);			
1) $R_a = 1,5 \mu\text{m}$;	5) $R_z \text{ max} = 6,7 \mu\text{m}$;											
2) "16 %-rule", default (ISO 4288);	6) max- rule;											
3) default transmission band (ISO 4288 and ISO 3274);	7) transmission band – 2,5 mm (ISO 3274);											
4) default evaluation length ($5 \times \lambda_c$) (ISO 4288);	8) evaluation length default ($5 \times 2,5 \text{ mm}$);											
<p>C.4</p>	<p>Surface roughness:</p> <ul style="list-style-type: none"> — a single unilateral/upper specification limit; — $R_z = 1 \mu\text{m}$; — "16 %-rule", default (ISO 4288); — default transmission band (ISO 4288 and ISO 3274); — default evaluation length ($5 \times \lambda_c$) (ISO 4288); — surface lay, no requirement; — surface treatment: nickel/chromium coating; — the surface requirement is valid for all surfaces represented by the closed outline. 											
<p>C.5</p>	<p>Surface roughness:</p> <ul style="list-style-type: none"> — one unilateral upper and one bilateral specification: <table style="width: 100%; border: none;"> <tr> <td style="width: 50%;">1) unilateral $R_a = 3,1 \mu\text{m}$;</td> <td style="width: 50%;">1) bilateral R_z:</td> </tr> <tr> <td>2) "16 %-rule", default (ISO 4288);</td> <td>2) upper specification limit $R_z = 18 \mu\text{m}$;</td> </tr> <tr> <td>3) transmission band – 0,8 mm (λ_s according to ISO 3274);</td> <td>3) lower specification limit $R_z = 6,5 \mu\text{m}$;</td> </tr> <tr> <td>4) evaluation length $5 \times 0,8 = 4 \text{ mm}$ (ISO 4288);</td> <td>4) both: transmission band – 2,5 mm (λ_s according to ISO 3274);</td> </tr> <tr> <td></td> <td>5) both: evaluation length $5 \times 2,5 = 12,5 \text{ mm}$;</td> </tr> </table> <p>(the symbols U and L may be indicated even if there is no doubt)</p> — surface treatment: nickel/chromium coating. 	1) unilateral $R_a = 3,1 \mu\text{m}$;	1) bilateral R_z :	2) "16 %-rule", default (ISO 4288);	2) upper specification limit $R_z = 18 \mu\text{m}$;	3) transmission band – 0,8 mm (λ_s according to ISO 3274);	3) lower specification limit $R_z = 6,5 \mu\text{m}$;	4) evaluation length $5 \times 0,8 = 4 \text{ mm}$ (ISO 4288);	4) both: transmission band – 2,5 mm (λ_s according to ISO 3274);		5) both: evaluation length $5 \times 2,5 = 12,5 \text{ mm}$;	
1) unilateral $R_a = 3,1 \mu\text{m}$;	1) bilateral R_z :											
2) "16 %-rule", default (ISO 4288);	2) upper specification limit $R_z = 18 \mu\text{m}$;											
3) transmission band – 0,8 mm (λ_s according to ISO 3274);	3) lower specification limit $R_z = 6,5 \mu\text{m}$;											
4) evaluation length $5 \times 0,8 = 4 \text{ mm}$ (ISO 4288);	4) both: transmission band – 2,5 mm (λ_s according to ISO 3274);											
	5) both: evaluation length $5 \times 2,5 = 12,5 \text{ mm}$;											

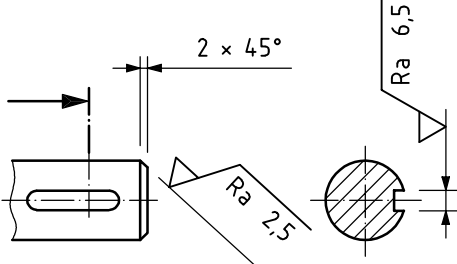
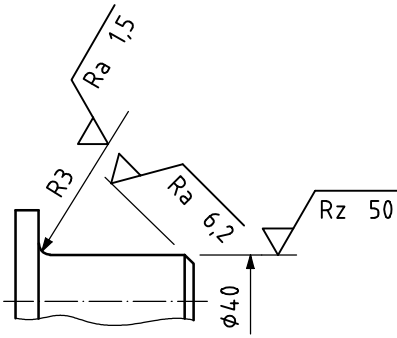
Reference No.	Requirement	Example
<p>C.6</p>	<p>Indication of surface texture and dimensioning may be combined using the same dimension line.</p> <p>Surface roughness on side surfaces of keyway:</p> <ul style="list-style-type: none"> — a single, unilateral upper specification limit; — $Ra = 6,5 \mu\text{m}$; — “16 %-rule”, default (ISO 4288); — default evaluation length ($5 \times \lambda_c$) (ISO 3274); — default transmission band (ISO 4288 and ISO 3274); — surface lay, no requirement; — manufacturing process shall remove material <p>Surface roughness on the chamfer:</p> <ul style="list-style-type: none"> — one single, unilateral/upper specification limit; — $Ra = 2,5 \mu\text{m}$; — “16 %-rule”, default (ISO 4288); — default evaluation length ($5 \times \lambda_c$) (ISO 3274); — default transmission band (ISO 4288 and ISO 3274); — surface lay, no requirement; — manufacturing process shall remove material. 	 <p>The diagram shows a cylindrical part with a keyway and a chamfered end. The keyway's side surfaces are specified with a surface roughness of $Ra = 6,5$. The chamfered surface is specified with a surface roughness of $Ra = 2,5$. A dimension line for the chamfer is labeled $2 \times 45^\circ$. The surface lay is indicated by arrows pointing in the direction of the manufacturing process.</p>
<p>C.7</p>	<p>Surface texture and dimensioning may be indicated</p> <ul style="list-style-type: none"> — together on an extended dimension line, or — separated on the respective projection line and dimension line <p>The three surface roughness requirements on the example are all:</p> <ul style="list-style-type: none"> — one single, unilateral/upper specification limit; — respectively: $Ra = 1,5 \mu\text{m}$, $Ra = 6,2 \mu\text{m}$, $Rz = 50 \mu\text{m}$; — “16 %-rule”, default (ISO 4288); — default evaluation length ($5 \times \lambda_c$) (ISO 3274); — default transmission band (ISO 4288 and ISO 3274); — surface lay, no requirement; — manufacturing process shall remove material. 	 <p>The diagram shows a cylindrical part with three different surface textures. The top surface has a surface roughness of $Ra = 1,5$. The side surface has a surface roughness of $Ra = 6,2$. The bottom surface has a surface roughness of $Rz = 50$. A dimension line for the diameter is labeled $\phi 14$. The surface lay is indicated by arrows pointing in the direction of the manufacturing process.</p>

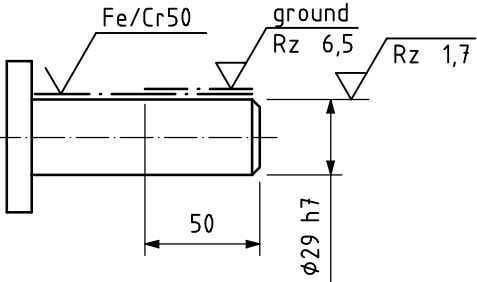
Reference No.	Requirement	Example
<p>C.8</p>	<p>Indication of surface texture, dimensioning and treatment. The example is illustrating three successive manufacturing processes or stages.</p> <p>Stage 1:</p> <ul style="list-style-type: none"> — one single, unilateral/upper specification limit; — $Rz = 1,7 \mu\text{m}$, — “16 %-rule”, default (ISO 4288); — default evaluation length ($5 \times \lambda_c$) (ISO 3274); — default transmission band (ISO 4288 and ISO 3274); — surface lay, no requirement; — manufacturing process shall remove material. <p>Stage 2:</p> <p>No surface texture requirement, except:</p> <ul style="list-style-type: none"> — chromium coating. <p>Stage 3:</p> <ul style="list-style-type: none"> — a single, unilateral/upper specification limit, only valid for the first 50 mm of the cylinder surface; — $Rz = 6,5 \mu\text{m}$, — “16 %-rule”, default (ISO 4288); — default evaluation length ($5 \times \lambda_c$) (ISO 3274); — default transmission band (ISO 4288 and ISO 3274); — surface lay, no requirement; — manufacturing process grinding. 	 <p>The diagram shows a cylindrical part with three distinct surface regions. From left to right: 1. A thin layer labeled 'Fe/Cr50' with a surface texture symbol indicating $Rz = 1,7$. 2. A section of length 50 mm labeled 'ground' with a surface texture symbol indicating $Rz = 6,5$. 3. A section with a surface texture symbol indicating $Rz = 1,7$. The diameter of the cylinder is $\phi 29$ with a tolerance of $h7$.</p>

Annex D (informative)

Minimum indications for unambiguous control of surface functions

A surface texture requirement is built from several different control elements, which can be part of the indication on the drawing or the textual indication given in other documents. The elements are as given in Figure D.1.

Experience has shown that all these elements are necessary to form an unambiguous relation between the surface texture requirement and the function of the surface. It is only in a very few cases that some of the elements can be omitted in an unambiguous requirement. The majority of the elements are also necessary for setting the measuring instrument (b, c, d, e, f). The rest are necessary for evaluating unambiguously the result of the measurement and for comparison with the limit or limits required.

In some cases it is necessary to indicate requirements for more than one surface texture parameter (profile or characteristic or both) in order to establish an unambiguous relation between the requirement on the drawing and the function of the surface.

Not all surface texture parameters have a strong and universal correlation with the function of a surface. Some parameters are highly specialized in relation to the type of surface or function of the surface or to both. Two main groups of surface texture parameters exist for use for two main types of surfaces, as follows.

— Single-process surfaces

These are surfaces that are the result of one manufacturing process (e.g. turning, grinding, milling, plating or painting). Parameters useful for these surfaces are defined in ISO 4287 and ISO 12085. In some cases the parameters in ISO 13565-2 may be useful for single-process surfaces. Parameters intended for single-process surfaces will usually not give meaningful results used on two-process surfaces.

— Two-process surfaces

These are surfaces that are the result of two manufacturing processes, and where part of the two surface textures are present in, and have influence on, the function of the resulting surface (e.g. ground surfaces partially lapped, super finished or honed). The parameters for these surfaces are defined in ISO 13565-2 and ISO 13565-3.

How strong the correlation between the surface texture parameter and the function of the surface is, and which parameters are appropriate for the control of a special function of a surface, are to be taken from the literature or from experience.

To simplify the indication of surface texture requirements and still maintain the relation between the indication on the drawing and the function of the surface as unambiguous, a number of default conditions are defined — for example, interpretation of the specification limit or limits, transmission band and evaluation length. The default definitions result in even simpler surface texture indications (e.g. Ra 1,6 and Rz 6,8) having a partly unambiguous meaning. This principle pertaining to default definitions is not yet finalized for all parameters.

The individual standards comprise information about default definitions, where present. In cases where no default definitions exist, the full information about, for example, interpretation of a specification limit or limits, transmission band and evaluation length, are to be given in the indication of the surface texture requirement on the drawing to make the requirement unambiguous — and meaningful.

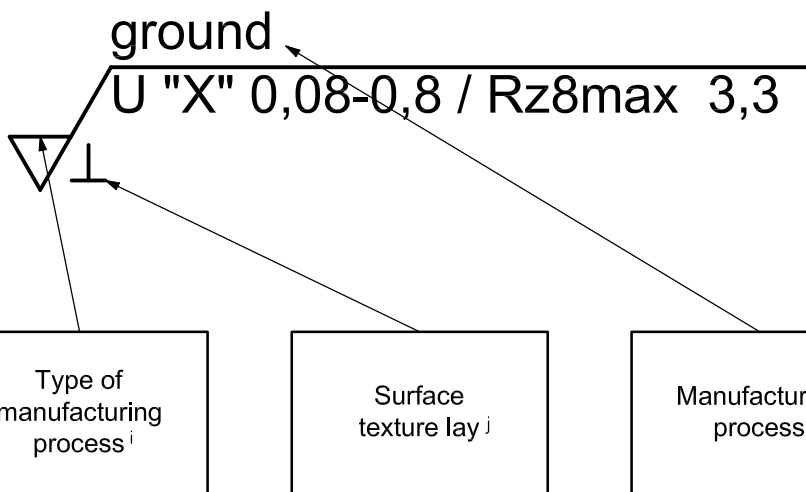
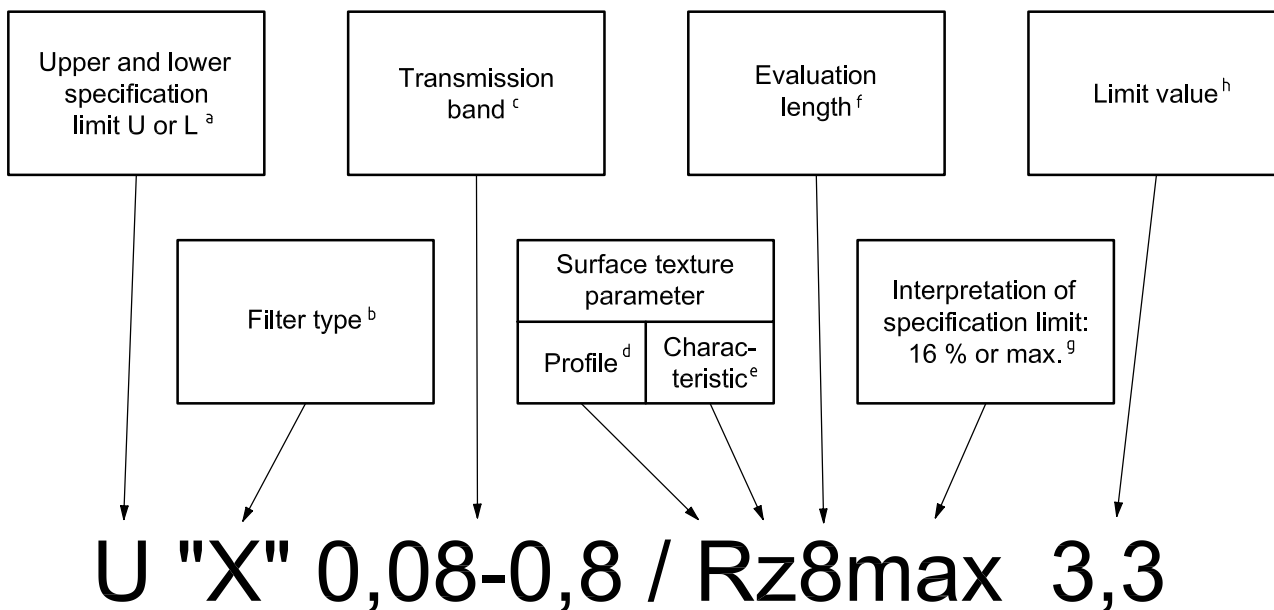

- a Indication of upper (U) or lower (L) specification limit — see 6.6 for details.
- b Filter type “X”. The standardized filter is the Gaussian filter (ISO 11562). The former standardized filter was the 2RC-filter. In the future, other filter types may be standardized. In the transition period it may be convenient for some companies to indicate the filter type on drawings. Filter type may be indicated as “Gaussian” or “2RC”. This is not standardized, but an indication of filter name as proposed here is unambiguous.
- c The transmission band is indicated as short-wave or long-wave filter — see 6.5 for details.
- d Profile (*R*, *W* or *P*) — see 6.2 for details.
- e Characteristic/parameter — see 6.2 for details.
- f Evaluation length as the number of sampling lengths — see 6.3 for details. When using motif parameters, the evaluation length is indicated between two oblique strokes in front of the surface texture parameter symbols (see also 6.3.3).
- g Interpretation of the specification limit (“16 %-rule” or “max-rule”) — see 6.4 for details.
- h Limit value in micrometres.
- i Type of manufacturing process — see 4.3 and 4.4 for details.
- j Surface texture lay — see clause 8 for details.
- k Manufacturing process — see clause 7 for details.

Figure D.1 — Control elements in indication of surface texture requirements on engineering drawings

When a default definition exists for a surface texture parameter, there are two possibilities for the indication, as follows.

- a) Use the total (existing) default definitions (as given in the standards), using only a simplified indication on the drawing.
- b) Indicate all the possible requirements and details in the requirement on the drawing, the detailed requirement being chosen on the basis of objective known relations between the surface texture requirement and the function of the surface.

On the one hand, a) has the advantage of reducing the annotations necessary and saves space on the drawing. On the other hand, it does not ensure that the choices made by the standardized default definitions are suitable for the specific task of controlling the function of the surface.

In general, possibility b) should always to be used for surfaces that are important for the function of a workpiece, i.e. where the surface texture is critical for the function.

Special attention shall be given to the choice of the default transmission band as specified in ISO 4288. The rules for choosing the default transmission band may have a major influence on the measured parameter value from a surface. Small (and nearly insignificant) changes in the surface may, because of the rules in ISO 4288, result in differences of up to 50 % in the measured parameter value. This fact points to the need for the transmission band (or at least the sampling length) to always be stated in the symbol on the drawing for surfaces where the surface texture are of importance for the function of the workpiece. In such cases the default filter should never be used.

The manufacturing process, and, in some cases, the surface lay, are of major importance for an unambiguous relation between the surface texture requirement on the drawing and the function of the surface. Two different manufacturing processes usually have "surface texture scales" of their own to relate to the same function of the surface. To obtain the same function of a surface, there is usually a difference of more than 100 % in the measured parameter values for the two surfaces when the surfaces are manufactured with two different processes.

One consequence of the above-mentioned facts is that the comparison of two or more surface texture parameter values only makes sense when the individual values have the same basis — for example, transmission band, evaluation length and manufacturing process.

Annex E (informative)

Surface texture parameter designations

E.1 General

Three principal groups of surface texture parameters have been standardized for use in connection with the complete symbol. The definitions of these parameters can be found in ISO 4287, ISO 12085, ISO 13565-2 and ISO 13565-3. Their parameter designations are presented in Tables E.1 to E.9.

E.2 Profile parameters according to ISO 4287

Tables E.1, E.2 and E.3 indicate the parameter designations of the surface parameters defined in ISO 4287. The profile parameters in ISO 4287 are defined for three surface profiles (*R*-, *W*- and *P*-profiles). Profile parameters are defined with Gaussian filtering according to ISO 11562.

Table E.1 — Designation of *R*-profile parameters according to ISO 4287

	Amplitude parameter									Spacing parameters	Hybrid parameters	Curves and related parameters		
	top-valley					mean value								
<i>R</i> -profile parameters (roughness parameters)	<i>R_p</i>	<i>R_v</i>	<i>R_z</i>	<i>R_c</i>	<i>R_t</i>	<i>R_a</i>	<i>R_q</i>	<i>R_{sk}</i>	<i>R_{ku}</i>	<i>R_{Sm}</i>	<i>R_{Δq}</i>	<i>R_{mr(c)}</i>	<i>R_{δc}</i>	<i>R_{mr}</i>

Table E.2 — Designation of *W*-profile parameters according to ISO 4287

	Amplitude parameter									Spacing parameters	Hybrid parameters	Curves and related parameters		
	top-valley					mean value								
<i>W</i> -profile parameters (waviness parameters)	<i>W_p</i>	<i>W_v</i>	<i>W_z</i>	<i>W_c</i>	<i>W_t</i>	<i>W_a</i>	<i>W_q</i>	<i>W_{sk}</i>	<i>W_{ku}</i>	<i>W_{Sm}</i>	<i>W_{Δq}</i>	<i>W_{mr(c)}</i>	<i>W_{δc}</i>	<i>W_{mr}</i>

Table E.3 — Designation of *P*-profile parameters according to ISO 4287

	Amplitude parameter									Spacing parameters	Hybrid parameters	Curves and related parameters		
	top-valley					mean value								
<i>P</i> -profile parameters (structure parameters)	<i>P_p</i>	<i>P_v</i>	<i>P_z</i>	<i>P_c</i>	<i>P_t</i>	<i>P_a</i>	<i>P_q</i>	<i>P_{sk}</i>	<i>P_{ku}</i>	<i>P_{Sm}</i>	<i>P_{Δq}</i>	<i>P_{mr(c)}</i>	<i>P_{δc}</i>	<i>P_{mr}</i>

E.3 Motif parameters according to ISO 12085

Tables E.4 and E.5 indicate the parameter designations of the surface parameters defined in ISO 12085. The parameters in ISO 12085 are only defined for the roughness and waviness profiles.

NOTE Attention is drawn to the fact that the *R*- and *W*-profiles in ISO 12085 are defined by means of a filtering method (motifs) other than the one used for other parameter systems defined in ISO 4287, ISO 13565-2 and ISO 13565-3.

Table E.4 — Designation of roughness profile motif parameters according to ISO 12085

	Parameters			
Roughness profile (roughness motif parameters)	<i>R</i>	<i>Rx</i>	<i>AR</i>	—

Table E.5 — Designation of waviness profile motif parameters according to ISO 12085

	Parameters			
Waviness profile (waviness motif parameters)	<i>W</i>	<i>Wx</i>	<i>AW</i>	<i>Wte</i>

E.4 Parameters based on material curve according to ISO 13565-2, ISO 13565-3 and ISO 12085

E.4.1 General

Two different parameter systems are associated with the material ratio curve:

- a) parameters based on the linear material ratio curve;
- b) parameters based on the probability material ratio curve.

E.4.2 Parameters based on linear material ratio curve

Tables E.6 and E.7 indicate the parameter designations related to the linear material ratio curve. These parameters are only defined for the *R*-profile, but by two different filtering processes, ISO 13565-1 and ISO 12085.

Table E.6 — Designation of *R*-profile parameters based on linear material ratio curve according to ISO 13565-1 and ISO 13565-2

	Parameters				
Roughness profile parameters according to ISO 13565-2 (filtering according to ISO 13565-1)	<i>Rk</i>	<i>Rpk</i>	<i>Rvk</i>	<i>Mr1</i>	<i>Mr2</i>

Table E.7 — Designation of *R*-profile parameters based on linear material ratio curve according to ISO 13565-2 and ISO 12085

	Parameters				
Roughness profile parameters according to ISO 13565-2 (filtering according to ISO 12085)	<i>Rke</i>	<i>Rpke</i>	<i>Rvke</i>	<i>Mr1e</i>	<i>Mr2e</i>
NOTE The “e” added to the parameter symbol indicates that filtering of profiles has taken place according to ISO 12085.					

E.4.3 Parameters based on material probability curve

Tables E.8 and E.9 indicate the parameter designations related to the material probability curve according to ISO 13565-3. These parameters are defined both for the *R*-profile and the *P*-profile.

Table E.8 — Designation of *R*-profile parameters based on the material probability curve according to ISO 13565-3

	Parameters		
Roughness profiles Filtering according to ISO 13565-1	R_{pq}	R_{vq}	R_{mq}

Table E.9 — Designation of *P*-profile parameters based on the material probability curve according to ISO 13565-3

	Parameters		
Structure profiles Filtering λ_s	P_{pq}	P_{vq}	P_{mq}

Annex F (informative)

Evaluation length, l_n

F.1 General

The surface texture requirement on the drawing applies to the evaluation length. Certain parameters are defined on the basis of the sampling length; others on the basis of the evaluation length (see ISO 4287, ISO 12085, 13565-2 and ISO 13565-3). When the parameter is defined on the basis of the sampling length, the number of sampling lengths constituting the evaluation length is of decisive importance. For sampling lengths, see annex G.

F.2 Profile parameters according to ISO 4287

The default evaluation lengths for the profile parameters defined in ISO 4287 are defined in ISO 4288.

- **R-profile:** the default evaluation lengths of the roughness parameters are defined in 4.4 and clause 7 of ISO 4288:1996. The default evaluation length, l_n , consists of five sampling lengths, l_r :

$$l_n = 5 \times l_r$$

This means that the parameter designations shown in Table E.1 implies an evaluation length equal to five sampling lengths.

- **W-profile:** waviness parameters; at present, no standardized default evaluation lengths exist for the waviness parameters⁷⁾.
- **P-profile:** structure parameters; the default evaluation length for structure parameters is defined in 4.4 of ISO 4288:1996 as the entire length of the feature.

F.3 Motif parameters according to ISO 12085

The default evaluation length of motif parameters given in 5.2 of ISO 12085:1996 is ($A = 0,5$ mm and $B = 2,5$ mm) 16 mm. The evaluation length is linked with the limit values of the transmission band (see G.3).

F.4 Parameters based on the material ratio curve according to ISO 13565-2 and ISO 13565-3

- **R-profile:** the default evaluation lengths for *R*-profile parameters related to the material ratio curve are defined in clause 7 of ISO 13565-1:1996 as being five sampling lengths:

$$l_n = 5 \times l_r$$

This means that the parameter designations in Tables E.6 and E.8 indicate the evaluation length as being equal to five sampling lengths.

- **P-profile:** the default evaluation length of *P*-profile parameters is defined in 4.4 of ISO 4288:1996 as the entire length of the feature.

7) At time of publication, default evaluation lengths for waviness parameters were under consideration by ISO/TC 213.

Annex G (informative)

Transmission band and sampling length

G.1 General

Generally, surface texture is defined in a transmission band — the wavelength range between two defined filters (see ISO 3274) and between two limits for the motif method (ISO 12085). This means that the transmission band is the wavelength range included in the evaluation. The transmission band is limited by one filter that cuts off short wavelengths (short-wave filter) and by another filter that cuts off long wavelengths of the surface (long-wave filter). The filters are characterized by the cut-off value. The filters and their transmission characteristics are defined in ISO 11562. For the motif method, the limits and the combination algorithm are defined in ISO 12085:1996 (see G.3).

NOTE The cut-off value of the long-wave filter is also designated as the sampling length.

G.2 Profile parameters according to ISO 4287

— *R*-profile

The cut-off value designation of the *R*-profile transmission band is λ_s (short-wave filter), and λ_c designates the sampling length (long-wave filter).

Default transmission bands of the roughness parameters are defined in combination by clause 7 of ISO 4288:1996 and 4.4 of ISO 3274:1996. ISO 4288 defines the default long-wave filter, λ_c , while ISO 3274 defines the default short-wave filter, λ_s , related to λ_c .

— *W*-profile

The cut-off value designation of the *W*-profile transmission band is λ_c (short-wave filter), and λ_f designates the sampling length (long-wave filter).

No default values of the transmission band of the *W*-profile are defined, nor is the ratio between λ_f and λ_c .

— *P*-profile

The cut-off value designation of the *P*-profile of the transmission band is λ_s (short-wave filter), while no designation of the long-wave filter has been standardized.

No default value of the cut-off value of the short-wave filter of the *P*-profile, λ_s , has been defined.

G.3 Motif parameters according to ISO 12085

For motif parameters, default values of the cut-off values of the short-wave filter, λ_s , have been defined as a function of the applicable evaluation length (see 5.2 of ISO 12085:1996).

— Roughness profile

The limit values of the transmission band for the roughness parameters assessment are

- λ_s for the short wavelength (see ISO 3274 and ISO 12085), and

— limit A for the long wavelength (see ISO 12085).

— **Waviness profile**

The limit values of the transmission band for the waviness parameters assessment are

— limit A for the short-wave length (see ISO 12085), and

— limit B for the long-wavelength (see ISO 12085).

G.4 Parameters based on material ratio curve according to ISO 13565-2 and ISO 13565-3

— ***R*-profile**

The cut-off value designations of the *R*-profile of the transmission band are λ_s (short-wave filter) and λ_c (long-wave filter) according to ISO 13565-1.

As ISO 13565-1 anticipates the use of only two different sampling lengths (long-wave filter) for the *R*-profile, the default transmission band defines the cut-off values $\lambda_c = 0,8$ mm (long-wave filter) and $\lambda_s = 0,0025$ mm (short-wave filter). Where no transmission band is indicated, this transmission band applies to *R*-parameters related to the material ratio curve.

The second standardized transmission band (special definition), given in ISO 13565-1 as 0,008 mm to 2,5 mm, is a standard transmission band specified in ISO 3274.

— ***P*-profile**

The cut-off value designation of the *P*-profile of the transmission band is λ_s (short-wave filter) according to ISO 13565-1. As the default case, *P*-parameters do not have any long-wave filter.

No default value of the cut-off value of the short-wave filter of the *P*-profile, λ_s , has been defined.

Annex H (informative)

Consequences of new ISO surface texture standards

This edition of ISO 1302 has been developed for use together with the new editions of the surface texture standards issued in 1996 and 1997.

The new editions of surface texture standards are ISO 3274, ISO 4287, ISO 4288, ISO 5436-1, ISO 11562, ISO 12085, ISO 12179, ISO 13565-1, ISO 13565-2 and ISO 13565-3 (clause 2). One additional new standard, not yet published, is listed in the Bibliography (ISO 5436-2).

A special International Standard for surface imperfections is ISO 8785.

A number of surface texture standards have been withdrawn: ISO 468, ISO 1878, ISO 1879, ISO 1880, ISO 2632-1, ISO 2632-2, ISO 2632-3 and ISO 4287-1 and ISO 4287-2.

The 1996 and 1997 editions of surface texture standards have resulted in many and major changes compared with the content of the former standards issued in the 1980s. The most important of these changes and their consequences are the following.

- The measuring instrument for surface texture has been redefined (ISO 3274); Skidded instruments are no longer standardized. The “true” value of a surface texture parameter is defined by an absolute measuring instrument.
- New filters are defined with a different filter characteristic (ISO 11562, digital phase correct Gaussian filter). The former analogue 2RC filter is no longer standardized.
- Two new surface texture profiles are defined [W - (waviness) and P -profile (structure)], additional to the already existing R -profile or roughness profile. Each of the three surface texture profiles can now form the basis of nearly all surface texture parameters (characteristics), e.g. R_a , W_a and P_a . See, in particular, annex E ISO 4287 and ISO 13565-3.
- Surface texture (all three profiles) is now defined by a transmission band (short-wave and long-wave filter) and not only by a single “cut-off filter” (long-wave filter) — see annex G and ISO 3274, ISO 4287 and ISO 11562.
- The typography of surface texture parameters has changed. The parameter symbol is now written on the line (e.g. R_a and R_z) Subscripts such as R_a and R_z are no longer used.
- Almost all surface texture designations and names of existing parameters have been changed (ISO 4287). The former surface roughness parameter R_z (t en point height) is no longer standardized by ISO. R_z has replaced the former symbol R_y .
- Three new groups/types of surface texture parameters are defined and standardized (ISO 12085, ISO 13565-2 and ISO 13565-3). These new surface texture parameters have, in part, their own filtering system (ISO 12085 and ISO 13565-1).
- The number of parameters having a default definition for interpretation of specification limit or limits, filtering and evaluation length, have been heavily increased over those three formerly existing (R_a , R_y and R_z). See ISO 4288, ISO 12085 and ISO 13565-1. Nearly all W - and P -parameters are without default definitions.

The changes from the former standards to the new editions of 1996 and 1997 are so numerous and of such magnitude that it is problematic to evaluate “old” surface requirements according to the new standards. Companies will need to make decisions on how to make the shift from the old to the new standards. If it is decided not to

update old drawings, they will still need to be interpreted according to the former editions of the surface texture standards and former editions of ISO 1302 applied to the old drawing.

One of the most important changes is the use of the Gaussian filter instead of the 2RC-filter. The Gaussian filter has been available on instruments for several years and is intended to have an effect very near to that of the former 2RC. However, this is not entirely possible. Cases exist where the Gaussian filter reduces the measured value by more than 37 % over the value from the same surface measured with 2RC-filtering. But in most cases the change of filters results in changes of measured values much smaller than that (differences of less than 5 % to 10 %).

In most cases as well the use of the transmission band (instead of a cut-off filter only) results in a small reduction of the measured value, especially for smooth surfaces. The advantage of the transmission band is that the uncertainty of measurement, the dependency of the tip radius and the difference between instruments of different make is heavily reduced.

Annex I (informative)

Former practice

I.1 Evolution of drawing indications of surface texture requirements

The evolution of drawing indications for surface texture requirements from former editions of ISO 1302 to this, the fourth, edition is illustrated in Table I.1.

It is important to recognize that at any given time, the detailed interpretation of the graphical symbols in ISO 1302 is covered by surface texture standards other than ISO 1302. The different editions of ISO 1302 refer to specific International Standards:

- ISO 1302:2001, 4th edition, refers to the surface texture standards issued in 1996 and 1997;
- ISO 1302:1992, 3rd edition, refers to the surface texture standards issued around 1980.
- ISO 1302:1978 and prior editions had ISO/R 468:1966 as the only other relevant standard of reference, and contained no details of importance to the interpretation of the symbols (see also footnotes ^c and ^d to Table I.1).

If the drawing rules in the different editions of ISO 1302 are used correctly, the detailed rules and the meaning of the requirements cannot be subject to misinterpretation.

A drawing indication using the 1978 designations cannot set up a requirement based on the surface texture standards issued around 1980 or in 1996 and 1997.

A drawing indication using the 1992 designation cannot set up a requirement based on the surface texture standards issued in 1996 and 1997.

I.2 Positions “x” and “a”

Indication of a surface texture requirement on the “x” position (see Figure I.1) and the related sampling length on the “a” position (as given in former editions of ISO 1302) are to be avoided on new drawings, and a surface texture requirement is always to include both the parameter designation and the related numerical value of the specification limit.

NOTE Previously, it was generally sufficient to indicate at position “x” either

- the numerical value of the specification limit alone, thus implying that this was a specification limit of the R_a parameter (according to the 1971, 1974 and 1978 editions of ISO 1302), or
- the parameter designation of any surface texture parameter together with the related numerical value of the specification limit (according to ISO 1302:1992).

Table I.1 — Evolution of drawing indications of surface texture requirements

	Editions of ISO 1302			Example illustrating main issue
	1971 (recommendation) ^a 1974 (1st edition) ^a 1978 (2nd edition) ^a	1992 (3rd edition) ^b	2001 (4th edition) ^c	
a)				Ra only — "16 %-rule"
b)				Parameter other than only Ra — "16 %-rule"
c)	— ^d			"Max-rule"
d)				Ra plus sampling length
e)	— ^d	— ^d		Transmission band
f)				Parameter other than only Ra plus sampling length
g)				Ra plus parameter other than Ra
h)	— ^d			Number of sampling lengths in the evaluation length — other than 5
j)	— ^d	— ^d		Lower limit
k)				Upper and lower limit

^a No defaults nor any other details defined, especially
 — no default evaluation length,
 — no default sampling length, and
 — no "16 %-rule" or "max-rule".

^b Defaults and details defined only for parameters R_a , R_y and R_z (ten-point height) in ISO 4287-1:1984 and ISO 4288:1985. Furthermore, there was a problem in ISO 1302:1992 where the text of the main body of the standard called for an indication of the second letter of the parameter symbol to be in subscript. In all illustrations the second letter is a normal lower case letter. All other surface texture standards at that time used subscript.

^c Defaults and details defined for the majority of parameters R_y has been renamed R_z . The old R_z is not standardized any more.

^d Not covered.

^e There was a problem in ISO 1302:1992 where clause D.3 included a misinterpretation of R_a 1,6 max. The parameter designation was not in accordance with the parameter designation definition in clause 4 of ISO 4288:1985, which called for $R_{a_{max}}$ 1,6.

^f See 5.9 of ISO 4287-1:1984.

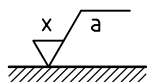

Figure I.1 — Positions “x” and “a”

I.3 Content of annex C of ISO 1302:1992

Table I.2 is a reproduction of Table C.1 from informative annex C of ISO 1302:1992 — itself taken from clause 4.1.5 of ISO 1302:1978 — and is given here for information“... in order to avoid misinterpretation of numerical values and roughness grade numbers on drawings which are not yet in accordance with this edition of ISO 1302 ...”.

**Table I.2 — Comparison of arithmetical mean deviation R_a and roughness grade numbers —
(Table C.1 of ISO 1302:1992)**

Roughness value R_a		Roughness grade numbers (given in the previous edition of ISO 1302)
μm	μin	
50	2 000	N 12
25	1 000	N 11
12,5	500	N 10
6,3	250	N 9
3,2	125	N 8
1,6	63	N 7
0,8	32	N 6
0,4	16	N 5
0,2	8	N 4
0,1	4	N 3
0,05	2	N 2
0,025	1	N 1

Annex J (informative)

Relation to the GPS matrix model

For full details about the GPS matrix model see ISO/TR 14638.

J.1 Information about this International Standard and its use

This International Standard gives the tools to control the surface texture of a surface by an unambiguous specification on technical drawings and in a written text.

It gives an overview of, and reference to, the default and special rules for the indication of surface texture given in other standards in the surface texture chains of standards. This overview makes it possible for the designer to indicate unambiguously the intended surface texture with the least possible effort, also making it possible for the reader of a given surface texture specification to understand, implement or verify the requirement without mistakes.

This International Standard also contains guidance with special address to designers on how to use the improved possibilities in other new GPS surface texture standards, issued since the previous edition in 1992.

Furthermore, it gives an exhaustive list of the changes in ISO surface texture standardization and mentions the consequences of these changes for the meaning of a surface texture specification. The information about the changes in surface texture standardization is extremely important because all other surface texture standards are new and issued since the previous edition of ISO 1302. The set of new standards comprises major changes and introduces completely new concepts, the result of which, in several cases, changes the meaning of a surface texture specification.

J.2 Position in the GPS matrix model

This International standard is a general GPS standard, which influences chain link 1 of the chain of standards on roughness profile, waviness profile and primary profile in the general GPS matrix, as illustrated in Figure J.1.

Fundamental GPS standards	Global GPS standards						
	General GPS standards						
	Chain link number	1	2	3	4	5	6
	Size						
	Distance						
	Radius						
	Angle						
	Form of line independent of datum						
	Form of line dependent of datum						
	Form of surface independent of datum						
	Form of surface dependent of datum						
	Orientation						
	Location						
	Circular run-out						
	Total run-out						
	Datums						
	Roughness profile						
	Waviness profile						
	Primary profile						
	Surface imperfections						
Edges							

Figure J.1

J.3 Related standards

The related International Standards are those of the chains of standards indicated in Figure J.1.

Bibliography

- [1] ISO 1456:—⁸⁾, *Metallic coatings — Electrodeposited coatings of nickel plus chromium and of copper plus nickel plus chromium*
- [2] ISO 5436-1:2000, *Geometrical Product Specifications (GPS) — Surface texture: Profile method; Measurement standards — Part 1: Material measures*
- [3] ISO 5436-2:2001, *Geometrical Product Specifications (GPS) — Surface texture: Profile method; Measurement standards — Part 2: Software measurement standards*
- [4] ISO 12179:2000, *Geometrical Product Specifications (GPS) — Surface texture: Profile method — Calibration of contact (stylus) instruments*
- [5] ISO/TR 14638:1995, *Geometrical Product Specifications (GPS) — Masterplan*

8) To be published. (Revision of ISO 1456:1988)

ICS 01.100.20; 17.040.20

Price based on 46 pages