

---

---

**Plastics — Determination of creep  
behaviour —**

**Part 2:  
Flexural creep by three-point loading**

*Plastiques — Détermination du comportement au fluage —*

*Partie 2: Fluage en flexion par mise en charge en trois points*



**PDF disclaimer**

This PDF file may contain embedded typefaces. In accordance with Adobe's licensing policy, this file may be printed or viewed but shall not be edited unless the typefaces which are embedded are licensed to and installed on the computer performing the editing. In downloading this file, parties accept therein the responsibility of not infringing Adobe's licensing policy. The ISO Central Secretariat accepts no liability in this area.

Adobe is a trademark of Adobe Systems Incorporated.

Details of the software products used to create this PDF file can be found in the General Info relative to the file; the PDF-creation parameters were optimized for printing. Every care has been taken to ensure that the file is suitable for use by ISO member bodies. In the unlikely event that a problem relating to it is found, please inform the Central Secretariat at the address given below.

© ISO 2003

All rights reserved. Unless otherwise specified, no part of this publication may be reproduced or utilized in any form or by any means, electronic or mechanical, including photocopying and microfilm, without permission in writing from either ISO at the address below or ISO's member body in the country of the requester.

ISO copyright office  
Case postale 56 • CH-1211 Geneva 20  
Tel. + 41 22 749 01 11  
Fax + 41 22 749 09 47  
E-mail [copyright@iso.org](mailto:copyright@iso.org)  
Web [www.iso.org](http://www.iso.org)

Published in Switzerland

# Contents

Page

<b>Foreword</b> .....	<b>iv</b>
<b>1 Scope</b> .....	<b>1</b>
<b>2 Normative references</b> .....	<b>1</b>
<b>3 Terms and definitions</b> .....	<b>2</b>
<b>4 Apparatus</b> .....	<b>3</b>
<b>5 Test specimens</b> .....	<b>4</b>
<b>6 Procedure</b> .....	<b>4</b>
<b>7 Expression of results</b> .....	<b>6</b>
<b>8 Test report</b> .....	<b>9</b>
<b>Annex A (informative) Physical-ageing effects on the creep of polymers</b> .....	<b>10</b>
<b>Bibliography</b> .....	<b>14</b>

## **Foreword**

ISO (the International Organization for Standardization) is a worldwide federation of national standards bodies (ISO member bodies). The work of preparing International Standards is normally carried out through ISO technical committees. Each member body interested in a subject for which a technical committee has been established has the right to be represented on that committee. International organizations, governmental and non-governmental, in liaison with ISO, also take part in the work. ISO collaborates closely with the International Electrotechnical Commission (IEC) on all matters of electrotechnical standardization.

International Standards are drafted in accordance with the rules given in the ISO/IEC Directives, Part 2.

The main task of technical committees is to prepare International Standards. Draft International Standards adopted by the technical committees are circulated to the member bodies for voting. Publication as an International Standard requires approval by at least 75 % of the member bodies casting a vote.

Attention is drawn to the possibility that some of the elements of this document may be the subject of patent rights. ISO shall not be held responsible for identifying any or all such patent rights.

ISO 899-2 was prepared by Technical Committee ISO/TC 61, *Plastics*, Subcommittee SC 2, *Mechanical properties*.

This second edition cancels and replaces the first edition (ISO 899-2:1993), which has been technically revised.

ISO 899 consists of the following parts, under the general title *Plastics — Determination of creep behaviour*:

- *Part 1: Tensile creep*
- *Part 2: Flexural creep by three-point loading*

# Plastics — Determination of creep behaviour —

## Part 2: Flexural creep by three-point loading

### 1 Scope

**1.1** This part of ISO 899 specifies a method for determining the flexural creep of plastics in the form of standard test specimens under specified conditions such as those of pretreatment, temperature and humidity. It applies only to a simple freely supported beam loaded at mid-span (three-point-loading test).

**1.2** The method is suitable for use with rigid and semi-rigid non-reinforced, filled and fibre-reinforced plastics materials (see ISO 472 for definitions) in the form of dumb-bell-shaped test specimens moulded directly or machined from sheets or moulded articles.

NOTE The method may be unsuitable for certain fibre-reinforced materials due to differences in fibre orientation.

**1.3** The method is intended to provide data for engineering-design and research and development purposes. Data for engineering-design purposes requires the use of extensometers to measure the gauge length of the specimen. Data for research or quality-control purposes may use the change in distance between the grips (nominal extension).

**1.4** Flexural creep may vary significantly with differences in specimen preparation and dimensions and in the test environment. The thermal history of the test specimen can also have profound effects on its creep behaviour (see Annex A). Consequently, when precise comparative results are required, these factors must be carefully controlled.

**1.5** If flexural-creep properties are to be used for engineering-design purposes, the plastics materials should be tested over a broad range of stresses, times and environmental conditions.

**1.6** The method may not be suitable for determining the flexural creep of rigid cellular plastics (attention is drawn in this respect to ISO 1209-1, *Cellular plastics, rigid — Flexural tests — Part 1: Bending test*, and ISO 1209-2, *Cellular plastics, rigid — Flexural tests — Part 2: Determination of flexural properties*).

### 2 Normative references

The following referenced documents are indispensable for the application of this document. For dated references, only the edition cited applies. For undated references, the latest edition of the referenced document (including any amendments) applies.

ISO 62:1999, *Plastics — Determination of water absorption*

ISO 178:2001, *Plastics — Determination of flexural properties*

ISO 291:1997, *Plastics — Standard atmospheres for conditioning and testing*

ISO 472:1999, *Plastics — Vocabulary*

### 3 Terms and definitions

For the purposes of this document, the terms and definitions given in ISO 472 and the following apply.

#### 3.1

##### **creep**

increase in strain with time when a constant force is applied

#### 3.2

##### **flexural stress**

$\sigma$

surface stress in the mid-span section of the test specimen

NOTE It is calculated from the relationship given in 7.1.2.

#### 3.3

##### **deflection**

$s_t$

distance over which the top or bottom surface of the test specimen at mid-span deviates from its original position during flexure

NOTE It is expressed in millimetres.

#### 3.4

##### **flexural-creep strain**

$\varepsilon_t$

strain at the surface of the test specimen produced by a stress at any given time  $t$  during a creep test, calculated in accordance with 7.1.3

NOTE It is expressed as a dimensionless ratio or as a percentage.

#### 3.5

##### **flexural-creep modulus**

$E_t$

ratio of flexural stress to flexural-creep strain, calculated as in 7.1.1

#### 3.6

##### **isochronous stress-strain curve**

Cartesian plot of stress versus creep strain, at a specific time after application of the test load

#### 3.7

##### **time to rupture**

period of time the specimen is under full load until rupture

#### 3.8

##### **creep-strength limit**

initial stress which will just cause rupture ( $\sigma_{B,t}$ ) or will produce a specified strain ( $\sigma_{\varepsilon,t}$ ) at a specified time  $t$ , at a given temperature and relative humidity

#### 3.9

##### **initial distance between specimen supports**

##### **span**

$L$

initial distance between lines of contact between test specimen and supports (see Figure 1)

## 4 Apparatus

**4.1 Test rack**, comprising a rigid frame with two supports, one for each end of the test specimen, the distance between the supports being adjustable to  $(16 \pm 1)$  times the thickness (height) of the specimen (see Figure 1) for normal specimens, or to greater than 17 times the thickness (height) of the specimen or a fixed distance (100 mm) for rigid unidirectional-fibre-reinforced test specimens (see 6.2). The test rack shall be levelled, and sufficient space shall be allowed below the specimen for the specimen to flex under constant loading at mid-span.

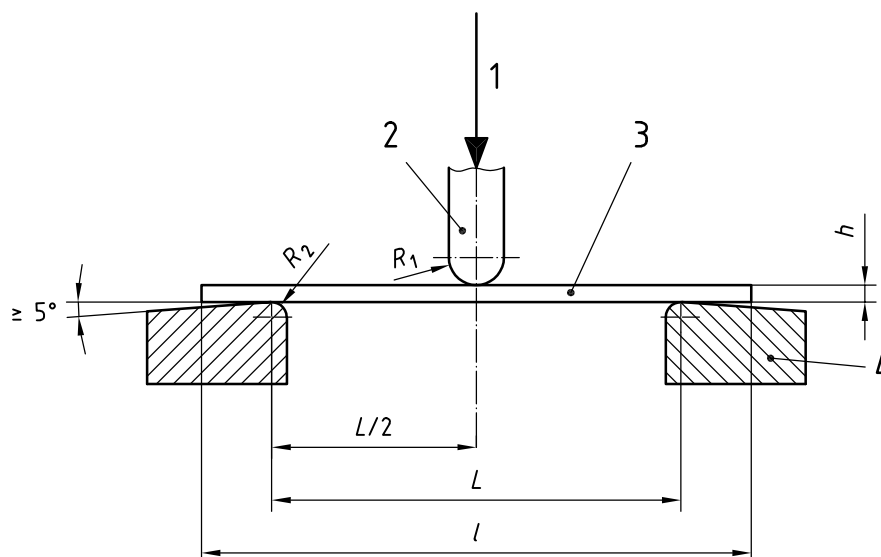

### Key

- 1 applied force,  $F$
- 2 loading edge
- 3 test specimen
- 4 support

**Figure 1 — Characteristics of flexural-creep apparatus**

The radius  $R_1$  of the loading edge and the radius  $R_2$  of the supports shall conform to the values given in Table 1.

**Table 1**

Values in millimetres

Thickness of test specimen	Radius of loading edge $R_1$	Radius of supports $R_2$
$\leq 3$	$5 \pm 0,1$	$2 \pm 0,2$
$> 3$	$5 \pm 0,1$	$5 \pm 0,2$

**4.2 Loading system**, capable of ensuring that the load is applied smoothly, without causing transient overloading, and that the load is maintained to within  $\pm 1\%$  of the desired load. In creep-to-rupture tests, provision shall be made to prevent any shocks which occur at the moment of rupture being transmitted to adjacent loading systems. The loading mechanism shall allow rapid, smooth and reproducible loading.

**4.3 Deflection-measuring device**, comprising any contactless or contact device capable of measuring the extension of the specimen under load without influencing the specimen behaviour by mechanical effects (e.g. undesirable deformations, notches), other physical effects (e.g. heating of the specimen) or chemical effects. The accuracy of the deflection-measuring device shall be within  $\pm 0,01$  % of the final deflection.

**4.4 Time-measurement device**, accurate to 0,1 %.

**4.5 Micrometer**, reading to 0,01 mm or closer, for measuring the initial thickness and width of the test specimen.

**4.6 Vernier callipers**, accurate to 0,1 % of the span between the test supports or better, for determining the span.

## 5 Test specimens

Use test specimens of the same shape and dimensions as specified for the determination of flexural properties (see ISO 178).

## 6 Procedure

### 6.1 Conditioning and test atmosphere

Condition the test specimens as specified in the International Standard for the material under test. In the absence of any information on conditioning, use the most appropriate set of conditions specified in ISO 291, unless otherwise agreed by the interested parties.

The creep behaviour will be affected not only by the thermal history of the specimen under test, but also by the temperature and (where applicable) humidity used in conditioning. It is recommended that a conditioning-time  $\geq t_{90}$  (see ISO 62) be used.

Conduct the test in the same atmosphere as used for conditioning, unless otherwise agreed upon by the interested parties, e.g. for testing at elevated or low temperatures. Ensure that the variation in temperature during the duration of the test remains within  $\pm 2$  °C.

### 6.2 Measurement of test-specimen dimensions and distance between supports

Measure the dimensions of the conditioned test specimens in accordance with ISO 178:2001, Subclause 8.2.

For normal test specimens, adjust the initial distance  $L$  between the test specimen supports to

$$(16 \pm 1) \cdot h$$

where  $h$  is the thickness of the specimen.

In the case of rigid unidirectional-fibre-reinforced test specimens, the distance between the supports may be adjusted to a value  $> 17h$  or to a fixed distance of 100 mm if necessary to avoid delamination by shearing or delamination in the compression zone.

Measure the distance between the supports to within  $\pm 0,5$  %.

### 6.3 Mounting the test specimens

Mount a conditioned and measured specimen symmetrically with its long axis at right angles to the supports and set up the deflection-measuring device as required.



## 6.4 Selection of stress value

Select a stress value appropriate to the application envisaged for the material under test, and calculate, using the equation given in 7.1.2, the load to be applied to the test specimen.

Choose the stress such that the deflection is not greater than 0,1 times the distance between the supports at any time during the test.

## 6.5 Loading procedure

### 6.5.1 Preloading

When it is necessary to preload the test specimen prior to increasing the load to the test load, take care to ensure that the preload does not influence the test results. Do not apply the preload until the temperature and humidity of the test specimen (positioned in the test apparatus) correspond to the test conditions.

Set the deflection-measuring device to zero immediately after application of the preload; the preload shall act during the whole duration of the test.

### 6.5.2 Loading

Load the test specimen progressively so that full loading of the specimen is reached between 1 s and 5 s after the beginning of the application of the load. Use the same rate of loading for each of a series of tests on one material.

Take the total load (including the preload) to be the test load.

## 6.6 Deflection-measurement schedule

Record the point in time at which the specimen is fully loaded as  $t = 0$ . Unless the deflection is automatically and/or continuously recorded, choose the times for making individual measurements as a function of the creep curve obtained from the particular material under test. It is preferable to use the following measurement schedule:

1 min, 3 min, 6 min, 12 min and 30 min;

1 h, 2 h, 5 h, 10 h, 20 h, 50 h, 100 h, 200 h, 500 h, 1 000 h, etc.

If discontinuities are suspected or observed in the creep-strain versus time plot, take readings more frequently.

## 6.7 Time measurement

Measure, to within  $\pm 0,1\%$  or  $\pm 2$  s (whichever is the less severe tolerance), the total time which has elapsed up to each creep measurement.

## 6.8 Temperature and humidity control

Unless temperature and relative humidity (where applicable) are recorded automatically, record them at the beginning of the test and then at least three times a day initially. When it has become evident that the conditions are stable within the specified limits, they may be checked less frequently (but at least once a day).

## 6.9 Measurement of recovery rate (optional)

Upon completion of non-rupture tests, remove the load rapidly and smoothly and measure the recovery rate using, for instance, the same schedule as was used for creep measurement.

## 7 Expression of results

### 7.1 Method of calculation

#### 7.1.1 Flexural-creep modulus

Calculate the flexural-creep modulus,  $E_t$ , expressed in megapascals, at each of the selected measurement times using the following equation:

$$E_t = \frac{L^3 \cdot F}{4b \cdot h^3 \cdot s_t}$$

where

- $L$  is the initial distance, in millimetres, between the test specimen supports;
- $F$  is the applied force, in newtons;
- $b$  is the width, in millimetres, of the test specimen;
- $h$  is the thickness (height), in millimetres, of the test specimen;
- $s_t$  is the deflection, in millimetres, at mid-span at time  $t$ .

#### 7.1.2 Flexural stress

Calculate the flexural stress,  $\sigma$ , expressed in megapascals, using the following equation:

$$\sigma = \frac{3F \cdot L}{2b \cdot h^2}$$

where

- $F$  is the applied force, in newtons;
- $L$  is the distance, in millimetres, between the test specimen supports;
- $b$  is the width, in millimetres, of the test specimen;
- $h$  is the thickness (height), in millimetres, of the test specimen.

#### 7.1.3 Flexural-creep strain

Calculate the flexural-creep strain,  $\varepsilon_t$ , using the following equation:

$$\varepsilon_t = \frac{6s_t \cdot h}{L^2}$$

where

- $s_t$  is the deflection, in millimetres, at mid-span at time  $t$ .
- $h$  is the thickness (height), in millimetres, of the test specimen;
- $L$  is the distance, in millimetres, between the test specimen supports.

## 7.2 Presentation of results

### 7.2.1 Creep curves

If testing is carried out at different temperatures, the raw data should preferably be presented, for each temperature, as a series of creep curves showing the flexural strain plotted against the logarithm of time, one curve being plotted for each initial stress used (see Figure 2).

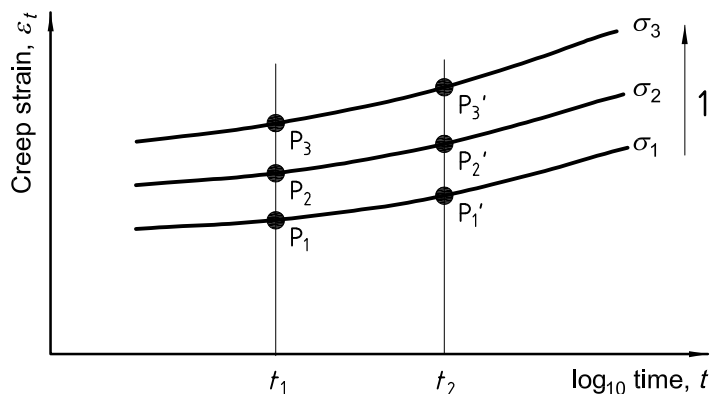

#### Key

1 increasing stress

Figure 2 — Creep curves

The data may also be presented in other ways, e.g. as described in 7.2.2 and 7.2.3, to provide information required for particular applications.

### 7.2.2 Creep-modulus/time curves

For each initial stress used, the flexural-creep modulus, calculated in accordance with 7.1.1, may be plotted against the logarithm of the time under load (see Figure 3).

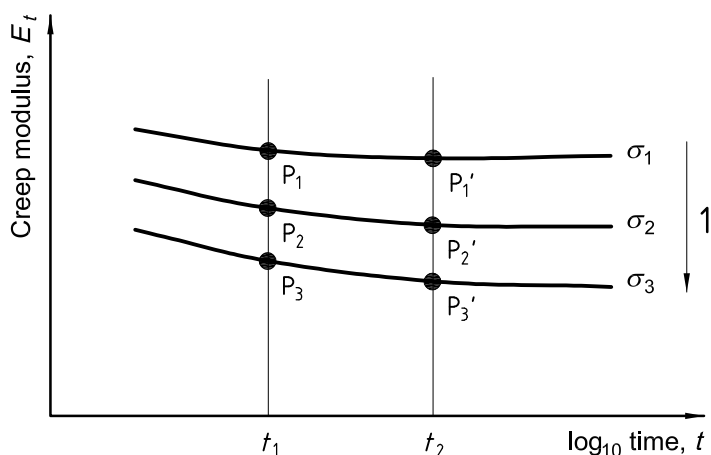

#### Key

1 increasing stress

Figure 3 — Creep-modulus/time curves

If testing is carried out at different temperatures, plot a series of curves for each temperature.

**7.2.3 Isochronous stress-strain curves**

An isochronous stress-strain curve is a Cartesian plot showing how the strain depends on the applied load, at a specific point in time after application of the load. Several curves are normally plotted, corresponding to times under load of 1 h, 10 h, 100 h, 1 000 h and 10 000 h. Since each creep test gives only one point on each curve, it is necessary to carry out the test at, at least, three different stresses, and preferably more, to obtain an isochronous curve.

To obtain an isochronous stress-strain curve for a particular time under load (say 10 h) from a series of creep curves as shown in Figure 2, read off, from each creep curve, the strain at 10 h, and plot these strain values (x-axis) against the corresponding stress values (y-axis). Repeat the process for other times to obtain a series of isochronous curves (see Figure 4).

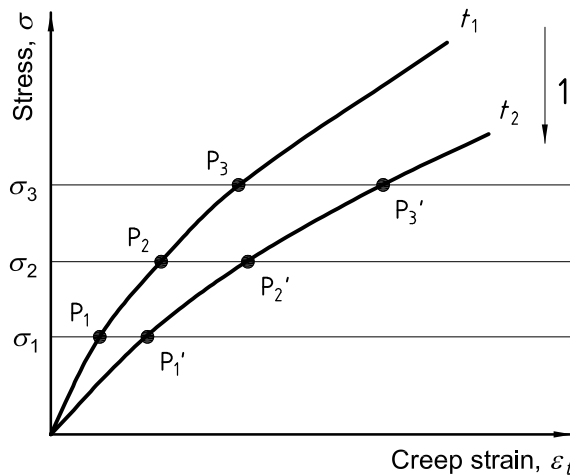

**Key**

1 increasing time

**Figure 4 — Isochronous stress-strain curves**

If testing is carried out at different temperatures, plot a series of curves for each temperature.

**7.2.4 Three-dimensional representation**

A relationship of the form  $\epsilon = f(t, \sigma)$  exists between the different types of curve (see Figures 2 to 4) that can be derived from the raw creep-test data. This relationship can be represented as a surface in a three-dimensional space (see Reference [1] in the Bibliography).

All the curves that can be derived from the raw creep-test data form part of this surface. Because of the experimental error inherent in each measurement, the points corresponding to the actual measurements normally do not lie on the curves but just off them.

The surface  $\epsilon = f(t, \sigma)$  can therefore be generated by deriving a number of the curves which form it, but a number of sophisticated smoothing operations are usually necessary. Computer techniques permit this to be done rapidly and reliably.

**7.2.5 Creep-to-rupture curves**

Creep-to-rupture curves allow the prediction of the time to failure at any stress. They may be plotted as stress against log time to break (see Figure 4) or log stress against log time to break.

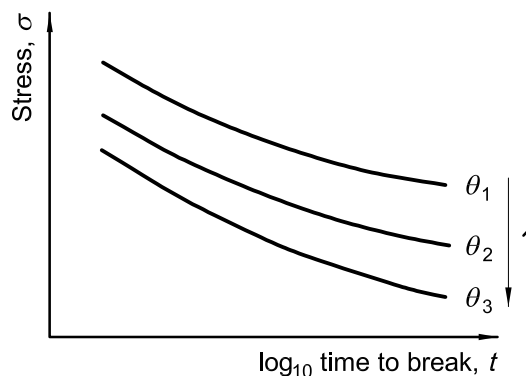

### Key

1 increasing temperature

NOTE The stress,  $\sigma$ , may also be plotted on a logarithmic scale.

**Figure 5 — Creep-to-rupture curves**

### 7.3 Precision

The precision of this test method is not known because interlaboratory data are not available. When interlaboratory data are obtained, a precision statement will be added at the following revision.

## 8 Test report

The test report shall include the following particulars:

- a) a reference to this part of ISO 899;
- b) a complete description of the material tested, including all pertinent information on composition, preparation, manufacturer, tradename, code number, date of manufacture, type of moulding and any annealing;
- c) the dimensions of each test specimen and the span-to-thickness ratio,  $L/h$ , or distance between supports, if other than 16 (see 6.2);
- d) the method of preparation of the test specimens;
- e) the directions of the principal axes of the test specimens with respect to the dimensions of the product or some known or inferred orientation in the material;
- f) details of the atmosphere used for conditioning and testing;
- g) the creep-test data for each temperature at which testing was carried out, presented in one or more of the graphical forms described in 7.2, or in tabular form.

## Annex A (informative)

### Physical-ageing effects on the creep of polymers

#### A.1 General

Physical ageing takes place when a polymer is cooled from an elevated temperature at which the molecular mobility is high to a lower temperature at which relaxation times for molecular motions are long in comparison with the storage time at that temperature. Under these circumstances, changes in the structure will take place over a long period of time, involving rearrangement in the shape and packing of molecules as the polymer approaches the equilibrium structural state for the lower temperature. Associated with this ageing process, there is a progressive decrease in the molecular mobility of the polymer, even when the temperature remains constant. As a direct consequence of this, the creep deformation produced by an applied stress will depend upon the age of the polymer, creep rates being lower in more highly aged material.

This is illustrated in Figure A.1 which shows creep compliance curves for PVC specimens of different ages. Each of these specimens has been rapidly cooled from a temperature of 85 °C (close to  $T_g$ ) and stored at the test temperature of 23 °C for different times  $t_e$  prior to load application. The physical age of a specimen is then defined by the time  $t_e$  and it can be seen that the older the specimen the further its creep curve is shifted on the time axis.

#### A.2 Creep at elevated temperatures

The influence of physical ageing on creep behaviour is more complicated when measurements are made at elevated temperatures following a storage period at a lower (ambient) temperature. Under these circumstances, the physical ageing that takes place during storage at the lower temperature is temporarily reversed when the specimen is heated to the test temperature. The rate at which this takes place depends on the size of the temperature change and the age of the specimen when the temperature is raised. Following the reduction in the apparent (or effective) age of the specimen, physical ageing is reactivated at the higher temperature. Again, the timescale over which this happens depends on the test conditions. One consequence of these changes in age state caused by the temperature increase is thus a dependence of the creep behaviour at the elevated temperature on the dwell time at this temperature prior to load application.

Typical ways in which this type of thermal history influences creep compliance are illustrated in Figures A.2 and A.3. In Figure A.2, specimens were stored for a period  $t_{e1}$  of 200 h at a temperature of 23 °C prior to heating to the test temperature of 44 °C. Creep curves were then obtained after different periods  $t_{e2}$  at 44 °C prior to load application. Despite the relatively long storage period  $t_{e1}$  at ambient temperature, the creep behaviour shows a strong dependence on the dwell time  $t_{e2}$ .

In Figure A.3, creep tests were carried out under the same conditions but following a storage period  $t_{e1}$  of greater than 1 year at 23 °C prior to heating to the test temperature. The progressive reduction in the effective age of the specimens is actually observed here as a shift in the curves to shorter creep times, and results from the more extensive structural changes that have taken place in the specimens through physical ageing before heating.

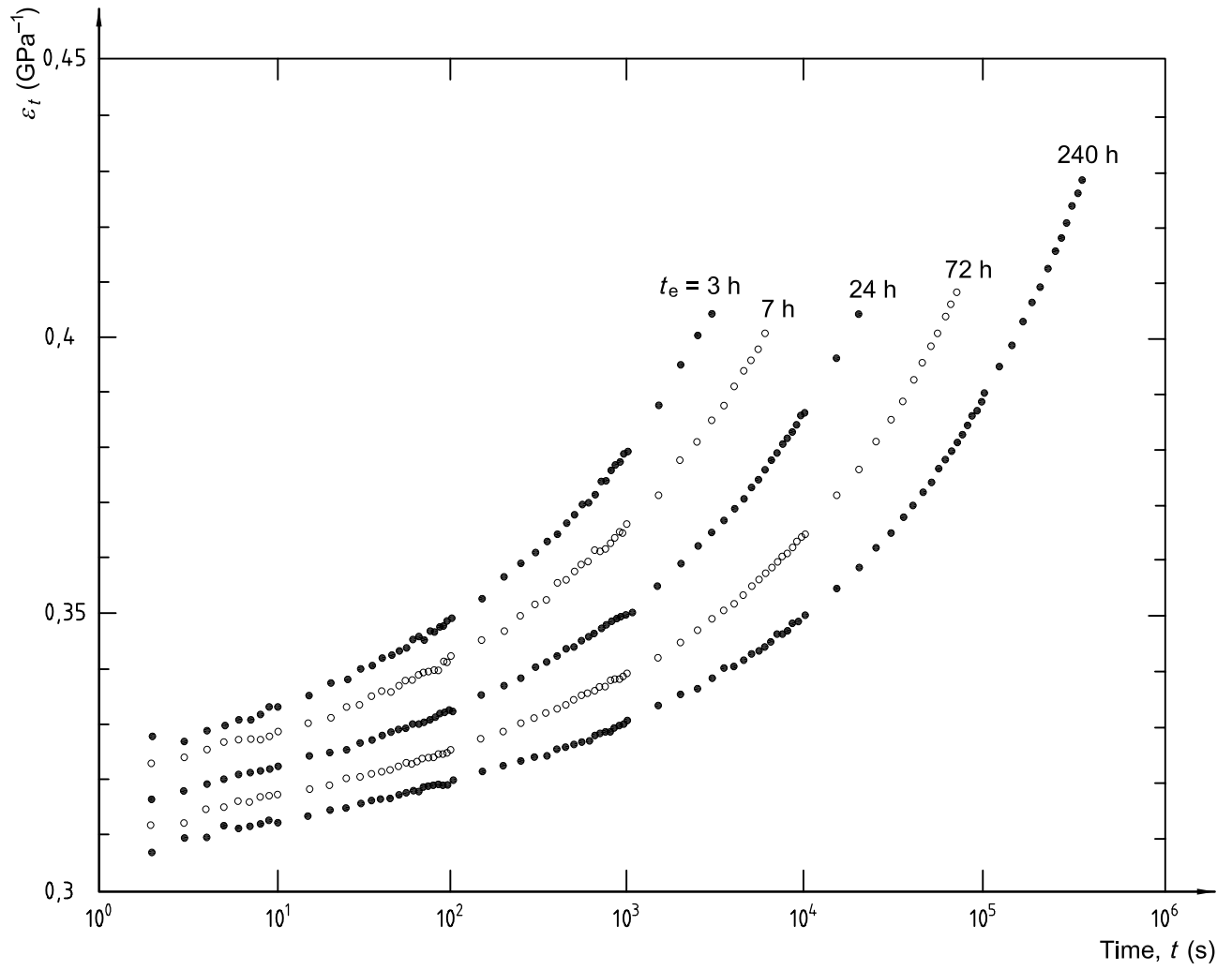

Figure A.1 — Creep curves for PVC at 23 °C obtained at different times  $t_e$  after rapid cooling of the specimen from 85 °C to 23 °C

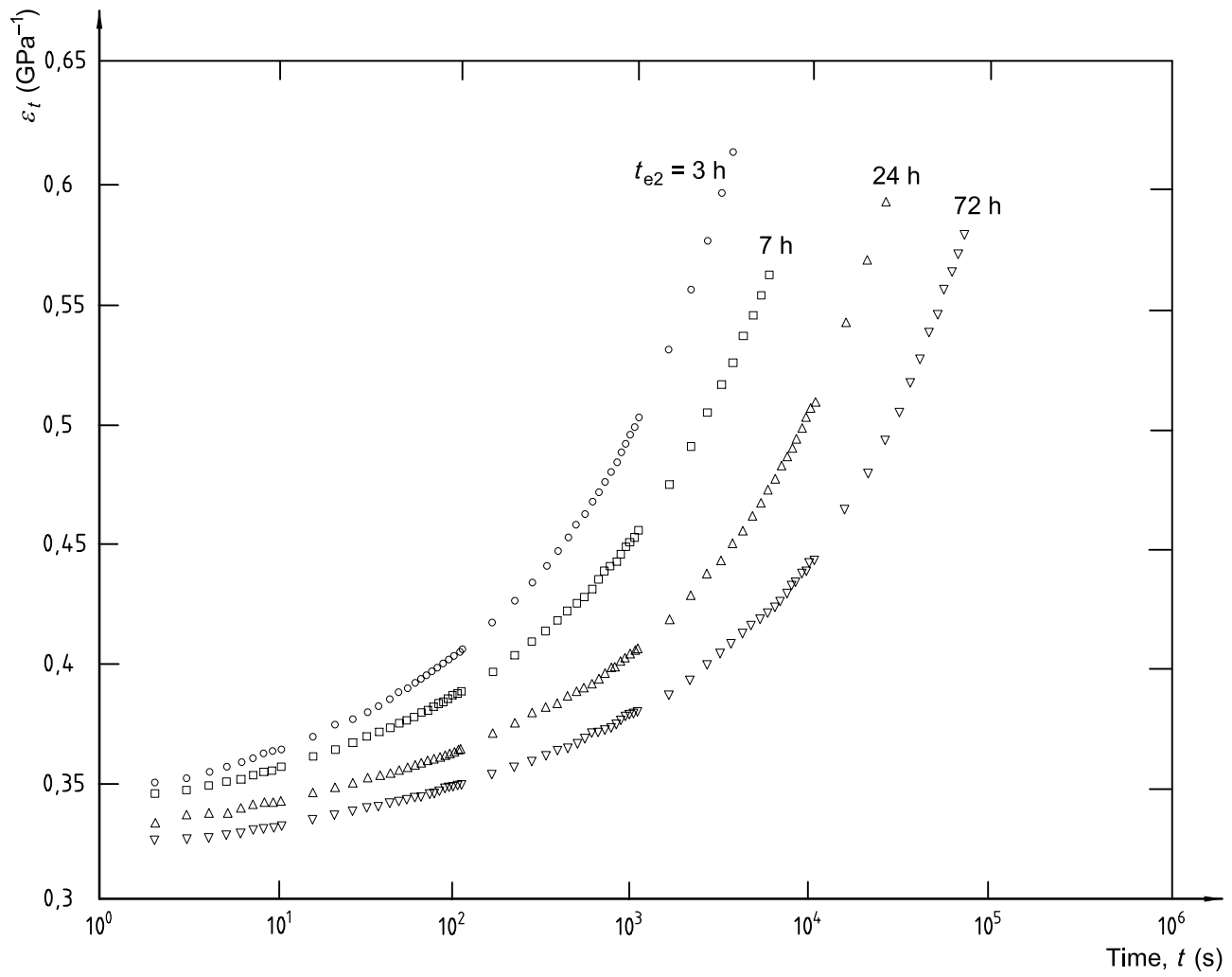

Figure A.2 — Creep curves for PVC at 44 °C obtained by application of the load at different times  $t_{e2}$  after heating from 23 °C (the specimen had been stored for 200 h at 23 °C prior to heating)



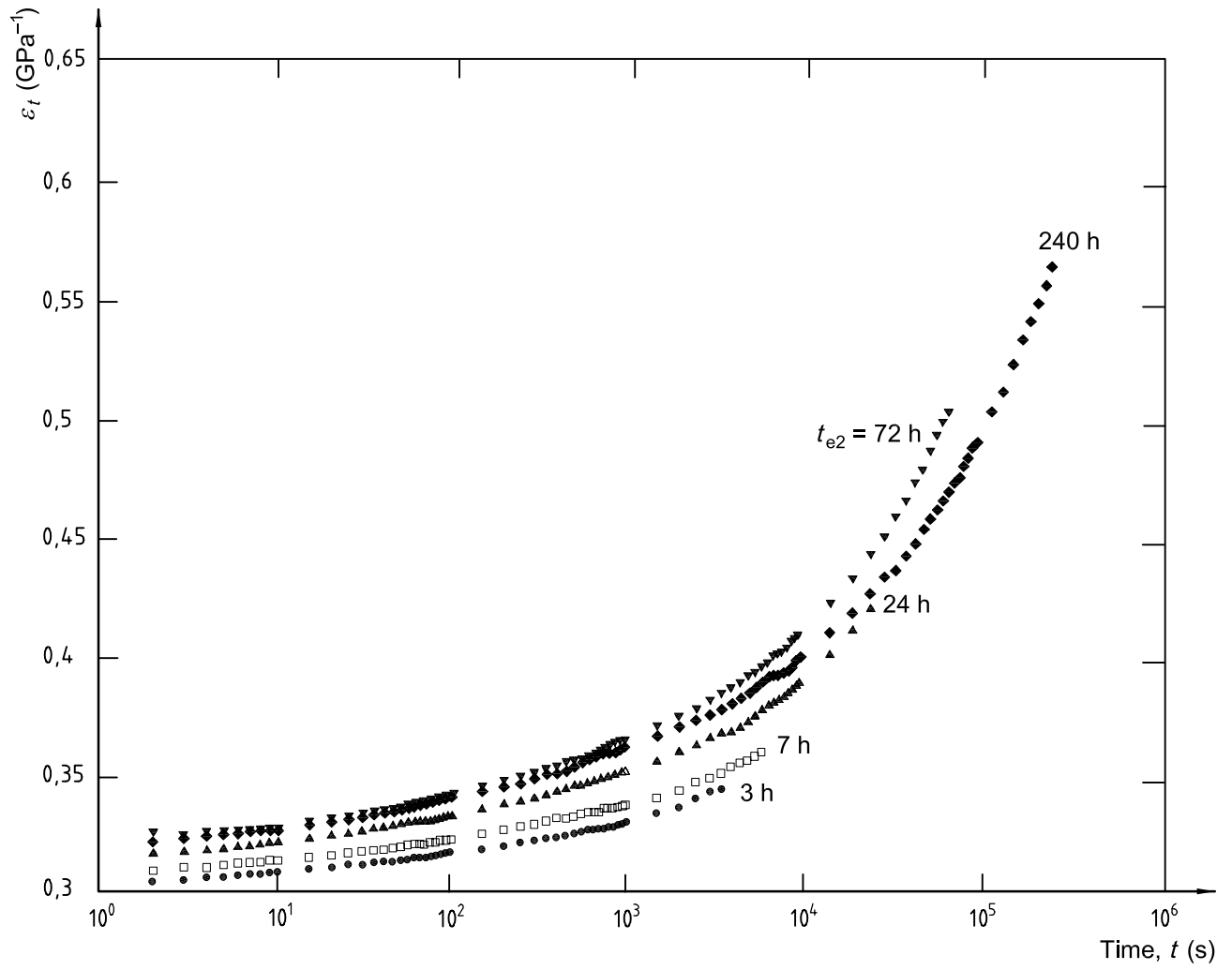

Figure A.3 — As for Figure A.2 but following storage for more than 1 year at 23 °C prior to heating

## Bibliography

- [1] TURNER, S., Creep in thermoplastics — Preliminary concepts and definitions, *British Plastics*, June (1964), pp. 322-324
- [2] LEHMANN, J., *Zeitstandverhalten von PMMA in der Freibewitterung und im Normklima*, V15 in 27. Jahrestagung der GUS, 18th March 1998, ISBN 3-9806167-0-3

www.iso.org

.....

---

---

**ICS 83.080.01**

Price based on 14 pages