

# Maritime structures —

## Part 7: Guide to the design and construction of breakwaters

ICS: 47.020.01; 93.140

Confirmed December 2011
----------------------------

# Committees responsible for this British Standard

The preparation of this British Standard was entrusted by the Civil Engineering and Building Standards Policy Committee (CSB/-) to Technical Committee CSB/17, upon which the following bodies were represented:

Association of Consulting Engineers  
 British Ports Federation and the National Association of Ports Employers  
 British Steel Industry  
 Concrete Society  
 Department of the Environment (Property Services Agency)  
 Department of Transport (Marine Directorate)  
 Federation of Civil Engineering Contractors  
 Health and Safety Executive  
 Institution of Civil Engineers  
 Institution of Structural Engineers  
 Oil Companies International Marine Forum

This British Standard, having been prepared under the direction of the Civil Engineering and Building Structures Standards Policy Committee, was published under the authority of the Standards Board and comes into effect on 31 October 1991

© BSI 2010

The following BSI references relate to the work on this standard:  
 Committee reference CSB/17  
 Draft for comment 90/10429 DC

ISBN 978 0 580 69608 4

## Amendments issued since publication

Date	Comments
31 January 2010	Correction to equations in <b>4.4.3</b> and <b>4.4.5</b>

# Contents

	Page
Committees responsible	Inside front cover
Foreword	v
<hr/>	
Section 1. General	
1.1 Scope	1
1.2 Definitions	1
<hr/>	
Section 2. Layout planning	
2.1 General	2
2.2 Harbour layout	2
2.2.1 General	2
2.2.2 Navigational aspects	2
2.2.3 Wave penetration	2
2.2.4 Wave overtopping and transmission	3
2.2.5 Breakwater alignment	3
2.2.6 Physical and computational modelling	4
2.3 Environmental effects	4
2.3.1 General	4
2.3.2 Hydrodynamic regime and sediment transport	4
2.3.3 Pollution	4
2.3.4 Ecological considerations	5
2.4 Data collection	5
2.4.1 Meteorology and climatology	5
2.4.2 Waves	5
2.4.3 Bathymetry and coastal topography	5
2.4.4 Water levels	5
2.4.5 Water movement	5
2.4.6 Sediment transport	5
2.4.7 Geotechnical aspects	7
2.4.8 Construction materials	7
<hr/>	
Section 3. General design of breakwater structures	
3.1 General	8
3.2 Design philosophy	8
3.2.1 General	8
3.2.2 The design wave	8
3.2.3 Factors contributing to failure	10
3.3 Design development	10
3.4 Design wave climate	12
3.4.1 Derivation of wave climate	12
3.4.2 Design wave conditions	13
3.5 Choice of type of structure	14
3.5.1 Types of structure	14
3.5.2 Factors affecting choice	14
3.6 Hydraulic model testing	16
3.6.1 Introduction	16
3.6.2 Model scales	17
3.6.3 Model concrete armour units	17
3.6.4 Model construction	17
3.6.5 Test programme	18
3.7 Risk analysis	20

	Page	
3.7.1	Limit states	20
3.7.2	Choice of level of risk	20
3.7.3	Fault trees	20
3.7.4	Method of analysis	21
<hr/>		
Section 4. Rubble mound structures		
4.1	General	22
4.2	Overall design	22
4.2.1	Factors affecting choice of cross section	22
4.2.2	Run-up and overtopping	28
4.2.3	Overall stability	28
4.3	Design of armour	31
4.3.1	General	31
4.3.2	Rock armour	31
4.3.3	Concrete armour units	32
4.3.4	Design formulae	34
4.3.5	Thickness and extent of armour layer	37
4.3.6	Crest and rear face armour	38
4.4	Design of core and underlayers	38
4.4.1	General considerations	38
4.4.2	Grading of core material	38
4.4.3	Sizing of underlayer material	39
4.4.4	Thickness of underlayers	40
4.4.5	Filters for reclamation	40
4.5	Design of crest structures	41
4.5.1	General considerations	41
4.5.2	Structural design	43
4.5.3	Analysis	43
4.6	Design of toe and apron	44
4.7	Design of foundations	49
4.8	Design of breakwater head	49
4.9	Low crest breakwaters	50
4.9.1	General considerations	50
4.9.2	Design of armour	51
4.10	Construction materials	51
4.10.1	Rock	51
4.10.2	Concrete	53
4.10.3	Geotextiles and related products	53
4.10.4	Bituminous materials	53
4.11	Construction	53
4.11.1	General	53
4.11.2	Construction plant	53
4.11.3	Construction sequence	54
4.11.4	Toe construction	54
4.11.5	Core and underlayers	54
4.11.6	Armour	54
4.11.7	Measurement, deviations and tolerances	56
4.11.8	Crest structure	56
4.12	Monitoring and maintenance	57
<hr/>		
Section 5. Vertical face structures		
5.1	General	58
5.2	Types of structure	58

	page
5.2.1 General	58
5.2.2 Structures with solid face	58
5.2.3 Structures with perforated face	58
5.2.4 Structures with rubble mound at seaward face	58
5.3 Design	58
5.3.1 General	58
5.3.2 Hydraulic performance	58
5.3.3 Loads	67
5.3.4 Overall stability	69
5.3.5 Foundations	69
5.3.6 Anti-scour protection	70
5.3.7 Crest structures	71
5.3.8 Breakwater head	72
5.3.9 Durability and detailing	72
5.4 Caisson structures	72
5.4.1 General	72
5.4.2 Shape	72
5.4.3 Foundations	73
5.4.4 Floating condition	73
5.4.5 Fill	73
5.4.6 Joints between caissons	73
5.4.7 Crest structure	73
5.5 Concrete blockwork structures	75
5.6 Mass concrete structures	75
5.7 Cellular sheet piled structures	75
5.7.1 General	75
5.7.2 Anti-scour protection	76
5.7.3 Crest structures	76
5.8 Double-wall sheet piled structures	76
5.9 Single-wall sheet piled structures	76
<hr/>	
Section 6. Composite structures	
6.1 General	77
6.2 Types of structure	77
6.3 Design of composite breakwater structures	77
6.3.1 Introduction	77
6.3.2 Factors affecting choice of cross section	77
6.3.3 Hydraulic performance	77
6.3.4 Loads	77
6.3.5 Overall stability	77
6.3.6 Substructure and foundations	79
6.3.7 Superstructure	80
6.4 Construction	80
<hr/>	
Appendix A Bibliography	81
A.1 Publications referred to in the text	81
A.2 Further reading	83
<hr/>	
Figure 1 — Typical breakwater layouts	6
Figure 2 — Relationship between design life, return period and probability of exceedence	9
Figure 3 — The design process	11
Figure 4 — Typical cause-consequence chart for a rubble mound breakwater	21

	Page
Figure 5 — Elements and functions of typical rubble mound breakwaters	23
Figure 6 — Examples of rubble mound breakwaters with underlayers	24
Figure 7 — Examples of rubble mound breakwaters without underlayers	27
Figure 8 — Transmitted wave height due to overtopping relative to freeboard of rubble mound	29
Figure 9 — Transmitted wave height due to overtopping as a function of percentage exceedence	30
Figure 10 — Significant causes of failure due to wave action	31
Figure 11 — Examples of concrete armour units	33
Figure 12 — Typical crest structures for rubble mound breakwaters	42
Figure 13 — Toe details for rubble mound breakwaters	45
Figure 14 — Falling apron for rubble mound breakwaters	47
Figure 15 — Threshold movement of stone on sea bed under wave action	48
Figure 16 — Typical breakwater roundhead construction	50
Figure 17 — Typical construction sequence for rubble mound breakwater	55
Figure 18 — Caisson structures	59
Figure 19 — Concrete blockwork structure	61
Figure 20 — Mass concrete structure	61
Figure 21 — Typical cellular sheet piled structure	62
Figure 22 — Double-wall sheet piled structure	63
Figure 23 — Single-wall sheet piled structure	64
Figure 24 — Vertical wall structure with perforated face	64
Figure 25 — Slotted wavescreen	65
Figure 26 — Vertical wall structures with armour mound at seaward face	66
Figure 27 — Wave transmission coefficients due to overtopping	68
Figure 28 — Stability number $N_s$ for rubble foundation and toe protection	71
Figure 29 — Typical caisson joints	74
Figure 30 — Typical composite breakwater structures	78
Figure 31 — Failure modes for a composite breakwater structure	79
Table 1 — Wind speed adjustment, nearshore	12
Table 2 — Overtopping water: safety considerations	14
Table 3 — Movement of concrete armour units in models	19
Table 4 — Damage classification in model breakwaters	19
Table 5 — Typical values of voids for armour	32
Table 6 — Suggested maximum sizes of concrete armour units	34
Table 7 — Suggested $K_D$ values for rock armour using Hudson's formula	36
Table 8 — Suggested preliminary $K_D$ values for concrete armour units in structure trunk	37
Table 9 — Weight of rock in underlayer for some concrete armour units	39
Table 10 — Layer coefficients	41
Table 11 — Engineering characteristics and performance of common rocks	52
Publication(s) referred to	Inside back cover

## Foreword

This Part of BS 6349 has been prepared under the direction of the Civil Engineering and Building Structures Standards Policy Committee.

This Part of BS 6349 consists of six sections providing guidance for the design and construction of breakwaters as follows.

- *Section 1: General;*
- *Section 2: Layout planning;*
- *Section 3: General design of breakwater structures;*
- *Section 4: Rubble mound structures;*
- *Section 5: Vertical face structures;*
- *Section 6: Composite structures.*

It has been assumed in the drafting of this British Standard that the execution of its provisions is entrusted to appropriately qualified and experienced people, for whose guidance it has been prepared. It provides information and guidance, not all of which may be directly verifiable. Depending upon the extent of information and knowledge gained in this field in the coming years, it is possible that this guide could be updated as a code of practice.

The seven Parts of BS 6349 are as follows.

- *Part 1: General criteria;*
- *Part 2: Design of quay walls, jetties and dolphins;*
- *Part 3: Design of dry docks, locks, slipways and shipbuilding berths, shiplifts and dock and lock gates;*
- *Part 4: Design of fendering and mooring systems;*
- *Part 5: Code of practice for dredging and land reclamation;*
- *Part 6: Design of inshore moorings and floating structures;*
- *Part 7: Guide to the design and construction of breakwaters.*

Parts 1 to 6 have been written as codes of practice and contain recommendations on good, accepted practice as followed by competent practitioners. Part 7 has been written as a guide.

A number of the figures and tables in this Part of BS 6349 have been provided by individual organizations who own the copyright. The details of the sources are given at the foot of each figure and BSI acknowledges with appreciation permission to reproduce them.

The full list of the organizations which have taken part in the work of the Technical Committee is given on the inside front cover. The Chairman of the Committee was Mr P Lacey CEng, FICE, FIMStructE, FIHT, FRSA and the following were members of the Technical Committee.

J G Berry	BA, BAI, CEng, FICE, MIMStructE
T Cunnington	BSc, CEng, MICE
D F Evans	CEng, FICE, FIMStructE
D Kerr	CEng, MICE
J W Lloyd	BSc(Eng), MICE
R J Pannett	CEng, MICE
J Read	MA, CEng, FICE
D C Spooner	BSc, PhD, MInstP, CPHYS
P D Stebbings	BSc(Eng), CEng, FICE
D Waite	CEng, FIMStructE, MICE, AWeldI
M J C Wilford	CEng, MIMStructE

A British Standard does not purport to include all the necessary provisions of a contract. Users of British Standards are responsible for their correct application.

**Compliance with a British Standard does not of itself confer immunity from legal obligations.**

#### **Summary of pages**

This document comprises a front cover, an inside front cover, pages i to vi, pages 1 to 84, an inside back cover and a back cover.

This standard has been updated (see copyright date) and may have had amendments incorporated. This will be indicated in the amendment table on the inside front cover.



# Section 1. General

## 1.1 Scope

This Part of BS 6349 provides guidance on the design and construction of breakwaters.

Breakwaters are structures which provide protection to harbours and structures such as sea intakes against wave action and this Part of BS 6349 gives guidance on the main types of breakwater. Floating breakwaters are not included.

Coastal structures such as groynes, revetments and training walls are not covered, although certain aspects of design may be found to be relevant to them.

**NOTE** The titles of the publications referred to in this British Standard are listed on the inside back cover. The numbers in square brackets used throughout the text relate to the bibliographic references given in Appendix A.

## 1.2 Definitions

For the purposes of this Part of BS 6349, the definitions in BS 6349-1 apply together with the following.

### 1.2.1

#### **rubble mound breakwater**

a structure composed primarily of rocks dumped or placed upon the sea bed. An outer layer, or layers, of more massive rock or precast concrete units provides an armour layer to protect the less massive rock core from wave attack. A concrete crest structure which contributes to the function of the breakwater may be constructed on the mound

**NOTE** Examples of rubble mound breakwaters are shown in Figure 6.

### 1.2.2

#### **vertical face breakwater**

a breakwater in which wave attack is resisted primarily by a vertically faced structure extending directly from sea bed level

**NOTE** Examples of vertical face breakwaters are shown in Figure 18.

### 1.2.3

#### **composite breakwater**

a submerged rubble mound foundation or breakwater surmounted by a vertically faced structure projecting above sea level

**NOTE** Examples of composite breakwaters are shown in Figure 30.

## Section 2. Layout planning

### 2.1 General

This section considers the planning of breakwater layout to achieve the harbour protection function. Guidance is given on navigational aspects, wave penetration, environmental effects and data collection.

### 2.2 Harbour layout

#### 2.2.1 General

Wave energy can enter a harbour by penetration through the entrance between the breakwaters, by overtopping and by transmission through permeable breakwater structures. The types of breakwater structures used and their detailed design therefore influence the wave climate within the harbour, and for this reason breakwater layout cannot be entirely separated from design of the structures; an iterative process is often needed in determining the optimum solution.

Port planning requirements for the number, size and locations of cargo handling facilities will determine the overall dimensions of the harbour. These considerations are outside the scope of this Part of BS 6349. References are given in 2.1.1 of BS 6349-2:1988.

Breakwaters can also be required to protect an approach channel from littoral drift or to stabilize or train the alignment of a tidal entrance.

The siting and layout of the breakwaters to provide the necessary degree of protection to the harbour are determined by the need for the following:

- a) sheltered conditions for ships at berth or anchorage;
- b) manoeuvring and turning areas for ships within the harbour;
- c) an adequate stopping distance for ships entering the harbour entrance at a safe navigating speed.

#### 2.2.2 Navigational aspects

Criteria for depth and width of approach channels are given in clause 18 of BS 6349-1:1984, criteria for manoeuvring inside harbours are given in clause 19 of BS 6349-1:1984, and criteria for the acceptable wave conditions for moored boats and ships are given in clauses 30 and 31 of BS 6349-1:1984. Suitable conditions should also be provided to enable tugs and mooring vessels to work satisfactorily.

The presence of the breakwaters produces special navigation conditions at the harbour entrance. Currents can be generated across a harbour entrance as a result of the deflection of currents and by wave diffraction around the head of the breakwater. Wave reflections can occur from the breakwaters, and as a vessel moves from the open sea to sheltered water there are significant changes in environmental conditions affecting the vessel over a short distance.

A wide harbour entrance, to ease navigation, conflicts with the objective of limiting wave penetration, and some compromise is needed. Navigation is not always possible in exceptional wind and wave conditions.

The advice of experienced mariners is essential in determining the optimum layout of breakwaters at the harbour entrance, taking into account the economic aspects of cost and any limits on navigation and port operation.

Models and ship simulators, described in clause 18 of BS 6349-1:1984, can be valuable aids to the planning of the harbour entrance and breakwater layout.

#### 2.2.3 Wave penetration

The most important determinant of harbour response is wave penetration through the entrance. It is first necessary to establish wave conditions just outside the entrance, then to determine the effect of the entrance in permitting waves to enter the harbour and finally to determine the response at critical positions within the harbour.

Guidance on establishing the offshore wave climate is given in clause 22 of BS 6349-1:1984, and methods of deriving inshore wave conditions at the harbour entrance are given in clause 23 of BS 6349-1:1984. Wave direction is important and, whilst the greatest shelter to the harbour area should be provided against the largest waves, lesser wave conditions from different directions can be important in designing the layout.

Consideration should be given to fairly frequent wave conditions as well as to rare events, as the former can affect down-time and economy of operation whereas the latter will affect safety. Acceptable limits on ship movement are given in 31.4 of BS 6349-1:1984.

Wave action should be investigated at different water levels caused by tide or surge effects. Water level will normally modify incident wave energy and can particularly affect wave direction at the entrance (see clause 25 of BS 6349-1:1984). Changes in sea bed contours can also have significant effects. An example would be the creation of a dredged channel outside the harbour, as referred to in 23.2.3 of BS 6349-1:1984.

Wave diffraction at the harbour entrance will determine the degree of shelter provided by the breakwaters and the spread of waves into the harbour basin. It is necessary to consider the extent to which waves can be reflected or absorbed within the harbour and, where depths vary, whether shoaling, refraction and bottom friction need to be considered in determining the harbour response. Guidance on these aspects and on the use of physical and computational models is given in clause 29 of BS 6349-1:1984.

Long period waves, over approximately 30 s, are difficult to exclude from a harbour and can cause ranging of moored ships. Long period waves can also cause harbour resonance, on which guidance is given in 29.4 of BS 6349-1:1984. This undesirable phenomenon is aggravated by the use of reflecting faces within the harbour and such faces should be avoided if possible. Absorbing faces sometimes have to be provided.

#### 2.2.4 Wave overtopping and transmission

Wave overtopping and transmission and their effect on harbour layout and response are determined by the design of the breakwater structure. It can be very costly to prevent waves overtopping a breakwater, because increasing the height to achieve this can greatly increase the forces on the structure. The extent of overtopping which can be allowed should be considered very carefully.

A distinction should be drawn between mass overtopping and wind-carried spray. In the case of a rubble mound breakwater the mass overtopping may be prevented or controlled by appropriate design of the seaward face and crest; wind-carried spray cannot be controlled. When reclaimed areas and installations are located behind a breakwater, overtopping and wind-carried spray can cause serious inconvenience or danger to personnel and vehicles, interrupt operations and cause flooding.

Suggested limits for overtopping are given in 3.5.2.4. These relate to the passage of vehicles and people. Even quite severe overtopping will rarely have a significant effect on wave action generally within the harbour, except in the special case of a breakwater designed with a very low crest. The effect then becomes important and is referred to in 4.9 with respect to rubble mounds, and in 5.3.2 with respect to vertical face structures.

Transmission through the structure can occur with a very porous rubble mound, e.g. one constructed only of large rocks, where the degree of transmission increases appreciably with wave period. For long period waves, over approximately 30 s, the effects on harbour response can be pronounced.

Vertical face breakwaters do not permit wave transmission except in the case of perforated wave screens, which are not generally applicable in harbour works but can be used in mild wave climates such as sheltered yacht marinas.

#### 2.2.5 Breakwater alignment

The dimensions of the harbour and alignment of breakwaters should be determined using the guidance in 2.2.1 to 2.2.4. A variety of options would usually be considered, and by taking advantage of favourable features of the coastline and sea bed topography, considerable economies can be achieved. For example, it could be possible to:

- a) site the root of the breakwater at a rocky headland to reduce the risk of scour at this location;
- b) choose a layout which will minimize the length and depth of construction for a given port area and facilities;
- c) select a breakwater position and alignment such that there is a reduction in the height of the waves which the breakwater has to resist.

The last arrangement could involve taking advantage of offshore reefs or sandbanks which would cause the higher waves to break before reaching the breakwater. In such cases it is particularly necessary to assess the effect of wave refraction, which can increase wave height due to wave concentration at some location along the breakwater. Wave height at the breakwater can also be increased by oblique wave attack causing a build-up of waves running along the breakwater.

It is important to determine whether the presence of the breakwater will cause changes, e.g. the deepening of offshore shoals which can then expose the breakwater to greater wave attack, as discussed further in 2.3.

Reflections from the seaward face of a breakwater can set up standing wave patterns which can result in increased wave attack in some sections. This effect is reduced if a convex alignment is adopted instead of a straight one. A concave curvature can create very severe wave concentrations and should be avoided.

The layout of the heads of the main and lee breakwaters are often designed to give a substantial overlap which will prevent direct penetration of the most severe waves into the harbour.

It is sometimes possible to design a main breakwater to resist the most severe wave attack and provide a lee breakwater of lighter construction as shown in Figure 1(a). This could enable harbour facilities to be concentrated along the lee breakwater, which would permit overtopping of some magnitude to be accepted along the main breakwater with consequent economy.

A different design of harbour, as shown in Figure 1(b), usually more appropriate to a river mouth where training of currents is important, has little breakwater overlap and permits more wave action to penetrate the entrance. Spending beaches inside the main breakwaters absorb a large proportion of the waves and a narrower secondary harbour entrance leads to the berths.

### 2.2.6 Physical and computational modelling

Much experience has been gained evaluating harbour layouts by means of physical models. Guidance is given in 29.5 of BS 6349-1:1984.

Computational models are now available for assessing the effects of different layouts. They can also be used to determine the qualitative effects of different layouts but do not necessarily give sufficiently detailed information for all aspects required. Guidance on the use of computational models is given in 29.6 of BS 6349-1:1984.

Current best practice for major projects is to use both physical and computational models.

Attention is drawn to the need for the early collection of site data to enable the model to be constructed and the test programme planned.

The physical models referred to above are often of too small a scale in a wave basin covering the whole harbour area to study breakwater structure stability. However, such models can give useful guidance on the parts of the breakwater which will suffer the most severe wave attack, and these can be used to guide the planning of hydraulic model testing, referred to in 3.6.

## 2.3 Environmental effects

### 2.3.1 General

Construction of breakwaters involves one of the largest changes which can be imposed on a coastal regime. Considerable attention should be given not only to the effects of the environment on the breakwater but also to the effects of the breakwater on the environment. Factors which could arise are indicated in 2.3.2 to 2.3.4.

### 2.3.2 Hydrodynamic regime and sediment transport

A breakwater will cause changes to the sea state (see clause 28 of BS 6349-1:1984). The resulting changes arising from the movement of mobile bed material by tidal or wave induced currents need careful evaluation even though considerable uncertainty attends the results. Clause 14 of BS 6349-1:1984 gives general advice on sediment transport and the limitations of both physical and mathematical modelling of the processes.

In the simplest case it is to be expected that up-drift accretion and down-drift scour will occur after construction of a coastal harbour, as indicated in Figure 1. Up-drift accretion could eventually cause the formation of a bar across the entrance, which can require maintenance dredging. Down-drift erosion could lead to loss of beaches and the need for coastal protection measures, which can extend a long way from the harbour.

The effects on the breakwater structure need to be assessed. For example shoaling can reduce wave action on the up-drift breakwater and toe scour can increase the risk of instability of the down-drift breakwater.

Where littoral drift is a major feature of the coastline and the consequences of interruption of the drift are likely to have serious effects on the adjacent shoreline it can be necessary to provide a bypassing facility for the drift material.

Bypassing can be achieved by the training of tidal currents if these are of sufficient strength or by trapping drift material where it can be pumped past the entrance or dredged and dumped to feed the beaches on the down-drift side.

### 2.3.3 Pollution

The creation of a coastal harbour will result in an area of water relatively undisturbed by waves and currents. As far as is practicable no major drainage sources should be allowed to discharge into the harbour as pollution and settlement of sediment could occur in the quiescent water.



Openings or culverts can be provided at suitable positions in breakwaters to increase flow inside a harbour, where the tidal range is small, e.g. in the Mediterranean Sea.

Outside the harbour the changes in the hydraulic regime due to the breakwaters can affect the dispersion of pollutants.

#### 2.3.4 Ecological considerations

Breakwaters generally have no harmful effects on the ecology of the area unless changes they cause in the regime affect the local habitat (see **13.5.2** of BS 6349-1:1984).

## 2.4 Data collection

### 2.4.1 Meteorology and climatology

Data on wind, temperature and barometric pressure are required for breakwater design and construction, and for assessment of wave climate and extreme water levels. Details of sources of data and the meteorological and climatological considerations to be taken into account are given in clause **7** of BS 6349-1:1984.

### 2.4.2 Waves

The design and construction of breakwaters requires detailed knowledge of wave activity and persistence under all conditions. Data on extreme wave heights are required for design of structures, while data on seasonal and annual variations are required for layout of harbours, for assessing the effect on harbour operations and for construction planning. At some locations, particularly where there is a persistent swell, data on long period wave activity will be needed. Details of data sources, wave recording and analysis are given in clause **26** of BS 6349-1:1984.

### 2.4.3 Bathymetry and coastal topography

Details of sea bed and coastline are required for determining the alignment of breakwaters and assessing the effect of the sea bed and coastal features on wave propagation in the area under consideration. The extent of the area to be surveyed and the specification of the survey work needed can be determined from a study of available charts. Additional bathymetric information can be obtained from collector charts held by The Hydrographer of the Navy<sup>1)</sup>. The Hydrographic Department holds records not only for the UK but also for many other countries. Similar facilities are available in other countries.

The extent of the offshore bathymetry needed for wave refraction studies is related to wave period. The area covered to seawards of the proposed breakwater should normally extend to locations where the depth is about half the wavelength. Methods of carrying out bathymetric surveys are described in clause **8** of BS 6349-1:1984.

### 2.4.4 Water levels

Data on variations in water levels due to tidal fluctuations and predictions of extreme water levels due to barometric effects, storm surges and wave set-up are required.

Methods of water level recording and the meteorological effects causing changes in levels are described in clause **10** of BS 6349-1:1984 and guidance on storm surges is given in clause **25** of BS 6349-1:1984.

In areas where tsunamis occur a thorough investigation of historical records is sometimes necessary to determine their severity and probability of occurrence. For data in the Pacific Ocean reference can be made to the US Weather Centre in Hawaii.

### 2.4.5 Water movement

Data should be collected on the velocity and the pattern of currents at the site of the breakwater so that the effect of the proposed structure on the hydrodynamic regime can be investigated. The same data is needed to study navigational aspects. Some information on currents can be obtained from the Admiralty Pilots published by The Hydrographer of the Navy and other similar bodies in other countries. Current directions and velocities also appear on charts but the information is usually insufficient for detailed planning purposes. Local fishermen and yachtsmen are often a valuable source of information, particularly during the preliminary stages of design, but quantitative information from such sources should be treated with caution.

Methods of measuring current velocities are described in **11.2** of BS 6349-1:1984.

### 2.4.6 Sediment transport

The effects of alterations to the hydrodynamic regime due to breakwater construction and the subsequent changes in sediment transport should be considered, as discussed in **2.3.2**.

<sup>1)</sup> The Hydrographer of the Navy, Taunton, Somerset TA1 2DN.

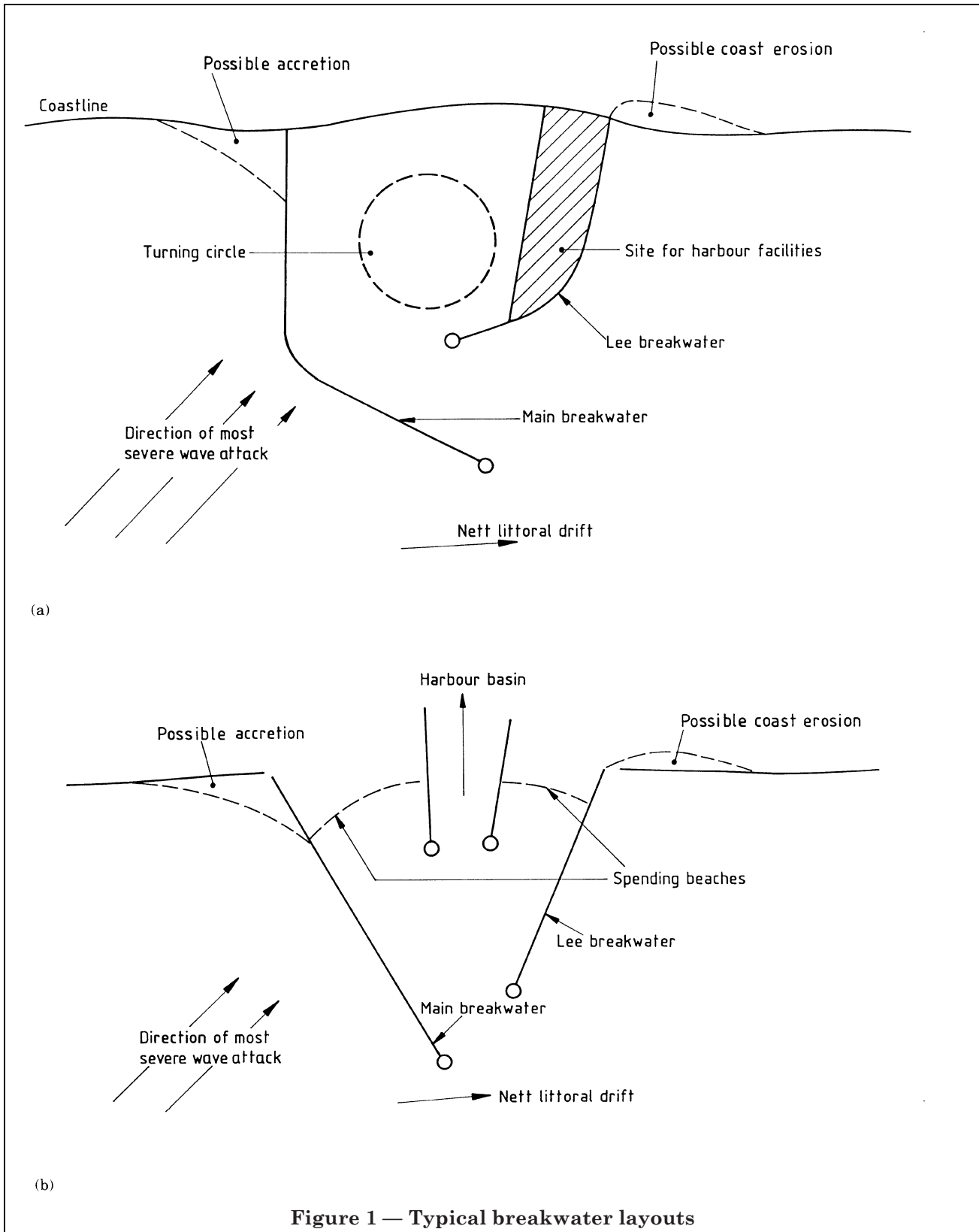

Figure 1 — Typical breakwater layouts

Comparative study of old charts, and aerial photographs, can give an indication of the extent of bed movement which has occurred in the past. Sediment transport and methods of measuring sediment load, accretion and scour due to wave transport are discussed in clause 14 of BS 6349-1:1984.

#### 2.4.7 Geotechnical aspects

Guidance on site investigations required to determine subsurface conditions is given in clause 49 of BS 6349-1:1984. Borehole investigations should, where appropriate, be preceded by side scan sonar and geophysical surveys to obtain a preliminary picture of coverage of surface and subsurface changes throughout the area under investigation.

Careful consideration should be given to the timing, extent and detail of marine site investigations. At the early stages of design the precise location of breakwaters can be uncertain, suggesting coverage of a wide area in limited detail. For final design of the structures a narrower area requires more detailed exploration.

The sequential development of knowledge of the subsoils has to be tailored for each individual project, being dependent on the ground variability and the cost of setting up one or more stages of investigation. It is also largely affected by the remoteness of the site and the severity of wave exposure.

#### 2.4.8 Construction materials

Large volumes of rock and concrete aggregates are usually required for breakwater construction. The potential sources and qualities of material should be determined at an early stage. The work includes the assessment of available maps, photographs and reports, followed by site investigation.

Tests for quality of primary armour rock are described in 57.2 of BS 6349-1:1984. Estimates of the yield of rock of different sizes can be made by experienced engineers and geologists and some guidance on this is given by Allsop, Bradbury and others [1]. Further information on particular aspects of rock material usage in rubble mound breakwaters is given in 4.10.1.

## Section 3. General design of breakwater structures

### 3.1 General

This section considers the philosophy of the design of breakwater structures, the factors which affect the selection of design criteria and the derivation of design wave conditions. Considerations which affect the choice of structure type are described and the use of hydraulic models is discussed, followed by a review of risk analysis.

### 3.2 Design philosophy

#### 3.2.1 General

The structural design is determined by the function of the breakwater, the site topography, environmental conditions and economic considerations. The principal factors in design are wave loading and foundation conditions.

The essential comparison of imposed wave loadings and the structural resistance to such loadings is complex. The reasons for this are that wave loads are stochastic in nature, and structural response to waves is not fully understood.

The practical approach adopted differs between vertical face and rubble mound structures, and the current design philosophy can be briefly described as follows for each case.

Vertical walls are regarded as rigid structures and are designed by a quasi-static analysis, in which an assessment is made of extreme wave conditions at the structure, from which pressures, loads and movements are computed from formulae. These applied loadings are compared with the resistance of the structure to confirm that the design has appropriate factors of safety. The uncertainty in design is largely concerned with the wave conditions and the validity of the formulae used.

For rubble mounds, which are regarded as flexible structures, there is similar uncertainty over wave conditions, but in addition the nature of wave/structure response is less well understood. The design is thus based on a concept of tolerable damage or movement of the main armour layer, using empirical relationships to assess the design of the main armour for given wave conditions. Other elements of the rock mound are empirically related to the main armour layer. There is no quasi-static concept of overall safety factors in current design philosophy, although advances are being made in the understanding of probabilistic design of rubble mounds.

The extreme wave conditions selected for the design of a breakwater must be carefully assessed in each case. It is common practice to regard a design wave as a single value of wave height with a low probability of exceedence during the intended service life or design life of the structure. However, the descriptive parameter of wave height for a given sea state can vary according to the design method used, as described in sections 4, 5 and 6. For example the maximum wave height  $H_{\max}$  is usual for vertical walls, whereas the significant wave height  $H_s$  or the mean of the highest one-tenth of wave heights  $H_{1/10}$  is used for rubble mounds. In addition other sea state parameters such as wave period, spectral energy, direction and whether waves are breaking are important in the design process.

It is nevertheless convenient to make the following observations generally in terms of wave height. It is the major parameter in assessing the severity of wave action, and in a particular sea area an increased wave height on a structure will generally lead to an increased probability of failure.

Failure is defined as having occurred when the breakwater no longer substantially fulfils its function of providing protection to a harbour or land area or if the cost of damage repair, including interference with commercial operations, is unacceptable. This is the ultimate limit state.

The serviceability limit state exists when damage to the breakwater of considerable magnitude has occurred but it is still possible to carry on most normal operations inside the harbour.

The acceptable probability of failure or the acceptable degree of damage during the life of the structure should be decided at an early stage of the design. The cost of the repair should be estimated and included in the assessment of the economic feasibility of the project. It will be evident that at the early stages of design this will be very imprecise, but should be improved as the project proceeds and more information becomes available.

#### 3.2.2 The design wave

The design methods described in this Part of BS 6349 are based on the assumption that some waves that occur during the life of a breakwater may be higher than the design wave.

Design life is discussed in clause 16 of BS 6349-1:1984, but the choice should be determined chiefly by the function of the project. A service life of 50 to 100 years is often assumed, but the design wave should normally have a much longer return period for the reasons set out below.



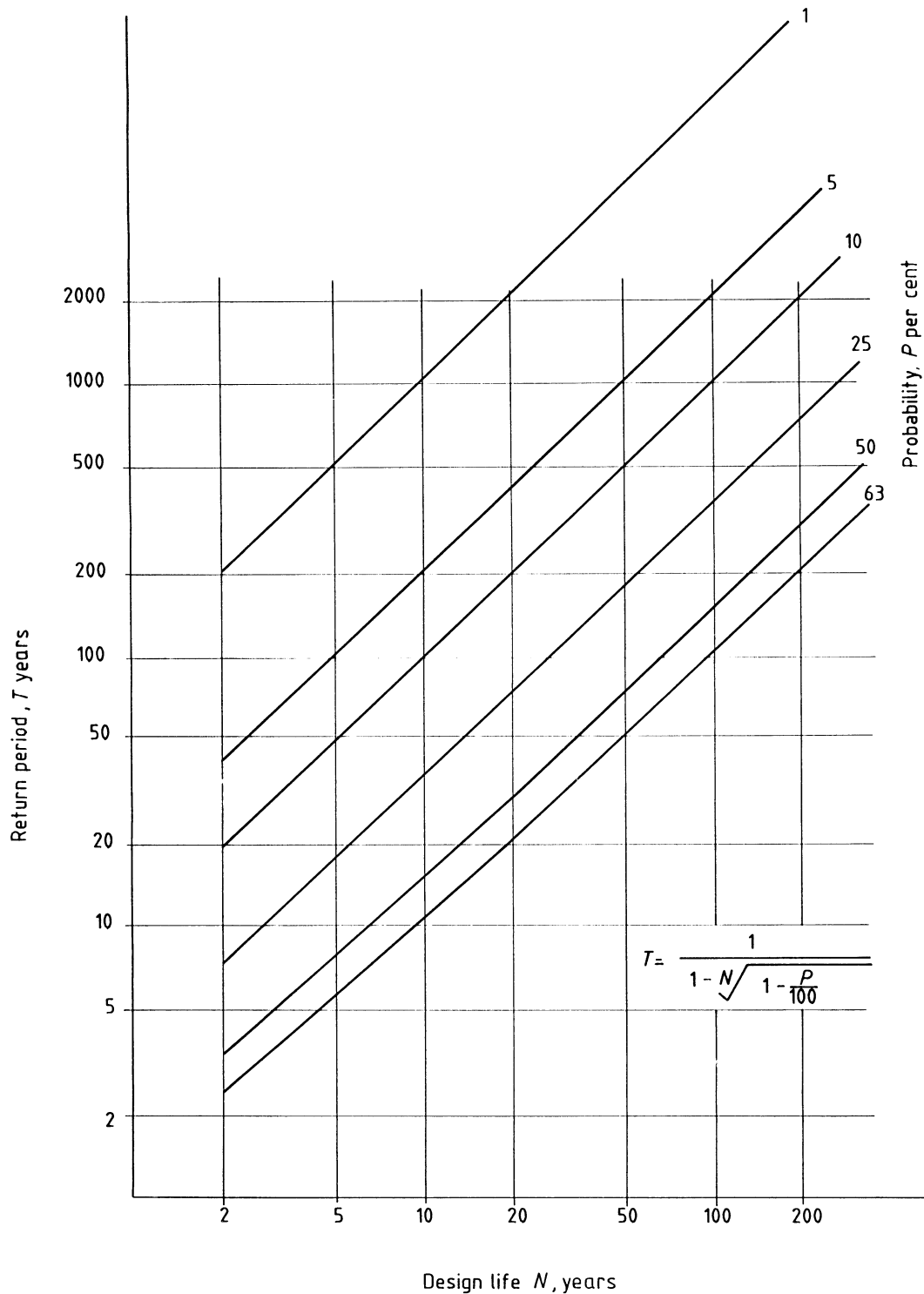

NOTE  $T$  is the return period of a particular extreme wave condition in years.  
 $P$  is the probability of a particular extreme wave condition occurring during design life  $N$  years.

**Figure 2 — Relationship between design life, return period and probability of exceedance**

If a breakwater is designed to resist a wave whose return period equals the design life, there is a 63 % probability that the design wave will be exceeded during the design life (see clause 21 of BS 6349-1:1984).

The relationships between design life, return period and probability of exceedence are shown in Figure 2. If a 5 % probability of the design wave being exceeded were to be acceptable for a design life of 50 years, it would be necessary for the design wave to have a return period of 1 000 years.

It is therefore necessary to balance the probabilities and consequences of damage against the costs of avoiding or reducing these risks. It is recommended that the stability of the structure should be checked under a wave which has a probability of exceedence during the design life of only 5 %. This is not necessarily a no-damage condition.

The value to be ascribed to the height (and other parameters) of a design wave with a return period considerably longer than the design life is site specific. Where there are no natural limits of wave action due to shallow water or limited fetch length, an extrapolation of return periods by the methods described in clause 27 of BS 6349-1:1984 can be used. However, generally in shallow water conditions, there can be a physical limit to wave action so that the 1 000-year return period wave can be little different from the 50-year return period wave. In determining such cases it is necessary to take account of the combined probabilities of storm waves and high water levels due to tide and surge.

### 3.2.3 Factors contributing to failure

Significant modes of failure are indicated in Figure 10 (for rubble mounds) and Figure 31 (for composite breakwaters). However, where failures have occurred it has frequently not been possible to identify a single cause with certainty. Factors which are believed to have contributed to failure, and which should be considered during the design of a breakwater, include the following:

- a) underestimation of design wave due to inadequate information about wave climate or designing for too short a return period;
- b) insufficient allowance for local concentration of waves due to localized feature of sea bed contour;
- c) inadequacy of design techniques and knowledge of the behaviour of the structure resulting in hydraulic instability of the structure and its component parts;
- d) inadequacies in carrying out and in interpreting the results of hydraulic model tests;
- e) geotechnical instability of the structure or its foundations;

f) insufficient control and supervision of construction, particularly in placing of underwater elements;

g) poor quality of materials used in construction, or insufficient appreciation of material behaviour in service, e.g. inadequate resistance to corrosion, abrasion, weathering; fatigue of concrete armour units and variations in quality.

## 3.3 Design development

Figure 3 illustrates a logic diagram for the design process from the pre-feasibility stage to the construction stage [2].

An assessment of wave climate is the first requirement as wave action is the most important consideration in design. It can be based at the pre-feasibility stage on storm wave prediction using formulae involving wind speed, duration of storm and fetch as described in 22.2.1 to 22.2.5 of BS 6349-1:1984. This is refined at the feasibility stage by analysis of additional wind records and using the results of wave records. The process is described further in 3.5.

A number of alternative preliminary designs should be prepared and compared during the period when more detailed site-specific information is collected and analysed to ensure that all required data is obtained. The main elements to be considered in design and the procedures which are available are described in sections 4, 5 and 6.

All except the simplest of breakwater designs should be based upon hydraulic model testing (see 3.6). The sections to be tested should be chosen after comparing alternative designs and selecting the optimum.

Physical hydraulic model testing is the most efficient and reliable way of determining the stability of a breakwater design and recent developments in laboratory techniques enable most hydraulic aspects of stability to be investigated. A comprehensive series of model tests should be carried out to refine the design and determine the safety of the structure under extreme conditions. Because of limitations of time and cost it is rarely possible to test all options and the test programme should be carefully prepared to obtain the greatest benefit from testing and to assist interpretation of the results.

Computational models have not yet been developed for examining the hydraulic stability of breakwater elements although there have been some advances in research into modelling the hydraulic behaviour inside a rubble mound and its effects on overall geotechnical stability.

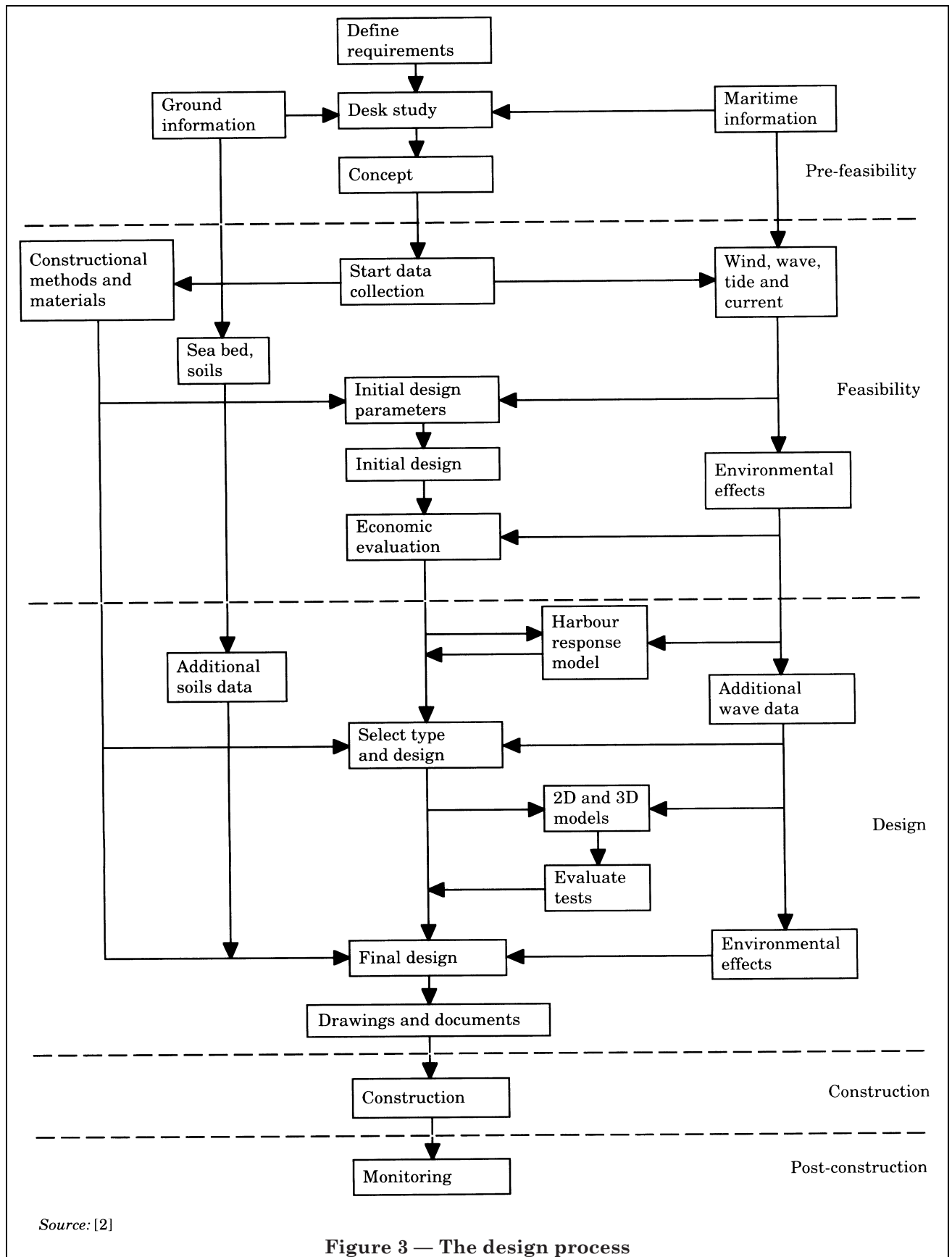

The final stage of each design process should comprise a thorough analysis of the expected risks and consequences of damage with a view to balancing the costs of acceptable damage against capital investment required, while at the same time seeking to provide adequate factors of safety against those forms of damage which constitute failure of the project as a whole to fulfil its function.

This final design stage will take into account the extent and reliability of the data collected, the results of hydraulic model testing and its limitations, the availability and cost of construction materials, construction methods and the risk of damage and its repair. Risk analysis is discussed in 3.7 and should be reviewed fully at the final stage of design. However, the need for adequate margins of safety against ultimate failure during design life and application of the philosophy of risk analysis should be considered by the designer throughout the design process.

### 3.4 Design wave climate

#### 3.4.1 Derivation of wave climate

##### 3.4.1.1 General

Wave data are often expressed in terms of significant wave height  $H_s$  for storms of different return periods. This is now recognized as being only part of the description of wave conditions, as mentioned in 3.2.1, and wave period, spectral energy, wave direction and breaking need also to be considered.

Wave grouping effects, as described in 24.3 of BS 6349-1:1984 can occur. The long waves associated with wave grouping are of importance in harbour response, but the effect of wave groups on structures (particularly rubble mounds) is less certain.

Methods of predicting wave parameters are given in clauses 22 and 23 of BS 6349-1:1984; wave recording and analysis are discussed in clause 26 of BS 6349-1:1984 and extrapolation of wave data in clause 27 of BS 6349-1:1984. The effects of breakwaters and sea walls on sea states are discussed in clause 28 of BS 6349-1:1984.

##### 3.4.1.2 Wind records

It is rare for long term recorded wave data to be available and short term records, which are often for only one year, are not necessarily representative of long term conditions.

Wind records can be used for hindcasting over many years to assist in extrapolating wave records and to determine whether the period of wave recording occurred during a period of low, average or high wind (and therefore wave) activity. Design wave conditions can then be determined by comparing recorded heights with the estimated wind-generated heights during the period of recording and during extreme storm conditions.

Wind records are often the only available means of determining offshore wave directions. When waves travel into shallow water their characteristics are altered and should be assessed as described in clause 23 of BS 6349-1:1984.

The UK Meteorological Office provides overland wind records which can be used to estimate overwater wind speeds. Table 1 gives approximate relationships for anemometer stations within 16 km of the coast. A check should be made to establish whether wind speeds recorded at the station are affected by major topographical features.

It should be borne in mind, however, that local winds may be quite different from those in the area where waves are generated. Wave forecasting from synoptic charts may be of greater value [3].

**Table 1 — Wind speed adjustment, nearshore**

Wind direction	Location of recording station	Ratio <sup>a</sup>
Onshore	3 km to 5 km offshore	1.0
Onshore	At coast	0.9
Onshore	8 km to 16 km inland	0.7
Offshore	At coast	0.7
Offshore	16 km offshore	1.0

<sup>a</sup> Ratio of wind speed at location to overwater wind speed (both at 9 m above sea level).

Knowledge of offshore wind conditions is not always available for prediction of wind conditions in sufficient detail for use over long fetches. Use should then be made of the published wind and wave observations made by mariners. Information on availability of records is now held by Marine Information and Advisory Services (MIAS) and the Meteorological Office have developed methods for enhancing the reliability of visual wave data which have been validated with measured wave records. These methods are based on functional modelling of the statistical relationships between wave height, wave period and wind speed and are incorporated in a computer programme NMIMET from which the wave climate may be synthesized [4, 5].

Since the raw data observations are concentrated along shipping lanes it is essential to review the likely spatial variability at the site of the breakwater.

#### **3.4.1.3 Wave hindcasting**

Wave hindcasting can be used for estimating wave conditions from historical wind data. Methods of wave hindcasting and forecasting make use of a wind model and a wave model. The wind model for hindcasting can use as an input not only synoptic weather charts at the time of the event but also other wind observations which have been collected before or after it. For further information on the use of these techniques see Battjes [6] and Mynett, De Voogt and Schmeltz [3].

#### **3.4.1.4 Tropical storms**

Tropical storms are revolving storms with very high winds of 33 m/s (64 kn) or greater and are known as hurricanes, typhoons, tornadoes, tropical cyclones and by other local names.

A fully developed hurricane can have a diameter of 1 000 km. At the average travel rate a hurricane will take about two days to pass. The worst conditions for shipping normally last only a small fraction of the two days and the period of most severe weather, including the eye, will seldom exceed 6 h. However, the effect on build-up of waves at a breakwater can be quite different depending on the direction in which the storm is travelling. A steady build-up of waves over a number of days is possible and the aftermath of swell can persist for a long time afterwards [7]. Swell can affect areas remote from the track of the hurricane.

Tropical storms cannot be fitted into the same statistical projection as normal wind/wave records and should be considered as a separate data set.

Tropical storms approaching a coastline will have an effect on water level due to surge, wind and wave set-up.

Further information can be obtained from the *Shore Protection Manual* [8] and the Meteorological Office.

#### **3.4.1.5 Storm duration**

The duration of storm wave attack will affect the extent of damage which can occur and is particularly important for a rubble mound and should be assessed. The probability of occurrence of two consecutive storms should also be investigated. If repairs needed as a result of the first storm cannot be executed before the arrival of the second storm, this could represent a worse case than a single storm that is more severe than either of the others.

Storm duration is less important for vertical face breakwaters where the critical condition is that which causes the worst case to occur, taking account of water level.

It should be noted that the longer a storm persists, the higher the maximum individual wave will be, as described in 27.3 of BS 6349-1:1984.

#### **3.4.1.6 Influence of water level**

Since the maximum height of waves which can attack a breakwater is dependent on the depth at or near the toe, a knowledge of tidal levels and extreme levels due to storm surges is necessary. The combined probability of a storm with high water levels should be assessed. With storm surges the meteorological conditions causing the rise in water levels are sometimes but not always the same as those causing maximum wave attack. In some cases the two conditions will be independent variables; in others they can be positively or negatively related. The likelihood of occurrence can be assessed by joint probability computations [9].

In some instances the low water case can be important as the form of wave attack can alter from non-breaking to breaking, due to the reduction in water depth. This can also increase toe scour.

#### **3.4.1.7 Tsunamis**

In areas where tsunamis can occur their effect should also be considered. Although the probability of coincidence with extreme storms is very low, wave shoaling, as mentioned in 24.4 of BS 6349-1:1984 can have a severe effect on these waves and their effect on the structure can be pronounced.

### **3.4.2 Design wave conditions**

#### **3.4.2.1 Methods for assessment**

A review of methods to establish the wave climate for breakwater design is given by Battjes [6]. The particular wave conditions which are critical in the design will depend upon the type of breakwater. Each part of the structure should be considered independently when determining design wave criteria.

#### **3.4.2.2 Wave height**

The deep water where waves at the structure are not depth limited and an unbroken wave can reach the structure, the selection of the design wave height should be based on a probability of exceedence within the design life of the structure. The probability of exceedence should be chosen taking into account the factors outlined in 3.2 and will involve both owner and designer. Extrapolation of wave data is described in clause 27 of BS 6349-1:1984.



Probabilities of waves beyond the design wave height should be predicted for use in a sensitivity analysis of behaviour under less likely conditions.

#### 3.4.2.3 Wave spectrum

The spectrum for the design wave cannot be predicted by extrapolation from short term wave records and it will rarely be possible to record a spectrum which is relevant to extreme conditions.

The reliability of wave spectra obtained from site records should be considered in relation to the length of records and whether these include any storms approaching the design wave in height. Adoption of an arbitrary one-dimensional spectrum such as JONSWAP (Joint North Sea Wave Project) in a fetch-limited situation, or Pierson–Moskowitz where a fully developed sea occurs, is sometimes the only solution (see 22.2.5 of BS 6349-1:1984).

#### 3.4.2.4 Wave refraction and diffraction

Both graphical and computer methods are available for determining the effects of wave refraction and diffraction (see clause 23 of BS 6349-1:1984). Back tracking will be the best method when considering wave conditions in the entrance or at the roundhead, but tracking the advancing wave can be more suitable when considering possible wave concentrations along the length of the breakwater.

Deep water incident waves are, at some sites, attenuated by diffraction around headlands. The graphical method described in 29.2 of BS 6349-1:1984 for a flat sea bed can be used to give an approximate solution. Computer methods are also available.

## 3.5 Choice of type of structure

### 3.5.1 Types of structure

1.2 defines the three main types of breakwater, the design of which is discussed with examples in sections 4, 5 and 6. In some cases general consideration, discussed in 3.5.2, will enable a decision to be made in favour of one type; in other cases it will be necessary to compare the cost of a number of designs of different types.

### 3.5.2 Factors affecting choice

#### 3.5.2.1 General

Some of the main factors which will affect the choice of type of structure are described in 3.5.2.2 to 3.5.2.10. These often result in conflicting preferences, and an important part of the design process will be giving each the appropriate weight in arriving at a compromise.

#### 3.5.2.2 Other functions

Besides providing sheltered water the breakwater can be required to protect a reclamation area, to provide a berth on the inner face or to support access and services. Both the risks of damage and its consequences are increased by designing for this type of dual function. Overtopping can be critical, and could have to be minimized at considerable extra cost.

#### 3.5.2.3 Navigation

Wave reflections from vertical face and composite breakwaters can cause confused seas at harbour entrances, rendering navigation dangerous. Energy absorbing rubble mounds in front of vertical walls, as illustrated in Figure 26, can be used to reduce such reflections. However, mariners need to give a wide clearance to underwater slopes, where navigation width is not so clearly defined as with vertical structures.

#### 3.5.2.4 Wave overtopping

Overtopping can be minimized with some types of breakwater by providing sufficient freeboard. In this respect rubble mound breakwaters are particularly suitable as most of the wave energy is dissipated in the armour layer before reaching and passing over the crest. With vertical face structures a column of water is thrown up by wave action with little reduction in energy, even with a high freeboard. The column could collapse partly on the structure and partly on the water area behind it, creating secondary waves. The secondary waves will have a shorter period than the incident wave.

Clause 28 of BS 6349-1:1984 discusses overtopping and Table 2 gives guidance on permissible volumes of overtopping water in relation to inconvenience or danger to personnel and vehicles.

**Table 2 — Overtopping water: safety considerations**

Consideration	(m <sup>3</sup> /m)/s
Inconvenience to personnel	4 × 10 <sup>-6</sup>
Inconvenience to vehicles	1 × 10 <sup>-6</sup>
Danger to personnel	3 × 10 <sup>-5</sup>
Impassable for vehicles	2 × 10 <sup>-5</sup>
<i>Source:</i> [10, 11]	

The discharges given in Table 2 are average values for personnel and vehicles about 3 m behind the wave wall; peak values can be up to 100 times the average.

### 3.5.2.5 *Wave transmission*

A permeable rubble mound breakwater consisting only of large rocks has good stability when partly built but has the disadvantage that waves, particularly those with periods of 20 s or more, are transmitted through the structure. As discussed in 2.2.4, the effects on harbour response need to be considered.

### 3.5.2.6 *Environmental effects*

The type of structure will influence the effects on the coastal regime as discussed in 2.3. The principal effects will be caused by the reflective characteristics of a vertical wall compared with the reduced reflections of waves from a rubble mound, both outside and inside the harbour.

### 3.5.2.7 *Foundation conditions*

Where poor foundations exist a rubble mound breakwater can be more suitable than a vertical face breakwater because it is better able to tolerate settlement. If it is necessary to remove poor foundation material and replace it with better quality materials, or where excavation would expose a firm foundation material, a vertical face or composite breakwater can be more economical than a rubble mound because the foundation width is less.

Sheet pile structures require good foundation conditions in order to develop resistance against rotational failure (see clause 51 of BS 6349-1:1984).

Wave action on breakwaters can cause erosion of the sea bed at the toe of the structure particularly where there are also significant currents. A rubble mound structure will generally cause less erosion than a vertical face structure.

### 3.5.2.8 *Construction materials*

Rubble mound construction requires large volumes of rocks of many sizes. When large rock cannot be obtained for armouring, concrete armour units can be used instead. If supplies of suitable rock are limited, a vertical face breakwater can be used, although in deep water it is usual to select a composite type. Although a composite breakwater requires less rock and of a smaller size than a rubble mound type, volumes may still be considerable.

Sand or gravel fill could also be required for replacement of weak foundation material and as ballast for caissons. If large quantities are required an offshore source should be located as extraction, transport and placing by dredger can be more economical than a land source.

For concrete caissons aggregates of the required quality are needed to ensure durability of reinforced concrete. Large quantities of good aggregate could also be needed in concrete armour units and cap structures on rubble mound breakwaters.

### 3.5.2.9 *Construction methods*

Rubble mound breakwaters in shallow waters do not necessarily require specialized construction plant. For bigger structures a large crane with long outreach will be required when placing armour from the crest of the breakwater and for placing core material between natural end tip face and final slope. Alternatively, the crane can be mounted on a jack-up barge or large pontoon but use of these will be affected by wave conditions.

Vertical face and composite structures usually require preparation of the sea bed and upper surface of the rubble foundation. This underwater work can be slow and requires calm sea conditions.

Vertical face and composite structures are often built by floating in caissons. These can be constructed in a dry dock. Alternatively the lower part of the caisson can be built onshore and lifted or launched into the water for completion afloat.

Caissons can also be lifted into position, which can reduce the period of risk of storm damage during construction, but in this case the availability of very heavy lifting equipment will be a major consideration. However, there are a wide variety of other forms of construction which can be considered depending upon circumstances. The degree of protection of the breakwater site will be an important factor (see 5.4).

Most forms of construction using steel sheet piling are very vulnerable to damage by wave action until each section has been completed, particularly cellular straight web sheet pile structures.

### 3.5.2.10 *Damage and maintenance*

Because of the variable and unpredictable nature of the wave forces to which a breakwater is subjected the possibility of damage during its life should be accepted. The method of repair should be considered in design.

Some rubble mound breakwaters can suffer a considerable amount of damage before their function is seriously impaired. With rock armour, a displacement of up to 5 % of the units is often considered acceptable before repair is necessary. With concrete armour units, depending on interlock for their stability, a lower level of allowable damage is advisable as fully effective repair is not always economically viable. In all cases repair work will require the use of heavy lifting equipment and permanent access along the breakwater should be provided if repair from floating plant is likely to be impracticable or too costly.

The availability and cost of mobilization of suitable plant and materials for repair is very important when considering what risk of damage should be accepted.

Limited movement of vertical face structures is acceptable if their sole function is wave protection. When other facilities are incorporated in or connected to the breakwater this can be unacceptable. Damage to joints between caissons whether caused by movement of the caissons or otherwise should be repaired as soon as possible in order to prevent further deterioration.

Serious damage to the rubble mound of a composite breakwater can lead to collapse of the structure above and total failure of the breakwater.

## 3.6 Hydraulic model testing

### 3.6.1 Introduction

Physical hydraulic model testing is the most reliable method of assessing the hydraulic performance of a breakwater. The reliability of test results depends upon the quality of the input data.

With reliable data it is reported that rock armoured rubble mound sections in a flume give almost complete agreement between model and prototype [12].

The primary object of testing is to check the stability of the breakwater up to and exceeding the design state and its hydraulic performance in respect of run-up, overtopping, wave transmission and reflection.

The use of computational models for planning breakwater layouts is described in 29.6 of BS 6349-1:1984, and the general principles given are applicable to breakwater stability tests.

As referred to in 2.2.6, the scales for a harbour response model are usually too small to represent properly the structure stability (see also 3.6.2), but depending on the size of wave basin available and the breakwater dimensions it is sometimes possible to combine structural testing in three dimensions with a harbour response model. This possibility should be borne in mind when planning the test programme.

There are three methods of physically modelling a breakwater structure in stability testing. The principal, easiest and most frequent method is to model a cross section of the breakwater in a flume, which gives normal wave incidence with unidirectional sea states. A programmable random wave generator should be used rather than one generating regular waves.

The cross section modelled will normally be chosen to represent that part of the breakwater with the most severe exposure, but in some cases it can be desirable to model more than one cross section at different locations.

Where oblique wave attack is expected, such as at roundheads, the use of a wave basin is to be recommended. Such a basin will contain part or all of the breakwater and will be used for tests with random long-crested waves, usually with a wave generator which can be moved to provide different incident wave directions. The sea state generator is unidirectional, as in a flume, but the effects of bed topography can cause wave concentrations and changes of wave direction at particular places along the breakwater, so that the results are more nearly representative of true wave conditions at the site than in a flume.

However, the long-crested seas generated are not fully representative of the multidirectional and short-crested waves which occur in nature, particularly in deep water. In order to study such effects on a structure it is necessary to generate multidirectional waves in a specially designed basin. Such a procedure is difficult and has rarely been used in breakwater engineering. Results available are insufficient to establish the value of this procedure, although studies on a rock mound have indicated that, for the same incident wave energy, a multidirectional sea produces less damage than a unidirectional sea normal to the breakwater [13].

The objectives of model testing, the methods to be used and the programming should be discussed with experienced hydraulic laboratories to ensure that the most suitable procedures are adopted.



### 3.6.2 Model scales

Models should be constructed to as large an undistorted geometric scale as is practicable. Scales are usually in the range 1 : 30 to 1 : 80, modelled according to the Froude scaling law for which the scale factors are given in 29.5 of BS 6349-1:1984.

For rubble mound breakwaters the behaviour depends partly on the flow of water through, into or out of the structure. Flow through the voids depends on Reynolds number which, as water is used in the model, is not correctly scaled and therefore flow and permeability cannot be correctly reproduced at all locations in the model.

It has been found in practice that scale effects are insignificant if the armour unit Reynolds number  $R_e$  is greater than about  $3 \times 10^4$ , although some recent studies suggest that it can be as low as  $8 \times 10^3$ . Reynolds number is defined as follows:

$$R_e = \frac{(W/\gamma_a)^{1/3} (gH)^{1/2}}{\nu} \quad (1)$$

where

$W$  is the armour unit weight (in t);

$\gamma_a$  is the density of armour (in t/m<sup>3</sup>);

$H$  is the wave height at incipient failure (in m);

$\nu$  is the kinematic viscosity (in m<sup>2</sup>/s);

$g$  is the acceleration due to gravity (9.81 m/s<sup>2</sup>).

When impacts due to breaking waves on vertical face structures are measured, the same scaling laws do not apply to all types of impact mainly because air entrainment cannot be modelled at suitable scales. Generally the Froude relationship is used as there is evidence to suggest that this gives a conservative result [14].

Erodible bed material is rarely modelled because of the difficulty of correctly modelling such material (see 14.6 of BS 6349-1:1984). Instead a rigid bed model is used and bed protection material modelled to Froude scale.

### 3.6.3 Model concrete armour units

When concrete armour units are used for rubble mound breakwaters it is generally not practicable to model all the material properties of the unit. Model units of concrete, mortar or plastic, correctly scaled for density and friction, are stronger than is required for similitude between model and prototype. This is particularly important with slender units such as Dolosse where the effects of rocking and displacement can cause breakage in the prototype, but breakage does not occur under similar wave conditions in the model.

The following methods have been used to study the behaviour of model concrete units. They are not generally adopted and add to the cost and duration of any model studies.

a) Instrumentation of model concrete units has been used in a few instances at large scales (1 : 5). Accelerometers have been used to measure the change of velocity on impact and the forces and stresses developed have been determined by analysis [15].

b) Model concrete units made of a material with scaled-down tensile strength have been inserted at critical locations in the model. Failure at these locations due to hydrodynamic and impact forces has then been revealed by testing [15].

c) A plastic material, steel-fibre-reinforced epoxy resin, has been used with the correct density but with an elasticity such that the strains induced on the unit during testing can be measured by model instrumentation. The strains measured during tests have been used to derive, by numerical analysis, loads which could be used for structural design [15].

Because of random placing and random wave attack a sufficient number of special model units should be provided to enable a statistical analysis of the results to be made.

### 3.6.4 Model construction

The model should be constructed to an undistorted scale and the relative density, coefficient of friction and shape of all materials correctly reproduced. If uplift pressures under crest structures, caissons or similar vertical face structures are to be measured it could be necessary to modify rock sizes to reproduce flow through the voids more correctly.

Model construction techniques should be comparable with those which will be employed in the prototype breakwater and care should be taken to see that over-compaction does not occur. In particular the method of placing armour units should be similar to that which will be used in the prototype in order to ensure that the correct packing density is achieved.

If placing is expected to take place during moderate sea and swell conditions, the appropriate sea states should be generated during armour placing. The armour layer should be reconstructed for each test series. Ideally the underlayer should also be reconstructed.

The sea bed should in general be modelled for a distance of about five wavelengths in front of the structure so that the effects of shoaling on the waves are reproduced. This is not always practicable in the flume available, and the effects on the structure need to be considered in deciding the scale and techniques appropriate in the particular case.

### 3.6.5 Test programme

#### 3.6.5.1 General

A test programme should consist of a series of preliminary tests designed to identify critical features of the proposed design and the effect of modifications. The preferred test section should then be subjected to a more comprehensive series of tests.

Regular waves should not be used for testing. A random deep water sea state should be produced by a wave generator which can reproduce the design wave energy/frequency spectrum and wave height group characteristics. For this purpose the generator should be able to reproduce a sequence of at least 1 000 waves so that random distributions are automatically generated. The sequence should be repeatable for comparative purposes.

Ideally at least five tests should be carried out for each design condition in order to allow for random variations in damage results.

When funds and time available for testing are limited, it is important that any limitations on the test results are understood and the test programme is carefully planned, within the constraints, to provide the information which will best enable a safe and economical design to be prepared.

It is important that variations in the design parameters of wave climate and water level should be examined particularly when water level variation can result in a change from non-breaking to breaking wave conditions. It is not normally possible to vary water level during a test as wave generator response will change.

In location with appreciable tidal ranges water levels can change significantly during a storm and therefore it will be necessary to design the testing programme to take account of this. It is usual to test at a high water level for overtopping and upper armour stability under the largest waves, with further tests at low water for toe scour and possibly for waves breaking seaward of the structure.

In all cases the relationships between wave conditions, water level and structure response need to be considered carefully in designing the test programme.

#### 3.6.5.2 Rubble mound breakwaters

##### 3.6.5.2.1 General

For rubble mound breakwaters a series of tests is often carried out increasing in steps, e.g. from 50 % to 120 % or more of design wave height with corresponding increases in wave period to simulate the build-up of storm conditions and to check the margin of safety in the test design. The most logical approach to deciding the steps and increasing severity of test conditions is to model waves with progressively lower probabilities of occurrence during the design life, to the limit discussed in 3.2.2. In depth limited conditions higher waves will tend to be modified or break before the structure and it can be impossible for a wave of 120 % of the design wave height to exist at the breakwater, although the use of increased wave period can affect stability.

Whenever larger waves are generated, the need or otherwise to raise standing water levels should be considered. Wave set up is normally reproduced in the model, and tide conditions can be regarded as independent of wave conditions. However, joint probability of increased storm surge with increased wave height will sometimes need to be taken into account (see clause 25 of BS 6349-1:1984).

The duration of each prototype test would normally be about 3 h but, when the test level reaches the design wave, prototype testing should be increased to 6 h. This will simulate storm build-up but if the storm profile is known, or has been deduced, this may be modelled.

In order to assess the stability of armour units their movement should be recorded by photography, cine film or video so that displacement can be measured or acceleration estimated. There are as yet no standardized methods of recording results and this can lead to difficulties when comparing published results.

The amount of movement which can be tolerated by a concrete armour unit before breakage occurs will vary with each type and with its size. Categories of movement which have been used for a number of unit types are given in Table 3.

A descriptive method of classifying overall damage is given in Table 4.

##### 3.6.5.2.2 Reflection and transmission

Coefficients of reflection from the breakwater and wave transmission through and over the structure can be measured by wave probes in front of and behind the breakwater.

### 3.6.5.2.3 Overtopping

With random seas the rate of overtopping varies considerably. Measurement of quantity should be made over periods of about 50 waves to 100 waves and this should be repeated to obtain sufficient results for statistical analysis of the overtopping discharge.

Spray cannot be correctly modelled because of the effects of viscosity, and wind is not usually modelled in a flume.

**Table 3 — Movement of concrete armour units in models**

Classification	Description
0	No discernible movement
R	Units seen to be rocking but not permanently displaced
1	Unit displaced by up to $0.5d$
2	Unit displaced by more than $0.5d$ and up to $1.0d$
3	Unit displaced by more than $1.0d$

*Source:* Hydraulics Research Ltd.  
NOTE  $d$  is normally the equivalent cube size of the unit, but other characteristic dimensions such as height of armour unit have been used.

**Table 4 — Damage classification in model breakwaters**

Damage	Description
Destroyed	Core of breakwater affected
Serious	Core of breakwater visible
Much	Large gaps in primary layer; 5 % of units displaced
Moderate	Gaps in primary layer; 3 % of units displaced
Little	2 % of units displaced
Slight	1 % of units displaced
Hardly	No damage

*Source:* Delft Hydraulics Laboratory

### 3.6.5.2.4 Toe scour

The sea bed profile is usually modelled as a fixed bed and model tests should be designed to determine the size of stone necessary to resist movement. Quantitative observation of sea bed scour is not possible but observation of currents above the bed will assist in determining the extent of protection necessary to reduce erosion to acceptable limits.

### 3.6.5.2.5 Forces on crest structures

Measurement of wave forces on crest structures can be carried out using the same methods as for vertical faced breakwaters (see 3.6.5.3). The work is difficult to execute and interpret because of the effect of the armour in front of the crest structure, and the uncertainty of modelling the flows and pressures in the rock under the cap. Crest structures have been modelled at reduced relative density to investigate whether there is a margin of safety in the design [16].

### 3.6.5.3 Vertical face breakwaters

The model testing of vertical face breakwaters is mainly concerned with the evaluation of pressures and forces on the structure rather than the determination of acceptable thresholds of damage, although the latter can apply in the case of scour protection. Measurement of overtopping and reflections will usually be important.

A series of tests should be carried out, using increasing steps in wave height as for rubble mound breakwaters (see 3.6.5.2).

It is particularly important to consider the full range of wave heights and water levels, as there can be considerable differences between the various types of wave impact on a vertical face (see 39.4 of BS 6349-1:1984).

Measurements of force or pressure should be made with continuously recording instruments so that fluctuations of magnitude and duration can be measured and exceedance curves calculated.

Total forces can be estimated by simultaneous measurement of pressure at a number of locations on the structure and integrating the results. Total forces on a rigid structure can also be measured using a force frame.

Wave forces and pressures are subject to rapid fluctuations and instrumentation should be sensitive enough to record this as maxima can exist for less than 0.1 s.

In order to indicate a margin of safety for a vertical face gravity structure such as a caisson, it is possible to model the structure at reduced relative density; this can also be done to assess temporary construction stability before filling is completed. However, because of variation in buoyancy with wave action, and the uncertainty of modelling uplift pressures, any threshold of movement will not necessarily provide a reliable measure of a true factor of safety.

For wave reflection, overtopping and toe scour, see 3.6.5.2.

### 3.6.5.4 Composite breakwaters

Testing of composite breakwater structures should combine the test programme and measurements outlined in 3.6.5.2 and 3.6.5.3.

Particular attention should be paid to the stability of the top of the rubble mound where wave reflections from the vertical face can cause stability problems.

### 3.6.5.5 Temporary conditions during construction

It is desirable to carry out tests on the partially completed stages of breakwater construction especially when storms expected to occur during construction can make it impossible to continue work during a winter season; some form of temporary protection can be justified.

Tests would be designed to assess the damage which might occur during a storm and find means of preventing or reducing it.

A construction wave climate which is appropriate to the risk should be used. Particular features which should be examined are as follows.

- a) For rubble mound breakwaters: stability of core and underlayer, effect of overtopping before crest is completed, scour at working end.
- b) For vertical face and composite breakwaters: effect of scour at working end and in front of vertical face, stability of partly completed structure.

## 3.7 Risk analysis

### 3.7.1 Limit states

The design of a breakwater should be such that, during its construction and throughout its intended service life, it has an acceptably low probability of failure, as defined in 3.2.1. In order to obtain the best assessment of probability, a risk analysis is carried out. The analysis involves quantifying, on the one hand, the probability of occurrence of an undesirable event (e.g. partial collapse of a breakwater) and, on the other, the consequences of the occurrence of that event (e.g. interruption of port operations).

A risk analysis requires the preparation of an inventory of the hazards and response mechanisms, i.e. the manner in which the breakwater responds to hazards. A distinction is drawn between ultimate limit state and serviceability limit state (see 3.2.1). The material damage and non-material loss for each state is assessed. The risk can be evaluated by multiplying the loss by the probability of occurrence during the service life of the structure.

### 3.7.2 Choice of level of risk

The choice of level of risk depends on the following factors.

- a) *The characteristics of the type of breakwater.* A rubble mound structure can suffer only partial damage when the design conditions have been exceeded. With vertical face or composite breakwaters or slender concrete armour units, the exceedence of design conditions can involve their total destruction.
- b) *The purpose of the breakwater.* The permissible risk level should reflect the importance of the breakwater, the function for which it has been designed and its value to commercial operations. The risk level for failure (ultimate limit state) should be different from that for damage (serviceability limit state).
- c) *The reliability of the data used for design.* If there is doubt about the data or the assumptions adopted, the philosophy should be to adopt a conservative approach and to design for a low risk.
- d) *Quality control and tolerances achieved in construction.*
- e) *Whether sufficient model testing has been carried out to be able to determine the failure conditions for the proposed design.*

Although it is possible to make a classification according to security or risk criteria in a qualitative way for different situations, the quantitative determination of the values to be adopted is a matter of decision for the person responsible for the project.

### 3.7.3 Fault trees

In assessing the safety of a breakwater the system should be considered as a whole, as the structure is composed of several components, each of which is subject to hazards and mechanisms, and the failure of any one component can lead to a different consequence. For industrial installations the system can be represented by diagrams such as fault trees and event trees. For breakwaters and other civil engineering projects, where problems of a continuous character are a fairly frequent occurrence a cause-consequence diagram may be more appropriate. An example is shown in Figure 4.



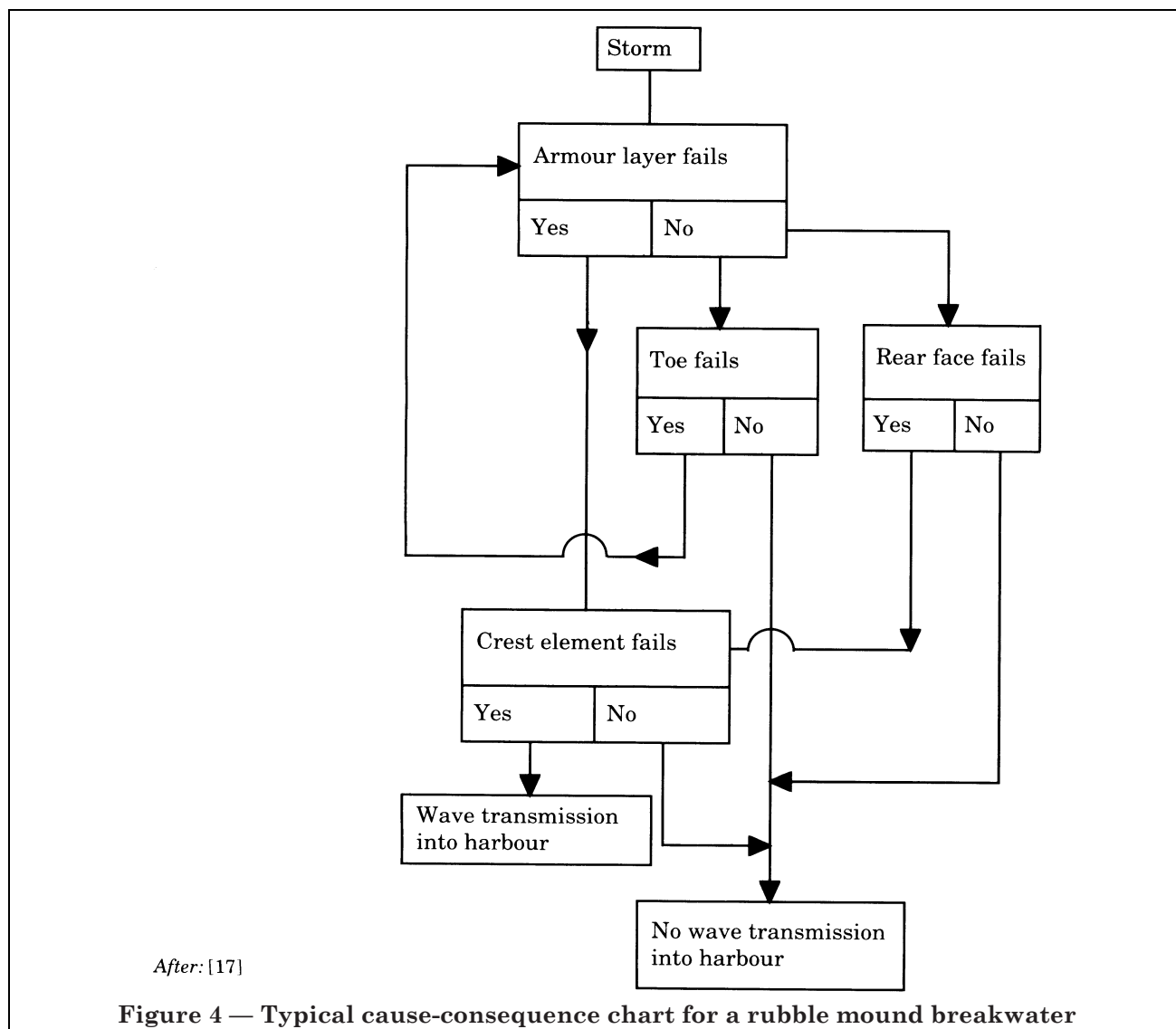

### 3.7.4 Method of analysis

There are two approaches in determining the probability of failure by a particular response mechanism. One is to prepare a computational model of the mechanism in order to establish a reliability function for the limit state considered; the other is to make a direct estimate of the probability on the basis of experience [17].

There are various techniques which can be applied to determine the probability of failure for a given reliability function and for given statistical characteristics of the basic variables, generally described as follows.

a) Level III comprises calculations in which the complete probability density functions of the stochastic variables are introduced and the possibly non-linear character of the reliability function is fully accounted for.

b) Level II comprises a number of approximate methods in which the reliability function is linearized and all probability density functions are approximated by normal distributions.

c) Level I comprises calculations based on characteristic values and safety factors. This is not strictly a probabilistic approach because uncertainty is not included.

Full physical descriptions of all the possible mechanisms which can lead to failure are not yet possible, nor can the probability density functions of the load and strength variables be formulated.

Methods of risk analysis are currently being developed, mainly at level II. In the meantime a factor of safety approach (level I) linked to qualitative comparisons based on fault tree and cause-consequence diagrams should be used to compare designs with respect to the risks to be adopted. This is a matter for consideration by both owner and designer.

## Section 4. Rubble mound structures

### 4.1 General

This section considers the detailed design of a rubble mound structure, and covers the various parts of the breakwater and the design of a suitable cross section to provide the necessary service functions.

The interaction of the component parts is important and successive designs for each element will need to be prepared, the effects on the total cross section examined and the optimum solution sought for the particular location and conditions.

Figure 5 indicates the elements and functions of a typical rubble mound breakwater. The design of the individual elements is dealt with in the succeeding parts of this section.

Figure 6 shows cross sections of several existing breakwaters and illustrates the diversity of designs which have been adopted for this type of structure.

### 4.2 Overall design

#### 4.2.1 Factors affecting choice of cross section

To perform the functions of limiting, to an acceptable degree, overtopping and the transmission of wave energy and providing stability under the severest wave attack, a rubble mound structure consists of a mass of rock material, generally of low permeability at the centre and gradually modifying to larger stable material on the outside, carried up to a suitable crest height. For practical purposes the structure is built in layers over a central core. Figure 7 shows an example of one layer over the core; Figure 6(b) and Figure 6(c) show three such layers.

The principal factors determining the cross section are the nature and slope of the seaward armour layer and the height and width of the crest of the breakwater. The cross section adopted has to be suitable for the foundation conditions and permit construction in a practical sequential manner.

Settlement to be expected and tolerable deviations from theoretical profiles during construction should be considered in determining the cross-sectional dimensions.

The maximum size of armour rock which can be economically obtained will be the chief factor in determining whether rock or concrete armour units are chosen for the primary armour, the size, layer thickness and slope of which depend on the design wave. The requirements for sizing the layer or layers beneath the primary armour will determine the thickness of such layers and the profile of the core.

The nature and slope of the armour layer will enable the run-up to be estimated as described in 4.2.2; this will indicate options for an armoured crest layer or a crest structure for tolerable overtopping (see 4.5). It is usual for the top of the core to be at such height above high water level that safe access for plant and personnel is provided during construction. This level of core will normally meet the design requirement of preventing or limiting transmission of waves. The width of the core is determined by the plant and vehicles which will be used for construction and this consideration often governs the width of the completed breakwater. If floating plant is used for construction the height and width of the core can be reduced (see 4.11).

Another main factor in designing the overall cross section is whether or not a crest structure is to be provided and the degree of overtopping which is acceptable. Several of the cross sections illustrated in Figure 6 show a crest structure, which can also have the function of allowing access to berthing facilities, access to service navigation aids, or access for inspection and maintenance. Crest structures can also be provided in order to limit run-up and overtopping (see 4.2.2). In other cases, the crest structure could be omitted, as shown in Figure 6(g) and Figure 6(j).

The position of the crest structure relative to the top of the primary armour slope needs special consideration. A berm of secondary armour on which primary armour is placed, seaward of the crest wall, is preferred in order to reduce forces on the wall and to provide enhanced stability of the top of the primary armour slope against wave turbulence caused by reflections from the wall. Figure 6(d) and Figure 6(e) show examples of this.

The natural angle of repose of the core as placed is usually steeper than the required slope of the primary armour. This difference can be pronounced with flat armour slopes.

Wave action during construction can be beneficial in flattening the tipped slope, but some reshaping will generally be needed to produce the designed outer slope of the core.

Alternatively the difference in slope can be accommodated by placing additional core material to form one or more berms, or varying the thickness of the underlayer as shown in Figure 6(a) and Figure 6(f).

Many variations are possible and the best choice will be influenced by site conditions, available materials and construction plant.

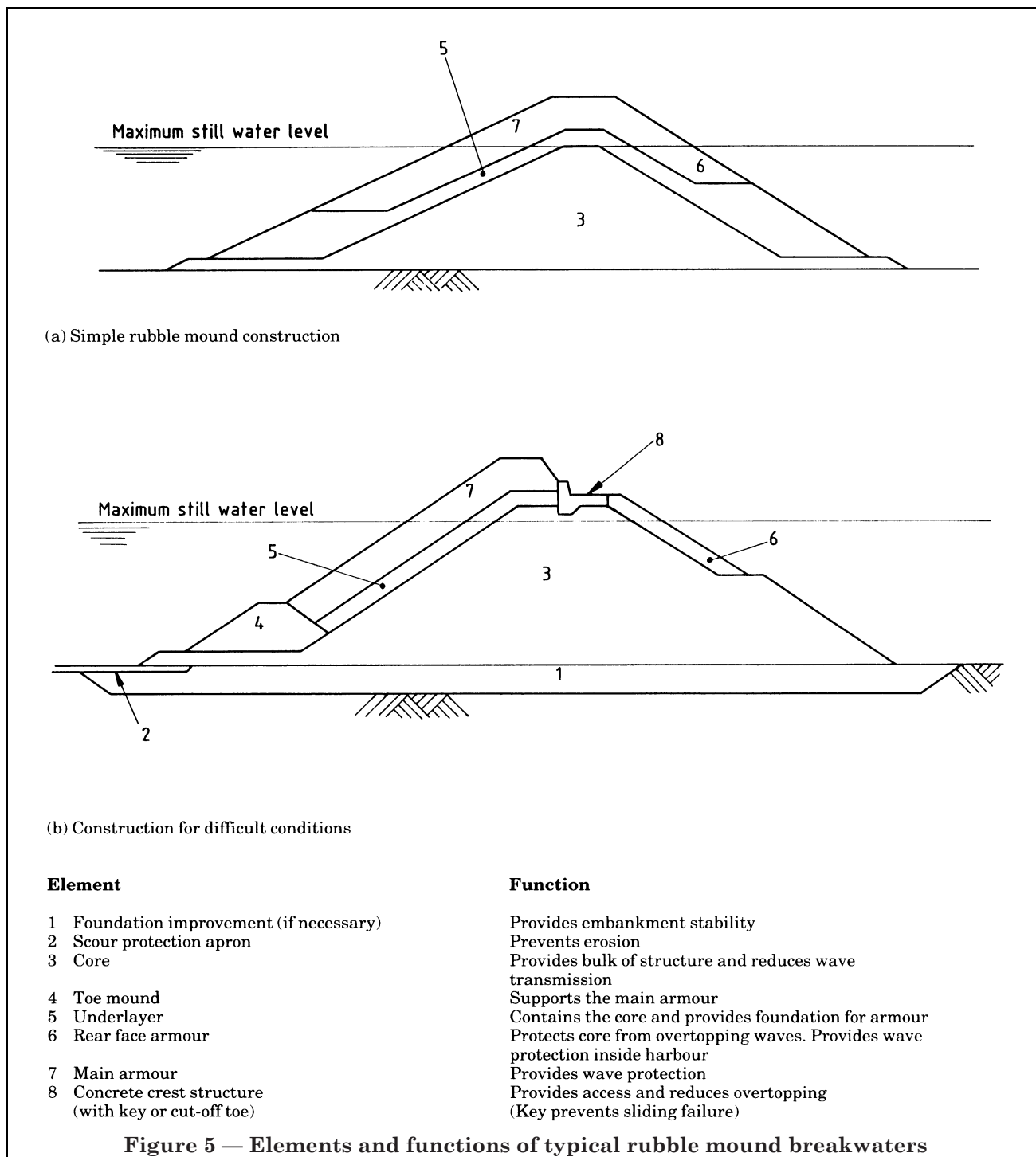

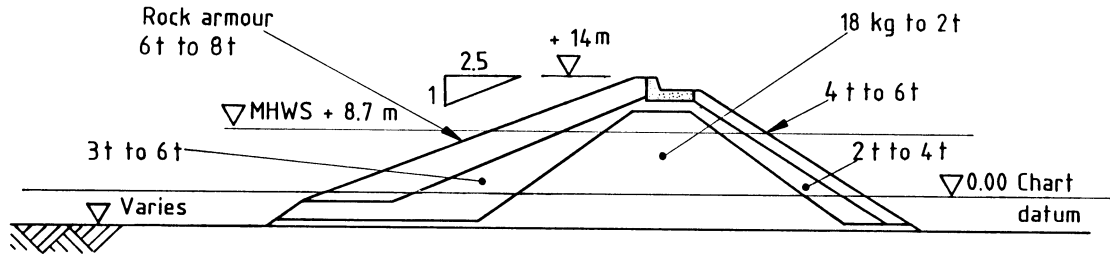

(a) Port Talbot, UK

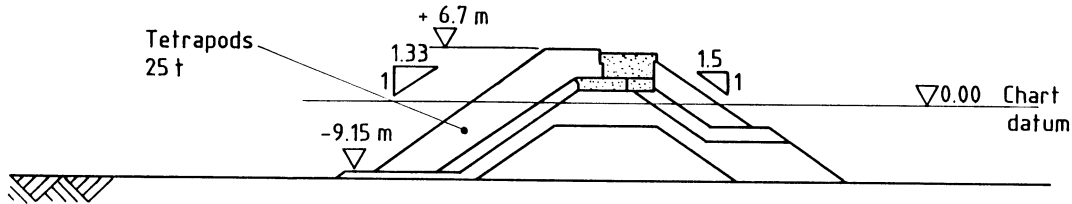

(b) Crescent City, USA

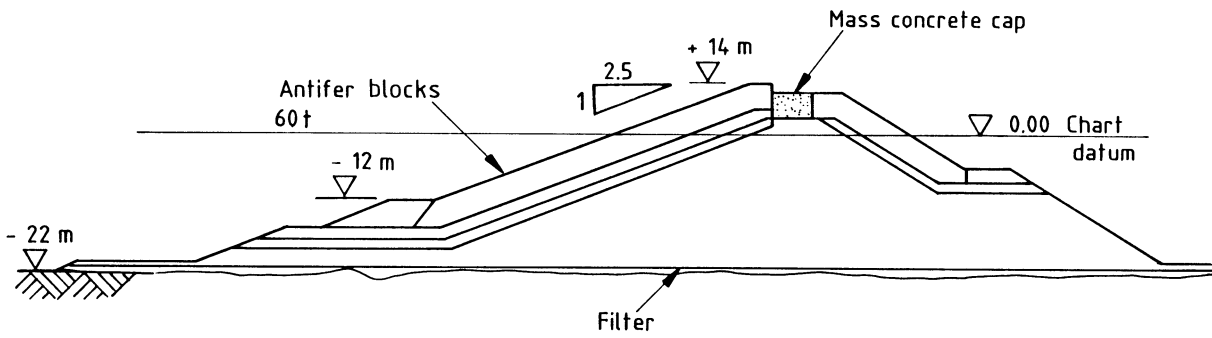

(c) Sines, Portugal: East breakwater

Figure 6 — Examples of rubble mound breakwaters with underlayers



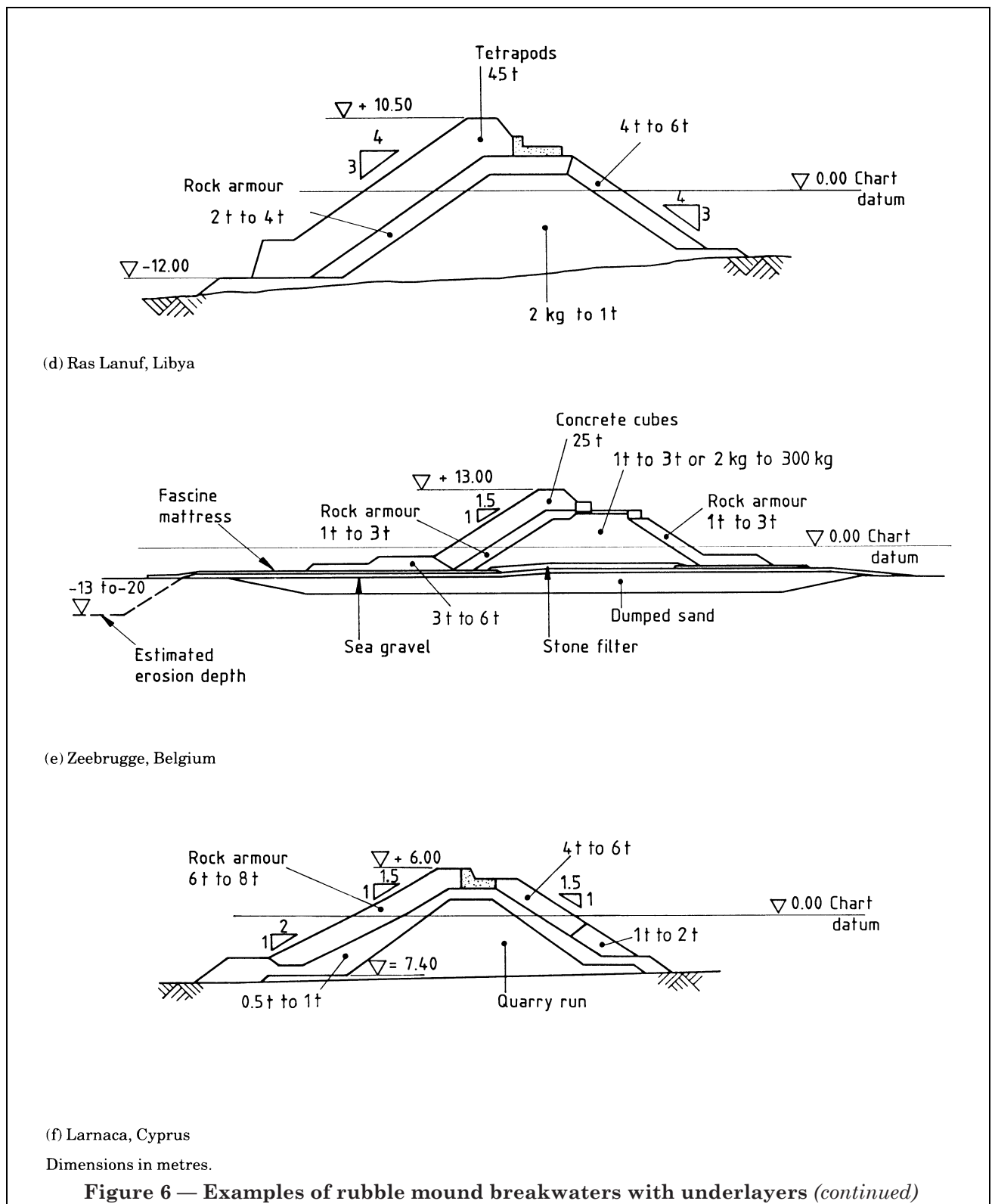

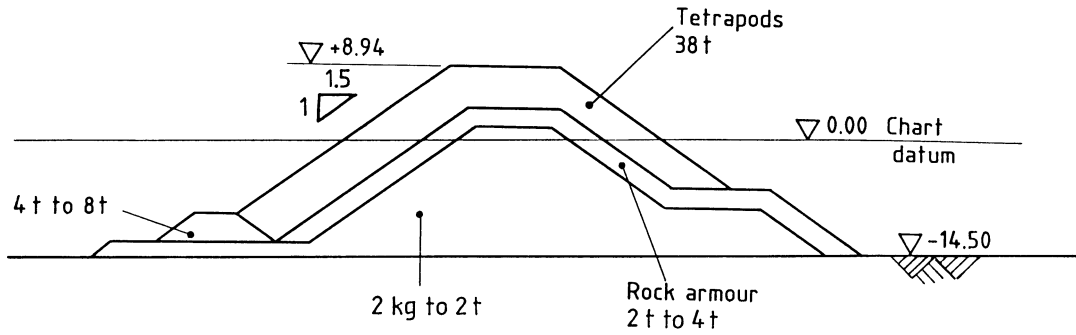

(g) Benghazi, Libya

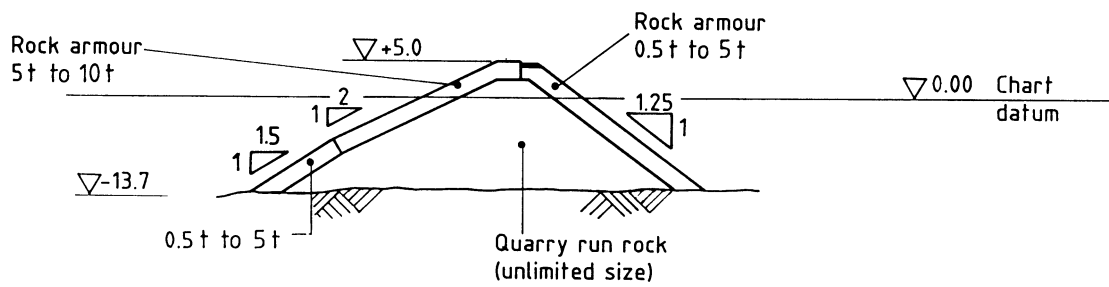

(h) Tema, Ghana

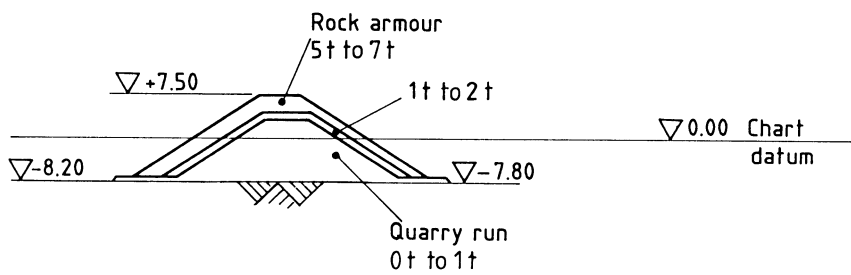

(j) Khassab, Oman

Dimensions in metres.

**Figure 6 — Examples of rubble mound breakwaters with underlayers (concluded)**

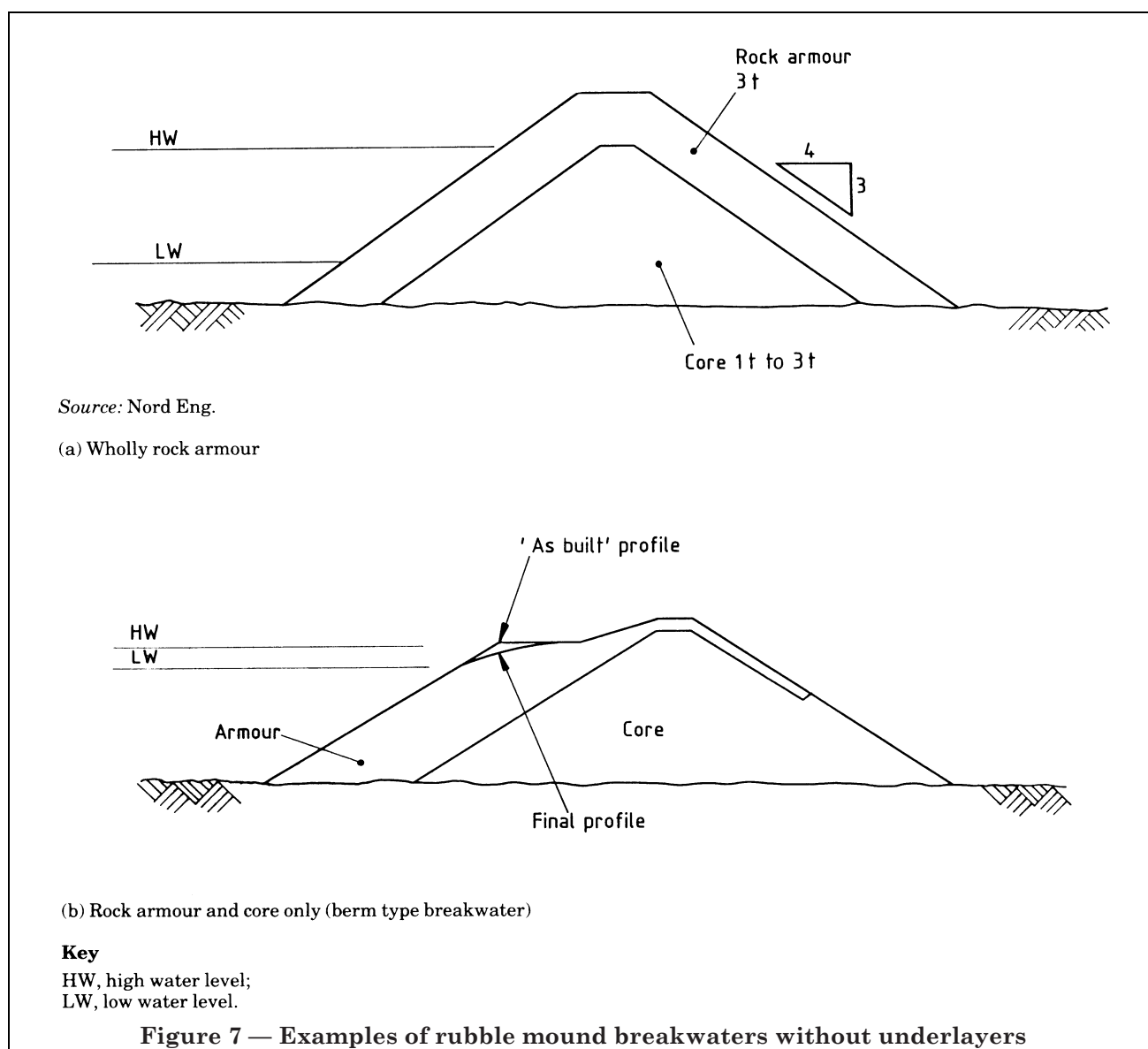

It is important, for economy, to design the cross section so that the greatest range of rock products arising from quarrying operations can be used. The sizing of the primary and secondary armour can leave an intermediate range of unutilized material. This could be used for the following:

- armour on the lower face, below the level at which the primary armour terminates;
- a toe at bed level, in conjunction with a suitable underlayer;
- armour on part of the rear face.

Another use for such intermediate material can be provided by varying the design of the cross section as depths increase from the shore or where the alignment or offshore bathymetry is such that parts of the structure are less exposed to wave attack.

Some designs have been used in recent years which avoid the use of underlayers. These are as follows.

- The use of armour rock only for the whole cross section, producing a permeable breakwater.
- The use of a core protected by a very thick layer of relatively small primary armour which is reshaped by wave action into an S-shaped or berm type profile.

NOTE Wave activity behind the breakwater from the transmitted wave limits the occasions when solution (1) can be adopted for general harbour breakwaters.

An example of each type is shown in Figure 7.

Changes in profile are usually required at the seaward end of a breakwater where a roundhead or other structure is provided (see 4.8). Where a sudden change in plan alignment of a breakwater is unavoidable, the resulting concave or convex corner can require a different design to the trunk. A corner can be considered in a similar manner to a roundhead. A concave corner can produce severe wave concentrations and require special consideration of armour stability and overtopping.

#### 4.2.2 Run-up and overtopping

28.2 and 28.3 of BS 6349-1:1984 give a method for estimating wave run-up on slopes armoured with rock, based on regular wave tests.

There appears to be reasonably good agreement between significant wave run-up levels determined from random wave tests and those determined in earlier regular wave tests. The method given in BS 6349-1 can therefore be used to estimate run-up on a rock slope for a range of wave heights assuming a Rayleigh distribution of wave heights for a random sea, which is appropriate for deep water conditions.

A review of wave run-up on steep slopes and the results of more recent model tests for slopes armoured with concrete units under irregular waves are given by Allsop, Franco and Hawkes [18] and by Allsop, Hawkes, Jackson and Franco [19].

For concrete armour units reference should be made to the run-up characteristics of the particular unit selected.

If run-up calculations indicate that overtopping will occur the quantity of water should be assessed. There are at present no reliable analytical methods of determining the quantity of overtopping water.

The results of hydraulic model tests using random waves to determine overtopping discharges for various profiles of impermeable sea walls are given by Owen [20], and can be applied to breakwaters in shallow water where waves break on the structure.

Further hydraulic model test results for sea walls are given by Jensen and Sorenson [21] for different crest profiles and crest structures as well as a limited number of breakwater cases.

The effects of overtopping range from small amounts of water causing inconvenience or danger to persons on the crest to major overtopping causing waves to develop on the lee side. Criteria for the former are given in section 3.

When major overtopping is accepted the amount of wave transmission to the lee side may be estimated from Figure 8 and Figure 9 and reference may also be made to Powell and Allsop [22].

Whilst preliminary design can be based on these methods, hydraulic model tests of the design section using irregular waves should be carried out for final design in cases where run-up and overtopping are important. (See 3.6.5.2)

#### 4.2.3 Overall stability

The overall stability of a rubble mound breakwater involves both the structure and its foundation, and the effects of both static and dynamic loadings. Dynamic loadings are caused by earthquakes or by wave action and their effects are influenced by long term changes to the structure and its foundations such as settlement or scour of the sea bed.

Reference should be made to clause 54 of BS 6349-1:1984 for general advice on the slope stability aspects and the influence of changes in pore water pressure. These changes in pore water pressure in the mound and the underlying soil are probably the most important factors for overall stability and yet are the least well documented at present. For example, increase in pore water pressure effectively reduces the angle of friction between particles and hence reduces the slope stability.

Figure 10 shows significant failure modes of the various elements of a rubble mound breakwater.

Settlement of the foundation will cause deformation of the whole structure. This can cause fracturing of some types of armour unit and failure of the armour layer. Settlement, even without adverse structural effects, increases the wave forces on the crest structure and the amount of overtopping.

Slumping could occur due to wave induced build-up of pore water pressure in a core containing excessive fine material, particularly where long period waves occur. There is no established design procedure but methods of examining this are suggested by Barends [23] and Allsop and Wood review the subject [24].

Most hydraulic model testing carried out to date has only been carried out for a limited range of permeabilities but clearly shows an increase in stability of armouring with a more permeable core [25, 26]. Insufficient work has been carried out to give quantitative guidance on the increase in stability.

The stability of the armour against sliding on the underlayer is affected by the coefficient of friction between the layers, and this increases when the ratio of underlayer size to armour size is larger [27].

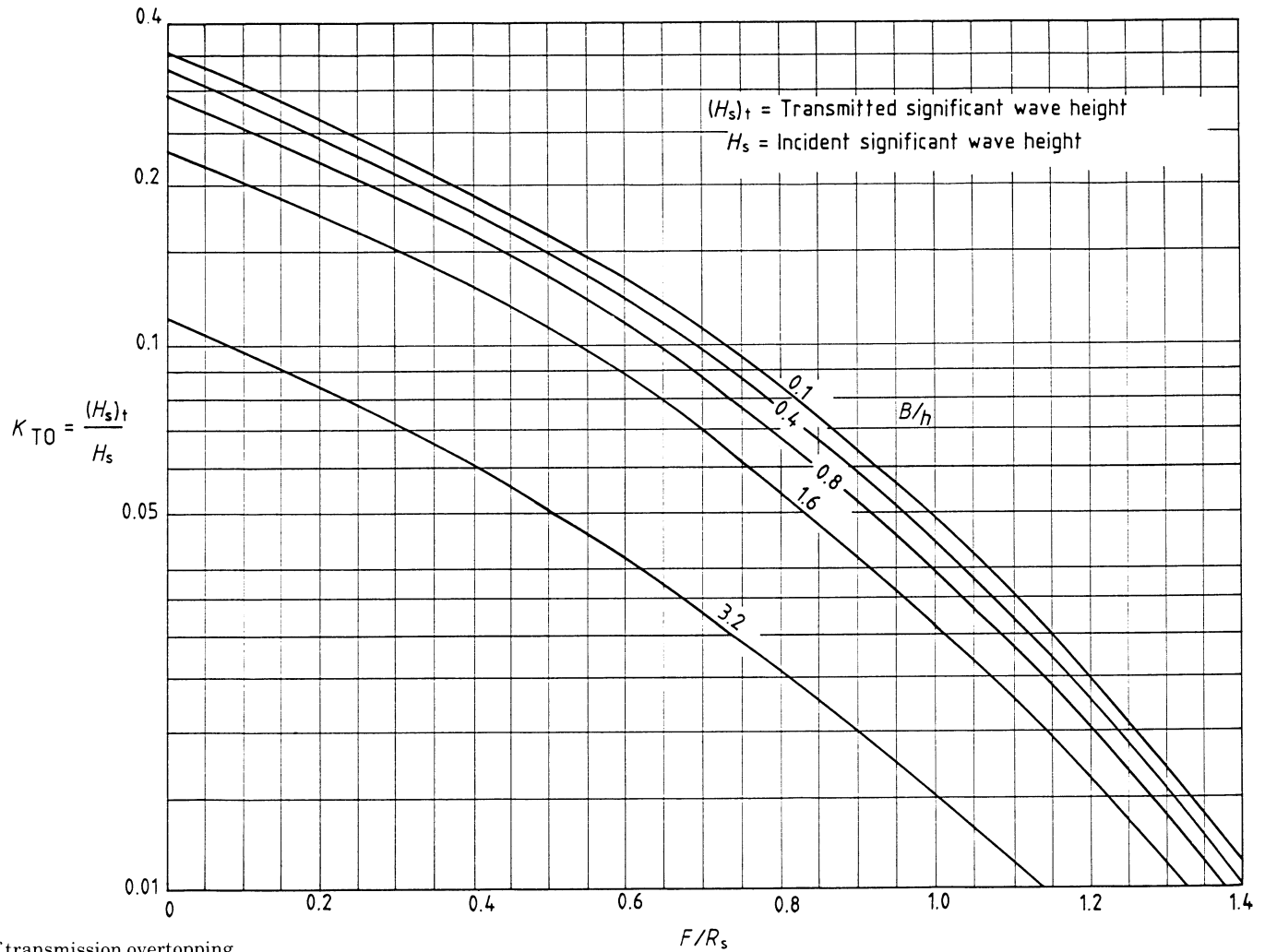

**Key**  
 $K_{TO}$ , coefficient of transmission overtopping  
 $F$ , freeboard  
 $R_s$ , significant run-up  
 $B$ , width of breakwater  
 $h$ , height of breakwater above sea bed level  
 Source: [8]

**Figure 8 — Transmitted wave height due to overtopping relative to freeboard of rubble mount**

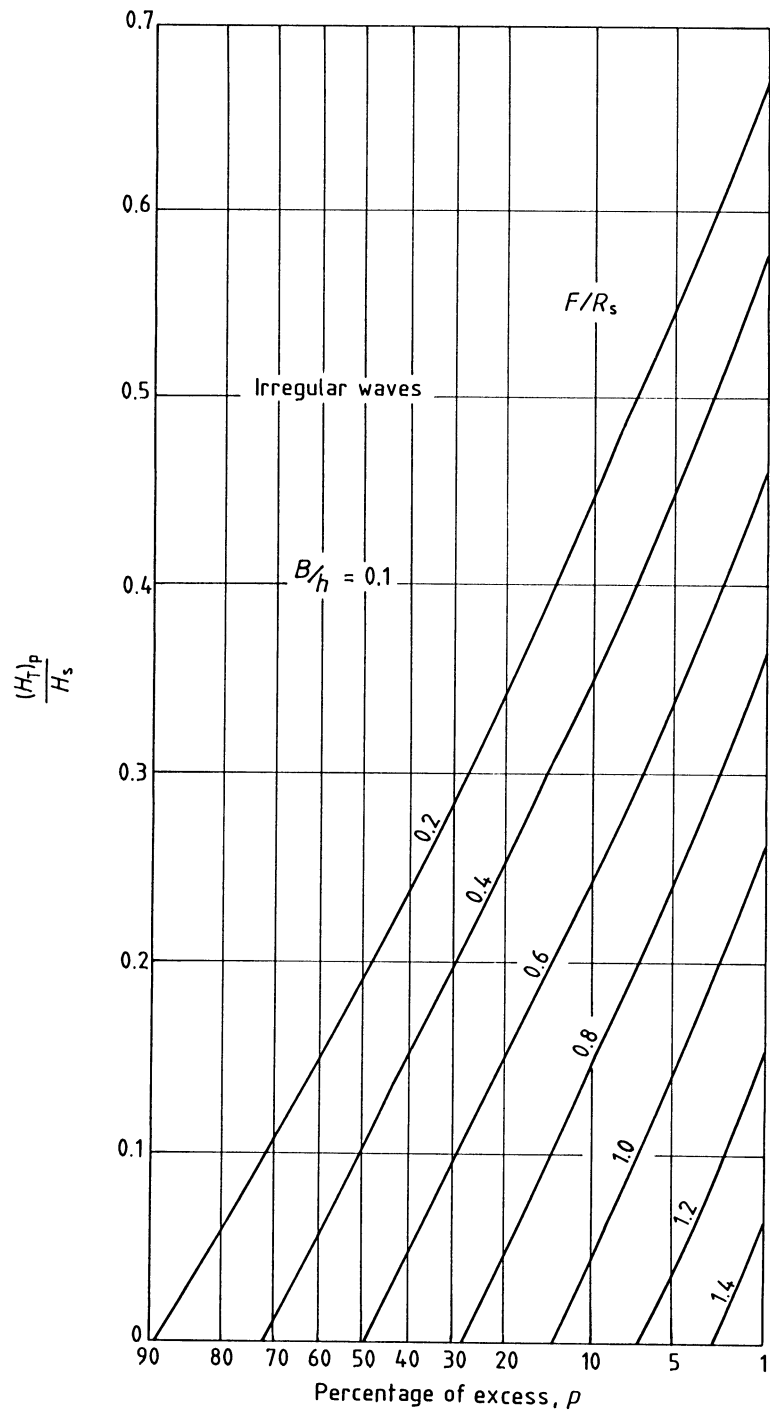
**Key**

$(H_T)_p$ , wave height equal or exceeded  $P$  % of the time

$H_s$ , incident significant wave height

$F$ , freeboard

$R_s$ , significant run-up

$B$ , width of breakwater

$h$ , height of breakwater above sea bed level

Source: [8]

**Figure 9 — Transmitted wave height due to overtopping as a function of percentage exceedence**

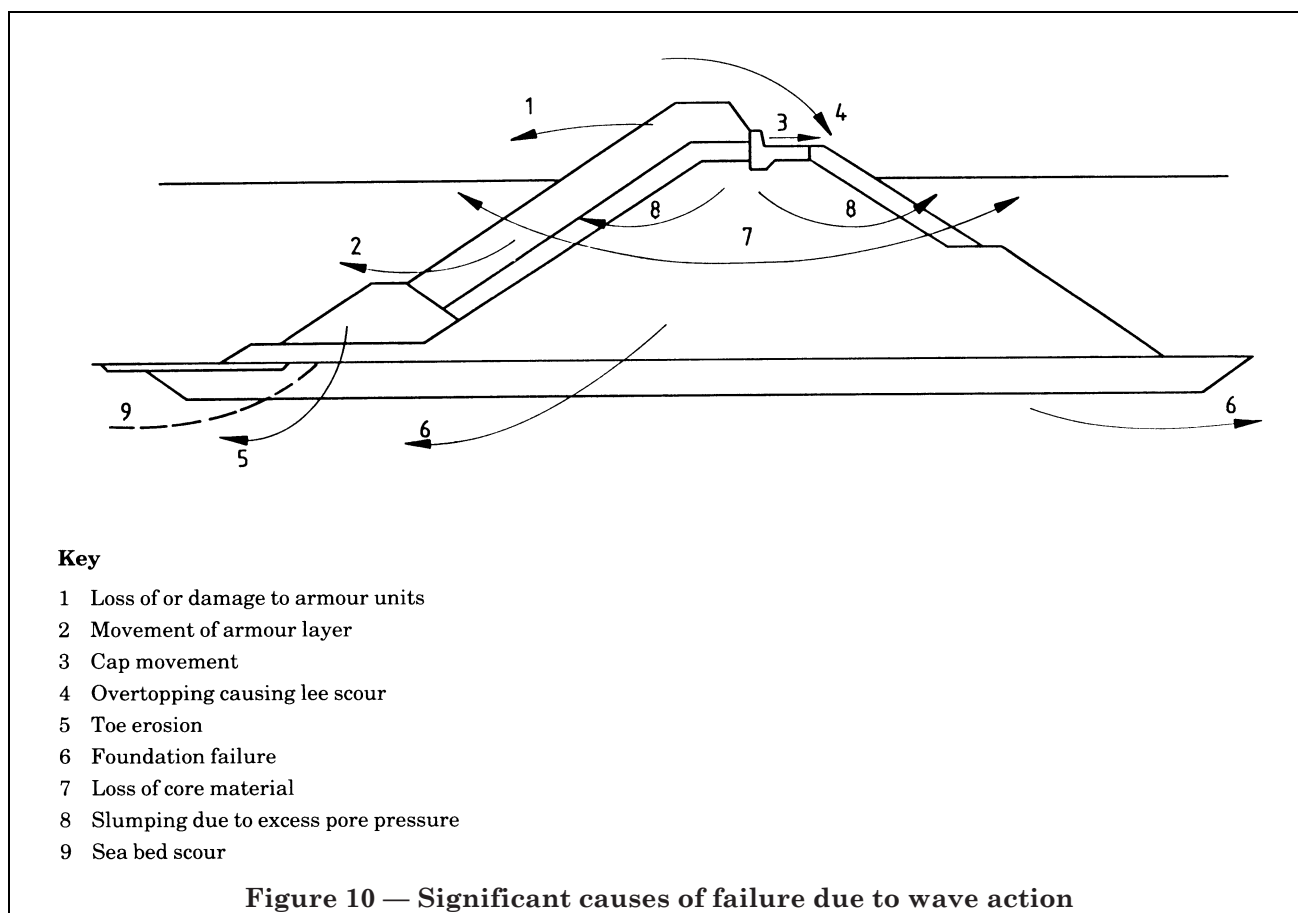

**Figure 10 — Significant causes of failure due to wave action**

Recent research into other factors which influence the shear strength of rubble fill is given by Barton and Kjaerusli [28] and by Charles and Soares [29]. Geotechnical instability of breakwater slopes under wave action is unlikely to occur suddenly because pore pressures may only be high enough for critical conditions to occur for a short time in each wave period. Small increments of movement are more likely to occur leading to a progressive flattening of slopes.

Where fill material is to be placed behind a breakwater, the effects of the resulting loads in the structure should be taken into account in stability calculations.

### 4.3 Design of armour

#### 4.3.1 General

The armour layer is probably the most important feature of a rubble mound breakwater since damage or failure can lead to failure of other parts (such as collapse of the crest structure erosion of underlayers and core material).

The armour layer has an important influence on wave reflections, run-ups and overtopping, which affect toe details, underlayers and crest details. The armour layer is also often the controlling factor in the selection of crane capacity for construction.

In this section the applications, limitations and design methods available for rock and concrete armour are described.

#### 4.3.2 Rock armour

The use of rock armour is limited by the largest size of rock which can be economically produced. This is commonly found to be in the range 10 t to 15 t but in many rock formations the limiting size is much smaller and it can be necessary to quarry very large quantities to produce a small percentage of the largest stones.

The size of rock required can be reduced by using flatter slopes but extra quantities of material are then required for core, underlayer and armour.



Placing small rocks to a flat slope can be expensive. An alternative which can be considered is to place a steep face with a sufficient thickness of material in the armour layer to allow for natural flattening of the slope by wave action [30]. If this is to be successful it is essential that the rock is able to withstand the resulting movement without breakdown. Some rounding due to abrasion can also occur and this can reduce the stability of the armour.

### 4.3.3 Concrete armour units

#### 4.3.3.1 Types of unit

Many different types of concrete armour unit have been developed but few have been adopted for general use. Illustrations of the most commonly used units are given in Figure 11. Nearly all are of mass concrete construction and can be broadly classified as random placed or regular pattern placed.

a) *Random placed units.* The majority of concrete armour units are of this type, placed normally in two layers but sometimes in a single layer. They range from massive approximately cubical units (e.g. cubes, Antifer blocks) through intermediate types (e.g. Accropodes, Akmons) to the more complex forms (e.g. Tetrapods, Stabits, Dolosse). The massive types are intended to function in a similar way to natural rock, while the more complex units depend for hydraulic stability upon a degree of interlock between units.

True random placing is difficult to achieve, and inevitably results in some units not being as well interlocked as others. Although placing to a predetermined layout is usually specified for interlocking units, this also is difficult to achieve except under favourable conditions of good underwater visibility and calm seas. The result is usually a semi-random pattern.

The more complex armour units were designed to achieve greater stability by obtaining a high degree of interlock and also to reduce wave forces by increasing the voids in the armour layer.

Table 5 gives typical values of percentage voids for certain units. The greater percentage of voids gives a greater dissipation of wave energy and reduces the weight of the unit required for hydraulic stability compared with the requirements for the simpler massive units. The reduced weight requires an increase in interlock capability to achieve stability of the armour mass.

The reduced weight can also result in rocking of units under wave action, particularly those which rely most on interlock, leading to impact loading between adjacent units. If breakage is caused, interlock can be destroyed. Movement of the more mobile broken parts can cause further impacts and the possibility of progressive failure arises.

b) *Regular pattern placed units.* Examples of this type are the Cob, the Shed and the Seabee. The stability of these units depends upon the placing pattern, the support provided by the toe and crest structures and the preparation of the underlayer. The units are placed in a single layer to form a continuous revetment.

**Table 5 — Typical values of voids for armour**

Unit	Voids
	%
Quarry stones (rough angular random, placed in double layer)	37
Tetrapods	50
Stabits	52
Dolosse	56

Information on the use of particular armour units should be obtained from literature published by the originator or licensee of the unit. This should be reviewed in the light of published experience of their use and the guidance given in this section.

Guidance on the materials and manufacture of concrete armour units is given in 4.10 and 4.11.

Steel reinforcement has rarely been incorporated in armour units, where design has not been based on conventional structural principles. Opinions are divided on the effectiveness of reinforcement in armour units as, if the steel corrodes, the adverse effect on durability can outweigh any advantages in using it (see section 7 of BS 6349-1:1984). Fibre reinforcement appears to have some slight benefit in reducing cracking, but reports on the performance to date have been inconclusive.

#### 4.3.3.2 Effect of size on strength of units

The design of large armour units should take into account the fact that the intrinsic strength of units decreases with increasing size. Major failures have occurred with complex shaped units, and all aspects of design, manufacture and placing should be considered very carefully before proceeding to construction [31].



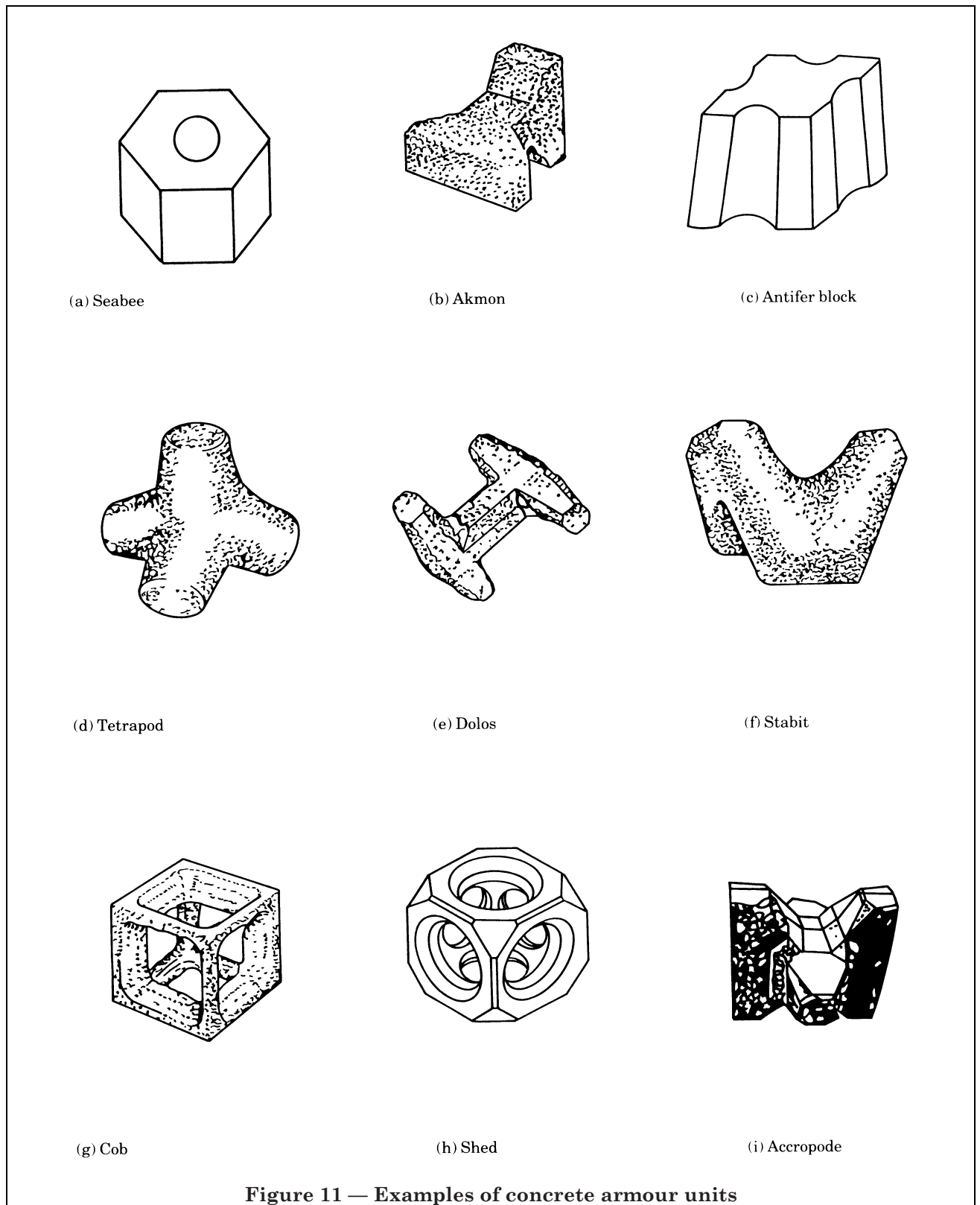

Concrete armour units are subjected to the following load conditions.

- a) *Construction loads*. These occur during manufacture, transport and placing. Cracks resulting from stresses arising during manufacture (e.g. shrinkage or thermal cracks in large units) or other conditions can significantly reduce the capacity of the unit to resist loads applied subsequently.
- b) *Static loads*. These are due to self-weight and interlocking forces, support of overlying units and jamming of units caused by settlement of core and underlayer.
- c) *Hydraulic loads*. These are due to wave breaking, uprush and downrush and can be transferred by bearing contact to another unit.
- d) *Dynamic loads*. These are due to rocking and displacement of units resulting in impact on other units, and are probably the most significant, although they are not necessarily the highest loads imposed on units. Repeated loading due to rocking can result in breakage due to fatigue [32].

More fundamental research is required to enable the loads to be quantified more accurately. There is at present insufficient information for stresses in concrete armour units to be calculated with confidence.

Hydraulic model tests have been carried out using instrumented units to measure various parameters but at present this is not a normal laboratory test (see 3.6.3).

Full scale dynamic loading tests can be carried out on site. These can take the form of drop tests in which a unit is dropped from varying heights at particular attitudes onto a concrete or rubble surface. Impact tests on a fixed unit have also been used. Relatively few examples of this type of testing are available to date. Results from these tests have shown that flexural strength may be reduced by 60 % after 6 impacts to 10 impacts. Further information on testing and assessment of strength is given by Silva [33], Grimaldi and Fontana [31] and Burcharth [34].

It has been suggested that the maximum size of concrete armour units be limited to the values given in Table 6. Examples can be found of the successful use of larger units but, in the present state of knowledge, the degree of caution implied by the limits given appears justified.

**Table 6 — Suggested maximum sizes of concrete armour units**

Unit	Maximum size
	t
Dolos	15
Stabit	20
Tetrapod	30
Antifer block	60

#### 4.3.4 Design formulae

##### 4.3.4.1 Introduction

The relationship between wave height and the weight of rock armour in rubble mound breakwaters has been the subject of a large number of empirical or semi-empirical formulae compiled over many years.

Sixteen formulae were identified by PIANC (Permanent International Association of Navigation Congresses) [35] in 1976. The most commonly used has been Hudson's formula, which is discussed in 4.3.4.2. This was developed for rock armour but has also been applied to concrete armour units.

As a result of recent research in Holland into static and dynamic stability of rubble mound revetments and breakwaters, further formulae have been proposed by Van der Meer. These formulae are discussed in 4.3.4.3, and take account of factors not included in Hudson's formula.

Considerable uncertainty exists over the ability of any of the formulae to cover all the effects of hydrodynamic-structure interaction in an armour layer. Hudson's formula is at present the most widely used and despite its limitations has the advantages of relative simplicity and the largest accumulation of experience in its use.

##### 4.3.4.2 Hudson's formula for rock armour

Hudson's formula was developed for rock armour by extensive hydraulic model testing using regular waves [36].

Hudson's formula is:

$$W = \frac{W_r H_D^3}{K_D X^3 \cot \alpha} \quad (2)$$

where

$W$  is the weight in air of an individual armour unit in the primary cover layer, in newtons;

$W_r$  is the unit weight (saturated surface dry) of armour unit in newtons per cubic metre;

$H_D$  is the design wave height at the structure site, in metres (see below for recommended value);

$W_w$  is the unit weight of water in newtons per cubic metre (fresh water = 9 810 N/m<sup>3</sup>; seawater = 10 050 N/m<sup>3</sup> typical value);

$X$  is the relative mass density of armour unit, relative to water at the structure, i.e.  $(W_r/W_w) - 1$ ;

$\alpha$  is the slope angle;

$K_D$  is a dimensionless stability coefficient.

The equation was derived for seaward armour stability in conditions when the crest of the structure is high enough to prevent major overtopping. The formula should not be used for a low crest breakwater.

The design wave height  $H_D$  was based on model testing using regular waves. There is no simple method of comparing the results of laboratory tests carried out using regular and random waves. Laboratory studies have shown that the equivalent regular wave height can range between the significant wave height  $H_s$  of a random wave train and higher values such as  $H_{1/10}$ , the mean of the highest one-tenth of wave heights.

Current opinion is that, for non-breaking conditions,  $H_{1/10}$  at the site of the structure should be used in equation (2). For conditions where the  $H_{1/10}$  waves would break before reaching the breakwater, the wave height used for preliminary design should be  $H_b$  (the breaking wave height) or  $H_s$ , whichever has the more severe effect.

For guidance on distribution of wave heights and breaking conditions, refer to section 4 of BS 6349-1:1984.

Cover layer slopes steeper than 1 : 1.5 are not recommended for rock armour and the formula is unreliable as the natural angle of repose is approached. In addition, the formula is not generally applicable to flat slopes (see Table 7). Hedar's formula [37] has been developed to avoid this limitation and can be of assistance in such cases. This formula, like Hudson's formula, was developed for regular waves only.

Values of  $K_D$  for use in Hudson's formula for the preliminary design of rock armour are given in Table 7; they have been taken from data published in 1984 [8]. The stability coefficient  $K_D$  is varied in breaking waves, in structure head and in some cases in armour slope and thickness of armour layer.

The values of  $K_D$  quoted do not take account of differences in the following factors, which can be expected to have some influence on stability:

- a) wave period and spectrum;
- b) shape of armour stone;
- c) manner of placing armour;
- d) degree of interlock of armour;

e) angle of incidence of wave attack;

f) size and porosity of underlayer material;

g) distance below still-water level that the armour extends down the face slope;

h) core height relative to still-water level.

Where, as is usual, run-up reaches the top of the armour slope, the effect of the crest structure and its elevation above still-water level relative to wave height is also not taken into account.

Values of  $K_D$  published in the *Shore Protection Manual* [8], from which those in Table 7 have been selected, should not be used without a careful review of all the factors involved. They, in particular the values used for breaking waves, have been revised from time to time in the light of experience.

The  $K_D$  values indicated correspond to a damage level of up to 5 %. Percentage damage is based on the number of rocks displaced from the zone of potential armour removal for a specific wave height, generally between the crest centre line and bed level or one design wave height below still-water level. In many circumstances this level of damage can be unacceptable, in which case a more robust design should be considered.

Consideration should be given to the possibility that only loose placing of the armour stone will be achieved. This might result in lower initial stability and in settlement of the armour layer during the first storm after construction.

#### 4.3.4.3 Other formulae for rock armour

New formulae have recently been proposed as a result of a research programme on the stability of rubble mound revetments and breakwaters carried out at the Delft Hydraulics Laboratory and reported by Van der Meer [25]. As research proceeded the constants shown in equations (3) and (4) were modified; those shown are based on research carried out up to 1988 (see [38]). The model tests used irregular waves, and were based closely on the methods and data given by Thompson and Shuttler [39]. They are described as practical design formulae for rock armour, although experience in use is limited at present. It is important to recognize that these are empirical formulae which should not be used for conditions outside the experimental limits.

Table 7 — Suggested  $K_D$  values<sup>ab</sup> for rock armour using Hudson's formula

Rock shape	$n^c$	Placement	Structure trunk		Structure head		Cot $\alpha$
			$K_D^d$ for a breaking wave	$K_D^d$ for a non-breaking wave	$K_D$ for a breaking wave	$K_D$ for a non-breaking wave	
Smooth rounded	2	Random	1.2*	2.4	1.1*	1.9	1.5 to 3.0
Smooth rounded	> 3	Random	1.6*	3.2*	1.4*	2.3*	— <sup>e</sup>
Rough angular	2	Random	2.0	4.0	1.9*	3.2	1.5
					1.6*	2.8	2.0
					1.3	2.3	3.0
Rough angular	> 3	Random	2.2*	4.5	2.1*	4.2*	— <sup>e</sup>

<sup>a</sup> CAUTION. The  $K_D$  values shown with an asterisk are unsupported by test results and are only provided for preliminary design purposes.  
<sup>b</sup> Application: 0 % to 5 % damage and minor overtopping.  
<sup>c</sup>  $n$  is the number of layers.  
<sup>d</sup> Applicable to slopes ranging from 1 : 1.5 to 1 : 5.  
<sup>e</sup> Until more information is available on the variation of  $K_D$  value with slope, the use of  $K_D$  should be limited to slopes ranging from 1 : 1.5 to 1 : 3.  
Source: [8]

These formulae take account of the following variables which are not included in Hudson's formula:

- wave period;
- surf similarity parameter;
- breaking wave conditions;
- duration of storm;
- permeability of core.

The formulae are as follows.

For plunging (breaking) waves, applicable for values of  $\xi_m$  less than 2.5 to 3.5

$$(H_s/XD_{n50}) \sqrt{\xi_m} = 6.2P^{0.18}(S/\sqrt{N})^{0.2} \quad (3)$$

and for surging (non-breaking) waves, applicable for  $\xi_m$  values greater than 2.5 to 3.5

$$(H_s/XD_{n50}) = 1.0P^{-0.13}(S/\sqrt{N})^{0.2} \sqrt{(\cot \alpha) \xi_m} P \quad (4)$$

where

$H_s$  is the significant wave height at the structure site, in metres;

$D_{n50}$  is the median nominal size (equivalent cube) in metres;

$X$  is the relative mass density, relative to water at the structure;

$\alpha$  is the slope angle;

$S$  is the damage level;

$N$  is the number of waves;

$\xi_m$  is the surf similarity parameters, equal to

$$\frac{\tan \alpha}{\sqrt{(2\pi H_s/gT_z^2)}}$$

$T_z$  is the average zero crossing wave period in seconds;

$P$  is the core permeability factor;

$g$  is the acceleration due to gravity (9.81 m/s<sup>2</sup>),

It should be noted that the design wave height in equations (3) and (4) is  $H_s$  while that currently recommended for equation (2) is  $H_{1/10}$ .

Stability is a minimum at the transition between plunging and surging conditions.

Damage level  $S$  is defined as  $S = A/D_{n50}^2$  where  $A$  is the eroded cross-sectional area of the profile.

Alternatively it can be considered as the number of  $D_{n50}$  sized stones displaced over a  $D_{n50}$  wide strip [25]. "Initial" damage, defined as one to three stones extracted from the  $D_{n50}$  wide strip is said to correspond to the 5 % damage level referred to in 4.3.4.2. However, this depends upon the size of stones in relation to the length of the strip.

As discussed by Powell [40], the main problem when using equations (3) and (4) is the assessment of the core permeability factor  $P$ . The values of  $P$  suggested range from 0.1 for a relatively impermeable core up to 0.6 for a virtually homogeneous rock structure. The choice of  $P$  to be used in design depends on judgement and it is recommended that the permeability be underestimated rather than overestimated. Similarly, the sensitivity of the final calculated rock weight to the assumed values of  $P$  should always be checked.

When using the formulae, unless data available allow a more detailed assessment to be made, it has been suggested that the following values be used.

$N = 3\ 000$  to  $5\ 000$  (research has suggested that this storm duration is sufficient for preliminary design purposes)

$S = 1$  to  $3$  (roughly equivalent to  $5\%$  damage)

$P = 0.3$  (unless an open core is to be provided).

#### 4.3.4.4 Use of Hudson's formula for concrete armour units

Hudson's formula has been used for random placed concrete armour units by selection of appropriate values of  $K_D$  derived from hydraulic model tests. This approach can be dangerous because many concrete units rely for their stability upon factors which are not included in Hudson's formula. In particular no account can be taken of the part played by interlocking between the units in the stability of an armour layer. The effect of such interlocking is to increase the apparent stability of a unit allowing the use of lighter weights than would otherwise be the case for a given wave height. However, an increase in wave height can have a greater effect on reducing the stability of these lighter, interlocked units than on bulky units. Particular attention should therefore be paid to the effect of waves larger than the design wave upon units which interlock in order to ensure an adequate reserve of stability. Model tests also neglect the effect of structural damage to a unit.

It is recommended that in the design of concrete armouring Hudson's formula should be regarded as no more than a device for comparing the stability of different types of unit, and  $K_D$  values published from previous hydraulic model testing should be used only as guidance for preliminary selection of armour sizes for full hydraulic model testing. It should be noted that Hudson's formula is not applicable to regular pattern placed armour units.

Values of  $K_D$  suggested for preliminary design of the structure trunk are given in Table 8. However, the maximum sizes suggested in Table 6 should also be taken into account.

**Table 8 — Suggested preliminary  $K_D$  values for concrete armour units in structure trunk**

Unit	$K_D$
Dolos	10 to 12
Stabit	10 to 12
Tetrapod	6 to 8
Antifer block	6 to 8
Accropode	10 to 12

The  $K_D$  values suggested in Table 8 are taken from recent testing experience and are intended to correspond to acceptable limits of movement under hydraulic forces so that the final design will have a margin of safety against breakage of units. It is emphasized, however, that, because of the difficulty of modelling the strength of concrete units, movement of the units (e.g. rocking) during model testing should be monitored to provide the basis for an assessment of prototype damage (see 3.6.5.2.1). The results of model tests have suggested that some units, e.g. Tetrapods and Dolosse are less stable when subjected to oblique wave attack than to perpendicular wave attack. It is possible that the suggested values of  $K_D$  for concrete armour units will therefore need to be reduced further on this account.

Lower  $K_D$  values than those suggested should also be used if good interlock between the units cannot be assured, such as where a flat slope is adopted or where control of placing is poor.

There is no definite guidance on this particular point and it is recommended that if slopes flatter than 1 in 3 are considered then great care should be taken and responses should be checked by hydraulic testing.

#### 4.3.5 Thickness and extent of armour layer

The thickness of random placed rock armour should normally be designed to contain a double layer of rocks, and may be taken as  $2D$ , where  $D$  is the nominal size (equivalent cube). For a single layer rock armour, the corresponding layer thickness is about  $1.15D$ .

The thickness of random placed concrete units depends on the method of placing. Normally two layers of units are provided but with some units (e.g. Accropodes, Stabits) one layer is used. In all cases the method of placing should be based on careful testing or, where adequate testing has already been undertaken, as recommended by the originator or licensee.

For many units, published literature gives guidance on the total number required per unit area of the slope. This is a better method of defining the armour layer required than specifying thickness. It will normally be necessary to pre-plan the placing of such units and control the operation very carefully to obtain a satisfactory armour face.

For regular pattern placed units a single layer is usual.



The armour layer should extend below minimum sea level to a depth equal to 1.5 to 2.0 times  $H_s$ . In deep water structures, the slope below the level at which the primary armour terminates should be protected by stone having a size not less than that required for the underlayer (see 4.4).

Toe protection should be provided as described in 4.6.

#### 4.3.6 Crest and rear face armour

No analytical methods are available for determining the size of rear face armour, nor of crest armour in breakwaters which are designed to be overtopped and do not have a crest structure. The size required depends principally on the amount of overtopping which results from wave run-up. This in turn is affected by freeboard and crest width. For preliminary design the size of crest armour should be assumed to be no less than the main armour size. Hydraulic model tests are necessary for severely overtopped or submerged breakwaters and the results of these can show that larger armour is required at the crest.

The crest should be of sufficient width to accommodate at least three crest armour units where the armour is continued over the crest.

Crest stability, particularly for some concrete units, can be less than the stability of the main face armour due to the smaller effect of gravitational forces and less interlock. On the rear face continuous downrush forces may also result in greater instability. Rear armour sizes can have to be as large as or larger than main armour. Smaller armour can be used on the rear face if overtopping is not large or a concrete crest structure is designed to throw overtopping water clear of the top of the rear face so that its force is cushioned by water.

## 4.4 Design of core and underlayers

### 4.4.1 General considerations

The main function of the breakwater, the prevention of passage of waves, is normally performed chiefly by the core. It is generally necessary to provide one or more underlayers as filters to prevent the core material from being drawn out through the armour layer. The sizes of material in the core and underlayers and armour should therefore be correctly related [27].

In addition it is generally necessary to design underlayer and core to resist some degree of wave action during construction (when it will rarely be possible to leave them exposed for even the minimum practicable period without risk of wave attack).

### 4.4.2 Grading of core material

The ideal core of a rubble mound has a uniform grading over a wide range of sizes so that, except in the immediate vicinity of exposed faces, fine material cannot be drawn out by wave action. This will ensure a low permeability in respect of wave transmission.

In practice the placing procedures and wave action during construction can be expected to modify the disposition of particles of core material, so that it is unlikely that a uniformly graded core will result, even if uniformly graded material is provided.

Segregation in trucks and by tipping can result in larger rocks rolling down the face and smaller stones remaining at the top. This is more easily controlled above water, where the core is of minimum width and the importance of good grading is greater. However, care is needed to prevent an excess of fines here, as they can be lost gradually, resulting in settlement of the rock mound.

Larger material on the outer face of the core mound below water is beneficial for temporary stability and as a foundation for the underlayer, and can be caused by dispersal of finer material due to wave action. Even if segregation is reduced by placing core from rock trays, this self-sorting will probably occur, but there are no reliable measurements of the extent to which core grading distribution is affected by the placing methods and the construction environment. Construction is discussed further in 4.11, but it is important that there should be control of the quality of core material.

Specifications should be prepared in relation to the particular quarry, the breakwater cross section and construction procedures. The maximum size of core material will depend upon the quarry and the design of the underlayers and armour stone. A maximum size of 1 t will often be appropriate but larger sizes up to 3 t have been adopted for large structures exposed to swell during construction.

Opinions are divided regarding the limit to be placed on fine material in the core. Quarry overburden and rubbish should be excluded, but rock dust will always be present on the quarry floor and care should be taken to minimize the inclusion of dust in picking up, loading and transporting core material. Dust will normally be washed out of the core underwater and is unlikely to affect breakwater stability and function, although it can cause environmental pollution.

Core material is normally loaded by shovel from the quarry floor after armour and underlayer rocks have been picked from the yield of the face after blasting. It is sometimes possible to obtain the required grading by selection during loading with the unwanted fines being excluded.

It is also possible to tip the core material over a screen to remove fine material (from concrete aggregate sizes of up to 1 kg for example). This is costly and in any case does not control the uniformity of grading. Grading can be checked from sample loads, but quality control is normally by visual inspection only.

In practice therefore the specification of limits to fine material in the core is a matter of judgement, both as to what is required and as to the methods of achieving it. It could be advisable to specify the proportion of fines below, for example, 1 kg as not more than 1 % of the total mass. Material between 1 kg and 10 kg should also be restricted; a range of between 5 % and 10 % of the total mass could be appropriate.

#### 4.4.3 Sizing of underlayer material

The function of the underlayer(s) is as follows:

- to act as filter between core and armour layer;
- to provide a stable bed for the armour layer;
- to dissipate wave energy passing through the armour layer;
- to protect the core material from moderate storms during construction.

The design of underlayers has to take account of gradings of both the armour and the core, and more than one underlayer could be needed to meet the filter criteria suggested in this subclause.

An underlayer usually comprises a single sized material of nominal unit mass, but graded material can be used, and the following should be interpreted approximately in each case.

The nominal weight of underlayer rock is usually taken as not less than one-tenth of the nominal weight of armour, if this is natural rock [8]. The size of individual underlayer stones should be within  $\pm 30$  % of the nominal weight selected, i.e. a weight range of about 2 : 1 of which at least 50 % should be above the nominal weight.

For concrete armour units, examples of which are shown in Figure 11, the weight of rock in the first underlayer should be derived from published results based on experience and model tests. Data for some units is given in Table 9.

**Table 9 — Weight of rock in underlayer for some concrete armour units**

Armour unit (of weight $W$ )	Weight of rock in underlayer
Dolos	$W/5$ to $W/10$
Stabit	$W/5$ to $W/10$
Tetrapod	$W/10$ to $W/20$
Accropode	$W/7.5$ to $W/15$

Where such information is not available it has been suggested that the underlayer be selected so as to satisfy the following relationship [27]:

$$\frac{D_{85(\text{underlayer})}}{D_{\text{voids}(\text{armour})}} > 2$$

where

$D$  is the nominal size (equivalent cube);

the suffix “85” refers to the percentage of stone passing that size;

the suffix “voids” refers to the maximum size of voids.

Regular pattern placed units may require a relatively smooth surface for placing and smaller size underlayer stones are sometimes necessary for profiling. Present practice is to use a gravel stone with a maximum size equal to about two-thirds of the diameter of the aperture in the unit. Reference should be made to tests and experience with the particular unit.

For the filter action between successive underlayers and between the lower underlayer and the core a number of relationships have been suggested. These are based on experience with unidirectional flow and do not necessarily take full account of varying wave induced water movements, about which uncertainty exists.

A modified version of the Terzaghi filter criteria [24] can be used to assist in sizing underlayers in relation to core, as follows:

$$\frac{D_{15u}}{D_{85c}} \leq 4 \text{ to } 5$$

$$4 \leq \frac{D_{15u}}{D_{15c}} \leq 20 \text{ to } 25$$

where

$D$  is the nominal size (equivalent cube);

the suffix “c” refers to core;

the suffix “u” refers to underlayer;

the suffixes “15” and “85” refer to the percentage of stone passing that size.

Practical limits of quarry yield, number of layers and construction operations should also be taken into account.

The criteria for rip-rap embankment protection [39] can also be of assistance. They can be applicable to core containment using rip-rap of wide grading but not to single size armour and underlayer. The criteria are expressed in the form:

$$\frac{D_{15r}}{D_{85c}} \leq 4$$

$$\frac{D_{50r}}{D_{50c}} \leq 7$$

$$\frac{D_{15r}}{D_{15c}} \leq 7$$

where

the suffix “r” refers to rip-rap;

the suffix “c” refers to core.

Under cyclical loading caused by wave action it is probable that the reversal of flow within a filter layer will cause some disturbance of the finer material and possible migration through the overlying material.

This can ultimately reach stability after settlement of the layer but it is preferable to adopt a conservative approach which will satisfy both hydraulic and geotechnical stability requirements.

#### 4.4.4 Thickness of underlayers

Each underlayer should be at least two stones thick (see 4.3.5).

The thickness of an underlayer can be determined from the following formula:

$$r = nk_{\Delta} \left( \frac{W}{W_r} \right)^{1/3} \quad (5)$$

where

$r$  is the average thickness of the layer in metres;

$n$  is the number of layers of stones;

$W$  is the nominal mass of rock in newtons;

$W_r$  is the unit mass of rock in newtons per cubic metre;

$k_{\Delta}$  is a layer coefficient.

Typical values of  $k_{\Delta}$  are given in Table 10 which also indicates typical porosities.

With small stone underlayers placed from trays, the thickness should be increased to ensure that an adequate layer is formed underwater.

It is important that the thickness of underlayers should be maintained on the crest of the core, whether the underlayer terminates in front of a concrete crest wall or continues over the top of the core to the rear face.

#### 4.4.5 Filters for reclamation

When a breakwater is protecting reclaimed land adequate filters should be provided to prevent loss of fine material through the core. A number of layers of filter material could be required between the core and retained fill. The material in each layer can be sized in accordance with the following criteria:

a)

$$\frac{D_{15(\text{larger})}}{D_{85(\text{smaller})}} \leq 4 \text{ to } 5$$

$$4 \leq \frac{D_{15(\text{larger})}}{D_{15(\text{smaller})}} \leq 20 \text{ to } 25$$

$$\frac{D_{50(\text{larger})}}{D_{50(\text{smaller})}} \leq 25$$

where

$D$  is the nominal size (equivalent cube);

the suffixes “15”, “50” and “85” refer to the percentage of material passing that size.

b) No filter layer should contain more than 5 % ( $m/m$ ) material passing a 63  $\mu\text{m}$  sieve complying with BS 410.

c) Filter material should be well graded within the specified limits and its grading curve should have approximately the same shape as the grading curve of the protected material.

d) Where the retained fill material contains a large proportion of gravel or coarser material, the filter should be designed on the basis of the grading of that proportion of the protected material finer than a 20 mm sieve complying with BS 410.

e) Where the retained fill is gap graded (e.g. a silty fine sand with some gravel) the coarse particles should be ignored and the grading limits for the filter should be selected on the grading curve of the finer soil.

f) Where a filter protects a variable soil, the filter should be designed to protect the finest soil.

The thickness of filter layers should be ample to ensure integrity of the filter when placed underwater. In practice thicknesses of 1 m below and 0.5 m above water level should be the minimum thicknesses used, subject to a minimum of 4  $D_{85}$  (filter layer).

The filters should cover the full depth of the breakwater.

If an impermeable crest structure is constructed on an underlayer particular attention should be paid to venting the lee side as wave pressures are readily transmitted through an underlayer and can cause blow holes to occur in overlying filter material.

Filter fabrics can be used in place of one or more filter layers. The core material should be covered with an intermediate layer of finer material to form a smooth face on which the fabric can be laid.

Fabrics should not be used where fluctuating pressures from wave action can be severe as this could cause wear and puncturing of the fabric. Where geotextiles are laid on slopes allowance should be made for a reduction in interlayer friction.

## 4.5 Design of crest structures

### 4.5.1 General considerations

Crest structures can be simple structures, whose only function is to provide an access roadway for inspection and maintenance, or massive structures with a wave wall to prevent or reduce overtopping and incorporating land side features required for services or other commercial activities. Typical crest structures are shown in Figure 12.

Figure 12(a) and Figure 12(b) show a plain cap which provides some lateral support to the armour on both faces, but allows considerable overtopping to occur. The underlayer beneath the cap can also permit significant penetration of higher waves.

The example in Figure 12(c) gives full lateral support to the seaward face armour and reduces wave loads on the wave wall. Overtopping can occur, but damage to the rear armour is avoided by extending the crest structure in a lip overhanging the rear face.

The high wave wall shown in Figure 12(d) will normally only be required where it is necessary virtually to eliminate overtopping, in order to protect important installations from damage. A shaped parapet to reverse flow due to uprush can be provided but will not necessarily be effective for large waves of long period causing massive uprush. A high wave wall will be subjected to greater wave forces than other crest structures.

In all cases a horizontal berm of underlayer sufficient for at least two armour units should be provided in front of the crest structure.

For maximum resistance to sliding, the underside of the crest structure should be keyed into the underlying material: see Figure 12 for typical methods.

**Table 10 — Layer coefficients**

Armour unit	$n$	Placement	Layer coefficient $k_A$	Porosity $P$ %
Quarrystone (smooth)	2	Random	1.02	38
	2	Random	1.15	37
Quarrystone (rough)	< 3	Random	1.10	40
	2	Random	1.10	47
Quarrystone (rough)				
Cube (modified)				

Source: [8]

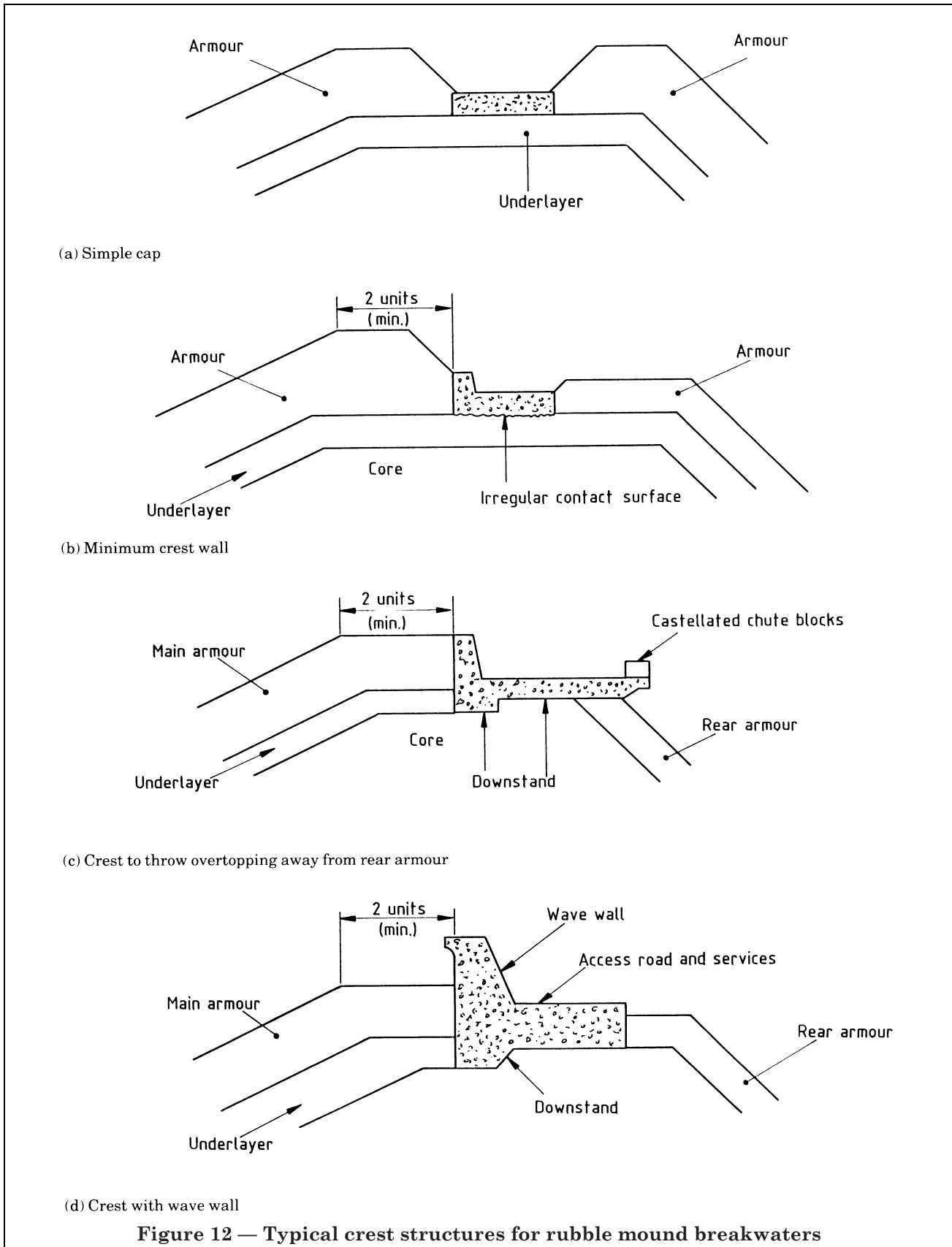



In crest structures designed to minimize overtopping by reflecting waves to seaward, the increased reflection can cause stability problems at the top of the main armour. This should be investigated on a hydraulic model. Where the crest structure is designed to direct overtopping water clear of the leeward edge of the breakwater, this can also require model testing.

Close to the wave wall much of the overtopping water falls as a continuous mass and its throw is comparatively independent of wind speed, whereas further away it falls as spray which is carried by wind. Comparison of rates of overtopping measured in a few model studies and full scale have been published by Jensen [11] and Jensen and Sorensen [21].

#### 4.5.2 Structural design

The structural design of crest structures should take into account the relevant recommendations in BS 6349-1 and BS 6349-2.

Crest structures are normally designed for stability as gravity structures and a thick cross section will therefore be appropriate. Mass concrete structures are commonly used but reinforcement can be provided for any of the following reasons:

- to control surface cracking due to thermal stresses;
- to resist bending stresses due to uneven settlement of the rubble mound or to wave loads on the upstand wall;
- to resist local stresses imposed via shear connectors.

It is recommended that, in general, the use of reinforcement should be kept to a minimum by providing mass concrete of appropriate thickness, strength and durability.

Settlement joints should be provided across the full cross section of the crest structure at intervals of 5 m to 10 m. The joints should be capable of horizontal shear transfer. Allowance for settlement should also be made in the design of any services supported on the crest.

#### 4.5.3 Analysis

##### 4.5.3.1 Introduction

Wave loads depend on the geometry of the structure, the level of the armour layer in front of it and the permeability of the rubble beneath the structure.

##### 4.5.3.2 Water pressures

In the absence of specific hydraulic model testing and when waves do not break upon the crest structure, the wave pressure can be assumed to be proportional to the difference between the significant wave height and the crest height above still water. The pressure  $P_w$  (in  $\text{kN/m}^2$ ) should be assumed to be uniform over the whole height of the vertical face and an approximate value can be calculated from the following empirical formula:

$$P_w = KW_w L \left( \frac{H_s}{H_c} - 0.5 \right) \quad (6)$$

where

$H_s$  is the significant wave height at the structure site in metres;

$H_c$  is the crest height of rubble mound in metres;

$L$  is the wave length corresponding to the significant period in a water depth equal to that at the structure site, in metres;

$W_w$  is the unit weight of water (fresh water =  $9\,810 \text{ N/m}^3$ , seawater =  $10\,050 \text{ N/m}^3$  typical value);

$K$  is a dimensionless coefficient, which in limited model testing has varied from 0.025 to 0.19 for armour varying from rounded stones to Tetrapods. It is suggested that a value of 0.25 be adopted for preliminary calculations.

An alternative approach is to estimate the height of run-up for the type of armour to be used, for the worst design wave, based upon published test results for uniform slopes. The resulting trapezoidal loading on the vertical face of the crest structure would be calculated, with the water rising to the same level at the structure.

Uplift pressures generated under the crest structure will depend on the level of its foundation relative to the height of the wave run-up. Decrease of uplift pressure from the seaward side to the land side will depend on wave uprush level, wave period and permeability of the founding layer.

Where no downstand is provided between the crest structure and an impermeable core, a uniform pressure equal to the horizontal pressure on the vertical face should be assumed to act beneath the base of the structure. In practice the uplift pressure diminishes fairly uniformly towards the leeward edge of the structure but the value of the minimum pressure will depend upon the permeability of the layers immediately beneath the structure.

#### 4.5.3.3 Stability

The factors of safety referred to in this section should be calculated as the total effect of the restoring forces divided by the total effect of the disturbing forces.

Crest structures should have a factor of safety against sliding of at least 1.5 against the wave forces calculated from the pressures derived in 4.5.3.2. It may also be advisable to consider the increased forces that arise from loss of armour and to check that the factor of safety under this condition would exceed unity.

Crest structures which project above the armour [as in Figure 12(d)] should have factors of safety of at least 2.0 against sliding and overturning failure where important installations have to be protected from damage by overtopping. Consideration could be given in such cases to designing the upper part of the wave wall to fail before the main structure moves, if the damage would thereby be restricted. When calculating stability of the crest structure against overturning, full uplift should be assumed under the entire width of the base.

Because of the uncertainty of wave forces on crest structures it is preferable to carry out specific hydraulic model tests in the case of major structures (see 3.6.5.2). Tests may be carried out as follows:

- a) subjecting the model structure to wave conditions exceeding those used in design to show that there is a reserve of stability;
- b) constructing the model crest structure at an equivalent relative density less than that of the prototype to show that there is a reserve of stability;
- c) measuring the forces on the model structure due to design conditions to permit a factor of safety to be estimated.

It is sometimes also necessary to check that there is an adequate factor of safety against slip failure in the top of the rubble mound.

Where a downstand is provided into the rubble mound this will have the dual function of delaying undercutting of the crest structure should damage occur to the armour or underlayers on the seaward side and of transferring horizontal forces into the rubble mound. A suitable shear connection should be provided between the crest structure and the downstand to ensure that all horizontal forces can be transferred in this way.

## 4.6 Design of toe and apron

In shallow water conditions the toe of the rubble mound breakwater can be exposed to breaking wave action. High water velocities and reversals in hydraulic gradient can cause erosion of the sea bed material (unless it is rock) and settlement of the toe. Such settlement can be controlled by providing a filter apron under the toe.

On the protected harbour side of a breakwater, particularly just inside the roundhead, the need for a filter should also be considered for protection against wave induced scour.

When the water depth at the toe is less than about twice  $H_s$  and the slope of the armour face is steeper than about 1 : 3, a toe bund will normally be necessary. Figure 13 shows typical forms of toe construction.

In Figure 13(a) the underlayer is extended to form the toe and this size of rock may be assumed for preliminary design where the water depth exceeds about twice  $H_s$ . In shallower water, larger stone is needed in the toe; guidance on its size is given by Eckert [41] and by Figure 28 which is based on model testing of vertical faced breakwaters and is likely to give conservative results. The core should not be exposed, but protected by main and secondary armour.

Consideration should be given to the effects of currents leading to scour of the sea bed (see 14.3 of BS 6349-1:1984). These can be due to tidal effects or can be caused by reflections of oblique waves off the face of the breakwater. Concentration of currents can occur at changes in alignment and at the end of the breakwater. Stone sizes for protection against scour caused by currents can be based on formulae used for design of channel revetments [42] (see also 5.3.8).

An important function of the toe bund is to provide support to the armour. The width of the bund should be such as will accommodate at least four rocks. However, because the formation of a berm constitutes a discontinuity in a seaward face which may affect downrush the final dimensions and stone size are preferably confirmed by hydraulic model tests.

A protective apron can be provided in front of the toe as shown in Figure 13(e).

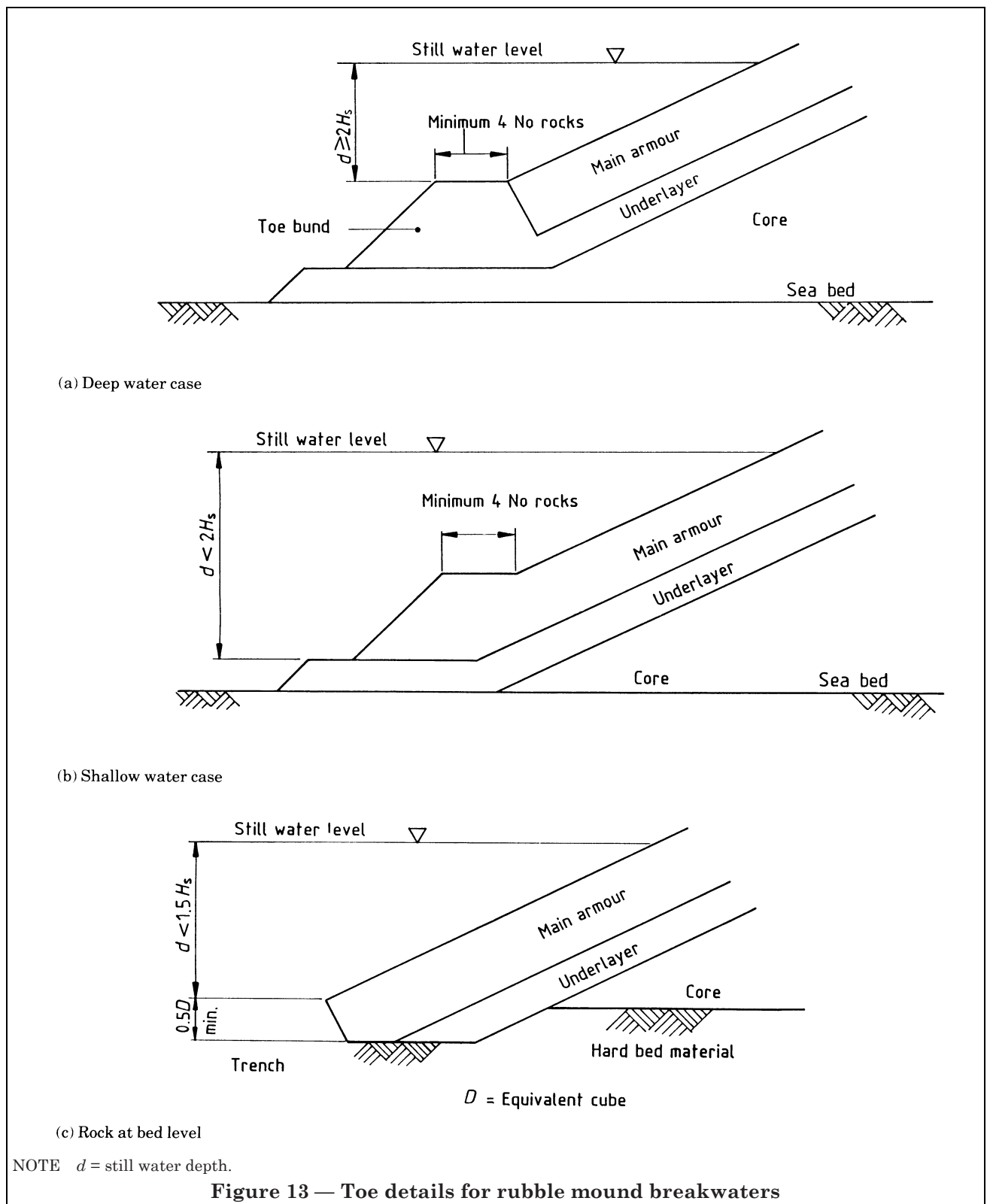

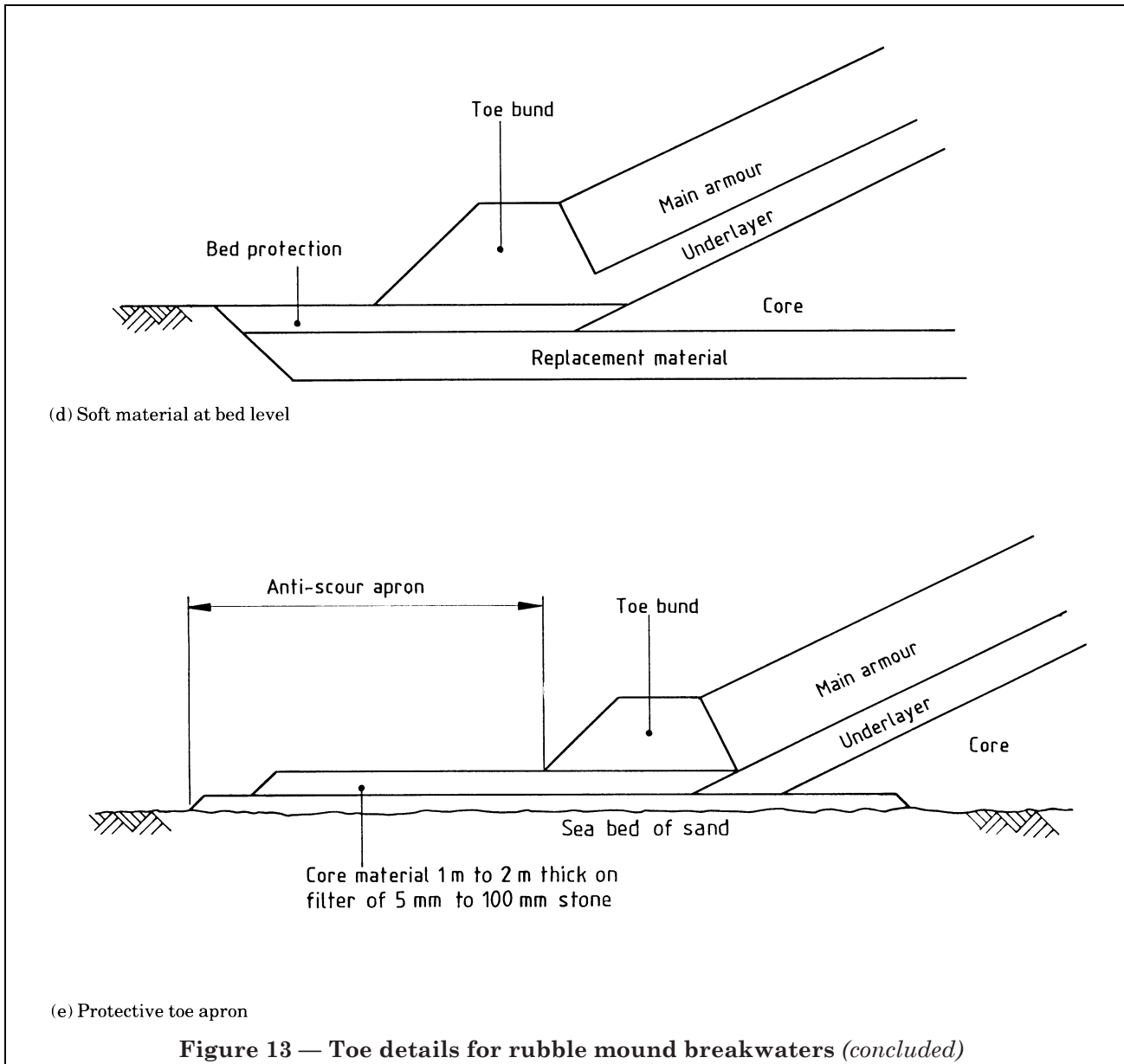
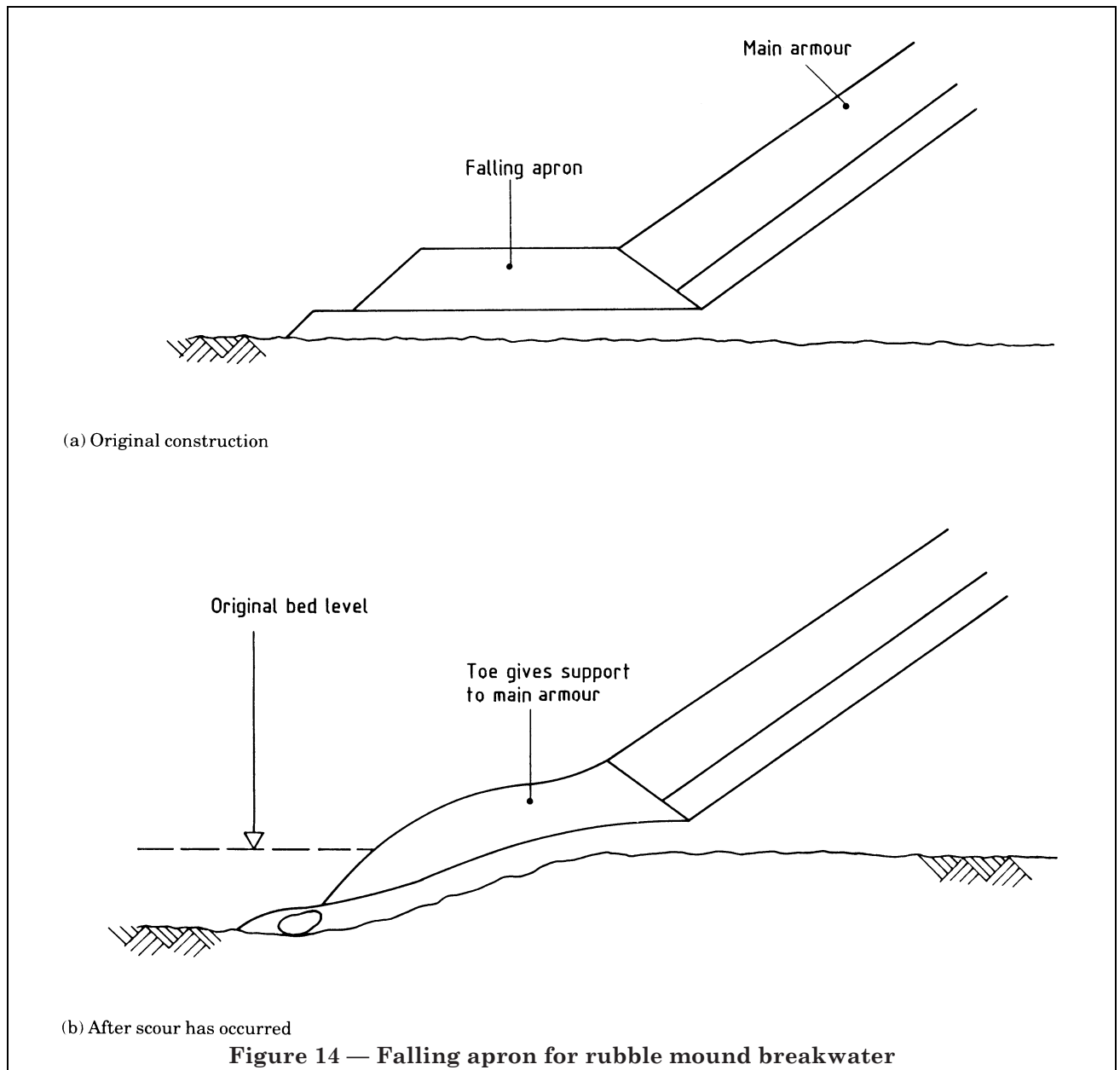

Figure 13 — Toe details for rubble mound breakwaters (concluded)

A wider toe is needed where the bed is of fine material liable to scour and the design should provide sufficient volume of rubble to act as a falling apron, as shown in Figure 14, if scour undercuts the toe protection. For further reading see Eckert [41]. A survey of practice in the USA is given by Hales [43].

No criteria have yet been established for determining the required width of anti-scour protection. In general, scour can be assumed to be greatest within one-quarter wavelength of the foot of the armour slope. The width of the toe or extent of protective apron needed depends on the depth of erodible bed material as well as the characteristics of the breaking wave and the strength of currents.

The size of stone required in an apron may be determined by assessing the size needed on the sea bed for threshold stability under the action of the design wave in the open sea, but allowing an increase in size to allow for the effects of wave breaking and downrush. Figure 15 gives a nomogram for threshold movement under wave action. The wave height used should be  $H_{1/10}$ . It is suggested that stone weights derived from Figure 15 be doubled, with a further increase if strong currents are expected.



When the bed material consists of loose sand and finer materials, mattresses are sometimes required to prevent migration of the sand through any layers of stone used for scour protection, resulting from fluctuation of pore pressures due to wave action. Willow mattresses loaded with stone were the traditional form of construction but synthetic fibre materials loaded with rubble or concrete are now being used.

Methods of estimating the mesh size of synthetic fibres for use in revetments are given in reference [45]. Several types of geotextile can be used and there is information on the performance of such fabrics in revetments. There is insufficient experience of their use on breakwaters under severe wave action for any guidance to be given.



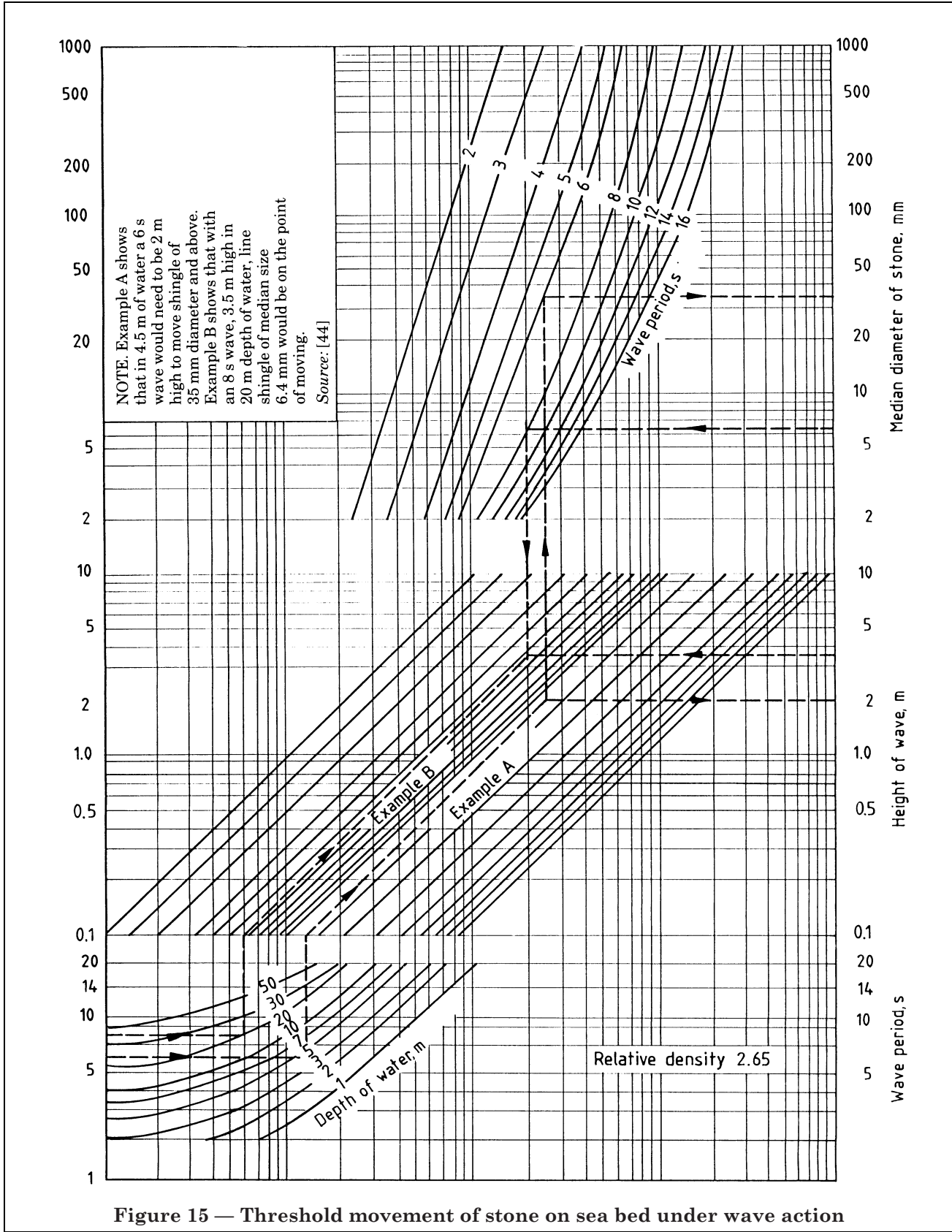

If stones of the required size are not available, alternative forms of anti-scour protection should be considered. These can include grout-filled synthetic fibre mattresses and small stones bound together with mastic asphalt. These alternative forms of construction will also in general prevent migration of fine sea bed materials.

An example of a large breakwater on an eroding sea bed is shown in Figure 6(e).

Because the toe is very important as a support for the armour and the cost of the toe is small compared with the cost of armour, it should be designed on a conservative basis. Stone size and toe profile should be checked by model testing.

#### 4.7 Design of foundations

As referred to in 4.2.3 overall stability involves both the rubble mound and its foundations, and both static and dynamic loadings.

Stability of the foundation against failure should be calculated based on the proposed structure design and a full knowledge of the foundation soils.

Guidance on suitable factors of safety is given in BS 6031.

It is necessary to consider the possibility of failure of the mound and foundation together, and to take account of the effect of sudden draw down in a wave trough. If seismic activity is expected both the mound and the foundation should be examined using appropriate codes (see clause 40 of BS 6349-1:1984). Rubble mounds are often formed at steep slopes and can be affected by severe earthquakes. The foundation can be affected where soils are subject to liquefaction.

If found necessary the factors of safety can be increased by widening the structure, by reducing by sponcing the side slope, and/or by adding a toe berm.

Settlement of the breakwater foundation should be assessed. This can be caused by the following:

- a) compression or failure of the foundation material;
- b) liquefaction of loose and/or fine sands at foundation level due to seismic action;
- c) liquefaction of the same materials due to reverse hydraulic gradients caused by wave action;
- d) migration of fine grained foundation material into the body of the breakwater.

Settlements due to compressibility or liquefaction can be estimated using standard soil mechanics theory. The effects of reverse hydraulic gradients on the foundation material are difficult to assess. The toe and anti-scour apron (see 4.6) give protection against this action.

Migration of fine grained material at foundation level into the body of the breakwater can be restricted by providing a filter layer as shown in Figure 6(c). Guidance on filter design is given in 4.4 and by Hedges [27].

Replacing a weak foundation material with rubble, gravel or sand fill provides a solution for both foundation stability and settlement problems.

If there are sand deposits at depth which are liable to liquefaction, consideration can be given to compaction by ground improvement techniques.

It is sometimes possible to limit the effects of settlement by careful programming of construction, so that the rate of settlement is controlled and advantage is taken of possible improvements in ground quality before the full load of the structure is applied.

#### 4.8 Design of breakwater head

The head of a breakwater requires special consideration to achieve the necessary stability at a vulnerable part of the structure.

Conditions at the head may be more exposed than at other parts of the structure in the following respects:

- a) the head is usually located in the deepest water;
- b) the head is often exposed to attack by waves approaching from a wider range of directions;
- c) incident waves can be reflected, refracted or diffracted by the structure or by the other breakwater at a harbour entrance;
- d) increased wave disturbance can arise due to reflection or refraction from a dredged channel or due to changes in bed level due to littoral drift or bar formation;
- e) currents can be more pronounced than elsewhere along the breakwater.

It is usual to design the head of a rubble mound breakwater as a roundhead, an example of which is shown in Figure 16, although it is possible to achieve the additional stability needed by means of a strong point comprised of one or more caissons.

If a vertical faced caisson is used instead of a roundhead, the junction with the rubble mound requires special consideration as wave action can be concentrated here. The strongpoint should be designed by reference to sections 5 and 6.

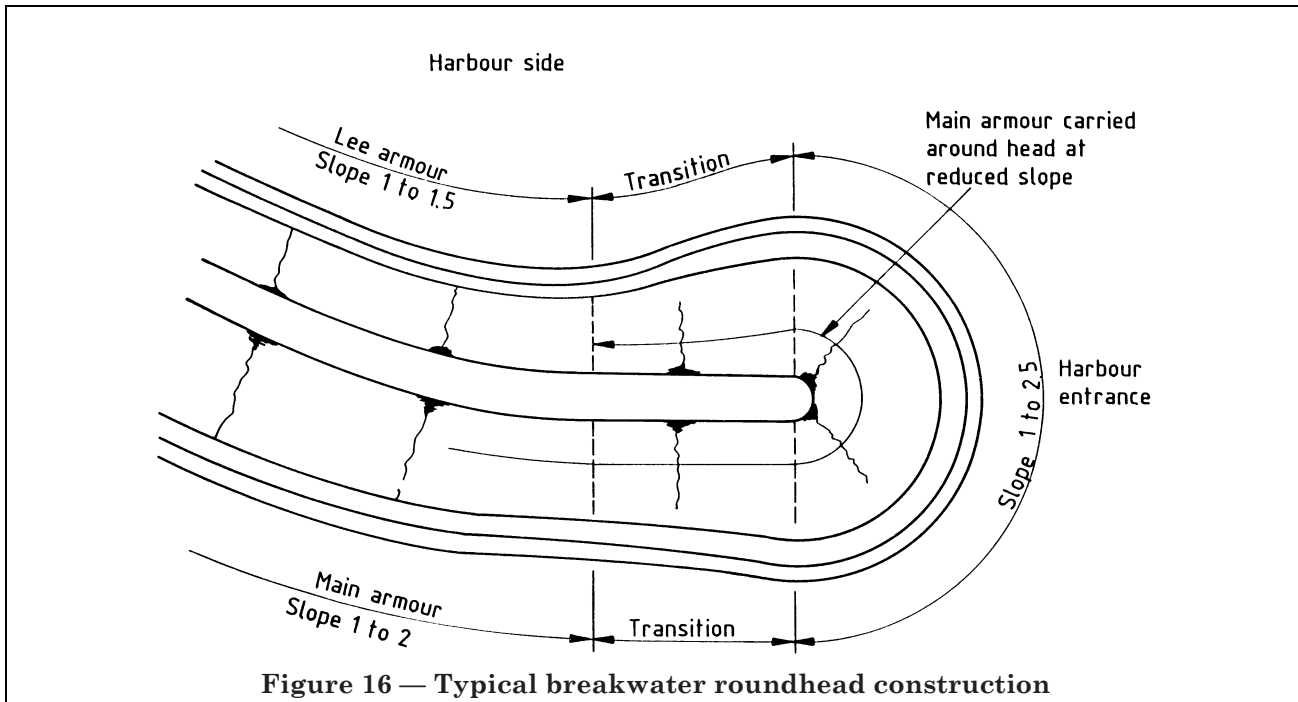

Figure 16 — Typical breakwater roundhead construction

With a conventional roundhead the geometry creates additional problems for armour stability as follows:

- wave action will result in higher water velocities over parts of the rear slope than elsewhere and it is often found that this is the region of least armour stability;
- the curvature of the roundhead can reduce the interlock between units of armour.

The adverse factors summarized above require a roundhead to be designed with greater strength than the breakwater trunk in order to achieve comparable stability under the same storm conditions. This can be done by using either larger armour units or a flatter slope angle, or by a combination of these two. Other possible methods are to increase the thickness, hence the permeability, of the armour layer, or to use heavy aggregates in concrete armour units, to avoid the need to produce extra moulds for larger units for the roundhead. The crest width can also be increased.

Such measures should be applied around the head and for a distance, along both sides of the trunk, of (typically) 1 to 2 times the overall height of the breakwater tip. A smooth transition should be provided between the roundhead and the trunk on the seaward side.

Some types of armour unit, e.g. Tetrapod and Dolos, are less stable under oblique wave attack than under attack by waves perpendicular to the structure. The measures described above could therefore need to be increased when using units displaying this characteristic.

Suggested  $K_D$  values for rock armour in roundheads are given in Table 7. These values are lower than those applicable to the structure trunk and are limited to the range of slopes indicated. Flatter slopes than these can significantly reduce armour stability, rendering the suggested  $K_D$  values inappropriate.

Reference should be made to 4.6 for design of the toe and anti-scour protection at roundheads.

Roundheads for major structures should be tested in three-dimensional wave basins using waves from various directions as described in 3.6.1. For further information on design of roundheads see Jensen [11].

## 4.9 Low crest breakwaters

### 4.9.1 General considerations

A low crest breakwater can be provided where significant wave transmission by overtopping is acceptable. The crest can be submerged at some or all states of the tide and in large tidal ranges there can be a considerable variation in performance with tide level.

The structure can then act as a conventional rubble mound at low water, with limited or no overtopping.

In a low crest breakwater the core will not extend up to high water level, a crest structure is not normally provided and significant wave transmission can therefore also result through the structure. Taking account of the high wave transmission and allowing for construction conditions it is sometimes convenient to provide a permeable core of large rock.

Wave transmission is affected by incident wave conditions and by the freeboard or submergence, the crest width and the core material used. Further information on the hydraulic performance and stability of low crest breakwaters is given by Powell and Allsop [22].

Low crest breakwaters usually need to be constructed using floating plant although with high tidal ranges they can be built from the shore at low water. The possible cost disadvantages due to interruptions by tides, adverse weather or double handling of the materials could cancel out any saving resulting from the smaller quantity of materials compared with that required for a higher crested structure.

A submerged or low crest structure is a greater hazard to navigation than a conventional breakwater. Adequate navigation warning buoys and lights should be provided.

Inspection and maintenance of low crest breakwaters is difficult because access is only possible by floating craft or at low tide.

#### 4.9.2 Design of armour

On the seaward face of a low crest breakwater the downrush forces are smaller than in a higher crested structure, while on the lee face the downrush forces are greater. Armour on the crest is exposed to severe forces but does not have the same interlocking characteristics as that on a slope due to the difference in gravitational forces [22].

A low crest structure will therefore require heavier crest and lee side armour than a rubble mound of conventional crest height (see 4.3.4).

Should a permeable core be used lee side armour stability is likely to be somewhat less.

For preliminary design purposes a uniform armour size equivalent to that which would be required for the seaward armour of a conventional rubble mound can be adopted. The armour should extend over the crest and rear face down to about one wave height below still water level. This water level needs careful consideration with respect to tidal range and structure profile.

Hydraulic model tests should be carried out to verify the armour size used in the final design.

## 4.10 Construction materials

### 4.10.1 Rock

Recommendations for the quality and shape of rock for use in breakwaters are given in 57.1 of BS 6349-1:1984.

Engineering characteristics of common rocks and notes on suitability for use in breakwaters are summarized in Table 11. Guidance on selection is given by Fookes and Poole [46].

One of the first requirements in the design of breakwaters is the identification of a suitable source of rock. Rock can come from an existing source, where the quality and yield is established and the material can be supplied to a known specification.

However, it is often necessary to locate and investigate a new source for quarrying. This requires considerable experience in assessing quality and yield, and in using these predictions in designing and specifying the breakwater works.

Site investigations will be required to determine the following.

- a) Lithology: strength, grain size, cementation, relative density.
- b) Joint frequency, orientation and bed thickness: to assess the likelihood of being able to produce large blocks and the percentage of total yield these form.
- c) Depth of overburden and ground water levels: these affect the cost of quarry operations.
- d) Land ownership, requiring royalties or payments.

Detailed site investigations can include geophysical surveys, rotary core drilling and trial blasts.

Laboratory tests of rock quality should be carried out as soon as samples are available. 57.2 of BS 6349-1:1984 lists the tests required, although these are based on quality tests for aggregates. Fracture toughness and abrasion tests specifically in breakwater rock are being developed but are not yet in regular use [1]. The need to ensure high quality rock for breakwater construction is of particular importance if the rubble mound is designed to be reshaped by wave action.

Table 11 — Engineering characteristics and performance of common rocks

Rock <sup>a</sup>	Seismic velocity	Bulk density <sup>b</sup>	Water absorption <sup>c</sup>	Aggregate crushing value <sup>d</sup> (ACV)	Dry uniaxial compressive strength	Notes
	km/s	t/m <sup>3</sup>			MN/m <sup>3</sup>	
<i>Sedimentary</i>						
Quartzite	6.0 to 6.2 <sup>e</sup>	2.4 to 2.8	0.1 to 2.0	8.0 to 25.0	150.0 to 300.0	Usually good armour and core
Sandstone	1.4 to 5.0	2.1 to 2.7	1.0 to 15.0	15.0 to 35.0	10.0 to 170.0	Often good armour and core
Siltstone	— <sup>f</sup>	2.1 to 2.3	—	15.0 to 35.0	5.0 to 100.0	May be good core
Shale	2.3 to 4.7	2.0 to 2.5	1.0 to 10.0	—	5.0 to 100.0	Occasionally may be suitable for core
Limestone	2.0 to 6.4	2.2 to 2.6	0.2 to 5.0	12.0 to 40.0	30.0 to 250.0	Usually good armour and core but soft types are suspect
Chalks	1.7 to 4.2	1.8 to 2.3	2.0 to 30.0	30.0 to 50.0	5.0 to 75.0	May be suitable core
<i>Igneous</i>						
Granite	5.0 to 6.0	2.5 to 2.8	0.2 to 2.0	10.0 to 25.0	100.0 to 250.0	Usually good armour and core; beware weathered rock
Diorite	5.8 to 6.4	2.7 to 3.05	—	12.0 to 30.0	150.0 to 300.0	Usually good armour and core; beware weathered rock
Gabbro	6.4 to 6.6	2.8 to 3.1	1.0 to 5.0	8.0 to 25.0	150.0 to 300.0	Usually good armour and core; beware weathered rock
Rhyolite	—	2.4 to 2.6	1.0 to 8.0	16.0 to 35.0	75.0 to 200.0	May be suitable core
Andesite	2.6 to 5.2	2.2 to 2.5	0.2 to 10.0	18.0 to 40.0	50.0 to 200.0	May be suitable armour and core
Basalt	5.4 to 6.4	2.7 to 3.0	0.1 to 2.0	12.0 to 25.0	150.0 to 300.0	Often good armour and core; beware weathered rock
Serpentinite	6.0 to 6.9	2.7 to 3.1	—	14.0 to 35.0	—	Often good armour and core
<i>Metamorphic</i>						
Slate	2.3 to 4.7	2.6 to 2.8	—	16.0 to 35.0	100.0 to 200.0	May be suitable core
Phyllite	—	—	0.5 to 6.0	22.0 to 40.0	40.0 to 150.0	May be suitable core
Schist	4.2 to 5.0	—	0.4 to 5.0	20.0 to 35.0	50.0 to 150.0	May be suitable armour and core
Gneiss	3.3 to 7.5	2.8 to 3.0	0.5 to 5.0	14.0 to 30.0	50.0 to 200.0	Often good armour and core; beware weathered rock
Marble	3.7 to 6.9	2.6 to 2.7	0.5 to 2.0	20.0 to 35.0	100.0 to 275.0	Often good armour and core

<sup>a</sup> Only fresh and slightly/moderately weathered rock should be considered.

<sup>b</sup> The value for the bulk density (in mg/m<sup>3</sup>) approximates to the oven dried relative density. Generally this will be slightly lower than saturated surface dried relative density (see BS 812-2).

<sup>c</sup> See BS 812-2.

<sup>d</sup> This test performed on aggregates. See BS 812-110.

<sup>e</sup> All data given as ranges of typical rock not extremes.

<sup>f</sup> Gaps in this table due to insufficient data.



An estimation of yield of stone sizes should be made and design optimized if possible to suit predicted quarry output. Rough estimates can be made, from joint-spacing, of the size and proportion of rock blocks, but if possible a trial blast from a prepared face should be carried out to give a more reliable estimate. It is unlikely that the percentage grading of heavy stones will exceed the following [37]:

stone from 0.2 t to 1 t	15 %
stone from 1 t to 4 t	20 %
stone over 4 t	15 %

Testing of rock should be carried out throughout quarrying operations to confirm that the properties specified continue to be achieved. Lower quality rock is more likely to suffer from fracture, abrasion, rounding and chemical attack, particularly when it is used in armour layers. This is likely to increase the probability of damage or failure during the design life of the structure. The economic consequences compared with locating a better and more costly source of rock should be carefully considered during the design.

#### 4.10.2 Concrete

Guidance on specification for concrete in maritime structures is given in clause 58 of BS 6349-1:1984 and reference should also be made to BS 5328-1 and BS 8110-1.

Although concrete used in concrete armour units is in general mass concrete and only occasionally contains reinforcement it should not be considered merely as a dead weight of concrete. Because of the static and dynamic loads to which armour units are subjected and the corrosive conditions to which marine structures are subjected, a high quality concrete should always be used: a characteristic strength of 30 N/mm<sup>2</sup> or more is recommended, but caution should be exercised on the use of high cement contents because of the risk of shrinkage cracking, particularly with large armour units. A high standard of quality control is important.

#### 4.10.3 Geotextiles and related products

Geotextiles can be employed to serve either the reinforcement function, as part of the formation stability-analysis, or the filtration function, as part of the formation design or if the breakwater contains a reclamation.

When used as reinforcement, the most important qualities required are a long term sustainable tensile strength, mechanical robustness and chemical inertness.

When serving the filtration function, the most important quality is long term filtering efficiency based on particle retention and permeability criteria. The effect of particle blocking or clogging of the geotextile core openings is fundamental to the assessment of retention and permeability [45, 47, 48]. In most applications further regard has to be paid to the puncture and abrasion resistance of the geotextile and hence the layers with or without unit that can be placed or dropped on the geotextile. Test methods for geotextiles are given in BS 6906.

#### 4.10.4 Bituminous materials

Guidance on the use of bitumen in maritime engineering for grouting or mastic asphalt is given in clause 66 of BS 6349-1:1984 and by Van Garderen and Mulders [49] and in reference [50].

### 4.11 Construction

#### 4.11.1 General

4.11.2 to 4.11.12 cover the influence of construction plant on design, factors affecting the construction sequence, the construction of the principal elements of a breakwater, and measurement and tolerances in construction.

Detailed descriptions of rubble mound breakwater construction are given by Ridgway and others [51] for a structure with rock armour, and by Hookway and Brinson [52] for one with concrete armour units.

#### 4.11.2 Construction plant

Construction of rubble mound breakwaters can be carried out by plant based on land or sea. On major structures it can be economic to use both. Submerged and offshore structures require the use of floating plant or jack-up platforms.

The possible methods of construction should be considered at an early stage of design, since the potential methods will influence the design.

Floating plant is affected by weather conditions: in particular, movement of crane barges can make accurate positioning of armour units difficult. An analysis of the variations of wave climate throughout the year should be made to assist in construction planning. A suitable position fixing system should be used to ensure accurate positioning of dump and crane barges. Jack-up barges require calm conditions for moving to a new position, but will allow more accurate construction to be achieved.



In sea conditions such as a permanent swell, accurate placing is not necessarily achieved even from land based plant, because of swinging of the armour unit when lowering through water. Designs should allow for this condition by assuming that packing can be loose and interlock low.

Breakwaters which are to be constructed using land based plant require a crest width sufficient for access and construction at a height which permits continuity of work under normal wave conditions.

Both the core and underlayer can be used to provide an adequate operating width for the plant, the running surface being formed by temporary blinding with small stone.

#### 4.11.3 Construction sequence

A rubble mound breakwater should be constructed in a sequence of bed preparation, toe construction, core placing, underlayer, armour and crest structure. A construction sequence for a large breakwater is illustrated in Figure 17.

#### 4.11.4 Toe construction

Where there is any danger of suspended solids entering the trench, foundation trenches should be filled with the specified material as soon as possible after dredging.

Stones for berms and toe structures can be deposited using rock trays.

Where geotextiles are used underwater, they will need to be weighted to prevent them from floating or being lifted by waves. The method of weighting should be such that the fabric lies flat when placed.

#### 4.11.5 Core and underlayers

Core construction below water level can be economically done from floating craft, particularly if there is a convenient loading point from the quarry. Bottom dumping from barges can be used in depths greater than about 4 m and side dumping from flat top pontoons in depths greater than 2 m.

Alternatively, rock can be rehandled by a crane mounted on a pontoon or jack-up platform.

The core and underlayers are liable to damage by wave action during construction. If continuous rough weather is expected at certain stages it could be necessary to cease work before the onset of rough weather and provide temporary protection to unfinished work.

It is good practice to limit the extent to which the core is constructed ahead of the underlayer, and the underlayer ahead of the armour, to reduce the risk of storm damage and consequent delay.

The risk of damage to the core by wave action during construction, should be considered in specifying the size of underlayer stone. Stability of the exposed end of the core, or of a partly built core below water level, should also be considered in deciding the specification of core material. Material accepted for core construction, but which is generally of smaller size or inferior quality to the average, should be deposited in the centre of the core in preference to the edges or top.

Tipped core material can stand at slopes as steep as 1 : 1 to 1 : 1¼ unless drawn down by wave action. To obtain flatter slopes it will be necessary to place additional material and to trim the slopes. Slope trimming is sometimes also required to restore slopes after moderate wave action.

A high proportion of fine material can remain at the top of a tipped face. This fine material and any additional fines used to form a temporary running surface should be removed by sluicing or jetting with water before final underlayers, armour or crest are placed, to ensure that there are no planes of weakness and that the permeability and performance match as closely as possible those assumed in design.

Rocks in underlayers larger than 1 t should preferably be placed individually to establish uniform distribution and correct layer thickness. Underlayer material up to about 1 t in size can be tipped into position preferably from rock trays. With care, it is possible to place larger rocks up to approximately 5 t by rock tray with subsequent slope adjustment by a rock grapple.

#### 4.11.6 Armour

##### 4.11.6.1 Rock armour

Rock should be sorted at the quarry. Acceptably shaped samples of each size of rock required should be permanently displayed.

Each rock should be placed individually, after inspection to ensure that it is within the specified weight range, uncracked and of acceptable shape. It is preferable that the whole thickness of armour layer is placed in one pass to ensure good bonding of the individual blocks.

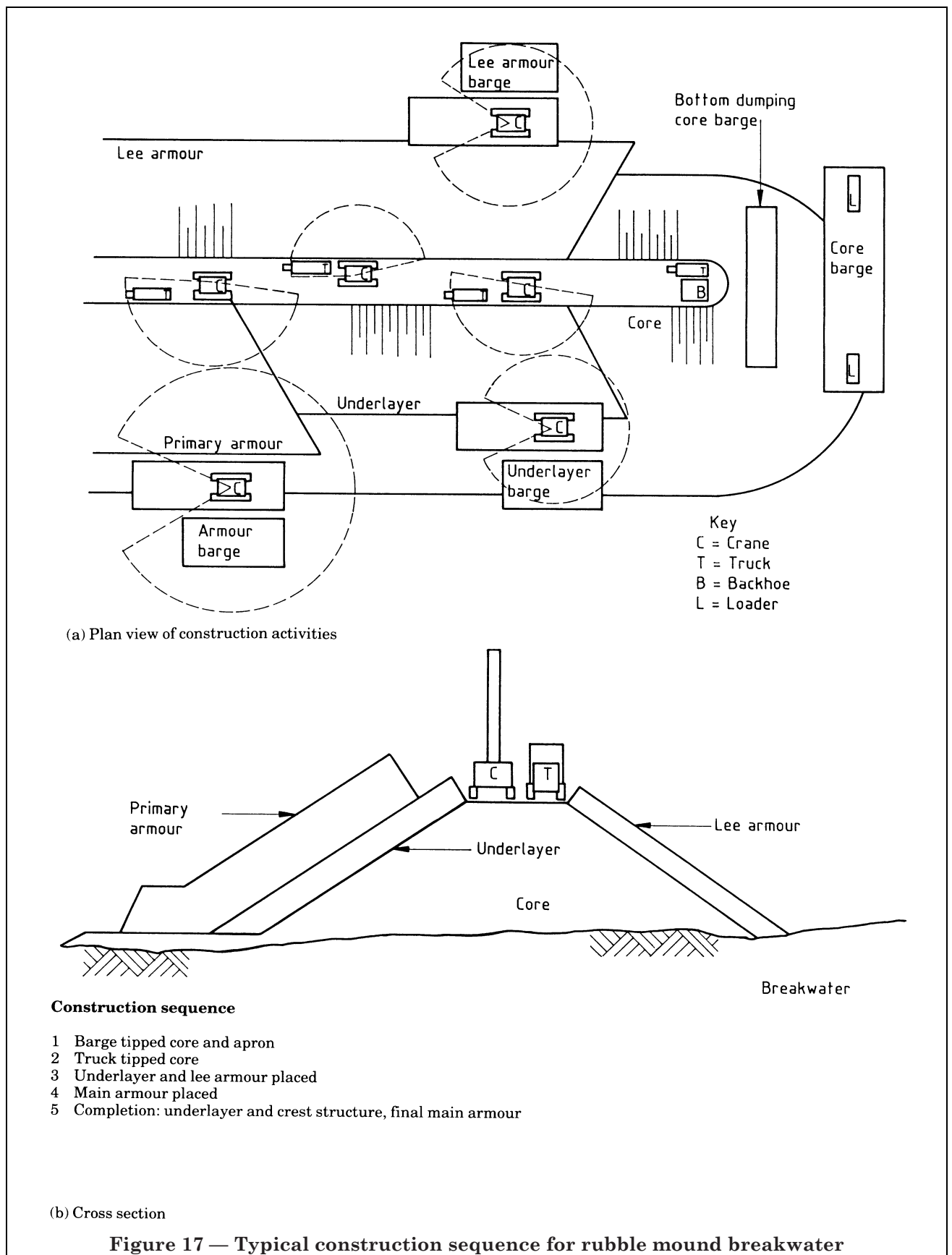

#### 4.11.6.2 Concrete armour units

The manufacture, transport and placing of concrete armour units should be carefully controlled. In particular, concrete mixes for large units should be designed to reduce temperature differentials and moulds should be designed to avoid cracking due to thermal stresses. Low heat cement can also be advisable. Concrete production, casting, curing, stripping of formwork, moving to stockyard, transporting and placing should be arranged and programmed to minimize stresses. A working area with capacity to store at least 1½ to 2 months' production plus the space needed for manufacturing will be required.

The placing specification for artificial armour units should be appropriate to the type of unit (see 4.3.3.1).

Regular pattern placing can only be satisfactorily carried out above water or in favourable conditions of calm seas and clear water to enable diving inspectors to check the position of all units.

With random placing the number of units for a stated area should be specified to ensure adequate coverage and thickness of armour layer. It is rarely practicable to control placing only by tolerance on thickness, although soundings to confirm the thickness of armour layers can be carried out. The exact method of sounding after placing requires careful specification where concrete armour units with large voids are adopted [53].

Experience with many artificial armour units shows that a degree of pattern placing is to be recommended, so that each unit is lowered onto the underlayer rock face at a predetermined position (and sometimes with a particular attitude).

The position is determined by crane position and a combination of boom elevation and horizontal angle, or by direct measurement of co-ordinates if a boat can be used to support a measuring line. Specific recommendations are usually available from the originator or licensee.

The risk of damage to units due to impact when placing should be assessed and limitations in placing due to weather conditions determined.

#### 4.11.7 Measurement, deviations and tolerances

Deviations from the theoretical profiles of layers in a breakwater can be expected. These will depend on construction methods, environmental conditions and the quality of control exercised. Tolerances are those deviations which are acceptable to the design and specified as such. Measurements are required to check deviations; the principal concerns are the slope, overall and locally, and the layer thicknesses.

Conventional surveying above water level is straightforward but soundings are required below water level and this can be difficult, time consuming and of limited reliability. Echo sounding or use of a sounding line is possible from a boat in good sea conditions, but where there is more than mild wave action sounding by line from a crane boom could be required. Due to the large voids in rock layers a wire basket or block should be used on the end of the line to determine an average profile.

Successive profiles should be taken at each location so that the effects of locally steeper slopes and deficient layer thickness can be assessed before the work is approved for the placing of subsequent layers.

The general requirements for check measurements and the tolerances on profile and layer thickness should be specified by the designer. They should be realistic for the conditions expected and taken into account in the design and in any hydraulic model testing.

#### 4.11.8 Crest structure

Construction should be programmed to allow sufficient time for settlement of the rubble mound to occur before the crest structure is built. This will usually be achieved more easily if the crest structure is constructed out from the shore to follow the rubble mound construction sequence. However, this is not always practicable if the crest structure is too narrow for use by mobile plant.

Before the crest structure is built, any fines remaining on the formation should be removed. The formation should then be prepared to present a rough surface and to prevent loss of base concrete. Concrete bagwork or small rock in the interstices can be used to fill voids where the crest structure is to be built on underlayer. Core material should be sluiced to leave the larger rocks projecting.

Following construction of the crest structure, the rubble mound will require completion. Rock armour should be placed to avoid gaps or large projections, without having to resort to undersize material. Concrete armour units should be carefully arranged to interlock whilst resting against the crest wall.

## 4.12 Monitoring and maintenance

Any breakwater design should take careful account of the problems of maintenance. Because of the heavy lifts at large outreach required for replacing armour units it is sometimes advisable to make general provision for access by construction plant carrying out maintenance. In designing for an economic balance between increased initial investment and reduced maintenance expenditure full account should be taken of the costs of mobilizing heavy plant and re-opening quarries or re-establishing casting yards for concrete units.

The condition of a breakwater should be regularly inspected and surveyed so that its behaviour can be assessed and to enable damage to be detected at an early stage. An inspection should be carried out at the end of winter storm periods and especially after particularly severe storms.

Features which will assist monitoring should be incorporated into the structure during construction. These include fixed survey points for determining movement, settlement and location of survey cross sections, and marked armour stones or units.

Monitoring the performance of rubble mound breakwaters which do not incorporate a crest structure presents problems because of the difficulty of access and nature of the armour layer at the crest.

Monitoring should include the following:

- a) recording of environmental conditions, including wind speed and direction and water levels; these measurements are normal features of harbour operations; wave recording should be continued during and after construction;

- b) surveys of position and level of permanent station points and cross sections;

- c) diving inspections;

- d) photographic records, including underwater if possible, to assist in assessing changes in the condition of the armour layer; successive photographs should, ideally, be taken from the same view point;

- e) readings of built-in instrumentation (if provided).

Echo sounding and side scan sonar can be used for profiling underwater slopes and aprons and assessing condition. Aerial surveys can also be used. Soundings should be carried out over the sea bed along the entire perimeter of the breakwater. It is suggested that soundings should extend over a distance from the toe of at least one-quarter of the maximum wavelength to check for scour. The distance adopted should be appropriate to the conditions and features at the breakwater location and should be sufficient to include the side slopes of adjacent dredged channels.

Provision for maintenance should be established once the breakwater has been completed, although implementation will depend on the results of monitoring and particularly on the effects of severe storms.

## Section 5. Vertical face structures

### 5.1 General

This section gives recommendations and guidance on the design and construction of vertical face breakwaters, as defined in 1.2.

The types of vertical face structure are discussed in 5.2, and overall design is discussed in 5.3.

Advice on construction methods is included where appropriate in the clauses dealing with the various structures covered.

### 5.2 Types of structure

#### 5.2.1 General

A vertical face breakwater usually prevents transmission through the structure, thus reflecting all the energy from the waves which do not overtop it. In suitable circumstances a breakwater can be made permeable and permit a degree of transmission. A permeable seaward face can be used to absorb wave energy in chambers within an impermeable breakwater.

The seaward face is usually vertical but batters or slopes can be provided over part or all of the height. The seaward face is usually straight in plan but shaped faces are sometimes adopted.

Some vertical face breakwaters have been provided with sloping banks of natural rock armour or artificial blocks on the seaward face.

The structural form can be either a gravity structure or a piled structure, and many aspects of quay wall design and construction will be found relevant to such breakwaters. Reference should be made to BS 6349-2.

Many different cross sections have been adopted and some examples are shown in Figure 18 to Figure 26.

#### 5.2.2 Structures with solid face

Figure 18 to Figure 23 show typical cross sections of vertical face structures with solid faces.

The most common forms of structures with vertical solid faces are of gravity construction. Caisson structures can be floated [Figure 18(a) and Figure 18(b)] or lifted into position [Figure 18(c)]. Blockwork structures as in Figure 19 require extensive divers' work, and those in Figure 20 to Figure 22 use sheet piling to contain the structural fill, and act as gravity structures.

The designs given in Figure 18 to Figure 23 illustrate a few of the many alternative structural arrangements which are possible including hybrids of two or more of the arrangements described.

#### 5.2.3 Structures with perforated face

An example of an impermeable vertical wall breakwater structure with a perforated face is shown in Figure 24.

Perforated vertical wall structures are of similar external geometry to solid wall structures but are generally limited to caissons and blockwork.

The perforated front wall of the caisson type shown in Figure 24 contains circular or rectangular openings, which allow flow into and out of a chamber located behind the front wall in which energy is dissipated by turbulence reducing wave reflections, wave loads on the structure and overtopping.

Further information on the design of perforated walls may be found in Nagai [59] and Quinlan [60].

Perforated breakwaters can also be designed to be permeable, where some wave transmission occurs. Such a structure can consist of open blockwork or of a slotted wavescreen supported by piling. An example of the latter is shown in Figure 25.

#### 5.2.4 Structures with rubble mound at seaward face

Examples of vertical wall breakwaters with a rubble mound at the seaward face are shown in Figure 26. The base structure may be of any form suitable for the conditions, but that shown in Figure 26(a) with a caisson is common, particularly in Japan [57, 61].

The rubble mound can be provided to reduce overtopping, wave reflection and wave loads on the structure.

### 5.3 Design

#### 5.3.1 General

The main factors to be considered in the design of vertical face structures are hydraulic performance, loads and overall stability. Ground conditions and construction methods will have a considerable influence on the structure adopted.

#### 5.3.2 Hydraulic performance

##### 5.3.2.1 Overtopping

The structure can be designed for varying degrees of overtopping. The amount of overtopping which can be tolerated depends on the protective function of the breakwater, referred to in 2.2.4, and the acceptable wave conditions immediately behind the breakwater, on which guidance is given in 3.5.2.4.

Overtopping of vertical face structures can lead to a significant reduction in horizontal wave forces on the vertical face.



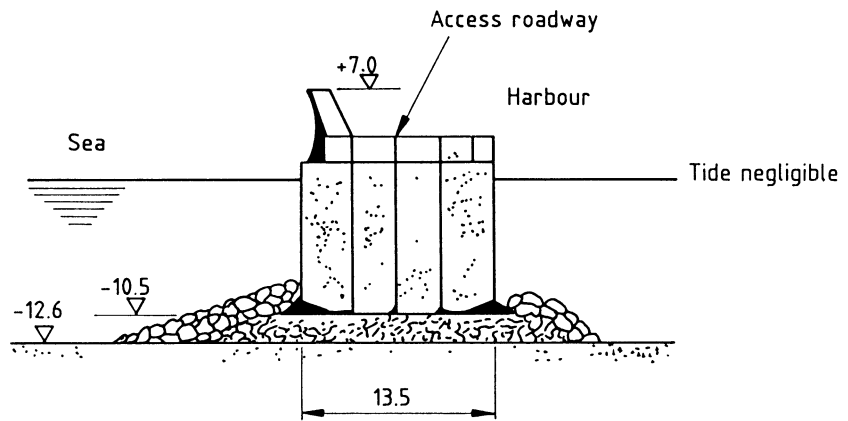

(a) Gela (Italy)

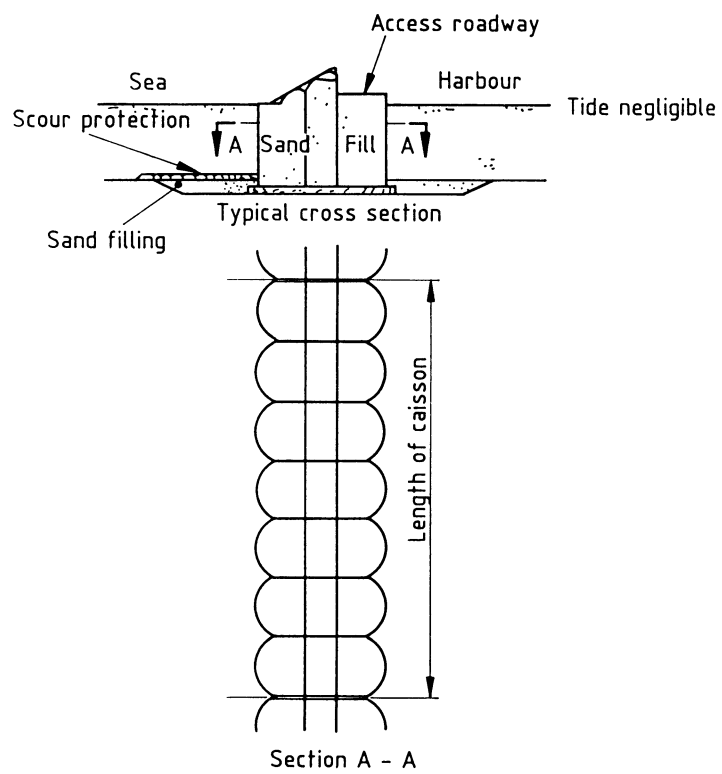

(b) Marsa el Brega

Dimensions in metres.

Figure 18 — Caisson structures

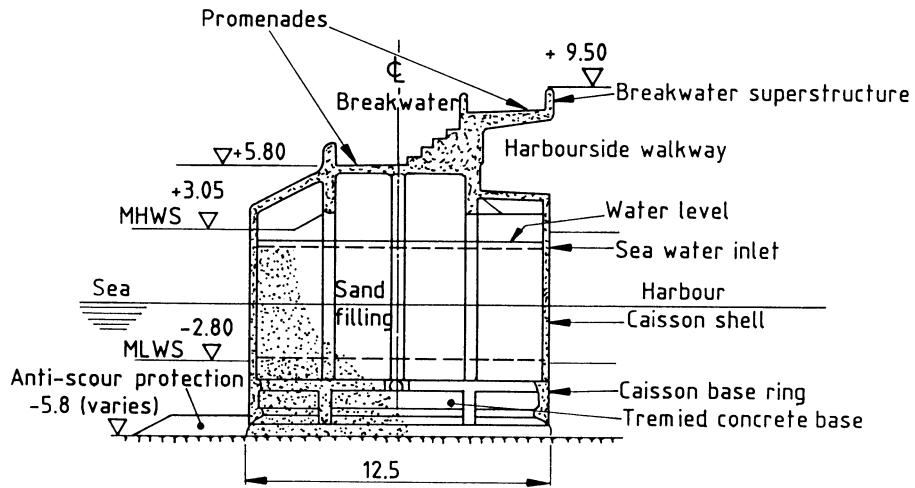

Cross section

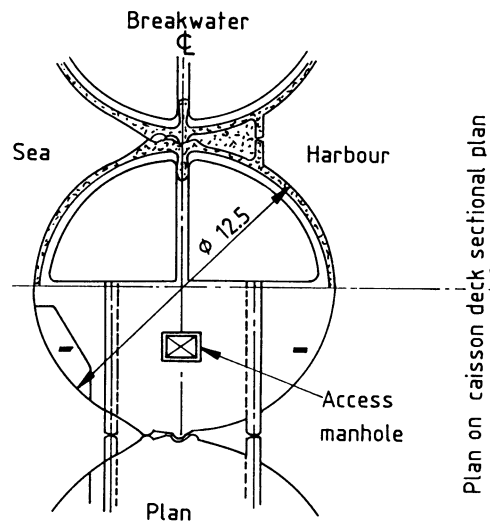

(c) Brighton marina  
 Dimensions in metres.

Figure 18 — Caisson structures (concluded)

Licensed copy: Lee Shau Kee Library, HKUST, Version correct as of 03/01/2015, (c) The British Standards Institution 2013

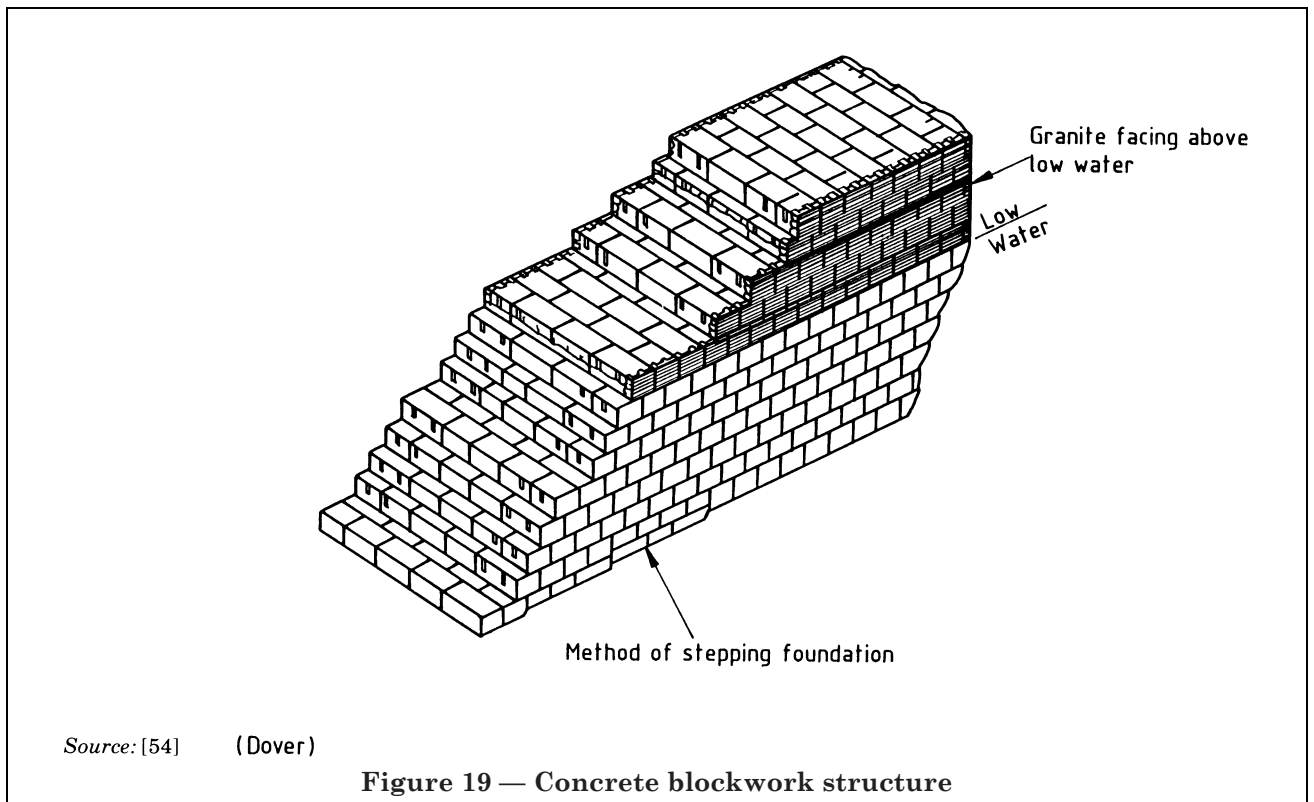

Figure 19 — Concrete blockwork structure

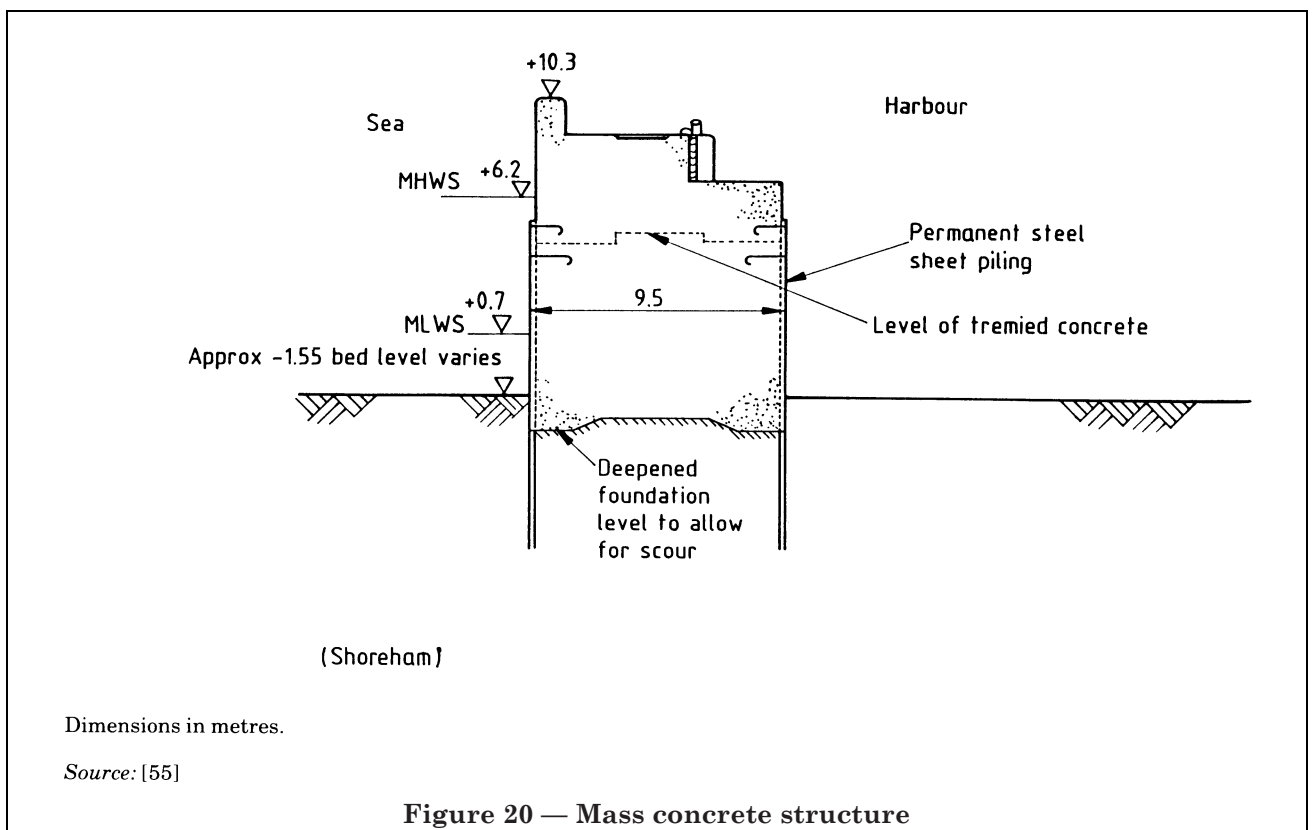
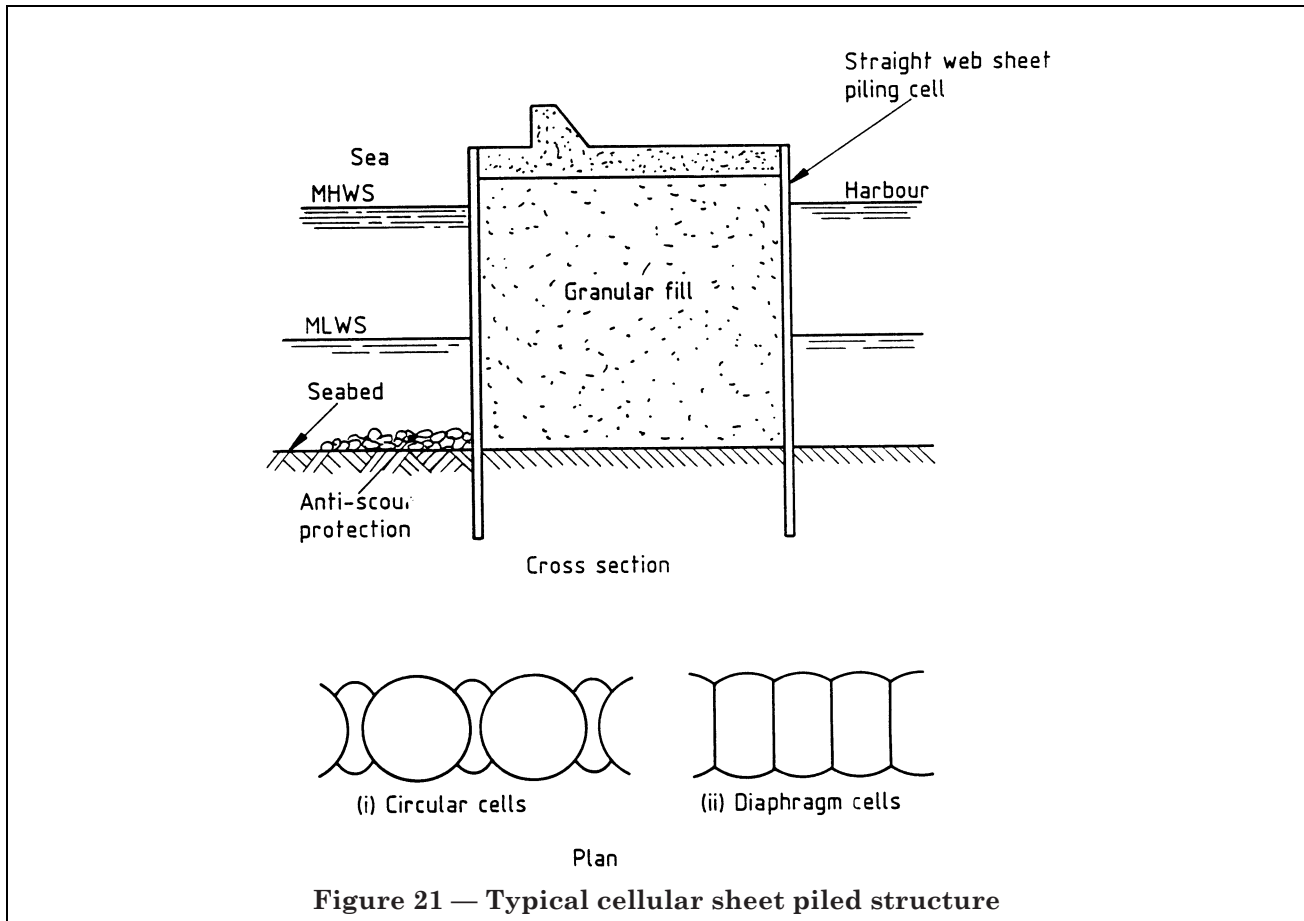
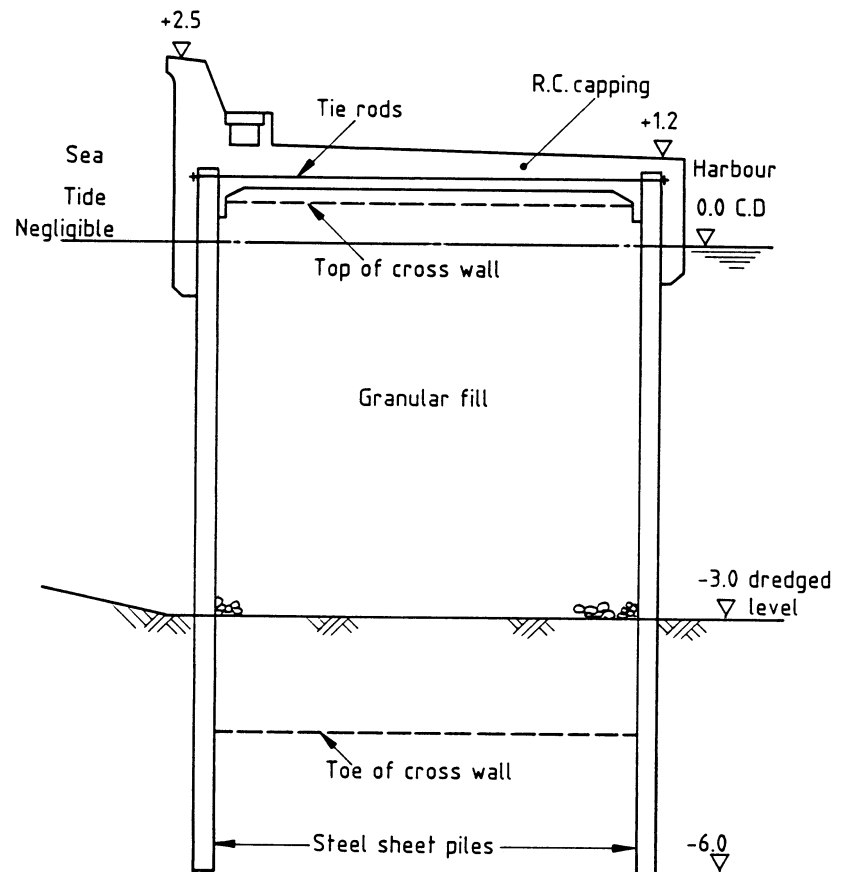

Figure 20 — Mass concrete structure





Dimensions in metres.

**Figure 22 — Double-wall sheet piled structure**



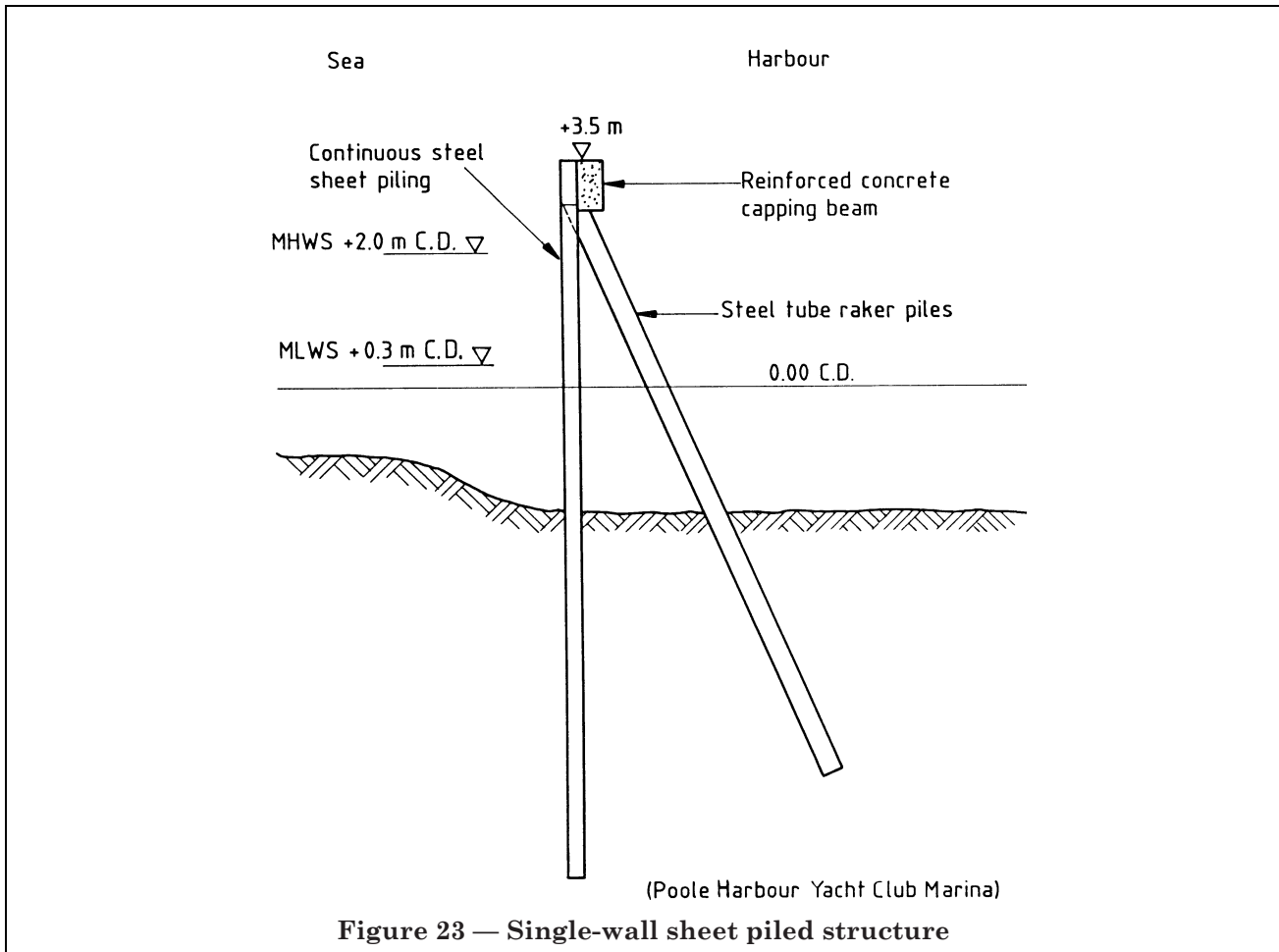

Figure 23 — Single-wall sheet piled structure

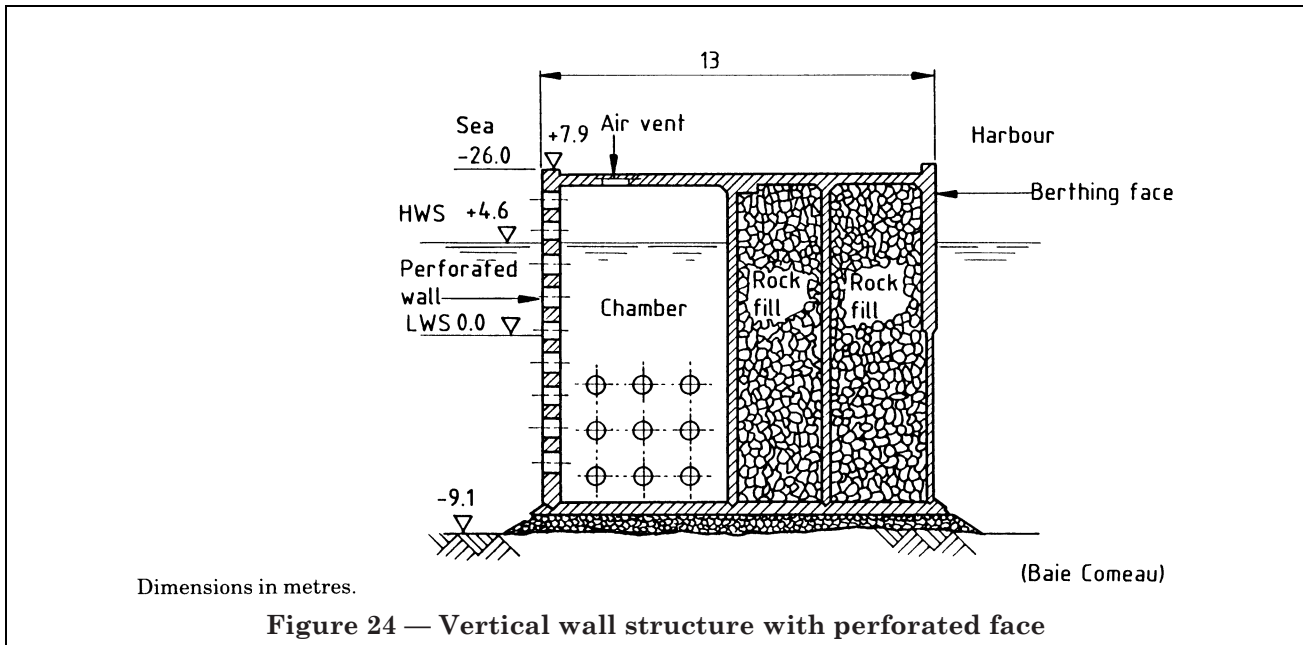
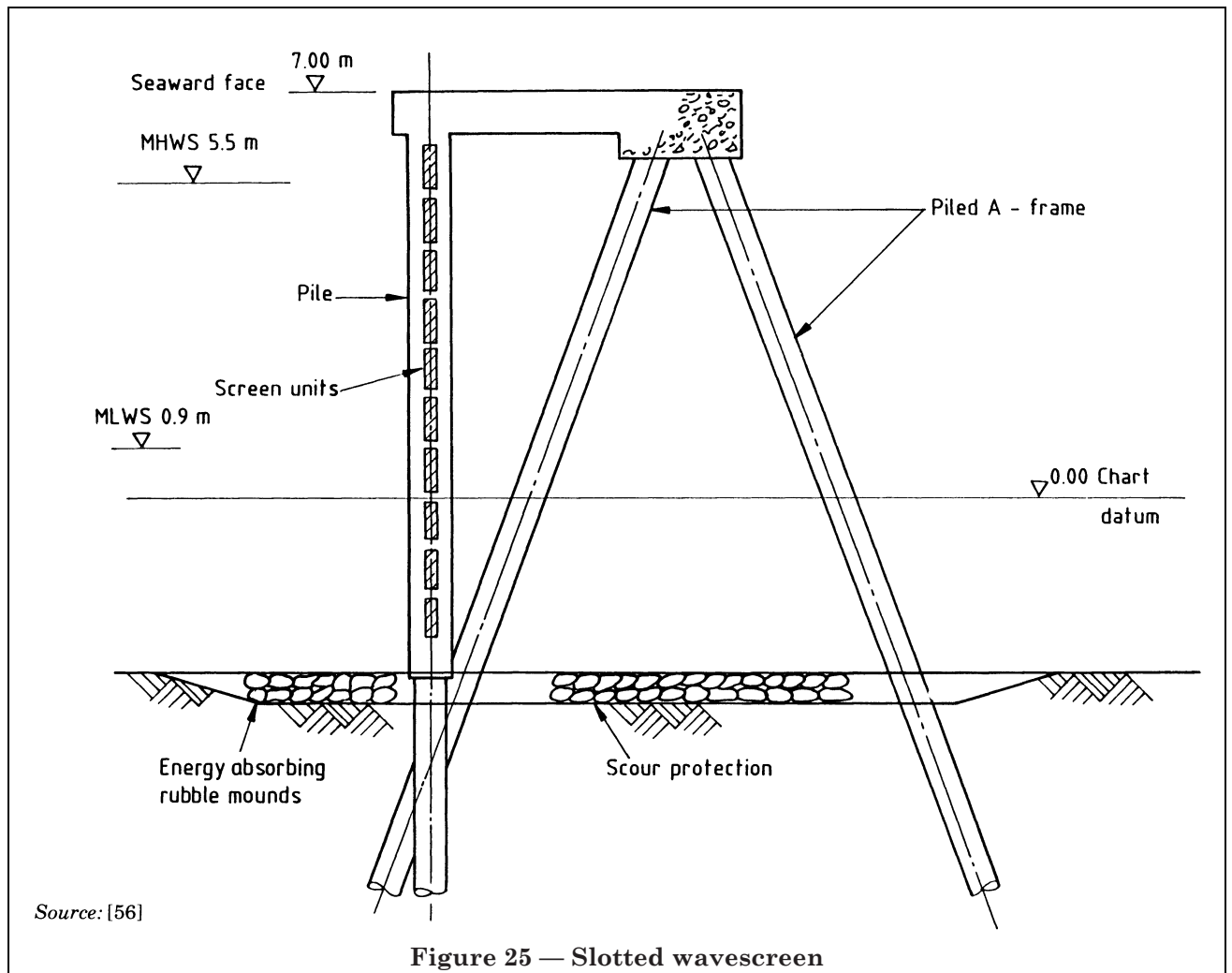
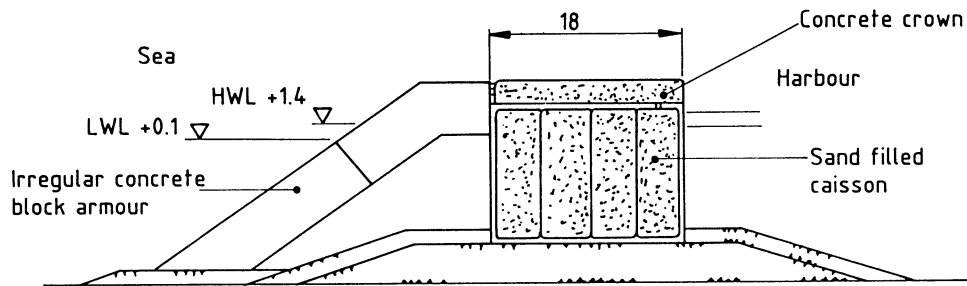

Figure 24 — Vertical wall structure with perforated face





Source: [57]

(a) Armour with underlayers

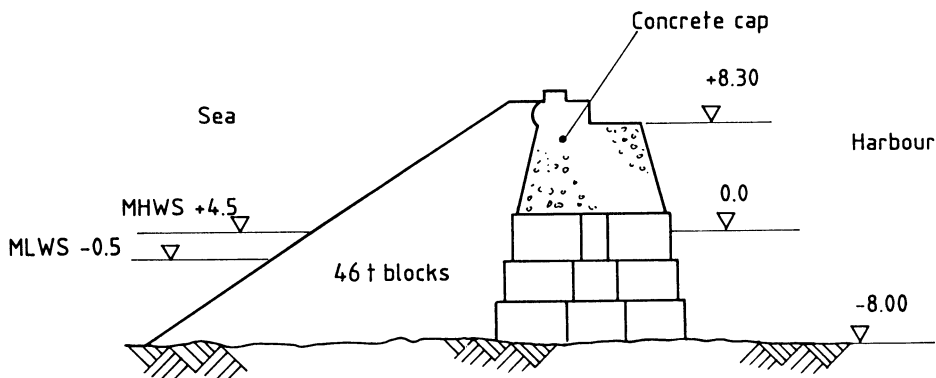

Source: [58]

(b) Armour without underlayers

Dimensions in metres.

**Figure 26 — Vertical wall structures with armour mound at seaward face**

If overtopping is allowed, there will usually be a saving in cost. However, the additional cost of strengthening the top of the structure to withstand the loads imposed by overtopping waves should be taken into account. For economic reasons breakwater structures with a sloping top face will not normally be designed to prevent overtopping and can throw overtopping water some distance into the harbour.

Significant quantities of overtopping water will cause disturbance behind the breakwater and can generate secondary waves in the harbour.

Preliminary estimates of wave transmission due to overtopping can be derived from Figure 27 which is based on tests with regular waves. Many design methods and various results have been suggested [8], but none is conclusive and hydraulic model testing of the structure is recommended.

If a rubble mound is placed in front of the vertical face a preliminary estimate of overtopping can be obtained by determining the run-up as for a rubble mound structure (see 4.2.2).

#### 5.3.2.2 Wave reflection

Wave reflection from a vertical face structure exposed to a non-breaking wave can amount to nearly 100 % of the incident wave energy. The amount of wave energy reflected can be important to ship navigation (see 2.2.2 and 3.5.2.3), and in causing scour seaward of the structure.

Methods of dissipating wave energy have been developed using perforated chambers in the seaward face.

The amount of reflection varies with wave period and cannot be calculated. An example quoted by Goda [62] has a reflection coefficient ranging from 30 % to 70 %.

The use of a rubble mound, or mound of concrete armour units, in front of the vertical face, will reduce wave reflections as well as overtopping. The reflection coefficient in such cases depends upon wave period, the crest height of the rubble and its porosity. Goda [62] quotes 30 % to 50 % for a slope of energy dissipating concrete blocks. The rubble mound can be designed with reference to section 4. Depending upon the height to which the armour units are placed wave reflection off the exposed vertical face can cause disturbance of the units such that larger units can be required than for rubble mound structures.

Other than in the case of the reflection of non-breaking waves from a plane vertical face in deep water, hydraulic modelling is recommended to determine the reflection coefficient. In the case of walls with a perforated face, reflections can vary widely with wave period.

### 5.3.3 Loads

#### 5.3.3.1 Wave loads on vertical walls

The form of wave attack on the structure will be determined by the depth and slope of the sea bed in front and by the steepness and direction of the waves (see 23.4 of BS 6349-1:1984).

Design formulae for wave loads are given in 39.4 of BS 6349-1:1984. These may be used to estimate the stability of simple vertical face structures and to obtain preliminary estimates for other profiles. Further information is given by the Ports and Harbours Research Institute, Japan [57], and by Goda [62].

The formulae, which are based on recent Japanese work, give the wave pressures from breaking and reflected waves. Under breaking wave conditions, high impact forces are generated although some energy is dissipated during breaking. Hydrostatic pressures due to differences of water levels between seaward and rear sides due to wave crests and troughs should be considered separately [62]. Both the total force and its distribution over the face should be assessed for stability calculations.

With some types of construction the vertical face can be either plane or curved in plan. Hydraulic model tests have shown that the total horizontal loads due to wave action are almost the same for plane and curved in plan vertical faces.

Impact loads, which are more critical for the design of small elements rather than the overall stability, can be twice the hydrostatic loads for a plane face and 1.3 times for a curved face [14]. Very high local pressures and water current can be caused in the re-entrant angle of a curved face. Local impact pressure can exceed the hydrostatic pressure by a factor of from 10 to 50. Parts of a structure where impacts occur should be designed for these high pressures. They are of very short duration (less than 0.2 s).

A careful assessment should be made of the distribution of uplift pressures under caissons and other structures which are founded on granular bedding where water pressures can vary under the structure (see 5.3.4).

#### 5.3.3.2 Method of reducing wave loads

Wave loads on the structure can be reduced by any of the following means:

- a) allowing a degree of overtopping;
- b) providing a perforated face;
- c) placing a rubble mound in front of the wall;
- d) sloping the upper part of the face.

It has been claimed that wave loads can be reduced by 60 % by provision of a perforated front face [59]. However, such action is sensitive to wave period, and is not always effective.

Wave loads can also be reduced by covering or partially covering the vertical face with a rubble mound. For preliminary design the method given by the Ports and Harbours Research Institute, Japan [57] can be used to estimate wave loads on the structure.

Horizontal loads can be significantly reduced by provision of a sloping face on the top of the breakwater [see Figure 18(b)]. When the slope starts at design water level the reduction can be up to 50 % but overtopping, which depends on the height and angle of slope, can then be severe. Also the slope face can be subject to high impact pressures due to breaking waves. Wave action on the sloping face produces a vertical component of force which under some circumstances can improve the stability against both sliding and overturning failure.

Opinion is divided as to whether the horizontal and vertical forces on the slope are always in phase with forces on the vertical face.

With sloping faces, wave reflections can be reduced, resulting in shallower troughs and improved stability of the structure against toe scour.

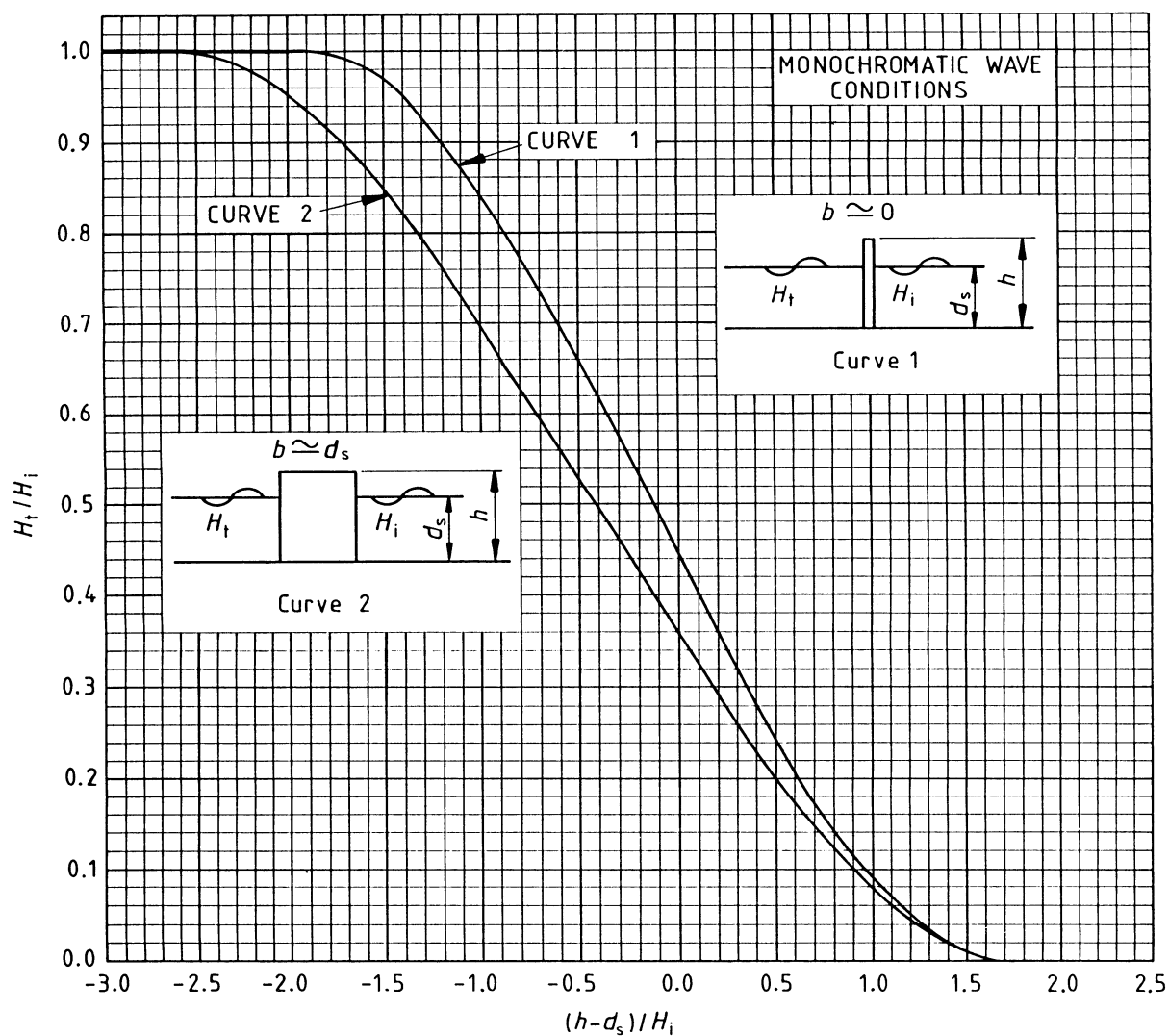
**Key**

$b$ : width of structure (in m);

$d_s$ : depth of water (in m);

$H_i$ : height of incident wave (in m);

$H_t$ : height of transmitted wave (in m);

$h$ : height of structure above sea bed level (in m);

$g$ : gravitational acceleration ( $9.81 \text{ m/s}^2$ );

$i$ : period of incident wave(s).

NOTE. This is applicable to vertical walls and thin-wall breakwaters where  $0.0157 \leq d_s/gT^2 \leq 0.0793$ .

Source: [8]

**Figure 27 — Wave transmission coefficients due to overtopping**



Only in case a), where overtopping of a vertical face is allowed, can the wave loads be fairly reliably estimated, as the design method gives a direct answer. In the other cases, model tests are needed to determine wave loads.

#### 5.3.3.3 Use of hydraulic model tests

Hydraulic model testing should be used to estimate wave loads on all major structures other than fully reflective walls with non-breaking waves.

The recommended procedure for hydraulic model testing is given in 3.6.

Factors which can be investigated are:

- a) wave pressures and total loads, to determine horizontal, vertical and overturning components;
- b) overtopping, to determine quantity and wave transmission to the rear side;
- c) reflection coefficients;
- d) scour protection at the toe.

#### 5.3.3.4 Seismic loads

Guidance on the effects of earthquakes is given in clause 40 of BS 6349-1:1984 and 2.3.8 of BS 6349-2:1988. Design should be based on local earthquake regulations, if these are considered adequate.

For the design of a gravity structure the use of quasi-static methods of analysis of stability will normally be appropriate. They are not necessarily adequate for design of the foundations, where the considerations outlined in 4.7 should be taken into account.

#### 5.3.4 Overall stability

Factors of safety should be assessed for failure by sliding and overturning under the most severe combinations of wave crests and troughs and water levels.

The factors of safety should be calculated as the total effect of the restoring forces divided by the total effect of the disturbing forces.

Where fill material is to be placed behind a breakwater or a rubble mound is placed at its seaward face, the effects of the resulting loads on the structure should be taken into account in stability calculations.

Uplift pressures under caissons can vary between a triangular distribution when there is free drainage at the rear side and full uplift pressures across the base when free drainage does not occur.

Consideration should be given to the possibility that the initial design conditions might not be achieved in service, e.g. if a granular base were to become clogged by fine sediments. In checking safety against overturning the most severe uplift pressures should be considered.

It is suggested that the coefficient of friction between the flat concrete base of a structure and a coarse granular material should not be assumed to be greater than 0.6. With a corrugated caisson base (see 5.4.2) higher values can be appropriate.

It has been suggested [57] that caisson breakwaters can be designed with factors of safety against sliding and overturning of 1.2. However, with the present state of knowledge this value should be considered only in cases where damage or displacement would not impair the function of the breakwater and where the wave climate is well defined. In cases where the operation of berths on the rear side of the breakwater would be endangered or where movement of the structure is not acceptable, factors of safety of between 1.5 and 2.0 could be more appropriate. The selection of particular values requires assessment of risk (see 3.7).

Similar factors of safety should be adopted for other types of vertical wall structure. Particulars of breakwaters which have suffered sliding failure are given by Goda [62].

#### 5.3.5 Foundations

The maximum bearing values transmitted to the foundation material either directly or through a prepared bed should not exceed the values given in Table 1 of BS 8004:1986.

The factor of safety against circular slip or wedge type failure of the foundation should be calculated. Guidance on suitable values is given in BS 6031 and BS 6349-2.

Settlement of the breakwater foundation needs to be assessed and for a vertical face breakwater very little settlement is usually tolerable, so that such structures are usually employed only in good ground conditions.

The causes of settlement listed in 4.7 should be considered.

Replacing any weak foundation material with rubble, gravel or sand fill can provide a solution for both inadequate foundation stability and excessive settlement.

Migration of fine grained material from the ground under the foundation into the rubble base or granular bedding material can be restricted by providing a filter layer. Guidance on filter design is given in 4.4 and by Hedges [27].

The effects of reverse hydraulic gradients on the foundation material are difficult to assess.

An anti-scour apron (see 5.3.6) gives protection against this action.

When a structure is subject to dynamic wave impact loads, repetitive loading can cause build-up of pore water pressures in the ground which can result in liquefaction of fine grained material. Wherever this is possible the fine grained material should be removed and replaced by a rubble foundation and scour protection which will allow rapid dissipation of pore water pressure. Alternatively ground improvement techniques can be used to compact the fine grained material.

### 5.3.6 Anti-scour protection

Wave action at a vertical face will cause severe turbulence at bed level. Where the structure is to be placed upon a levelled and prepared bed of granular material this, and the sea bed in front of the structure, should be protected against scour and possible undermining of the foundation. Scour can also affect rock foundations, particularly those of chalk or similar soft rocks.

Because of the potentially serious consequences of scour in front of vertical wall structures, and because the cost of anti-scour protection is small compared with the cost of the structure, the protection should be designed on a conservative basis. Stone size, profile and the extent of scour protection for major structures should be checked by model testing, particularly where breaking wave conditions occur. For further information see Eckert [41] and Goda [62].

Scour in front of the structure can result in a reduction in bearing capacity and/or passive soil resistance. It is difficult to estimate the extent of scour which can occur even by using model testing. A conservative approach should be adopted in estimating the effects of scour on stability.

The size of stone required for protection against wave action can be determined from equation (7) from the *Shore Protection Manual* [8], which is a form of Hudson's formula (see 4.3.4.2). The results are based on model testing using regular waves.

A few results have been published for non-breaking random waves [63] and these indicate that the following formula is adequate for preliminary sizing of armour stone.

$$W = \frac{W_r H^3}{N_s^3 X^3} \quad (7)$$

where

$H$  is the design wave height at the structure site, in metres (a value of not less than  $H_{1/10}$  is recommended);

$N_s$  is the design stability number for rubble foundations and toe protection;

$W_r$  is the unit weight of rock (saturated surface dry) in newtons per cubic metre;

$X$  is the relative mass density of rock armour, relative to water at the structure, i.e.  $(W_r/W_w - 1)$

$W_w$  is the unit weight of water (fresh water = 9 810 N/m<sup>3</sup>; sea water = 10 050 N/m<sup>3</sup>, typical value).

Values of  $N_s$  for non-breaking wave conditions can be obtained from Figure 28 or from Goda [62], provided that the cases represented therein are comparable with the design conditions.

Consideration should be given to the effects of currents leading to scour of the sea bed (see 14.3 of BS 6349-1:1984). These can be due to tidal effects or caused by reflections of oblique waves off the face of the breakwater. Concentration of currents can occur at changes in alignment and at the end of the breakwater. Some guidance on the size of stone required for protection against currents can be obtained from the Isbash equation for protection of channel beds [42].

In the form derived in the *Shore Protection Manual* [8] this is

$$W = 0.0219 \frac{V^6 W_r}{g^3 X^3} \left(1 - \frac{\sin^2 \theta}{\sin^2 \phi}\right)^{-3/2} \quad (8)$$

where

$W$  is the weight in air of individual stone, in newtons;

$V$  is the maximum current velocity, in metres per second;

$W_r$  is the unit weight of rock (saturated surface dry), in newtons per cubic metre;

$X$  is the relative mass density of rock armour, relative to the water at the structure i.e.  $(W_r/W_w - 1)$

$W_w$  is the unit weight of water (fresh water = 9 810 N/m<sup>3</sup>; seawater = 10 050 N/m<sup>3</sup>, typical value);

$\theta$  is the slope angle;

$\phi$  is the angle of repose of armour stone.

Where currents are combined with wave action it is suggested that the weight of stone required for protection against wave scour should be increased by 50 % [41]. Another approach is to calculate shear stresses due to waves and current and consider their combined effect.

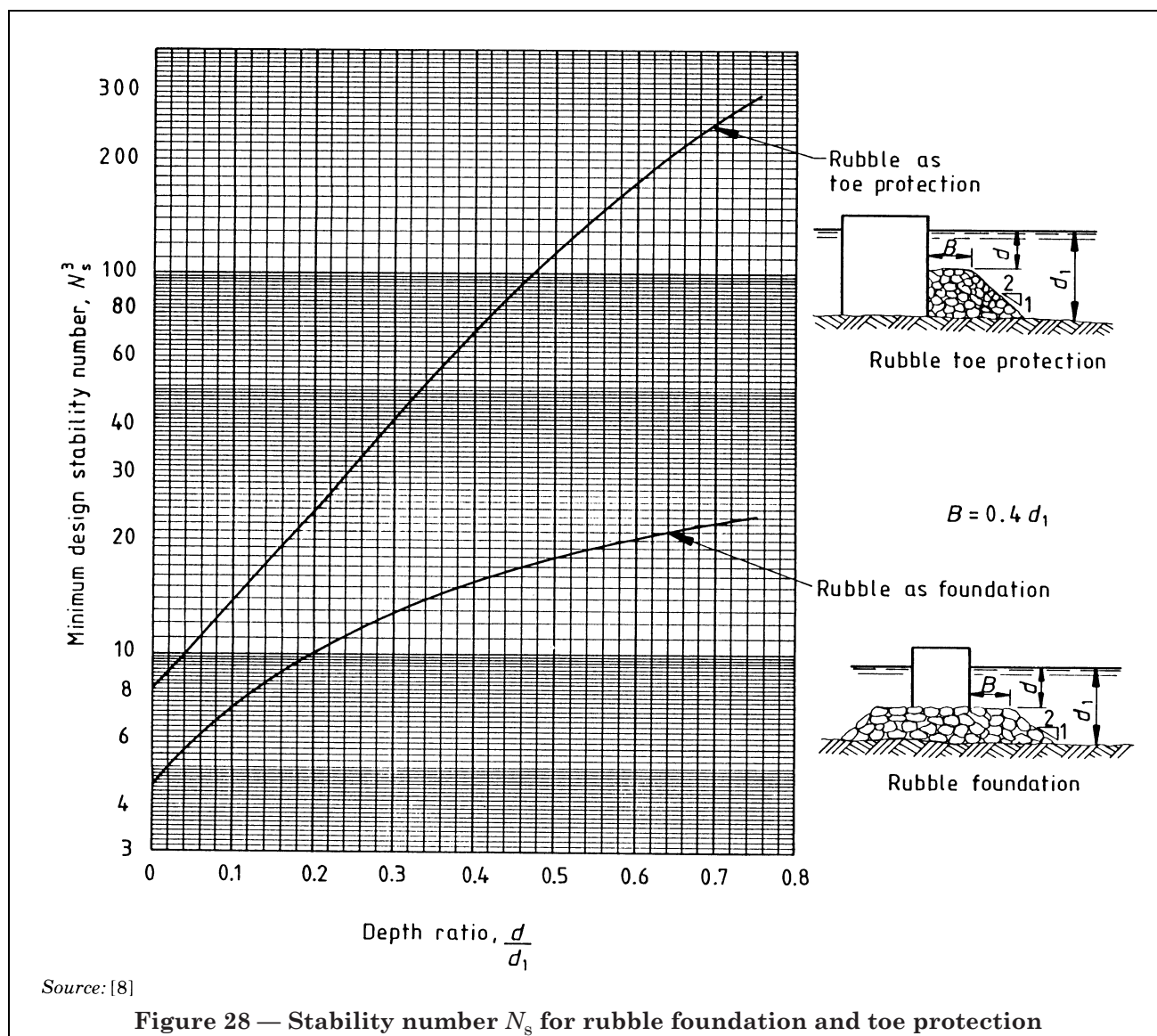

Figure 28 — Stability number  $N_s$  for rubble foundation and toe protection

As construction proceeds, the sea bed at the exposed end of the structure can be subjected to particularly severe scour, comparable with that at the end of the completed structure (see 5.3.8). The need to provide anti-scour protection before or immediately after construction of each length of the vertical wall should therefore be considered.

No definitive criteria have yet been established for determining the required width of anti-scour protection. In general, scour can be assumed to be greatest within one-quarter wavelength of the face of the wall. For preliminary purposes, the apron should be designed to extend to a distance in front of the wall equal to not less than twice the design wave height as defined for equation (7). This distance sometimes needs to be increased to preserve the geotechnical stability of the foundation.

NOTE See 4.6 for further discussion of scour protection design.

### 5.3.7 Crest structures

A high crest wall will normally only be required where it is necessary to eliminate overtopping, in order to protect important installations from damage. A shaped parapet to reverse flow due to uprush can be provided but will not necessarily be effective for large waves of long period causing massive uprush.

In addition to horizontal loads the crest capping structure should also be designed to resist the loads due to large volumes of water falling on it.

The crest structure should be built after any initial settlement of the structure has taken place. Joints should be designed to allow for the effects of subsequent long term settlement.

### 5.3.8 Breakwater head

The head of a breakwater requires special consideration with respect to the factors listed in 4.8.

At the head of a vertical face breakwater there can be significant wave action both inside and outside so that crests and troughs on opposite sides can impose greater total wave forces. It is therefore sometimes necessary to increase the weight of the structure, usually by making it wider.

The sea bed at the head of a vertical face breakwater can be more susceptible to scour than at the head of a rubble mound structure (see 4.8) because of the sudden change in profile. The effects of scour can be reduced as follows:

- a) by providing an outer face which is curved on plan;
- b) increasing the anti-scour protection compared with that required along the trunk of the breakwater: the width of the protection and the weight of stones should be increased by at least 50 %; such protection will need to continue along the main face for a suitable distance.

### 5.3.9 Durability and detailing

The guidance on durability given in 2.4 of BS 6349-2:1988 should be taken into account in the design of vertical wall breakwaters. Properly constructed concrete structures should be more durable in marine conditions than those employing steel sheet piles.

It is recommended that, for durability, the use of steel reinforcement be kept to a minimum by providing mass concrete of appropriate thickness, strength and quality.

The effects on durability of abrasion by sea-borne material should be considered, particularly in the cases of steel sheet piled structures. Abrasion is usually most severe in the beach zone.

Greater economies are generally achieved by aiming at simplicity of construction and robustness of design than by trying to reduce the quantities of materials in the structure by the use of complicated details.

## 5.4 Caisson structures

### 5.4.1 General

Structures comprising reinforced concrete caissons are a common form of vertical face breakwater. They can be designed either for floating into position and sinking or for lowering directly to the sea bed using a crane travelling on the completed work or floating plant.

Floating caissons are generally multi-cellular structures and can be constructed to almost any size compatible with ground conditions and construction methods. Non-floating caissons are usually single circular cells and open-bottomed: their size is limited by available lifting capacity.

Many aspects of the design and construction of caissons described in 5.6 of BS 6349-2:1988 apply also to caissons for breakwaters. In general greater tolerances are required in the more exposed conditions of breakwater construction. Additional points particular to breakwaters are discussed in 5.4.2 to 5.4.7.

### 5.4.2 Shape

Floating caissons are generally constructed with a flat base to rest on a prepared level bed [see Figure 18(a) and Figure 18(b)]. The bases of caissons are sometimes cast on corrugated formwork to give a rough underside to the base in order to increase the resistance to sliding (see 5.3.1.4 of BS 6349-2:1988). Caissons are mostly of rectangular shape in plan and usually subdivided into cells for strength and for control of stability during towing, sinking into position and filling when in the final position. The face of each cell can be either plane or curved on plan.

Where the foundation is rock, open-bottom circular caissons can be used. These are generally single cell structures placed by a crane running on previously placed cells. After the caisson has been positioned on the sea bed, the base should be completed using tremie concrete [see Figure 18(c)]. Alternatively closed-bottom caissons suitable for floating into position provided with downstand stub walls which form a shear key with trenches excavated into the rock surface can be used.

Where the foundation level along the breakwater varies, it will in general be economic to provide caissons of similar plan shape throughout the structure. The height of the units will vary along the breakwater.

The seaward cells of a floating caisson can be designed to provide a perforated face and wave chamber, but account then has to be taken of the special problems of floating stability and attitude during sinking.



### 5.4.3 Foundations

Floating caissons are normally placed on a prepared granular foundation.

A caisson can be subjected to severe wave action soon after positioning. Scour protection on the seaward side should, therefore, be placed and completed as soon as possible after positioning. If construction has to be stopped because of a storm, the end caisson is particularly susceptible to undermining by scour. Temporary scour protection sometimes has to be provided at the ends and this will need to be removed before construction can recommence. It can be advisable for model tests to be carried out to investigate the extent of the temporary protection required.

Where the foundation is stepped to accommodate caissons of different heights, it is necessary to place the deeper caisson first even though this will imply working from the deeper seaward part of the breakwater. Particular care should be taken in the design of the foundations at the junction to avoid differential settlement and scour.

### 5.4.4 Floating condition

For towing and positioning, suitable anchor points for towing wires should be provided in the structure. For towing in open sea conditions, where wave action can be severe, a watertight deck should be provided.

Where ballast is required for stability, its movement will be restricted in a cellular form of caisson.

However, if cells are very large it is sometimes necessary to provide temporary bulkheads.

The whole operation of positioning should be carefully planned so that tugs, winches and anchors are properly co-ordinated and flooding valves opened in the correct sequence.

A thorough analysis of weather conditions and wave climate should be carried out to verify that sufficient periods of calm are available to allow for preparation of sea bed, positioning and sinking of the caissons so that reasonable progress in construction can be achieved.

### 5.4.5 Fill

Filling should be carried out as soon as the caisson is correctly positioned. Seaward compartments except where they are designed as perforated should always be completely filled for stability under wave loading. Rear compartments can be partially filled to reduce maximum bearing pressures and provide increased stability. In designing for this condition the outward forces due to water level differences when the wave trough is at the seaward face of the wall should also be considered.

Fill is usually of sand but seaward compartments can be filled with lean concrete to provide increased resistance to impact loads.

### 5.4.6 Joints between caissons

Gaps between caissons should generally be closed to prevent water movement and to protect the bedding layer from scour by high velocity currents caused by wave action; Figure 29 shows typical joint details.

Keyed joints are sometimes necessary to transmit load between caissons to avoid relative movement. It has been suggested [64] that keyed joints should be capable of transmitting in shear 25 % of the maximum horizontal load on either caisson to the adjacent unit. Except where caissons are placed on a rock foundation some relative settlement is likely to take place and joints should provide for vertical movement.

The joint seal on the seaward face should be made as close as practicable to the seaward face to keep the depth of the gap between caisson walls to a minimum. If the water is likely to be heavily laden with sediment, especially gravel, it could be necessary to provide additional thickness of concrete to allow for erosion of the joint surface.

Where storm wave action is possible at any time during construction the joint should be completed as soon as possible but where a reasonably calm period can be forecast with confidence it is sometimes better to allow primary settlement to take place first.

Where differential settlement between caissons is possible the joint faces should be painted with a slip coat such as bitumen to avoid bond between the joint plug and the caissons. The gap can be sealed at the face using a grout sock or tube, with tremie concrete being used to form the joint plug.

### 5.4.7 Crest structure

If a crest structure is provided it is usual to complete it after caisson sinking and filling in order to obtain a good line. The choice of how much of the superstructure to prefabricate with the caisson depends on the overall design, flotation depth and stability. The crest structure, with or without a sloping face, usually creates an unsymmetrical cross section which can cause sinking difficulties.



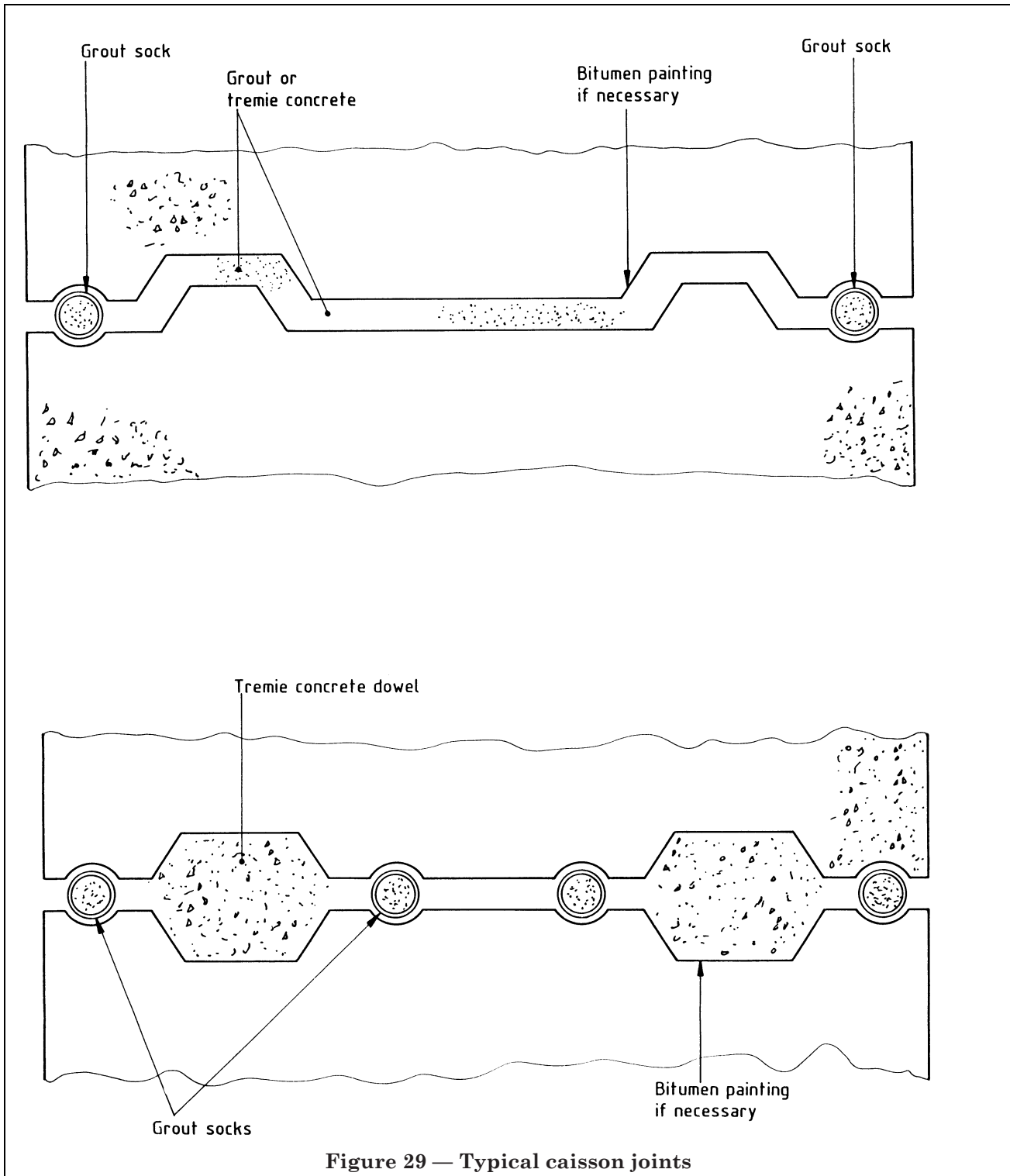

Figure 29 — Typical caisson joints

## 5.5 Concrete blockwork structures

Precast concrete blockwork has been used for the construction of breakwaters for a considerable time and longstanding examples can be found at Dover and Peterhead. Some of the details used there are now unlikely to be economic. Guidance on the design and construction of concrete blockwork walls is given in 5.4 of BS 6349-2:1988, and can be used in the design of blockwork for breakwater construction although breakwaters are normally free standing rather than earth retaining structures. Additional points particular to breakwaters are discussed below.

A prepared base of either rubble or concrete is usually needed for blockwork construction; bed preparation by divers requires calm weather. For accurate placing of blocks the block placing crane can be mounted on the previously constructed wall.

Where foundation settlement is unlikely to be significant, bonded blockwork should be used. The blocks should in general be interlocked to strengthen the mass of the breakwater and the joints should be sealed and grouted in order to prevent the build-up of air pressure caused by wave action.

In the past, sliced blockwork has been used to allow for the effects of unequal settlement. Sliced blockwork construction is unsuitable at corners owing to the large number of different block types required. Reversion to vertical jointing is usually necessary at corners and ends of slice work.

Forms of blockwork construction which incorporate large voids in the seaward face have been used to reduce wave reflections.

If the sea bed is rock and the blocks are bedded on in situ concrete, it is important to achieve a good bond between the rock and concrete foundation layer to prevent transmission of water pressure through cracks. With soft sedimentary or weakly cemented rocks, erosion can be caused at the interface by wave action particularly when sand is carried in suspension.

Particular attention should be given to anti-scour protection (see 5.3.6 and 5.4.3).

## 5.6 Mass concrete structures

For guidance on the design and construction of in situ mass concrete structures see 5.9 of BS 6349-2:1988.

Figure 20 shows an example which was constructed within a steel sheet pile cofferdam, the piling forming a permanent facing. Where the foundation material is rock and the site dries out at low water, steel sheet piling is not needed and construction can be carried out tidally.

The mass concrete filling within a cofferdam can be placed by either of the following methods depending on the permeability of the ground.

- a) Place concrete underwater by tremie or bottom opening skip up to low water level and continue construction above this level tidally.
- b) Place a plug of underwater concrete to seal the base and then de-water, continuing construction above this level in the dry. This method requires calmer sea conditions than the first as the cofferdam is more liable to damage by wave action. The plug should be designed to resist uplift pressures, or pressure relief drains leading to pump sumps should be provided.

Shuttering can be used inside the cofferdam to enable the upper part of the sheet piling to be recovered. The lower part of the piling is left in place.

Where the sea bed is liable to fluctuation in level and abrasion of the steel piling by bed material is likely, the base of the concrete should be set about 1 m below the lowest predicted bed level. This is necessary to guard against undermining of the concrete in the event of holes forming in the piles below the concrete.

Where the foundation level varies, care should be taken to avoid weakening the foundation with sudden changes or large steps.

## 5.7 Cellular sheet piled structures

### 5.7.1 General

Guidance on the design of cellular sheet piled structures is given in 5.7 of BS 6349-2:1988. Figure 21 shows a typical example.

This type of structure can be constructed in depths of water up to about 12 m.

Impact pressures can cause deflection of piles and failure of the clutches. This type of construction should therefore not be used where heavy wave action or breaking waves can occur; it can be more suitable for temporary protection than for a permanent breakwater.

Cellular sheet piled structures are particularly liable to damage by wave action during construction before internal filling is complete. Each free standing cell should therefore be filled as soon as the piles have been installed. For continuous diaphragm cell construction (see detail ii) on Figure 21), a carefully controlled sequence of filling should be used as each section is closed.

Abrasion of steel sheet piles by granular sediments (especially small sized gravel) carried by wave action can limit their life.

Corrosion should also be considered. Typical rates of corrosion for steel in UK maritime conditions are given in Table 22 of BS 6349-1:1984. The design life will depend largely on the thickness of metal in the sheet piles. Cathodic protection and other methods of protection against corrosion should be considered.

### 5.7.2 Anti-scour protection

As straight web piles cannot be driven into hard materials, cellular sheet piled structures are very vulnerable to damage by scour at the base.

Scour protection should be provided where there is any risk of bed material being eroded by wave action (see 5.3.6). Scour protection will have the dual function of preventing scour and reducing the quantity of material moving at bed level which can cause abrasion of the piles.

### 5.7.3 Crest structures

Crest structures should not be made integral with or supported on the straight web steel sheet piles as this can prevent the development of the necessary tensile forces in the clutches. Supporting the crest structure on the fill allows further settlement of the fill and the weight of the crest structure resting on it contributes to the shear strength of the complete structure.

The intersection between cells should not be covered by the crest structure if it is liable to be subjected to wave uprush which will be concentrated in this area by the curved walls. If a wave wall is required to prevent or reduce overtopping it should therefore be sited behind the seaward side intersections between adjacent cells.

The crest structure should be constructed only after the main initial settlement is complete. If overtopping is liable to cause erosion of fill before settlement is complete, temporary surfacing should be provided.

## 5.8 Double-wall sheet piled structures

Guidance on the design of double-wall sheet piled structures is given in 5.8 of BS 6349-2:1988. Figure 22 shows a typical example.

Such structures can be used in preference to cellular straight web sheet piled structures when heavier piles are required for driving and thicker sections needed to resist corrosion.

It is essential that transverse bulkheads are provided at regular intervals for lateral stiffness during construction and in service and to limit damage and loss of fill in the event of damage to piles. A bulkhead interval of three to five times the overall structure width is commonly adopted.

Where the sea bed is formed of granular material abrasion can occur within the pans of the pile section due to bed material becoming trapped by oblique wave action.

Crest structures can be made integral with the piles. Pile stiffness is increased by fixing the head and if a structural slab is provided some wave loading can be transmitted to the lee side piles.

Settlement of the fill material will normally continue after construction so it will be necessary to design the capping to be wholly supported either on the piles or the fill.

## 5.9 Single-wall sheet piled structures

Guidance on the design of single-wall sheet piled structures is given in section 4 of BS 6349-2:1988. Figure 23 shows a typical example.

Such structures are only suitable for resisting moderate wave action. Independent single-wall structures should be buttressed by raking piles or other means to resist wave pressures. Where ground conditions permit, structures in very shallow water can be designed as cantilevers to resist mild wave action by bending alone.

The top of the structure should incorporate a capping or waling to provide continuity in resisting wave loading. Wave action will cause reversal of stress in the piles and the soil. Allowance should therefore be made for fatigue due to cyclic loading, when calculating working stresses.

Single-wall sheet piled structures rely for their stability on penetration below bed level. It is essential that sufficient depth of scour is allowed for in the design of the sheet piles or scour protection provided. The end of a single-wall sheet piled breakwater is particularly liable to scour due to currents and wave action.

## Section 6. Composite structures

### 6.1 General

This section gives recommendations and guidance on the design and construction of composite breakwater, as defined in 1.2. Reference should also be made to sections 4 and 5 as appropriate.

### 6.2 Types of structure

Figure 30 illustrates cross sections of typical composite breakwater structures.

This type of structure can be used as a breakwater in very deep water, when the volume of rock required for a rubble mound structure is not available, when it is not practicable to design a vertical face structure to carry the design wave loading to the full depth or to reduce the cost. Many examples of such structures can be found in the Mediterranean, Japan and South American Pacific Ocean ports.

The vertical face structure can comprise reinforced concrete caissons or precast concrete blockwork. Variations in water depth can be accommodated by the rubble mound, so that the base of the vertical structure can be horizontal throughout the breakwater.

### 6.3 Design of composite breakwater structures

#### 6.3.1 Introduction

The main factors to be considered in the overall design of composite structures are choice of cross section, hydraulic performance, loads, overall stability and design of the principal elements of the structure.

#### 6.3.2 Factors affecting choice of cross section

It is recommended that, unless wave data is extremely good and thorough model testing is carried out, the composite type of breakwater should only be used when the depth of water is such that all waves are reflected and breaking waves do not occur against the vertical face. Design formulae for wave forces should only be used for preliminary design.

To achieve total reflection of waves by the structure the following ratios have been suggested [65].

$$d \geq 0.75d_1$$

$$d_1 \geq 1.8H_{1/10}$$

where

$d$  is the depth of water at the toe of the vertical face;

$d_1$  is the depth of water at the toe of the rubble mound.

If however  $d_1$  is much greater than  $1.8H_{1/10}$ , then  $d < 0.75d_1$  is however, permissible.

Variations in tidal level should be taken into account in using the above guidelines.

The crest level of the rubble mound should be determined from an optimization of all factors in design, construction and cost. Where the superstructure comprises caissons to be floated into position, the depth required for flotation should be taken into account when determining the crest level of the rubble mound.

#### 6.3.3 Hydraulic performance

For discussion of the hydraulic performance of the superstructure of composite structures, reference should be made to 5.3.2. For guidance on the permeability of the rubble mound, refer to section 4.

#### 6.3.4 Loads

For general guidance on the loads acting on vertical face structures, refer to 5.3.3.

The design formula for wave pressures given in 39.4 of BS 6349-1:1984 is based on work carried out in Japan and has been tested against data from 21 breakwaters where damage due to sliding has occurred. It is meant to be applicable for all types of wave attack varying from totally reflective to breaking waves. The latter can take the form of either plunging breakers causing high shock pressures or surging breakers. These forms can be affected by the geometry of the rubble mound, particularly when  $(d_1 - d)/d$  (see 6.3.2) is greater than 0.4 to 0.5. The width of the berm also has an influence. Guidance is given by Goda [62].

Reductions in wave pressures and loads on the vertical structure can be achieved with a perforated face and wave chamber or by provision of a sloping top surface to the breakwater.

#### 6.3.5 Overall stability

Overall design requires investigation of the stability both of the mound and of the superstructure. It is necessary to combine many of the considerations required for the design of rubble mound and vertical face structures (see 4.2.3 and 5.3.4).

Figure 31 illustrates some of the failure modes of the various elements of a composite breakwater structure.

The principal causes of failure of composite structures are scour of the rubble mound and large wave loads causing displacement of the vertical face structure. Failure of the rubble mound can lead to failure of the vertical face structure by undermining of its foundations causing collapse to seaward and/or by an increase in uplift pressure causing failure by sliding. It is therefore recommended that a conservative approach be adopted for design of the armour protection to the rubble mound.

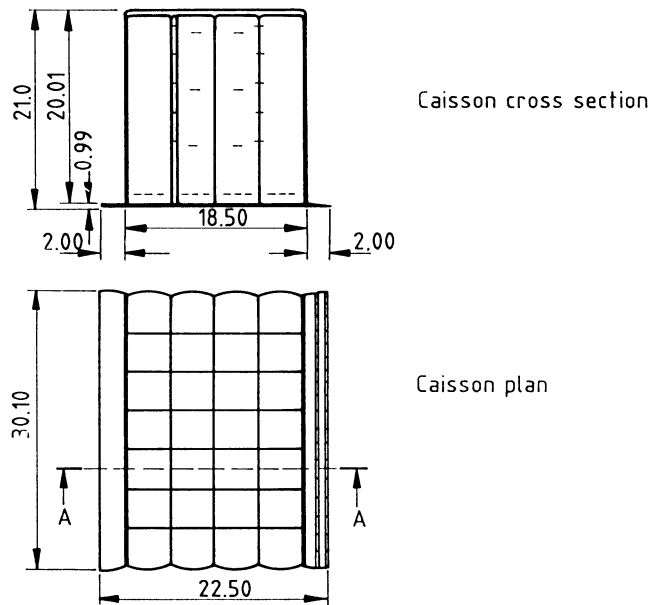
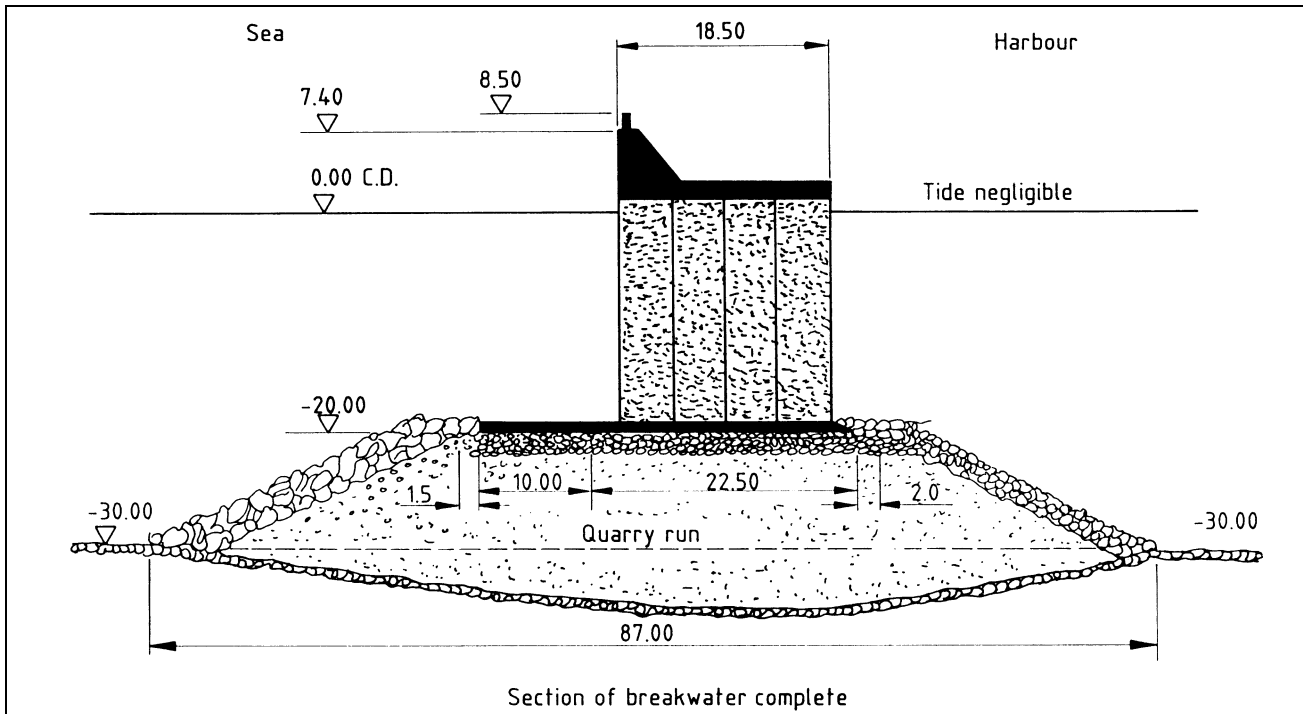

Source: [65]  
 (a) Floating caisson  
 Dimensions in metres.

Figure 30 — Typical composite breakwater structures



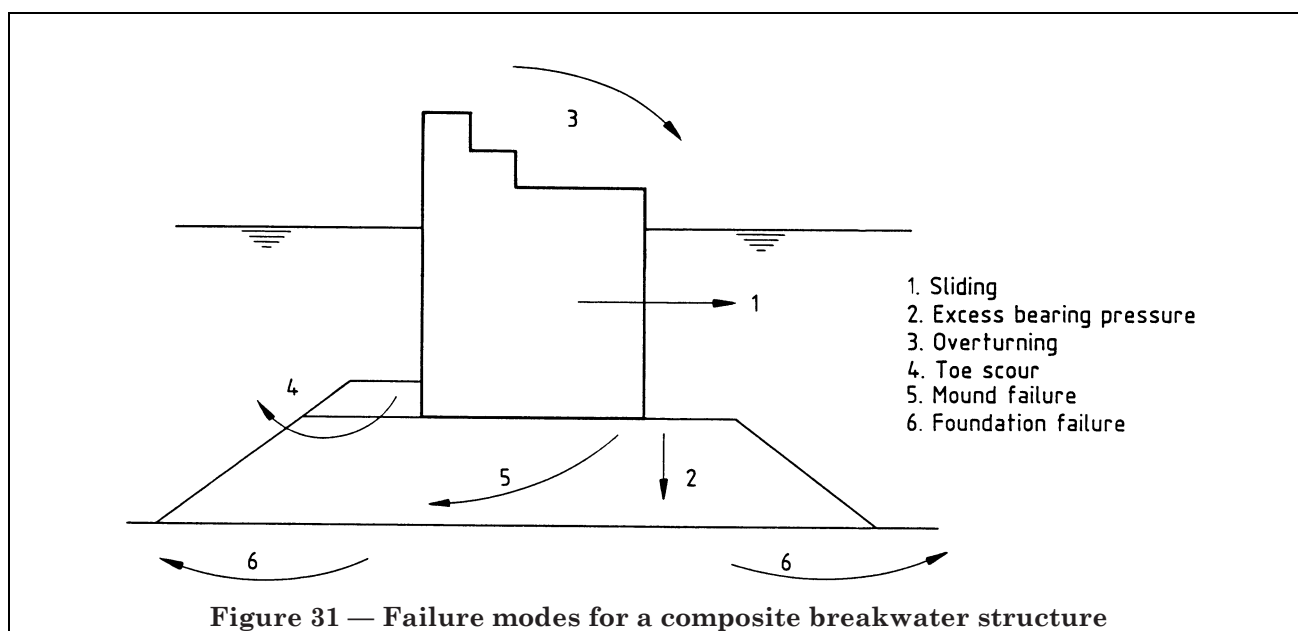
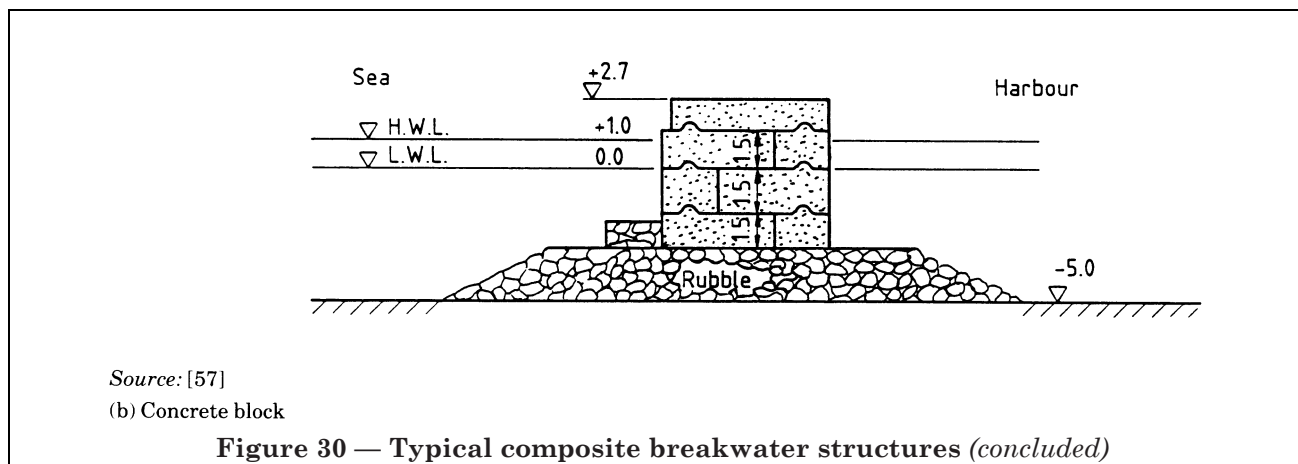

Uplift pressures (see 5.3.4) can vary from a triangular distribution when the base is on a permeable mound to uniform pressure if dissipation of pressure on the rear side is restricted. This can occur if the rear side of the mound becomes clogged with fine grained material.

The coefficient of friction between the base and the rubble mound should not be assumed to be more than 0.6. It is possible for friction to increase with time.

In cases where movement of the vertical structure due to sliding would not affect its function, factors of safety as low as 1.2 have been suggested. However, the condition where whole sections of the vertical structure can slide off the rubble mound is one in which this factor of safety would not be acceptable.

Factors of safety against overturning or sliding should normally be 1.5 to 2.0 depending upon the consequences of failure, and the degree of confidence in the wave climate.

### 6.3.6 Substructure and foundations

At present, it is not possible to describe satisfactorily the velocities and accelerations of wave motion occurring in front of a composite structure. If pure standing waves occur the maximum horizontal velocity will occur at a distance of one-quarter of a wavelength in front of the wall. This will generally be greater than the width of the mound in front of the vertical face.

For general design of the rubble mound structure refer to section 4. Preliminary sizing of armour stone for the rubble mound should be made using equation (7) which is applicable to the sloping face of the mound. However, it can result in an underestimate of the weight of armour on the top which is subjected both to hydrostatic uplift and to the forces arising from wave action on the vertical face. An alternative approach is described by Jensen [63].

Precast concrete blocks or slabs are often used to form the armour on the berm. These units are usually a minimum of 10 t, but can be up to 30 t or more [57]. Since these closely spaced units are more susceptible than rock armour to uplift pressures, pressure relieving holes can be required for stability. The stability of armour at the top of the slope will be affected when the berm crest is formed of concrete slabs because these are virtually impervious to the transient effect of wave action.

The crest and top of the slope are the most critical parts for overall stability. For preliminary design the crest width of the mound in front of the vertical wall should be at least 5 m or be able to accommodate at least five armour stones or units.

The stability of the sea bed material should be checked (see 4.6 and 5.3.5) and toe protection provided if necessary.

### 6.3.7 Superstructure

For design of the superstructure, refer to section 5.

## 6.4 Construction

Guidance is given in 4.11 for rubble mounds, in 5.4 for caissons and in 5.5 for concrete blockwork structures.

The rubble mound will be constructed using floating plant and/or a jack-up platform. Suitable weather conditions are required for construction and during design an analysis of annual weather statistics should be made to check that sufficient calm periods are available to allow reasonable progress.

The surface of the rubble core should be carefully levelled to provide an even bearing for floating caissons and other types of superstructure as appropriate. The wide grading normally allowed for core material is not always suitable and a special levelling layer will usually be necessary. This layer should have a minimum thickness of 0.5 m and a maximum stone size of 100 mm. It is important to protect this material from scour by wave action. Tolerances in level for bedding under floating caissons and interlocking blockwork can be up to 150 mm but greater variations are sometimes acceptable under sliced blockwork.

If caissons are placed by lifting into position it is sometimes possible to seat them onto core material. To develop a key and to fill any voids, tremie concrete can be used in calm weather conditions.

It is desirable to construct the rubble mound as long a period as possible in advance of caisson placing to allow settlement of the mound and the sea bed soil. To do this the temporary stability of the mound should be assured, if necessary by providing temporary protection to the crest.

Settlement of the superstructure can continue for some time after completion and joints should be designed to allow for this.

## Appendix A Bibliography

### A.1 Publications referred to in the text

1. ALLSOP, N.W.H., A.P. BRADBURY, A.B. POOLE, T.E. DIBB, and D.W. HUGHES. *Rock Durability in the Marine Environment*. Report SR 11. Wallingford; Hydraulics Research, 1985.
2. CLIFFORD, J.E. The design process. In: [66].
3. MYNETT, A.E., W.J.P. DE VOOGT, and E.J. SCHMELTZ. West breakwater — Sines, wave climatology. In: *Coastal Structures 1983*. New York: American Society of Civil Engineers.
4. ANDREWS, K.S., N.M.C. DACUNHA, and N. HOGBEN. *Wave Climate Synthesis Report*. Report R149. National Maritime Institute, January 1983.
5. *Global Wave Statistics*. British Marine Technology Ltd., 1986.
6. BATTJES, J.A. A review of methods to establish the wave climate for breakwater design. *Coastal Engineering*, May 1984, **8** (2).
7. LIANG, N.K., and G.C. CHIEN. A typhoon wave hindcasting technique. In: *Proc. 19th Conference on Coastal Engineering*. New York: American Society of Civil Engineers, 1984.
8. U.S. ARMY CORPS OF ENGINEERS. *Shore Protection Manual, 1984*, vols I and II. Fort Belvoir: Coastal Engineering Research Centre. Obtainable from the Superintendent of Documents, US Government Printing Office, Washington DC 20402.
9. ALCOCK, G.A., and D.J.T. CARTER. Extreme events in wave and water levels. In: [61].
10. FUKUDA, N., T. UNO, and I. IRIE. Field observations of wave overtopping of wave absorbing revetment. *Coastal Engineering in Japan*, 1984, **17**.
11. JENSEN, O.J. *A Monograph on Rubble Mound Breakwaters*. Danish Hydraulic Institute, 1984. Obtainable from Danish Hydraulic Institute, Agern Allé 5, DK-2970 Hørsholm, Denmark.
12. BRADBURY, A.P., N.W.H. ALLSOP, and R.V. STEPHENS. *Hydraulic Performance of Breakwater Crown Walls*. Report SR 146. Wallingford: Hydraulics Research, March 1988.
13. CHRISTIANSON, F.T., P.C. BROBERG, S.E. SAND, and P. TRYDE. Behaviour of rubble mound breakwater in directional and uni-directional waves. *Coastal Engineering*, August 1984, **8** (3).
14. VAN DE MEER, J.W., and E. BENASSI. Wave forces and impacts on a circular and square caisson. In: *Proc. 19th Conference on Coastal Engineering*. New York: American Society of Civil Engineers, 1984.
15. HALL, L.R., and W.F. BAIRD. Structural design procedures for concrete armour units. In: *Proc. 19th Conference on Coastal Engineering*. 1984.
16. METTAM, J.D., and J.G. BERRY. Factors of safety for the design of breakwaters. In: *Proc. 18th Conference on Coastal Engineering*. New York: American Society of Civil Engineers, 1982.
17. CIAD PROJECT GROUP. *Computer Aided Evaluation of the Reliability of a Breakwater Design*. Zoetermeer, Netherlands; CIAD-III, 1985.
18. ALLSOP, N.W.H., L. FRANCO, and P.J. HAWKES. *Wave Run-up on Steep Slopes. A Literature Review*. Report SR 1. Wallingford: Hydraulics Research, 1985.
19. ALLSOP, N.W.H., P.J. HAWKES, F.A. JACKSON, and L. FRANCO. *Wave Run-up on Steep Slopes: Model Tests Under Random Waves*. Report SR 2. Wallingford: Hydraulics Research, 1985.
20. OWEN, M.W., *Design of Sea Walls Allowing for Wave Overtopping*. Report EX 924. Wallingford: Hydraulics Research, 1980.
21. JENSEN, O.J., and T. SORENSEN. Overspilling/overtopping of rubble-mound breakwaters. *Coastal Engineering*, 1979, **3**.
22. POWELL, K.A., and N.W.H. ALLSOP. *Low Crest Breakwaters, Hydraulic Performance and Stability*. Report SR 57. Wallingford: Hydraulics Research, 1985.
23. BARENDTS, F.B.J. Geotechnical aspects of rubble mound breakwaters. In: [61].
24. ALLSOP, N.W.H., and L.A. WOOD. *Hydro-geotechnical Performance of Rubble Mound Breakwaters: a Literature Review*. Report SR 98. Wallingford: Hydraulics Research, March 1987.
25. VAN DE MEER, J.W. Stability of breakwater armour layers — design formulae. In: [61].
26. TIMCO, G.W., E.P.D. MANSARD, and J. PLOEG. Stability of breakwaters with variations in core permeability. In: *Proc. 19th Conference on Coastal Engineering*. New York: American Society of Civil Engineers, 1984.
27. HEDGES, T.S. The core and underlayers of a rubble mound structure. In: [66].
28. BARTON, N., and B. KJAERUSLI. Shear strength of rockfill. *Proc. American Society of Civil Engineers*, 1981, **107** (G T7).
29. CHARLES, J.A., and M.M. SOARES. Stability of compacted rockfill slopes. *Geotechnique*, 1984, **34** (1).

30. BAIRD, W.F., and K.R. HALL. The design of breakwaters using quarried stone. *In: Proc. 19th Conference on Coastal Engineering*. New York: American Society of Civil Engineers, 1984.
31. GRIMALDI, F., and F. FONTANA. Redesign of main breakwaters of Gioia Tauro (Italy). *In: International Symposium on Maritime Structures in the Mediterranean Sea*. Athens: National Technical University of Athens, 1984.
32. BURCHARTH, H.F. Fatigue on breakwater concrete armour units. *In: Proc. 19th Conference on Coastal Engineering*. New York: American Society of Civil Engineers, 1984.
33. SILVA, M.A.G. On the mechanical strength of cubic armour blocks. *Coastal Structures 1983*. New York: American Society of Civil Engineers.
34. BURCHARTH, H.F. Full scale testing of dolosse to destruction. *Coastal Engineering*, 1981.
35. PIANC. *Final Report of the International Commission for the Study of Waves*. Supplement to Bulletin No. 25, vol. III, 1976.
36. HUDSON, R.Y. Laboratory investigations of rubble-mound breakwaters. *Proc. American Society of Civil Engineers*, 1959.
37. PIANC. *Final Report of the 3rd International Commission for the Study of Waves*. Supplement to Bulletin No. 36, vol II, 1980.
38. VAN DE MEER, J.W. Stability of cubes, tetrapods and accropodes. *In: [67]*.
39. THOMPSON, D.H., and R.M. SHUTTLE. *Design of Rip Rap Slope Protection Against Wind Waves*. Report 61. London: Construction Industry Research and Information Association.
40. POWELL, K.A. Armour rock size, the prediction methods available. *Hydraulics Research Seminar*, 16 January 1986. Wallingford: Hydraulics Research.
41. ECKERT, J.W. Design of toe protection for coastal structures. *Coastal Structures 1983*. New York: American Society of Civil Engineers.
42. ISBASH, S.V., and K.Y. KHALDRE. *Hydraulics of River Channel Closure*. 1959.
43. HALES, L.Z. *Erosion Control of Scour During Construction*. HL-80-3, Report 1-3. Vicksburg: US Army Engineer Waterways Experimental Station, 1980.
44. *HRS Notes*, December 1969, 15. Wallingford: Hydraulics Research.
45. *Flexible armoured revetments incorporating geotextiles*. *Proc. International Conference*. Institution of Civil Engineers. London: Thomas Telford, March 1984.
46. FOOKES, P.G., and A.B. POOLE. Some preliminary considerations on the selection and durability of rock and concrete materials for breakwaters and coastal protection works. *Quarterly Journal of Engineering Geology*, 1981, 14.
47. JOHN, N.W.M. *Geotextile*. New York: Chapman and Hall, 1977.
48. HEERTEN, G. Geotextiles in coastal engineering — 25 years experience. *Geotextiles and Geomembrances*, 1984, 1.
49. VAN GARDEREN, A.P., and G.L.M. MULDER. The use of bitumen in coastal structures. *Coastal Structures 1983*. New York: American Society of Civil Engineers.
50. *The use of Asphalte in Hydraulic Engineering*. Report No. 37-1985. Rijkswaterstat, Netherlands.
51. RIDGWAY, R.J., M. KIER, L.P. HILL, and D.W. LOW. Port Talbot harbour: construction. *In: Proc: Institution of Civil Engineers*, April 1970.
52. HOOKWAY, D.W., and A.G. BRINSON. Construction of rubble mound breakwaters at Ras Lanuf, Libya. *In: [55]*.
53. BARLOW, P.G.R., and M.G. BRIGGS. Rubble breakwaters — specifications. *In: [3]*.
54. CORNICK, H.F. *Dock and Harbour Engineering*. 2nd edn. London: Charles Griffin, 1968.
55. *Proc. ICE*. London, November 1958.
56. GARDNER, J.D., and I.H. TOWNEND. Slotted vertical screen breakwaters. *In: [67]*.
57. *Technical Standards for Port and Harbour Facilities in Japan*. Ports and Harbours Research Institute, Ministry of Transport, Japan, 1980.
58. BRUUN, P. (ed.). *Design and Construction of Mounds for Breakwaters and Coastal Protection. Developments in Coastal Engineering*. Amsterdam: Elsevier, 1985.
59. NAGAI, S. Wave pressures on slit-type breakwaters. *In: Proc. 16th Conference on Coastal Engineering*. New York: American Society of Civil Engineers, 1978.
60. QUINLAN, J.S.S. Kuwait breakwater — a case history. *In: [55]*.
61. *Development in Breakwaters. Conference Proc. Institution of Civil Engineers*. 1985.
62. GODA, Y. *Random Seas and Design of Maritime Structures*. Tokyo: University of Tokyo Press, 1985.
63. JENSEN, O.J. Stability of rubble foundation for composite breakwaters. *In: International Conference on Coastal and Port Engineering in Developing Countries*. Colombo, 1983.



64. GRAVESEN, H., and H. LUNDGREN. Forces on vertical and sloping face breakwaters. *In: 17th Congress, International Association for Hydraulic Research*. 1977. Obtainable from IAHR Secretariat, Rotterdamseweg 185, PO Box 177, 2600MH Delft, Netherlands.

65. ROMITI, G., A. NOLI, and L. FRANCO. The Italian experience in composite breakwaters. *In: [61]*.

66. *Breakwaters. Design and Construction. Conference Proc. Institution of Civil Engineers*. 1983.

67. *Design of Breakwaters. Conference Proc. Institution of Civil Engineers*. 1988.

### A.2 Further reading

ALLSOP, N.W.H. *Concrete Armour Units for Rubble Mound Breakwaters and Sea Walls: Recent Progress*. Report SR 100. Wallingford: Hydraulics Research, March 1988.

ALLSOP, N.W.H., and A.R. CHANNEL. *Wave Reflections in Harbours: Reflection Performance of Rock Armoured Slopes in Random Waves*. Report OD 102. Wallingford: Hydraulics Research, 1989.

ALLSOP, N.W.H., L. FRANCO, and P.J. HAWKES. Probability distributions and levels of wave run-up on armoured slopes. *In: Numerical and Hydraulic Modelling of Ports and Harbours*. BHRA, 1985.

ALLSOP, N.W.H., and S.S.L. HETTIARACHICHI. Reflections from coastal structures. *In: Proc. 21st Conference on Coastal Engineering*. New York: American Society of Civil Engineers, 1988.

BARENDS, F.B.J., and P. HOLSCHER. Modelling interior processes in a breakwater. *In: [61]*.

MADSEN, O.S., and S.M. WHITE. *Reflection and Transmission Characteristics of Porous Rubble Mound Breakwaters*. MR76-5. Fort Belvoir: Coastal Engineering Research Centre, March 1976.

OWEN, M.W., and M.G. BRIGGS. Limitations of modelling. *In: [55]*.

PIANC. *The Stability of Rubble Mound Breakwaters in Deeper Water*. Supplement to Bulletin No. 48, 1985.

SEELIG, W.N. *Estimation of Wave Transmission Coefficient for Permeable Breakwaters*.

CETA 79-6. Fort Belvoir: Coastal Engineering Research Centre, Oct. 1979.

TIMCO, G.W., and E.P.D. MANSARD. On the interpretation of rubble mound breakwater tests. *Coastal Structures 1983*. New York: American Society of Civil Engineers.





---

## Publication(s) referred to

BS 410, *Specification for test sieves.*

BS 812, *Testing aggregates.*

BS 812-2, *Methods for determination of physical properties.*

BS 812-110, *Methods for determination of aggregate crushing value (ACV).*

BS 5328, *Concrete.*

BS 5328-1, *Guide to specifying concrete.*

BS 6031, *Code of practice for earthworks.*

BS 6349, *Maritime structures.*

BS 6349-1, *General criteria<sup>2)</sup>.*

BS 6349-2, *Design of quay walls, jetties and dolphins<sup>2)</sup>.*

BS 6349-3, *Design of dry docks, locks, slipways and shipbuilding berths, shiplifts and dock and lock gates<sup>2)3)</sup>.*

BS 6349-4, *Design of fendering and mooring systems<sup>2)3)</sup>.*

BS 6349-5, *Code of practice for dredging and land reclamation<sup>2)3)</sup>.*

BS 6349-6, *Design of inshore moorings and floating structures<sup>2)3)</sup>.*

BS 6906, *Methods of test for geotextiles.*

BS 8004, *Code of practice for foundations.*

BS 8110, *Structural use of concrete.*

BS 8110-1, *Code of practice for design and construction.*

---

<sup>2)</sup> Published as a code of practice.

<sup>3)</sup> Referred to in the foreword only.

---

---

## BSI — British Standards Institution

BSI is the independent national body responsible for preparing British Standards. It presents the UK view on standards in Europe and at the international level. It is incorporated by Royal Charter.

### Revisions

British Standards are updated by amendment or revision. Users of British Standards should make sure that they possess the latest amendments or editions.

It is the constant aim of BSI to improve the quality of our products and services. We would be grateful if anyone finding an inaccuracy or ambiguity while using this British Standard would inform the Secretary of the technical committee responsible, the identity of which can be found on the inside front cover. Tel: 020 8996 9000. Fax: 020 8996 7400.

BSI offers members an individual updating service called PLUS which ensures that subscribers automatically receive the latest editions of standards.

### Buying standards

Orders for all BSI, international and foreign standards publications should be addressed to Customer Services. Tel: 020 8996 9001. Fax: 020 8996 7001.

In response to orders for international standards, it is BSI policy to supply the BSI implementation of those that have been published as British Standards, unless otherwise requested.

### Information on standards

BSI provides a wide range of information on national, European and international standards through its Library and its Technical Help to Exporters Service. Various BSI electronic information services are also available which give details on all its products and services. Contact the Information Centre. Tel: 020 8996 7111. Fax: 020 8996 7048.

Subscribing members of BSI are kept up to date with standards developments and receive substantial discounts on the purchase price of standards. For details of these and other benefits contact Membership Administration. Tel: 020 8996 7002. Fax: 020 8996 7001.

### Copyright

Copyright subsists in all BSI publications. BSI also holds the copyright, in the UK, of the publications of the international standardization bodies. Except as permitted under the Copyright, Designs and Patents Act 1988 no extract may be reproduced, stored in a retrieval system or transmitted in any form or by any means – electronic, photocopying, recording or otherwise – without prior written permission from BSI.

This does not preclude the free use, in the course of implementing the standard, of necessary details such as symbols, and size, type or grade designations. If these details are to be used for any other purpose than implementation then the prior written permission of BSI must be obtained.

If permission is granted, the terms may include royalty payments or a licensing agreement. Details and advice can be obtained from the Copyright Manager. Tel: 020 8996 7070.