

BS ISO 24521:2016



BSI Standards Publication

Activities relating to drinking water and wastewater services — Guidelines for the management of basic on-site domestic wastewater services

National foreword

This British Standard is the UK implementation of ISO 24521:2016.

The UK participation in its preparation was entrusted to Technical Committee CB/503, Drinking water and wastewater service levels.

A list of organizations represented on this committee can be obtained on request to its secretary.

This publication does not purport to include all the necessary provisions of a contract. Users are responsible for its correct application.

© The British Standards Institution 2016. Published by BSI Standards Limited 2016

ISBN 978 0 580 84778 3

ICS 03.080.30; 13.060.30

Compliance with a British Standard cannot confer immunity from legal obligations.

This British Standard was published under the authority of the Standards Policy and Strategy Committee on 30 September 2016.

Amendments issued since publication

| Date | Text affected |
|------|---------------|
|------|---------------|

**Activities relating to drinking water
and wastewater services — Guidelines
for the management of basic on-site
domestic wastewater services**

*Activités relatives aux services de l'eau potable et des eaux usées —
Lignes directrices pour la gestion sur site des services d'eaux usées
domestiques de base*





COPYRIGHT PROTECTED DOCUMENT

© ISO 2016, Published in Switzerland

All rights reserved. Unless otherwise specified, no part of this publication may be reproduced or utilized otherwise in any form or by any means, electronic or mechanical, including photocopying, or posting on the internet or an intranet, without prior written permission. Permission can be requested from either ISO at the address below or ISO's member body in the country of the requester.

ISO copyright office
Ch. de Blandonnet 8 • CP 401
CH-1214 Vernier, Geneva, Switzerland
Tel. +41 22 749 01 11
Fax +41 22 749 09 47
copyright@iso.org
www.iso.org

Contents

Page

| | |
|--|-----------|
| Foreword | v |
| Introduction | vi |
| 1 Scope | 1 |
| 2 Normative references | 1 |
| 3 Terms and definitions | 2 |
| 4 Objectives | 2 |
| 4.1 General..... | 2 |
| 4.2 Protection of public health..... | 3 |
| 4.3 Protection of users and operators..... | 4 |
| 4.4 Meeting the needs and expectations of users..... | 4 |
| 4.5 Provisions of services under normal and emergency situations..... | 4 |
| 4.6 Sustainability of basic on-site domestic wastewater systems..... | 4 |
| 4.7 Promotion of sustainable development of the community..... | 5 |
| 4.8 Protection of the environment..... | 5 |
| 5 Components of basic on-site domestic wastewater systems | 6 |
| 5.1 General..... | 6 |
| 5.2 Basic on-site domestic wastewater systems..... | 6 |
| 5.2.1 User interface..... | 6 |
| 5.2.2 Collection..... | 7 |
| 5.2.3 Transportation..... | 7 |
| 5.2.4 Treatment..... | 7 |
| 5.2.5 Disposal/reuse..... | 8 |
| 6 Management of basic on-site domestic wastewater systems | 9 |
| 6.1 General..... | 9 |
| 6.2 Independent management of system function and stakeholder communication..... | 10 |
| 6.3 Basic management activities..... | 11 |
| 6.3.1 Developing objectives and establishing action plans..... | 11 |
| 6.3.2 Financial sustainability of the system..... | 11 |
| 6.3.3 Sustainability of the assets..... | 11 |
| 6.3.4 Customer relations..... | 12 |
| 6.4 Stakeholder relations..... | 12 |
| 6.4.1 Developing plans for support of stakeholders..... | 12 |
| 6.4.2 Education and/or training of stakeholders..... | 13 |
| 6.5 Environmental management..... | 13 |
| 6.6 Risk management..... | 14 |
| 7 Planning and construction | 15 |
| 7.1 Planning and construction of basic on-site domestic wastewater systems..... | 15 |
| 7.2 Criteria for selecting appropriate basic on-site domestic wastewater technologies..... | 16 |
| 7.3 User interface..... | 17 |
| 7.4 Collection..... | 18 |
| 7.5 Transportation..... | 18 |
| 7.6 Treatment..... | 19 |
| 7.7 Disposal/reuse..... | 19 |
| 8 Operation and maintenance | 20 |
| 8.1 General..... | 20 |
| 8.2 Developing operational plans and instructions..... | 20 |
| 8.3 Developing maintenance plans and instructions..... | 21 |
| 8.4 Developing plans and instructions for collection of waste..... | 21 |
| 8.5 Developing plans and instructions for transportation of waste..... | 21 |
| 9 Health and safety issues | 21 |
| 9.1 Health and safety measures and training..... | 21 |

| | | |
|---------------------|---|-----------|
| 9.2 | Public health programmes..... | 22 |
| Annex A | (informative) Corresponding terms in English, French and Spanish..... | 23 |
| Annex B | (informative) Schematics of basic on-site domestic wastewater systems..... | 24 |
| Bibliography | | 55 |

Foreword

ISO (the International Organization for Standardization) is a worldwide federation of national standards bodies (ISO member bodies). The work of preparing International Standards is normally carried out through ISO technical committees. Each member body interested in a subject for which a technical committee has been established has the right to be represented on that committee. International organizations, governmental and non-governmental, in liaison with ISO, also take part in the work. ISO collaborates closely with the International Electrotechnical Commission (IEC) on all matters of electrotechnical standardization.

The procedures used to develop this document and those intended for its further maintenance are described in the ISO/IEC Directives, Part 1. In particular the different approval criteria needed for the different types of ISO documents should be noted. This document was drafted in accordance with the editorial rules of the ISO/IEC Directives, Part 2 (see www.iso.org/directives).

Attention is drawn to the possibility that some of the elements of this document may be the subject of patent rights. ISO shall not be held responsible for identifying any or all such patent rights. Details of any patent rights identified during the development of the document will be in the Introduction and/or on the ISO list of patent declarations received (see www.iso.org/patents).

Any trade name used in this document is information given for the convenience of users and does not constitute an endorsement.

For an explanation on the meaning of ISO specific terms and expressions related to conformity assessment, as well as information about ISO's adherence to the World Trade Organization (WTO) principles in the Technical Barriers to Trade (TBT) see the following URL: www.iso.org/iso/foreword.html.

The committee responsible for this document is Technical Committee ISO/TC 224, *Service activities relating to drinking water supply systems and wastewater systems — quality criteria of the service and performance indicator*.

Introduction

0.1 Water issues: global context and policies framework

Water constitutes a worldwide challenge for the 21st century, both in terms of the management of available water resources and the provision of access to drinking water and sanitation for the world's population. In 2000, the United Nations recognized that access to water is an essential human right and, in conjunction with national governments, it set ambitious goals (the "Millennium Development Goals") to increase access to drinking water and wastewater services, including safe disposal or reuse of residues (jointly referred to as "water services" in this International Standard), particularly in developing countries. International conferences on sustainable development and water (e.g. the World Summit on Sustainable Development in Johannesburg in September 2002, the third World Water Forum in Kyoto in March 2003 and the fourth World Water Forum in Mexico City in March 2006) have highlighted this issue, and UN agencies (including WHO and UNESCO) have developed recommendations and programmes to establish a framework in which to advance.

The United Nations Commission on Sustainable Development has emphasised that governments have a primary role in promoting improved access to safe drinking water and basic sanitation through improved governance at all levels and appropriate enabling environments and regulatory frameworks, with the active involvement of all stakeholders.

NOTE Governments are referred to as "relevant authorities" in ISO 24510, ISO 24511 and ISO 24512).

If institutional solutions are incorporated into this process, the water sector becomes more productive and the management of water resources becomes more sustainable. Declarations from the World Water Forum have recommended that governments endeavour to reinforce the role of parliaments and local public authorities, particularly with regard to the provision of adequate water services, and have recognized that an effective collaboration with and between these actors is a key factor for meeting water-related challenges and goals.

Examples of key issues for efficient drinking water and sanitation services policy frameworks are:

- clearly defining the roles of the different stakeholders;
- establishing how sanitary rules and organization are defined and assessed;
- establishing processes to ensure consistency between the policies regarding urban development and water utility infrastructure;
- regulating water withdrawal and wastewater discharge;
- providing information to users and communities.

0.2 Water utilities: general objectives

In addition to public health protection, sound management of the drinking water and wastewater utilities (jointly referred to as "water utilities" in this International Standard) is an essential element of integrated water resources management. When applied to these utilities, sound management practices will contribute, both quantitatively and qualitatively, to sustainable development. Sound utility management also contributes to social cohesion and economic development of the communities served, because the quality and efficiency of water services have implications for virtually all activities of society.

As water is considered to be a social good and activities related to water services support the three aspects (economic, social and environmental) of sustainable development, it is logical that the management of water utilities be transparent to, and inclusive of, all stakeholders identified in accordance with the local context.

There is a broad array of stakeholders that can play a role in activities related to water services. Examples of such stakeholders include:

- governments or public agencies (international, national, regional or local);
- associations of the utilities themselves (e.g. international, regional/multinational and national drinking water or wastewater associations);
- autonomous bodies seeking to play an overview role (e.g. organizations concerned, such as non-governmental organizations);
- users and associations of water users.

The relationships between stakeholders and water utilities vary around the world. In many countries, there are bodies that have responsibility (in whole or in part) for overseeing the activities related to water services, whether the utilities are publicly or privately owned or operated, and whether they are regulated by relevant authorities or acting in a system of technical self-regulation. Standardization and technical self-regulation are possible ways of ensuring involvement of all stakeholders and meeting the subsidiarity principle.

The aim of water utilities is to offer services to everybody in the area of responsibility of the utility, to provide users with a continuous supply of drinking water and to collect and treat wastewater under economic and social conditions that are acceptable to the users and to the utility. Water utilities are expected to meet the requirements of relevant authorities and the expectations specified by the responsible bodies in conjunction with the other stakeholders, while ensuring the long-term sustainability of the service. In a context of scarcity of resources, including financial resources, it is advisable that the investments made in installations be appropriate and that necessary attention be paid to proper maintenance and effective use of the installations. It is advisable that water tariffs generally aim at meeting cost-recovery principles and at promoting efficiency in the use of the resources, while striving to maintain affordable basic access to water services.

It is advisable that the stakeholders be involved in both setting service objectives and assessing the adequacy and efficiency of service.

0.3 Objectives, content and implementation of ISO standards addressing water services

The ISO standards addressing water services are ISO 24510 (service-oriented), ISO 24511 and ISO 24512 (both management-oriented). The objective of these ISO standards is to provide the relevant stakeholders with guidelines for assessing and improving the service to users and guidance for managing water utilities, consistent with the overarching goals set by the relevant authorities.

ISO 24510 contains the following:

- a brief description of the components of the service relating to the users;
- core objectives for the service, with respect to the needs and expectations of users;
- guidelines for satisfying the needs and expectations of users;
- assessment criteria for service to users in accordance with the provided guidelines;
- examples of performance indicators linked to the assessment criteria that can be used for assessing the performance of the service.

ISO 24511 and ISO 24512 contain the following:

- a brief description of the physical/infrastructural and managerial/institutional components of water utilities;
- core objectives for water utilities, considered to be globally relevant at the broadest level;
- guidelines for the management of the water utilities;

- guidelines for the assessment of the water services with service assessment criteria related to the objectives, and performance indicators linked to these criteria.

The performance indicators presented in ISO 24510, ISO 24511 and ISO 24512 are for illustrative purposes only, because assessing the service to users cannot be reduced to a single or universal set of performance indicators.

The quality of the supplied water (or discharged wastewater) can be adversely impacted between the point-of-delivery (or, in the case of wastewater, the point-of-collection) and the point-of-use (or, in the case of wastewater, the point-of-discharge) by the installations inside the premises. Some stakeholders (e.g. relevant authorities, owners, contractors and users) can have a role to play regarding this issue.

Recognizing that the organization of water utilities differs from country to country, the guidelines given in ISO 24510, ISO 24511 and ISO 24512 focus on the needs and expectations of users and on the water services themselves, without imposing a means of meeting those needs and expectations, in order to permit the broadest possible use of ISO 24510, ISO 24511 and ISO 24512 while respecting the cultural, socio-economic, climatic, health and legislative characteristics of the different countries and regions of the world. In the short term, it might not always be possible to meet the expectations of local users, due to factors such as climate conditions, resource availability and difficulties relating to the economic sustainability of the water services, particularly regarding financing and the capacity of users to pay for improvements. These conditions can limit the achievement of some objectives or restrict the implementation of some recommendations in developing countries. However, ISO 24510, ISO 24511 and ISO 24512 are drafted with such constraints in mind and, for example, allow for differing levels of fixed networks and the need for on-site alternatives. Notwithstanding the need for flexibility in terms of engineering and hardware, many recommendations in ISO 24510, ISO 24511 and ISO 24512, such as consultation mechanisms, are intended to apply universally.

In order to assess and improve the service to users and to ensure proper monitoring of the improvements, an appropriate number of performance indicators (PIs) or other methods can be established for checking conformity with requirements. Stakeholders can select PIs from the examples given in ISO 24510, ISO 24511 and ISO 24512, or develop other relevant PIs taking into account the principles described. The PIs logically relate to the objectives for which they are defined through the assessment criteria, and are used to measure performance. They can also be used to set required or targeted values. ISO 24510, ISO 24511 and ISO 24512 do not impose any specific indicator or any minimum value or performance range; they respect the principle of adaptability to local contexts, facilitating local implementation. ISO 24510, ISO 24511 and ISO 24512 can serve to assess progress towards water policy goals and the objectives of financing programmes, by providing guidelines for the continual improvement and for the assessment of the service.

ISO 24510, ISO 24511 and ISO 24512 are consistent with the principle of the “Plan-Do-Check-Act” (PDCA) approach: they propose a step-by-step process, from identifying the components and defining the objectives of the utility to establishing performance indicators, with a loop back to the objectives and to the management, after having assessed the performances. ISO 24510, ISO 24511 and ISO 24512 are consistent with management systems standards such as ISO 9001 and ISO 14001. Implementation of an overall ISO 9001 and/or ISO 14001 management system can facilitate the implementation of the guidelines contained within ISO 24510, ISO 24511 and ISO 24512; conversely, these guidelines can help to achieve the technical provisions of ISO 9001 and ISO 14001 for organizations choosing to implement them.

0.4 Basic on-site domestic wastewater services

The absence of basic on-site sanitation services globally is a major inhibitor of achieving global societal goals of improving public health and economic development. This situation prevails in both developed and developing countries. Although often thought of as a rural problem, it is also a fact for many peri-urban and urbanized areas. According to the United Nations (see Reference [5]), 2,1 billion people gained access to improved sanitation facilities between 1990 and 2015. However, by 2015, 2,4 billion people still lacked improved sanitation and 946 million people, accounting for 13 % of the world's population, practiced open defecation.

Poor sanitation facilities are often linked to contaminated water sources, which in turn are linked to transmission of diseases such as cholera, diarrhoea, dysentery, hepatitis A and typhoid. In addition,

such conditions are often exacerbated by inadequate or absent health care facilities, which exposes already vulnerable patients to additional risk of infection and disease. UNICEF estimates that diarrhoea is the second largest killer of children under the age of five in the developing world and this is caused largely by poor sanitation and inadequate hygiene.

The environmental and public health impacts of the lack of sanitation facilities depend on the density of the population. In sparsely populated rural and remote areas, the lack of sanitation facilities might not result in significant risk as urine and faecal deposits (also referred to as “open defecation”) might be handled ecologically to a satisfactory level. However, as population density increases, a point is reached where the failure of natural absorption or decomposition processes become both a public health and an environmental risk. In such circumstances, basic on-site wastewater services can be installed. These can be either on the scale of a single family unit or on a community scale, although the latter requires collection systems of some type and can include transportation and disposal. Regardless of the type of on-site domestic wastewater services in place, its scale or the level of technology installed, the services and processes need to be managed to ensure effective operation within the socio-economic and cultural conditions.

Management of on-site domestic wastewater services of all types and at all levels of technology requires an understanding of the biological processes at work, the factors that can inhibit those processes and the means of ensuring those processes are functioning. It also involves a general understanding by the wider community served of the benefits of sanitation system use and management. In this way, the sanitation facilities work efficiently and help sustain the community in which they are located. Management of the services is often considered to be the responsibility of the relevant authority, whether it is local or supported by larger scale water utilities. However, in many instances, the management of the basic on-site domestic wastewater services is the responsibility of the user in collaboration with the local authorities.

Many of these basic on-site sanitation systems are located near or adjacent to sanitation services, under professional supervision and operation. In many cases, the basic on-site systems can be supported by the nearby larger scale wastewater services, e.g. through the collection of wastewater or partially treated sanitary effluents for further treatment/disposal in the larger facility. This symbiotic relationship provides an opportunity for small scale sanitation facilities without needing to host all the technology or experienced wastewater treatment systems and staff on-site. In other cases, the management of the large scale facility can provide supervisory technical services to the neighbouring basic system operators, to help train and ensure effective treatment levels.

This International Standard provides guidelines on the management of such basic on-site domestic wastewater services with a focus on improving hygiene, taking into account social norms through stakeholder communication, management of assets and better management of human waste and wastewater.

Activities relating to drinking water and wastewater services — Guidelines for the management of basic on-site domestic wastewater services

1 Scope

This International Standard provides guidance for the management of basic on-site domestic wastewater services, using appropriate technologies in their entirety at any level of development.

This International Standard supplements and is intended to be used in conjunction with ISO 24511. It includes the following:

- guidelines for the management of basic on-site domestic wastewater services from the operator's perspective, including maintenance techniques, training of personnel and risk considerations;
- guidelines for the management of basic on-site domestic wastewater services from the perspective of users;
- guidance on the design and construction of basic on-site domestic wastewater systems;
- guidance on planning, operation and maintenance, and health and safety issues.

The following are outside the scope of this International Standard:

- limits of acceptability for wastewater discharged into a receiving body;
- analytical methods;
- the management structure of sanitary waste/wastewater service activities of operation and management;
- the content of contracts or subcontracts.

This International Standard is applicable to both publicly and privately operated basic on-site domestic wastewater (black and grey water) services, for one or more dwellings.

NOTE 1 Management of on-site domestic wastewater, especially in rural areas and areas under development, is sometimes provided by the owners of the premises where wastewater is generated. In such cases, the owners of the premises carry out the management of domestic wastewater by themselves. In this International Standard, the term "services" includes "self-services" provided by the owners of the premises.

NOTE 2 Especially in undeveloped areas, domestic wastewater is collected in an undiluted form (i.e. sanitary waste). Sources of sanitary waste/wastewater in this International Standard are residential, excluding storm water runoff.

NOTE 3 [Annex A](#) contains a table of correspondence between equivalent terms in English, French and Spanish.

NOTE 4 [Annex B](#) gives some examples of schematics of basic on-site domestic wastewater systems and components.

2 Normative references

The following documents, in whole or in part, are normatively referenced in this document and are indispensable for its application. For dated references, only the edition cited applies. For undated references, the latest edition of the referenced document (including any amendments) applies.

ISO 24510, *Activities relating to drinking water and wastewater services — Guidelines for the assessment and for the improvement of the service to users*

ISO 24511, *Activities relating to drinking water and wastewater services — Guidelines for the management of wastewater utilities and for the assessment of wastewater services*

3 Terms and definitions

For the purposes of this document, the terms and definitions given in ISO 24510 and ISO 24511 and the following apply.

NOTE All terms and definitions from ISO publications are publicly available on the ISO Online Browsing Platform (www.iso.org/obp).

3.1 basic

minimum equipment or process required to treat wastewater and meet discharge objectives

3.2 basic on-site domestic wastewater

water containing only human body waste and human liquid waste, which can contain grey water from washing but does not contain commercial or industrial discharges

3.3 excreta

waste products of human metabolism, in solid or liquid form, generally urine and/or faeces

3.4 land treatment

treatment that can include simply spraying homogenized waste onto a land surface for bacterial breakdown through the effects of sun and climate or subsurface discharge of partially treated wastewater (after removal of suspended solids) and decomposition of dissolved organics in the soil anaerobic environment

3.5 technology

specific infrastructure or method that is designed to collect, store, treat, use and/or transport wastewater and/or residues

3.6 wetland

natural or constructed lined media filled bed, into which effluent is discharged and which contains suitable flora and fauna that grow and feed on the nutrients in the effluent

Note 1 to entry: These are “natural” alternatives to a biological treatment process involving buildings, aeration systems and sedimentation systems. However, these “natural” systems also require maintenance, i.e. periodic removal of overgrown flora and fauna as well as collected sediment.

4 Objectives

4.1 General

Basic on-site domestic wastewater services are in many cases not provided by others; instead, wastewater collection, transport and disposal is carried out by the owner of the premises where wastewater is generated.

The four main objectives of basic on-site domestic wastewater services are:

- public health and safety;

- occupational health and safety;
- environmental protection;
- sustainable development.

Basic on-site domestic wastewater system solutions should adapt to local conditions, respond to actual needs and be adaptable to a changing environment.

Besides constituting these main objectives, basic on-site sanitation solutions should consider the following:

- effective disease barrier;
- prevention of environmental pollution;
- environmental requirements;
- optimization of the use of resources in terms of nutrients, water and energy;
- simplicity of construction, use, operation, maintenance and repair;
- adherence to hygienic safety standards;
- affordability and willingness to pay;
- existing institutional support;
- existing best practice, experience and infrastructure;
- development of ownership, involving landlords, users of all kinds, public water utilities and the private sector in design and planning;
- cultural sensitivity, taking into account values, attitudes and the behaviour of the user.

4.2 Protection of public health

The requirements of ISO 24511 apply.

Safe and sanitary disposal of wastewater should be a public health priority. Wastewater should be disposed of in a manner that ensures that:

- drinking water supplies are not threatened;
- direct human exposure is not possible;
- waste is inaccessible to vectors, insects, rodents or other possible carriers;
- odour or aesthetic nuisances are not created.

The following should be considered.

- Discharges of untreated or partially treated wastewater from basic on-site domestic wastewater systems cause public health risks and negative environmental health effects.
- The presence of nitrates or bacteria in the drinking water well indicates that liquid from the system may be flowing into the well through the ground or over the surface (water analyses available from the local health department will indicate whether this is a problem).
- The reuse of reclaimed water (treated effluent) is encouraged; however, the relevant authority should establish that the extent of treatment, the method of application and the reuse purpose for reclaimed water does not create public health risks and adverse environmental impacts before approval is granted. Reuse is only permitted for non-potable (not for human consumption) purposes.

For further guidance on possible actions, see ISO 24511:2007, Annexes C and D.

4.3 Protection of users and operators

All users and operators need protective equipment when handling wastewater. Appropriate training should be available for users and operators.

Health protection of the owners of the premises or workers providing emptying services should also be accounted for.

The health and safety precautions for users and operators should be documented and reviewed periodically. The actual health and safety situation should be reviewed at prescribed intervals.

4.4 Meeting the needs and expectations of users

The requirements of ISO 24510 and ISO 24511 apply.

NOTE In many cases, a favoured technology is chosen and little attempt is made to include the views of users. Users are most interested in seeing improvements to their living conditions, e.g. due to health issues, matters of privacy and safety for family members.

The requirements of the users should be identified for the site (number of users, economic costs and cultural acceptance) so that the implemented technologies meet the users' needs and expectations.

Basic on-site domestic wastewater systems should be secure, comfortable, convenient and safe for all kinds of users (children, adults, elderly and disabled persons).

Users' expectations typically relate to:

- response to complaints;
- reporting of financial results;
- consultation on plans for changes;
- involvement in electing or appointing management positions;
- expectations that public health and the environment will be protected.

If there is potential for wastewater reuse, the needs and expectations of the potential end-users of the treated wastewater and/or residues should be considered.

4.5 Provisions of services under normal and emergency situations

The requirements of ISO 24511 apply.

User interfaces intended for emergency situations should be portable/easy to assemble, as applicable.

The system (assets) should have written and visual instructions for operating and maintenance plans for normal and emergency situations. Such plans should include advice for situations that could occur because of the technology used or the site location.

See ISO 24511:2007, Annexes C and D, for additional guidance.

4.6 Sustainability of basic on-site domestic wastewater systems

The requirements of ISO 24511 apply.

Whenever possible, effluents should be used beneficially or disposed of in a safe and appropriate way. The focus should be on the outputs of systems and their (potential) value.

It should be determined if there is a real or potential demand for reuse of sanitation system products; such reuse systems need to be designed considering health and safety requirements.

When possible, nutrients recovered from faeces and urine should be recycled and used at household level as fertilizer or soil improver. Safety and hygiene issues should be taken into consideration.

The system (assets) should be maintained and should provide the capacity to meet current and future needs. Preventative maintenance of the facility and desludging should be identified and performed periodically so that the assets meet the criterion for functional lifespan.

Revenue sources should be developed in order to ensure cost recovery of services and financial sustainability.

See ISO 24511:2007, Annexes C and D, for additional guidance.

4.7 Promotion of sustainable development of the community

The requirements of ISO 24511 apply.

Specifically integrated water resources management and renewable energy and utilization of treated wastewater residues should be taken into consideration.

Another advantage from basic on-site domestic wastewater systems is the reuse of treated wastewater residues in agriculture for the provision of food, when applicable.

Possible actions are shown in ISO 24511:2007, Annexes C and D, for further guidance.

See ISO 16075-1, for further guidance.

4.8 Protection of the environment

The requirements of ISO 24511 apply.

Improper discharge of wastewater from the system into the natural environment can lead to high levels of pollution. Aquatic organisms living in surface waters may be endangered when untreated wastewater is discharged.

Many of the environmental impacts, e.g. salinization of soil and contamination of water resources, can be minimized through systems that are environmentally friendly.

Only basic on-site domestic wastewater systems that do not have a negative effect on the environment should be set up.

Competent authorities should ascertain the compatibility of the system for the environment. Where necessary, pre-approval for basic on-site domestic wastewater disposal may be required before home construction. The process may require site-evaluation by environmental health experts or other competent authorities.

Management should ensure that failing basic on-site domestic wastewater systems do not have negative environmental effects as a result of discharge of partially treated or untreated wastewater.

Designs should include safeguards to ensure that failing on-site domestic wastewater systems do not cause accumulation of wastewater on the ground, its percolation into ground water or its flow into waterways that are close to the failing system.

From the perspective of water environment conservation, existing basic on-site domestic wastewater systems that are found to have negative effect on the environment should be replaced by systems that meet local environmental requirements and are affordable.

For further guidance, see possible actions as shown in ISO 24511:2007, Annexes C and D.

5 Components of basic on-site domestic wastewater systems

5.1 General

Basic on-site domestic wastewater systems generally comprise:

- user interface;
- collection and transport of sanitary waste/wastewater and residues removed from wastewater;
- treatment of sanitary waste/wastewater and residues removed from wastewater;
- disposal/reuse of treated effluent;
- disposal/reuse of treated residues.

[Table 1](#) outlines the chains of successive components of basic on-site domestic wastewater technologies.

NOTE [Table 1](#) is adapted from pS-Eau^[6], in which the component “user interface” is called “access”.

Table 1 — Chains of successive components of basic on-site domestic wastewater technologies

| Component | Definition | Objective |
|----------------|--|--|
| User interface | Technologies with which the user comes into contact and access the sanitation system. | To improve the sanitary conditions in people’s homes. |
| Collection | Technologies which enable wastewater to be collected, temporarily stored and, if appropriate, to be partially treated. | To improve the sanitary conditions in people’s homes. |
| Transportation | Technologies that transport wastewater away from the user’s home to temporary disposal, treatment or discharge sites. | To ensure the health and hygiene of the neighbourhood. |
| Treatment | Technologies used to treat wastewater and residues in order to reduce the pollution load by means of physico-chemical and/or biological processes. | To reduce pollution and ensure the health of the community. |
| Disposal/reuse | Technologies or methods by which residues are ultimately disposed of in the environment or reused as useful resources. | To allow a safe and adequate disposal of treated residues (disposal) or the utilization of treated residues (reuse). |

In some simple systems (e.g. pit latrines), the treatment component is not present or, if present, can include only a screening component, depending on the quantity and quality of the wastewater and the disposal method.

Depending on the extent of the development of wastewater management in a particular country or area, only one or a few of the components mentioned in [Annex B](#) may be used (e.g. only collection, disposal).

5.2 Basic on-site domestic wastewater systems

5.2.1 User interface

Toilets and washing facilities are the user interfaces with which the user comes into contact and which provide access to the sanitation system.

Toilets may be designed to allow the separation of urine and faeces.

User interfaces including (but not limited to) the following are considered, depending on local circumstances:

- simple ventilated/unventilated pit latrine;

- double ventilated improved pit latrine/fossa alterna;
- dry toilet (including urine diverting dry toilet, composting toilet and other basic dry toilet models and their variations);
- pour flush toilet;
- waterless urinal;
- cistern flush toilet;
- washing facilities, e.g. grey water sink;
- soak-away, e.g. for grey water.

NOTE 1 For descriptions, see [Annex B](#).

NOTE 2 To maximize the use of water, especially where it is in short supply, water that has been used for washing hands and/or anal areas can afterwards be utilized, where possible, as flushing water (e.g. toilets where the top of the water tank forms a sink).

5.2.2 Collection

Collection facilities contain human excreta awaiting transportation, including drums and containers, vaults and chambers, and double pit system.

Collection technologies including (but not limited to) the following may be considered:

- above ground tank (jerrycan/other tank);
- under or below ground tank (drum/vaults/chambers);
- human-powered emptying;
- motorized (pump or vacuum) emptying;
- transfer station (underground holding tank).

NOTE For descriptions, see [Annex B](#).

5.2.3 Transportation

Transportation may be by way of carts, tricycles or any other human-powered multiple-wheeled vehicles, trucks and vacuum tankers.

NOTE 1 When water is used, conventional drainage systems (gravity sewers) and non-conventional drainage systems (settled sewage or simplified sewer systems) can be applicable.

NOTE 2 For descriptions, see [Annex B](#).

5.2.4 Treatment

The following basic on-site domestic wastewater treatment facilities should be considered, depending on local circumstances. The treatment technologies are listed in two groups.

- a) Technologies primarily for the treatment of wastewater may include:
 - septic tank with one or more compartments without discharge;
 - septic tank system with discharge and adequate filtration;
 - upflow anaerobic sludge blanket reactor (UASB);

- stabilization ponds (anaerobic, facultative, aerobic, maturation);
 - natural or constructed wetland;
 - land treatment (slow filtration, rapid filtration and overland flow or subsurface dispersion);
 - compact biological treatment units, based usually on attached growth (such as trickling filters or rotating biological contactors), suspended growth biological processes (such as low-rate activated sludge) or hybrid aeration systems (suspended and attached growth in the same tank).
- b) Technologies primarily for the treatment of sludge may include:
- sedimentation/thickening ponds;
 - unplanted drying beds;
 - planted drying beds;
 - co-composting (where composting is required with other available organic waste);
 - anaerobic biogas reactor.

NOTE For descriptions, see [Annex B](#).

5.2.5 Disposal/reuse

This subclause deals with disposal (see [Figure 1](#)) of residues and reuse of treated wastewater and sludge.

The recovery of resources for economic use by post treatment should be considered when designing basic on-site domestic wastewater systems.

Some examples of disposal/reuse of wastewater sub-products may include:

- effluent discharge to the natural environment;
- effluent use in irrigation;
- land application of treated/stabilized sludge (biosolids) as fertilizer/soil conditioner;
- energy recovery option of sludge treatment (i.e. recovery and use of biogas and/or energy recovery from incinerating solids).

NOTE For descriptions, see [Annex B](#).

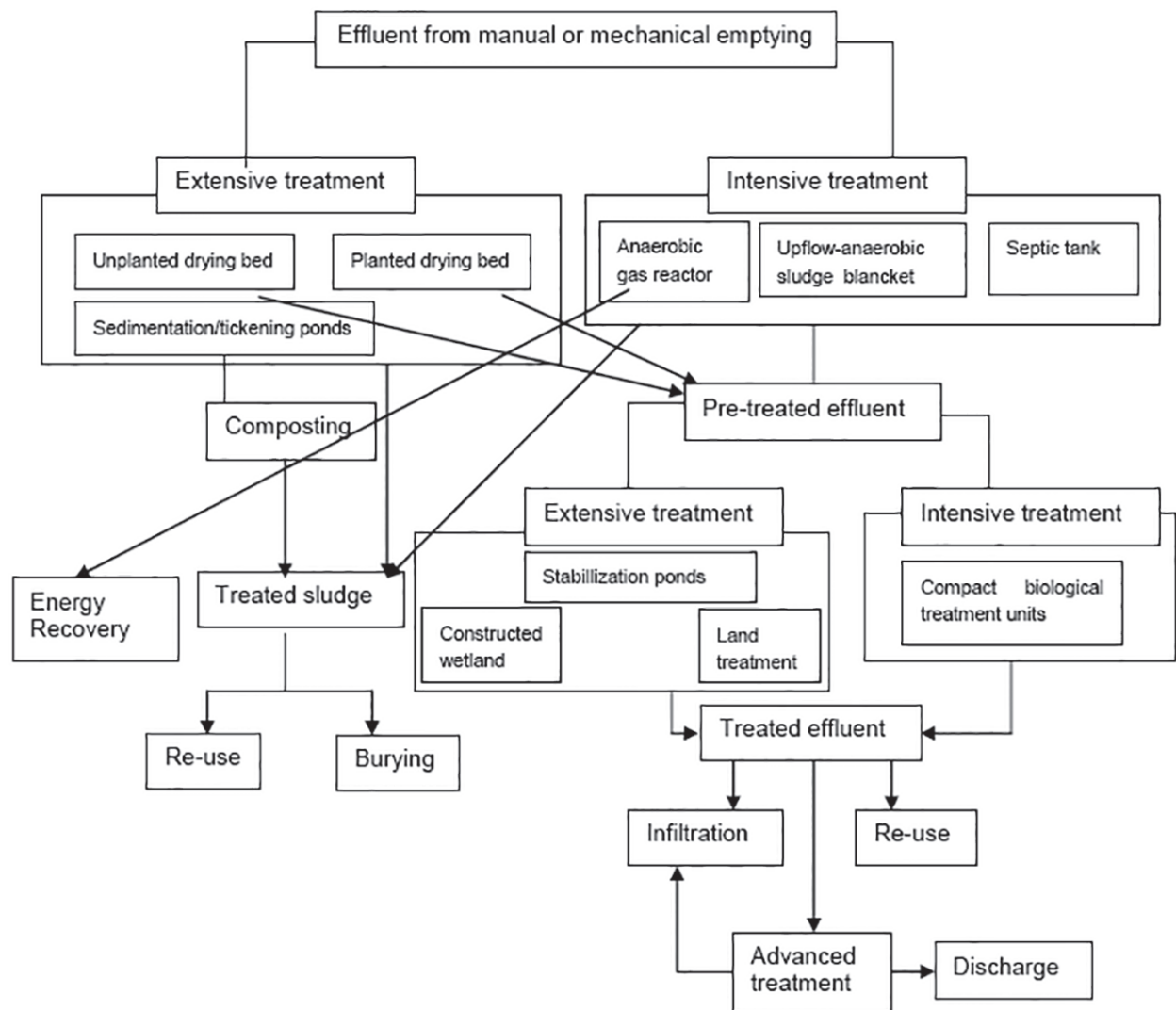

NOTE Figure source: Adapted from pS-Eau[6].

Figure 1 — Examples of typical available technologies for on-site treatment/disposal

6 Management of basic on-site domestic wastewater systems

6.1 General

The sustainability and continuity of the entire sanitation system depends on good organization and management of collection, transportation, treatment and disposal.

Management of basic on-site domestic wastewater systems should ensure that they meet the needs of the users and community to fulfil the objectives of basic on-site sanitation (see [Clause 4](#)).

Economic and cultural factors should also be identified to meet the objectives for providing basic on-site domestic sanitation to as many users as possible.

The basic on-site domestic wastewater systems should protect both the public health and the environment.

Conservative assumptions for operation and maintenance and managing system risk should be used to obtain the best possible result in the treatment of domestic wastewater. The health risks of ineffective

system operation or failure demand that a rigorous system of equipment and process maintenance and risk mitigation be installed.

The basic on-site domestic wastewater system is used for individual residences or small villages, where the responsible body might have limited technical/socio-economic capacity to implement, operate and maintain it. The system needs to be cost effective and sustainable, as well as easy to maintain while meeting the stated objectives for improved sanitation and treatment of domestic wastewater. The management guidance and risk assessment should be flexible to allow for use of other types of basic technologies that may be developed.

Appropriately treated wastewater is eventually returned to the environment and can have significant positive impact on both quantity and quality of natural water resources. Basic on-site domestic wastewater systems are often close to sources of drinking water and should produce a treated effluent that does not contaminate the drinking water source and does not affect the uses of the receiving waters.

Effective and safe management of residues resulting from wastewater treatment, including their final disposal or reuse, is becoming increasingly important due to concerns about both environmental protection and resource conservation.

Basic on-site domestic wastewater systems may have a useful life of more than one generation depending on the technology and its operation and maintenance. Consequently, basic on-site domestic wastewater systems should be durable and repairable and should consistently treat various concentrations of domestic wastewater.

6.2 Independent management of system function and stakeholder communication

Where the basic on-site domestic wastewater systems are not managed by the owners of the premises, the organization for the management should ensure that the systems function and are maintained as designed and that services are performed by fully trained people, in order to prevent risk to the environment and the community. A system function and stakeholder communication process should be developed (see [Figure 2](#)). The organization should provide information using data between the users and the service provider or utility, so that the community is informed, supports the use of the basic on-site domestic wastewater systems and sees the benefit to its needs and the environment.

To reach out to various stakeholders, different communication channels should be adapted.

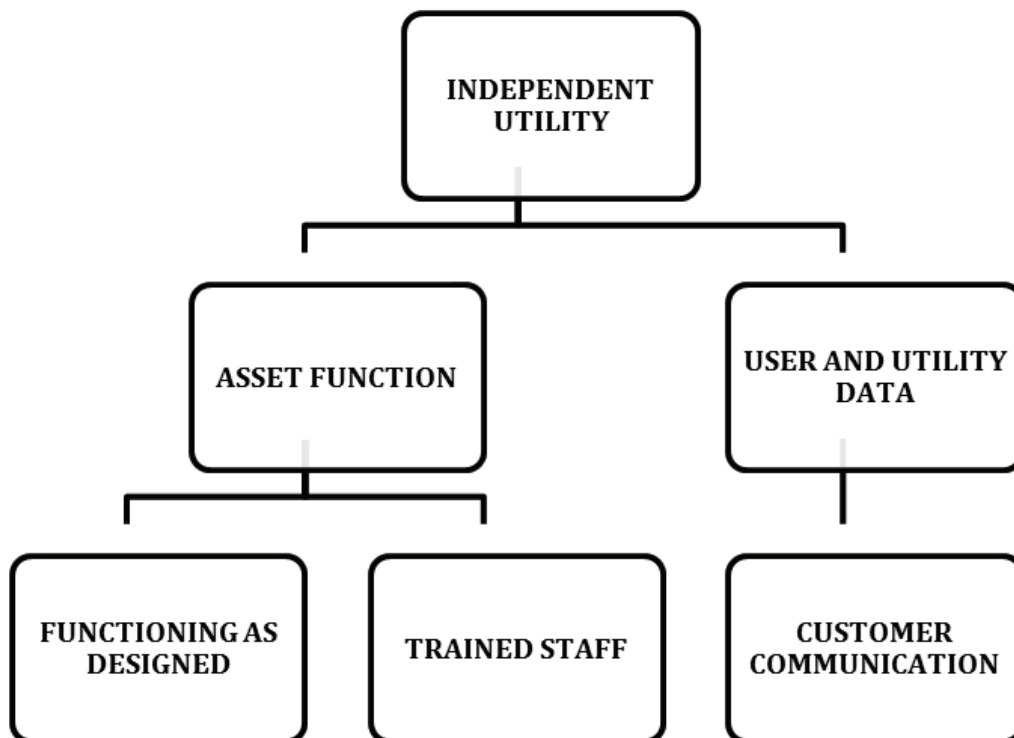

Figure 2 — Developing information for the system function and stakeholder communication process

6.3 Basic management activities

6.3.1 Developing objectives and establishing action plans

Before the basic on-site domestic wastewater system is designed and installed, the objectives, strategies and processes of the system and users should be identified to ensure that all human waste/wastewater is treated properly and that, together with residue disposal and effluent discharge, it meets requirements.

See ISO 24511:2007, Annexes C and D, for additional guidance.

6.3.2 Financial sustainability of the system

The financial stability of all resources is important to ensure that the wastewater systems function as designed, are operated as intended and meet the objectives for sustainability and the criterion for lifespan.

See ISO 24511:2007, Annexes C and D, for additional guidance.

6.3.3 Sustainability of the assets

The management of the assets of basic on-site domestic wastewater systems should include monitoring and planning for continuous technical functioning and the continuing availability of financial resources, so that the needs and requirements of the users are met with respect to treatment of the human waste/wastewater and lifespan criterion for the asset.

See ISO 24511:2007, Annexes C and D, for additional guidance.

6.3.4 Customer relations

Where basic on-site domestic wastewater systems are managed by people other than the owners of the premises, managing the customer relationship requires that the customers (user/users) accept the human waste/wastewater treatment system and agree that their needs and concerns are known and resolved.

Easily understandable system operating instructions including expected results should be prepared with the installation of the on-site wastewater systems and provided to their user.

The benefits of using basic on-site domestic wastewater systems should also be known by the users.

See ISO 24511:2007, Annexes C and D, for additional guidance.

User data information is necessary for proper functioning of basic on-site domestic wastewater systems. The data should be clearly defined, accurate and known for both the function and servicing of the system, so that it can be ensured that the needs of the users are met.

See ISO 24511:2007, Annexes C and D, for additional guidance.

6.4 Stakeholder relations

6.4.1 Developing plans for support of stakeholders

Management of operation, maintenance and disposal of waste should meet the requirements of the various stakeholders, have clearly communicated objectives and ensure proper education and training of stakeholders, so that the stakeholders understand and support the basic on-site domestic wastewater system objectives (see [Figure 3](#)).

NOTE Stakeholders can include public or private entities, end users, individuals and the community.



Figure 3 — Identifying stakeholder requirements and support

6.4.2 Education and/or training of stakeholders

Education and/or training should be well planned and sustainable.

Stakeholders should be well informed and trained or be educated to ensure the safe collection/transport, treatment and disposal/reuse of wastewater and residues from the basic on-site domestic wastewater system for the protection of human health and safety and of the environment. In addition, they should be trained in health and hygienic practices taking into consideration cultural acceptability.

The education and/or training should cover health and hygienic practices of using the basic on-site domestic wastewater system and could be provided as follows:

- for key local authorities and field staff: proper training on principles and technical solutions;
- for field workers: practical training concerning the construction and management of the basic on-site system, as well as empowerment methods;
- for household and community members: acquisition of skills in building, operating and maintaining basic on-site domestic wastewater systems, including awareness raising on hygienic practices of the basic on-site domestic wastewater system.

Education could be conducted through:

- public awareness campaigns;
- one to one basis;
- school curriculum;
- media;
- community-based organization/community user groups;
- community engagement/mobilization programs (government or donor), such as community-led total sanitation;
- school health clubs/youth groups;
- neighbouring municipalities operating their own similar or larger wastewater collection, treatment and disposal facilities.

Educational and/or training materials should be tailored to meet the needs of the target audience.

NOTE The learning-by-doing approach can be encouraged, including participatory seminars, workshops and meetings, as well as broader hands-on training.

6.5 Environmental management

Environmental management of basic on-site domestic wastewater systems should promote sustainability of the policy objectives for wastewater projects by protecting and preserving water quality and water resources.

The use of contaminated wastewater residues in agriculture may be managed through preventive actions which can reduce the risk to both crop viability and human health.

In order to easily assess the impact of basic on-site domestic wastewater collection, treatment and disposal, an environmental check list should be specifically developed in accordance with local conditions.

An environmental check list could include the following:

- the number of persons whose waste will be treated;

- the expected monthly flow;
- the nature of the expected flow, i.e. whether it is just domestic (as it should be in the case of basic on-site systems) or mixed with institutional or industrial waste;
- the type of treatment unit: septic tank, alternative treatment system (e.g. aeration), wetlands;
- the nature of the soils surrounding the effluent bed;
- the proximity to natural water sources;
- the use of the natural water sources;
- access to the area by livestock.

See ISO 16075, for further guidance.

6.6 Risk management

Risk management requires a systematic approach to the analysis (identification, description and estimation) of individual risks and their relative evaluation. Taken together, these steps comprise risk assessment. The assessment process should consider the different components of the basic on-site domestic wastewater system. The objective of the assessment should be to identify potential risks and develop and implement a plan to eliminate or minimize the risks to public health and safety, environmental degradation and negative socioeconomic impacts.

Risk management should begin in the planning stage of the basic on-site domestic wastewater system and should include all aspects of design, construction, implementation and operation and maintenance. The risk management should include the following steps.

- Problem formulation: A planning process for generating and evaluating hypotheses about the effects that might occur and identify the risks.
- Analysis: Typically includes both the site-specific analysis and characterization of risk causation (occurrence or exposure) and the more general analysis or characterization of risk effects (exposure-response relationships). These analyses are interdependent and are typically performed concurrently.
- Risk characterization: The process of combining the estimates of occurrence or exposure with the exposure-response relationships from the analysis of effects to estimate the magnitude and (if possible) probability of effects and resulting consequences.
- Development and implementation of a dynamic plan: The plan should include monitoring operation, preventative maintenance and corrective action to eliminate or control the risks.
- Categorization of risks: Risks may be grouped in the following categories:
 - public health and safety;
 - environmental impact;
 - socio-economic.
- Operational risk of transportation of wastewater: Risks associated with the collection, treatment and transportation of wastewater and its constituents (e.g. organic material, nutrients and pathogens) require an evaluation of the type of basic on-site domestic wastewater system (engineering) and site assessment.
- Risk framework: The framework for evaluating risk of system performance should be flexible enough to accommodate various types of basic on-site domestic wastewater systems; assumptions such as

seasonal occupation, multi-family homes; or several types of wastewater sources. The operational risk model for wastewater should account for:

- backup of the treatment system;
 - surface breakthrough from structural failure;
 - contamination of the land;
 - transport into drinking water wells and groundwater;
 - potentially exposed populations;
 - exposure of biota.
- Site assessment for risks: The site model for evaluating basic on-site system risks should account for:
- location of the basic on-site domestic wastewater treatment system;
 - location of residences and water wells;
 - topography;
 - groundwater sources to prevent adverse impacts from contamination on water sources like wells and boreholes;
 - surface water sources to prevent adverse impacts or nutrient over enrichment from contamination;
 - soils and slopes which may create effluent plumes;
 - potentially exposed populations.
- Causes of a failure: The failure mode can be divided into two categories, design deficiency or process variation, which can be described in terms of something that can be corrected or can be controlled. The potential failure modes are identified through answers to the following questions:
- In what way can this subsystem fail to perform its intended function?
 - What can go wrong although the subsystem is manufactured/assembled to specifications?
 - If the subsystem function was tested, how would its failure mode be recognized?
 - How will the environment contribute to or cause a failure?
 - In the application of the subsystem, how will it interact with other subsystems?

7 Planning and construction

7.1 Planning and construction of basic on-site domestic wastewater systems

When planning and constructing basic on-site domestic wastewater systems, the economic costs, the risk assessment of the site, cultural acceptance, protection of public health and protection of the environment should be considered (see [Figure 4](#)). Care should be taken to minimize or prevent as many of the risks of failures of the systems and contamination as possible, while still complying with the socio-economic requirements of the cost of installing and maintaining systems to meet the lifespan criterion.

Water reuse should be an important part in the design of basic on-site domestic wastewater systems and should function whenever possible.

| PLANNING AND CONSTRUCTION CRITERIA | | | | |
|---|---------------------------------------|----------------------------|------------------------------------|--------------------------------------|
| ECONOMIC COSTS | RISK ASSESSMENT AND MANAGEMENT | CULTURAL ACCEPTANCE | PROTECTION OF PUBLIC HEALTH | PROTECTION OF THE ENVIRONMENT |

Figure 4 — Considerations for the planning and construction of basic on-site domestic wastewater systems

There may be areas of human habitation which, in combination, are completely neglected by mainstream planning. In such cases, sanitation planning should put together individual systems and neighbourhoods.

Stakeholder involvement is a prerequisite to effective planning. Planners need to work closely with a variety of stakeholders and need to be prepared for conflict resolution, facilitation and negotiation.

Awareness-raising methods should be introduced as complementary participatory sanitation planning tools for mobilizing communities for participation.

7.2 Criteria for selecting appropriate basic on-site domestic wastewater technologies

A technological solution is feasible if it meets local demand, if the financial resources are available for its construction and if the financial resources and technical and management skills exist to ensure its proper operation and maintenance.

The approach used in this International Standard consists of helping users assess the feasibility of the different technical basic on-site wastewater solutions by providing a series of feasibility criteria.

These criteria include the following.

- The criterion of acceptance by households and by local sanitation professionals: this criterion could be assessed through surveys, considering also various basic on-site domestic wastewater local practices.
- The criterion of lifespan of the infrastructure: this criterion is determined by the technology used. The objective of the infrastructure should be to install the longest lifespan technology that is possible when effectiveness, economic costs and cultural acceptance are determined. The system should be durable and repairable (preferably with locally available materials and skills) and should treat various concentrations of domestic wastewater that are likely to occur.

- The criterion of the efficiency of the technology: this criterion depends on the segment under consideration:
 - the efficiency of a technology used to collect wastewater and excreta (access segment) is defined by its ease of use and maintenance and by its capacity for pre-treating effluent;
 - the efficiency of a technology used to evacuate wastewater and excreta (evacuation segment) is defined by its capacity to minimize all contact between operator and excreta, by the speed of evacuation, by its capacity to evacuate all sanitary waste (solid and liquid) and by its capacity to transport this to a suitable treatment plant;
 - the efficiency of a technology used to treat (disposal/treatment segment) is defined by the level of treatment the effluent has received upon leaving the plant;
 - the efficiency of a technology in its utilization of available water resources in its operation.
- In order to assess the feasibility of appropriate basic on-site domestic wastewater technologies, the required efficiency should be broken down qualitatively for each technical solution into two levels of the relevant criteria: low and high.
- The criterion of investment, operating and maintenance cost.
- The criterion of design, construction, operation and maintenance: this criterion refers both to locally available materials and to the local available technical skills available for the design, construction and operation of the infrastructure, as well as to the skills required to ensure facilities are kept in good working order. In this International Standard, this criterion is broken down into two levels: low or high.
- The criterion of accessibility.
- The criterion of range: this criterion relates to the distance between the sanitation facility that is being emptied and the disposal or treatment site.
- The criterion of required surface area: this criterion relates to the amount of land required for the sanitation facilities. There are two distinct levels of surface area requirement: large or limited.
- The criterion of water requirements: In this International Standard, two levels of water requirements are used: low or high.
- The criterion of availability of energy.

The final choice of a specific basic on-site system should be perceived by the relevant population as safe and attractive to use, while construction and maintenance costs should be affordable.

NOTE The condition of existing on-site water supply systems/equipment (e.g. water well and water piping) needs to be checked before installing on-site wastewater collection/treatment facilities, especially those that drain the effluent to the adjacent ground. The existing on-site water supply systems might have deficiencies (e.g. cracked water well casing and/or cracked pipes) that have not been noticed by users and that have not posed a serious health hazard previously. However, once a new on-site wastewater treatment system is installed nearby, even if such a system is properly designed, installed and operated, the existing water system deficiencies might result in serious contamination of the local water supply and greatly jeopardize the health and safety of users.

7.3 User interface

All toilets should be built on slightly raised ground to avoid surface flooding, and the pits should be shallow where water tables are high.

Good pit drainage is necessary. If wet anal cleaning is preferred to wiping, a special washing area should be provided.

In areas with unstable soil, the ring beam elevating the slab should be placed a little deeper. In very loose collapsing sandy soil, the pit should be lined.

The choice of user interface technologies depends on the following (among other aspects):

- the availability of water;
- the availability of funding;
- user preferences, such as anal cleaning material or anal cleaning water;
- soil characteristics;
- interest in the diversion of urine and faeces for subsequent use.

7.4 Collection

Collection facilities should:

- make efficient use of limited space;
- provide for overflow, e.g. overflowing urine;
- function effectively, guaranteeing hygienic safety;
- provide for easy management of the volumes and densities of the sludge;
- be such that the volumes and densities of the sludge are easily manageable;
- be easily accessible to the users and collectors of the waste for transportation.

The choice of a suitable collection method/technique should consider the following:

- the characteristics of waste produced;
- socio-cultural user acceptance and practices;
- the ease of operation and maintenance of the technology (i.e. emptying intervals);
- health and safety;
- the availability of adequate off-site disposal;
- the cost of collection/emptying.

7.5 Transportation

The appropriate transportation method depends heavily on:

- soil characteristics, topography and site practicalities;
- the availability of sufficient amounts of water for flushing (now and in the future);
- the volumes of wastewater produced in an area/region;
- the availability of financial and institutional capacity.

Factors that influence the choice, design and applicability of the transport system include the following:

- the amount and density of waste generated;
- housing/population density;
- accessibility;
- the terrain;

- the haul distance/proximity to disposal site;
- the efficiency of transportation system;
- capital and operational costs;
- institutional and business practices;
- local cultural and environmental perspectives;
- the availability of energy.

7.6 Treatment

The quality and quantity of the wastewater or faecal sludge will significantly affect the treatment technology that is receiving it for processing.

Treatment facilities are located either on-site or off-site, depending on the following factors:

- land availability;
- the reuse potential of excreta and grey water;
- capital investment and operational costs;
- health aspects and acceptance;
- the organization and/or management concept to be employed;
- the availability, relative distance and practicability of effluent transportation from the source to the treatment facility.

If use of treated excreta is appropriate at the household level, on-site treatment is preferred.

The location of the treatment facilities should be carefully chosen to maximize efficiency, while minimizing odours and nuisance to nearby residents.

The site for the treatment should be:

- easily accessible;
- conveniently located;
- easy to use, operate and sustain;
- protected from flooding;
- well constructed to prevent leaching and ground/surface water contamination.

7.7 Disposal/reuse

Where recovery of resources is desired, the actual design of the treatment facility and the disposal/reuse solutions depends on:

- the wastewater characteristics;
- the loading;
- the intended storage/retention time;
- the fertilizer value of sludge;
- the energy value and needs from the sludge;

- the availability of market/demand for recovered resources and energy;
- defined microbial standards on safe use of effluent, e.g. WHO guidelines[Z];
- the required hygienic/microbial quality of the products;
- the adequacy of sludge transformation points;
- the operation and maintenance of the transformation chain;
- the characteristics of the surrounding environment (both surface and subsurface).

8 Operation and maintenance

8.1 General

Basic on-site domestic wastewater systems should have written and visual instructions for operational and maintenance plans, disposal plans and/or education and training plans (see [Figure 5](#)).

When planning basic on-site domestic wastewater services, it is crucial to consider operation and maintenance from the very beginning of planning. Every technology needs operation and maintenance to fulfil its functions in the sanitation service chain. Planning of operation and maintenance should take into consideration defined responsibilities.

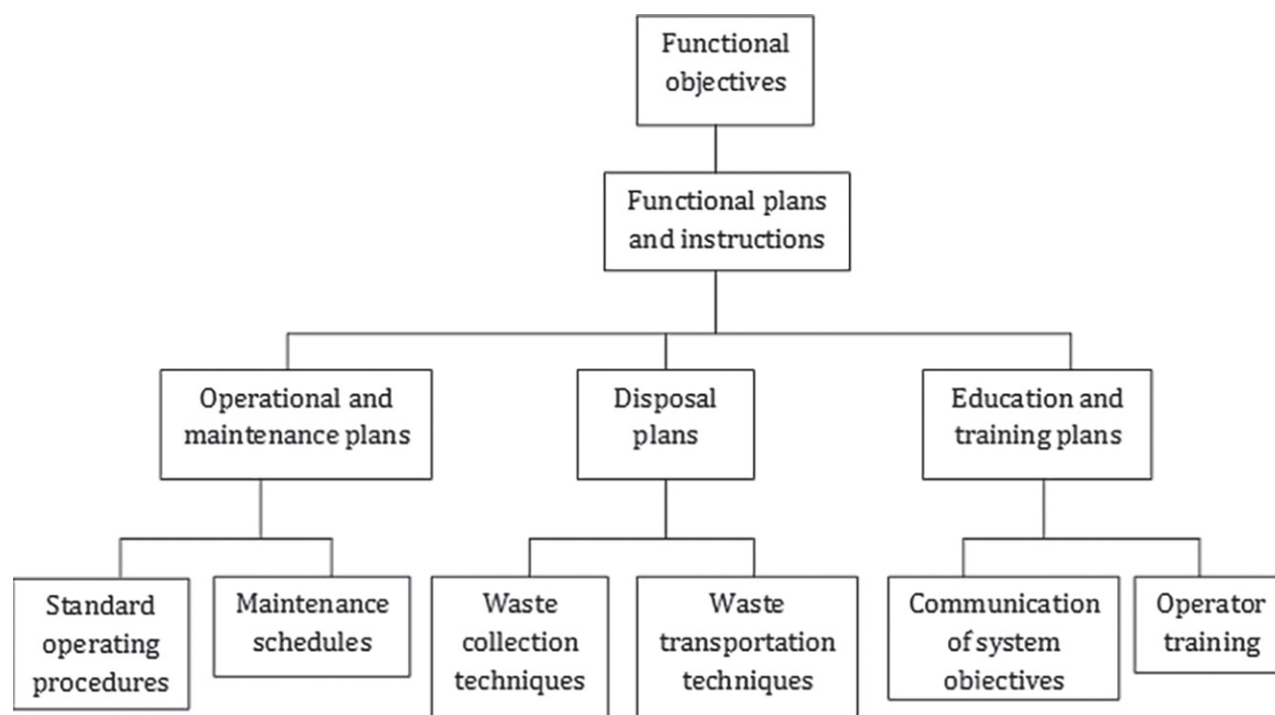

Figure 5 — Developing instructions for operational and maintenance plans, disposal plans and/or education and training plans

8.2 Developing operational plans and instructions

The documentation of operations for basic on-site domestic wastewater treatment systems should define the sequence of all essential operations required for the systems to treat the domestic waste properly and define the tasks necessary to maintain the processes, including the residues disposal and effluent discharge. Documentation using visual representations or instructions should provide all users with a clear understanding of the tasks necessary for proper operation and should minimize problems due to language or education. More detailed working instructions (such as standard operating

procedures and operation and maintenance manuals) should be prepared whenever required, in order to ensure the proper and expert handling of individual activities, adhering to applicable national or generally accepted requirements or practices.

8.3 Developing maintenance plans and instructions

The plan for maintenance of the system should be both preventative and reactive by including maintenance performed at planned intervals and a strategy for correcting an emergency condition resulting in system failure. Preventative maintenance includes maintenance performed at planned, condition-oriented or scheduled intervals in order to prevent, minimize or delay failures or ineffective treatment of domestic wastewater. Preventative maintenance eliminates many conditions that cause unplanned maintenance, as well as ensuring continued, efficient operation of the basic on-site domestic wastewater system and prolonging asset life. Reactive maintenance includes maintenance performed following a failure of the equipment, treatment process or shutdown, and involves activities necessary to repair or restore the system to a satisfactory condition or level of performance.

Some on-site wastewater treatment and disposal systems, such as constructed wetlands, may perform well for long periods of time with no or very little operator attention, but may require major maintenance work (e.g. removal of collected sediment or overgrown vegetation) in quite long time intervals. These long periods of non-activity often lead to total neglect of the required maintenance work, resulting in the system performance deterioration or failure. This should be prevented by establishing and implementing mechanisms (physical or administrative) that remind the responsible parties of the necessary maintenance activities.

8.4 Developing plans and instructions for collection of waste

Domestic wastewater is collected from different types of toilets. It may be undiluted when collected from dry toilets, dry urine diversion toilets or waterless urinals. It may be diluted when collected from pour flush toilets or conventional toilets that use water for flushing.

Collection techniques can include double pit system, plastic or metal containers or drums for collecting the urine, faeces, or both. Excreta can also be collected in vaults and chambers. Whenever possible, faeces and urine should be separated to facilitate reuse.

Implementation and operation of various toilet and collection techniques should include regular removal of excreta. Collected excreta should be handled carefully as they may contain pathogens. The systems should be structurally resistant to cracks and checked regularly for leakage. The capacity should be monitored to prevent overflow of the excreta.

8.5 Developing plans and instructions for transportation of waste

The sustainability and continuity of the entire sanitation system depends on good organization and management of transportation systems.

Depending on the volume and the characteristics of wastewater and sludge (both treated and untreated), different types of transportation techniques may be required. Cartage techniques include cycles and pushcarts, mechanical emptying systems and sewer systems (settled sewage, simplified systems or gravity conventional sewers). Cartage techniques and emptying systems should be regularly scheduled to prevent overflows and contamination of the immediate area. Sewer systems require relatively high water consumption for excreta removal and should be regularly checked for removal of sediments and identification and repair of leaks.

9 Health and safety issues

9.1 Health and safety measures and training

All facilities should be managed so that the health and safety of the users, community and service providers are maintained.

Users who handle waste/wastewater themselves and service providers/operators should undergo regular medical check-ups and, where applicable, should seek assurance from the public health authority as to their safety when operating wastewater services. Whenever practical and consistent with social customs, users and service providers/operators should be inoculated for protection against diseases that may be present in wastewater or waste residues.

These users and operators need protective equipment when handling wastewater.

The health of stakeholders who come into contact with the wastewater and/or sub-products of the basic on-site domestic wastewater system should be monitored for any infectious or parasitic diseases as a result of exposure to the basic on-site system.

To avoid health risks, user handling of excreta should only be after respective education/training.

Appropriate operator training is necessary for proper transport and handling of waste/wastewater to prevent or minimize operator risk and risk to the public (community) or environment (soil or natural waters) due to spills, contamination or exposure to the waste during transport. It should be confirmed that the operator is sufficiently well-trained before he/she is permitted to transport waste/wastewater.

In the event of an outbreak of disease originating from the basic on-site domestic wastewater system, the use of the system should be discontinued in order to address the cause of the outbreak. Alternatives to the basic on-site domestic wastewater system should be used during such periods.

See ISO 24511:2007, Annexes C and D, for additional guidance.

9.2 Public health programmes

Public health programmes should be put in place to mitigate any effects of sub-products of basic on-site domestic wastewater systems. Public health programmes should not be limited to investigations of the health of stakeholders, but should also include the testing of the basic on-site domestic wastewater system sub-products. The effectiveness of the programmes should also be monitored in that the testing of the basic on-site domestic wastewater system sub-products and subsequent treatment programme should address sources of diseases. Public health programmes should be conducted at regular intervals.

The health programmes should include (but not be limited to) the following:

- medical surveillance of concerned stakeholders;
- testing of sub-products for any pathogenic microorganisms or other hazardous materials;
- review of the use of technologies of the system to establish any improper use or faults that could promote activity of pathogenic microorganisms and, where possible, the kind of routes of exposure as a result of using the system;
- health and hygiene education, including promotion of washing hands with soap and/or an equivalent washing agent;
- pre-evaluation of a particular technology for possible failure that could promote the activity of pathogenic microorganisms as well as other hazards, where feasible.

Annex A (informative)

Corresponding terms in English, French and Spanish

[Table A.1](#) provides a table of correspondence between equivalent terms in English, French and Spanish.

Table A.1 — Corresponding terms in English, French and Spanish

| Term number | English | French | Spanish |
|---------------------|------------------------------------|--|---|
| 3.1 | basic | basique | básico |
| 3.2 | basic on-site domestic waste-water | services d'eaux usées domestiques de base sur site | servicios de aguas domésticas para usos básicos in situ |
| 3.3 | excreta | excréments | excrementos |
| 3.4 | land treatment | traitement par épandage | tratamiento de suelo |
| 3.5 | technology | technologie | tecnología |
| 3.6 | wetland | zone humide | humedal |

Annex B (informative)

Schematics of basic on-site domestic wastewater systems

B.1 General characteristics of basic on-site domestic wastewater services

General characteristics of basic on-site domestic wastewater services are as follows:

- technologies which are simple to use, to maintain and repair;
- technologies which are simple to manage;
- technologies which are locally available or which can be preferably built with local raw materials;
- technologies requiring low or no energy consumption;
- technologies which can be used with low or no water;
- technologies requiring no or low treatment chemicals;
- technologies which:
 - do more with less in the face of ever-changing requirements and tighter budget constraints;
 - question the status quo;
 - institute new ideas;
 - let the process open for changes;
 - abolish usual hierarchies.

NOTE 1 Definition adapted from Hach^[8].

Possible definitions for basic on-site domestic wastewater services:

- services intended to treat human waste/wastewater using readily available tools and equipment;
- services by less advanced or unsophisticated means of collecting and disposing of faeces/urine/wastewater in a hygienic way so as not to endanger the health of individuals and the community as a whole.

NOTE 2 Definition adapted from the WHO guidelines^[2].

B.2 Types of basic on-site domestic wastewater systems

[Figure B.1](#) shows different types of basic on-site domestic wastewater systems.

NOTE 1 The following terms are commonly used when referring to basic on-site domestic wastewater systems: improved traditional latrine, ventilated improved pit latrine, double-vault compost latrine, bored hole latrine, pour-flush latrine, septic tank, vacuum tanker.

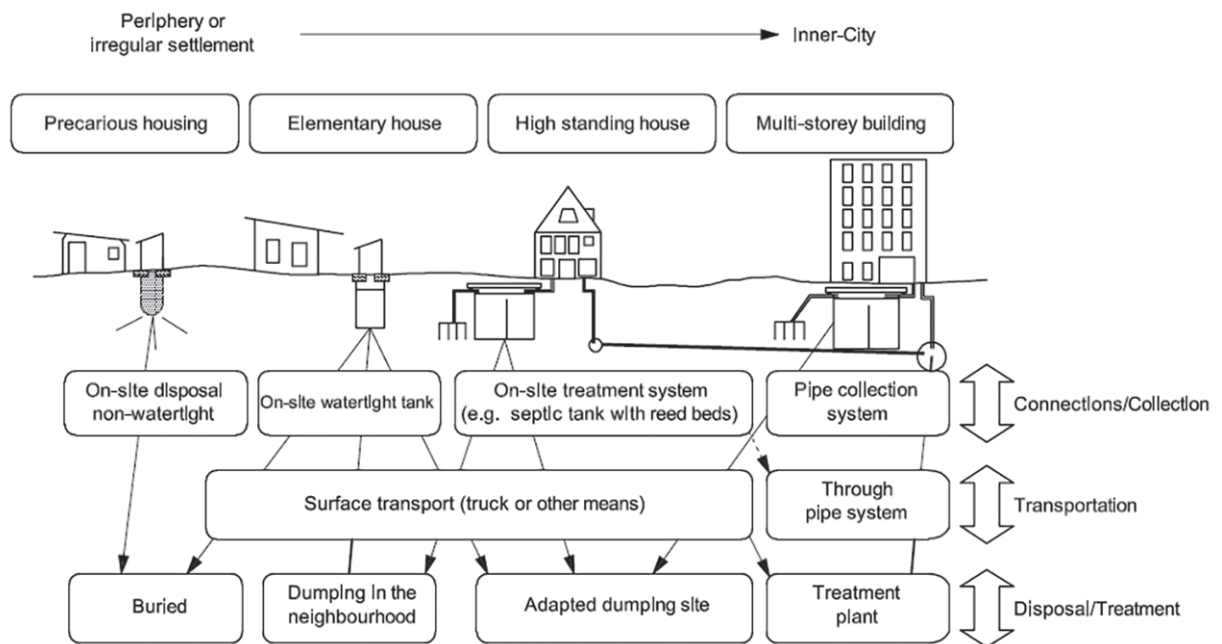

NOTE Figure source: ISO 24511:2007, Figure B.2.

Figure B.1 — Types of wastewater systems

NOTE 2 [Figure B.1](#) provides an overview of components of wastewater systems.

NOTE 3 The types of basic on-site wastewater systems shown in [Figure B.1](#) might not describe all options for a particular user, community or site. The examples provide a range of basic on-site domestic wastewater systems for different conditions, which will offer solutions to the largest number of users and comply with the socio-economic requirements.

NOTE 4 In addition to [Figure B.1](#), the disposal of sludge from latrines can be made use also as a fertilizer on land sides.

B.3 Detailed information of components for management of basic on-site domestic wastewater

B.3.1 Summary of user interface examples of basic on-site wastewater technologies

B.3.1.1 General

[Table B.1](#) provides a non-exhaustive list of user interface examples of basic on-site wastewater technologies.

NOTE [Table B.1](#) is adapted from pS-Eau^[6] and Compendium of Sanitation Systems and Technologies^[9].

Table B.1 — Summary of user interface examples of basic on-site wastewater technologies

| Type of technology | Water required | Energy required | Treatment ^a | | Recycling/reuse | Advantages | Disadvantages | Outputs |
|---|----------------|-----------------|------------------------|-------------|----------------------|---|--|---|
| | | | Passive | Non-passive | | | | |
| Simple ventilated/un-ventilated pit latrine | No | No | b | b | Yes, after treatment | <p>Can be constructed and repaired locally.</p> <p>Low investment and operating costs.</p> <p>Not necessary to have a constant source of water.</p> <p>Soil enrichment material and fertilizer is produced, cannot be used in areas where groundwater is close to ground surface or it is hard to dig a pit, minor runoffs.</p> | <p>Presence of flies and smells.</p> <p>Not very user-friendly.</p> <p>Requires regular transportation of effluent to a centralized treatment area.</p> <p>Latrine waste needs to be added litter, waste treatment requires time and education, prejudices in handling latrine waste may emerge due to cultural and other factors.</p> | Human excreta and urine |
| Ventilated improved pit latrine/fossa alterna | No | No | b | b | Yes, after treatment | <p>Can be constructed and repaired locally.</p> <p>Low investment and operating costs.</p> <p>Reduction of flies and smells.</p> <p>Not necessary to have a constant source of water.</p> | <p>Requires regular pit emptying.</p> <p>Requires sludge treatment.</p> | Human excreta and urine |
| Dry toilet (including urine diverting dry toilet, composting toilet and other basic dry toilet models and their variations) | No | No | b | b | Yes, after treatment | <p>Does not require a constant source of water.</p> <p>Can be built and repaired with locally available materials.</p> <p>Low capital and operating costs.</p> <p>Suitable for all types of users (sitters, squatters, washers, wipers).</p> | <p>Odours can occur if the vent pipe is not operating properly or if the pile is not covered after use with litter or bedding material.</p> <p>The excreta pile is visible except where a deep pit is used.</p> <p>Vectors such as flies are hard to control unless fly traps and appropriate covers for the pile are used.</p> | Human excreta and urine together, or in diverting models separately |

^a Passive treatment of the wastewater causes the waste to be degraded through naturally occurring organisms without the use of additional equipment to generate the organisms, but may include the use of additives. The capability of a design to provide non-passive treatment may depend on the topography of the site. Non-passive treatment uses external energy and includes additional equipment to treat the wastewater by moving the wastewater to other treatment stages with pumps or using compressors to introduce air into the wastewater.

^b Not applicable.

Table B.1 (continued)

| Type of technology | Water required | Energy required | Treatment ^a | | Recycling/reuse | Advantages | Disadvantages | Outputs |
|--|----------------|-----------------|------------------------|-------------|----------------------|---|--|-----------------|
| | | | Passive | Non-passive | | | | |
| Pour flush toilet | Yes | No | b | b | Yes, after treatment | Can be constructed and repaired locally. Low investment costs. No flies or smells. | Requires a constant source of water. Requires regular emptying if connected to a pit. High investment and operating costs for a watertight pit. Health risks due to the presence of unsanitized sludge. | Raw black water |
| Waterless urinal | no | no | b | b | Yes, after storage | Does not require a constant source of water. Can be constructed and repaired locally. Low investment costs. User friendly. | Odours can exist if not used correctly. Can only collect urine (excreta needs to be collected separately). Salts and minerals can build up to pipes. | Urine |
| <p>^a Passive treatment of the wastewater causes the waste to be degraded through naturally occurring organisms without the use of additional equipment to generate the organisms, but may include the use of additives. The capability of a design to provide non-passive treatment may depend on the topography of the site. Non-passive treatment uses external energy and includes additional equipment to treat the wastewater by moving the wastewater to other treatment stages with pumps or using compressors to introduce air into the wastewater.</p> <p>^b Not applicable.</p> | | | | | | | | |

Table B.1 (continued)

| Type of technology | Water required | Energy required | Treatment ^a | | Recycling/reuse | Advantages | Disadvantages | Outputs |
|--|----------------|-----------------|------------------------|-------------|----------------------|---|--|-----------------|
| | | | Passive | Non-passive | | | | |
| Cistern flush toilet | Yes | No | b | b | Yes, after treatment | Can be constructed and repaired locally. Very user-friendly. No flies or smells. | Requires a constant source of water. Requires regular emptying if connected to a pit. High investment and operating costs for a watertight pit. Health risks due to the presence of unsanitized sludge. There is risk of significant water wastage if the system is not functioning correctly (i.e. continuously running). | Raw black water |
| Washing facilities, e.g. grey water sink | Yes | No | b | b | Yes, after treatment | Can be constructed and repaired locally. Very user-friendly. No flies or smells. Improves hygiene after user interface with sanitation facilities. | Requires constant source of water. There is risk of water wastage if the system is not functioning correctly (i.e. continuously running). Risk of surface pollution if there is no storage. Risk of pollution if the groundwater table is high. | Grey-water only |
| Soak-away, e.g. for grey water | No | No | b | b | No | Can be constructed and repaired locally. Low investment and operating costs. Very small footprint. | Risk of pollution of the groundwater table if this is too high. | Grey-water only |
| <p>^a Passive treatment of the wastewater causes the waste to be degraded through naturally occurring organisms without the use of additional equipment to generate the organisms, but may include the use of additives. The capability of a design to provide non-passive treatment may depend on the topography of the site. Non-passive treatment uses external energy and includes additional equipment to treat the wastewater by moving the wastewater to other treatment stages with pumps or using compressors to introduce air into the wastewater.</p> <p>^b Not applicable.</p> | | | | | | | | |

B.3.1.2 Descriptions

B.3.1.2.1 Simple ventilated/unventilated pit latrine

A simple pit latrine is the simplest type of latrine technology. It enables the collection of excreta but it has the disadvantage of giving off smells and attracting flies.

A simple pit latrine is used to collect excreta, not grey-water. It is recommended that a soak-away (see [Figure B.2](#)) is constructed as a complement to the simple latrine to dispose of the grey-water.

There are options to deal with a filled up simple pit latrine, e.g.

- to emptied regularly and to treat the sludge;
- to plant a tree on the old pit and to move the toilet building on a new pit.

Prerequisites:

- a) The groundwater table is at a suitable depth (greater than 3 m from the bottom of the planned pit).
- b) There is a non-rocky layer several meters deep and water is able to infiltrate the soil.
- c) The nearest water source is over 30 m away.

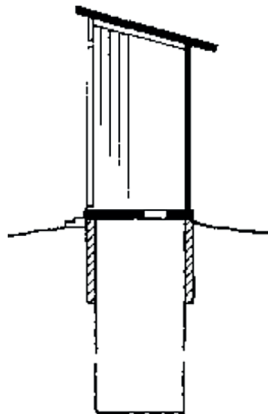

NOTE Figure source: pS-Eau[6].

Figure B.2 — Simple ventilated/unventilated pit latrine

B.3.1.2.2 Ventilated improved pit latrine/fossa alterna

The ventilated improved pit (VIP) latrine is more user-friendly than a simple toilet: the ventilation pipe serves to reduce the presence of flies and smells.

A VIP toilet is used to collect excreta, not grey-water. It is recommended that a soak-away (see [Figure B.3](#)) is constructed as a complement to the VIP latrine to dispose of the grey-water. The VIP toilet can be watertight (if the groundwater table is high) or enable filtration into the soil (where there is a low water table and permeable soil).

A VIP toilet needs to be emptied regularly and the sludge that is extracted needs to be treated.

Prerequisites:

- a) There is a low groundwater table.
- b) There is a non-rocky layer several meters deep and water is able to infiltrate the soil.

- c) The nearest water source is over 30 m away.
- d) Where possible, the buildings around the latrine are not very high

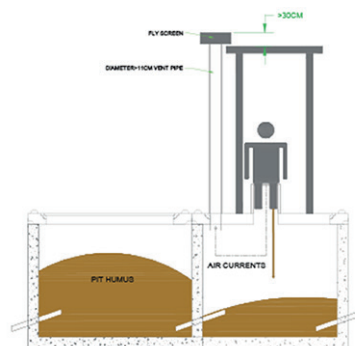

NOTE Figure sources: pS-Eau^[6] and Compendium of Sanitation Systems and Technologies^[9].

Figure B.3 — Ventilated improved pit latrine/fossa alterna

B.3.1.2.3 Dry toilet (including urine diverting dry toilet, composting toilet and other basic dry toilet models and their variations)

A dry toilet uses no or little amount of water and can include composting toilets, urine diverting dry toilets, dehydrating dry toilets and other variations. A urine diverting dry toilet separates the urine and faeces at source, i.e. within the toilet bowl or squatting slab (see [Figure B.4](#)).

A dry toilet is used to collect excreta, not grey-water. It is recommended that a soak-away is constructed at the same time as the dry toilet for disposal of the grey-water.

Dry toilet needs to be emptied regularly. Where the toilet is equipped with two drying pits, the sludge extracted is sanitized after storage time (12 to 18 months) and requires no further treatment.

Dry toilet creates, after proper storage and hygienization, ideal fertilizer or can be used as soil improver (see WHO guidelines^[7] for safe and sustainable use of dry toilet outputs). Land/space for disposal of sanitized excreta and/or source-separated urine and sludge should be available within reasonable distance from household.

Prerequisites: There are no particular prerequisites required for the area of intervention.



NOTE Figure source: Rieck et al^[10].

Figure B.4 — Sitting and squatting types of urine diverting dry toilets (UDDT)

B.3.1.2.4 Pour flush toilet

A pour flush toilet (see [Figure B.5](#)) provides improved user-friendliness as there is a water seal to prevent flies and smells.

A pour flush toilet needs to be connected to either:

- a pit (ventilated pit, septic tank) that requires regular emptying and additional sludge treatment, or
- a sewerage system, via a junction chamber that needs regular cleaning out.

Prerequisites:

- a) There is a low groundwater table (for a non-watertight pit).
- b) There is a non-rocky layer several meters deep.
- c) The nearest water source is over 30 m away (for a non-watertight pit).
- d) There is enough water available (2,5 l is required per flush, equating to typical water consumption of at least 30 l per person per day).

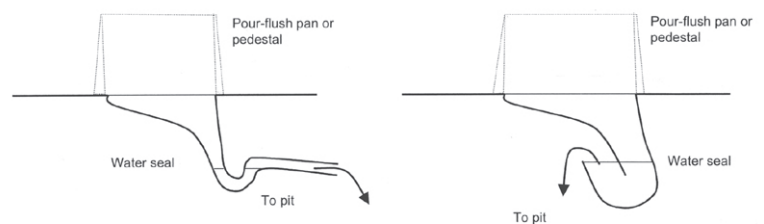

NOTE Figure sources: pS-Eaul^[6] and Parry-Jones^[11].

Figure B.5 — Pour flush toilet

B.3.1.2.5 Waterless urinal

A waterless urinal uses no water. Urinals (see [Figure B.6](#)) are generally for use by men, but also urinals for women have been developed and are becoming more common.

Waterless urinal is used to collect urine only; excreta and grey water need to be collected separately.

To minimize odours, urinal should be equipped with a proper seal. To minimize minerals building up to pipes regular maintenance should take place (slightly acidic water or hot water can be used to clean).

Waterless urinals save water and costs and allow collection of pure, undiluted urine for use in agriculture as a nitrogen and phosphorus-rich fertilizer.

Urine from urinals can be collected to sewer pipe or separate storage tank.

Land/space for disposal of stored urine should be available within reasonable distance from household. Urine is nutritious and can be used as fertilizer after appropriate storage times (see WHO guidelines^[Z]).



NOTE Figure sources: Caroma.com; Franke.com; Urimat.com; Waterless.com.¹⁾

Figure B.6 — Various designs of waterless urinals

B.3.1.2.6 Cistern flush toilet

The cistern flush toilet (see [Figure B.7](#)) provides improved user-friendliness through use of a water seal that eliminates flies and smells. The flush water comes from tank (cistern), so it requires a constant source of water. It is more convenient to use than a pour flush toilet as it is not necessary to fill a bucket with water for flushing, but simply to pull the chain or lever.

A cistern flush toilet should be connected to either:

- a pit (ventilated pit, septic tank) that requires regular emptying and treatment of the extracted sludge, or
- a sewerage system, via a junction chamber that requires regular cleaning out.

Prerequisites:

- a) There is a low groundwater table (for a non-watertight pit).
- b) There is a non-rocky layer several meters deep.
- c) The nearest water source is over 30 m away (for a non-watertight pit).
- d) There is a constant supply of water to the toilets.

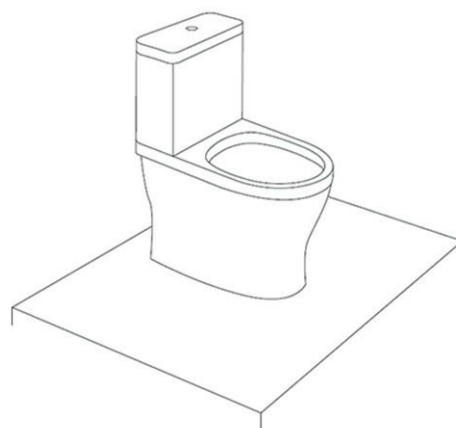
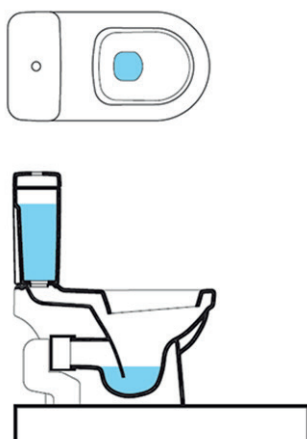

1) Caroma, Franke, Urimat and Waterless are examples of a suitable products available commercially. This information is given for the convenience of users of this document and does not constitute an endorsement by ISO of these products.

NOTE Figure sources: pS-Eau[6] and Compendium of Sanitation Systems and Technologies[9].

Figure B.7 — Cistern flush toilet

B.3.1.2.7 Washing facilities

A hand-washing facility is a [bowl](#) that is located in a [bathroom](#) or near a [toilet](#) or kitchen and has [pipes](#) to [supply](#) clean water and [carry](#) away grey [water](#) from [washing hands](#) with soap (see [Figure B.8](#)). It could also be a leaky tin, i.e. a container with a hole in the bottom of the sidewall and a stop to the hole. To wash hands, the stop is loosened and water flows from hole.



NOTE Figure source: [Global WASHES](#)[12].

Figure B.8 — Leaky tin and ceramic wash basin

Prerequisites:

- a) They are accessible and sufficient for the maximum anticipated attendance and configured for use by children, adults and those with disabilities.
- b) They are conveniently located in transition areas between animal and non-animal areas and in the non-animal food concession areas.
- c) There is maintenance, including routine cleaning and restocking, to ensure adequate supply of paper towels and soap.
- d) There is running water of sufficient volume and pressure to remove soil from hands. A permanent pressured water supply is preferable.
- e) The hand-washing station is designed so that both hands are free for hand-washing, by having operation with a foot pedal or water that stays on after turning on hand faucets.
- f) There is provision of a soap that emulsifies easily in cold water.

B.3.1.2.8 Soak-away

A soak-away (see [Figure B.9](#)) is a simple and inexpensive technology used for the collection of grey-water and its infiltration into the soil. The soak-away prevents wastewater from running through yards and in the streets.

It is recommended to always construct a soak-away with complementary or additional facilities that only handle excreta.

Prerequisites:

- a) There is a low groundwater table.

- b) There is a non-rocky layer several meters deep and water can infiltrate the soil.
- c) The nearest underground water source is over 30 m away.

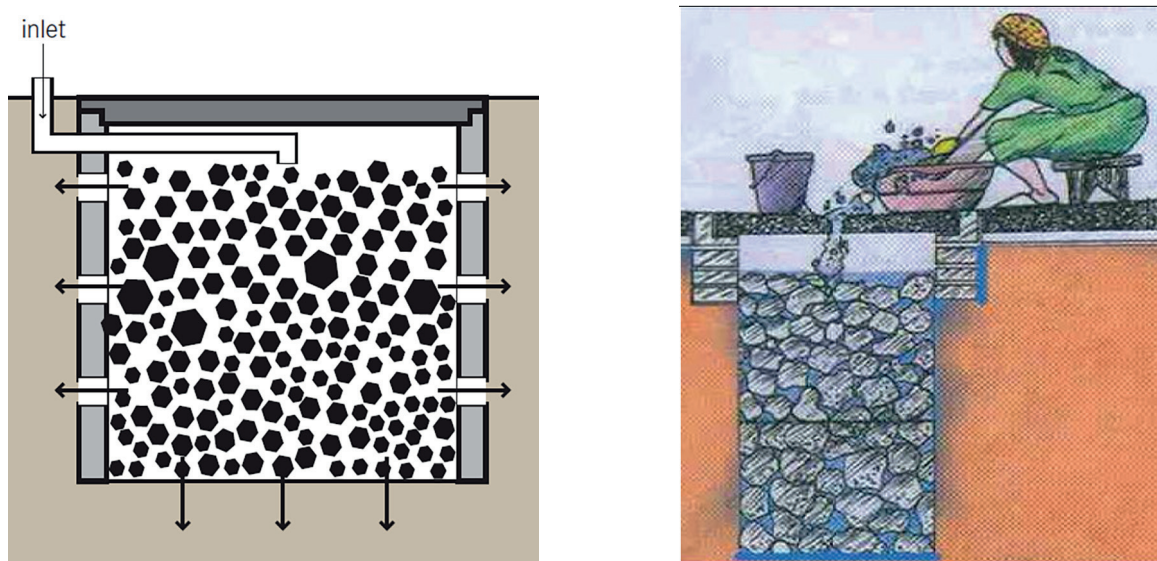

NOTE Figure sources: Compendium of Sanitation Systems and Technologies^[9] and Kopitopoulos^[13].

Figure B.9 — Soak-away

B.3.2 Summary of collection examples of basic on-site wastewater technologies

B.3.2.1 General

[Table B.2](#) gives a non-exhaustive list of collection examples of basic on-site wastewater technologies.

Table B.2 — Summary of collection examples of basic on-site wastewater technologies

| Type of technology | Water re-quired | Energy required | Treatment ^a | | Recycling/reuse | Advantages | Disadvantages |
|---|-----------------|-----------------|------------------------|--------------|----------------------|--|--|
| | | | Passive | Non-pas-sive | | | |
| Jerrycan/other tank | No | No | b | b | Yes, after treatment | Easy to transport. Low cost. Easy to clean. | Transfers small volumes. Risk of pollution when transferring. |
| Drum/vaults/chambers | No | No | b | b | Yes, after treatment | Stores larger vol-umes than jerrycan. Can be constructed and repaired using locally available materials. Low cost. | More difficult to empty than a jerrycan. Risk of pollution if leaks occur. Requires a low groundwater table. |
| Human-powered emp-tying | No | No | b | b | Yes, after treatment | Low cost. | Risk of pollution during emptying. Risk of exposure to pathogens dur-ing emptying. May not be so-cially acceptable as a job. |
| Motorized (pump or vacuum) emptying | No | No | b | b | Yes, after treatment | Faster emptying. Less risk of pollution than human-pow-ered emptying. | High cost. Equipment main-tenance required. Personnel re-quire training. |
| Transfer station (under-ground holding tank). | No | No | b | b | Yes, after treatment | Can be constructed using local materials. Encourages commu-nity use. May reduce trans-port distance to the final treatment location. | Typically requires a vacuum truck for emptying. Requires a low ground water table. Risk of pollution if tank leakage occurs. |

^a Passive treatment of the wastewater causes the waste to be degraded through naturally occurring organisms without the use of additional equipment to generate the organisms, but may include the use of additives. The capability of a design to provide non-passive treatment may depend on the topography of the site. Non-passive treatment uses external energy and includes additional equipment to treat the wastewater by moving the wastewater to other treatment stages with pumps or using compressors to introduce air into the wastewater.

^b Not applicable.

B.3.2.2 Descriptions

B.3.2.2.1 Jerrycan

A jerrycan is a small, lightweight, often plastic container that can be carried easily by one person. It is commonly used to transport urine to a central location for collection or for land application. Transporting wastewater using this method is time consuming because of the small volume of each jerrycan or tanks of this size. The wastewater should contain enough liquid to be transferred in and out of the jerrycan easily. There is a risk of operator exposure to the wastewater.

B.3.2.2.2 Drum/vaults/chambers

A storage device for wastewater (urine and faecal matter) that is installed above ground or below ground. It can be used as storage for multiple dwellings but needs to be emptied on a regular basis.

If the storage device is below ground, it should only be installed where there is a low water table to minimize the risk of pollution. The method of emptying and the distance to water sources should be considered when choosing a location for this storage device.

B.3.2.2.3 Human-powered emptying

Human-powered emptying of a wastewater storage device is carried out using shovels, buckets or a hand-operated pump. The type of wastewater and amount of solid material in the wastewater may determine the method that should be used. The wastewater is transferred from the storage device to a transportation device which has a tank. Human-powered emptying should minimize direct contact and exposure to fresh faecal matter or hazardous waste to reduce risk to the people emptying the storage device. This method is time consuming and may not be culturally acceptable.

B.3.2.2.4 Motorized (pump or vacuum) emptying

Motorized emptying of a wastewater storage device is carried out with equipment that has a pump and a transport storage tank, typically installed on a truck. A hose is connected to the pump and the wastewater is transferred from the storage device to the transport tank using the pump. The wastewater should contain enough liquid (urine, water or both) so that it can be transferred to the transport tank using the pump. This method is fast and minimizes contact with hazardous material. It is very expensive. Depending on the location of the storage device, it may not be possible to use motorized emptying.

B.3.2.2.5 Transfer station (underground holding tank)

The transfer station (underground holding tank) is a location to collect wastewater before it is transported to a final location for treatment. The wastewater is carried to the transfer station by jerrycans or in small tanks that are filled by hand using buckets, shovels or a hand-operated pump. The opening for dumping the wastewater into the transfer station should be low enough to minimize spillage. The transfer station should be easily accessible and located in a low water table area to reduce the risk of pollution in case of leakage. A transfer station is useful when there are several small sources of wastewater and the final treatment station is located far from the source of the wastewater. The wastewater in the transfer station should be removed regularly to prevent overflowing and potential pollution of the environment.

B.3.3 Summary of transportation examples of basic on-site wastewater technologies

B.3.3.1 General

[Table B.3](#) provides a non-exhaustive list of transportation examples of basic on-site wastewater technologies.

Table B.3 — Summary of transportation examples of basic on-site wastewater technologies

| Type of technology | Water required | Energy required | Treatment ^a | | Recycling/reuse | Advantages | Disadvantages | Outputs |
|---|----------------|-----------------|------------------------|-------------|----------------------|--|---|-------------|
| | | | Passive | Non-passive | | | | |
| Carts | No | No | b | b | Yes, after treatment | <p>Can be constructed and repaired using locally available materials.</p> <p>Low investment and operating costs.</p> <p>No electrical energy is required. Provides a pit emptying service to areas not connected to a sewerage system or areas difficult for vacuum trucks to access.</p> <p>Low cost for using the service.</p> | <p>Time-consuming: emptying is slow.</p> <p>Significant health risks for emptiers.</p> <p>Short range sludge transfer by tank-cart (sludge transport over large distances is impractical).</p> | Black water |
| Tricycle or any other human-powered multiple-wheeled vehicles | No | No | b | b | Yes, after treatment | <p>Can be constructed and repaired using locally available materials.</p> <p>Low investment and operating costs.</p> <p>No electrical energy is required. Provides a pit emptying service to areas not connected to a sewerage system or areas difficult for vacuum trucks to access.</p> <p>Transfer range is greater than cart.</p> <p>Low cost for using the service.</p> | <p>Time-consuming: emptying is slow.</p> <p>Significant health risks for emptiers.</p> <p>Transfer range is greater than cart range, but sludge transfer (sludge transport) over large distances is impractical.</p> | Black water |
| Trucks | No | No | b | b | Yes, after treatment | <p>Transfer range is greater than cart and tricycle or any other human-powered multiple-wheeled vehicle.</p> <p>Reduced potential for spills compared to carts and tricycle or any other human-powered multiple-wheeled vehicles.</p> <p>Larger transfer capacity.</p> | <p>Cannot be constructed and repaired using locally available materials.</p> <p>High investment and operating costs.</p> <p>May not be able to access sewerage collection location.</p> <p>Requires large amounts of fuel.</p> <p>High cost of service.</p> | Black water |
| Vacuum tankers | No | No | b | b | Yes, after treatment | <p>Quick and efficient emptying.</p> <p>Reduced health risks (safest emptying system in terms of health risks).</p> <p>Able to remove large volumes.</p> <p>Reduced potential for spills compared to carts and tricycle or any other human-powered multiple-wheeled vehicles.</p> | <p>Use is restricted to those areas accessible by vehicle.</p> <p>Does not remove dry (solid) sludge.</p> <p>High investment and operating costs.</p> <p>Requires large amounts of fuel.</p> <p>High cost of using the service.</p> | Black water |

^a Passive treatment of the wastewater causes the waste to be degraded through naturally occurring organisms without the use of additional equipment to generate the organisms, but may include the use of additives. The capability of a design to provide non-passive treatment may depend on the topography of the site. Non-passive treatment uses external energy and includes additional equipment to treat the wastewater by moving the wastewater to other treatment stages with pumps or using compressors to introduce air into the wastewater.

^b Not applicable.

There may be different types of transport techniques. All transport requires proper training of operators to ensure the health and safety of the operator and user and to avoid contamination to the environment. Operator training and knowledge should be confirmed before they are permitted to transport human waste/wastewater/residues. Emptying systems should be regularly scheduled to prevent overflows and contamination of the immediate area.

Sewer systems require relatively high water consumption for excreta removal and should be regularly checked for removal of sediments and identification and repair of leaks.

B.3.3.2 Descriptions

B.3.3.2.1 Carts

The use of a bucket for emptying is not, strictly speaking, a technology. This is a method of manually emptying sludge from a pit into a tank placed on top of a cart that is then used to transport the sludge to a location outside the town. There are health risks involved in this approach for the emptiers because they can come into contact with excreta. The advantage of this method is that the sludge is taken out of the neighbourhood (rather than being poured into a hole in the yard or directly into the street).

In urban areas, emptying by bucket needs to be followed by a sludge treatment process, such as that provided by drying beds, UASB reactors or anaerobic biogas reactors.

Prerequisites: There is a sludge discharge site (treatment site or discharge station) away from the neighbourhoods from which the sludge will be removed.

B.3.3.2.2 Tricycle or any other human-powered multiple-wheeled vehicles

Tricycles or any other human-powered multiple-wheeled vehicles are used for transporting waste/sludge from a smaller collection point to a larger collection point or to a treatment facility. Waste is manually collected from a pit using a bucket and emptied into a container mounted on a cycle with three wheels (tricycle or any other human-powered multiple-wheeled vehicle). The container is typically located in the back. This method transports the sludge out of the neighbourhood and can be used for transporting longer distances than possible by cart. There are health risks involved in this approach for the emptiers because they can come into contact with excreta.

In urban areas, emptying by bucket needs to be followed by a sludge treatment process, such as that provided by drying beds, UASB reactors or anaerobic biogas reactors.

Prerequisites:

- a) There is a sludge discharge site (treatment site or discharge station) away from the neighbourhoods from which the sludge will be removed.
- b) The roads are generally smooth since a tricycle or any other human-powered multiple-wheeled vehicle may be unable to move easily on very rough roads or where there are hills.
- c) If possible, containers should have lids to prevent spillage during transport and be detachable for emptying to reduce the risk of pollution if a manual emptying by bucket is required.

B.3.3.2.3 Trucks

Trucks are used to transport large amounts of waste/sludge from a smaller collection point (or points) to a larger collection point or treatment facility; often at great distances. If the truck has no equipment to empty the latrine or pit, it will be necessary to use a bucket to manually collect the waste/sludge. The emptiers are at risk of contact with excreta. There is risk of pollution during emptying. The use of trucks is expensive and has higher operating costs than carts or tricycle or any other human-powered multiple-wheeled vehicles.

Prerequisites:

- a) There are a large number of latrines that require the removal of waste/sludge contained in the pits.
- b) The smaller collection points are accessible by roads suitable for trucks.
- c) There is a sludge discharge site (treatment site or discharge station) away from the neighbourhoods from which the sludge will be removed.

B.3.3.2.4 Vacuum tankers

Vacuum trucks can be used to empty toilet and latrine pits without the operators coming into contact with excreta. The sludge is usually liquid but can sometimes be quite viscous. The removed sludge then needs to be transported to a treatment site or intermediate discharge station (where the sludge is collected to reduce the number of trips required to transport it to the final treatment site, further away).

Prerequisites:

- a) There are a large number of latrines that require the removal of sludge contained in the pits.
- b) The pits are accessible by roads suitable for vehicles.
- c) There is a sludge discharge site (treatment site or discharge station) away from the neighbourhoods from which the sludge will be removed.
- d) The pits only contain liquid sludge (water discharged into the pits, but not solids such as garbage).
- e) The pits are sufficiently robust that they will not collapse during emptying.

B.3.4 Summary of treatment examples of basic on-site wastewater technologies

B.3.4.1 General

[Table B.4](#) provides a non-exhaustive list of treatment examples of basic on-site wastewater technologies.

Table B.4 — Summary of treatment examples of basic on-site wastewater technologies

| Type of technology | Water required | Energy required | Treatment ^a | | Recycling/reuse | Advantages | Disadvantages | Outputs |
|--|----------------|------------------------------|------------------------|-----------------------|----------------------|--|---|----------------------|
| | | | Passive | Non-passive | | | | |
| Treatment of domestic wastewater | | | | | | | | |
| Septic tank system with adequate filtration, if discharged | Yes | No | Yes | No | Yes, after treatment | <p>Can be constructed and repaired locally.</p> <p>No flies or smells.</p> <p>Ensures primary treatment of wastewater and excreta. Very user-friendly.</p> <p>Can treat grey water, if designed for.</p> <p>Low investment and operating costs.</p> <p>Ensures primary treatment of black water.</p> | <p>Requires a constant source of water.</p> <p>Requires regular emptying.</p> <p>High investment costs.</p> <p>Effluent and sludge require secondary treatment</p> <p>Risk of pollution of the groundwater table.</p> | Effluent and sludge |
| Ponds (anaerobic, facultative, aerobic, maturation) | Yes | Yes, depending on topography | Yes | Depends on topography | Yes, after treatment | <p>Low or no energy consumption.</p> <p>Natural disinfection process depending on pond type.</p> <p>Sustainable technology.</p> | <p>Large land area may be required.</p> <p>Risk of pollution if not constructed properly.</p> <p>Type of pond determines waste load that can be treated.</p> <p>Small reduction in nutrients.</p> | Effluent and sludge |
| Constructed wetland | Yes | Yes, depending on topography | Yes | Depends on topography | Yes, after treatment | <p>Little or no energy required.</p> <p>May be low cost.</p> <p>Plants may provide nutrient removal</p> <p>Improved habitat for wildlife.</p> | <p>Should be carefully designed to use site topography and local plants.</p> <p>Large land area may be required.</p> <p>Possible degradation of pond due to changes in water flow or nutrients.</p> <p>Toxic materials may be retained in the pond.</p> | Effluent and biomass |
| <p>^a Passive treatment of the wastewater causes the waste to be degraded through naturally occurring organisms without the use of additional equipment to generate the organisms, but may include the use of additives. The capability of a design to provide non-passive treatment may depend on the topography of the site. Non-passive treatment uses external energy and includes additional equipment to treat the wastewater by moving the wastewater to other treatment stages with pumps or using compressors to introduce air into the wastewater.</p> <p>^b Not applicable.</p> | | | | | | | | |

Table B.4 (continued)

| Type of technology | Water required | Energy required | Treatment ^a | | Recycling/reuse | Advantages | Disadvantages | Outputs |
|--|----------------|-----------------|------------------------|-------------|-----------------------|---|--|------------------------------|
| | | | Passive | Non-passive | | | | |
| Land treatment (slow filtration, rapid filtration and overland flow) | Yes | No | Yes | No | Yes, after treatment. | May be constructed using local labour and materials. Little or no energy required. Plants may provide nutrient removal. | May require primary treatment. Large land area may be required. Not all sites qualify for land treatment. There should be a buffer zone around the application area to reduce risk of exposure to pathogens. May need to be shut down during cold weather. | Effluent |
| Biological treatment units, based usually on attached growth (such as trickling filters or rotating biological contactors) or suspended growth biological processes, such as low-rate activated sludge | Yes | Yes | No | Yes | Yes, after treatment | Small footprint. Simple mechanical equipment. Low odour. | Additional treatment required before disposal. Filtering media requires regular cleaning or it may plug. Beneficial bacteria may be killed by components in the wastewater. | Effluent and sludge |
| Upflow anaerobic sludge blanket reactor (UASB) | Yes | Yes | No | Yes | Yes, after treatment | Low energy costs. Simple construction. May be able to treat high strength wastewater. Requires less land than ponds. Biogas may be captured and used to generate electricity. | May require post treatment. Waste sludge requires disposal using drying beds and storage before land application. High initial cost. Possible odours. | Effluent, sludge and biomass |
| Treatment of sludge | | | | | | | | |
| <p>^a Passive treatment of the wastewater causes the waste to be degraded through naturally occurring organisms without the use of additional equipment to generate the organisms, but may include the use of additives. The capability of a design to provide non-passive treatment may depend on the topography of the site. Non-passive treatment uses external energy and includes additional equipment to treat the wastewater by moving the wastewater to other treatment stages with pumps or using compressors to introduce air into the wastewater.</p> <p>^b Not applicable.</p> | | | | | | | | |

Table B.4 (continued)

| Type of technology | Water required | Energy required | Treatment ^a | | Recycling/reuse | Advantages | Disadvantages | Outputs |
|--|----------------|-----------------|------------------------|-------------|----------------------|--|---|---------------------|
| | | | Passive | Non-passive | | | | |
| Sedimentation/thickening ponds | Yes | No | Yes | b | No | Can be constructed and repaired using locally available materials. Low investment costs. No electrical energy required. | Sludge and effluent need further treatment. The output sludge is still infectious, so particular care is required when handling it. Odours and flies are normally noticeable. Requires large areas. | Effluent and sludge |
| Unplanted drying beds | Yes | No | Yes | b | Yes, after treatment | Can be constructed and repaired using locally available materials. Low investment costs. No electrical energy required. Effective way to decrease the volume of sludge. | Sludge and effluent need further treatment. The output sludge is not effectively stabilized or sanitized, so particular care is required when handling it. Odours and flies are normally noticeable. Requires large areas. | Effluent and sludge |
| <p>^a Passive treatment of the wastewater causes the waste to be degraded through naturally occurring organisms without the use of additional equipment to generate the organisms, but may include the use of additives. The capability of a design to provide non-passive treatment may depend on the topography of the site. Non-passive treatment uses external energy and includes additional equipment to treat the wastewater by moving the wastewater to other treatment stages with pumps or using compressors to introduce air into the wastewater.</p> <p>^b Not applicable.</p> | | | | | | | | |

Table B.4 (continued)

| Type of technology | Water required | Energy required | Treatment ^a | | Recycling/reuse | Advantages | Disadvantages | Outputs |
|--|----------------|-----------------|------------------------|--------------|----------------------|--|---|-------------------------------|
| | | | Passive | Non-passive | | | | |
| Planted drying beds | Yes | No | Yes | ^b | Yes, after treatment | <p>Can be constructed and repaired using locally available materials.</p> <p>Medium-level investment costs, low operating costs.</p> <p>No electrical energy required.</p> <p>This system can be developed over time (in line with the quantities of sludge to be treated).</p> <p>Better quality of sludge obtained than from a solar drying bed.</p> | <p>Large footprint.</p> <p>Long storage times.</p> <p>Requires expert design.</p> <p>Resulting dehydrated sludge requires secondary treatment.</p> <p>Maintenance is more complex than for solar drying beds (thinning the filtering plants and planting new vegetation).</p> | Effluent, sludge and bio-mass |
| Co-composting (where composting is required with other available organic waste) | Yes | No | Yes | ^b | Yes | <p>It produces a beneficial soil conditioner which can improve local agriculture and food production.</p> <p>Can be constructed and repaired using locally available materials.</p> <p>Low investment costs.</p> <p>No energy required.</p> | <p>Labour intensive.</p> <p>Requires large areas.</p> <p>An available source of well-sorted biodegradable solid waste is required.</p> | Compost |
| <p>^a Passive treatment of the wastewater causes the waste to be degraded through naturally occurring organisms without the use of additional equipment to generate the organisms, but may include the use of additives. The capability of a design to provide non-passive treatment may depend on the topography of the site. Non-passive treatment uses external energy and includes additional equipment to treat the wastewater by moving the wastewater to other treatment stages with pumps or using compressors to introduce air into the wastewater.</p> <p>^b Not applicable.</p> | | | | | | | | |

Table B.4 (continued)

| Type of technology | Water required | Energy required | Treatment ^a | | Recycling/reuse | Advantages | Disadvantages | Outputs |
|---|----------------|-----------------|------------------------|--------------|-----------------|--|--|-------------------|
| | | | Passive | Non-passive | | | | |
| Anaerobic biogas reactor | Yes | No | Yes | ^b | Yes | Can be constructed and repaired using locally available materials. Produces energy. Medium investment costs, low operating costs. System has a long lifespan. Small footprint. | High-level skills required for design and construction. Sludge and effluent require further treatment. Risks associated with the production of biogas. Maintenance is needed to ensure operation at all times and operation and maintenance can require capital | Sludge and biogas |
| ^a Passive treatment of the wastewater causes the waste to be degraded through naturally occurring organisms without the use of additional equipment to generate the organisms, but may include the use of additives. The capability of a design to provide non-passive treatment may depend on the topography of the site. Non-passive treatment uses external energy and includes additional equipment to treat the wastewater by moving the wastewater to other treatment stages with pumps or using compressors to introduce air into the wastewater. ^b Not applicable. | | | | | | | | |

B.3.4.2 Descriptions

B.3.4.2.1 Septic tank system

Septic tanks are designed to collect black-water (and sometimes also designed to collect grey-water). They store and treat wastewater (primary excreta treatment) using mainly settling and anaerobic processes (see [Figure B.10](#)).

Septic tanks provide partial treatment, with the result that a large amount of pathogens remain. The effluent that is removed needs to undergo further treatment in a disposal field (usually through filtration in disposal pits, intermittent sand filters or mound filters).

Septic tanks should be emptied periodically to remove the accumulated thick sludge, depending on the toilet uses, to avoid its overflow.

Micro-septic tanks are designed only for black-water and have a minimal investment cost.

Prerequisites:

- a) There is a system in place for the subsequent treatment or evacuation of effluent from the septic tank (soak-away or infiltration trenches, sewerage system).
- b) There is sufficient water available (water consumption of at least 30 l per person per day).
- c) There is a pit emptying service available locally (or such a service can be set up).
- d) There is sufficient space available for the construction of a septic tank.

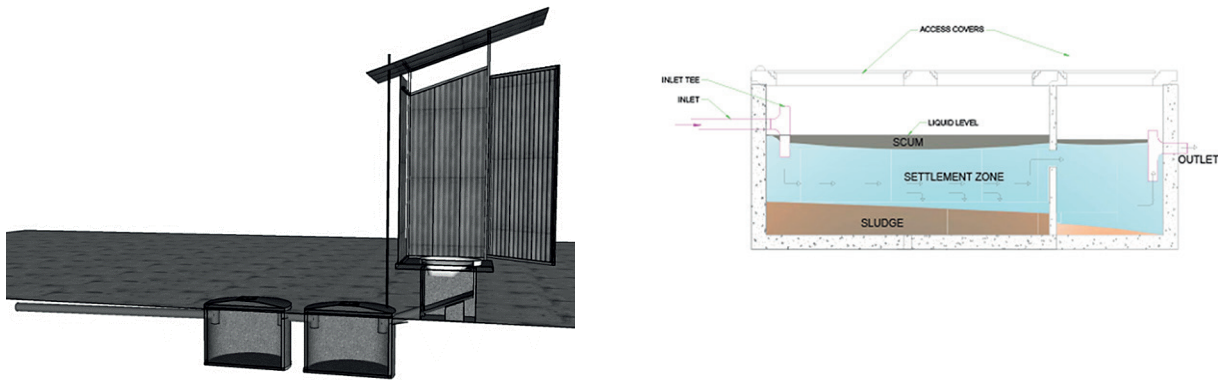

NOTE Figure sources: pS-Eau^[6] and Compendium of Sanitation Systems and Technologies^[9].

Figure B.10 — Examples of septic tanks

B.3.4.2.2 Ponds (anaerobic, facultative, aerobic, maturation)

Ponds used for domestic wastewater treatment typically require a larger footprint than many other on-site technologies and are often used where land is inexpensive (see [Figure B.11](#)). This requirement may limit their use in densely populated areas. Ponds use natural conditions of sun, wind, temperature, bacteria and algae to create an effluent that meets the quality for reuse. Wastewater remains in the ponds for a period of time during which time the natural conditions interact with the waste to create the desired effluent quality. Ponds may exist as a single pond or as a series of ponds with different characteristics.

An anaerobic pond does not contain dissolved oxygen, so the organic waste is broken down by anaerobic bacteria. This treatment pond is used primarily for removing suspended solids. In contrast, an aerobic pond has dissolved oxygen and organic waste is broken down by aerobic bacteria. An aerobic pond may require mechanical equipment to inject oxygen, although such equipment can be solar-powered, or a design where oxygen is introduced through natural agitation. A facultative pond has an upper aerobic layer containing dissolved oxygen and a lower anaerobic layer without dissolved oxygen. Both aerobic bacteria and algae can exist in the upper layer, along with bacteria that can be present in either aerobic or anaerobic conditions. There is also a boundary or intermediate layer between the upper and lower layers. Maturation ponds typically have a smaller footprint and are placed after facultative ponds to reduce concentrations of pathogens.

Ponds may be degraded by flow or the types of wastewater. There is a risk that contaminants will be retained in the pond.

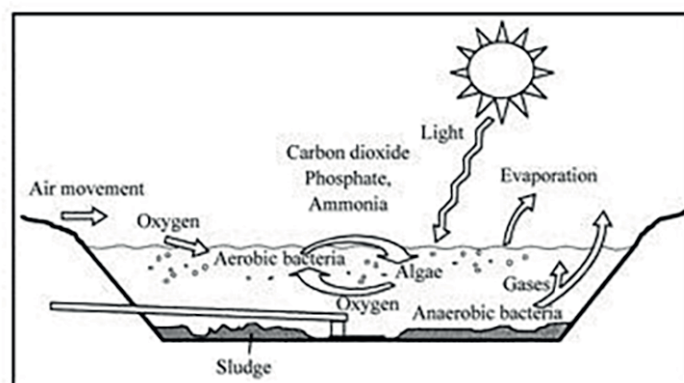

NOTE Figure source: Hygnstrom et al^[14].

Figure B.11 — Example of a wastewater pond

B.3.4.2.3 Constructed wetland

A constructed wetland is designed to treat several types of wastewater effluents by combining a variety of natural processes, including chemical, physical and biological (see [Figure B.12](#)). The system typically uses aquatic plants to create the treatment process. For this reason, they are commonly called reed beds. The most cost effective wetland uses gravity to achieve the treatment, so that pumps and electrical use are eliminated or minimized. The wastewater flow may be above the surface (above-surface flows) or below the surface (subsurface flows). Subsurface flows are preferred in developing countries to avoid the problem of creating a breeding environment for mosquitoes as may occur with above-surface flows. Like ponds, constructed wetlands require a large land footprint, so land needs to be inexpensive. This limits their use if the area is densely populated. To reduce the use of land, wetlands can be used after a primary anaerobic treatment process. An advantage of constructed wetlands is that the technology is simple and requires low maintenance. They can accommodate fluctuations in organic loading and flow volume, but need to be properly designed. To prevent groundwater contamination by the wastewater, the bottom of the wetlands should be properly sealed. Benefits of wetlands include the creation of wildlife habitat and growing crops in the wetlands area for biomass energy. Wetlands are more complex than wastewater ponds and have greater management requirements. Plants may need to be thinned or replanted to continue treatment processes.

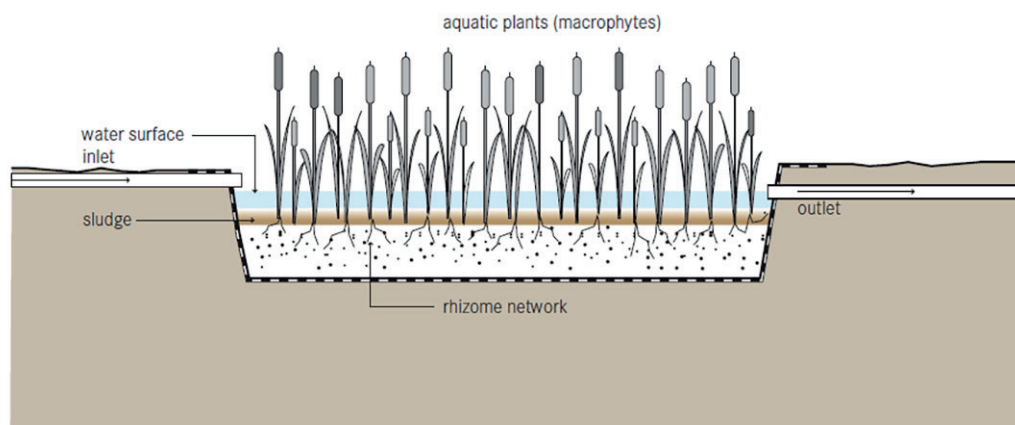

NOTE Figure source: Compendium of Sanitation Systems and Technologies[9].

Figure B.12 — Example of a constructed wetland

B.3.4.2.4 Land treatment (slow filtration, rapid filtration and overland flow)

Land treatment of wastewater is a method whereby partially treated wastewater is applied to land with controlled application techniques for further treatment, using crops or irrigation to treat the wastewater with the natural processes of the soil (see [Figure B.13](#)). The design of the application depends on the type of wastewater, the characteristics of the soil and the method of application. The slow filtration process requires the wastewater to be applied to land with vegetation to minimize runoff. The wastewater is absorbed by the plants or moves through the soil for treatment. Rapid infiltration applies the wastewater to soil that does not contain any plants. This method uses only the characteristics of the soil for treatment by filtration, adsorption or chemical processes that occur within the soil. This method allows for recharging of the groundwater. The overland flow design allows the wastewater to be applied to sloping land that contains various plants and vegetation for treatment to occur. It is a low cost method that is easy to operate and requires little maintenance or energy. The wastewater is collected by pipes at the bottom of the sloping land. This method is often used for secondary treatment. There should be careful planning and design in order to ensure complete treatment and to eliminate contamination of the groundwater from nutrients or pathogens.

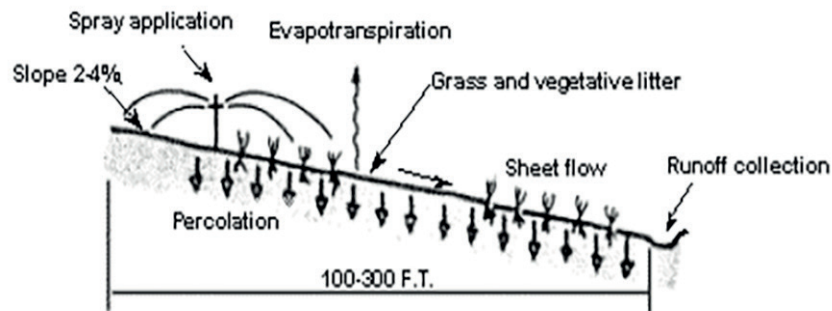

NOTE Figure source: United Nations Environment Programme[15].

Figure B.13 — Example of overland flow land application

B.3.4.2.5 Biological treatment units

Biological treatment units, based usually on attached growth (such as trickling filters or rotating biological contactors) or suspended growth biological processes (such as low-rate activated sludge) use a bed of rocks, gravel, algae or other types of materials to allow the wastewater to flow downward and be treated by the aerobic bacteria generated by the natural splashing mechanism of the process (see [Figure B.14](#)). Rotating biological contactors operate by filtering out the grit and other solids, allowing organic waste to come into contact with a biological medium, often plastic, which allows the waste to be treated by bacteria which grow on the biological medium.

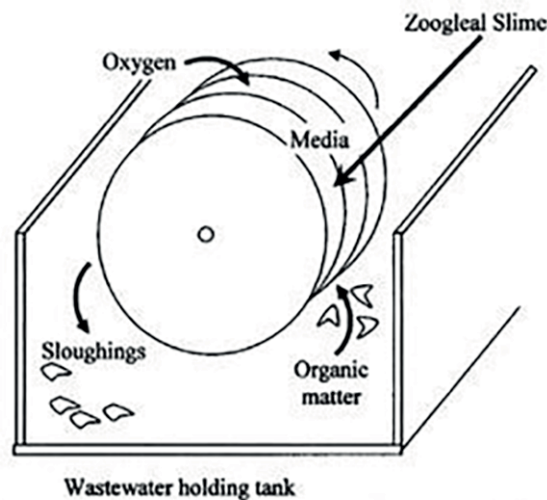

NOTE Figure source: Mountain Empire Community College[16].

Figure B.14 — Example of a rotating biological contactor

B.3.4.2.6 Upflow anaerobic sludge blanket reactor (UASB)

The upflow anaerobic sludge blanket reactor is a type of anaerobic digester that generates biogas that may be captured during the process for reuse (see [Figure B.15](#)). During this process, a blanket (layer) of sludge forms and is suspended in the wastewater. This happens in one or more individual tanks. The wastewater flows up through the sludge blanket where the waste is digested by anaerobic bacteria. This method requires careful monitoring to ensure that the sludge blanket is maintained and not washed away. The energy required for this process is typically lower than the energy necessary for conventional aerobic processes.

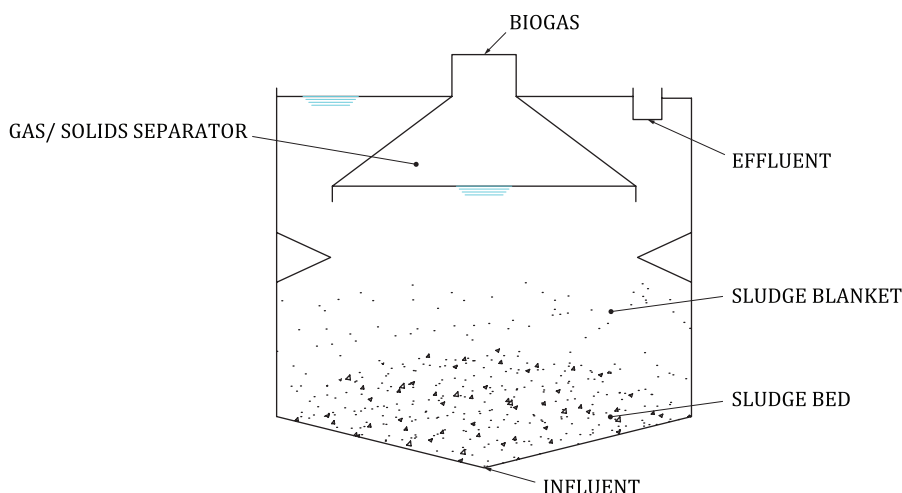

NOTE Figure source: U.S. EPA[19].

Figure B.15 — Upflow anaerobic sludge blanket reactor

B.3.4.2.7 Sedimentation/thickening ponds

This method allows for the thickening and dewatering of faecal sludge (see [Figure B.16](#)). The effluent can be removed and treated further. The thickened sludge can then be treated in waste stabilization ponds, in planted or unplanted drying beds, or by other methods. The ponds are simple systems, but the wastewater often has a long retention time to permit settling of the sludge if the source is a latrine or public toilets with holding tanks. Partially digested sludge from septic tanks or anaerobic digesters with solids that settle quickly require shorter retention times.

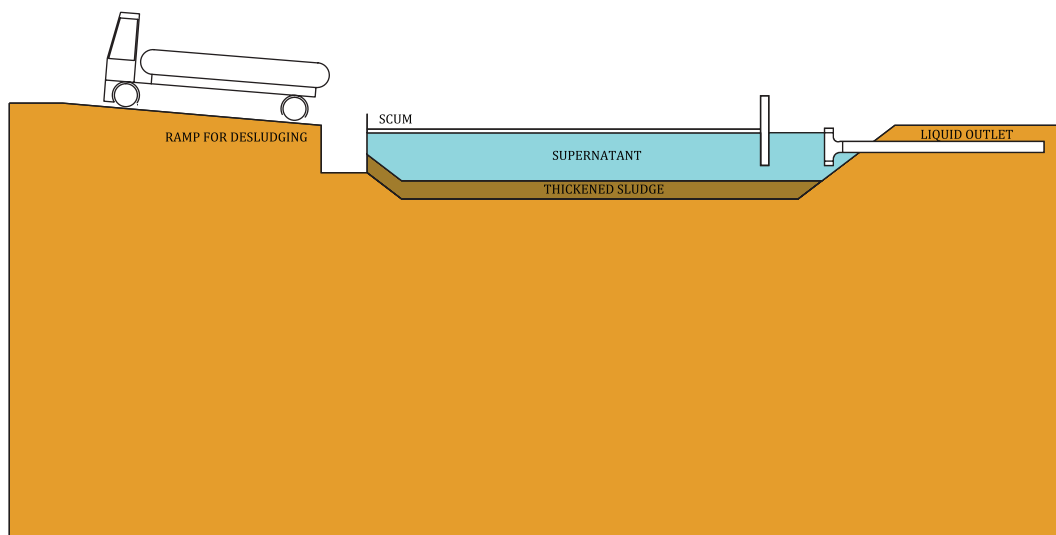

NOTE Figure source: Compendium of Sanitation Systems and Technologies[9].

Figure B.16 — Sedimentation/thickening pond

B.3.4.2.8 Unplanted drying beds

This method consists of a bed with various drainage layers that allow the sludge to move (percolate) through the layers allowing the sludge to dry (see [Figure B.17](#)). Although the water in the sludge is significantly reduced, there is no sanitization of the sludge. Additional treatment is required before the sludge can be used for fertilizer or safely disposed of. The beds should be desludged before fresh sludge

is applied. The beds are easy to construct and maintain but they require large surface areas. The cost is low if land is inexpensive and filtering materials like gravel are available locally. Manual or mechanical desludging is an important part of the process. The water flowing through the drainage layers may still contain pathogens and needs additional treatment before disposal or controlled reuse. The bottom of the bed uses perforated pipe to collect the percolate and transport it for further treatment. Beds should be installed away from the population to avoid the odours. Workers managing the unplanted drying beds should wear protective clothing because of the pathogens.

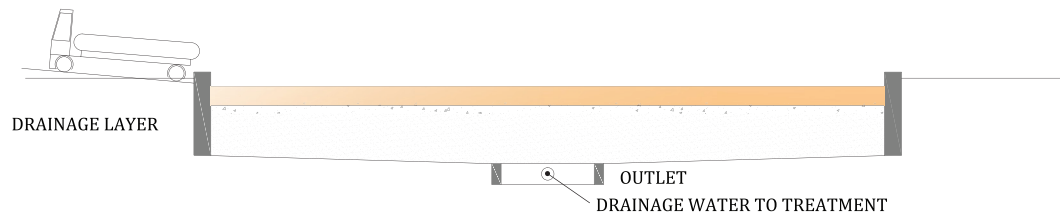

NOTE Figure source: Compendium of Sanitation Systems and Technologies[9].

Figure B.17 — Schematic of an unplanted drying bed

B.3.4.2.9 Planted drying beds

Planted drying beds treat the sludge obtained from pit emptying (see [Figure B.18](#)). This system uses a sand and gravel filter and the action of plants (macrophytes) and evapotranspiration to dry out the sludge and partially treat the residual water.

The sludge obtained as a result of this system needs to undergo further treatment that is less extensive than that required when using a solar drying bed, such as composting. The resulting effluent also needs to be treated, e.g. by anaerobic filter, by anaerobic baffled reactor, Imhoff tank or through means of a waste stabilization pond. This system can be used on either neighbourhood or town scale.

Prerequisites:

- a) The area of intervention is a small town or an urban neighbourhood.
- b) There is a local pit emptying service.
- c) There is sufficient space available for creation of the treatment plant.
- d) The plant is located a sufficient distance away from, and upwind of, housing areas (to avoid bad smells).
- e) There is an outlet after the drying bed for the evacuation of residual water.

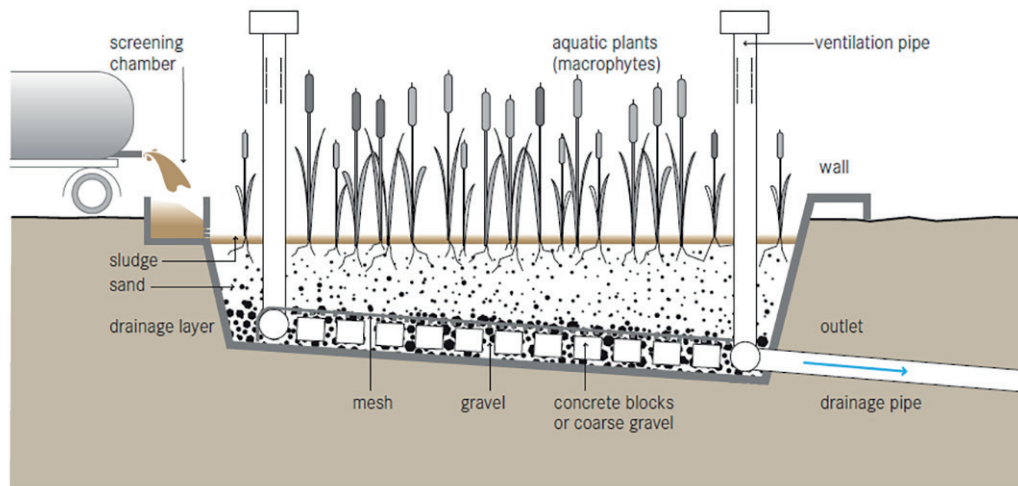

NOTE Figure source: Compendium of Sanitation Systems and Technologies[9].

Figure B.18 — Examples of planted drying beds

B.3.4.2.10 Co-composting

Composting is an extensive utilization technique, used where composting is required with other available organic waste. This system is based on natural processes, i.e. the degradation of organics by microorganisms that destroy the pathogens contained in the sludge (see [Figure B.19](#)). The resulting compost provides nutrients to cultivated land, improves the retention properties of the soil and the storage of minerals. In contrast to chemical fertilizer, it enriches the soil.

The sludge to be treated (which has already undergone treatment in a solar or planted drying bed) can be combined with organic matter from household waste or vegetation to optimize the composting process. There need to be sufficient moisture levels to ensure decomposition in optimum conditions. Composting consists of several stages, during which different types of microorganisms break down the organic matter. The material to be composted is piled into heaps, so little infrastructure is required.

Prerequisites:

- There is a low groundwater table.
- There is sufficient water available in the area.
- The composting site is located away from housing or against the wind (if the process is carried out correctly, there should be no flies or smells).
- There is an initial pre-treatment system or one can be put in place (e.g. solar or planted drying bed).
- There is an agricultural sector near the site interested in using the compost.

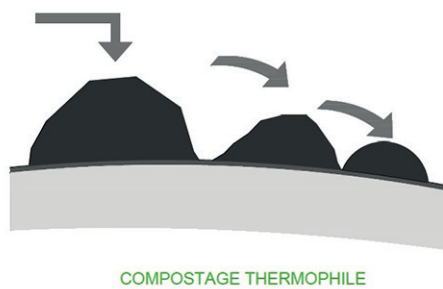

NOTE Figure source: Strauss et al[17].

Figure B.19 — Examples of co-composting

B.3.4.2.11 Anaerobic biogas reactor

Anaerobic biogas reactors are used for the anaerobic treatment of faecal sludge and produce biogas, a gas that can for example be used to produce electricity for cooking. This system produces effluent that requires secondary treatment.

Prerequisites:

- a) The biogas can be reused at a distance or within the reactor.
- b) There is a non-rocky layer several meters deep.
- c) There is a local pit emptying service (or one can be set up).
- d) There is a subsequent system in place for treating or using the resulting sludge.

B.3.5 Summary of disposal/reuse examples of basic on-site wastewater technologies

B.3.5.1 General

[Table B.5](#) provides a non-exhaustive list of disposal/reuse examples of basic on-site wastewater technologies.

Table B.5 — Summary of disposal/reuse examples of basic on-site wastewater technologies

| Type of technology | Water required | Energy required | Treatment ^a | | Recycling/reuse | Advantages | Disadvantages |
|--------------------|----------------|----------------------------------|------------------------|-------------------------------|---|---|---|
| | | | Passive | Non-passive | | | |
| Energy recovery | No | Depends on the system | Yes, without energy | Yes, with energy for aeration | Following the energy recovery, the sludge may be used after treatment | Will provide some energy in remote areas or for specific application. | Requires occasional maintenance such as sludge removal. |
| Effluent disposal | No | Yes for removal and distribution | Yes | No | Yes for irrigation and soil enrichment after treatment | Improves crop production. | Should not be used for food crop production. Run off into water bodies should be prevented. |
| Land application | No | No | Yes | No | Yes with proper treatment | Recharges groundwater. Minimizes flow of wastewater into surface streams. Provides additional treatment after initial treatment. Simple process. Can restore soil nutrients. Can be used for growing plants. | May require large land areas. May not remove all pollutants or pathogens. Possible contamination of groundwater or soil. Treatment effectiveness depends on application method and type of soil. Some application methods may cause soil erosion. |

^a Passive treatment of the wastewater causes the waste to be degraded through naturally occurring organisms without the use of additional equipment to generate the organisms, but may include the use of additives. The capability of a design to provide non-passive treatment may depend on the topography of the site. Non-passive treatment uses external energy and includes additional equipment to treat the wastewater by moving the wastewater to other treatment stages with pumps or using compressors to introduce air into the wastewater.

B.3.5.2 Descriptions

B.3.5.2.1 Effluent disposal

The proper disposal of treated effluent is an essential part of planning and designing wastewater facilities. There are different methods for the ultimate disposal of treated effluents.

The most common disposal practice when dealing, for example, with the effluent of stabilization ponds, constructed wetlands or compact biological treatment units is to discharge the treated effluent by gravity pipes into natural waters. The self-purification or assimilative capacity of natural waters is utilized to provide further treatment. Other common effluent disposal practice is the discharge of the effluent from septic tanks into the ground via drains or soaks wells.

Less common disposal methods include natural evaporation (a process that involves relatively large impoundments with no discharge) and those related with effluent reuse for agriculture or other compatible uses.

Disposal methods should be planned to prevent or minimize public health risks and negative environmental effects.

B.3.5.2.2 Land application

Land application of primary treated wastewater can replenish soil nutrients, recharge groundwater and potentially minimize flow of wastewater into surface streams. Applying the primary effluent to the land with controlled application techniques creates secondary and tertiary treatment by using the natural processes of the soil and plants. The design of the application depends on the type of wastewater, quality of the primary effluent, characteristics of the soil and method of application.

Types of land application are slow filtration, rapid infiltration and overland flow.

- The slow filtration process requires the wastewater to be applied to land with vegetation to minimize runoff. The wastewater is absorbed by the plants or moves through the soil for treatment. This method can be most effective in removing pollutants and pathogens if the proper soil characteristics are present.
- Rapid infiltration applies the wastewater to soil that does not contain any plants. This method uses only the characteristics of the soil for treatment by filtration, adsorption or chemical processes that occur within the soil. This method allows for recharging of the groundwater. Rapid infiltration may not remove all of the pollutants.
- The overland flow design allows the wastewater to be applied to sloping land where various plants and vegetation allow treatment to occur. The wastewater is collected by pipes at the bottom of the sloping land. This method is often used for secondary treatment but may not be effective in removing all pathogens.

Land application is a low cost method that is easy to operate and requires little maintenance or energy. However, this method can require large land areas and may contaminate soil or groundwater depending on the quality of the effluent and the soil characteristics. There should be careful planning and design in order to ensure complete treatment during land application and to eliminate contamination of the groundwater from nutrients or pathogens.

B.3.5.2.3 Energy recovery

Energy is recovered by means of biogas generators.

In many rural areas, most villages do not have electricity, and commercial fuels like kerosene and coal are expensive. The rural population relies heavily on locally available biological sources of energy. Fuel wood and crop residues (mostly straw) can account for much of rural household energy use.

The basic biogas system involves an anaerobic digester (usually underground) with an inlet pipe, an outlet pipe and a tube for the biogas collection and storage component (see [Figure B.20](#)). The feedstock is a combination of plant and animal wastes (including human waste) plus water. Crop residues as well as tree litter and weeds are suitable, as are manure from pigs, cows, chickens and humans. The mixture ferments in the digester tank to produce biogas, which contains 60 % to 70 % methane (CH₄).

The energy content is 22 GJ per m³, about the same as 0,5 l of kerosene. The basic chemical reaction is:

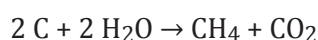

The process occurs with the aid of bacteria and is temperature sensitive (the range is 8 °C to 60 °C). Under ideal conditions, a 10 m³ digester can supply enough gas for cooking and lighting for a family of five. Biogas can also be used for fuelling farm machinery and for power generation. Both the liquid sludge from the outlet pipe and the sediment at the bottom of the tank are very good fertilizers.

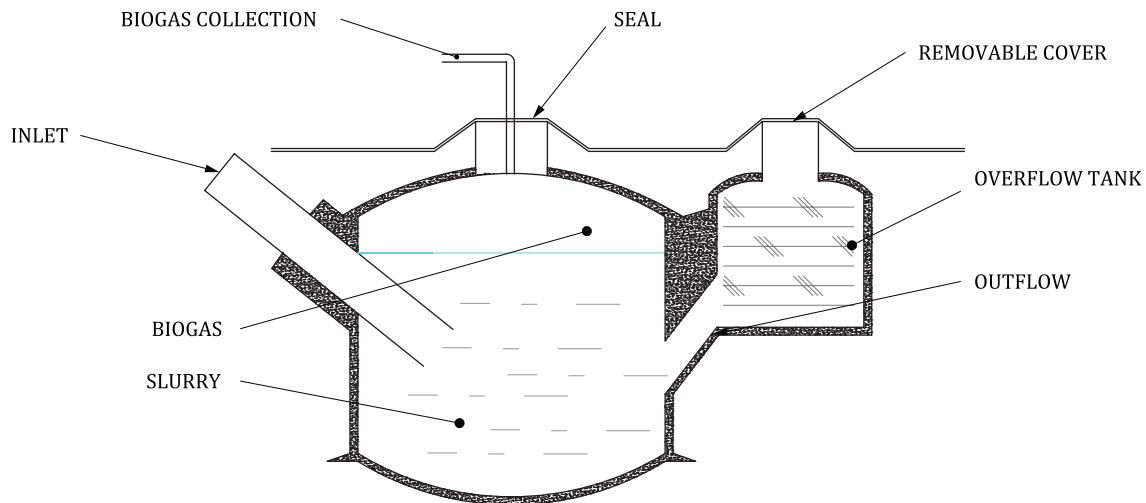

NOTE Figure source: Kangmin and Ho[18].

Figure B.20 — Basic biogas digester

Some systems can have mechanical paddles inserted to stir the slurry and enhance the bio digestion.

If two digesters are built, they can be operated alternately. The digester that is not being used can be drained and the digested sludge can be removed and used as soil enhancement and enrichment products, i.e. biosolids. It normally takes about three weeks for the CH₄ (methane gas) to be generated in sufficient quantities to be useful.

Bibliography

- [1] ISO 9001, *Quality management systems — Requirements*
- [2] ISO 14001, *Environmental management systems — Requirements with guidance for use*
- [3] ISO 16075 (all parts), *Guidelines for treated wastewater use for irrigation projects*
- [4] ISO 24512, *Activities relating to drinking water and wastewater services — Guidelines for the management of drinking water utilities and for the assessment of drinking water services*
- [5] UNICEF/WHO. Progress on Sanitation and Drinking Water — 2015 Update and MDG Assessment 2015
- [6] pS-Eau, *How to select appropriate technical solutions for sanitation*, Municipal Development Partnership [MDP] and programme Solidarité Eau (pS-Eau), 2010.
- [7] WHO. A Guide to the Development of On-Site Sanitation, World Health Organization., 1992, Available at http://www.who.int/water_sanitation_health/hygiene/envsan/onsitesan.pdf
- [8] Hach, *Lean Operations for the Water and Wastewater Industry*. Hach Company, 2011. Available at: <http://www.hach.com/hachwims>
- [9] TILLEY E., ULRICH L., LUETHI C., REYMOND P., ZURBRUEGG C. *Compendium of Sanitation Systems and Technologies*, Duebendorf, Switzerland, Swiss Federal Institute of Aquatic Science and Technology (Eawag), 2nd Revised Edition, 2014. Available at: <http://www.eawag.ch/en/department/sandec/publikationen/compendium/>
- [10] RIECK C., VON MÜNCH E., HOFFMANN H. Technology review of urine-diverting dry toilets (UDDTs) — Overview on design, management, maintenance and costs, Deutsche Gesellschaft für Internationale Zusammenarbeit (GIZ) GmbH., Eschborn, Germany, 2012 Available at <http://www.susana.org/en/resources/library/details/874>
- [11] PARRY-JONES S. *On-site sanitation in areas with a high groundwater table*, 1999, Reviewed and Updated: Scott R., September 2005. Available at: <http://www.lboro.ac.uk/well/resources/fact-sheets/fact-sheets-htm/lcsahgt.htm>
- [12] Global WASHES. *Global Water, Sanitation, and Hygiene Entrepreneurial Solutions*. Available at: <https://globalwashes.wordpress.com/>
- [13] KOPITOPOULOS D. Guide pour l'assainissement liquide des douars marocains, ONEP/The World Bank, 2005
- [14] HYGSTROM J., SKIPTON S., WOLDT W. *Residential Onsite Wastewater Treatment: Lagoon Maintenance*, University of Nebraska- Lincoln Extension, Institute of Agriculture and Natural Resources, Lincoln, Nebraska USA, Revised May 2011. Available at: <http://extensionpublications.unl.edu/assets/pdf/g1423.pdf>
- [15] United Nations Environment Programme, Sourcebook of Alternative Technologies for Freshwater Augmentation in West Asia.
- [16] Mountain Empire Community College, Big Stone Gap, Virginia, USA 24219; Courses: ENV110: Introduction to Water/Wastewater Technology and ENV149: Wastewater Treatment Plant Operation, 2015
- [17] STRAUSS M., DRESCHER S., ZURBRÜGG C., MONTANGERO A., COFIE O., DRECHSEL P. Co-composting of faecal sludge and municipal organic waste — A literature and state-of-knowledge review. 2003 Available at, <http://www.susana.org/en/resources/library/details/1548>

- [18] KANGMIN L., & HO M. *Biogas China; ISIS Report 02/10/06*. Available at: <http://www.i-sis.org.uk/BiogasChina.php>
- [19] U.S. EPA. *Onsite Wastewater Treatment Systems Manual*, Office of Water, Office of Research and Development; U.S. Environmental Protection Agency. 2002 Available at: nepis.epa.gov/Exe/ZyPURL.cgi?Dockey=30004GXI.TXT

British Standards Institution (BSI)

BSI is the national body responsible for preparing British Standards and other standards-related publications, information and services.

BSI is incorporated by Royal Charter. British Standards and other standardization products are published by BSI Standards Limited.

About us

We bring together business, industry, government, consumers, innovators and others to shape their combined experience and expertise into standards-based solutions.

The knowledge embodied in our standards has been carefully assembled in a dependable format and refined through our open consultation process. Organizations of all sizes and across all sectors choose standards to help them achieve their goals.

Information on standards

We can provide you with the knowledge that your organization needs to succeed. Find out more about British Standards by visiting our website at bsigroup.com/standards or contacting our Customer Services team or Knowledge Centre.

Buying standards

You can buy and download PDF versions of BSI publications, including British and adopted European and international standards, through our website at bsigroup.com/shop, where hard copies can also be purchased.

If you need international and foreign standards from other Standards Development Organizations, hard copies can be ordered from our Customer Services team.

Copyright in BSI publications

All the content in BSI publications, including British Standards, is the property of and copyrighted by BSI or some person or entity that owns copyright in the information used (such as the international standardization bodies) and has formally licensed such information to BSI for commercial publication and use.

Save for the provisions below, you may not transfer, share or disseminate any portion of the standard to any other person. You may not adapt, distribute, commercially exploit, or publicly display the standard or any portion thereof in any manner whatsoever without BSI's prior written consent.

Storing and using standards

Standards purchased in soft copy format:

- A British Standard purchased in soft copy format is licensed to a sole named user for personal or internal company use only.
- The standard may be stored on more than 1 device provided that it is accessible by the sole named user only and that only 1 copy is accessed at any one time.
- A single paper copy may be printed for personal or internal company use only.

Standards purchased in hard copy format:

- A British Standard purchased in hard copy format is for personal or internal company use only.
- It may not be further reproduced – in any format – to create an additional copy. This includes scanning of the document.

If you need more than 1 copy of the document, or if you wish to share the document on an internal network, you can save money by choosing a subscription product (see 'Subscriptions').

Reproducing extracts

For permission to reproduce content from BSI publications contact the BSI Copyright & Licensing team.

Subscriptions

Our range of subscription services are designed to make using standards easier for you. For further information on our subscription products go to bsigroup.com/subscriptions.

With **British Standards Online (BSOL)** you'll have instant access to over 55,000 British and adopted European and international standards from your desktop. It's available 24/7 and is refreshed daily so you'll always be up to date.

You can keep in touch with standards developments and receive substantial discounts on the purchase price of standards, both in single copy and subscription format, by becoming a **BSI Subscribing Member**.

PLUS is an updating service exclusive to BSI Subscribing Members. You will automatically receive the latest hard copy of your standards when they're revised or replaced.

To find out more about becoming a BSI Subscribing Member and the benefits of membership, please visit bsigroup.com/shop.

With a **Multi-User Network Licence (MUNL)** you are able to host standards publications on your intranet. Licences can cover as few or as many users as you wish. With updates supplied as soon as they're available, you can be sure your documentation is current. For further information, email subscriptions@bsigroup.com.

Revisions

Our British Standards and other publications are updated by amendment or revision.

We continually improve the quality of our products and services to benefit your business. If you find an inaccuracy or ambiguity within a British Standard or other BSI publication please inform the Knowledge Centre.

Useful Contacts

Customer Services

Tel: +44 345 086 9001

Email (orders): orders@bsigroup.com

Email (enquiries): cservices@bsigroup.com

Subscriptions

Tel: +44 345 086 9001

Email: subscriptions@bsigroup.com

Knowledge Centre

Tel: +44 20 8996 7004

Email: knowledgecentre@bsigroup.com

Copyright & Licensing

Tel: +44 20 8996 7070

Email: copyright@bsigroup.com

BSI Group Headquarters

389 Chiswick High Road London W4 4AL UK