

BS ISO 24409-2:2014



BSI Standards Publication

# **Ships and marine technology — Design, location and use of shipboard safety signs, safety- related signs, safety notices and safety markings**

Part 2: Catalogue

**bsi.**

...making excellence a habit.™

**National foreword**

This British Standard is the UK implementation of ISO 24409-2:2014.

The UK participation in its preparation was entrusted to Technical Committee SME/32/-/1, Lifesaving and fire protection.

A list of organizations represented on this committee can be obtained on request to its secretary.

This publication does not purport to include all the necessary provisions of a contract. Users are responsible for its correct application.

© The British Standards Institution 2014. Published by BSI Standards Limited 2014

ISBN 978 0 580 66169 3

ICS 47.020.01

**Compliance with a British Standard cannot confer immunity from legal obligations.**

This British Standard was published under the authority of the Standards Policy and Strategy Committee on 31 January 2014.

**Amendments issued since publication**

Date	Text affected
------	---------------

---

---

---

**Ships and marine technology — Design,  
location and use of shipboard safety  
signs, safety-related signs, safety notices  
and safety markings —**

Part 2:  
**Catalogue**

*Navires et technologie maritime — Conception, emplacement et  
utilisation des signaux de sécurité, signaux relatifs à la sécurité, notes  
de sécurité et marquages de sécurité à bord des navires —*

*Partie 2: Catalogue*





**COPYRIGHT PROTECTED DOCUMENT**

© ISO 2014

All rights reserved. Unless otherwise specified, no part of this publication may be reproduced or utilized otherwise in any form or by any means, electronic or mechanical, including photocopying, or posting on the internet or an intranet, without prior written permission. Permission can be requested from either ISO at the address below or ISO's member body in the country of the requester.

ISO copyright office  
Case postale 56 • CH-1211 Geneva 20  
Tel. + 41 22 749 01 11  
Fax + 41 22 749 09 47  
E-mail [copyright@iso.org](mailto:copyright@iso.org)  
Web [www.iso.org](http://www.iso.org)

Published in Switzerland

## Contents

Page

1	Scope .....	1
2	Normative references .....	1
3	Terms and definitions .....	2
4	Categorization of shipboard signs .....	2
5	Standardized shipboard safety sign and fire control plan signs .....	14

## Foreword

ISO (the International Organization for Standardization) is a worldwide federation of national standards bodies (ISO member bodies). The work of preparing International Standards is normally carried out through ISO technical committees. Each member body interested in a subject for which a technical committee has been established has the right to be represented on that committee. International organizations, governmental and non-governmental, in liaison with ISO, also take part in the work. ISO collaborates closely with the International Electrotechnical Commission (IEC) on all matters of electrotechnical standardization.

The procedures used to develop this document and those intended for its further maintenance are described in the ISO/IEC Directives, Part 1. In particular the different approval criteria needed for the different types of ISO documents should be noted. This document was drafted in accordance with the editorial rules of the ISO/IEC Directives, Part 2 (see [www.iso.org/directives](http://www.iso.org/directives)).

Attention is drawn to the possibility that some of the elements of this document may be the subject of patent rights. ISO shall not be held responsible for identifying any or all such patent rights. Details of any patent rights identified during the development of the document will be in the Introduction and/or on the ISO list of patent declarations received (see [www.iso.org/patents](http://www.iso.org/patents)).

Any trade name used in this document is information given for the convenience of users and does not constitute an endorsement.

For an explanation on the meaning of ISO specific terms and expressions related to conformity assessment, as well as information about ISO's adherence to the WTO principles in the Technical Barriers to Trade (TBT) see the following URL: [Foreword - Supplementary information](#)

The committee responsible for this document is ISO/TC 8, *Ships and marine technology*, Subcommittee SC 1, *Lifesaving and fire protection*.

ISO 24409 consists of the following parts, under the general title *Ships and marine technology — Design, location and use of shipboard safety signs, safety-related signs, safety notices and safety markings*:

- *Part 1: Design principles*
- *Part 2: Catalogue*
- *Part 3: Code of practice*

## Introduction

The growth of international travel by ship has created a need to provide people travelling and working on-board ships with signs and associated systems that communicate consistent and effective safety information. This part of ISO 24409 specifies a system of safety and safety-related signs on ships and other marine installations that is generally consistent with standardized signs with which many will have gained familiarity in other applications.

As such, this part of ISO 24409 clarifies and supplements existing requirements set out in SOLAS regulations II-2/13.3.2.5.1, III/9.2.3, III/11.5, III/20.10, and ISO 17631. However, it is directly applicable to shipboard safety and safety-related signs only, and does not deal with graphical symbols to be used on shipboard plans or documentation.

This part of ISO 24409 contains a catalogue of signs developed in accordance with the general design principles specified in Part 1, for application on ships in accordance with the code of practice in Part 3.





# Ships and marine technology — Design, location and use of shipboard safety signs, safety-related signs, safety notices and safety markings — Part 2: Catalogue

**IMPORTANT** — The colours represented in the electronic file of this part of ISO 24409 can be neither viewed on screen nor printed as true representations. Although the copies of this part of ISO 24409 printed by ISO have been produced to correspond (with an acceptable tolerance as judged by the naked eye) to the requirements of ISO 3864-4, it is not intended that these printed copies be used for colour matching. Instead consult ISO 3864-4 which provides colorimetric and photometric properties together with, as a guideline, references from colour order systems.

For a definitive version of all ISO symbols for use in application of this part of ISO 24409, please consult the ISO Online Browsing Platform (<http://www.iso.org/obp/ui/>).

## 1 Scope

This part of ISO 24409 prescribes standardized signs and safety notices specifically for use on board ships. Each sign is categorized and indexed according to the safety message that is to be conveyed. Each sign is provided with relevant information on the preferred format of use, the context in which it is used and displayed as well as a description of the intended audience. The shape and colour required to be used for each sign, as prescribed by ISO 3864-4, are given together with the graphical symbols contained within each sign. This part of ISO 24409 specifies the sign originals that may be scaled for reproduction and application purposes. It includes signs which require supplementary text signs to be used in conjunction with them to improve comprehension. This catalogue is intended to be under continual revision as new shipboard signs and notices are added and as new requirements are identified and corresponding safety signs and notices are developed and standardised. Where an ISO 7010 reference number is given in this part of ISO 24409 it means that the sign is identical to the one in ISO 7010.

## 2 Normative references

The following documents, in whole or in part, are normatively referenced in this document and are indispensable for its application. For dated references, only the edition cited applies. For undated references, the latest edition of the referenced document (including any amendments) applies.

ISO 3864 (all parts), *Graphical symbols — Safety colours and safety signs*

ISO 7010, *Graphical symbols — Safety colours and safety signs — Registered safety signs*

ISO 17631, *Ships and marine technology — Shipboard plans for fire protection, life-saving appliances and means of escape*

ISO 17724, *Graphical symbols — Vocabulary*

ISO 24409-1, *Ships and marine technology — Design, location, and use of shipboard safety signs — Part 1: Design principles*

### 3 Terms and definitions

For the purposes of this document, the terms and definitions given in ISO 17724, ISO 24409-1, and the following apply.

#### 3.1

##### **fire control plan signs**

signs used to identify and locate equipment shown on the fire control plan

Note 1 to entry: These signs are related to the symbols in ISO 17631; see 4.1 h) below.

#### 3.2

##### **image content**

written description of the elements of a graphical symbol or safety sign and their relative disposition

#### 3.3

##### **referent**

idea or object that a graphical symbol is intended to represent

#### 3.4

##### **safety sign original**

safety sign with which a referent, a graphical representation and a description of the application are associated

### 4 Categorization of shipboard signs

4.1 Shipboard signs are categorized according to their function as follows.

- a) **MES** is the category for means of escape signs which provide escape route identification.
- b) **EES** is the category for emergency equipment signs which provide use and location of first aid facilities and portable safety equipment.
- c) **LSS** is the category for life saving systems and appliances signs which provide use and location of life saving systems and appliances.
- d) **FES** is the category for fire-fighting equipment signs which provide use and location of fire-fighting equipment.
- e) **PSS** is the category for prohibition signs which provide prohibited actions.
- f) **WSS** is the category for hazard warning signs which provide identification of hazards to avoid.
- g) **MSS** is the category for mandatory action signs which provide mandatory notices and instructions.

NOTE The PSS, WSS and MSS categories are the same, respectively, as the P, W and M categories of ISO 7010.















- h) **SIS** is the category for safety and operating instructions for trained personnel. Most of these signs are taken from IMO Resolution A.952(23) for fire control symbols and ISO 17631.









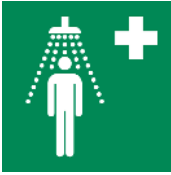












However, the following list shows symbols from A.952(23) that have been replaced by the use of safety signs meeting ISO 3864-1 and are part of the FES category:

- 1) FES012 remote release station replaces 2.13.
  - 2) FES009 Fixed fire extinguishing installation replaces 2.20.
  - 3) FES005 Fixed fire extinguishing battery replaces 2.21.
  - 4) FES010 Fixed fire extinguishing bottle replaces 2.22.
  - 5) FES013 Fire monitor replaces 2.26.
  - 6) FES002 Fire hose reel replaces 2.27.
  - 7) FES001 Fire extinguisher replaces 2.28.
  - 8) FES006 Wheeled fire extinguisher replaces 2.29.
  - 9) FES007 Portable foam replaces 2.30.
  - 10) FES003 Collection of fire fighting equipment replaces 2.31.
  - 11) FES008 Water fog applicator replaces 2.33.
  - 12) FES011 Push button for general alarm replaces 2.39.
  - 13) FES004 Fire alarm call point replaces 2.40.
- i) SMS is the category for mimic signs. Refer to SOLAS regulation II-2/13.7.2.2, and the cabin instructions referred to in SOLAS regulation III/8.4 and IMO Resolution A.752(18).

















**4.2** Table 1 summarizes the standardized safety signs, with the exception of SIS and mimic signs, used in workplaces and public areas in terms of functional category, referent number, referent, graphical symbol as well as geometric shape and colour in accordance with the design principles in ISO 24409-1.

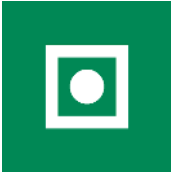



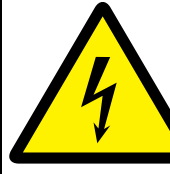





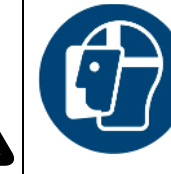




Table 1 — Summary of safety signs for shipboard use

CATEGORY						
MES	EES	LSS	FES	PSS	WSS	MSS
Means of Escape Signs	Emergency Equipment Signs	Lifesaving Signs	Fire-fighting Equipment Signs	Prohibition Signs	Warning Signs	Mandatory Signs
						
MES001 (ISO 7010-E032) Assembly station	EES001 (ISO 7010-E003) First Aid	LSS001 (ISO 7010-E036) Lifeboat	FES001 (ISO 7010-F001) Fire extinguisher	PSS001 (ISO 7010-P001) General prohibition	WSS001 (ISO 7010-W001) General warning	MSS001 (ISO 7010-M001) General Mandatory action
						
MES002 (ISO 7010-E001) Emergency exit (left hand)	EES002 (ISO 7010-E004) Emergency telephone	LSS002 (ISO 7010-E037) Rescue boat	FES002 (ISO 7010-F002) Fire hose reel	PSS002 (ISO 7010-P002) No smoking	WSS002 (ISO 7010-W002) Warning; Explosive material	MSS002 (ISO 7010-M002) Refer to instruction manual or booklet













CATEGORY						
MES	EES	LSS	FES	PSS	WSS	MSS
 <p>MES003 (ISO 7010-E002) Emergency exit (right hand)</p>	 <p>EES003 (ISO 7010-E011) Eye wash station</p>	 <p>LSS003 (ISO 7010-E038) Liferaft</p>	 <p>FES003 (ISO 7010-F004) Collection of fire fighting equipment</p>	 <p>PSS003 (ISO 7010-P003) No open flame; fire, open ignition source and smoking prohibited</p>	 <p>WSS003 (ISO 7010-W003) Warning; Radioactive material or ionizing radiation</p>	 <p>MSS003 (ISO 7010-M003) Wear ear protection</p>
 <p>MES004 (ISO 7010-E033) Door slides right to open</p>	 <p>EES004 (ISO 7010-E012) Emergency shower</p>	 <p>LSS004 (ISO 7010-E039) Davit-launched liferaft</p>	 <p>FES004 (ISO 7010-F005) Fire alarm call point</p>	 <p>PSS004 (ISO 7010-P004) No thoroughfare</p>	 <p>WSS004 (ISO 7010-W004) Warning; Laser beam</p>	 <p>MSS004 (ISO 7010-M004) Wear eye protection</p>
 <p>MES005 (ISO 7010-E034) Door slides left to open</p>	 <p>EES005 (ISO 7010-E013) Stretcher</p>	 <p>LSS005 (ISO 7010-E040) Lifebuoy</p>	 <p>FES005 (ISO 7010-F008) Fixed fire extinguishing battery</p>	 <p>PSS005 (ISO 7010-P005) Not drinking water</p>	 <p>WSS005 (ISO 7010-W005) Warning; Non-ionizing radiation</p>	 <p>MSS005 (ISO 7010-M005) Connect an earth terminal to the ground</p>





CATEGORY						
MES	EES	LSS	FES	PSS	WSS	MSS
 <p>MES 006            (ISO 7010-E018)            Turn anti-clockwise to open</p>	 <p>EES006            (ISO 7010-E027)            Medical grab bag</p>	 <p>LSS006            (ISO 7010-E041)            Lifebuoy with line</p>	 <p>FES006            (ISO 7010-F009)            Wheeled fire extinguisher</p>	 <p>PSS006            (ISO 7010-P006)            No access for fork lift trucks and other industrial vehicles</p>	 <p>WSS006            (ISO 7010-W006)            Warning; Magnetic field</p>	 <p>MSS006            (ISO 7010-M006)            Disconnect mains plug from electrical outlet</p>
 <p>MES007            (ISO 7010-E019)            Turn clockwise to open</p>	 <p>EES007            (ISO 7010-E028)            Oxygen resuscitator</p>	 <p>LSS007            (ISO 7010-E042)            Lifebuoy with light</p>	 <p>FES007            (ISO 7010-F010)            Portable foam</p>	 <p>PSS007            (ISO 7010-P007)            No access for people with active implanted cardiac devices</p>	 <p>WSS007            (ISO 7010-W007)            Warning; Floor level obstacle</p>	 <p>MSS007            (ISO 7010-M007)            Wear opaque eye protection</p>
 <p>MES008            (ISO 7010-E057)            Door opens by pulling on left-hand side</p>	 <p>EES008            (ISO 7010-E029)            EEBD</p>	 <p>LSS008            (ISO 7010-E043)            Lifebuoy with line &amp; light</p>	 <p>FES008            (ISO 7010-F011)            Water fog applicator</p>	 <p>PSS008            (ISO 7010-P008)            No metallic articles or watches</p>	 <p>WSS008            (ISO 7010-W008)            Warning; Drop (fall)</p>	 <p>MSS008            (ISO 7010-M008)            Wear safety footwear</p>









CATEGORY						
MES	EES	LSS	FES	PSS	WSS	MSS
 <p>MES009 (ISO 7010-E058) Door opens by pulling on right-hand side</p>	 <p>EES009 (ISO 7010-E009) Doctor</p>	 <p>LSS Lifebuoy with light and smoke</p>	 <p>FES009 (ISO 7010-F012) Fixed fire extinguishing installation</p>	 <p>PSS009 (ISO 7010-P010) Do not touch</p>	 <p>WSS009 (ISO 7010-W009) Warning; Biological hazard</p>	 <p>MSS009 (ISO 7010-M009) Wear protective gloves</p>
 <p>MES 010 (ISO 7010-E023) Push door on right-hand side to open</p>	 <p>EES010 (ISO 7010-E010) Automated external heart defibrillator</p>	 <p>LSS009 (ISO 7010-E044) Lifejacket</p>	 <p>FES010 (ISO 7010-F013) Fixed fire extinguishing bottle</p>	 <p>PSS010 (ISO 7010-P011) Do not extinguish with water</p>	 <p>WSS010 (ISO 7010-W010) Warning; Low temperature or freezing conditions</p>	 <p>MSS010 (ISO 7010-M010) Wear protective clothing</p>
	 <p>EES011 Safety Equipment</p>	 <p>LSS010 (ISO 7010-E045) Child's lifejacket</p>	 <p>FES011 (ISO 7010-F014) Remote release station</p>	 <p>PSS011 (ISO 7010-P013) No activated mobile phones</p>	 <p>WSS011 (ISO 7010-W011) Warning; Slippery surface</p>	 <p>MSS011 (ISO 7010-M011) Wash your hands</p>








CATEGORY						
MES	EES	LSS	FES	PSS	WSS	MSS
	 EES012 General Alarm	 LSS011 (ISO 7010-E046) Infant's lifejacket	 FES012 (ISO 7010-F015) Fire monitor	 PSS012 (ISO 7010-P014) No access for persons with metallic implants	 WSS012 (ISO 7010-W012) Warning; Electricity	 MSS012 (ISO 7010-M012) Use handrail
	 EES013 Break glass to obtain access	 LSS012 (ISO 7010-E047) Search and rescue locating device		 PSS013 (ISO 7010-P015) No reaching in	 WSS013 (ISO 7010-W013) Warning; Guard dog	 MSS013 (ISO 7010-M013) Wear faceshield
		 LSS013 (ISO 7010-E048) Survival craft distress signals		 PSS014 (ISO 7010-P017) No pushing	 WSS014 (ISO 7010-W014) Warning; Forklift trucks and other industrial vehicles	 MSS014 (ISO 7010-M014) Wear head protection



CATEGORY						
MES	EES	LSS	FES	PSS	WSS	MSS
		 <p>LSS014 (ISO 7010-E049) Rocket parachute flares</p>		 <p>PSS015 (ISO 7010-P018) No sitting</p>	 <p>WSS015 (ISO 7010-W015) Warning; Overhead load</p>	 <p>MSS015 (ISO 7010-M015) Wear high visibility clothing</p>
		 <p>LSS015 (ISO 7010-E050) Line-throwing appliances</p>		 <p>PSS016 (ISO 7010-P019) No stepping on surface</p>	 <p>WSS016 (ISO 7010-W016) Warning; Toxic material</p>	 <p>MSS016 (ISO 7010-M016) Wear a mask</p>
		 <p>LSS016 (ISO 7010-E051) Two-way VHF radiotelephone apparatus</p>		 <p>PSS017 (ISO 7010-P020) Do not use lift in the event of fire</p>	 <p>WSS017 (ISO 7010-W017) Warning; Hot surface</p>	 <p>MSS017 (ISO 7010-M017) Wear respiratory protection</p>

CATEGORY						
MES	EES	LSS	FES	PSS	WSS	MSS
		 <p>LSS017            (ISO 7010-E052)            Emergency Indicating Radio Beacon (EPIRB)</p>		 <p>PSS018            (ISO 7010-P021)            No dogs</p>	 <p>WSS018            (ISO 7010-W018)            Warning; Automatic start-up</p>	 <p>MSS018            (ISO 7010-M018)            Wear safety harness</p>











		 <p>LSS018            (ISO 7010-E053)            Embarkation ladder or other approved device</p>		 <p>PSS019            (ISO 7010-P022)            No eating or drinking</p>	 <p>WSS019            (ISO 7010-W019)            Warning; Crushing</p>	 <p>MSS019            (ISO 7010-M019)            Wear welding mask</p>
		 <p>LSS019            (ISO 7010-E054)            Marine evacuation system (slide)</p>		 <p>PSS020            (ISO 7010-P023)            Do not obstruct</p>	 <p>WSS020            (ISO 7010-W020)            Warning; Overhead obstacles</p>	 <p>MSS020            (ISO 7010-M022)            Use barrier cream</p>

		 <p>LSS020 (ISO 7010-E055) Marine evacuation system (chute)</p>		 <p>PSS021 (ISO 7010-P024) Do not walk or stand here</p>		 <p>MSS021 (ISO 7010-M023) Use footbridge</p>
		 <p>LSS021 (ISO 7010-E056) Survival clothing</p>			 <p>WSS021 (ISO 7010-W021) Warning; Flammable material</p>	
		 <p>LSS022 (ISO 7010-E0xx) Liferaft Knife</p>			 <p>WSS022 (ISO 7010-W022) Warning; Sharp element</p>	

**4.3** Table 2 summarizes a subset of MSS signs adapted from IMO Assembly Resolution A.760(18) that may be displayed together to form a sequence of critical mandatory actions to safely launch a lifeboat, rescue boat, or liferaft.


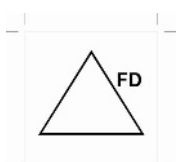
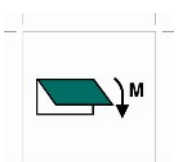
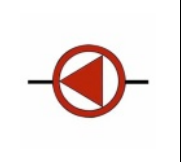
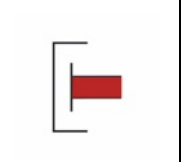



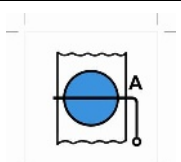
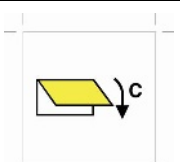
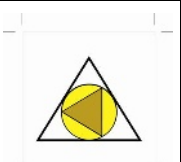
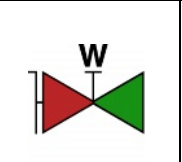
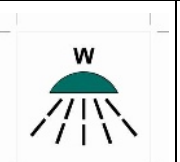
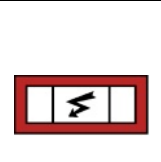
NOTE MSS022 (ISO 7010-M020) replaces the Fasten seat belts sign from Resolution A.760(18).




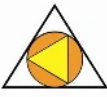

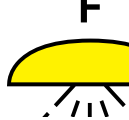

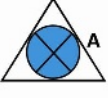


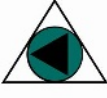

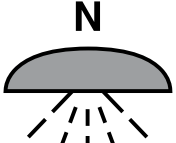


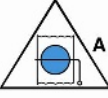
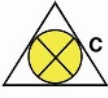

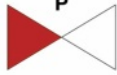
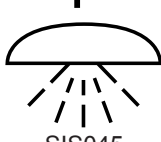
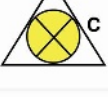

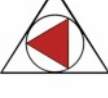


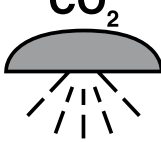
**Table 2 — Summary of related-referent mandatory action signs for launching lifesaving equipment**

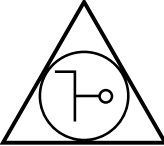
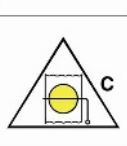
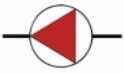
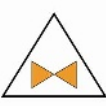

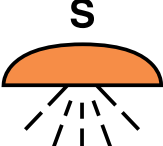

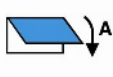


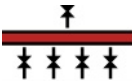

 MSS022 (ISO 7010-M020) Fasten seat belts	 MSS023 (ISO 7010-M037) Close hatches	 MSS024 (ISO 7010-M038) Start engine	 MSS025 (ISO 7010-M039) Lower to the water (lifeboat)	 MSS026 (ISO 7010-M040) Lower to the water (liferaft)
 MSS027 (ISO 7010-M041) Lower to the water (rescue boat)	 MSS028 (ISO 7010-M042) Release falls	 MSS029 (ISO 7010-M043) Start water spray	 MSS030 (ISO 7010-M044) Start air supply	 MSS031 (ISO 7010-M045) Release lifeboat gripes

4.4 Table 3 summarizes the SIS catalogue primarily adapted from IMO Resolution A.952(23) and ISO 17631 with the exception of the SIS signs listed in 4.1.

**Table 3 — Summary of shipboard fire control plan signs (SIS) for shipboard use**

 SIS001 Fire control plan	 SIS009 Remote control for fire doors	 SIS017 Closing device for ventilation inlet or outlet (machinery)	 SIS025 Emergency fire pump	 SIS033 International shore connection	 SIS041 Intert gas installation	 SIS049 Emergency source of electrical power (battery)
 SIS002 Safety plan	 SIS010 Fire damper	 SIS018 Closing device	 SIS026 Fuel pump(s)	 SIS034 Fire hydrant	 SIS042 Space or group	 SIS050

	(accommodation and service spaces)	for ventilation inlet or outlet (cargo spaces)	remote shut-off		of spaces protected by a water fire-extinguishing system	Emergency switchboard
 SIS003 Fire and safety plan	 SIS011 Fire damper (machinery space)	 SIS019 Remote control for closing device for ventilation inlet and outlet (accomm)	 SIS027 Lube oil pump(s) remote shut-off	 SIS035 Main section valve	 SIS043 Space or group of spaces protected by a foam fire-extinguishing system	 SIS051 Air compressor for breathing devices
 SIS004 Ventilation remote control or shut-off (accommodation and service spaces)	 SIS012 Fire damper (cargo space)	 SIS020 Remote control for closing device for ventilation inlet and outlet (machinery)	 SIS028 Remote control for bilge pump(s)	 SIS036 Sprinkler-section valve	 SIS044 Space or group of spaces protected by a gas other than CO2 fire-extinguishing system	 SIS052 Control panel for fire detection and alarm system
 SIS005 Ventilation remote control or shut-off (machinery spaces)	 SIS013 Remote control for fire damper (accommodation or service spaces)	 SIS021 Remote control for closing device for ventilation inlet and outlet (cargo)	 SIS029 Remote control for emergency bilge pump	 SIS037 Powder-section valve	 SIS045 Space or group of spaces protected by a powder fire-extinguishing system	
 SIS006 Ventilation remote control or shut-off (cargo)	 SIS014 Remote control for fire damper (machinery)	 SIS022 Remote control for fire pump	 SIS030 Remote control for fuel oil valves	 SIS038 Foam-section valve	 SIS046 Space or group of spaces protected by a CO2 fire-extinguishing system	

 <p>SIS007 Remote control for skylight</p>	 <p>SIS015 Remote control for fire damper (cargo space)</p>	 <p>SIS023 Fire pump</p>	 <p>SIS031 Remote control for lube oil valves</p>	 <p>SIS039 High expansion foam supply trunk (outlet)</p>	 <p>SIS047 Space or group of spaces protected by a sprinkler or high-pressure water fire- extinguishing system</p>	
 <p>SIS008 Remote control for watertight doors</p>	 <p>SIS016 Closing device for ventilation inlet or outlet (accommodatio n and service spaces)</p>	 <p>SIS024 emergency fire pump Remote control or fire pump supplied by the emergency source of power</p>	 <p>SIS032 Remote control for fire pump valves</p>	 <p>SIS040 Water spray system valves 2.24</p>	 <p>SIS048 Emergency generator</p>	

## 5 Standardized shipboard safety sign and fire control plan signs

**5.1** Tables 4 to 11 give safety sign and fire control plan sign originals in a uniform 70 mm size with corner marks to enable accurate enlargement and reduction scaling. The sign illustrations are shown without borders in order to allow for consistent reproduction scaling, though the use of borders is encouraged as defined by ISO 3864-1. The signs should be reproduced exactly as shown in Tables 4 to 11. However some degree of graphical modification is permitted when cultural differences or special application formats need to be considered, provided the original meaning is retained and comprehension of the safety or safety-related sign is maintained. Consistent reproduction and use of these signs will lead to a progressively improved degree of comprehension at the international level.

**5.2** In cases where the orientation of the graphical symbol is not essential to the meaning of the safety sign, the graphical symbol may be reproduced in a mirrored form. For prohibition signs, it is essential that the prohibition bar does not obscure significant details of the graphical symbol.

**NOTE** The graphical symbol is the complete image containing all the graphical symbol elements as shown in the registered safety sign.

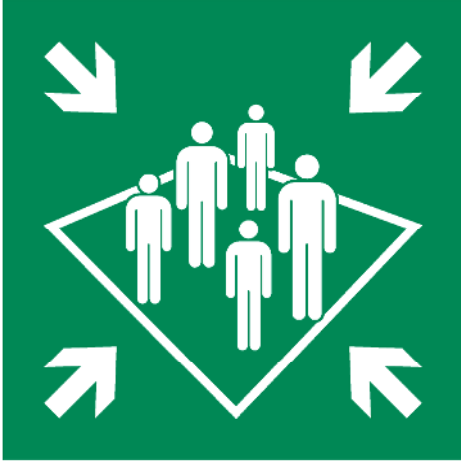

**5.3** Where a graphical symbol is not available to indicate a particular desired meaning, the meaning shall be obtained by using the appropriate general sign together with supplementary safety information.

**5.4** Tables 4 to 11 present the safety sign and fire control plan sign originals according to their category as follows:

- MES - Means of escape see Table 4
- EES - Emergency equipment signs see Table 5
- LSS - Life saving systems and appliances see Table 6

— FES - Fire-fighting equipment see	Table 7
— PSS - Prohibition signs see	Table 8
— WSS - Warning signs see	Table 9
— MSS - Mandatory action signs see	Table 10
— SIS - Fire control plan signs for trained personnel	Table 11

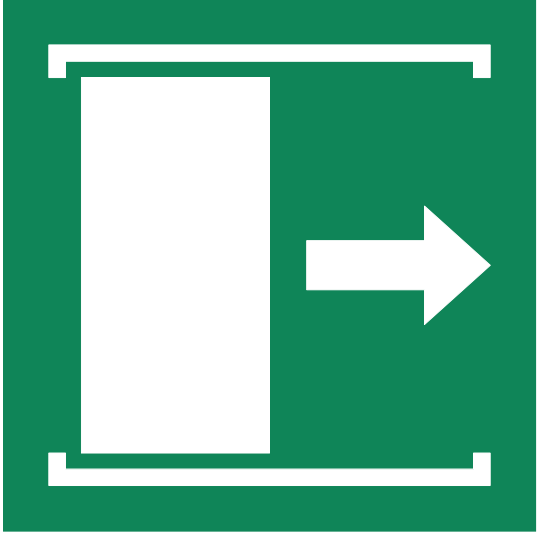
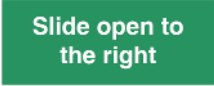

Table 4 — Means of escape signs (MES)

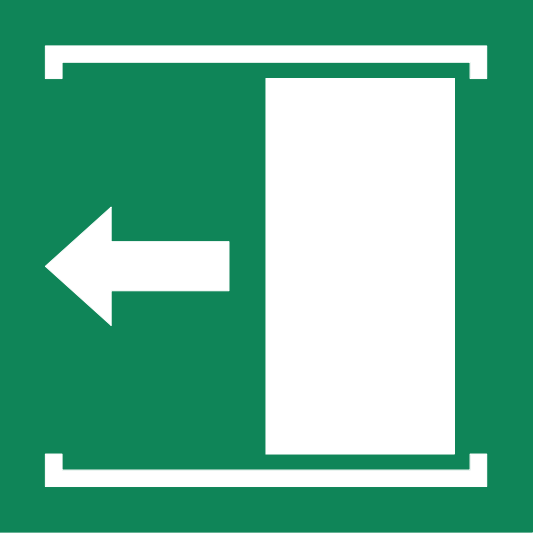
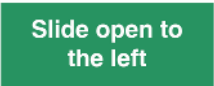

	<b>Reference No.</b> <p style="text-align: center;"><b>MES001 (ISO 7010 E032)</b></p>
	<b>Referent</b> <p style="text-align: center;"><b>Assembly Station</b></p>
	<b>Function</b> <p>To indicate the location of an assembly station on board ship</p>
	<b>Image content</b> <p>Five human figures in different sizes standing on a square, four arrows coming from the corners pointing to them</p>
<b>Hazard</b> <p>Not being able to locate an assembly station on board ship</p>	
<b>Human behaviour that is intended to be caused after understanding the safety sign's meaning:</b> <p>Being aware of the location of an assembly station on board ship</p>	
<b>Related referents</b> <p>ISO 7010-E007</p>	
<b>Additional information.</b> <p>Test data obtained according to ISO 9186-1:2007 are not available. Consequently, a supplementary sign shall be used to increase comprehension except when the safety sign is supplemented by manuals, instructions or training.</p> <p>Supplementary arrow sign (type D of ISO 3864-3) in white on green to be used to give directional information. Management information panel supplementary sign with a reference number or letter may be used to indicate a specific assembly station to aid in distinguishing between multiple assembly stations.</p>	
	






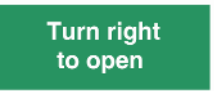
	<b>Reference No.</b> <p style="text-align: center;"><b>MES002 (ISO 7010-E001)</b></p>
	<b>Referent</b> <p style="text-align: center;"><b>Emergency Exit (left hand)</b></p>
	<b>Function</b> To locate means of escape and/or escape routes to a place of safety.
	<b>Image content</b> Human figure moving to left through doorway
<b>Hazard</b> Not being able to locate means of escape and/or escape routes to a place of safety which is provided for evacuation in the event of an emergency	
<b>Human behaviour that is intended to be caused after understanding the safety sign's meaning:</b> Being aware of the location of an escape route to a place of safety in the event of an emergency	
<b>Related referents</b> ISO 7010-E001, ISO 7010-E002, MES003	
<b>Additional information</b> Test data obtained according to ISO 9186-1:2007 are not available. Consequently, a supplementary sign shall be used to increase comprehension except when the safety sign is supplemented by manuals, instructions or training.  Supplementary arrow sign (type D of ISO 3864-3) in white on green to be used to give directional information:	
	



	<b>Reference No.</b> <p style="text-align: center;"><b>MES003 (ISO 7010-E002)</b></p>
	<b>Referent</b> <p style="text-align: center;"><b>Emergency Exit (right hand)</b></p>
	<b>Function</b> To locate means of escape and/or escape routes to a place of safety
	<b>Image content</b> Human figure moving to right through doorway
<b>Hazard</b> Not being able to locate means of escape and/or escape routes to a place of safety which is provided for evacuation in the event of an emergency	
<b>Human behaviour that is intended to be caused after understanding the safety sign's meaning:</b> Being aware of the location of an escape route to a place of safety in the event of an emergency	
<b>Related referents</b> ISO 7010-E001, ISO 7010-E002, MES002	
<b>Additional information</b> Test data obtained according to ISO 9186-1:2007 are not available. Consequently, a supplementary sign shall be used to increase comprehension except when the safety sign is supplemented by manuals, instructions or training.	
Supplementary arrow sign (type D of ISO 3864-3) in white on green to be used to give directional information:	
	



	<b>Reference No.</b> <p style="text-align: center;"><b>MES004 (ISO 7010 E033)</b></p>
	<b>Referent</b> <p style="text-align: center;"><b>Door slides right to open</b></p>
	<b>Function</b> To indicate the direction in which a sliding door opens
	<b>Image content</b> Rectangle bordered top and bottom, arrow pointing to the right
<b>Hazard</b> Not being able to determine the direction of movement of a sliding door	
<b>Human behaviour that is intended to be caused after understanding the safety sign's meaning:</b> Being able to discern a sliding door which opens to the right.	
<b>Related referents</b> ISO 7010-E022, ISO 7010-E023, ISO 7010-E034, ISO 7010-E057, ISO 7010-E058	
<b>Additional information</b> Test data obtained according to ISO 9186-1:2007 are not available. Consequently, a supplementary sign shall be used to increase comprehension except when the safety sign is supplemented by manuals, instructions or training.	
	

	<b>Reference No.</b> <p style="text-align: center;"><b>MES005 (ISO 7010-E034)</b></p>
	<b>Referent</b> <p style="text-align: center;"><b>Door slides left to open</b></p>
	<b>Function</b> To indicate the direction in which a sliding door will open.
	<b>Image content</b> White rectangle bordered top and bottom with arrow pointing to left
<b>Hazard</b> Not being able to determine the direction of travel of a sliding door in order to open it	
<b>Human behaviour that is intended to be caused after understanding the safety sign's meaning:</b> Being able to discern a sliding door which opens to the left.	
<b>Related referents</b> MES004, ISO 7010-W019	
<b>Additional information</b> Test data obtained according to ISO 9186-1:2007 are not available. Consequently, a supplementary sign shall be used to increase comprehension except when the safety sign is supplemented by manuals, instructions or training.	
	

	<b>Reference No.</b> <p style="text-align: center;"><b>MES006 (ISO 7010-E018)</b></p>
	<b>Referent</b> <p style="text-align: center;"><b>Turn anticlockwise to open</b></p>
	<b>Function</b> To indicate that a counter clockwise rotation is needed to turn a knob to open a door.
	<b>Image content</b> Knob and portion of a door in perspective with arrow curving counter clockwise
<b>Hazard</b> Not being able to determine the correct rotation to turn a knob in order to open a door	
<b>Human behaviour that is intended to be caused after understanding the safety sign's meaning:</b> Being able to discern that counter clockwise is the correct way to turn a knob to open a door.	
<b>Related referents</b> ISO 7010 E018, ISO 7010 E019, MES007	
<b>Additional information</b> Test data obtained according to ISO 9186-1:2007 are not available. Consequently, a supplementary sign shall be used to increase comprehension except when the safety sign is supplemented by manuals, instructions or training.	
	

	<b>Reference No.</b> <p style="text-align: center;"><b>MES007 (ISO 7010 E019)</b></p>
	<b>Referent</b> <p style="text-align: center;"><b>Turn clockwise to open</b></p>
	<b>Function</b> To indicate that a clockwise rotation is needed to turn a knob to open a door.
	<b>Image content</b> Knob and portion of a door in perspective with arrow curving clockwise
<b>Hazard</b> Not being able to determine the correct rotation to turn a knob in order to open a door [especially in the event of an emergency]	
<b>Human behaviour that is intended to be caused after understanding the safety sign's meaning:</b> Being able to discern that clockwise is the correct way to turn a knob to open a door.	
<b>Related referents</b> ISO 7010 E018, ISO 7010 E019, MES006	
<b>Additional information</b> Test data obtained according to ISO 9186-1:2007 are not available. Consequently, a supplementary sign shall be used to increase comprehension except when the safety sign is supplemented by manuals, instructions or training.	
	

	<b>Reference No.</b> <p style="text-align: center;"><b>MES008 (ISO 7010 E057)</b></p>
	<b>Referent</b> <p style="text-align: center;"><b>Door opens by pulling on left-hand side</b></p>
	<b>Function</b> To indicate that the door opens by pulling on the left-hand side.
	<b>Image content</b> Doorway with door opening inwards, curved arrow pointing to right
<b>Hazard</b> Not being able to determine that a door handle must be pulled on left-hand side in order to open a door	
<b>Human behaviour that is intended to be caused after understanding the safety sign's meaning:</b> Being aware that pulling on the left-hand side is the correct way to open a door.	
<b>Related referents</b> MES009	
<b>Additional information</b> Test data obtained according to ISO 9186-1:2007 are not available. Consequently, a supplementary sign shall be used to increase comprehension except when the safety sign is supplemented by manuals, instructions or training.	
	

	<b>Reference No.</b> <p style="text-align: center;"><b>MES009 (ISO 7010 E058)</b></p>
	<b>Referent</b> <p style="text-align: center;"><b>Door opens by pulling on right-hand side</b></p>
	<b>Function</b> To indicate that the door opens by pulling on the right-hand side.
	<b>Image content</b> Doorway with door opening inwards, curved arrow pointing to left
<b>Hazard</b> Not being able to determine that a door handle must be pulled on right-hand side in order to open a door	
<b>Human behaviour that is intended to be caused after understanding the safety sign's meaning:</b> Being aware that pulling on the right-hand side is the correct way to open a door.	
<b>Related referents</b> MES008	
<b>Additional information</b> Test data obtained according to ISO 9186-1:2007 are not available. Consequently, a supplementary sign shall be used to increase comprehension except when the safety sign is supplemented by manuals, instructions or training.	
	







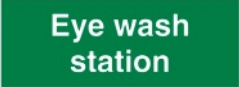
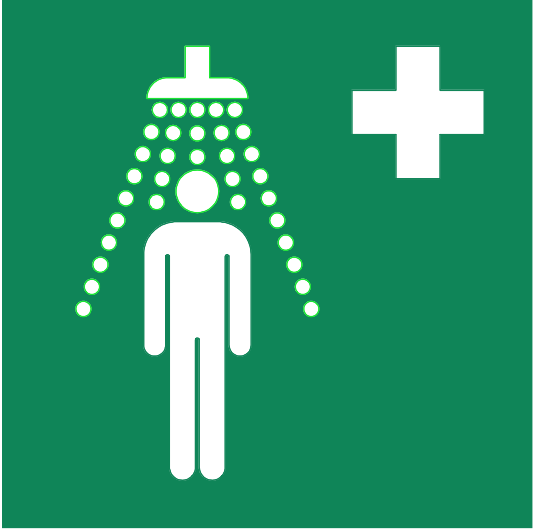

	<b>Reference No.</b> <p style="text-align: center;"><b>MES009</b></p>
	<b>Referent</b> <p style="text-align: center;"><b>Push</b></p>
	<b>Function</b> To indicate that a pushing force is needed [to open a door].
	<b>Image content</b> A white arrow in perspective pointing in and to the right
<b>Hazard</b> Not being able to determine that a door handle must be pushed in order to open a door	
<b>Human behaviour that is intended to be caused after understanding the safety sign's meaning:</b> Being able to discern that pushing is the correct way to open a door.	
<b>Related referents</b> MES008	
<b>Additional information</b> Test data obtained according to ISO 9186-1:2007 are not available. Consequently, a supplementary sign shall be used to increase comprehension except when the safety sign is supplemented by manuals, instructions or training.	
	

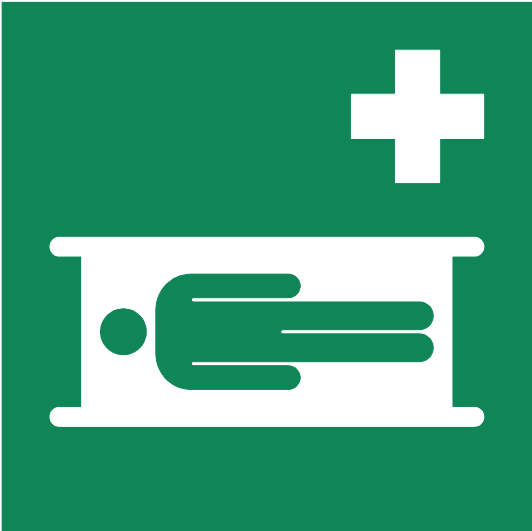
Table 5 — Emergency equipment signs (EES)


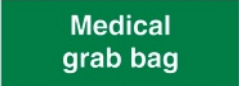
	<b>Reference No.</b> <p style="text-align: center;"><b>EES001 (ISO 7010-E003)</b></p>
	<b>Referent</b> <p style="text-align: center;"><b>First aid</b></p>
	<b>Function</b> To indicate the location of first aid equipment or facilities or staff.
	<b>Image content</b> First aid cross
<p><b>Hazard</b>          Not being able to locate first aid equipment or facilities or staff in the event of injury or emergency</p> <p><b>Human behaviour that is intended to be caused after understanding the safety sign's meaning</b>          Being aware of the location of first aid equipment or facilities or staff.</p> <p><b>Related referents</b>          ISO 7010-E003, ISO 7010-E004, ISO 7010-E009, ISO 7010-E010, ISO 7010-E011, ISO 7010-E012, ISO 7010-E013</p> <p><b>Additional information</b>          The first aid cross may be replaced with another element appropriate to cultural requirements.          Test data obtained according to ISO 9186-1:2007 are not available. Consequently, a supplementary text sign shall be used to increase comprehension except when the safety sign is supplemented by manuals, instructions or training.</p> <div style="border: 1px solid black; padding: 5px; width: fit-content; margin-top: 10px;"> <p style="text-align: center; background-color: green; color: white; margin: 0;"><b>First aid</b></p> </div>	


	<b>Reference No.</b> <p style="text-align: center;"><b>EES002 (ISO 7010-E004)</b></p>
	<b>Referent</b> <p style="text-align: center;"><b>Emergency telephone</b></p>
	<b>Function</b> To indicate the location of an emergency telephone.
	<b>Image content</b> Telephone receiver (profile), first aid cross
<b>Hazard</b> Not being able to locate a telephone which is provided for use in the event of an emergency	
<b>Human behaviour that is intended to be caused after understanding the safety sign's meaning</b> Being aware of the location of an emergency telephone	
<b>Related referents</b> ISO 7010-E003, ISO 7010-E004, ISO 7010-E009, ISO 7010-E010, ISO 7010-E011, ISO 7010-E012, ISO 7010-E013, ISO 7010-F006	
<b>Additional information</b> The first aid cross may be replaced with another element appropriate to cultural requirements. Test data obtained according to ISO 9186-1:2007 are not available. Consequently, a supplementary text sign shall be used to increase comprehension except when the safety sign is supplemented by manuals, instructions or training.	
	

	<b>Reference No.</b> <p style="text-align: center;"><b>EES003 (ISO 7010-E011)</b></p>
	<b>Referent</b> <p style="text-align: center;"><b>Eye wash station</b></p>
	<b>Function</b> To indicate the location of an eyewash station.
	<b>Image content</b> Eye above running water coming out of a shower head, first aid cross
<b>Hazard</b> <p>Not being able to locate an eyewash station which is provided to assist in the clearance of eye contamination from substances which can lead to eye damage and loss of sight, if not cleared sufficiently quickly</p>	
<b>Human behaviour that is intended to be caused after understanding the safety sign's meaning</b> <p>Being aware of the location of an eyewash station</p>	
<b>Related referents</b> <p>ISO 7010-E003, ISO 7010-E011, ISO 7010-E012</p>	
<b>Additional information</b> <p>The first aid cross may be replaced with another element appropriate to cultural requirements of the target group. Test data obtained according to ISO 9186-1:2007 are not available. Consequently, a supplementary text sign shall be used to increase comprehension except when the safety sign is supplemented by manuals, instructions or training.</p>	
	


	<b>Reference No.</b> <p style="text-align: center;"><b>EES004 (ISO 7010-E012)</b></p>
	<b>Referent</b> <p style="text-align: center;"><b>Safety shower</b></p>
	<b>Function</b> To indicate the location of a safety shower.
	<b>Image content</b> Human figure under running water coming out of a shower head, first aid cross
<b>Hazard</b> <p>Not being able to locate a safety shower which is provided to assist in the clearance of contamination from substances which can lead to death, injury or illness, if not cleared sufficiently quickly</p>	
<b>Human behaviour that is intended to be caused after understanding the safety sign's meaning</b> <p>Being aware of the location of a safety shower</p>	
<b>Related referents</b> <p>ISO 7010-E003, ISO 7010-E011, ISO 7010-E012</p>	
<b>Additional information</b> <p>The first aid cross may be replaced with another element appropriate to cultural requirements of the target group.</p> <p>Test data obtained according to ISO 9186-1:2007 are not available. Consequently, a supplementary text sign shall be used to increase comprehension except when the safety sign is supplemented by manuals, instructions or training.</p>	
	



	<b>Reference No.</b> <p style="text-align: center;"><b>EES005 (ISO 7010-E013)</b></p>
	<b>Referent</b> <p style="text-align: center;"><b>Stretcher</b></p>
	<b>Function</b> To indicate the location of a stretcher.
	<b>Image content</b> Human figure outlined on a white stretcher, first aid cross
<b>Hazard</b> <p>Not being able to locate a stretcher which is provided to assist in the transport of people with injury or illness to a place where medical care will be available</p>	
<b>Human behaviour that is intended to be caused after understanding the safety sign's meaning</b> <p>Being aware of the location of a stretcher</p>	
<b>Related referents</b> <p>ISO 7010-E003, ISO 7010-E013</p>	
<b>Additional information</b> <p>The first aid cross may be replaced with another element appropriate to cultural requirements of the target group. Test data obtained according to ISO 9186-1:2007 are not available. Consequently, a supplementary text sign shall be used to increase comprehension except when the safety sign is supplemented by manuals, instructions or training.</p>	
<div style="background-color: green; color: white; padding: 5px; display: inline-block;"><b>Stretcher</b></div>	


	<b>Reference No.</b> <p style="text-align: center;"><b>EES006 (ISO 7010 E027)</b></p>
	<b>Referent</b> <p style="text-align: center;"><b>Medical grab bag</b></p>
	<b>Function</b> <p>To indicate the location of a medical grab bag.</p>
	<b>Image content</b> <p>Bag (outlined) with handles, first aid cross</p>
<b>Hazard</b> <p>Not being able to locate a medical grab bag.</p>	
<b>Human behaviour that is intended to be caused after understanding the safety sign's meaning</b> <p>Being aware of the location of a medical grab bag.</p>	
<b>Related referents</b> <p>ISO 7010-E003, ISO 7010-E004, ISO 7010-E009, ISO 7010-E010, ISO 7010-E011, ISO 7010-E012, ISO 7010-E013, ISO 7010-E028, ISO 7010-E029</p>	
<b>Additional information</b> <p>The first aid cross may be replaced with another element appropriate to cultural requirements of the target group. Test data obtained according to ISO 9186-1:2007 are not available. Consequently, a supplementary text sign shall be used to increase comprehension except when the safety sign is supplemented by manuals, instructions or training.</p>	
	



	<b>Reference No.</b> <p style="text-align: center;"><b>EES007 (ISO 7010 E028)</b></p>
	<b>Referent</b> <p style="text-align: center;"><b>Oxygen resuscitator</b></p>
	<b>Function</b> <p>To indicate the location of an oxygen resuscitator.</p>
	<b>Image content</b> <p>Oxygen cylinder with manual control, hose line and mask, first aid cross.</p>
<p><b>Hazard</b></p> <p>Not being able to locate an oxygen resuscitator</p> <p><b>Human behaviour that is intended to be caused after understanding the safety sign's meaning</b></p> <p>Being aware of the location of a oxygen resuscitator</p> <p><b>Related referents</b></p> <p>ISO 7010-E003, ISO 7010-E004, ISO 7010-E009, ISO 7010-E010, ISO 7010-E011, ISO 7010-E012, ISO 7010-E013, ISO 7010-E027, ISO 7010-E029</p> <p><b>Additional information</b></p> <p>The first aid cross may be replaced with another element appropriate to cultural requirements of the target group. Test data obtained according to ISO 9186-1:2007 are not available. Consequently, a supplementary text sign shall be used to increase comprehension except when the safety sign is supplemented by manuals, instructions or training.</p> <div style="border: 1px solid black; background-color: #008000; color: white; padding: 5px; display: inline-block; margin-top: 10px;">       Oxygen resuscitator     </div>	



	<b>Reference No.</b>  <b>EES008 (ISO 7010 E029)</b>
	<b>Referent</b>  <b>Emergency escape breathing device</b>
	<b>Function</b>  To indicate the location of an emergency escape breathing device (EEBD)
	<b>Image content</b>  Full-face mask with regulator (front view), first aid cross
<p><b>Hazard</b></p> <p>Not being able to locate an EEBD</p> <p><b>Human behaviour that is intended to be caused after understanding the safety sign's meaning</b></p> <p>Being aware of the location of an EEBD</p> <p><b>Related referents</b></p> <p>ISO 7010-E003, ISO 7010-E004, ISO 7010-E009, ISO 7010-E010, ISO 7010-E011, ISO 7010-E012, ISO 7010-E013, ISO 7010-E027, ISO 7010-E028</p> <p><b>Additional information</b></p> <p>The first aid cross may be replaced with another element appropriate to cultural requirements.</p> <p>Test data obtained according to ISO 9186-1:2007 are not available. Consequently, a supplementary text sign shall be used to increase comprehension except when the safety sign is supplemented by manuals, instructions or training.</p> <div style="border: 1px solid black; background-color: #008000; color: white; padding: 5px; width: fit-content; margin-top: 20px;">       Emergency escape breathing device (E.E.B.D.)     </div>	

	<b>Reference No.</b> <p style="text-align: center;"><b>EES009 (ISO 7010-E009)</b></p>
	<b>Referent</b> <p style="text-align: center;"><b>Doctor</b></p>
	<b>Function</b> To indicate the location of a doctor, infirmary, or medical assistance.
	<b>Image content</b> Upper human figure with stethoscope, first aid cross
<b>Hazard</b> <p>Not being able to locate a doctor, infirmary, or similar medical assistance</p>	
<b>Human behaviour that is intended to be caused after understanding the safety sign's meaning</b> <p>Being aware of the location of medical assistance.</p>	
<b>Related referents</b> <p>ISO 7010-E003, ISO 7010-E004, ISO 7010-E010, ISO 7010-E011, ISO 7010-E012, ISO 7010-E013</p>	
<b>Additional information</b> <p>The first aid cross may be replaced with another element appropriate to cultural requirements.</p> <p>Test data obtained according to ISO 9186-1:2007 are not available. Consequently, a supplementary text sign shall be used to increase comprehension except when the safety sign is supplemented by manuals, instructions or training.</p>	
	

	<b>Reference No.</b> <p style="text-align: center;"><b>EES010 (ISO 7010-E010)</b></p>
	<b>Referent</b> <p style="text-align: center;"><b>Automated external heart defibrillator</b></p>
	<b>Function</b> To indicate the location of an automated external heart defibrillator.
	<b>Image content</b> Heart with flash in the middle, first aid cross
<p><b>Hazard</b></p> <p>Not being able to locate an automated external heart defibrillator which is provided to assist in the avoidance of death from a heart attack</p> <p><b>Human behaviour that is intended to be caused after understanding the safety sign's meaning</b></p> <p>Being aware of the location of an automated external heart defibrillator</p> <p><b>Related referents</b></p> <p>ISO 7010-E003, ISO 7010-E010,</p> <p><b>Additional information</b></p> <p>The first aid cross may be replaced with another element appropriate to cultural requirements of the target group. Test data obtained according to ISO 9186-1:2007 are available from more than one country. Findings from testing showed that the graphical symbol did not reach the criteria of acceptability. Consequently, a supplementary text sign shall be used to increase comprehension except when the safety sign is supplemented by manuals, instructions or training.</p> <div style="border: 1px solid black; background-color: #008000; color: white; padding: 5px; width: fit-content; margin-top: 20px;">       Automated external heart defibrillator     </div>	

	<b>Reference No.</b> <b>EES011</b> (This sign was not approved for inclusion in ISO 7010 graphical symbols.)
	<b>Referent</b> <p style="text-align: center;"><b>Safety equipment</b></p>
	<b>Function</b> To indicate the location of safety equipment [or a safety equipment locker].
	<b>Image content</b> White checkmark
<b>Hazard</b>  Not being able to locate shipboard safety equipment [or a safety equipment locker]	
<b>Human behaviour that is intended to be caused after understanding the safety sign's meaning</b>  Crew being aware of the location of shipboard safety equipment	
<b>Related referents</b> EES004, EES005, EES006, EES007, EES009, EES010	
<b>Additional information</b> Test data obtained according to ISO 9186-1:2007 are not available. Consequently, a supplementary text sign shall be used to increase comprehension except when the safety sign is supplemented by manuals, instructions or training.	
	

	<b>Reference No.</b> <p style="text-align: center;"><b>EES012 (ISO 7010 E031)</b></p>
	<b>Referent</b> <p style="text-align: center;"><b>Shipboard general alarm</b></p>
	<b>Function</b> To indicate the location of a general alarm button on board ship.
	<b>Image content</b> Circle in a square (outlined)
<b>Hazard</b> <p>Not being able to locate a general alarm button on board ship</p> <p><b>Human behaviour that is intended to be caused after understanding the safety sign's meaning</b></p> <p>Crew being aware of the location of the general alarm button</p> <p><b>Related referents</b></p> <p>ISO 7010-F005</p> <p><b>Additional information</b></p> <p>Test data obtained according to ISO 9186-1:2007 are not available. Consequently, a supplementary text sign (i.e. "General alarm" or "General alarm call point") shall be used to increase comprehension except when the safety sign is supplemented by manuals, instructions or training.</p> <div style="display: flex; justify-content: space-around; margin-top: 20px;"> <div style="background-color: #008000; color: white; padding: 5px 15px; text-align: center;">General alarm</div> <div style="background-color: #008000; color: white; padding: 5px 15px; text-align: center;">General alarm call point</div> </div>	


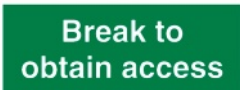
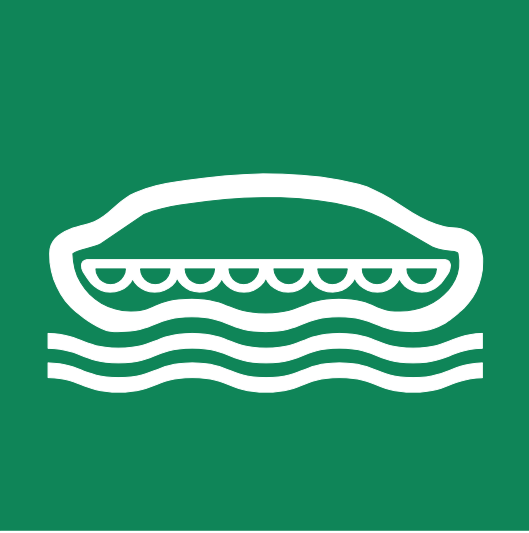
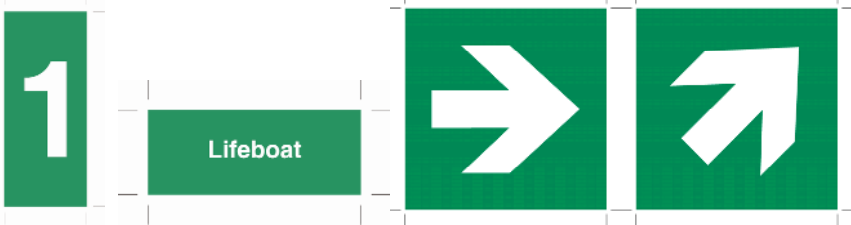

	<b>Reference No.</b> <p style="text-align: center;"><b>EES013 (ISO 7010 E008)</b></p>
	<b>Referent</b> <p style="text-align: center;"><b>Break to obtain access</b></p>
	<b>Function</b> To indicate a cover which requires breaking to obtain access to an emergency exit device. For everyday use in workplaces and public areas
	<b>Image content</b> Human fist and lower arm (outlined) holding a bar, uneven star shape
<b>Hazard</b> <p>Not being able to open an emergency exit device which is provided for evacuation in the event of an emergency</p>	
<b>Human behaviour that is intended to be caused after understanding the safety sign's meaning</b> <p>Breaking the cover to gain access to the device that operates an emergency exit in the event of an emergency</p>	
<b>Related referents</b> <p>---</p>	
<b>Additional information</b> <p>Test data obtained according to ISO 9186-1:2007 are not available from more than one country. Findings from national testing, however, showed that in one country the graphical symbol did not reach the criteria of acceptability. Consequently, a supplementary text sign shall be used to increase comprehension except when the safety sign is supplemented by manuals, instructions or training.</p>	
	

Table 6 — Life saving systems and appliances signs (LSS)

	<b>Reference No.</b> <p style="text-align: center;"><b>LSS001 (ISO 7010 E036)</b></p>
	<b>Referent</b> <p style="text-align: center;"><b>Lifeboat</b></p>
	<b>Function</b> To indicate the location of, or route to, a lifeboat.
	<b>Image content</b> White silhouette lifeboat with eight becketed lifelines atop a wave pattern
<b>Hazard</b> Not being able to locate the lifeboat in the event of an evacuation.	
<b>Human behaviour that is intended to be caused after understanding the safety sign's meaning:</b> Being aware of the location of, or route to, a lifeboat.	
<b>Related referents</b> ---	
<b>Additional information.</b> Test data obtained according to ISO 9186-1:2007 are not available. Consequently, a supplementary sign shall be used to increase comprehension except when the safety sign is supplemented by manuals, instructions or training.	
Supplementary arrow sign (type D of ISO 3864-3) in white on green to be used to give directional information. Management information panel supplementary sign with a reference letter may be used to indicate a specific lifeboat to aid in distinguishing between multiple lifeboats.	
	

	<b>Reference No.</b>
	<b>LSS002 (ISO 7010 E037)</b>
	<b>Referent</b>
	Rescue boat
	<b>Function</b>
	To indicate the location of, or route to, a rescue boat.
	<b>Image content</b>
	Rescue boat with enclosed cabin in profile with human figure pulling another figure from water with wave pattern

**Hazard**

Not being able to locate the rescue boat.

**Human behaviour that is intended to be caused after understanding the safety sign's meaning:**

Being aware of the location of, or route to, a rescue boat.

**Related referents**

---


**Additional information.**

Test data obtained according to ISO 9186-1:2007 are not available. Consequently, a supplementary sign shall be used to increase comprehension except when the safety sign is supplemented by manuals, instructions or training.

Supplementary arrow sign (type D of ISO 3864-3) in white on green to be used to give directional information. Management information panel supplementary sign with a reference number may be used to indicate a specific rescue boat to aid in distinguishing between multiple rescue boats.





	<b>Reference No.</b>
	<b>LSS003 (ISO 7010 E038)</b>
	<b>Referent</b>
	<b>Liferaft</b>
	<b>Function</b>
	To indicate the location of, or route to, a liferaft.
	<b>Image content</b>
	Liferaft over wave pattern

**Hazard**

Not being able to locate a liferaft.

**Human behaviour that is intended to be caused after understanding the safety sign's meaning:**

Being aware of the location of, or route to, a liferaft.

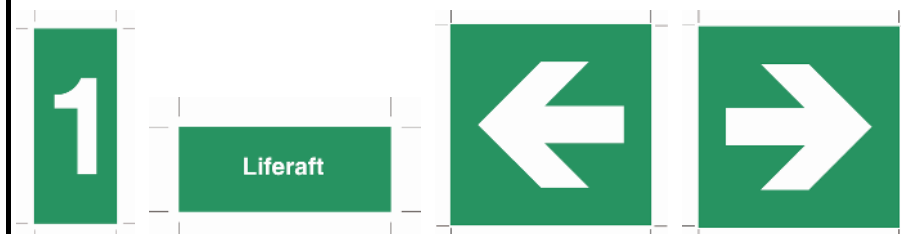
**Related referents**


---

**Additional information.**

Test data obtained according to ISO 9186-1:2007 are not available. Consequently, a supplementary sign shall be used to increase comprehension except when the safety sign is supplemented by manuals, instructions or training.

Supplementary arrow sign (type D of ISO 3864-3) in white on green to be used to give directional information. Management information panel supplementary sign with a reference number or letter may be used to indicate a specific liferaft to aid in distinguishing between multiple liferafts..



	<b>Reference No.</b>
	<b>LSS004 (ISO 7010 E039)</b>
	<b>Referent</b>
	<b>Davit-launched-liferaft</b>
	<b>Function</b>
	To indicate the location of, or route to, a davit launched liferaft.
	<b>Image content</b>
	Liferaft suspended from single point davit

**Hazard**

Not being able to locate a davit-launched liferaft.

**Human behaviour that is intended to be caused after understanding the safety sign's meaning:**

Being aware of the location of, or route to, a davit-launched liferaft.

**Related referents**


---

**Additional information.**

Test data obtained according to ISO 9186-1:2007 are not available. Consequently, a supplementary sign shall be used to increase comprehension except when the safety sign is supplemented by manuals, instructions or training.

Supplementary arrow sign (type D of ISO 3864-3) in white on green to be used to give directional information. Management information panel supplementary sign with a reference number or letter may be used to indicate a specific davit-launched liferaft to aid in distinguishing between multiple liferafts.



	<b>Reference No.</b> <p style="text-align: center;"><b>LSS005 (ISO 7010 E040)</b></p>
	<b>Referent</b> <p style="text-align: center;"><b>Lifebuoy</b></p>
	<b>Function</b> To indicate the location of a lifebuoy.
	<b>Image content</b> Ring buoy with four becketed lines

**Hazard**

Not being able to locate a lifebuoy in time to launch it, especially in man overboard situations.

**Human behaviour that is intended to be caused after understanding the safety sign's meaning:**

Being aware of the location of a lifebuoy.


**Related referents**



ISO 20712-1 WSE001,


**Additional information.**

Test data obtained according to ISO 9186-1:2007 are not available. Consequently, a supplementary sign shall be used to increase comprehension except when the safety sign is supplemented by manuals, instructions or training.

Management information panel supplementary sign to be used to reference a specific lifebuoy.

	
---	---

	<b>Reference No.</b> <p style="text-align: center;"><b>LSS006 (ISO 7010 E041)</b></p>
	<b>Referent</b> <p style="text-align: center;"><b>Lifebuoy with line</b></p>
	<b>Function</b> To indicate the location of a lifebuoy with heaving line.
	<b>Image content</b> Ring buoy with four becketed lines and attached segmented line
<b>Hazard</b> Not being able to locate a lifebuoy with heaving line in time to launch it, especially in man overboard situations.	
<b>Human behaviour that is intended to be caused after understanding the safety sign's meaning:</b> Being aware of the location of a lifebuoy with heaving line.	
<b>Related referents</b> ISO 20712-1 WSE001,	
<b>Additional information.</b> Test data obtained according to ISO 9186-1:2007 are not available. Consequently, a supplementary sign shall be used to increase comprehension except when the safety sign is supplemented by manuals, instructions or training.	
Management information panel supplementary sign to be used to reference a specific lifebuoy.	
	

	<b>Reference No.</b>
	<b>LSS007 (ISO 7010 E042)</b>
	<b>Referent</b>
	<b>Lifebuoy with light</b>
	<b>Function</b>
	To indicate the location of a lifebuoy with water light.
	<b>Image content</b>
	Ring buoy with four becketed lines and attached light

**Hazard**

Not being able to locate a lifebuoy with an attached water light in time to launch it, especially in man overboard situations in reduced visibility or night time.

**Human behaviour that is intended to be caused after understanding the safety sign's meaning:**

Being aware of the location of a lifebuoy with light.

**Related referents**



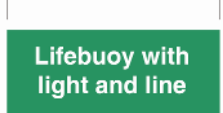
ISO 20712-1 WSE001,



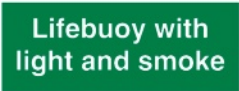
**Additional information.**



Test data obtained according to ISO 9186-1:2007 are not available. Consequently, a supplementary sign shall be used to increase comprehension except when the safety sign is supplemented by manuals, instructions or training.

Management information panel supplementary sign to be used to reference a specific lifebuoy.







	<b>Reference No.</b> <p style="text-align: center;"><b>LSS008 (ISO 7010 E043)</b></p>
	<b>Referent</b> <p style="text-align: center;"><b>Lifebuoy with line &amp; light</b></p>
	<b>Function</b> To indicate the location of a lifebuoy with heaving line and light.
	<b>Image content</b> Ring buoy with four becketed lines and attached line and light
<b>Hazard</b> Not being able to locate a lifebuoy with attached light and heaving line.	
<b>Human behaviour that is intended to be caused after understanding the safety sign's meaning:</b> Being aware of the location of a lifebuoy with light and line.	
<b>Related referents</b> ISO 20712-1 WSE001,	
<b>Additional information.</b> Test data obtained according to ISO 9186-1:2007 are not available. Consequently, a supplementary sign shall be used to increase comprehension except when the safety sign is supplemented by manuals, instructions or training.	
Management information panel supplementary sign to be used to reference a specific lifebuoy.	
	


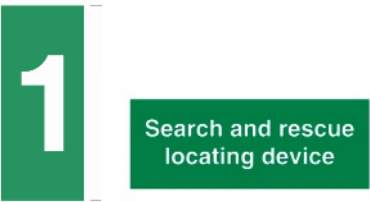
	<b>Reference No.</b> <b>LSS008 bis (needs application form)</b>
	<b>Referent</b> <b>Lifebuoy with light &amp; smoke</b>
	<b>Function</b> To indicate the location of a lifebuoy with light and smoke.
	<b>Image content</b> Ring buoy with four becketed lines and attached line and smoke
<b>Hazard</b> Not being able to locate a lifebuoy with attached water light and smoke.	
<b>Human behaviour that is intended to be caused after understanding the safety sign's meaning:</b> Being aware of the location of a lifebuoy with light and smoke.	
<b>Related referents</b> ISO 20712-1 WSE001,	
<b>Additional information.</b> Test data obtained according to ISO 9186-1:2007 are not available. Consequently, a supplementary sign shall be used to increase comprehension except when the safety sign is supplemented by manuals, instructions or training.	
Management information panel supplementary sign to be used to reference a specific lifebuoy.	
	


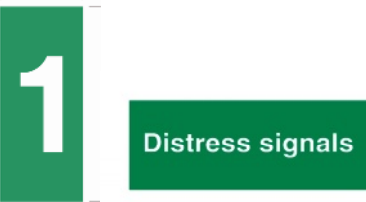
	<b>Reference No.</b> <p style="text-align: center;"><b>LSS009 (ISO 7010 E044)</b></p>
	<b>Referent</b> <p style="text-align: center;"><b>Lifejacket</b></p>
	<b>Function</b> To indicate the location of a lifejacket or location of stowed lifejackets.
	<b>Image content</b> Stylized lifejacket
<b>Hazard</b> Not being able to locate a lifejacket.	
<b>Human behaviour that is intended to be caused after understanding the safety sign's meaning:</b> Being aware of the location of a lifejacket or a stowage location of lifejackets.	
<b>Related referents</b> ISO 20712-1 WSM001,	
<b>Additional information.</b> Test data obtained according to ISO 9186-1:2007 are not available. Consequently, a supplementary sign shall be used to increase comprehension except when the safety sign is supplemented by manuals, instructions or training.	
Management information panel supplementary sign may be used to indicate the number of lifejackets stowed.	
	


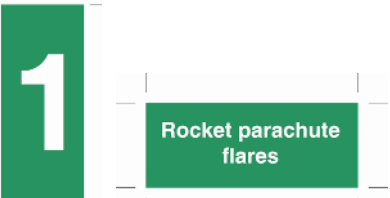




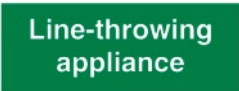
	<b>Reference No.</b> <p style="text-align: center;"><b>LSS010 (ISO 7010 E045)</b></p>
	<b>Referent</b> <p style="text-align: center;"><b>Child's Lifejacket</b></p>
	<b>Function</b> To indicate the location of a child sized lifejacket or location of stowed child sized lifejackets.
	<b>Image content</b> Stylized lifejacket with walking child
<b>Hazard</b> Not being able to locate a child size lifejacket.	
<b>Human behaviour that is intended to be caused after understanding the safety sign's meaning:</b> Being aware of the location of a child size lifejacket.	
<b>Related referents</b> ISO 20712-1 WSM001,	
<b>Additional information.</b> Test data obtained according to ISO 9186-1:2007 are not available. Consequently, a supplementary sign shall be used to increase comprehension except when the safety sign is supplemented by manuals, instructions or training.	
Management information panel supplementary sign may be used to indicate the number of lifejackets stowed.	
	


	<b>Reference No.</b> <p style="text-align: center;"><b>LSS011 (ISO 7010 E046)</b></p>
	<b>Referent</b> <p style="text-align: center;"><b>Infant's Lifejacket</b></p>
	<b>Function</b> To indicate the location of a infant sized lifejacket or location of stowed infant sized lifejackets.
	<b>Image content</b> Stylized lifejacket with infant
<b>Hazard</b> Not being able to locate an infant sized lifejacket.	
<b>Human behaviour that is intended to be caused after understanding the safety sign's meaning:</b> Being aware of the location of an infant sized lifejacket.	
<b>Related referents</b> ISO 20712-1 WSM001,	
<b>Additional information.</b> Test data obtained according to ISO 9186-1:2007 are not available. Consequently, a supplementary sign shall be used to increase comprehension except when the safety sign is supplemented by manuals, instructions or training.	
Management information panel supplementary sign may be used to indicate the number of lifejackets stowed.	
	

	<b>Reference No.</b> <p style="text-align: center;"><b>LSS012 (ISO 7010 E047)</b></p>
	<b>Referent</b> <p style="text-align: center;"><b>Search and rescue locating device</b></p>
	<b>Function</b> To indicate the location of a search and rescue locating device.
	<b>Image content</b> Locating device with solid arrow pointing towards antenna and a dashed arrow pointing away
<b>Hazard</b> Not being able to locate a search and rescue locating device.	
<b>Human behaviour that is intended to be caused after understanding the safety sign's meaning:</b> Being aware of the location of a search and rescue locating device.	
<b>Related referents</b> LSS017	
<b>Additional information.</b> Test data obtained according to ISO 9186-1:2007 are not available. Consequently, a supplementary sign shall be used to increase comprehension except when the safety sign is supplemented by manuals, instructions or training.	
Management information panel supplementary sign may be used.	
	

	<b>Reference No.</b> <p style="text-align: center;"><b>LSS013 (ISO 7010 E048)</b></p>
	<b>Referent</b> <p style="text-align: center;"><b>Distress signals</b></p>
	<b>Function</b> To indicate the stowed location of distress signals.
	<b>Image content</b> A bursting star at the end of a curved path of diminishing width
<b>Hazard</b> Not being able to locate the stowed location of distress signals.	
<b>Human behaviour that is intended to be caused after understanding the safety sign's meaning:</b> Being aware of the location of distress signals.	
<b>Related referents</b> ---	
<b>Additional information.</b> Test data obtained according to ISO 9186-1:2007 are not available. Consequently, a supplementary sign shall be used to increase comprehension except when the safety sign is supplemented by manuals, instructions or training.	
Management information panel supplementary sign may be used.	
	

	<b>Reference No.</b> <p style="text-align: center;"><b>LSS014 (ISO 7010 E049)</b></p>
	<b>Referent</b> <p style="text-align: center;"><b>Rocket parachute flares</b></p>
	<b>Function</b> To indicate the stowed location of rocket parachute flares.
	<b>Image content</b> Bursting star suspended from a parachute
<b>Hazard</b> Not being able to locate the stowed location of rocket parachute flares.	
<b>Human behaviour that is intended to be caused after understanding the safety sign's meaning:</b> Being aware of the location of rocket parachute flares.	
<b>Related referents</b> ---	
<b>Additional information.</b> Test data obtained according to ISO 9186-1:2007 are not available. Consequently, a supplementary sign shall be used to increase comprehension except when the safety sign is supplemented by manuals, instructions or training.	
Management information panel supplementary sign may be used.	
	

	<b>Reference No.</b> <p style="text-align: center;"><b>LSS015 (ISO 7010 E050)</b></p>
	<b>Referent</b> <p style="text-align: center;"><b>Line-throwing appliance</b></p>
	<b>Function</b> To indicate the location of a line-throwing appliance.
	<b>Image content</b> Barrel-mounted rocket with attached line
<b>Hazard</b> Not being able to locate the stowed location of a line-throwing appliance.	
<b>Human behaviour that is intended to be caused after understanding the safety sign's meaning:</b> Being aware of the location of a line-throwing appliance.	
<b>Related referents</b>	
<b>Additional information.</b> Test data obtained according to ISO 9186-1:2007 are not available. Consequently, a supplementary sign shall be used to increase comprehension except when the safety sign is supplemented by manuals, instructions or training.	
Management information panel supplementary sign may be used.	
	

	<b>Reference No.</b>
	<b>LSS016 (ISO 7010 E051)</b>
	<b>Referent</b>
	<b>Two-way VHF radiotelephone apparatus</b>
	<b>Function</b>
	To indicate the location of a two-way VHF radiotelephone apparatus.
	<b>Image content</b>
	Right hand holding radio with three-prong antenna and flash

**Hazard**

Not being able to locate the stowed location of a two-way VHF radiotelephone apparatus.

**Human behaviour that is intended to be caused after understanding the safety sign's meaning:**

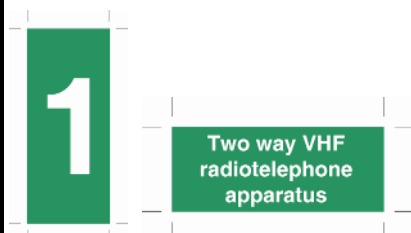
Being aware of the location of a two-way VHF radiotelephone apparatus.


**Related referents**

**Additional information.**


Test data obtained according to ISO 9186-1:2007 are not available. Consequently, a supplementary sign shall be used to increase comprehension except when the safety sign is supplemented by manuals, instructions or training.

Management information panel supplementary sign may be used.



	<b>Reference No.</b> <p style="text-align: center;">LSS017 (ISO 7010 E052)</p>
	<b>Referent</b> <p style="text-align: center;">Emergency Position Indicating Radio Beacon (EPIRB)</p>
	<b>Function</b> To indicate the stowed location of an EPIRB.
	<b>Image content</b> EPIRB with flash
<b>Hazard</b> Not being able to locate the stowed location of an EPIRB.	
<b>Human behaviour that is intended to be caused after understanding the safety sign's meaning:</b> Being aware of the location of an EPIRB.	
<b>Related referents</b> LSS016	
<b>Additional information.</b> Test data obtained according to ISO 9186-1:2007 are not available. Consequently, a supplementary sign shall be used to increase comprehension except when the safety sign is supplemented by manuals, instructions or training.	
Management information panel supplementary sign may be used.	
<div style="display: flex; align-items: center; gap: 20px;"> <div data-bbox="140 1473 228 1675" style="border: 1px solid black; padding: 5px; text-align: center; width: 50px; height: 80px;">1</div> <div data-bbox="276 1541 555 1675" style="border: 1px solid black; padding: 5px; text-align: center; width: 150px; height: 50px;">           Emergency indicating radio beacon EPIRB         </div> </div>	



	<b>Reference No.</b> <p style="text-align: center;"><b>LSS018 (ISO 7010 E053)</b></p>
	<b>Referent</b> <p style="text-align: center;"><b>Embarkation ladder</b></p>
	<b>Function</b> To indicate the location of an embarkation ladder.
	<b>Image content</b> Arrow with superimposed six-rung ladder pointing down toward rippling water surface

**Hazard**

Not being able to locate the location of an embarkation ladder.

**Human behaviour that is intended to be caused after understanding the safety sign's meaning:**

Being aware of the location of an embarkation ladder.

**Related referents**


---

**Additional information.**

Test data obtained according to ISO 9186-1:2007 are not available. Consequently, a supplementary sign shall be used to increase comprehension except when the safety sign is supplemented by manuals, instructions or training.

Management information panel supplementary sign may be used.



	<b>Reference No.</b> <p style="text-align: center;">LSS019 (ISO 7010 E054)</p>
	<b>Referent</b> <p style="text-align: center;">Marine evacuation system (slide)</p>
	<b>Function</b> To indicate the location of a marine evacuation system (slide).
	<b>Image content</b> Slide terminating in open raft above rippling water surface

**Hazard**

Not being able to locate a marine evacuation system (slide).

**Human behaviour that is intended to be caused after understanding the safety sign's meaning:**

Being aware of the location of a marine evacuation system (slide) to launch from its stowed position or at an egress point for passengers and crew to use.

**Related referents**

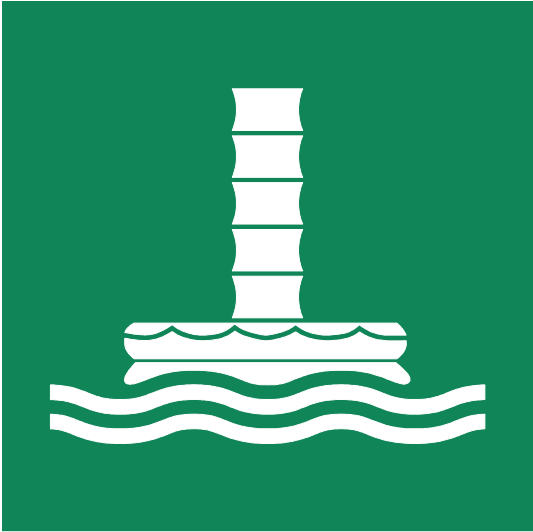
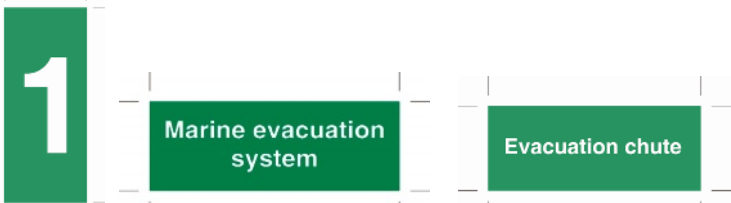
LSS020


**Additional information.**

Test data obtained according to ISO 9186-1:2007 are not available. Consequently, a supplementary sign shall be used to increase comprehension except when the safety sign is supplemented by manuals, instructions or training.

Management information panel supplementary sign may be used.



	<b>Reference No.</b> <p style="text-align: center;"><b>LSS020 (ISO 7010 E055)</b></p>
	<b>Referent</b> <p style="text-align: center;"><b>Marine evacuation system (chute)</b></p>
	<b>Function</b> To indicate the location of a marine evacuation system (chute).
	<b>Image content</b> Vertical chute above an open raft above rippling water surface
<b>Hazard</b> Not being able to locate a marine evacuation system (chute) in the event of an evacuation.	
<b>Human behaviour that is intended to be caused after understanding the safety sign's meaning:</b> Being aware of the location of a marine evacuation system (chute) to launch from its stowed position or at an egress point for passengers and crew to use.	
<b>Related referents</b> LSS019	
<b>Additional information.</b> Test data obtained according to ISO 9186-1:2007 are not available. Consequently, a supplementary sign shall be used to increase comprehension except when the safety sign is supplemented by manuals, instructions or training.	
Management information panel supplementary sign may be used.	
	

	<b>Reference No.</b> <p style="text-align: center;"><b>LSS021 (ISO 7010 E056)</b></p>
	<b>Referent</b> <p style="text-align: center;"><b>Survival clothing</b></p>
	<b>Function</b> To indicate the location of survival clothing in the event of an evacuation from the vessel or search and rescue operation.
	<b>Image content</b> Full body survival suit with hood

**Hazard**

Not being able to locate survival clothing in the event of an abandon ship or search and rescue operation when worn while on board a rescue boat.

**Human behaviour that is intended to be caused after understanding the safety sign's meaning:**

Being aware of the location of survival clothing.

**Related referents**

N/A

**Additional information.**

Test data obtained according to ISO 9186-1:2007 are not available. Consequently, a supplementary sign shall be used to increase comprehension and indicate the type of survival clothing except when the safety sign is supplemented by manuals, instructions or training.

Management information panel supplementary sign may be used.


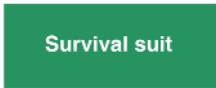




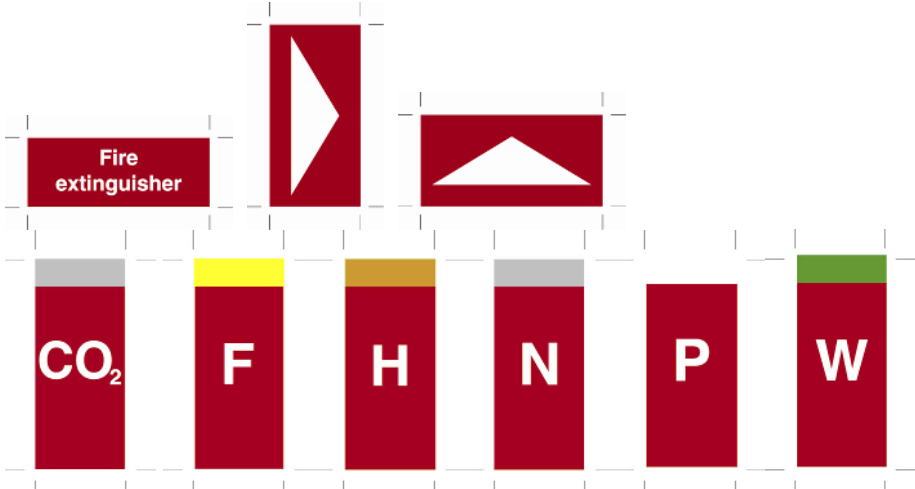

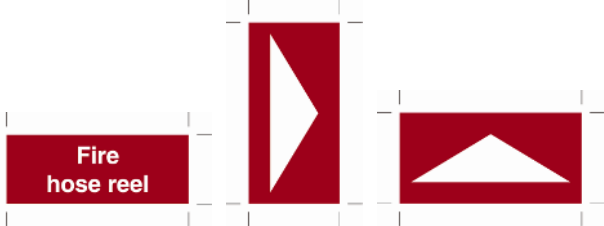

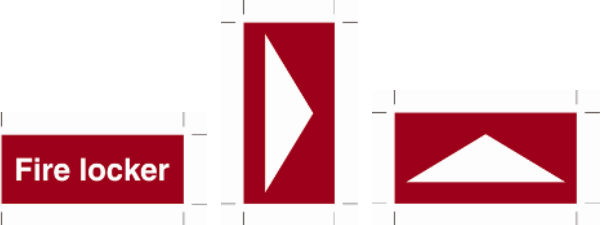

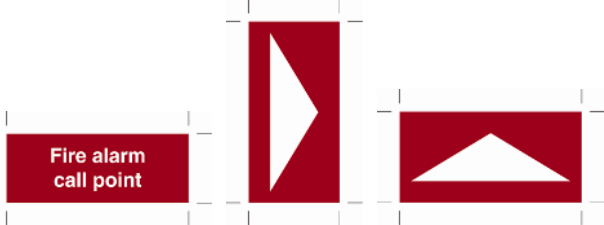
				
---	---	---	--	---

Table 7 — Fire-fighting equipment signs (FES)


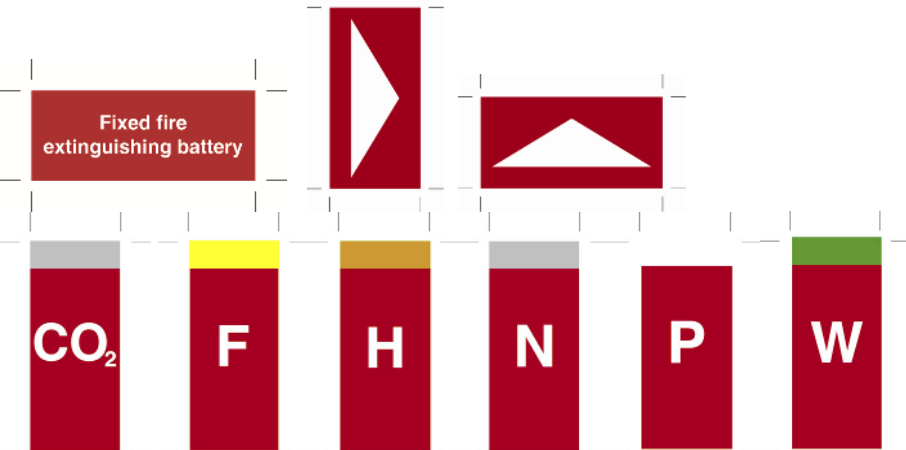
	<b>Reference No.</b> <p>FES001 (ISO 7010-F001)</p>
	<b>Referent</b> <p>Fire extinguisher</p>
	<b>Function</b> <p>To indicate the location of a fire extinguisher.</p>
	<b>Image content</b> <p>Fire extinguisher (profile) with label, flame determinant</p>
<b>Hazard</b> <p>Not being able to locate a fire extinguisher</p>	
<b>Human behaviour that is intended to be caused after understanding the safety sign's meaning</b> <p>Being aware of the location of a fire extinguisher</p>	
<b>Related referents</b> <p>ISO 7010-F002, ISO 7010-F003, ISO 7010-F004, ISO 7010-F005, ISO 7010-F006</p>	
<b>Additional information</b> <p>Test data obtained according to ISO 9186-1:2007 are not available. Consequently, a supplementary text sign shall be used to increase comprehension except when the safety sign is supplemented by manuals, instructions or training. A supplementary sign may be used to identify what extinguishing media is in the fire extinguisher: CO<sub>2</sub>, Nitrogen, Foam, Powder, Water, Gases other than CO<sub>2</sub>.</p>	
	


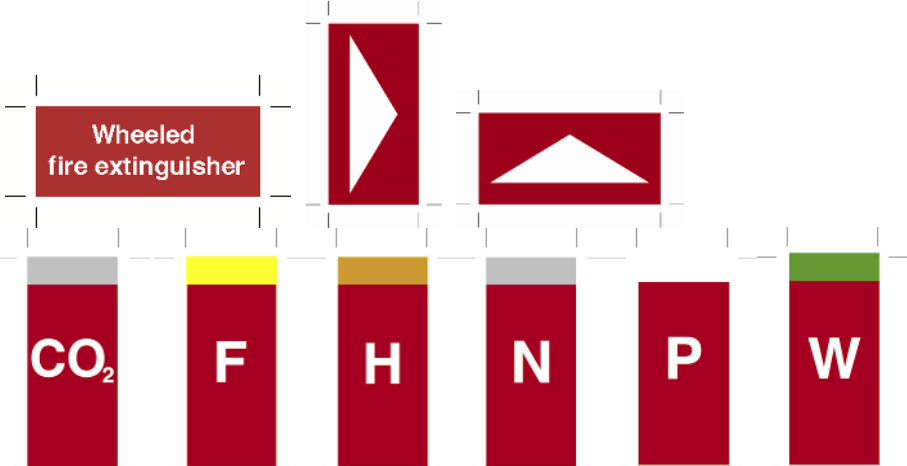
	<b>Reference No.</b> <p style="text-align: center;"><b>FES002 (ISO 7010-F002)</b></p>
	<b>Referent</b> <p style="text-align: center;"><b>Fire hose reel</b></p>
	<b>Function</b> To indicate the location of a fire hose reel.
	<b>Image content</b> Seven vertical lines, one with an irregular rectangle under, circle with cross and line attached to vertical bar, flame determinant
<b>Hazard</b> Not being able to locate a fire hose reel	
<b>Human behaviour that is intended to be caused after understanding the safety sign's meaning</b> A crewmember or firefighter being aware of the location of a fire hose reel	
<b>Related referents</b> ISO 7010-F001, ISO 7010-F003, ISO 7010-F004, ISO 7010-F005, ISO 7010-F006	
<b>Additional information</b> Test data obtained according to ISO 9186-1:2007 are not available. Consequently, a supplementary text sign shall be used to increase comprehension except when the safety sign is supplemented by manuals, instructions or training.	
	


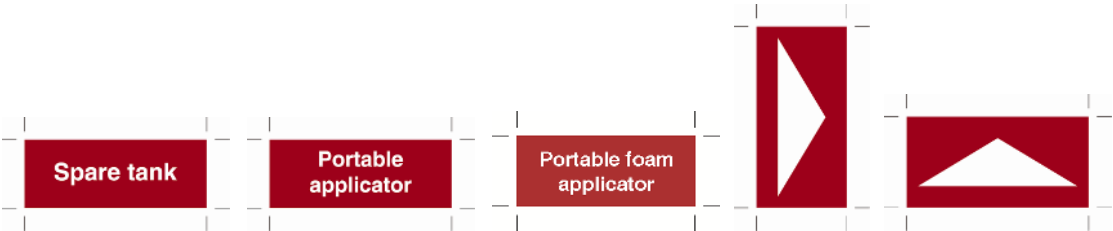
	<b>Reference No.</b>  <b>FES003 (ISO 7010-F004)</b>
	<b>Referent</b>  <b>Fire locker (Collection of fire fighting equipment)</b>
	<b>Function</b> To indicate the location of a fire locker.
	<b>Image content</b> Fire helmet (profile), flame determinant
<b>Hazard</b>  Not being able to locate a collection of fire-fighting equipment	
<b>Human behaviour that is intended to be caused after understanding the safety sign's meaning</b>  A crewmember or firefighter being aware of the location of fire-fighting equipment	
<b>Related referents</b>  ISO 7010-F001, ISO 7010-F002, ISO 7010-F003, ISO 7010-F005, ISO 7010-F006	
<b>Additional information</b>  This safety sign should be used for fire-fighting equipment for which there is no standardized safety sign.  The fire helmet may be replaced with another fire helmet appropriate to cultural requirements.  Test data obtained according to ISO 9186-1:2007 are not available. Consequently, a supplementary text sign shall be used to increase comprehension except when the safety sign is supplemented by manuals, instructions or training.	
	


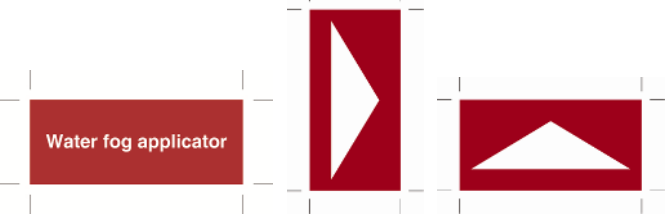
	<b>Reference No.</b> <p style="text-align: center;"><b>FES004 (ISO 7010-F005)</b></p>
	<b>Referent</b> <p style="text-align: center;"><b>Fire alarm call point</b></p>
	<b>Function</b> To indicate the location of a fire alarm call point
	<b>Image content</b> Hand (plan view) with one finger extended, dot in square (outlined) broken at bottom, flame determinant
<b>Hazard</b> Not being able to locate a fire alarm call point	
<b>Human behaviour that is intended to be caused after understanding the safety sign's meaning</b> Being aware of the location of a fire alarm call point	
<b>Related referents</b> ISO 7010-F001, ISO 7010-F002, ISO 7010-F003, ISO 7010-F004, ISO 7010-F006	
<b>Additional information</b> Test data obtained according to ISO 9186-1:2007 are not available. Consequently, a supplementary text sign shall be used to increase comprehension except when the safety sign is supplemented by manuals, instructions or training.	
	




	<p><b>Reference No.</b></p> <p>FES005 (ISO 7010 F008)</p>
	<p><b>Referent</b></p> <p>Fixed fire extinguishing battery</p>
	<p><b>Function</b></p> <p>To indicate the location of a fixed fire extinguishing battery</p>
	<p><b>Image content</b></p> <p>Four bottles attached to a manifold, flame determinant</p>
<p><b>Hazard</b></p>	
<p>Not being able to locate a fixed fire extinguishing battery</p>	
<p><b>Human behaviour that is intended to be caused after understanding the safety sign's meaning</b></p>	
<p>A crewmember or firefighter being aware of the location of a fixed fire extinguishing battery</p>	
<p><b>Related referents</b></p>	
<p>ISO 7010-W029</p>	
<p><b>Additional information</b></p>	
<p>Test data obtained according to ISO 9186-1:2007 are not available. Consequently, a supplementary text sign shall be used to increase comprehension except when the safety sign is supplemented by manuals, instructions or training. A supplementary sign may be used to identify what extinguishing media is in the battery: CO<sub>2</sub>, Nitrogen, Foam, Powder, Water, Gases other than CO<sub>2</sub>.</p>	
	

	<b>Reference No.</b> <p style="text-align: center;">FES006 (ISO 7010 F009)</p>
	<b>Referent</b> <p style="text-align: center;">Wheeled fire extinguisher</p>
	<b>Function</b> To indicate the location of a wheeled fire extinguisher
	<b>Image content</b> Bottle on wheeled cart (profile), flame determinant
<b>Hazard</b> Not being able to locate a wheeled fire extinguisher in order to fight a fire in an emergency	
<b>Human behaviour that is intended to be caused after understanding the safety sign's meaning</b> A crewmember or firefighter being aware of the location of a wheeled fire extinguisher	
<b>Related referents</b> ---	
<b>Additional information</b> Test data obtained according to ISO 9186-1:2007 are not available. Consequently, a supplementary text sign shall be used to increase comprehension except when the safety sign is supplemented by manuals, instructions or training. A supplementary sign may be used to identify what extinguishing media is in the extinguisher: CO <sub>2</sub> , Nitrogen, Foam, Powder, Water	
	

	<b>Reference No.</b> <p style="text-align: center;"><b>FES007 (ISO 7010 F010)</b></p>
	<b>Referent</b> <p style="text-align: center;"><b>Portable foam applicator unit</b></p>
	<b>Function</b> To indicate the location of a portable foam applicator unit or spare foam tank
	<b>Image content</b> Foam can with goose neck hose terminating with a venturi nozzle, flame determinant
<b>Hazard</b> <p>Not being able to locate a portable foam applicator unit or relevant spare foam tank to fight a fire in an emergency situation</p>	
<b>Human behaviour that is intended to be caused after understanding the safety sign's meaning</b> <p>A crewmember or firefighter being aware of the location of a portable foam applicator unit or spare foam tank</p>	
<b>Related referents</b> <p>---</p>	
<b>Additional information</b> <p>Test data obtained according to ISO 9186-1:2007 are not available. Consequently, a supplementary text sign shall be used to increase comprehension (e.g. Portable foam applicator unit, relevant spare tank, and portable applicator) except when the safety sign is supplemented by manuals, instructions or training.</p>	
	

	<p><b>Reference No.</b></p> <p>FES008 (ISO 7010 F011)</p>
	<p><b>Referent</b></p> <p>Water fog applicator</p>
	<p><b>Function</b></p> <p>To indicate the location of a water fog applicator</p>
	<p><b>Image content</b></p> <p>90 degree bend terminating in a nozzle with five non-parallel segmented lines, flame determinant</p>
<p><b>Hazard</b></p>	
<p>Not being able to locate a water fog applicator in an emergency situation</p>	
<p><b>Human behaviour that is intended to be caused after understanding the safety sign's meaning</b></p>	
<p>A crewmember or firefighter being aware of the location of a water fog applicator</p>	
<p><b>Related referents</b></p> <p>---</p>	
<p><b>Additional information</b></p>	
<p>Test data obtained according to ISO 9186-1:2007 are not available. Consequently, a supplementary text sign shall be used to increase comprehension except when the safety sign is supplemented by manuals, instructions or training.</p>	
	

	<b>Reference No.</b> <p style="text-align: center;">FES009 (ISO 7010 F012)</p>
	<b>Referent</b> <p style="text-align: center;">Fixed fire extinguishing installation</p>
	<b>Function</b> To indicate the location of a fixed fire extinguishing installation
	<b>Image content</b> Tank in profile supported on a frame at two points, flame determinant

**Hazard**

Not being able to locate a fixed fire extinguishing installation in order to discharge the contents in fire fighting in an emergency situation

**Human behaviour that is intended to be caused after understanding the safety sign's meaning**

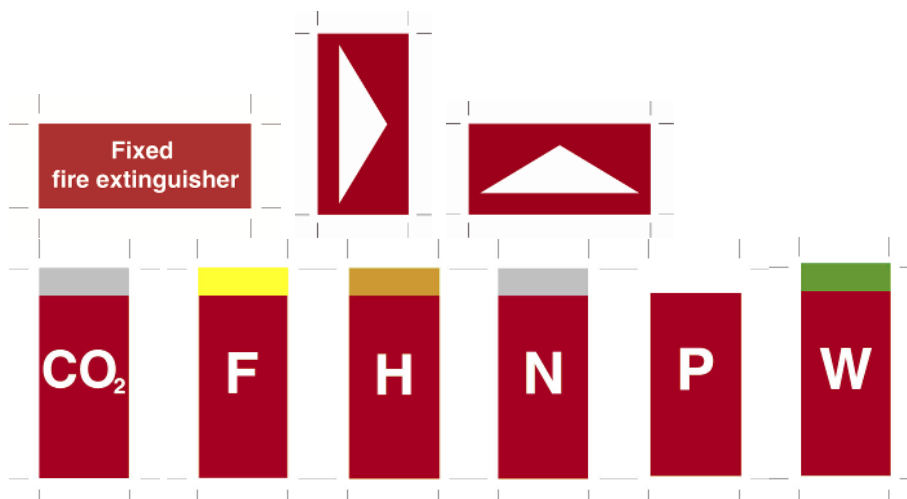
A crewmember or firefighter being aware of the location of a fixed fire extinguishing installation

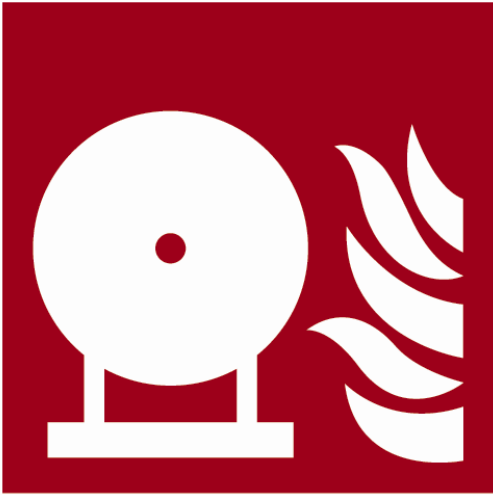
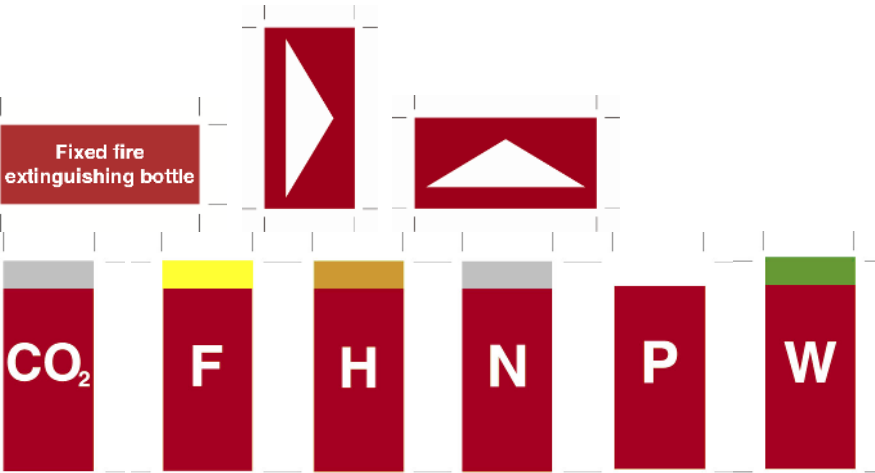
**Related referents**


---

**Additional information**

Test data obtained according to ISO 9186-1:2007 are not available. Consequently, a supplementary text sign shall be used to increase comprehension except when the safety sign is supplemented by manuals, instructions or training. A supplementary sign may be used to identify what extinguishing media is in the fixed installation: CO<sub>2</sub>, Nitrogen, Foam, Powder, Water, Gases other than CO<sub>2</sub>.



	<b>Reference No.</b> <p style="text-align: center;">FES010 (ISO 7010 F013)</p>
	<b>Referent</b> <p style="text-align: center;">Fixed fire extinguishing bottle</p>
	<b>Function</b> To indicate the location of a fixed fire extinguishing bottle
	<b>Image content</b> Head-on view of bottle supported on its side on a frame at two points, flame determinant
<b>Hazard</b> Not being able to locate and discharge a fixed fire extinguishing bottle in a fire situation	
<b>Human behaviour that is intended to be caused after understanding the safety sign's meaning</b> A crewmember or firefighter being aware of the location of a fixed fire extinguishing bottle	
<b>Related referents</b> ---	
<b>Additional information</b> Test data obtained according to ISO 9186-1:2007 are not available. Consequently, a supplementary text sign shall be used to increase comprehension except when the safety sign is supplemented by manuals, instructions or training. A supplementary sign may be used to identify what extinguishing media is in the fixed installation: CO <sub>2</sub> , Nitrogen, Foam, Powder, Water	
	

	<b>Reference No.</b> <p style="text-align: center;">FES011 (ISO 7010 F014)</p>
	<b>Referent</b> <p style="text-align: center;">Remote release station</p>
	<b>Function</b> To indicate the location of a remote release station
	<b>Image content</b> Bottle with a knob handle on top, flame determinant

**Hazard**

Not being able to locate a remote release station in an emergency situation

**Human behaviour that is intended to be caused after understanding the safety sign's meaning**

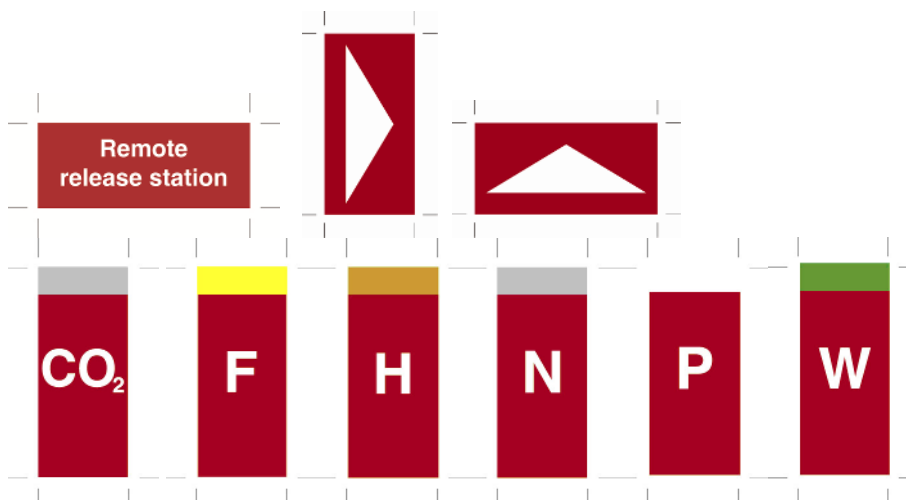
A crewmember or firefighter being aware of the location of a remote release station

**Related referents**

ISO 7010-W029

**Additional information**

Test data obtained according to ISO 9186-1:2007 are not available. Consequently, a supplementary text sign shall be used to increase comprehension (e.g. Remote release station) except when the safety sign is supplemented by manuals, instructions or training. A supplementary sign may be used to identify what extinguishing media is released at the remote station: CO<sub>2</sub>, Nitrogen, Foam, Powder, Water








	<b>Reference No.</b> <p style="text-align: center;">FES012 (ISO 7010 F015)</p>
	<b>Referent</b> <p style="text-align: center;">Fire monitor</p>
	<b>Function</b> To indicate the location of a fire monitor
	<b>Image content</b> Fire monitor in profile, flame determinant
<b>Hazard</b>	
Not being able to locate a fire monitor in an emergency situation	
<b>Human behaviour that is intended to be caused after understanding the safety sign's meaning</b>	
A crewmember or firefighter being aware of the location of a fire monitor	
<b>Related referents</b>	
---	
<b>Additional information</b>	
Test data obtained according to ISO 9186-1:2007 are not available. Consequently, a supplementary text sign shall be used to increase comprehension (e.g. Fire monitor, monitor) except when the safety sign is supplemented by manuals, instructions or training. A supplementary sign may be used to identify what extinguishing media is released at the fire monitor: Foam, Water, Powder,	
	







Table 8 — Prohibition signs (PSS)


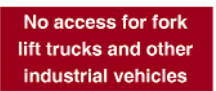
	<b>Reference No.</b> PSS001 (ISO 7010-P001)
	<b>Referent</b> General prohibition sign
	<b>Function</b> To signify a prohibited action
	<b>Image content</b> None
<b>Hazard</b> Risk to people specified by the supplementary sign <b>Human behaviour that is intended to be caused after understanding the safety sign's meaning</b> Not doing an action specified by the supplementary sign <b>Related referents</b> ISO 7010-M001, ISO 7010-W001 <b>Additional information</b> This safety sign cannot be used on its own and requires a supplementary sign to give further information about the action which is prohibited. For example: "do not throw garbage overboard"	



	<b>Reference No.</b> PSS002 (ISO 7010-P002)
	<b>Referent</b> No smoking
	<b>Function</b> To prohibit smoking
	<b>Image content</b> Cigarette (profile) with two wavy lines
<b>Hazard</b> Fire or explosion caused by lit cigarettes or other smoking materials or harm from the smoke <b>Human behaviour that is intended to be caused after understanding the safety sign's meaning</b> Not smoking <b>Related referents</b> ISO 7010-P003 <b>Additional information</b> Test data obtained according to ISO 9186-1:2007 are not available. Consequently, a supplementary text sign shall be used to increase comprehension except when the safety sign is supplemented by manuals, instructions or training.	



	<b>Reference No.</b> PSS003 (ISO 7010-P003)
	<b>Referent</b> No open flame; Fire, open ignition source and smoking prohibited
	<b>Function</b> To prohibit smoking and all forms of open flame
	<b>Image content</b> Match (profile, outlined), flame
<b>Hazard</b> Fire or explosion caused by an open flame, open ignition source or smoking <b>Human behaviour that is intended to be caused after understanding the safety sign's meaning</b> Not having an open flame or open ignition source and not smoking <b>Related referents</b> ISO 7010-P002, ISO 7010-W021 <b>Additional information</b> Test data obtained according to ISO 9186-1:2007 are not available. Consequently, a supplementary text sign shall be used to increase comprehension except when the safety sign is supplemented by manuals, instructions or training.	
<div style="display: flex; justify-content: space-around; border: 1px dashed gray; padding: 5px;"> <div style="background-color: #800000; color: white; padding: 5px 10px; border: 1px dashed gray;">No matches</div> <div style="background-color: #800000; color: white; padding: 5px 10px; border: 1px dashed gray;">No naked flames</div> <div style="background-color: #800000; color: white; padding: 5px 10px; border: 1px dashed gray;">No hot work</div> </div>	

	<b>Reference No.</b> PSS004 (ISO 7010-P004)
	<b>Referent</b> No thoroughfare*
	<b>Function</b> To prohibit the use of a thoroughfare by pedestrians
	<b>Image content</b> Human figure walking (left hand)
<b>Hazard</b> Collision with vehicles or machinery	
<b>Human behaviour that is intended to be caused after understanding the safety sign's meaning</b> Not using the thoroughfare; may also mean "no passage while at sea"; "Restricted Area, no unauthorized entry"; or Restricted Area: authorized persons only"	
<b>Related referents</b> ---	
<b>Additional information</b> Test data obtained according to ISO 9186-1:2007 are not available. Consequently, a supplementary text sign shall be used to increase comprehension except when the safety sign is supplemented by manuals, instructions or training.	
	

	<b>Reference No.</b> PSS005 (ISO 7010-P005)
	<b>Referent</b> Not drinking water
	<b>Function</b> To prohibit drinking of unsuitable water
	<b>Image content</b> Tap above three lines joined together, two wavy lines
<b>Hazard</b> Water unsuitable for drinking <b>Human behaviour that is intended to be caused after understanding the safety sign's meaning</b> Not drinking the water <b>Related referents</b> --- <b>Additional information</b> Test data obtained according to ISO 9186-1:2007 are not available. Consequently, a supplementary text sign shall be used to increase comprehension except when the safety sign is supplemented by manuals, instructions or training.	
	

	<b>Reference No.</b> PSS006 (ISO 7010-P006)
	<b>Referent</b> No access for fork lift trucks and other industrial vehicles
	<b>Function</b> To prohibit the use of fork lift trucks and other industrial vehicles in unauthorized areas
	<b>Image content</b> Fork lift truck (left hand profile) with human figure
<b>Hazard</b> Moving fork lift trucks and other industrial vehicles <b>Human behaviour that is intended to be caused after understanding the safety sign's meaning</b> Not using fork lift trucks and other industrial vehicles <b>Related referents</b> ISO 7010-W014 <b>Additional information</b> Test data obtained according to ISO 9186-1:2007 are not available. Consequently, a supplementary text sign shall be used to increase comprehension except when the safety sign is supplemented by manuals, instructions or training.	
	



	<b>Reference No.</b> PSS007 (ISO 7010-P007)
	<b>Referent</b> No access for people with active implanted cardiac devices
	<b>Function</b> To prohibit people with active implanted cardiac devices from entering a designated area
	<b>Image content</b> Heart shape and representation of pulse generator connected by curved line
<b>Hazard</b> Interference to the operation of or damage to active implanted cardiac devices from equipment generating strong electromagnetic fields	
<b>Human behaviour that is intended to be caused after understanding the safety sign's meaning</b> People with active implanted cardiac devices not entering a designated area	
<b>Related referents</b> ---	
<b>Additional information</b> Test data obtained according to ISO 9186-1:2007 are not available. Consequently, a supplementary text sign shall be used to increase comprehension except when the safety sign is supplemented by manuals, instructions or training.	
	



	<b>Reference No.</b> PSS008 (ISO 7010-P008)
	<b>Referent</b> No metallic articles or watches
	<b>Function</b> To prohibit metallic articles or watches
	<b>Image content</b> Face and part of strap of an analogue wristwatch, flat side of a key
<b>Hazard</b> Strong magnetic fields <b>Human behaviour that is intended to be caused after understanding the safety sign's meaning</b> Removing or not wearing metallic articles or watches <b>Related referents</b> --- <b>Additional information</b> Test data obtained according to ISO 9186-1:2007 are not available. Consequently, a supplementary text sign shall be used to increase comprehension except when the safety sign is supplemented by manuals, instructions or training.	
	



	<b>Reference No.</b> PSS009 (ISO 7010-P010)
	<b>Referent</b> Do not touch
	<b>Function</b> To prohibit touching objects/parts of an object
	<b>Image content</b> Hand, horizontal line
<b>Hazard</b> Dangerous surfaces <b>Human behaviour that is intended to be caused after understanding the safety sign's meaning</b> Not touching objects or parts of an object <b>Related referents</b> ISO 7010-P015 <b>Additional information</b> Test data obtained according to ISO 9186-1:2007 are not available. Consequently, a supplementary text sign shall be used to increase comprehension except when the safety sign is supplemented by manuals, instructions or training.	
	

	<b>Reference No.</b> PSS010 (ISO 7010-P011)
	<b>Referent</b> Do not extinguish with water
	<b>Function</b> To prohibit using water to extinguish a fire
	<b>Image content</b> Bucket, area outlined by wavy line, flame
<b>Hazard</b> Dangerous reaction from the application of water to a burning substance	
<b>Human behaviour that is intended to be caused after understanding the safety sign's meaning</b> Not using water to extinguish a fire	
<b>Related referents</b> ISO 7010-W021	
<b>Additional information</b> Test data obtained according to ISO 9186-1:2007 are not available. Consequently, a supplementary text sign shall be used to increase comprehension except when the safety sign is supplemented by manuals, instructions or training.	
	

	<b>Reference No.</b> PSS011 (ISO 7010-P013)
	<b>Referent</b> No activated mobile phone
	<b>Function</b> To prohibit the activation of mobile phones
	<b>Image content</b> Mobile phone (front view), six curved lines
<b>Hazard</b> Electromagnetic field <b>Human behaviour that is intended to be caused after understanding the safety sign's meaning</b> Turning the mobile phone off or not switching it on <b>Related referents</b> --- <b>Additional information</b> Test data obtained according to ISO 9186-1:2007 are not available. Consequently, a supplementary text sign shall be used to increase comprehension except when the safety sign is supplemented by manuals, instructions or training.	
	

	<b>Reference No.</b> PSS012 (ISO 7010-P014)
	<b>Referent</b> No access for persons with metallic implants
	<b>Function</b> To prohibit access of people with metallic implants
	<b>Image content</b> Hip joint and socket (outlined) joined by a black hip implant
<b>Hazard</b> Invisible rays causing a rise in temperature of a metallic implant <b>Human behaviour that is intended to be caused after understanding the safety sign's meaning</b> People with implants not entering a designated area <b>Related referents</b> --- <b>Additional information</b> Test data obtained according to ISO 9186-1:2007 are not available. Consequently, a supplementary text sign shall be used to increase comprehension except when the safety sign is supplemented by manuals, instructions or training.	
	


	<b>Reference No.</b> PSS013 (ISO 7010-P015)
	<b>Referent</b> No reaching in
	<b>Function</b> To prohibit people putting hands into openings
	<b>Image content</b> Hand, two converging lines
<b>Hazard</b> Injury to hands <b>Human behaviour that is intended to be caused after understanding the safety sign's meaning</b> Not putting hands into designated openings <b>Related referents</b> ISO 7010-P010 <b>Additional information</b> Test data obtained according to ISO 9186-1:2007 are not available. Consequently, a supplementary text sign shall be used to increase comprehension except when the safety sign is supplemented by manuals, instructions or training.	
	

	<b>Reference No.</b> PSS014 (ISO 7010-P017)
	<b>Referent</b> No pushing
	<b>Function</b> To prohibit pushing against an object
	<b>Image content</b> Horizontal line and vertical block with human figure leaning against it
<b>Hazard</b> Objects overbalancing and falling <b>Human behaviour that is intended to be caused after understanding the safety sign's meaning</b> Not pushing an object <b>Related referents</b> --- <b>Additional information</b> Test data obtained according to ISO 9186-1:2007 are not available. Consequently, a supplementary text sign shall be used to increase comprehension except when the safety sign is supplemented by manuals, instructions or training.	
	


	<b>Reference No.</b> PSS015 (ISO 7010-P018)
	<b>Referent</b> No sitting
	<b>Function</b> To prohibit sitting on a surface
	<b>Image content</b> Human figure in sitting position, horizontal line
<b>Hazard</b> Surface unsuitable to sit on <b>Human behaviour that is intended to be caused after understanding the safety sign's meaning</b> Not sitting on an unsuitable surface <b>Related referents</b> --- <b>Additional information</b> Test data obtained according to ISO 9186-1:2007 are not available. Consequently, a supplementary text sign shall be used to increase comprehension except when the safety sign is supplemented by manuals, instructions or training.	
	

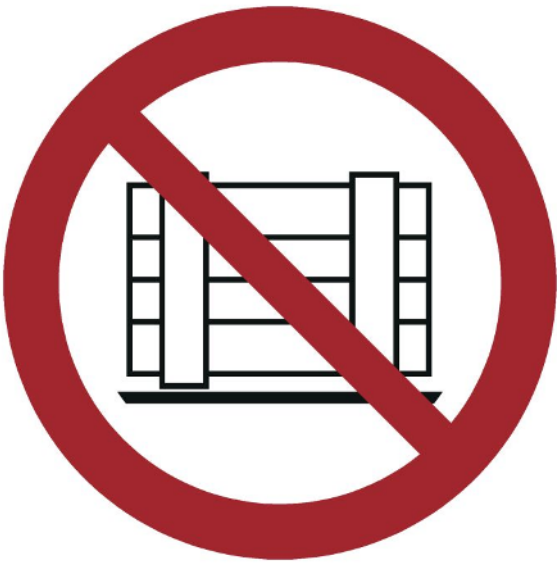
	<b>Reference No.</b> PSS016 (ISO 7010-P019)
	<b>Referent</b> No stepping on surface
	<b>Function</b> To prohibit stepping onto a surface
	<b>Image content</b> Human figure stepping up, line with right angle
<b>Hazard</b> Surface unsuitable for stepping onto <b>Human behaviour that is intended to be caused after understanding the safety sign's meaning</b> Not stepping onto an unsuitable surface <b>Related referents</b> ISO 7010-P024 <b>Additional information</b> Test data obtained according to ISO 9186-1:2007 are not available. Consequently, a supplementary text sign shall be used to increase comprehension except when the safety sign is supplemented by manuals, instructions or training.	
	



	<b>Reference No.</b> PSS017 (ISO 7010-P020)
	<b>Referent</b> Do not use lift in the event of fire
	<b>Function</b> To prohibit use of lift in the event of fire
	<b>Image content</b> Outline of lift with two human figures standing inside and flames at the right hand side of the lift
<b>Hazard</b> Being trapped in a lift during a fire <b>Human behaviour that is intended to be caused after understanding the safety sign's meaning</b> Not using lift in the event of fire <b>Related referents</b> --- <b>Additional information</b> Test data obtained according to ISO 9186-1:2007 are not available from more than one country. Findings from national testing, however, showed that the graphical symbol did not reach the criteria of acceptability. Consequently, a supplementary text sign shall be used to increase comprehension except when the safety sign is supplemented by manuals, instructions or training.	

	<b>Reference No.</b> PSS018 (ISO 7010-P021)
	<b>Referent</b> No dogs
	<b>Function</b> To prohibit taking dogs into designated areas
	<b>Image content</b> Dog (right hand profile)
<b>Hazard</b> Infections due to dogs; harming of people caused by dog bites	
<b>Human behaviour that is intended to be caused after understanding the safety sign's meaning</b> Not taking dogs into a prohibited area	
<b>Related referents</b> ---	
<b>Additional information</b> Test data obtained according to ISO 9186-1:2007 are not available from more than one country. Findings from national testing, however, showed that the graphical symbol did not reach the criteria of acceptability. Consequently, a supplementary text sign shall be used to increase comprehension except when the safety sign is supplemented by manuals, instructions or training.	

	<b>Reference No.</b> PSS019 (ISO 7010-P022)
	<b>Referent</b> No eating or drinking
	<b>Function</b> To prohibit eating and drinking
	<b>Image content</b> Three horizontal lines alongside a cup with straw
<b>Hazard</b> Ingestion of dangerous substances by food and drink contaminated at a designated area <b>Human behaviour that is intended to be caused after understanding the safety sign's meaning</b> No eating or drinking in the designated area <b>Related referents</b> --- <b>Additional information</b> Test data obtained according to ISO 9186-1:2007 are not available from more than one country. Findings from national testing, however, showed that the graphical symbol did not reach the criteria of acceptability. Consequently, a supplementary text sign shall be used to increase comprehension except when the safety sign is supplemented by manuals, instructions or training.	

	<b>Reference No.</b> PSS020 (ISO 7010-P023)
	<b>Referent</b> Do not obstruct
	<b>Function</b> To prohibit the obstruction of a designated clear area
	<b>Image content</b> Crate and horizontal line underneath
<b>Hazard</b> Obstruction in a designated clear area	
<b>Human behaviour that is intended to be caused after understanding the safety sign's meaning</b> Not placing an obstruction in a designated clear area (e.g. escape routes, emergency exits, passageways)	
<b>Related referents</b> ---	
<b>Additional information</b> Test data obtained according to ISO 9186-1:2007 are not available. Consequently, a supplementary text sign shall be used to increase comprehension except when the safety sign is supplemented by manuals, instructions or training.	





	<b>Reference No.</b> PSS021 (ISO 7010-P024)
	<b>Referent</b> Do not walk or stand here
	<b>Function</b> To prohibit walking or standing on a designated area
	<b>Image content</b> Two footprints
<b>Hazard</b> Areas which are unsafe for people to walk or stand on <b>Human behaviour that is intended to be caused after understanding the safety sign's meaning</b> Keeping off a designated area <b>Related referents</b> ISO 7010-P019 <b>Additional information</b> Test data obtained according to ISO 9186-1:2007 are not available. Consequently, a supplementary text sign shall be used to increase comprehension except when the safety sign is supplemented by manuals, instructions or training.	

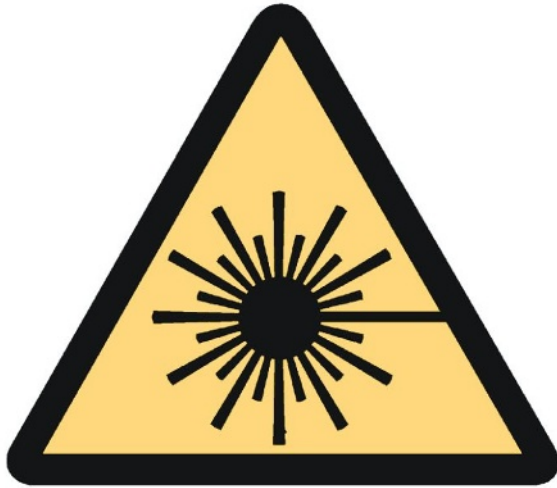
Table 9 — Hazard warning signs (WSS)


	<b>Reference No.</b> WSS001 (ISO 7010-W001)
	<b>Referent</b> General warning sign
	<b>Function</b> To signify a general warning
	<b>Image content</b> Exclamation mark
<b>Hazard</b> Risk to people specified by the supplementary sign <b>Human behaviour that is intended to be caused after understanding the safety sign's meaning</b> Taking care regarding the hazard specified by the supplementary sign <b>Related referents</b> ISO 7010-M001, ISO 7010-P001 <b>Additional information</b> This safety sign cannot be used on its own and requires a supplementary sign to give further information about the hazard.	


	<b>Reference No.</b> WSS002 (ISO 7010-W002)
	<b>Referent</b> Warning; Explosive material
	<b>Function</b> To warn of explosive materials
	<b>Image content</b> Part of filled circle with radiating triangular lines and irregular shapes
<b>Hazard</b> Explosion	
<b>Human behaviour that is intended to be caused after understanding the safety sign's meaning</b> Taking care when in the vicinity of or handling explosive materials	
<b>Related referents</b> ---	
<b>Additional information</b> Test data obtained according to ISO 9186-1:2007 are not available. Consequently, a supplementary text sign shall be used to increase comprehension except when the safety sign is supplemented by manuals, instructions or training.	


	<b>Reference No.</b> WSS003 (ISO 7010-W003)
	<b>Referent</b> Warning; Radioactive material or ionizing radiation
	<b>Function</b> To warn of radioactive materials or ionizing radiation
	<b>Image content</b> Circle, three semi-circular arc shapes surrounding the circle
<b>Hazard</b> Radioactivity and ionizing radiation	
<b>Human behaviour that is intended to be caused after understanding the safety sign's meaning</b> Taking care to avoid exposure to radioactive material or ionizing radiation	
<b>Related referents</b> ISO 7010-W005	
<b>Additional information</b> Test data obtained according to ISO 9186-1:2007 are not available. Consequently, a supplementary text sign shall be used to increase comprehension except when the safety sign is supplemented by manuals, instructions or training.	





	<b>Reference No.</b> <b>WSS004 (ISO 7010-W004)</b>
	<b>Referent</b> <b>Warning; Laser beam</b>
	<b>Function</b> To warn of a laser beam
	<b>Image content</b> Circle with twenty four regular equally spaced radiating lines, twelve shorter of equal length, eleven longer of equal length and one longer reaching horizontally the right hand side of the triangle
<b>Hazard</b> Laser beam	
<b>Human behaviour that is intended to be caused after understanding the safety sign's meaning</b> Taking care to avoid exposure to a laser beam	
<b>Related referents</b> ---	
<b>Additional information</b> Test data obtained according to ISO 9186-1:2007 are not available. Consequently, a supplementary text sign shall be used to increase comprehension except when the safety sign is supplemented by manuals, instructions or training.	


	<b>Reference No.</b> WSS005 (ISO 7010-W005)
	<b>Referent</b> Warning; Non-ionizing radiation
	<b>Function</b> To warn of non-ionizing radiation
	<b>Image content</b> Circle with two sets of three semi-circular lines each side of increasing length, ending in the same plane, triangular shaped rectangle under
<b>Hazard</b> Non-ionizing radiation	
<b>Human behaviour that is intended to be caused after understanding the safety sign's meaning</b> Taking care to avoid exposure to non-ionizing radiation	
<b>Related referents</b> ISO 7010-W003	
<b>Additional information</b> Test data obtained according to ISO 9186-1:2007 are not available. Consequently, a supplementary text sign shall be used to increase comprehension except when the safety sign is supplemented by manuals, instructions or training.	


	<b>Reference No.</b> WSS006 (ISO 7010-W006)
	<b>Referent</b> Warning; Magnetic field
	<b>Function</b> To warn of a magnetic field
	<b>Image content</b> Hoop with two outline sections at bottom, two lines in arc shapes each side of the outline section
<b>Hazard</b> Strong magnetic field	
<b>Human behaviour that is intended to be caused after understanding the safety sign's meaning</b> Taking care to avoid exposure to a strong magnetic field	
<b>Related referents</b> ---	
<b>Additional information</b> Test data obtained according to ISO 9186-1:2007 are not available. Consequently, a supplementary text sign shall be used to increase comprehension except when the safety sign is supplemented by manuals, instructions or training.	

	<b>Reference No.</b> WSS007 (ISO 7010-W007)
	<b>Referent</b> Warning; Floor level obstacle
	<b>Function</b> To warn of a floor level obstacle
	<b>Image content</b> Human figure falling forwards, thick horizontal line by forward leg
<b>Hazard</b> Floor level obstacle <b>Human behaviour that is intended to be caused after understanding the safety sign's meaning</b> Taking care when in the vicinity of a floor level obstacle <b>Related referents</b> ISO 7010-W008, ISO 7010-W011, ISO 7010-W020 <b>Additional information</b> Test data obtained according to ISO 9186-1:2007 are not available. Consequently, a supplementary text sign shall be used to increase comprehension except when the safety sign is supplemented by manuals, instructions or training.	


	<b>Reference No.</b> WSS008 (ISO 7010-W008)
	<b>Referent</b> Warning; Drop (fall)
	<b>Function</b> To warn of a drop
	<b>Image content</b> Human figure falling backwards from the edge of a surface
<b>Hazard</b> Drop <b>Human behaviour that is intended to be caused after understanding the safety sign's meaning</b> Taking care when in the vicinity of a drop <b>Related referents</b> ISO 7010-W007, ISO 7010-W011 <b>Additional information</b> Test data obtained according to ISO 9186-1:2007 are not available. Consequently, a supplementary text sign shall be used to increase comprehension except when the safety sign is supplemented by manuals, instructions or training.	

	<b>Reference No.</b> WSS009 (ISO 7010-W009)
	<b>Referent</b> Warning; Biological hazard
	<b>Function</b> To warn of a biological hazard
	<b>Image content</b> Circle with three equal overlaid pincer shaped circles
<b>Hazard</b> Virus or toxin	
<b>Human behaviour that is intended to be caused after understanding the safety sign's meaning</b> Taking care to avoid exposure to a biological hazard	
<b>Related referents</b> ---	
<b>Additional information</b> Test data obtained according to ISO 9186-1:2007 are not available. Consequently, a supplementary text sign shall be used to increase comprehension except when the safety sign is supplemented by manuals, instructions or training.	


	<b>Reference No.</b> WSS010 (ISO 7010-W010)
	<b>Referent</b> Warning; Low temperature/ freezing conditions
	<b>Function</b> To warn of low temperature or freezing conditions
	<b>Image content</b> Snow flake
<b>Hazard</b> Low temperature or freezing conditions <b>Human behaviour that is intended to be caused after understanding the safety sign's meaning</b> Taking care to avoid exposure to low temperature or freezing conditions <b>Related referents</b> --- <b>Additional information</b> Test data obtained according to ISO 9186-1:2007 are not available. Consequently, a supplementary text sign shall be used to increase comprehension except when the safety sign is supplemented by manuals, instructions or training.	


	<b>Reference No.</b> WSS011 (ISO 7010-W011)
	<b>Referent</b> Warning; Slippery surface
	<b>Function</b> To warn of a slippery surface
	<b>Image content</b> Human figure falling backwards, horizontal line underneath
<b>Hazard</b> Slippery surface <b>Human behaviour that is intended to be caused after understanding the safety sign's meaning</b> Taking care to avoid a slippery surface or, being aware of it, taking care to avoid slipping <b>Related referents</b> ISO 7010-W007, ISO 7010-W008 <b>Additional information</b> Test data obtained according to ISO 9186-1:2007 are not available. Consequently, a supplementary text sign shall be used to increase comprehension except when the safety sign is supplemented by manuals, instructions or training.	





	<b>Reference No.</b> WSS012 (ISO 7010-W012)
	<b>Referent</b> Warning; Electricity
	<b>Function</b> To warn of electricity
	<b>Image content</b> Lightning bolt
<b>Hazard</b> Electricity <b>Human behaviour that is intended to be caused after understanding the safety sign's meaning</b> Taking care to avoid coming into contact with electricity <b>Related referents</b> ISO 7010-M005, ISO 7010-M006 <b>Additional information</b> The graphical symbol is IEC 60417-5036 "Dangerous voltage". Test data obtained according to ISO 9186-1:2007 are not available. Consequently, a supplementary text sign shall be used to increase comprehension except when the safety sign is supplemented by manuals, instructions or training.	


	<b>Reference No.</b> WSS013 (ISO 7010-W013)
	<b>Referent</b> Warning; Guard dog
	<b>Function</b> To warn of a guard dog
	<b>Image content</b> Head of a dog (left hand profile) with collar
<b>Hazard</b> Guard dog	
<b>Human behaviour that is intended to be caused after understanding the safety sign's meaning</b> Not entering an area patrolled by a guard dog without ensuring that the dog is under control	
<b>Related referents</b> ISO 7010-P021	
<b>Additional information</b> Test data obtained according to ISO 9186-1:2007 are not available from more than one country. Findings from national testing, however, showed that in one country the graphical symbol did not reach the criteria of acceptability. Consequently, a supplementary text sign shall be used to increase comprehension except when the safety sign is supplemented by manuals, instructions or training.	


	<b>Reference No.</b> WSS014 (ISO 7010-W014)
	<b>Referent</b> Warning; Fork lift trucks and other industrial vehicles
	<b>Function</b> To warn of a fork lift truck and other industrial vehicles
	<b>Image content</b> Fork lift truck (left hand profile) with human figure
<b>Hazard</b> Moving fork lift trucks and other industrial vehicles <b>Human behaviour that is intended to be caused after understanding the safety sign's meaning</b> Taking care to avoid collision with moving fork lift trucks and other industrial vehicles <b>Related referents</b> ISO 7010-P006 <b>Additional information</b> Test data obtained according to ISO 9186-1:2007 are not available. Consequently, a supplementary text sign shall be used to increase comprehension except when the safety sign is supplemented by manuals, instructions or training.	

	<b>Reference No.</b> WSS015 (ISO 7010-W015)
	<b>Referent</b> Warning; Overhead load
	<b>Function</b> To warn of an overhead load
	<b>Image content</b> Box suspended at an angle from two ropes attached to a hook
<b>Hazard</b> Overhead load	
<b>Human behaviour that is intended to be caused after understanding the safety sign's meaning</b> Taking care to avoid being struck by or walking into an overhead load	
<b>Related referents</b> ISO 7010-W020	
<b>Additional information</b> Test data obtained according to ISO 9186-1:2007 are not available from more than one country. Findings from national testing, however, showed that in one country the graphical symbol did not reach the criteria of acceptability. Consequently, a supplementary text sign shall be used to increase comprehension except when the safety sign is supplemented by manuals, instructions or training.	


	<b>Reference No.</b> WSS016 (ISO 7010-W016)
	<b>Referent</b> Warning; Toxic material
	<b>Function</b> To warn of toxic material
	<b>Image content</b> Skull (outlined), behind it two crossed bones (outlined)
<b>Hazard</b> Poisoning <b>Human behaviour that is intended to be caused after understanding the safety sign's meaning</b> Taking care to avoid coming into contact with toxic material <b>Related referents</b> --- <b>Additional information</b> Test data obtained according to ISO 9186-1:2007 are not available. Consequently, a supplementary text sign shall be used to increase comprehension except when the safety sign is supplemented by manuals, instructions or training.	


	<b>Reference No.</b> WSS017 (ISO 7010-W017)
	<b>Referent</b> Warning; Hot surface
	<b>Function</b> To warn of a hot surface
	<b>Image content</b> Three parallel, vertical, s-shaped lines above a horizontal straight line
<b>Hazard</b> Hot surface	
<b>Human behaviour that is intended to be caused after understanding the safety sign's meaning</b> Taking care to avoid coming into contact with a hot surface	
<b>Related referents</b> ---	
<b>Additional information</b> Test data obtained according to ISO 9186-1:2007 are not available. Consequently, a supplementary text sign shall be used to increase comprehension except when the safety sign is supplemented by manuals, instructions or training.	

	<b>Reference No.</b> WSS018 (ISO 7010-W018)
	<b>Referent</b> Warning; Automatic start-up
	<b>Function</b> To warn of automatic activation
	<b>Image content</b> Circle with three connected curved lines
<b>Hazard</b> Automatically moving mechanical parts	
<b>Human behaviour that is intended to be caused after understanding the safety sign's meaning</b> Taking care when in the vicinity of machinery with moving mechanical parts which may start automatically and thus unexpectedly	
<b>Related referents</b> ---	
<b>Additional information</b> The graphical symbol is ISO 7000-0017 "Automatic control (closed loop)". Test data obtained according to ISO 9186-1:2007 are not available. Consequently, a supplementary text sign shall be used to increase comprehension except when the safety sign is supplemented by manuals, instructions or training.	

	<b>Reference No.</b> WSS019 (ISO 7010-W019)
	<b>Referent</b> Warning; Crushing
	<b>Function</b> To warn of moving mechanical parts
	<b>Image content</b> Human figure between two hatched bars; an arrow from the right side pointing to the right bar and an arrow from the left side pointing to the left bar
<b>Hazard</b> Mechanical parts which can come together in a crushing movement	
<b>Human behaviour that is intended to be caused after understanding the safety sign's meaning</b> Taking care to avoid mechanisms with parts which can come together in a crushing movement	
<b>Related referents</b> ---	
<b>Additional information</b> Test data obtained according to ISO 9186-1:2007 are not available. Consequently, a supplementary text sign shall be used to increase comprehension except when the safety sign is supplemented by manuals, instructions or training.	



	<b>Reference No.</b> WSS020 (ISO 7010-W020)
	<b>Referent</b> Warning; Overhead obstacle
	<b>Function</b> To warn of an overhead obstacle
	<b>Image content</b> Upper human figure underneath an overhead obstacle and star to indicate contact
<b>Hazard</b> Overhead obstacle	
<b>Human behaviour that is intended to be caused after understanding the safety sign's meaning</b> Taking care to avoid being struck or walking into an overhead obstacle	
<b>Related referents</b> ISO 7010-W007, ISO 7010-W015	
<b>Additional information</b> Test data obtained according to ISO 9186-1:2007 are not available. Consequently, a supplementary text sign shall be used to increase comprehension except when the safety sign is supplemented by manuals, instructions or training.	

	<b>Reference No.</b> WSS021 (ISO 7010-W021)
	<b>Referent</b> Warning; Flammable material
	<b>Function</b> To warn of flammable material
	<b>Image content</b> Flame, horizontal line underneath
<b>Hazard</b> Fire <b>Human behaviour that is intended to be caused after understanding the safety sign's meaning</b> Taking care to avoid causing a fire by igniting flammable material <b>Related referents</b> ISO 7010-P003, ISO 7010-P011 <b>Additional information</b> Test data obtained according to ISO 9186-1:2007 are not available. Consequently, a supplementary text sign shall be used to increase comprehension except when the safety sign is supplemented by manuals, instructions or training.	






	<b>Reference No.</b> WSS022 (ISO 7010-W022)
	<b>Referent</b> Warning; Sharp element
	<b>Function</b> To warn of a sharp element
	<b>Image content</b> Bandaged hand above a vertical line with a point
<b>Hazard</b> Sharp elements <b>Human behaviour that is intended to be caused after understanding the safety sign's meaning</b> Taking care to avoid injury from sharp elements (e.g. needles, blades) <b>Related referents</b> --- <b>Additional information</b> Test data obtained according to ISO 9186-1:2007 are not available from more than one country. Findings from national testing, however, showed that the graphical symbol did not reach the criteria of acceptability. Consequently, a supplementary text sign shall be used to increase comprehension except when the safety sign is supplemented by manuals, instructions or training.	


Table 10 — Mandatory action signs (MSS)

	<b>Reference No.</b> MSS001 (ISO 7010-M001)
	<b>Referent</b> General mandatory action sign
	<b>Function</b> To signify a mandatory action
	<b>Image content</b> Exclamation mark
<b>Hazard</b> Risk to people not following the mandatory action specified by the supplementary sign <b>Human behaviour that is intended to be caused after understanding the safety sign's meaning</b> Carrying out to the mandatory action specified by the supplementary sign <b>Related referents</b> ISO 7010-P001, ISO 7010-W001 <b>Additional information</b> This safety sign cannot be used on its own and requires a supplementary sign to give further information about the action to be taken.	


	<p><b>Reference No.</b>  <b>MSS002 (ISO 7010-M002)</b></p>
	<p><b>Referent</b>  <b>Refer to instruction manual/booklet</b></p>
	<p><b>Function</b>          To signify that the instruction manual/booklet must be read</p>
	<p><b>Image content</b>          Upper human figure (right hand profile) holding an open manual/booklet</p>
<p><b>Hazard</b>          Not reading the instruction manual/booklet before starting work and/or operating equipment or machinery</p> <p><b>Human behaviour that is intended to be caused after understanding the safety sign's meaning</b>          Reading the instruction manual/booklet before starting work and/or operating equipment or machinery</p> <p><b>Related referents</b>          ---</p> <p><b>Additional information</b>          Test data obtained according to ISO 9186-1:2007 are not available. Consequently, a supplementary text sign shall be used to increase comprehension except when the safety sign is supplemented by manuals, instructions or training.</p>	


	<b>Reference No.</b> MSS003 (ISO 7010-M003)
	<b>Referent</b> Wear ear protection
	<b>Function</b> To signify that ear protection must be worn
	<b>Image content</b> Human head (front view) wearing ear protection
<b>Hazard</b> Noise <b>Human behaviour that is intended to be caused after understanding the safety sign's meaning</b> Wearing ear protection <b>Related referents</b> --- <b>Additional information</b> Test data obtained according to ISO 9186-1:2007 are not available from more than one country. Findings from national testing, however, showed that in one country the graphical symbol exceeded the criteria of acceptability. A supplementary text sign may be used to increase comprehension. If the safety sign is supplemented by manuals, instructions or training, a supplementary text sign may not be required.	


	<b>Reference No.</b> <b>MSS004 (ISO 7010-M004)</b>
	<b>Referent</b> <b>Wear eye protection</b>
	<b>Function</b> To signify that eye protection must be used
	<b>Image content</b> Human head (front view) wearing eye protection
<b>Hazard</b> Flying objects/particles <b>Human behaviour that is intended to be caused after understanding the safety sign's meaning</b> Wearing eye protection <b>Related referents</b> ISO 7010-M007, ISO 7010-M013 <b>Additional information</b> Test data obtained according to ISO 9186-1:2007 are not available from more than one country. Findings from national testing, however, showed that in one country the graphical symbol exceeded the criteria of acceptability. A supplementary text sign may be used to increase comprehension. If the safety sign is supplemented by manuals, instructions or training, a supplementary text sign may not be required.	


	<b>Reference No.</b> MSS005 (ISO 7010-M005)
	<b>Referent</b> Connect an earth terminal to the ground
	<b>Function</b> To signify that an earth terminal must be connected
	<b>Image content</b> Vertical line joining horizontal line with two progressively shorter parallel horizontal lines underneath
<b>Hazard</b> Electric shock	
<b>Human behaviour that is intended to be caused after understanding the safety sign's meaning</b> Connecting an earth terminal of a product to the ground	
<b>Related referents</b> ISO 7010-W012	
<b>Additional information</b> This safety sign relates to products employing class I insulating system which requires protective earthing. Test data obtained according to ISO 9186-1:2007 are not available. Consequently, a supplementary text sign shall be used to increase comprehension except when the safety sign is supplemented by manuals, instructions or training.	





	<p><b>Reference No.</b>  <b>MSS006 (ISO 7010-M006)</b></p>
	<p><b>Referent</b>  <b>Disconnect mains plug from electrical outlet</b></p>
	<p><b>Function</b>          To signify that the mains plug must be disconnected from electrical outlet for the purposes of maintenance of electrical equipment, in the case of malfunction or when left unattended</p>
	<p><b>Image content</b>          Two fingers and thumb (outlined) holding two pin electrical plug, arrow pointing right, vertical line</p>
<p><b>Hazard</b>          Electric shock, fire</p> <p><b>Human behaviour that is intended to be caused after understanding the safety sign's meaning</b>          Disconnecting the mains plug before opening the electrical equipment for the purposes of maintenance, in the case of malfunction or when left unattended</p> <p><b>Related referents</b>          ISO 7010-W012</p> <p><b>Additional information</b>          Test data obtained according to ISO 9186-1:2007 are not available. Consequently, a supplementary text sign shall be used to increase comprehension except when the safety sign is supplemented by manuals, instructions or training.</p>	


	<b>Reference No.</b> MSS007 (ISO 7010-M007)
	<b>Referent</b> Opaque eye protection must be worn
	<b>Function</b> To signify that opaque eye protection must be worn
	<b>Image content</b> Human head (front view) wearing opaque eye protection
<b>Hazard</b> Visible or invisible rays	
<b>Human behaviour that is intended to be caused after understanding the safety sign's meaning</b> Responsible persons ensuring that the people undergoing treatment by visible or invisible rays are wearing opaque eye protection	
<b>Related referents</b> ISO 7010-M004, ISO 7010-M013, ISO 7010-M019	
<b>Additional information</b> Test data obtained according to ISO 9186-1:2007 are not available. Consequently, a supplementary text sign shall be used to increase comprehension except when the safety sign is supplemented by manuals, instructions or training.	


	<b>Reference No.</b> <b>MSS008 (ISO 7010-M008)</b>
	<b>Referent</b> <b>Wear safety footwear</b>
	<b>Function</b> To signify that safety footwear must be worn
	<b>Image content</b> Two safety boots, one shown in front, the other shown behind (outlined)
<b>Hazard</b> Feet striking or being struck by objects or being in contact with thermal or chemical materials <b>Human behaviour that is intended to be caused after understanding the safety sign's meaning</b> Wearing safety footwear <b>Related referents</b> --- <b>Additional information</b> Test data obtained according to ISO 9186-1:2007 are not available from more than one country. Findings from national testing, however, showed that in one country the graphical symbol exceeded the criteria of acceptability. A supplementary text sign may be used to increase comprehension. If the safety sign is supplemented by manuals, instructions or training, a supplementary text sign may not be required.	

	<b>Reference No.</b> MSS009 (ISO 7010-M009)
	<b>Referent</b> Wear protective gloves
	<b>Function</b> To signify that protective gloves must be worn
	<b>Image content</b> Two protective gloves, one shown in front, the other shown behind (outlined)
<b>Hazard</b> Hands striking or being struck by objects or being in contact with thermal or chemical materials	
<b>Human behaviour that is intended to be caused after understanding the safety sign's meaning</b> Wearing protective gloves	
<b>Related referents</b> ISO 7010-M022	
<b>Additional information</b> Test data obtained according to ISO 9186-1:2007 are not available from more than one country. Findings from national testing, however, showed that in one country the graphical symbol exceeded the criteria of acceptability. A supplementary text sign may be used to increase comprehension. If the safety sign is supplemented by manuals, instructions or training, a supplementary text sign may not be required.	


	<b>Reference No.</b> <b>MSS010 (ISO 7010-M010)</b>
	<b>Referent</b> <b>Wear protective clothing</b>
	<b>Function</b> To signify that protective clothing must be worn
	<b>Image content</b> Overall (front view)
<b>Hazard</b> Chemicals, heat or cold <b>Human behaviour that is intended to be caused after understanding the safety sign's meaning</b> Wearing protective clothing <b>Related referents</b> --- <b>Additional information</b> Test data obtained according to ISO 9186-1:2007 are not available. Consequently, a supplementary text sign shall be used to increase comprehension except when the safety sign is supplemented by manuals, instructions or training.	


	<b>Reference No.</b> MSS011 (ISO 7010-M011)
	<b>Referent</b> Wash your hands
	<b>Function</b> To signify that hands must be washed
	<b>Image content</b> Two hands, one shown in front, the other shown behind (outlined), three lines of three dashes, tap
<b>Hazard</b> Infection or contamination <b>Human behaviour that is intended to be caused after understanding the safety sign's meaning</b> Washing hands before starting work task and when having finished work task <b>Related referents</b> ISO 7010-M022 <b>Additional information</b> Test data obtained according to ISO 9186-1:2007 are not available. Consequently, a supplementary text sign shall be used to increase comprehension except when the safety sign is supplemented by manuals, instructions or training.	

	<b>Reference No.</b> MSS012 (ISO 7010-M012)
	<b>Referent</b> Use handrail
	<b>Function</b> To signify that the handrail must be used
	<b>Image content</b> Upper human figure with left arm touching diagonal line
<b>Hazard</b> Falling, slipping or tripping <b>Human behaviour that is intended to be caused after understanding the safety sign's meaning</b> Holding the handrail when using stairs, escalators or moving walkways <b>Related referents</b> --- <b>Additional information</b> Test data obtained according to ISO 9186-1:2007 are not available. Consequently, a supplementary text sign shall be used to increase comprehension except when the safety sign is supplemented by manuals, instructions or training.	


	<b>Reference No.</b> <b>MSS013 (ISO 7010-M013)</b>
	<b>Referent</b> <b>Wear face shield</b>
	<b>Function</b> To signify that face shield must be worn
	<b>Image content</b> Human head (left hand profile) wearing face shield
<b>Hazard</b> Flying objects/particles <b>Human behaviour that is intended to be caused after understanding the safety sign's meaning</b> Wearing face shield <b>Related referents</b> ISO 7010-M004, ISO 7010-M007, ISO 7010-M016, ISO 7010-M019 <b>Additional information</b> Test data obtained according to ISO 9186-1:2007 are not available from more than one country. Findings from national testing, however, showed that the graphical symbol did not reach the criteria of acceptability. Consequently, a supplementary text sign shall be used to increase comprehension except when the safety sign is supplemented by manuals, instructions or training.	





	<b>Reference No.</b> <b>MSS014 (ISO 7010-M014)</b>
	<b>Referent</b> <b>Wear head protection</b>
	<b>Function</b> To signify that head protection must be worn
	<b>Image content</b> Human head (left hand profile) wearing head protection
<b>Hazard</b> Objects falling on head or head striking objects <b>Human behaviour that is intended to be caused after understanding the safety sign's meaning</b> Wearing head protection <b>Related referents</b> --- <b>Additional information</b> Test data obtained according to ISO 9186-1:2007 are not available from more than one country. Findings from national testing, however, showed that in one country the graphical symbol exceeded the criteria of acceptability. Consequently, a supplementary text sign may be used to increase comprehension. If the safety sign is supplemented by manuals, instructions or training, a supplementary text sign may not be required.	


	<b>Reference No.</b> <b>MSS015 (ISO 7010-M015)</b>
	<b>Referent</b> <b>Wear high visibility clothing</b>
	<b>Function</b> To signify that high visibility clothing must be worn
	<b>Image content</b> Front view of a sleeveless jacket with two vertical and two horizontal line
<b>Hazard</b> Moving vehicles or equipment <b>Human behaviour that is intended to be caused after understanding the safety sign's meaning</b> Wearing high visibility clothing <b>Related referents</b> --- <b>Additional information</b> Test data obtained according to ISO 9186-1:2007 are not available. Consequently, a supplementary text sign shall be used to increase comprehension except when the safety sign is supplemented by manuals, instructions or training.	


	<b>Reference No.</b> <b>MSS016 (ISO 7010-M016)</b>
	<b>Referent</b> <b>Wear a mask</b>
	<b>Function</b> To signify that face mask must be worn
	<b>Image content</b> Human head (left hand profile) wearing a mask
<b>Hazard</b> Particulates in the air <b>Human behaviour that is intended to be caused after understanding the safety sign's meaning</b> Wearing face mask <b>Related referents</b> ISO 7010-M013, ISO 7010-M017 <b>Additional information</b> Test data obtained according to ISO 9186-1:2007 are not available from more than one country. Findings from national testing, however, showed that in one country the graphical symbol exceeded the criteria of acceptability. Consequently, a supplementary text sign may be used to increase comprehension. If the safety sign is supplemented by manuals, instructions or training, a supplementary text sign may not be required.	

	<b>Reference No.</b> MSS017 (ISO 7010-M017)
	<b>Referent</b> Wear respiratory protection
	<b>Function</b> To signify that respiratory protection must be worn
	<b>Image content</b> Human head (front view) wearing respiratory protection
<b>Hazard</b> Harmful substances (e.g. noxious gases)	
<b>Human behaviour that is intended to be caused after understanding the safety sign's meaning</b> Wearing respiratory protection	
<b>Related referents</b> ISO 7010-M016	
<b>Additional information</b> Test data obtained according to ISO 9186-1:2007 are not available from more than one country. Findings from national testing, however, showed that the graphical symbol did not reach the criteria of acceptability. Consequently, a supplementary text sign shall be used to increase comprehension except when the safety sign is supplemented by manuals, instructions or training.	

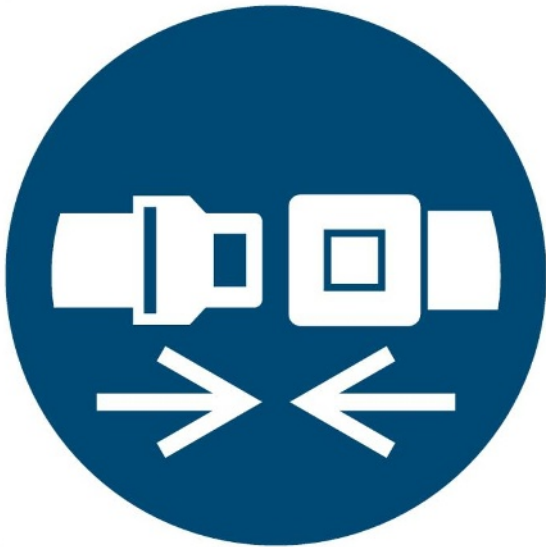
	<b>Reference No.</b> <b>MSS018 (ISO 7010-M018)</b>
	<b>Referent</b> <b>Wear safety harness</b>
	<b>Function</b> To signify that a safety harness must be worn
	<b>Image content</b> Human figure wearing a safety harness
<b>Hazard</b> Falling from a height <b>Human behaviour that is intended to be caused after understanding the safety sign's meaning</b> Wearing safety harness <b>Related referents</b> --- <b>Additional information</b> Test data obtained according to ISO 9186-1:2007 are not available from more than one country. Findings from national testing, however, showed that the graphical symbol did not reach the criteria of acceptability. Consequently, a supplementary text sign shall be used to increase comprehension except when the safety sign is supplemented by manuals, instructions or training.	


	<b>Reference No.</b> MSS019 (ISO 7010-M019)
	<b>Referent</b> Wear welding mask
	<b>Function</b> To signify that a welding mask must be worn
	<b>Image content</b> Human head (left hand profile) wearing a welding mask
<b>Hazard</b> Hot flying particles, intense light and UV radiation from welding activity	
<b>Human behaviour that is intended to be caused after understanding the safety sign's meaning</b> Wearing welding mask	
<b>Related referents</b> ISO 7010-M007, ISO 7010-M013	
<b>Additional information</b> Test data obtained according to ISO 9186-1:2007 are not available from more than one country. Findings from national testing, however, showed that in one country the graphical symbol exceeded the criteria of acceptability. Consequently, a supplementary text sign may be used to increase comprehension. If the safety sign is supplemented by manuals, instructions or training, a supplementary text sign may not be required.	

	<b>Reference No.</b> <b>MSS020 (ISO 7010-M022)</b>
	<b>Referent</b> <b>Use barrier cream</b>
	<b>Function</b> To signify that the skin has to be protected with an appropriate barrier cream
	<b>Image content</b> Human hand, tube, wavy line
<b>Hazard</b> Damage to the skin <b>Human behaviour that is intended to be caused after understanding the safety sign's meaning</b> Protecting the skin with barrier cream before starting work or putting on gloves <b>Related referents</b> ISO 7010-M009 <b>Additional information</b> Test data obtained according to ISO 9186-1:2007 are not available. Consequently, a supplementary text sign shall be used to increase comprehension except when the safety sign is supplemented by manuals, instructions or training.	

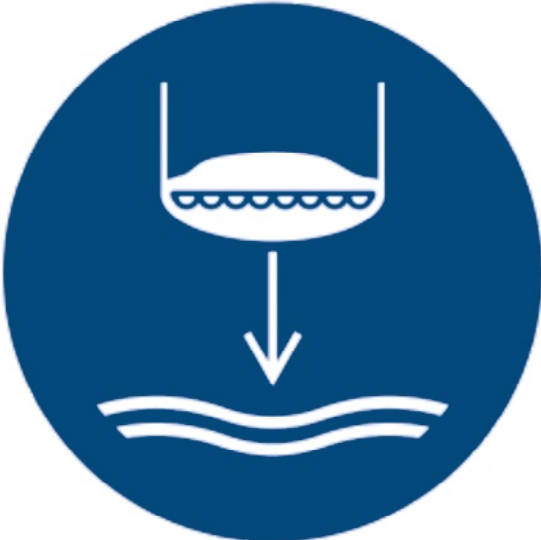
	<b>Reference No.</b> MSS021 (ISO 7010-M023)
	<b>Referent</b> Use footbridge
	<b>Function</b> To signify that a footbridge must be used
	<b>Image content</b> Human figure walking on a footbridge
<b>Hazard</b> Moving vehicles, obstructions, or tripping or falling <b>Human behaviour that is intended to be caused after understanding the safety sign's meaning</b> Using the footbridge to avoid dangerous areas <b>Related referents</b> --- <b>Additional information</b> Test data obtained according to ISO 9186-1:2007 are not available. Consequently, a supplementary text sign shall be used to increase comprehension except when the safety sign is supplemented by manuals, instructions or training.	





	<b>Reference No.</b> <b>MSS022 (ISO 7010-M020)</b>
	<b>Referent</b> <b>Wear safety belts</b>
	<b>Function</b> To signify that safety belts must be used
	<b>Image content</b> End of belts with a buckle and two arrows pointing to each other
<b>Hazard</b> Being projected from the seat of a vehicle, plant, lifeboat, or equipment <b>Human behaviour that is intended to be caused after understanding the safety sign's meaning</b> Wearing safety belts <b>Related referents</b> MSS023, MSS024, MSS025, MSS027, MSS028, MSS029, MSS030, MSS031 <b>Additional information</b> Test data obtained according to ISO 9186-1:2007 are not available. Consequently, a supplementary text sign shall be used to increase comprehension except when the safety sign is supplemented by manuals, instructions or training.	
<div style="background-color: #0056b3; color: white; padding: 5px; display: inline-block;">Fasten Seat belts</div>	


	<b>Reference No.</b> <b>MSS023 (ISO 7010 M037)</b>
	<b>Referent</b> <b>Close hatches</b>
	<b>Function</b> To signify hatches on a lifeboat, or fully enclosed rescue boat, must be closed
	<b>Image content</b> Stylized hand with four fingers around a hatch handle with arrow pointing to right above an arrow curving to clockwise
<b>Hazard</b> Hatches must be closed on a lifeboat or rescue boat to prevent the ingress of water and potentially maintain a secure internal environment in the case of an evacuation during a fire	
<b>Human behaviour that is intended to be caused after understanding the safety sign's meaning</b> Hatches will be closed at the appropriate time in the sequence of events during launch of a lifeboat or rescue boat.	
<b>Related referents</b> ISO 7010-M020, MSS025, MSS026, MSS028 through MSS032	
<b>Additional information</b> Test data obtained according to ISO 9186-1:2007 are not available. Consequently, a supplementary text sign shall be used to increase comprehension except when the safety sign is supplemented by manuals, instructions or training.	
<div style="background-color: #0056b3; color: white; padding: 5px; display: inline-block;">Close hatches</div>	


	<b>Reference No.</b> <b>MSS024 (ISO 7010 M038)</b>
	<b>Referent</b> <b>Start engine</b>
	<b>Function</b> To signify the location of the engine starter or to signify the lifeboat or rescue boat engine must be started
	<b>Image content</b> Handcrank and arrow curved in clockwise direction
<b>Hazard</b> No propulsion at the time of need.	
<b>Human behaviour that is intended to be caused after understanding the safety sign's meaning</b> The engine(s) will be started at the appropriate time in the sequence of events during launch of a lifeboat or rescue boat.	
<b>Related referents</b> ISO 7010-M020, MSS025, MSS026, MSS028 through MSS032	
<b>Additional information</b> Test data obtained according to ISO 9186-1:2007 are not available. Consequently, a supplementary text sign shall be used to increase comprehension except when the safety sign is supplemented by manuals, instructions or training.	
<div style="background-color: #0056b3; color: white; padding: 5px 20px; display: inline-block;">Start engine</div>	

	<b>Reference No.</b> <b>MSS025 (ISO 7010 M039)</b>
	<b>Referent</b> <b>Lower to the water (lifeboat)</b>
	<b>Function</b> To signify the lifeboat is to be lowered or the location of the control to lower lifeboat to the water
	<b>Image content</b> Lifeboat suspended on two falls above an arrow pointed downward above rippling water surface
<b>Hazard</b> The lifeboat is not lowered at the appropriate time <b>Human behaviour that is intended to be caused after understanding the safety sign's meaning</b> The lifeboat is lowered at the appropriate time <b>Related referents</b> MSS022, MSS023, MSS024, MSS028, MSS029, MSS030, MSS031 <b>Additional information</b> Test data obtained according to ISO 9186-1:2007 are not available. Consequently, a supplementary text sign shall be used to increase comprehension except when the safety sign is supplemented by manuals, instructions or training.	
<div style="background-color: #0056b3; color: white; padding: 5px; display: inline-block;"> <b>Lower to the water</b> </div>	


	<p><b>Reference No.</b>  <b>MSS026 (ISO 7010 M040)</b></p>
	<p><b>Referent</b>  <b>Lower to the water (liferaft)</b></p>
	<p><b>Function</b>          To signify a liferaft must be lowered or the location of the control to lower liferaft to the water</p>
	<p><b>Image content</b>          Liferaft on single fall above an arrow pointed downward above rippling water surface</p>
<p><b>Hazard</b>          A liferaft is not lowered at the appropriate time</p> <p><b>Human behaviour that is intended to be caused after understanding the safety sign's meaning</b>          A liferaft is lowered at the appropriate time</p> <p><b>Related referents</b>          MSS028</p> <p><b>Additional information</b>          Test data obtained according to ISO 9186-1:2007 are not available. Consequently, a supplementary text sign shall be used to increase comprehension except when the safety sign is supplemented by manuals, instructions or training.</p> <div style="border: 1px solid black; background-color: #0056b3; color: white; padding: 5px; display: inline-block; margin-top: 10px;"> <b>Lower to the water</b> </div>	

	<b>Reference No.</b> <b>MSS027 (ISO 7010 M041)</b>
	<b>Referent</b> <b>Lower to water (rescue boat)</b>
	<b>Function</b> To signify the rescue boat must be lowered or the location of the control to lower rescue boat to the water
	<b>Image content</b> Stylized rescue boat suspended on two falls with human figure pulling another figure from water with two rippling waves above an arrow pointed downward above rippling water surface
<b>Hazard</b> The rescue boat is not lowered to the water at the appropriate time <b>Human behaviour that is intended to be caused after understanding the safety sign's meaning</b> The rescue boat is lowered to the water at the appropriate time <b>Related referents</b> MSS024, MSS028 <b>Additional information</b> Test data obtained according to ISO 9186-1:2007 are not available. Consequently, a supplementary text sign shall be used to increase comprehension except when the safety sign is supplemented by manuals, instructions or training.	
<div style="background-color: #0056b3; color: white; padding: 5px; display: inline-block;"> <b>Lower to the water</b> </div>	

	<b>Reference No.</b>  <p style="text-align: center;"><b>MSS028 (ISO 7010 M042)</b></p>
	<b>Referent</b>  <p style="text-align: center;"><b>Release falls</b></p>
	<b>Function</b> <p>To signify the lifeboat or rescue boat falls are to be released or the location of the control to release falls</p>
	<b>Image content</b> <p>Hook on a pivot attached to a triangular frame superimposed over rippling water surface and below a fall ring partially out of frame; segmented arrow curving counterclockwise</p>
<p><b>Hazard</b></p> <p>The lifeboat or rescue boat release hook will not be released from the fall or falls</p> <p><b>Human behaviour that is intended to be caused after understanding the safety sign's meaning</b></p> <p>The lifeboat or rescue boat will be released from the fall or falls and so be detached from the ship</p> <p><b>Related referents</b></p> <p>MSS022, MSS023, MSS024, MSS025, MSS026, MSS027, MSS028, MSS029, MSS030, MSS031</p> <p><b>Additional information</b></p> <p>Test data obtained according to ISO 9186-1:2007 are not available. Consequently, a supplementary text sign shall be used to increase comprehension except when the safety sign is supplemented by manuals, instructions or training.</p> <div style="border: 1px solid black; background-color: #0056b3; color: white; padding: 5px; width: fit-content; margin-top: 10px;"> <p style="margin: 0;">Release falls</p> </div>	

	<b>Reference No.</b>  <b>MSS029 (ISO 7010 M043)</b>
	<b>Referent</b>  <b>Start water spray</b>
	<b>Function</b> To signify the water spray system for a lifeboat is to be energized or the location of the control to start water spray system
	<b>Image content</b> Nozzle with six lines of dots (5, 4, 3, 3, 4, 5) in a radial pattern above a stylized lifeboat
<b>Hazard</b> Fire	
<b>Human behaviour that is intended to be caused after understanding the safety sign's meaning</b> The water spray system is energized	
<b>Related referents</b> MSS022, MSS023, MSS024, MSS025, MSS028, MSS030, MSS031	
<b>Additional information</b> Test data obtained according to ISO 9186-1:2007 are not available. Consequently, a supplementary text sign shall be used to increase comprehension except when the safety sign is supplemented by manuals, instructions or training.	
<div style="background-color: #0056b3; color: white; padding: 5px; display: inline-block;">Start water spray</div>	



	<b>Reference No.</b>  <b>MSS030 (ISO 7010 M044)</b>
	<b>Referent</b>  <b>Start air supply</b>
	<b>Function</b> To signify the self-contained air support system is to be energized or the location of the control to start the air supply system
	<b>Image content</b> Stylized perspective view of a bellows with three arrows at the nozzle pointing away in a radial pattern
<b>Hazard</b> Fire or hazardous atmosphere  <b>Human behaviour that is intended to be caused after understanding the safety sign's meaning</b> The air supply is started inside the lifeboat.  <b>Related referents</b> MSS022, MSS023, MSS024, MSS025, MSS028, MSS029, MSS031  <b>Additional information</b> Test data obtained according to ISO 9186-1:2007 are not available. Consequently, a supplementary text sign shall be used to increase comprehension except when the safety sign is supplemented by manuals, instructions or training.	





	<b>Reference No.</b>  <b>MSS031 (ISO 7010 M045)</b>
	<b>Referent</b>  <b>Release lifeboat gripes</b>
	<b>Function</b> To signify the lifeboat gripes are to be released or the location of the control to release lifeboat gripes
	<b>Image content</b> Bow view of a lifeboat suspended on a fall in a davit with a stylized gripe surrounding the boat; segmented arrow pointing at the release point of the gripe
<b>Hazard</b> The gripes of a lifeboat fail to be released and the boat will not be detached from its launching appliance <b>Human behaviour that is intended to be caused after understanding the safety sign's meaning</b> The gripes of a lifeboat are released allowing the lifeboat to be lowered on its falls. <b>Related referents</b> MSS022, MSS023, MSS024, MSS025, MSS028, MSS029, MSS030 <b>Additional information</b> Test data obtained according to ISO 9186-1:2007 are not available. Consequently, a supplementary text sign shall be used to increase comprehension except when the safety sign is supplemented by manuals, instructions or training.	
<div style="background-color: #0056b3; color: white; padding: 5px; display: inline-block;"> <b>Release            lifeboat gripes</b> </div>	


Table 11 — Fire control plan signs (SIS)

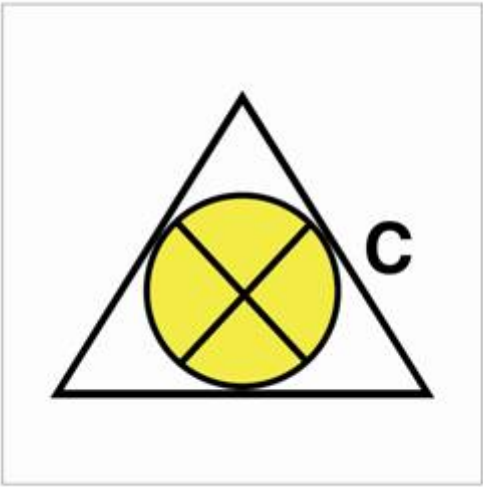
	<b>Sign Reference No.</b>  <p style="text-align: center;">SIS001</p>
	<b>Description</b>  <p style="text-align: center;">Fire control plan</p>
	<b>Function</b> To signify the location of the Fire control plan
	<b>Other references;</b> See figure A.2.1 ISO 17631
<b>Additional Information;</b>  Symbol to provide crewmembers and firefighters critical details on the location of fire fighting equipment and other systems than can be utilized to stop or reduce the spread of fire and smoke  Finding the location of a fire plan in the event of an emergency  <b>Related signs</b> --	

	<b>Sign Reference No.</b>  <p style="text-align: center;"><b>SIS002</b></p>
	<b>Description</b>  <p style="text-align: center;"><b>Safety Plan</b></p>
	<b>Function</b> To signify the location of a Safety plan
	<b>Other references;</b> See figure A.4.1 ISO 17631
<b>Additional information</b>  <p><b>Symbol to provide</b> crewmembers and firefighters critical details of the location of life-saving appliances and means of escape in the event of an emergency</p> <p><b>Related signs</b>          ---</p>	

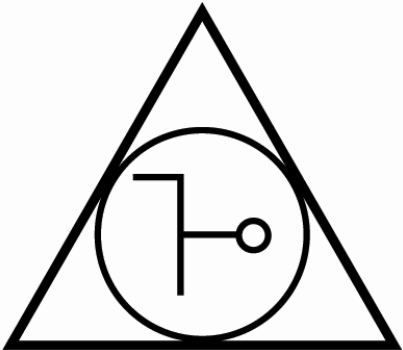
	<b>Sign Reference No.</b> <p style="text-align: center;">SIS003</p>
	<b>Description</b> <p style="text-align: center;">Fire &amp; Safety Plan</p>
	<b>Function</b> To signify the location of a Fire & Safety plan
	<b>Other references</b> See figures A2.1. & A.4.1 ISO 17631
<b>Additional information</b> <p><b>Symbol to provide</b> crewmembers and firefighters critical details within a combined view of the location of fire fighting equipment and other systems than can be utilized to stop or reduce the spread of fire and smoke plus the location of life-saving appliances and means of escape in the event of an emergency.</p> <p><b>Related Signs</b>          ---</p>	

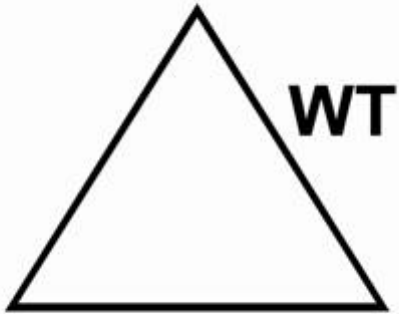
	<b>Sign Reference No.</b>  <p style="text-align: center;"><b>SIS004</b></p>
	<b>Description</b>  <p style="text-align: center;"><b>Ventilation remote control or shut off (Accommodation)</b></p>
	<b>Function</b> To signify the location of a accommodation ventilation remote control or shut off
	<b>Other references</b> See figure A.1.12 ISO 17631
<b>Additional information</b>  Symbol to provide crew members and firefighters with the location of an accommodation space ventilation remote control or shut off in the event of an emergency. Smoke and/or fire will spread faster if air handling systems are not shut down	
<b>Related Signs</b> ---	

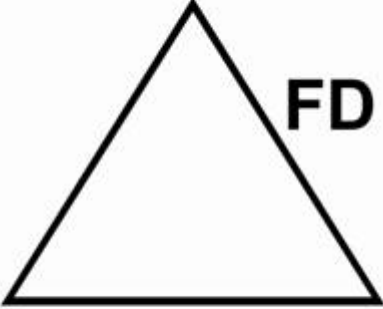
	<b>Sign Reference No.</b>  <p style="text-align: center;"><b>SIS005</b></p>
	<b>Description</b>  <p style="text-align: center;"><b>Ventilation remote control or shut off (Machinery)</b></p>
	<b>Function</b> To signify the location of a machinery ventilation remote control or shut off
	<b>Other references</b> See figure A.1.12 ISO 17631
<b>Additional information</b>  Symbol to provide crew members and firefighters with the location of a machinery space ventilation remote control or shut off in the event of an emergency. Smoke and/or fire will spread faster if air handling systems are not shut down.	
<b>Related Signs</b> ---	

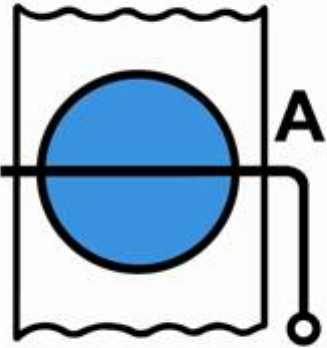
	<b>Sign Reference No.</b>  <p style="text-align: center;"><b>SIS006</b></p>
	<b>Description</b>  <p style="text-align: center;"><b>Ventilation remote control or shut off (Cargo)</b></p>
	<b>Function</b> To signify the location of a cargo ventilation remote control or shut off
	<b>Other references</b> See figure A.1.12 ISO 17631
<b>Additional information</b>  Symbol to provide crew members and firefighters with the location of a cargo space ventilation remote control or shut off in the event of an emergency. Smoke and/or fire will spread faster if air handling systems are not shut down	
<b>Related Signs</b> ---	

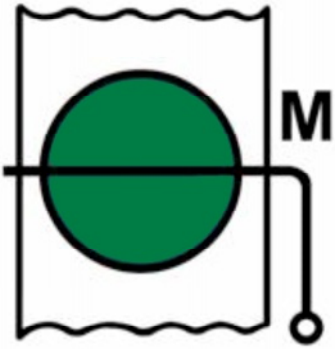


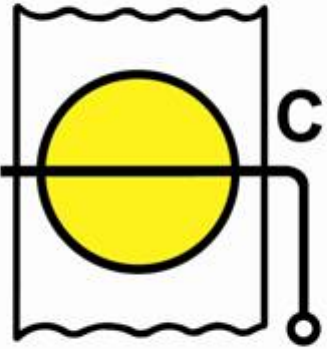
	<b>Sign Reference No.</b>  <p style="text-align: center;"><b>SIS007</b></p>
	<b>Description</b>  <p style="text-align: center;"><b>Remote control for skylight</b></p>
	<b>Function</b> To signify the location of a remote control for opening and closing a skylight
	<b>Other references</b> See A.1.13 of ISO 17631
<b>Additional information</b>  <p>Symbol to provide crew members and firefighters with the location of a remote control for a skylight in the event of an emergency. An open skylight may present a means for fire and smoke to spread as well as provide an air source for an existing fire</p>	
<b>Related signs</b> ---	

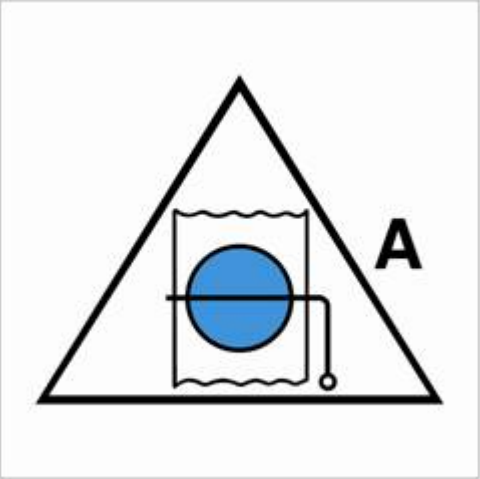
	<b>Sign Reference No.</b>  <p style="text-align: center;"><b>SIS008</b></p>
	<b>Description</b>  <p style="text-align: center;"><b>Remote control for water tight doors</b></p>
	<b>Function</b> To signify the location of a remote control for water tight doors
	<b>Other references</b> See figure A.1.14 ISO 17631
<b>Additional information</b>  <p>Symbol to provide crew members and firefighters with the location of a remote control for water tight doors in the event of an emergency. In the event of flooding, water tight doors left open would allow uncontrolled flooding to occur between watertight compartments severely comprising stability of the vessel. If flooding has already begun, crewmembers may not be able to safely or timely reach a watertight door to close it locally, therefore power operated watertight doors have a means to be operated remotely.</p>	
<b>Related signs</b> ---	

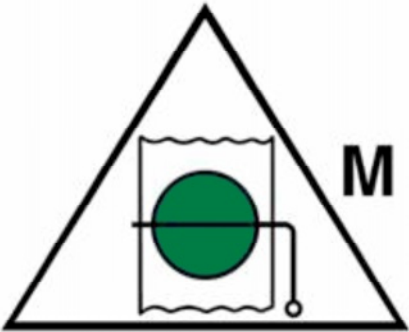
	<b>Sign Reference No.</b>  <p style="text-align: center;"><b>SIS009</b></p>
	<b>Description</b>  <p style="text-align: center;"><b>Remote control for fire doors</b></p>
	<b>Function</b> To signify the location of a remote control for fire doors
	<b>Other references</b>
<b>Additional information</b>  <p>Symbol to provide crew members and firefighters with the location of a remote control for fire doors in the event of an emergency. Fire and smoke will spread if fire doors are not closed in time increasing the risk of dangerous atmospheres and reduced visibility in the event of an evacuation. [In the event of fire and smoke, fire doors prevent their spread into adjoining zones. If a fire has started and there is significant chance of spreading, crewmembers may not be able to safely or timely reach a fire door to close it locally, therefore fire doors have a means to be closed remotely.]</p>	
<b>Relate signs</b> ---	

	<b>Sign Reference No.</b>  <p style="text-align: center;"><b>SIS010</b></p>
	<b>Description</b>  <p style="text-align: center;"><b>Fire damper (Accommodation)</b></p>
	<b>Function</b> To signify the location of a fire damper in a ventilation duct serving an accommodation space
	<b>Other references</b> See figure A.1.15 ISO 17631
<b>Additional information</b>  Symbol to provide crew members and firefighters with the location of a fire damper in a ventilation duct serving an accommodation space in the event of an emergency. Smoke and/or fire will spread faster if fire dampers are not closed	
<b>Related signs</b> ---	

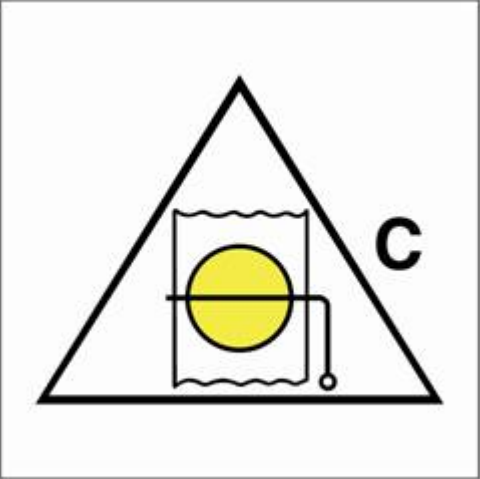
	<b>Sign Reference No.</b>  <p style="text-align: center;">SIS011</p>
	<b>Description</b>  <p style="text-align: center;">Fire damper (Machinery)</p>
	<b>Function</b> To signify the location of a fire damper in a ventilation duct serving a machinery space
	<b>Other references</b> See figure A.1.15 ISO 17631
<b>Additional information</b>  Symbol to provide crew members and firefighters with the location of a fire damper in a ventilation duct serving a machinery space in the event of an emergency. Smoke and/or fire will spread faster if fire dampers are not closed	
<b>Related signs</b> ---	

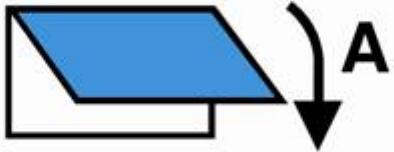
	<b>Sign Reference No.</b>  <p style="text-align: center;"><b>SIS012</b></p>
	<b>Description</b>  <p style="text-align: center;"><b>Fire damper (Cargo)</b></p>
	<b>Function</b> To signify the location of a fire damper in a ventilation duct serving a cargo space
	<b>Other references</b> See figure A.1.15 ISO 17631
<b>Additional information</b>  Symbol to provide crew members and firefighters with the location of a fire damper in a ventilation duct serving a cargo space in the event of an emergency. Smoke and/or fire will spread faster if fire dampers are not closed	
<b>Related signs</b> --- .	


	<p><b>Sign Reference No.</b></p> <p style="text-align: center;"><b>SIS013</b></p>
	<p><b>Description</b></p> <p>Remote control for Fire damper(s) (Accommodation)</p>
	<p><b>Function</b></p> <p>To signify the location of a remote control for a fire damper(s) (Accommodation)</p>
	<p><b>Other references</b></p> <p>See figure A.1.17 ISO 17631</p>
<p><b>Additional information</b></p> <p>Symbol to provide crew members and firefighters with the location of a remote control for a fire damper in a ventilation duct serving an accommodation space in the event of an emergency. Smoke and/or fire will spread faster if fire dampers are not closed</p> <p><b>Related signs</b></p> <p>---</p>	

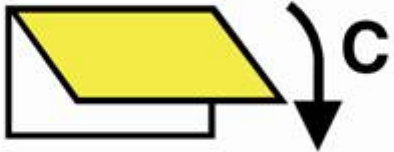
	<b>Sign Reference No.</b>  <p style="text-align: center;"><b>SIS-014</b></p>
	<b>Description</b>  <p style="text-align: center;"><b>Remote control for Fire damper(s) (Machinery)</b></p>
	<b>Function</b> To signify the location of a Fire damper(s) (Machinery)
	<b>Other references</b> See figure A.1.17 ISO 17631
<b>Additional information</b>  Symbol to provide crew members and firefighters with the location of a remote control for a fire damper in a ventilation duct serving a machinery space in the event of an emergency. Smoke and/or fire will spread faster if fire dampers are not closed	
<b>Related signs</b> ---	

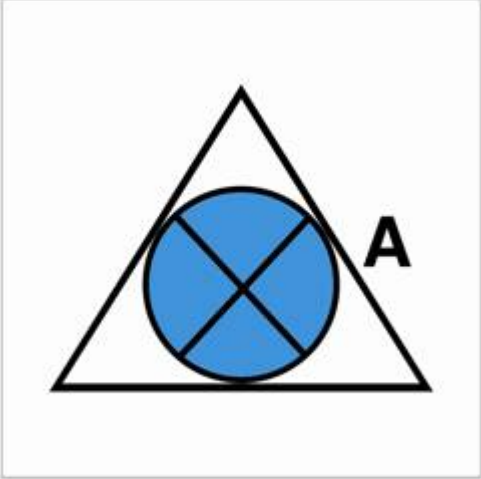


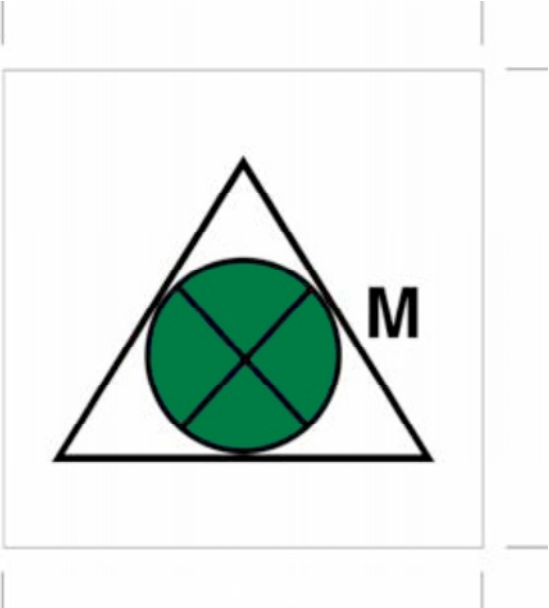
	<b>Sign Reference No.</b>  SIS-015
	<b>Description</b>  Remote control for Fire damper(s) (Cargo)
	<b>Function</b> To signify the location of a Fire damper(s) (Cargo)
	<b>Other references</b> See figure A.1.17 ISO 17631
<b>Additional information</b>  Symbol to provide crew members and firefighters with the location of a remote control for a fire damper in a ventilation duct serving a cargo space in the event of an emergency. Smoke and/or fire will spread faster if fire dampers are not closed	
<b>Related signs</b> ---	

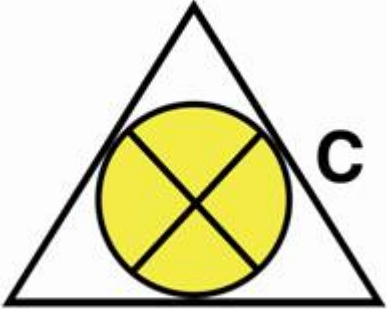
	<b>Sign Reference No.</b>  <p style="text-align: center;"><b>SIS-016</b></p>
	<b>Description</b>  <p style="text-align: center;"><b>Closing device for ventilation device inlet or outlet(Accommodation)</b></p>
	<b>Function</b> To signify the location of a Closing device for ventilation device inlet or outlet(Accommodation)
	<b>Other references</b> See figure A.1.16 ISO 17631
<b>Additional information</b>  Symbol to provide crew members and firefighters with the location of a ventilation inlet or outlet cover serving an accommodation space in the event of an emergency. Smoke and/or fire will spread faster if ventilation inlet or outlet covers are not closed	
<b>Related signs</b> ---	

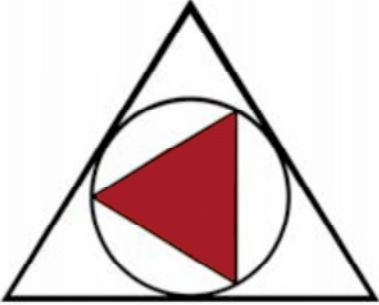
	<b>Sign Reference No.</b>  <p style="text-align: center;"><b>SIS-017</b></p>
	<b>Description</b>  <p style="text-align: center;"><b>Closing device for ventilation device inlet or outlet (Machinery)</b></p>
	<b>Function</b> To signify the location of a Closing device for ventilation device inlet or outlet(Machinery)
	<b>Other references</b> See figure A.1.16 ISO 17631
<b>Additional information</b>  Symbol to provide crew members and firefighters with the location of a ventilation inlet or outlet cover serving a machinery space in the event of an emergency. Smoke and/or fire will spread faster if ventilation inlet or outlet covers are not closed	
<b>Related signs</b> ---	

	<b>Sign Reference No.</b>  <p style="text-align: center;"><b>SIS-018</b></p>
	<b>Description</b>  <p style="text-align: center;"><b>Closing device for ventilation device inlet or outlet (Cargo)</b></p>
	<b>Function</b> To signify the location of a Closing device for ventilation device inlet or outlet(Cargo)
	<b>Other references</b> See figure A.1.16 ISO 17631
<b>Additional information</b>  Symbol to provide crew members and firefighters with the location of a ventilation inlet or outlet cover serving a cargo space in the event of an emergency. Smoke and/or fire will spread faster if ventilation inlet or outlet covers are not closed	
<b>Related signs</b> ---	

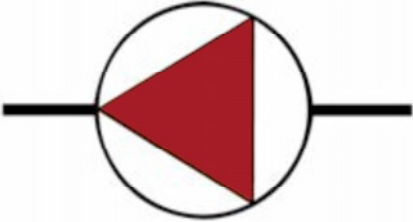
	<p><b>Sign Reference No.</b></p> <p>SIS-019</p>
	<p><b>Description</b></p> <p>Remote control closing device(s) for ventilation inlet and outlet (Accommodation)</p>
	<p><b>Function</b></p> <p>To signify the location of a remote control closing device(s) for ventilation inlet and outlet (Accommodation)</p>
	<p><b>Other references</b></p> <p>See figure A.1.12 ISO 17631</p>
<p><b>Additional information</b></p> <p>Symbol to provide crew members and firefighters with the location of a remote control for a ventilation inlet or outlet cover serving an accommodation space in the event of an emergency. Smoke and/or fire will spread faster if ventilation inlet or outlet covers are not closed.</p> <p><b>Related signs</b></p> <p>---</p>	

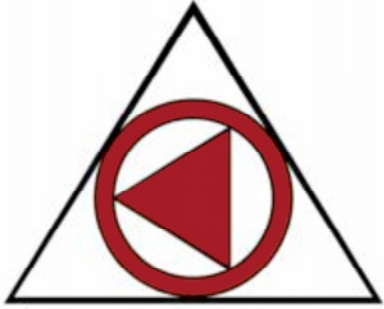
	<b>Sign Reference No.</b>  <p style="text-align: center;"><b>SIS-020</b></p>
	<b>Description</b>  <p style="text-align: center;"><b>Remote control closing device(s) for ventilation inlet and outlet(Machinery)</b></p>
	<b>Function</b> To signify the location of a Remote control closing device(s) for ventilation inlet and outlet (Machinery)
	<b>Other references</b> See figure A.1.12 ISO 17631
<b>Additional information</b>  Symbol to provide crew members and firefighters with the location of a remote control for a ventilation inlet or outlet cover serving a machinery space in the event of an emergency. Smoke and/or fire will spread faster if ventilation inlet or outlet covers are not closed	
<b>Related signs</b> ---	


	<b>Sign Reference No.</b>  <p style="text-align: center;">SIS-021</p>
	<b>Description</b>  <p style="text-align: center;"><b>Remote control closing device(s) for ventilation inlet and outlet(Cargo)</b></p>
	<b>Function</b> To signify the location of a Remote control closing device(s) for ventilation inlet and outlet (Cargo)
	<b>Other references</b> See figure A.1.12 ISO 17631
<b>Additional information</b>  <p>Symbol to provide crew members and firefighters with the location of a remote control for a ventilation inlet or outlet cover serving a cargo space in the event of an emergency.          Smoke and/or fire will spread faster if ventilation inlet or outlet covers are not closed.</p>	
<b>Related signs</b> ---	

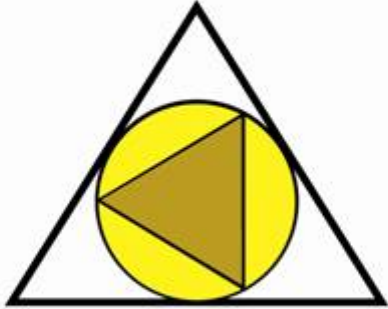
	<b>Sign Reference No.</b>  <p style="text-align: center;"><b>SIS-022</b></p>
	<b>Description</b>  <p style="text-align: center;"><b>Remote control for fire pumps</b></p>
	<b>Function</b> To signify the location of the Remote control for fire pumps
	<b>Other references</b> See figure A.2.2 ISO 17631
<b>Additional information</b>  Symbol to provide crew members and firefighters with the location of the remote control for fire pumps.	
<b>Related signs</b> ---	

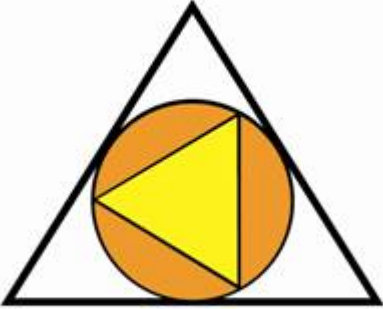


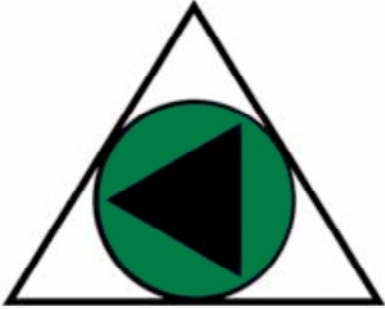
	<b>Sign Reference No.</b> <p style="text-align: center;">SIS-023</p>
	<b>Description</b> <p style="text-align: center;">Fire pump</p>
	<b>Function</b> To signify the location of the fire pump
	<b>Other references</b> See figure A.2.3 ISO 17631
<b>Additional information</b> <p>Symbol to provide crew members and firefighters with the location of the fire pump.</p> <p>This sign may be supplemented by text with supporting manuals, instructions and training as necessary</p>	
<b>Related signs</b> ---	

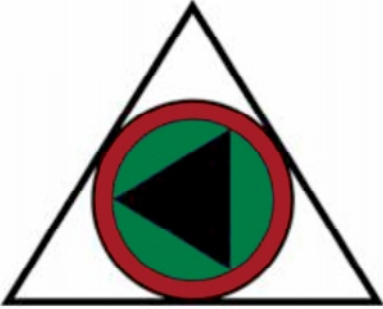
	<b>Sign Reference No.</b>  SIS-024
	<b>Description</b>  Emergency fire pump remote control
	<b>Function</b> To signify the location of the Emergency fire pump remote control
	<b>Other references</b> See figure A.2.4 ISO 17631
<b>Additional information</b>  Symbol to provide crew members and firefighters with the location of the remote control for the emergency fire pump	
<b>Related signs</b> ---	

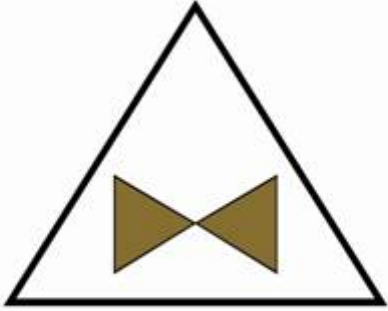
	<b>Sign Reference No.</b> SIS-025
	<b>Description</b> Emergency fire pump
	<b>Function</b> To signify the location of the Emergency Fire pump
	<b>Other references</b> See figure A.2.5 ISO 17631
<b>Additional information</b> Symbol to provide crew members and firefighters with the location of the emergency fire pump	
<b>Related signs</b> ---	

	<b>Sign Reference No.</b>  <p style="text-align: center;"><b>SIS-026</b></p>
	<b>Description</b>  <p style="text-align: center;"><b>Fuel pump(s) remote shut-off</b></p>
	<b>Function</b> To signify the location of the fuel pump remote shut-off
	<b>Other references</b> See figure A.2.6 ISO 17631
<b>Additional information</b>  Symbol to provide crew members and firefighters with the location of a fuel pump remote shut-off. Isolating fuel pumps in a machinery space is a critical function for reducing or eliminating the fuel source of a fire.	
<b>Related signs</b> ---	

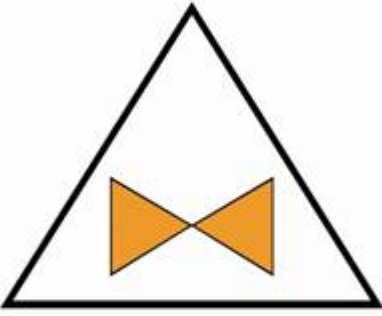
	<b>Sign Reference No.</b>  <p style="text-align: center;"><b>SIS-027</b></p>
	<b>Description</b>  <p><b>Lube oil pump remote shut-off</b></p>
	<b>Function</b> To signify the location of the Lube oil pump remote shut-off
	<b>Other references</b> See figure A.2.7 ISO 17631
<b>Additional information</b>  <p>Symbol to provide crew members and firefighters with the location of a lube oil pump remote shut-off. Isolating lube oil pumps in a machinery space is a critical function for reducing or eliminating the fuel source of a fire.</p>	
<b>Related signs</b> ---	

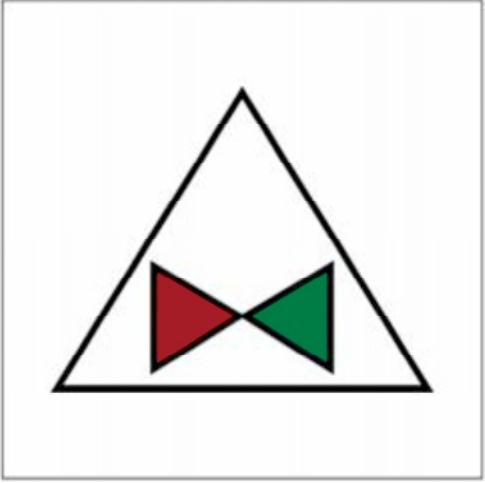
	<b>Sign Reference No.</b>  <p style="text-align: center;"><b>SIS-028</b></p>
	<b>Description</b>  <p style="text-align: center;"><b>Remote control for bilge pump(s)</b></p>
	<b>Function</b> To signify the location of the Bilge pump remote control
	<b>Other references</b> See figure A.2.8 ISO 17631
<b>Additional information</b>  Symbol to provide crew members and firefighters with the location of a bilge pump remote control. Flooding may not be controlled unless bilge pumps can be remotely operated.	
<b>Related signs</b> ---	

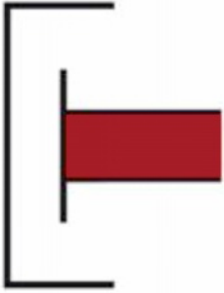
	<b>Sign Reference No.</b>  <p style="text-align: center;">SIS-029</p>
	<b>Description</b>  <p style="text-align: center;">Remote control for emergency bilge pump</p>
	<b>Function</b> To signify the location of the Emergency bilge pump remote control
	<b>Other references</b> See figure A.2.9 ISO 17631
<b>Additional information</b>  Symbol to provide crew members and firefighters with the location of the emergency bilge pump remote control. Flooding may not be controlled unless the emergency bilge pumps can be remotely operated; [emergency bilge pump may also be an emergency source of supply for firefighting water]	
<b>Related signs</b> ---	

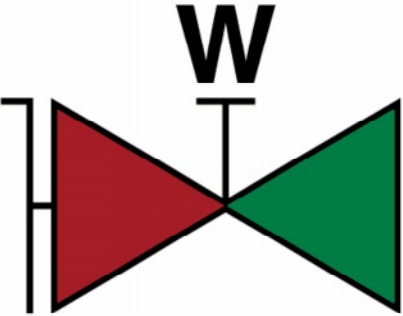
	<b>Sign Reference No.</b>  SIS-030
	<b>Description</b>  Remote control for fuel oil valves
	<b>Function</b> To signify the location of the fuel oil valve remote control
	<b>Other references</b> See figure A.2.10 ISO 17631
<b>Additional information</b>  Symbol to provide crew members and firefighters with the location of a fuel oil valve remote control. Isolating fuel oil valves in a machinery space is a critical function for reducing or eliminating the fuel source of a fire	
<b>Related signs</b> ---	

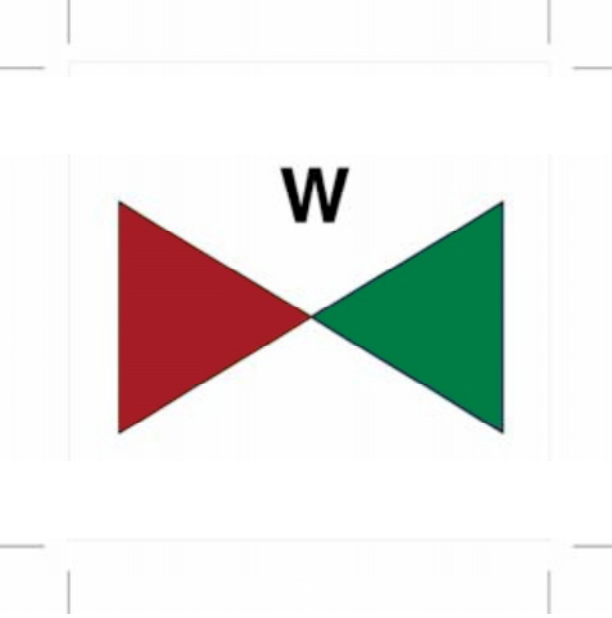


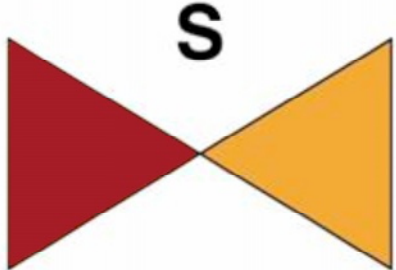
	<b>Sign Reference No.</b>  <p style="text-align: center;"><b>SIS-031</b></p>
	<b>Description</b>  <p style="text-align: center;"><b>Remote control for lube oil valves</b></p>
	<b>Function</b> To signify the location of the lube oil valve remote control
	<b>Other references</b> See figure A.2.11 ISO 17631
<b>Additional information</b>  Symbol to provide crew members and firefighters with the location of a lube oil valve remote control. Isolating lube oil valves in a machinery space is a critical function for reducing or eliminating the fuel source of a fire	
<b>Related signs</b> ---	

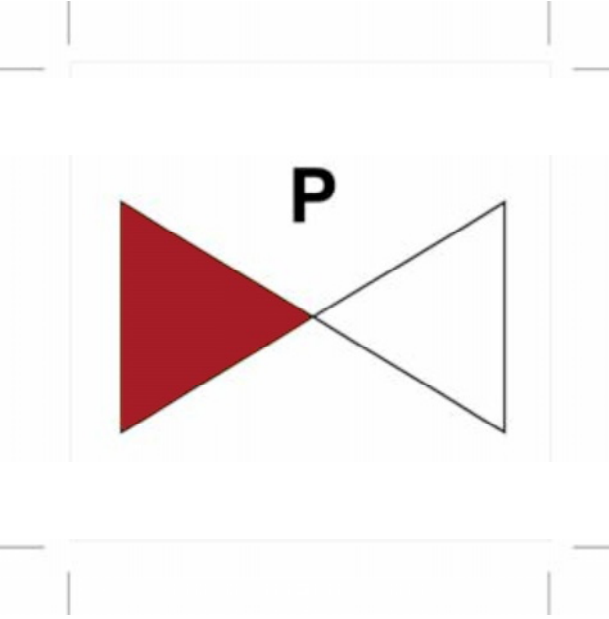
	<b>Sign Reference No.</b>  <p style="text-align: center;"><b>SIS-032</b></p>
	<b>Description</b>  <p style="text-align: center;"><b>Remote control for fire pump valves</b></p>
	<b>Function</b> To signify the location of the fire pump valve remote control
	<b>Other references</b> See figure A.2.12 ISO 17631
<b>Additional information</b>  Symbol to provide crew members and firefighters with the location of a fire pump valve remote control. Inability to locate remote closing/opening control of fire pump valves to supply firefighting water in an emergency	
<b>Related signs</b> ---	

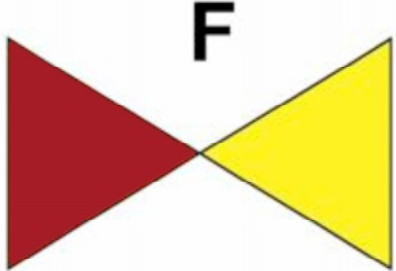
	<b>Sign Reference No.</b>  <p style="text-align: center;"><b>SIS-033</b></p>
	<b>Description</b>  <p style="text-align: center;"><b>International shore connection</b></p>
	<b>Function</b> To signify the location of an international shore connection
	<b>Other references</b> See figure A.2.14 ISO 17631
<b>Additional information</b>  <p>Symbol to provide crew members and firefighters with the location of the international shore connection. Inability of the crew or firefighters to find the international shore connection to supply firefighting water to the ship when the vessel is unable to supply its own</p>	
<b>Related signs</b> ---	

	<b>Sign Reference No.</b> <p style="text-align: center;">SIS-034</p>
	<b>Description</b> <p style="text-align: center;">Fire Hydrant</p>
	<b>Function</b> To signify the location of a fire hydrant
	<b>Other references</b> See figure A.2.15 ISO 17631
<b>Additional information</b> <p>Symbol to provide crew members and firefighters with the location of fire hydrant. Inability of the crew or firefighters to find a fire hydrant to fight a fire</p>	
<b>Related signs</b> ---	


	<b>Sign Reference No.</b> <p style="text-align: center;">SIS-035</p>
	<b>Description</b> <p style="text-align: center;">Fire main section valves</p>
	<b>Function</b> To signify the location of fire main section valves
	<b>Other references</b> See figure A.2.16 ISO 17631
<b>Additional information</b> <p>Symbol to provide crew members and firefighters with the location of fire main section valves. Inability of the crew to find fire main section valves and fight a fire.</p>	
<b>Related signs</b> ---	

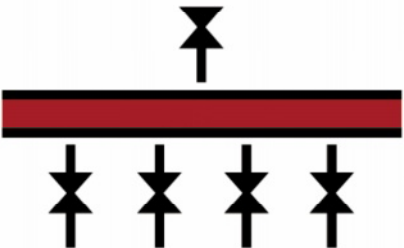
	<b>Sign Reference No.</b> <p style="text-align: center;">SIS-036</p>
	<b>Description</b> <p style="text-align: center;">Sprinkler section valves</p>
	<b>Function</b> To signify the location of sprinkler section valves
	<b>Other references</b> See figure A.2.17 ISO 17631
<b>Additional information</b> <p>Symbol to provide crew members and firefighters with the location of sprinkler section valves. Inability of the crew to find sprinkler section valves and fight a fire, or control water flow to, the section protected by the sprinklers</p>	
<b>Related signs</b> ---	


	<p><b>Sign Reference No.</b></p> <p>SIS-037</p>
	<p><b>Description</b></p> <p>Powder section valves</p>
	<p><b>Function</b></p> <p>To signify the location of powder section valves</p>
	<p><b>Other references</b></p> <p>See figure A.2.18 ISO 17631</p>
<p><b>Additional information</b></p> <p>Symbol to provide crew members and firefighters with the location of powder section valves. Inability of the crew to find powder section valves and fight a fire, or control flow to, the section protected by the powder</p> <p><b>Related signs</b></p> <p>---</p>	

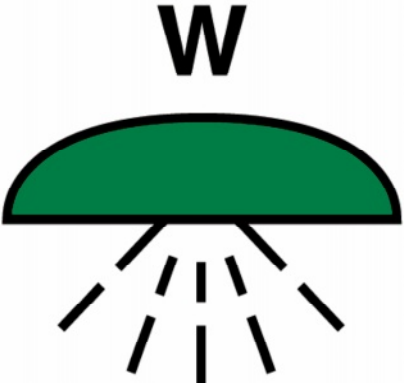
	<b>Sign Reference No.</b>  SIS-038
	<b>Description</b>  Foam section valves
	<b>Function</b> To signify the location of foam section valves
	<b>Other references</b> See figure A.2.19 ISO 17631
<b>Additional information</b>  Symbol to provide crew members and firefighters with the location of foam section valves. Inability of the crew to find foam section valves and fight a fire, or control flow to, the section protected by the foam	
<b>Related signs</b> ---	

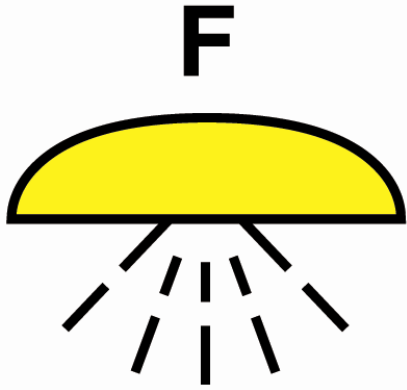


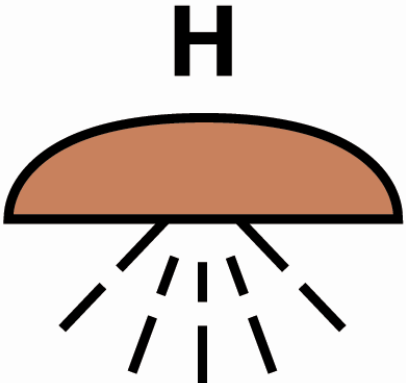
	<b>Sign Reference No.</b> <p style="text-align: center;">SIS-039</p>
	<b>Description</b> <p style="text-align: center;">High expansion foam supply trunk (outlet)</p>
	<b>Function</b> To signify the location of a high expansion foam supply trunk
	<b>Other references</b> see figure A.2.23 of ISO 17631
<b>Additional information</b> <p>Symbol to provide crew members and firefighters with the location of a foam supply trunk outlet. Inability of the crew to find a high expansion foam supply trunk (outlet) and fight a fire, or control flow to, the section protected by the foam</p>	
<b>Related signs</b> ---	

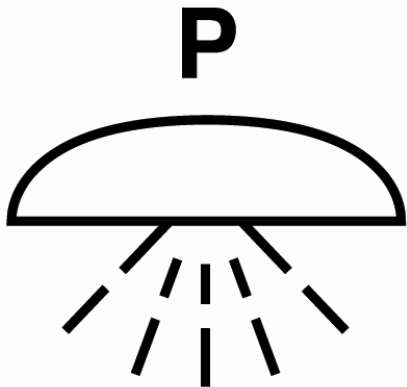
	<b>Sign Reference No.</b>  <p style="text-align: center;"><b>SIS-040</b></p>
	<b>Description</b>  <p style="text-align: center;"><b>Water spray system valves</b></p>
	<b>Function</b> To signify the location of water spray system valves
	<b>Other references</b> see figure A.2.24 of ISO 17631
<b>Additional information</b>  Symbol to provide crew members and firefighters with the location of water spray system valves. Inability of the crew to find water spray system valves and fight a fire, or control flow to, the section protected by the water spray  <b>Related signs</b> ---	

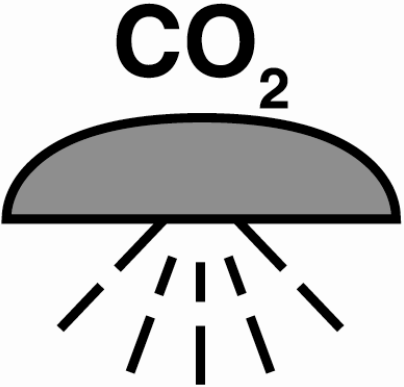
	<b>Sign Reference No.</b> <p style="text-align: center;">SIS-041</p>
	<b>Description</b> <p style="text-align: center;">Inert gas installation</p>
	<b>Function</b> To signify the area <i>containing</i> an inert gas installation
	<b>Other references</b> see figure A.2.25 of ISO 17631
<b>Additional information</b>  Symbol to provide crew members and firefighters with the location of an inert gas system. Inability of the crew to find an inert gas installation	
<b>Related signs</b> ---	

	<b>Sign Reference No.</b>  <p style="text-align: center;"><b>SIS-042</b></p>
	<b>Description</b>  <p style="text-align: center;"><b>Space or group of spaces protected by a water fire-extinguishing system</b></p>
	<b>Function</b> To signify the area protected by water fire-extinguishing system
	<b>Other references</b> See figure A.2.32 ISO 17631
<b>Additional information</b>  <p>Symbol to provide crew members and firefighters with the location of a space or group of spaces protected by a water fire-extinguishing system. Inability of the crew or firefighters to determine the extinguishing media used to protect a space or group of spaces which may lead to the inadvertent escape or release of the extinguishing media if the space or group of spaces are entered. May also cause a health hazard to personnel if the extinguishing media is released into manned spaces without appropriate personal protective equipment</p> <p>Indicate capacity (kg for gas and powder, litres for water and foam) at the top of the symbol. Add suffix "L" for fixed local application fire-fighting system.</p> <p><b>Related signs</b>          ---</p>	

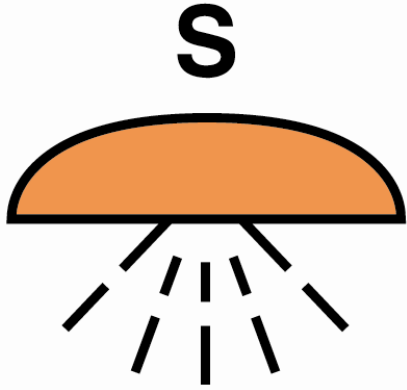
	<b>Sign Reference No.</b> <p style="text-align: center;">SIS-043</p>
	<b>Description</b> <p style="text-align: center;"><b>Space or group of spaces protected by a foam fire-extinguishing system</b></p>
	<b>Function</b> To signify the area protected by a foam fire-extinguishing system
	<b>Other references</b> See figure A.2.32 ISO 17631
<b>Additional information</b> <p>Symbol to provide crew members and firefighters with the location of a space or group of spaces protected by a foam fire-extinguishing system. Inability of the crew or firefighters to determine the extinguishing media used to protect a space or group of spaces which may lead to the inadvertent escape or release of the extinguishing media if the space or group of spaces are entered. May also cause a health hazard to personnel if the extinguishing media is released into manned spaces without appropriate personal protective equipment.</p> <p>Indicate capacity (kg for gas and powder, litres for water and foam) at the top of the symbol. Add suffix "L" for fixed local application fire-fighting system.</p> <p><b>Related signs</b>          ---</p>	


	<b>Sign Reference No.</b>  <p style="text-align: center;"><b>SIS-044</b></p>
	<b>Description</b>  <p style="text-align: center;"><b>Space or group of spaces protected by a gas other than CO<sub>2</sub> fire-extinguishing system</b></p>
	<b>Function</b> To signify the area protected by a gas (other than CO <sub>2</sub> ) fire-extinguishing system
	<b>Other references</b> See figure A.2.32 ISO 17631
<b>Additional information</b>  <p>Symbol to provide crew members and firefighters with the location of a space or group of spaces protected by a gas (other than carbon dioxide) fire-extinguishing system. Inability of the crew or firefighters to determine the extinguishing media used to protect a space or group of spaces which may lead to the inadvertent escape or release of the extinguishing media if the space or group of spaces are entered. May also cause a health hazard to personnel if the extinguishing media is released into manned spaces without appropriate personal protective equipment</p> <p>Indicate capacity (kg for gas and powder, litres for water and foam) at the top of the symbol. Add suffix "L" for fixed local application fire-fighting system.</p>	
<b>Related signs</b> ---	

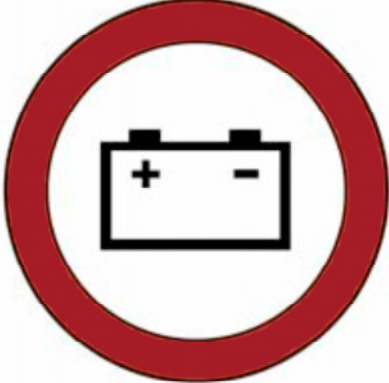
	<b>Sign Reference No.</b> <p style="text-align: center;">SIS-045</p>
	<b>Description</b> <p style="text-align: center;"><b>Space or group of spaces protected by a powder fire-extinguishing system</b></p>
	<b>Function</b> To signify the area protected by a powder fire-extinguishing system
	<b>Other references</b> See figure A.2.32 ISO 17631
<b>Additional information</b> <p>Symbol to provide crew members and firefighters with the location of a space or group of spaces protected by a powder fire-extinguishing system. Inability of the crew or firefighters to determine the extinguishing media used to protect a space or group of spaces which may lead to the inadvertent escape or release of the extinguishing media if the space or group of spaces are entered. May also cause a health hazard to personnel if the extinguishing media is released into manned spaces without appropriate personal protective equipment</p> <p>Indicate capacity (kg for gas and powder, litres for water and foam) at the top of the symbol. Add suffix "L" for fixed local application fire-fighting system.</p> <p><b>Related signs</b>          ---</p>	

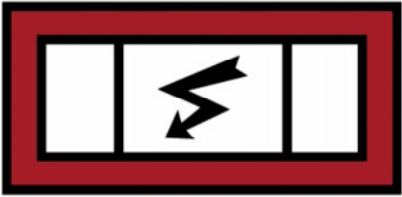
	<b>Sign Reference No.</b>  <p style="text-align: center;"><b>SIS-046</b></p>
	<b>Description</b>  <p style="text-align: center;"><b>Space or group of spaces protected by a CO<sub>2</sub> fire-extinguishing system</b></p>
	<b>Function</b> To signify the area protected by a CO <sub>2</sub> fire-extinguishing system
	<b>Other references</b> See figure A.2.32 ISO 17631
<b>Additional information</b>  <p>Symbol to provide crew members and firefighters with the location of a space or group of spaces protected by a CO<sub>2</sub> fire-extinguishing system. Inability of the crew or firefighters to determine the extinguishing media used to protect a space or group of spaces which may lead to the inadvertent escape or release of the extinguishing media if the space or group of spaces are entered. May also cause a health hazard to personnel if the extinguishing media is released into manned spaces without appropriate personal protective equipment</p> <p>Indicate capacity (kg for gas and powder, litres for water and foam) at the top of the symbol. Add suffix "L" for fixed local application fire-fighting system.</p> <p><b>Related signs</b>          ---</p>	

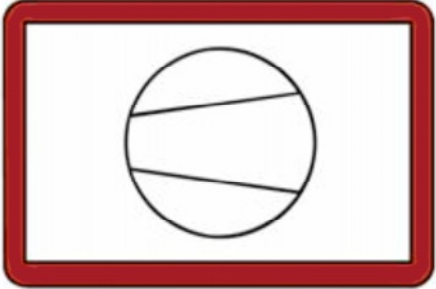


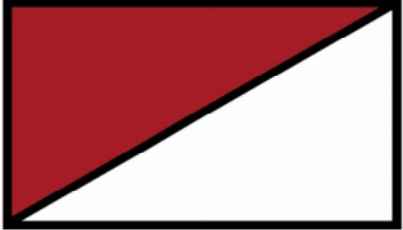
	<b>Sign Reference No.</b>  <p style="text-align: center;"><b>SIS-047</b></p>
	<b>Description</b>  <p style="text-align: center;"><b>Space or group of spaces protected by a  sprinkler or high-pressure water fire-  extinguishing system</b></p>
	<b>Function</b> To signify the area protected by a sprinkler or high- pressure water fire-extinguishing system
	<b>Other references</b> See figure A.2.32 ISO 17631
<b>Additional information</b>  <p>Symbol to provide crew members and firefighters with the location of a space or group of spaces protected by a sprinkler or high-pressure water fire-extinguishing system  Inability of the crew or firefighters to determine the extinguishing media used to protect a space or group of spaces which may lead to the inadvertent escape or release of the extinguishing media if the space or group of spaces are entered. May also cause a health hazard to personnel if the extinguishing media is released into manned spaces without appropriate personal protective equipment</p> <p>Indicate capacity (kg for gas and powder, litres for water and foam) at the top of the symbol. Add suffix "L" for fixed local application fire-fighting system.</p> <p><b>Related signs</b>  ---</p>	

	<b>Sign Reference No.</b> <p style="text-align: center;">SIS-048</p>
	<b>Description</b> <p style="text-align: center;">Emergency Generator</p>
	<b>Function</b> To signify the location of the emergency generator
	<b>Other references</b> 'See figure A.2.34 ISO 17631
<b>Additional information</b> <p>Symbol to provide crew members and firefighters with the location of the emergency generator. Knowing the location of the emergency generator is important for crew and firefighters to be able to not only energize or de-energize critical circuits on the emergency panel, but also start or stop the generator as needed</p>	
<b>Related signs</b> ---	

	<b>Sign Reference No.</b> <p style="text-align: center;">SIS-049</p>
	<b>Description</b> <p style="text-align: center;">Emergency Source of Power (battery)</p>
	<b>Function</b> To signify the location of the Emergency Source of Power from a battery or batteries
	<b>Other references</b> See figure A.2.35 ISO 17631
<b>Additional information</b> <p>Symbol to provide crew members and firefighters with the location of the Emergency Source of Power from batteries. Inability of the crew or firefighters to locate emergency batteries to isolate them for electrical safety or connect them to emergency circuits when needed</p>	
<b>Related signs</b> ---	

	<b>Sign Reference No.</b>  <p style="text-align: center;"><b>SIS-050</b></p>
	<b>Description</b>  <p style="text-align: center;"><b>Emergency switchboard</b></p>
	<b>Function</b> To signify the location of the emergency switchboard
	<b>Other references</b> see figure A.2.36 of ISO 17631
<b>Additional information</b>  <p>Symbol to provide crew members and firefighters with the location of the emergency switchboard. Inability of the crew or firefighters to locate the emergency switchboard to either isolate circuits for electrical safety or energize them in an emergency when needed</p>	
<b>Related signs</b> ---	

	<b>Sign Reference No.</b>  SIS-051
	<b>Description</b>  Air compressor for breathing devices
	<b>Function</b> To signify the location of an air compressor for breathing devices
	<b>Other references</b> See figure A.2.37 ISO 17631
<b>Additional information</b>  Symbol to provide crew members and firefighters with the location of the air compressor for breathing devices. Crew and/or firefighters will not be able to locate and generate air for breathing apparatuses during a fire	
<b>Related signs</b> ---	

	<b>Sign Reference No.</b>  SIS-052
	<b>Description</b>  Control panel for fire detection and alarm system
	<b>Function</b> To signify the location of the control panel for fire detection and alarm system
	<b>Other references</b> See figure A.2.38 ISO 17631
<b>Additional information</b>  Symbol to provide crew members and firefighters with the location of the fire detection and alarms panel. Crew and/or firefighters will not be able to locate the control panel for fire detection and alarms	
<b>Related signs</b> ---	

## Bibliography

- [1] IMO International Convention for the Safety of Life at Sea, 1974 (SOLAS 1974), as amended
- [2] IMO Resolution A.752(18) Guidelines for the evaluation, testing and application of low-location lighting on passenger ships
- [3] ISO 9186-1, *Graphical symbols — Test methods — Part 1: Method for testing comprehensibility*

---

---

**ICS 47.020.01**

Price based on 199 pages





# British Standards Institution (BSI)

BSI is the national body responsible for preparing British Standards and other standards-related publications, information and services.

BSI is incorporated by Royal Charter. British Standards and other standardization products are published by BSI Standards Limited.

## About us

We bring together business, industry, government, consumers, innovators and others to shape their combined experience and expertise into standards-based solutions.

The knowledge embodied in our standards has been carefully assembled in a dependable format and refined through our open consultation process. Organizations of all sizes and across all sectors choose standards to help them achieve their goals.

## Information on standards

We can provide you with the knowledge that your organization needs to succeed. Find out more about British Standards by visiting our website at [bsigroup.com/standards](http://bsigroup.com/standards) or contacting our Customer Services team or Knowledge Centre.

## Buying standards

You can buy and download PDF versions of BSI publications, including British and adopted European and international standards, through our website at [bsigroup.com/shop](http://bsigroup.com/shop), where hard copies can also be purchased.

If you need international and foreign standards from other Standards Development Organizations, hard copies can be ordered from our Customer Services team.

## Subscriptions

Our range of subscription services are designed to make using standards easier for you. For further information on our subscription products go to [bsigroup.com/subscriptions](http://bsigroup.com/subscriptions).

With **British Standards Online (BSOL)** you'll have instant access to over 55,000 British and adopted European and international standards from your desktop. It's available 24/7 and is refreshed daily so you'll always be up to date.

You can keep in touch with standards developments and receive substantial discounts on the purchase price of standards, both in single copy and subscription format, by becoming a **BSI Subscribing Member**.

**PLUS** is an updating service exclusive to BSI Subscribing Members. You will automatically receive the latest hard copy of your standards when they're revised or replaced.

To find out more about becoming a BSI Subscribing Member and the benefits of membership, please visit [bsigroup.com/shop](http://bsigroup.com/shop).

With a **Multi-User Network Licence (MUNL)** you are able to host standards publications on your intranet. Licences can cover as few or as many users as you wish. With updates supplied as soon as they're available, you can be sure your documentation is current. For further information, email [bsmusales@bsigroup.com](mailto:bsmusales@bsigroup.com).

## BSI Group Headquarters

389 Chiswick High Road London W4 4AL UK

## Revisions

Our British Standards and other publications are updated by amendment or revision.

We continually improve the quality of our products and services to benefit your business. If you find an inaccuracy or ambiguity within a British Standard or other BSI publication please inform the Knowledge Centre.

## Copyright

All the data, software and documentation set out in all British Standards and other BSI publications are the property of and copyrighted by BSI, or some person or entity that owns copyright in the information used (such as the international standardization bodies) and has formally licensed such information to BSI for commercial publication and use. Except as permitted under the Copyright, Designs and Patents Act 1988 no extract may be reproduced, stored in a retrieval system or transmitted in any form or by any means – electronic, photocopying, recording or otherwise – without prior written permission from BSI. Details and advice can be obtained from the Copyright & Licensing Department.

## Useful Contacts:

### Customer Services

**Tel:** +44 845 086 9001

**Email (orders):** [orders@bsigroup.com](mailto:orders@bsigroup.com)

**Email (enquiries):** [cservices@bsigroup.com](mailto:cservices@bsigroup.com)

### Subscriptions

**Tel:** +44 845 086 9001

**Email:** [subscriptions@bsigroup.com](mailto:subscriptions@bsigroup.com)

### Knowledge Centre

**Tel:** +44 20 8996 7004

**Email:** [knowledgecentre@bsigroup.com](mailto:knowledgecentre@bsigroup.com)

### Copyright & Licensing

**Tel:** +44 20 8996 7070

**Email:** [copyright@bsigroup.com](mailto:copyright@bsigroup.com)



...making excellence a habit.™