

BS ISO 22968:2010



BSI Standards Publication

Forced draught oil burners

NO COPYING WITHOUT BSI PERMISSION EXCEPT AS PERMITTED BY COPYRIGHT LAW

raising standards worldwide[™]

Copyright British Standards Institution
Provided by IHS under license with BSI - Uncontrolled Copy
No reproduction or networking permitted without license from IHS

Not for Resale



National foreword

This British Standard is the UK implementation of ISO 22968:2010.

The UK participation in its preparation was entrusted to Technical Committee GSE/27, Automatic gas and oil burners.

A list of organizations represented on this committee can be obtained on request to its secretary.

This publication does not purport to include all the necessary provisions of a contract. Users are responsible for its correct application.

© BSI 2010

ISBN 978 0 580 55430 8

ICS 27.060.10

Compliance with a British Standard cannot confer immunity from legal obligations.

This British Standard was published under the authority of the Standards Policy and Strategy Committee on 30 November 2010.

Amendments issued since publication

Date	Text affected
------	---------------

INTERNATIONAL STANDARD

BS ISO 22968:2010

ISO
22968

First edition
2010-11-01

Forced draught oil burners

Brûleurs à air soufflé pour combustibles liquides

Reference number
ISO 22968:2010(E)



© ISO 2010

PDF disclaimer

This PDF file may contain embedded typefaces. In accordance with Adobe's licensing policy, this file may be printed or viewed but shall not be edited unless the typefaces which are embedded are licensed to and installed on the computer performing the editing. In downloading this file, parties accept therein the responsibility of not infringing Adobe's licensing policy. The ISO Central Secretariat accepts no liability in this area.

Adobe is a trademark of Adobe Systems Incorporated.

Details of the software products used to create this PDF file can be found in the General Info relative to the file; the PDF-creation parameters were optimized for printing. Every care has been taken to ensure that the file is suitable for use by ISO member bodies. In the unlikely event that a problem relating to it is found, please inform the Central Secretariat at the address given below.



COPYRIGHT PROTECTED DOCUMENT

© ISO 2010

All rights reserved. Unless otherwise specified, no part of this publication may be reproduced or utilized in any form or by any means, electronic or mechanical, including photocopying and microfilm, without permission in writing from either ISO at the address below or ISO's member body in the country of the requester.

ISO copyright office
Case postale 56 • CH-1211 Geneva 20
Tel. + 41 22 749 01 11
Fax + 41 22 749 09 47
E-mail copyright@iso.org
Web www.iso.org

Published in Switzerland

Contents

Page

Foreword	v
Introduction.....	vi
1 Scope	1
2 Normative references	1
3 Terms and definitions	2
3.1 General	2
3.2 Fuel mass flow rate and performance.....	3
3.3 Test rig and combustion chamber.....	4
3.4 Composition of the gaseous combustion products	5
3.5 Adjustment, control and safety devices	6
3.6 Sequencing times.....	7
3.7 Diagrams	9
4 Classification of oil burners	9
4.1 General	9
4.2 Types of atomization.....	9
4.3 Automatic oil burner control methods	9
4.4 Means of ignition	10
5 Constructional and operational requirement	10
5.1 Construction and operation	10
5.2 Safety devices.....	20
5.3 Spurious light signals.....	22
5.4 Combustion.....	22
5.5 Combustion product quality.....	23
5.6 Combustion quality of the combustion products for other liquid fuels	24
5.7 Excess air ratio	24
5.8 Operational requirements.....	24
6 Test methods	26
6.1 General	26
6.2 Ambient test conditions.....	26
6.3 Combustion test chamber	26
6.4 Measuring equipment	34
6.5 Measuring accuracies	34
6.6 Test conditions	35
6.7 Test programme	36
6.8 Replacement of individual parts and equivalent components	43
6.9 Electrical safety	43
7 Conformity evaluation.....	44
8 Marking, labelling and packaging.....	44
8.1 General	44
8.2 Data plate	44
8.3 Other markings	44
8.4 Instructions for application, installation, commissioning, adjustment, maintenance and operation	45
8.5 Marking on the packaging	46
Annex A (normative) Smoke number.....	47
Annex B (normative) Emission measurements and corrections.....	48

Annex C (informative) Conversion factors 50

Annex D (normative) FID measuring method for recording the unburnt hydrocarbons 52

Annex E (informative) Conformity evaluation 53

Annex F (informative) Examples of equipping of burners 56

Annex G (informative) Additional recommendations for specific applications 60

Annex H (informative) Air-proving device check 62

Annex I (normative) Regional requirements specific to European countries 63

Annex J (normative) Requirements specific to Japan 64

Annex K (normative) Requirements specific to Australia 66

Annex L (normative) Requirements specific to Korea 67

Annex M (normative) Requirements specific to the USA 69

Annex N (informative) Electrical interfaces for burners 71

Bibliography 75

© ISO 2010 - All rights reserved

Foreword

ISO (the International Organization for Standardization) is a worldwide federation of national standards bodies (ISO member bodies). The work of preparing International Standards is normally carried out through ISO technical committees. Each member body interested in a subject for which a technical committee has been established has the right to be represented on that committee. International organizations, governmental and non-governmental, in liaison with ISO, also take part in the work. ISO collaborates closely with the International Electrotechnical Commission (IEC) on all matters of electrotechnical standardization.

International Standards are drafted in accordance with the rules given in the ISO/IEC Directives, Part 2.

The main task of technical committees is to prepare International Standards. Draft International Standards adopted by the technical committees are circulated to the member bodies for voting. Publication as an International Standard requires approval by at least 75 % of the member bodies casting a vote.

Attention is drawn to the possibility that some of the elements of this document may be the subject of patent rights. ISO shall not be held responsible for identifying any or all such patent rights.

ISO 22968 was prepared by Technical Committee ISO/TC 109, *Oil and gas burners*.

Introduction

This International Standard is primarily intended for application to automatic forced draught oil burners having a combustion air fan, operated with liquid fuels and intended to be marketed as a complete assembly.

Many burners are designed to operate using a wide range of fuel oils with little or no modification other than adjustment of the air supply.

When applying the requirements specific to a country or region, which are given in the various annexes, it is essential that a level of safety be ensured that is at least equivalent to that provided for by the requirements of the main body of this International Standard.

Forced draught oil burners

1 Scope

This International Standard specifies the terminology, test procedures and general requirements for the construction and operation of automatic forced draught oil burners supplied with a fuel having a viscosity at the burner inlet of 1,6 mm²/s (cSt) to 6 mm²/s (cSt) at 20 °C or higher, boiling petroleum in accordance with ISO 8217-based first raffinates, and the provision of related control and safety devices.

It is applicable to the following:

- a) automatic oil burners (hereinafter called “burners”) fitted with a combustion air fan and equipped as described in Clause 5, intended for use in appliances of different types and operated with fuel oils;
- b) single burners with a single combustion chamber, for which, where such burners are fitted to a single appliance, the requirements of the relevant appliance standard also apply;
- c) single-fuel and dual-fuel burners when operating only on oil;
- d) the oil function of dual-fuel burners designed to operate simultaneously on gaseous and liquid fuels, which, for the former, the requirements of ISO 22967 also apply.

It is not applicable to burners used in direct fired processes either with defined combustion chamber applications or where the combustion chamber wall surface temperature is greater than 750 °C or the heat-transfer medium temperature is greater than 500 °C.

2 Normative references

The following referenced documents are indispensable for the application of this document. For dated references only the edition cited applies. For undated references the latest edition of the referenced document (including any amendments) applies.

ISO 7-1, *Pipe threads where pressure-tight joints are made on the threads — Part 1: Dimensions, tolerances and designation*

ISO 228-1, *Pipe threads where pressure-tight joints are not made on the threads — Part 1: Dimensions, tolerances and designation*

ISO 1129, *Steel tubes for boilers, superheaters and heat exchangers — Dimensions, tolerances and conventional masses per unit length*

ISO 3183, *Petroleum and natural gas industries — Steel pipe for pipeline transportation systems*

ISO 6806, *Rubber hoses and hose assemblies for use in oil burners — Specification*

ISO 7005 (all parts), *Pipe flanges*

ISO 8217, *Petroleum products — Fuels (class F) — Specifications of marine fuels*

ISO 9329-1, *Seamless steel tubes for pressure purposes — Technical delivery conditions — Part 1: Unalloyed steels with specified room temperature properties*

ISO 9330-1, *Welded steel tubes for pressure purposes — Technical delivery conditions — Part 1: Unalloyed steel tubes with specified room temperature properties*

ISO/IEC 17025, *General requirements for the competence of testing and calibration laboratories*

ISO 22967, *Forced draught gas burners*

ISO 23550, *Safety and control devices for gas burners and gas-burning appliances — General requirements*

ISO 23552-1, *Safety and control devices for gas and/or oil burners and gas and/or oil appliances — Particular requirements — Part 1: Fuel/air ratio controls, electronic type*

ISO 23553-1, *Safety and control devices for oil burners and oil-burning appliances — Particular requirements — Part 1: Shut-off devices for oil burners*

IEC 60204-1, *Safety of machinery — Electrical equipment of machines — Part 1: General requirements*

IEC 60335-1:2001, *Household and similar electrical appliances — Safety — Part 1: General requirements, as amended 2004 and 2006*

IEC 60335-2-102:2004, *Household and similar electrical appliances — Safety — Part 2-102: Particular requirements for gas, oil and solid-fuel burning appliances having electrical connections*

IEC 60529, *Degrees of protection provided by enclosures (IP code)*

IEC 60730-2-5:2004, *Automatic electrical controls for household and similar use — Part 2-5: Particular requirements for automatic electrical burner control systems*

IEC 60747-5-2, *Discrete semiconductor devices and integrated circuits — Part 5-2: Optoelectronic devices — Essential ratings and characteristics*

IEC 60947-5-1, *Low-voltage switchgear and controlgear — Part 5-1: Control circuit devices and switching elements — Electromechanical control circuit devices*

IEC 61810-1, *Electromechanical elementary relays — Part 1: General requirements*

3 Terms and definitions

For the purposes of this document, the following terms and definitions apply.

3.1 General

3.1.1

forced draught burner

burner in which the total air for combustion is supplied by means of a fan

3.1.2

automatic forced draught burner

burner that is fitted with an automatic ignition, flame monitoring and burner control devices where the ignition, flame monitoring and the on/off switching of the burner occur automatically

NOTE The heat input of the burner can be adjusted during operation either automatically or manually.

3.1.3

dual-fuel burner

burner in which both gaseous and liquid fuels can be burnt either simultaneously or in succession

3.1.4

combustion chamber

part of the appliance in which the combustion takes place

3.1.5

burner head

device for mixing fuel and air comprising, for example, a stabilizing disc and nozzle, that keeps the flame in its safe position during operation of the burner

3.1.6

heat-transfer medium

gaseous or liquid substance for the transport of heat energy from the appliance

3.1.7

appliance

heat generator into which the burner fires having a combustion chamber and heat exchanger used to indirectly transmit the heat input from the burner combustion gases to the heat-transfer medium

3.2 Fuel mass flow rate and performance

3.2.1

mass flow rate

q_m

mass of oil consumed by the burner in unit time during continuous operation

NOTE It is expressed in kilograms per hour (kg/h) or grams per hour (g/h).

3.2.2

maximum mass flow rate

mass of fuel consumed during one hour at the highest mass flow rate stated by the manufacturer

NOTE It is expressed in kilograms per hour (kg/h).

3.2.3

minimum mass flow rate

mass of fuel consumed during one hour at the lowest mass flow rate stated by the manufacturer

NOTE It is expressed in kilograms per hour (kg/h).

3.2.4

calorific value

quantity of heat produced by the combustion, at a constant pressure equal to 0,101 325 MPa, of unit volume or mass of fuel oil, the constituents of the combustible mixture being taken at reference conditions and the products of combustion being brought back to the same conditions

NOTE 1 A distinction is made between

- the superior calorific value (H_s) in which the water produced by combustion is assumed to be condensed, and
- the inferior calorific value (H_i) in which the water produced by combustion is assumed to be in the vapour state.

NOTE 2 It is expressed in megajoules per kilogram (MJ/kg).

NOTE 3 See ISO 14532.

3.2.5
heat input

Q_F

amount of heat as a function of time released by the burner at a given mass flow rate

NOTE It is expressed in kilowatts (kW) and calculated as the oil flow rate \times lower calorific value ($q_{VO} H_i$) of the fuel.

3.2.6
maximum heat input

Q_{Fmax}

maximum heat input of the burner as stated by the manufacturer

NOTE It is expressed in kilowatts (kW).

3.2.7
minimum heat input

Q_{Fmin}

minimum heat input of the burner as stated by the manufacturer

NOTE It is expressed in kilowatts (kW).

3.2.8
start heat input

Q_s

maximum heat input at the start of ignition as a percentage of heat input (Q_F)

3.2.9
nominal heat input

Q_{FN}

value of the heat input declared by the manufacturer

NOTE 1 It is expressed in kilowatts (kW).

NOTE 2 Fixed heat input or range-rated burners have a single nominal heat input. Range-rated burners can be adjusted between the maximum nominal heat input and the minimum nominal heat input declared by the manufacturer.

3.2.10
heat load rate

ratio between heat input (Q_F) and volume or cross-sectional area of the combustion chamber

NOTE It may be expressed in kilowatt hours per cubic metre (kWh/m³) or per square metre (kWh/m²).

3.2.11
turndown rate

ratio between maximum heat input (Q_{Fmax}) and minimum heat input (Q_{Fmin})

3.3 Test rig and combustion chamber

3.3.1
combustion chamber pressure

p_F

effective positive pressure or negative pressure relative to the atmospheric pressure prevailing in the combustion chamber

NOTE Combustion chamber pressure is measured in kilopascals (kPa).

3.3.2

length of the combustion chamber

l_1

distance between the face of the nozzle or the fuel outlet and the rear wall of the test flame tube or combustion chamber or any lateral contraction

NOTE The length of the combustion chamber is measured in metres (m).

3.3.3

diameter of the combustion chamber

d_1

inner diameter of the combustion chamber around the flame tube of the burner

NOTE The diameter of the combustion chamber is measured in metres (m).

3.3.4

burner flame tube

device which hosts the mixing device and the root of the flame

3.3.5

test flame tube

cylindrical part of the test rig where the combustion takes place

3.4 Composition of the gaseous combustion products

3.4.1

content of carbon dioxide

CO_2

ratio of the volume of carbon dioxide to the total volume of dry gaseous products in which it is present

NOTE The carbon dioxide content is expressed as a percentage volume fraction.

3.4.2

content of oxygen

O_2

ratio of the volume of oxygen to the total volume of dry gaseous products in which it is present

NOTE The oxygen content is expressed as a percentage volume fraction.

3.4.3

content of carbon monoxide

CO

ratio of the volume of carbon monoxide to the total volume of dry gaseous products in which it is present

NOTE The carbon monoxide content is expressed as a volume fraction, in units of millilitres per cubic metre (ml/m^3) for measuring purposes and in milligrams per kilowatt hour (mg/kWh) related to inferior calorific value (H_i) for calculation purposes and declaring values.

3.4.4

content of nitrogen oxides

NO_x

ratio of the combined volume of nitrogen oxides to the total volume of dry gaseous products in which they are present

NOTE The nitrogen oxides content is expressed as a volume fraction, in units of millilitres per cubic metre (ml/m^3) for measuring purposes and in milligrams per kilowatt hour (mg/kWh) related to inferior calorific value (H_i) for calculation purposes and declaring values.

3.4.5

content of unburnt hydrocarbons

ratio of the volume of unburnt hydrocarbons to the total volume of dry gaseous products in which they are present

NOTE It is expressed in millilitres per cubic metre (ml/m³), calculated as C₃H₈.

3.4.6

smoke number

sample reference whose shade is closest to that of the test mark

NOTE See Annex A.

3.4.7

excess air ratio

λ
ratio between the effectively introduced quantity of air and the theoretically required quantity of air

3.5 Adjustment, control and safety devices

3.5.1

flame detector device

device by which the presence of a flame is detected and signalled

NOTE It can consist of a flame sensor, an amplifier and an element for signal transmission. These parts, with the possible exception of the actual flame sensor, may be assembled in a single housing for use in conjunction with a programming unit.

3.5.2

automatic burner control system

system comprising at least a programming unit and all the elements of a flame detector device

NOTE The various functions of an automatic burner control system may be in one or more housings.

3.5.3

programming unit

unit that reacts to signals from control and safety devices, gives control commands, controls the start-up sequence, supervises the burner operation and causes controlled shut-down and, if necessary, safety shut-down and non-volatile lock-out

NOTE The programming unit follows a predetermined sequence of actions and always operates in conjunction with a flame detector device.

3.5.4

safe start check

procedure employing a protection circuit or circuits to establish whether or not a fault in a safety system or flame simulating condition exists prior to start-up

3.5.5

controlled shut-down

process by which the power to the fuel shut-off valve(s) is immediately removed before any other action takes place (e.g. as a result of activating a controlling function)

3.5.6

safety shut-down

process that is effected immediately following the response of a safety limiter or the detection of a fault in the automatic burner control system and which puts the burner out of operation by immediately removing the power to the fuel shut-off valve(s) and the ignition device

NOTE Safety shut-down can also occur as a result of an interruption/decrease of the power supply.

3.5.7

non-volatile lock-out

safety shut-down condition of the system, such that a restart can only be accomplished by a manual reset of the system and by no other means

3.5.8

safety shut-off device

device that opens and that is held open by auxiliary energy and that closes by interruption or failure of the auxiliary energy that automatically cuts off the fuel supply

3.5.9

reignition

operation by which the fuel is reignited after the extinction of the flame during operation without the fuel supply being interrupted

3.5.10

recycling

process by which, after a safety shut-down, a full start-up sequence is automatically repeated

3.5.11

pressure switch

switch that compares the actual value of a pressure with the desired value, gives a signal when the actual value exceeds or drops below the desired value and initiates the shut-off sequence

3.5.12

ignition device

any means used to ignite the fuel at the ignition burner or at the main burner

EXAMPLE Flame, electrical ignition.

3.5.13

pressure monitoring device

device which monitors the actual value of a pressure and compares with the desired value, giving a signal when the actual value deviates from the desired value by a predetermined amount

3.5.14

output regulator

component on the burner intended to be used for adjusting the heat input, within a range of heat inputs stated by the manufacturer, to suit actual heat requirements of the installation

NOTE This adjustment may be progressive or in discrete steps.

3.6 Sequencing times

3.6.1

total ignition time

period during which the ignition device is in operation

NOTE 1 Pre-ignition, ignition and post-ignition times make up the total ignition time.

NOTE 2 It is expressed in seconds (s).

3.6.2

pre-ignition time

period between the start of the ignition cycle and the release of the fuel

NOTE It is expressed in seconds (s).

3.6.3

ignition time

period between the release of the fuel and the first indication of the flame by the flame detector device

NOTE It is expressed in seconds (s).

3.6.4

post-ignition time

period between the first indication of the flame by the flame detector device and the ignition device shut-off

NOTE It is expressed in seconds (s).

3.6.5

safety time

t_s

duration of the maximum permissible time during which the burner control unit allows the fuel to be released without there being a flame

NOTE It is expressed in seconds (s).

3.6.6

ignition safety time

period starting from the signal for release of the fuel and terminating at the moment at which the signal for interrupting the fuel supply is given

NOTE It is expressed in seconds (s).

3.6.7

flame extinction safety time

period that starts with the signal that the flame has been extinguished and ends with the signal to de-energize the safety shut-off valve of the oil supply

NOTE It is expressed in seconds (s).

3.6.8

purge time

period during which the combustion chamber is compulsorily ventilated without any fuel being supplied

NOTE It is expressed in seconds (s).

3.6.9

pre-purge time

period during which purging takes place at the proven air rate prior to energizing of the safety shut-off device

NOTE It is expressed in seconds (s).

3.6.10

post-purge time

period between any shut-down and the moment the fan is switched off

NOTE It is expressed in seconds (s).

3.6.11

flame simulation

signal indicating the existence of a flame when no flame is actually present

3.6.12

operational state

state commencing with the presence of a flame after the permissible ignition safety time has expired

NOTE It is the end of the starting process. Starting can, however, be considered not to have taken place if the fuel release is not authorized or if it is interrupted after expiry of the safety time by the lock-out of the burner control unit.

3.6.13

intermittent operation

state of operation whose duration does not exceed 24 h

3.6.14

continuous operation

state of operation whose duration exceeds 24 h

3.7 Diagrams

3.7.1

working diagram

admissible range of application of the burner (pressure in the combustion chamber as a function of fuel flow)

3.7.2

test diagram

test range of the burner during the tests (pressure in the combustion chamber as a function of fuel flow)

4 Classification of oil burners

4.1 General

Oil burners are classified according to their

- type of atomization,
- method of control, and
- means of ignition.

4.2 Types of atomization

4.2.1 Mechanical atomization by pressurization of the combustion liquid

Atomization of the fuel is obtained by means of an atomizing nozzle, through pressure release.

4.2.2 Atomization by auxiliary fluid

Atomization is obtained by the fuel flow meeting a flow of air, steam, other gas or any other fluid.

This type of burner particularly includes

- emulsion burners, in which there is prior mixing of the fuel with the atomizing fluid, and
- rotary cup burners, in which atomization of the fuel is obtained when the fuel leaves the edge of a rotating cup and meets an auxiliary fluid.

Burners having other means of atomization are allowed if they comply with all other requirements and test conditions of this International Standard.

4.3 Automatic oil burner control methods

4.3.1 On-off control (single-stage burner)

This controls whether the oil burner is either in operation at constant mass flow rate or is switched off.

4.3.2 Multi-stage control (two- and multi-stage burner)

This type of control provides several firing stages (steps) for operation. Oil burners with only two firing rates are included in this category.

4.3.3 Modulating control (modulating burner)

This type of control provides infinite variation of the mass flow rate between the lower and the upper limits.

4.4 Means of ignition

4.4.1 Automatic electric ignition

4.4.1.1 General

These are systems in which the ignition of the fuel is brought about by means of electrical energy.

4.4.1.2 Ignition by controlled spark

In this system, fuel is released when the presence of the ignition spark has been proven.

4.4.1.3 Ignition by non-controlled spark

In this system, fuel may be released when the ignition spark is not controlled.

4.4.2 Automatic ignition with liquid or gaseous fuels

4.4.2.1 General

These are systems in which an ignition burner, using a liquid or gaseous fuel, ignites the main fuel. The operation of the ignition burner may be either permanent or intermittent. Permanent ignition burners may be started manually, whereas intermittent ignition burners start automatically.

4.4.2.2 Ignition by controlled ignition burner

In this system, the main fuel supply may only be released when the controlled flame of the ignition burner has been proven.

4.4.2.3 Ignition by non-controlled ignition burner

In this system, the main fuel supply may be released when the ignition burner flame is not controlled.

5 Constructional and operational requirement

5.1 Construction and operation

5.1.1 General design

5.1.1.1 Materials

The quality and thickness of the materials used in the construction of the burner shall be selected so that the constructional and performance characteristics of the system do not deteriorate during operation. In particular, all burner components shall withstand the mechanical, chemical and thermal loads that may be encountered during operation. Under normal conditions of use, maintenance and adjustment, the burner components shall

not show any changes that could affect their normal functioning. The influence of higher heat-transfer media temperature shall also be considered.

If the burner housing contains any metal parts not made of corrosion-resistant material, these shall be suitably protected with an effective anti-corrosion coating.

Asbestos or asbestos-containing materials shall not be used.

Solder that has a melting point below 450 °C after application shall not be used for fuel-carrying parts.

The pipework material shall be in accordance with ISO 3183, ISO 9329-1, ISO 9330-1 or ISO 1129, as applicable.

In Japan and Korea, the specific requirements respectively given in normative Annexes J and L apply.

5.1.1.2 Design

The effective lifetime of a burner is primarily controlled by its operation and maintenance.

The design of the burner shall be based on its intended lifetime as declared by the manufacturer. The intended lifetime of the equipment into which the burner is to be installed shall also be taken into account.

NOTE 1 The lifetime of components can differ from that of the burner.

The construction and design of the oil burner shall be such that the fuel oil used burns safely over the specified input range and pressure range specified by the manufacturer and the requirements given in Clause 6 are met.

NOTE 2 The burner head can be lengthened as long as the performance of the burner is not affected in an unsafe manner. The geometry of the mixing device and its position in the flame tube can remain unchanged.

Oil burners that can only operate by means of permanent ignition are not permitted.

5.1.1.3 Mounting

The burner shall be designed such that it can be effectively mounted on the appliance.

The burner shall be mounted on the appliance such that no ejection of high temperature gas or flame can occur, and such that back radiation and high refractory temperatures do not adversely affect the stability and lifetime of the burner parts inside the combustion chamber.

The burner components shall be arranged and secured such that their correct operating position and — above all — the correct position of the burner orifices cannot change during operation. The correct operating position shall be maintained when accessories are removed and refitted.

Parts of the burner that are set or adjusted during manufacture and which are not intended to be manipulated by the user or installer shall be sealed.

5.1.1.4 Accessibility for maintenance and use

Components requiring regular maintenance shall be so arranged or designed that they are easily detachable. They shall be designed or marked such that reasonable interpretation of the manufacturer's instructions would provide for proper reinstallation.

Constructional parts accessible during use and maintenance shall be free from sharp edges and corners that might cause damage or personal injury. Burners that can be withdrawn or swivelled out of position without the use of tools shall be interlocked (e.g. by means of limit switches) so that they cannot be operated in the withdrawn or swivelled position.

The interlock device shall be fail-safe in design and, if a limit switch, shall conform with IEC 60204-1 or IEC 60947-5-1, depending on the design.

If the burner is installed according to the manufacturer's instructions, the surface temperatures of accessible burner parts not intended to be touched shall not exceed the ambient temperature by more than 60 K.

If, for technical reasons, these temperature limits cannot be respected, adequate warnings shall be provided.

5.1.2 Equipment

5.1.2.1 Motors, fans and pumps

Guards, grilles and shields shall be used to protect high-temperature or moving parts such that they cannot be touched accidentally. If this protection is not possible, warning signs shall be used.

Removal of such guards, grilles and shields shall be possible only with the use of tools.

The degree of protection provided shall be at least IP 20, according to IEC 60529.

Belt drives, where used, shall be so designed or positioned as to afford protection to the operator.

Means shall be provided to facilitate adjustment of belt tension. Access to such means shall be possible only with the use of tools.

Motors, fans and pumps shall be mounted such as to minimize noise and vibration. Lubrication points, if provided, shall be readily accessible.

5.1.2.2 Electrical safety

5.1.2.2.1 Electrical safety of devices

Controls in accordance with the electrical requirements of IEC 60730-2-5 and ISO 23550 are considered as fulfilling the electrical requirement of this International Standard, and thus 5.1.2.2.2 is not applicable to such controls.

5.1.2.2.2 Electrical safety of the burner

5.1.2.2.2.1 General

The leakage current and electrical strength tests of the complete burner need not be performed if the components and sub-assemblies have been separately tested and the interconnection is carried out in accordance with the manufacturer's instructions.

If the measurements of the leakage current as required in IEC 60335-1:2001, 13.2 are not possible because the protective impedance circuits or radio interference filters cannot be disconnected, then the limit specified for leakage current shall be calculated taking into account the current through those circuits.

The electrical safety of

- a) the burner,
- b) those of its control devices not in accordance with IEC 60730-2-5 and ISO 23550, and
- c) the interface between control devices which do fulfil the requirements of IEC 60730 and ISO 23550

shall be in accordance with IEC 60335-2-102, modified by the additions and replacements given in 5.1.2.2.2.2.

5.1.2.2.2 Modifications, additions and replacements

a) Moisture resistance

The requirements of IEC 60335-1:2001, Clause 15, apply.

IEC 60335-2-102:2004, 15.2, does not apply.

b) Leakage current and electric strength

The following replaces IEC 60335-2-102:2004, 16.2:

For oil burners, the limit is 10 mA.

The following replaces IEC 60335-2-102:2004, 16.3:

Compliance of spark ignition circuits shall be checked by inspection. In case of doubt, spark ignition circuits or crucial parts shall be submitted to an endurance test performed under the following conditions:

- i) the maximum duration of switch-on given by the manufacturer (complete switch-on duration shall correspond with the realistic time of use);
- ii) the relation between on/off cycles as declared by the manufacturer;
- iii) the maximum rated voltage;
- iv) the maximum ambient temperature of all parts under test.

During this test no breakdown of other circuits or — if the limits specified in IEC 60335-2-102:2004, 8.101, are exceeded — accessible surfaces shall occur. Breakdown of conductive parts which are connected to earth is allowed if this does not result in a critical failure of a circuit(s) with safety-related functions.

NOTE In case of doubt, compliance can normally be achieved by increasing the clearance at any part of the spark ignition circuit likely to cause an unacceptable breakdown.

c) Abnormal operation

In addition to the provisions of IEC 60335-2-102:2004, 19.11.2, the following failure mode applies:

Short-circuit and mechanical break-down of relay contacts in protective electronic circuits: these failure modes need not be considered if components conform with footnote g) of IEC 60730-2-5:2004, Table H.27.1.

The following replaces the last paragraph of IEC 60335-1:2001, 19.11.2:

In each case, the test is ended if:

- i) for risks of electrical origin, interruption of the supply occurs within the appliance;
- ii) for risks concerning the fuel, shut-down occurs.

The following is additional to the provisions of IEC 60335-2-102:2004, 19.11.3:

Tests are not to be repeated for protective electronic circuits conforming with the relevant control standard according to 5.1.2.2.1.

The following replaces IEC 60335-2-102:2004, 19.13:

During the tests described in 19.11.4, the appliance shall either continue to operate normally or reach a safe situation for risks concerning the fuel safety shut-down or non-volatile lock-out.

d) **Components**

The following is additional to IEC 60335-2-102:2004, 24.1.1:

Relays and optocouplers which ensure electrical isolation between live parts and accessible metal parts shall conform with IEC 61810-1 and IEC 60747-5-2.

e) **IEC 60335-2-102:2004, Annex Q**

The following is additional to the provisions of the annex:

NOTE Repeat testing of a protective electronic circuit is not required where the system has already been certified to conform with published International Standards where compliance requires that the fault behaviour of the fail-safe system is assessed on a second fault analysis basis.

5.1.2.3 Adjustable air damper

Any adjustable air damper or similar device for controlling the airflow shall be adjustable only by means of a tool. The adjusting positions of the air damper shall be visible (e.g. after removal of a cap).

If the burner is provided with a manual means of adjusting the combustion airflow, this means shall be designed so that, after adjustment according to the manufacturer's instructions, it is capable of being set and sealed.

5.1.2.4 Installation of automatic burner control unit

The automatic burner control unit shall be in accordance with IEC 60730-2-5 and, in the installed condition (e.g. in the burner housing/control panel), shall have at least an IP 40 degree of protection as specified in IEC 60529.

In Japan and Korea, the specific requirements respectively given in normative Annexes J and L apply.

5.1.2.5 Rubber hoses and hose assemblies

Rubber hoses and hose assemblies that have a corrosion-proof metal braiding and which meet the requirements of ISO 6806 are permitted.

In Japan and Korea, the specific requirements respectively given in normative Annexes J and L apply.

Rubber hoses and hose assemblies shall withstand the maximum fuel oil temperature.

5.1.2.6 Connections

Inlet connections with pressure-tight joints made on the threads, connections within the burner with pressure-tight joints made on the threads that are not loosened for maintenance, and connections for parts that are not frequently dismantled and refitted shall be designed in accordance with ISO 7-1.

Connections which have to be loosened for maintenance purposes shall be designed in accordance with ISO 228-1. Flange connections shall conform with ISO 7005-1, ISO 7005-2 and ISO 7005-3.

In Japan, Korea and the USA, the specific requirements respectively given in normative Annexes J, L and M apply.

5.1.2.7 Safety shut-off devices and oil pressure switches

In the USA, the specific requirements given in normative Annex M apply.

5.1.2.7.1 Safety shut-off devices

Safety shut-off devices shall be in accordance with ISO 23553-1.

5.1.2.7.2 Burners with a flow rate less than or equal to 30 kg/h

A safety shut-off device shall be provided between the pump and nozzle as shown in Figures F.1 to F.4. It is permissible that the safety shut-off device be integrated with the oil-pump.

In addition, the following applies.

- a) Single-stage burners shall be provided with one safety shut-off device in accordance with ISO 23553-1.
- b) Two-stage or multi-stage burners shall be fitted with one safety shut-off device for each nozzle. See Figure F.2.
- c) Burners with a spill-back nozzle shall be fitted with a safety shut-off device conforming to ISO 23553-1 in both the feed line and return line. A nozzle shut-off valve may be fitted in lieu of the safety shut-off device fitted in the feed line and return line on condition that the nozzle shut-off valve is tested and approved as a safety shut-off device in accordance with ISO 23553-1. See Figures F.3 and F.4.
- d) In the case of a burner with a nozzle head it may be necessary to have oil circulation up to the nozzle head, e.g. for pre-heating purposes. Since there is only a nozzle shut-off device in service, it shall be ensured by a second independent measure that an unsafe fuel discharge is prevented. In the case of a nozzle shut-off device in accordance with ISO 23553-1 a second measure is not necessary. It shall be ensured that the nozzle shut-off device cannot be opened by the return pressure.

5.1.2.7.3 Burners with a flow rate greater than 30 kg/h

Two series-connected safety shut-off devices shall be provided in the flow line of oil burners with a flow rate > 30 kg/h. See Figure F.5.

One of the devices shall be of the fast-closing type. The second device may also be used as a final controlling element for the combustion chamber input. Its closing time shall not exceed 5 s.

The following also applies:

- a) For burners with a spill-back nozzle, two safety shut-off devices shall be provided in the return line and a pressure monitoring device shall be provided between the power regulator and the safety shut-off device (see Figures F.6 and F.7). A nozzle shut-off valve may replace a safety shut-off device fitted in either the flow line or the return line provided it has been tested and certified as a safety shut-off device in accordance with ISO 23553-1.

Except where a step-regulated burner has a full-load stage, the safety shut-off devices shall be interlocked so that when the flow is open the return is not closed. This can be done, for example by

- making a mechanical connection between the safety shut-off devices in the flow and return (e.g. by means of an actuator), or
- by electric or pneumatic interlocking of the safety shut-off devices in the flow and return lines.

It shall be ensured that no excessive pressure builds up between the two shut-off devices.

- b) In the case of a burner with a nozzle head, it may be necessary to enable oil circulation up to the nozzle head, e.g. for pre-heating purposes. Since there is only a nozzle shut-off device in service, it shall be ensured by a second independent measure, so that an unsafe fuel discharge is prevented. In case of a nozzle shut-off device in accordance with ISO 23553-1, a second measure is not necessary. It shall be ensured that the nozzle shut-off valve cannot be opened by the return pressure.

5.1.2.8 Fuel pre-heating

5.1.2.8.1 General

Burners using higher-boiling petroleum in accordance with ISO 8217-based first raffinates shall be provided with the following.

5.1.2.8.2 Heat sources

Any heat source able to be cut off immediately if required and whose rating can be automatically controlled shall be able to be used for oil pre-heating. Open flames shall not be permitted.

5.1.2.8.3 Pre-heating temperature

In the unpressurized condition, the fuel oil temperature shall not attain the fuel oil flash point and shall in no case exceed 90 °C.

In pressurized-type pre-heaters, the maximum temperature shall not exceed a temperature 5 K below the boiling temperature of water in the pressurized oil.

5.1.2.8.4 Control of pre-heating temperature

Each fuel oil pre-heating system shall be automatically controlled. A temperature indicator shall be fitted downstream of the pre-heating system.

Shut-off devices (e.g. thermal limiters) shall prevent a temperature rise above 220 °C of the pre-heating system's surface within unpressurized fuel oil vessels, if not wetted by fuel oil.

5.1.2.8.5 Pressurized pre-heaters

Pressurized pre-heaters shall be designed for 1,5 times the permissible operating pressure.

In Europe, the specific requirements given in normative Annex I apply.

If the pre-heater is used in a closed system, an overpressure protection shall be provided.

Functioning of the necessary overpressure protection shall be ensured by a suitable temperature.

5.1.2.9 Ignition device

The ignition device shall ensure safe ignition of the ignition and/or main burner under the specified conditions of operation.

5.1.2.10 Flame detector device

5.1.2.10.1 General

The flame detector device shall be in accordance with IEC 60730-2-5.

The flame extinction safety time shall be not more than

- 1 s, or
- alternatively, 2 s, provided a flame detector device self-check test is performed at the same time as flame failure.

The flame detector shall be subjected to a safe start check by which, if a flame presence is detected at any time during the pre-purge, the device shall initiate a safety shut-down followed by non-volatile lock-out. The safe start check may be disabled during the 5 s preceding an attempt at ignition.

The flame detector device shall be suitable for the particular thermal rating and mode of operation of the burner (intermittent or permanent operation). When installed on the burner it shall be at least in accordance with IEC 60529, protective category IP 40, and with IP 54 for installations in open air.

In Japan and the USA, the specific requirements respectively given in normative Annexes J and M apply.

5.1.2.10.2 Flame detector device with sensor for the visible range of light

When using flame detector devices equipped with sensors for the visible range of light, the following applies.

- a) If the illumination intensity of the burner flame is $< 0,5$ lx at the flame detector device during operation, sensors for visible light are not allowed to be used for flame supervision purposes.
- b) If the illumination intensity of the burner flame is < 3 lx at the flame detector during operation, the burner with the mounted flame detector device shall conform with the following:
 - when the burner is searched by an illumination intensity of 20 000 lx at 2 856 K colour temperature, the flame detector device shall not show any spurious light signals during the test.

In Japan, the specific requirements given in normative Annex J apply.

5.1.2.10.3 System requirements

Where the ignition burner (if fitted) and the main burner are each provided with their own flame monitor, the ignition burner flame shall not influence the detection of the main flame. The main fuel oil supply shall be opened only after the ignition means is switched off and the ignition burner flame has been established and detected.

For systems where the ignition burner remains in use during main-burner operation, separate flame sensors shall be fitted for monitoring the ignition and main flames. The main flame sensor shall be positioned so that it cannot in any circumstance detect the ignition burner flame.

For systems where the ignition burner is extinguished during main burner operation, a single sensor will suffice. The ignition burner flame shall not influence the detection of the main flame.

5.1.2.11 Air-proving device

If a burner, depending on its design, requires an air-proving device (see 5.1.3.2), such a device shall be fitted as proves adequate airflow during the pre-purge, ignition and operation of the burner.

Airflow failure at any time during the ignition or operation of the burner shall cause a non-volatile lock-out.

Airflow failure during pre-purge shall at least result in a safety shut-down.

For burners with a heat input up to and including 120 kW, a safety shut-down followed by a single recycling attempt is permitted. If the recycling attempt fails then non-volatile lock-out shall occur.

Proof of adequate airflow to the burner shall be achieved by one or another of the following:

- a) pressure sensing;
- b) flow sensing;
- c) any other system which provides a safety level comparable to a pressure sensing-device as specified in a) above.

Fan rotation, an air damper interlock or air damper actuator interlock alone is not sufficient.

The air-proving device shall be proved in the no flow state prior to start-up. Failure to prove the device in the no flow state shall prevent start-up or cause non-volatile lock-out.

This check is not necessary if failure of the air-proving device leads to a safe condition.

The air-proving device shall be adjusted such that, if there is insufficient air supply at the highest or lowest burner operating stage, its operation ensures that no critical operating mode will be reached.

Where the burner is fitted with automatic fuel/air ratio control in which an airflow device provides the lead signal, continuous monitoring of the airflow by the air-proving device during the operation of the burner is not necessary. In the event of the failure of the air lead signal, the safety shut-off device shall be closed.

NOTE For multi-stage and modulating burners only one air-proving device is necessary to control the airflow.

An air-proving device may be omitted if the burners are fitted with all of the following:

- a) a device for checking the actual fan speed if no safety shut-down or blocking occurs;
- b) a device for checking the state of the adjustable air damper during pre-purge, if no oil opening occurs;
- c) a device for a positive coupling between motor/fan;
- d) a device for fuel release via fuel/air ratio control;
- e) a device which shall close the oil valve in the event of air reference signal failure.

If a separate combustion air fan is used, proof of adequate airflow is in principle the same as for a burner conforming to the requirements of this International Standard, with the exception that the positioning of the safety devices can be dependent on the installation on site. The air-proving device shall be located in a position ensuring that sufficient combustion air supply is detected.

The test method for the air-proving device shall be effective and take into account the design of the burner upon which it is installed (see Annex H).

5.1.2.12 Fuel/air ratio control device

Each burner shall be provided with an airflow adjustment device.

For two-stage or multi-stage burners, the combustion air and fuel oil flow rates shall be controlled in tandem by a sequential switching system. The air and fuel adjustment devices shall be interconnected (e.g. by mechanical, pneumatic, electric or electronic means) such that the relationship between combustion air and fuel is fixed in a repeatable way at any operating point of the burner.

On multi-stage or modulating burners where the airflow and fuel flow are not altered simultaneously, there shall be either

- a) air lead on increasing firing rate and fuel lead on reducing firing rate, or
- b) sufficient excess air to prevent fuel-rich firing.

The combined control or the sequential switching shall be effected in such a manner that even in the case of a fault the system will tend towards higher excess air or proceed to a safety shut-down.

Where an electronically operated fuel/air ratio device is fitted, it shall be in accordance with ISO 23552-1.

Where a combustion quality control system influencing the ratio between the oil and air supply is used, it shall be in accordance with ISO 23552-1.

NOTE These requirements apply to burners used for both continuous and intermittent operation with electronic fuel/air ratio control.

Setting of adjustment devices shall not change easily if the adjustment devices are properly fastened.

In Japan, the specific requirements given in normative Annex J apply.

5.1.2.13 Automatic burner control unit

The automatic burner control unit shall be in accordance with IEC 60730-2-5 and shall be suitable for the individual output stages of the burner and for the mode of burner operation (intermittent or permanent).

5.1.2.14 Pressure test points

Test points or pressure-measuring devices shall be provided to enable the fuel suction pressure, fuel adjustment pressure and the air pressure to be checked.

5.1.2.15 Interfacing with oil appliances

See Annex N for an example of the application, interfacing and wiring of a burner. This interfacing can facilitate the assembly of burners and boilers/oil appliances on site.

5.1.3 Operating requirements

5.1.3.1 Shut-down

If an on/off control, switch or limiter operates, the fuel oil supply shall be automatically cut off immediately.

5.1.3.2 Protection of the oil and air supply

The oil supply shall not be released without the atomizing process being ensured [e.g. failure of atomizing medium, oil pressure too low, return pressure too high (burners with spill-back nozzle), speed too low] or if the combustion air is not available. If the atomizing medium or combustion air supply fails during operation, the oil supply shall be automatically cut off immediately. In the case of oil pressure atomizers, if no spring-loaded fast closing devices are available in the oil-pump, oil pressure switches shall be used.

Where there are no oil- or air-supply monitoring devices or spring-loaded fast closing devices in the pump, the above requirements are considered to have been met if there is a motor-fan-pump assembly, in the case of a single shaft motor output, or a fan-motor-oil-pump assembly, in the case of a double-ended shaft motor output. In the latter case, there shall be a positive coupling between motor and fan.

Oil pressure shall not exceed a maximum value given by the manufacturer owing to

- expanding oil volume under temperature influence, and
- closing spill-back lines of feed pumps.

Means shall be installed to ensure safe operation and handling.

EXAMPLE Relief valve, expansion bellows, linkage of feed spill-back closures.

The control circuit of the automatic safety shut-off devices shall be designed so that it does not release the oil supply during start-up and cuts off the oil supply during operation under the following conditions:

- a) when the required atomizing pressure is not reached, in the case of steam and compressed air atomizers, or when the speed of the rotary cup is too low, in the case of rotary atomizers (when the coupling between the atomizing cup and fan cannot be detached, monitoring of the fan air pressure is adequate);
- b) when the maximum oil return pressure is exceeded, in the case of return atomizers greater than 30 kg/h;
- c) when the combustion air fails if the fan is separate;
- d) when the main switch is activated;
- e) when burners (or even burner lances) are swung out or moved out in cases where this can be done without the use of tools;
- f) if the excess air ratio, λ , under-runs a critical value.;

Requirement f) is met by one or the other of the following:

- 1) the fuel/air ratio mechanically fixed and the ratio unable to be altered by interference or operating effects, in which case control is not required;
- 2) use of an electronic fuel/air ratio device in accordance with ISO 23552-1.

As soon as the conditions given under 5.1.3.2 a) to c) no longer apply, the burners may start up automatically with the start-up programme maintained.

With regard to 5.1.3.2 d) to e), a recycling shall only be possible by manual intervention.

In Japan, the specific requirements given in normative Annex J apply.

5.1.4 Operation with dual fuel supply or simultaneous supply

Burners shall be designed such that when operating under dual fuel or simultaneous supply, no fuel shall adversely influence the flow of the other fuel.

5.2 Safety devices

5.2.1 General

The requirements given in 5.2.2 to 5.2.5 are generally applicable. Deviations from the sequence specified in this International Standard are permitted in the case of special types of apparatus and oil burners of special design or size.

The system and oil burners are also regarded as meeting the requirements of this International Standard if the design is declared safe to operate by the test laboratory after testing of the whole unit or of the oil burner with the appropriate equipment.

5.2.2 Ignition safety times for start-up

Table 1 gives the start heat inputs and safety times for cases where the burner size is matched by the burner manufacturer to the test rig/appliance by at least

- thermal rating,
- combustion chamber diameter,
- combustion chamber length, and
- combustion chamber pressure.

Table 1 — Maximum start heat input, Q_s , and ignition safety times, t_s

Heat input Q_F kg/h	Direct main burner ignition at full rate t_s s	Direct main burner ignition at reduced rate, Q_s (as a percentage of Q_F) t_s s	Reduced rate, Q_s , by ignition burner
≤ 30	$t_s \leq 10$	$t_s \leq 10$	$t_s \leq 10$
$> 30 \leq 100$	$t_s \leq 5$	$t_s \leq 5$	$t_s \leq 5$
$> 100 \leq 500$	not permitted	$t_s \leq 5$ ≤ 100 kg/h or $Q_s \leq 70 \% Q_F$	$t_s \leq 5$ ≤ 100 kg/h
> 500	not permitted	$t_{smax} \leq 5$ $Q_s \leq 35 \% Q_F$	$t_s \leq 5$ $Q_s \leq 50 \% Q_F$

In the case of an ignition burner ignited by electric energy, supervision of this flame is necessary if the time between opening of the fuel shut-off valve of the ignition burner and the opening of the main oil valve of the main burner is more than 5 s.

Separate supervision of the ignition burner flame is not necessary up to 5 s pre-ignition time if the oil supply is cut off and the ignition burner valve closed within the safety time with non-ignition of the oil flame. In this case, the ignition fuel is permitted to flow for a maximum of 10 s (5 s pre-ignition time and 5 s safety time).

In Australia, the specific requirements given in normative Annex K apply.

5.2.3 Non-volatile lock-out, recycling and ignition restoration of the oil burner

The oil supply shall be cut off automatically and non-volatile lock-out shall occur no later than at the end of the safety time under any of the following conditions:

- a) during the oil burner start-up, no flame has been established at the end of the ignition safety time;
- b) the flame is extinguished during operation, in which case
 - 1) one recycling attempt is allowed,
 - 2) for burners ≤ 30 kg/h, one ignition restoration is allowed (see IEC 60730-2-5).

NOTE A recycling of the oil burner may not be possible until the burner control unit has been manually reset.

5.2.4 Pre-purging of the combustion chamber

In Japan, the specific requirements given in normative Annex J apply.

5.2.4.1 For nominal fuel mass flow rates less than 30 kg/h

For nominal fuel mass flow rates less than 30 kg/h, the following applies.

- a) Natural ventilation of the combustion chamber is sufficient if the air regulation elements are fixed permanently in their operating positions.
- b) Arrangements shall be made to ensure a mechanical pre-purge (by fan) of at least 5 s if air registers with positive control (e.g. electro-hydraulic) are used. This mechanical pre-purge may be replaced by a natural ventilation of the combustion chamber (e.g. by means of the flue draught) for a period of at least 30 s.
- c) Mechanical pre-purge is not required in the case of air registers operated by vacuum if the closed damper blade allows sufficient openings for an air flow of at least 20 % of the maximum fan flow.
- d) Where positively operated registers are situated on the flue gas side, then b) above applies correspondingly.

5.2.4.2 For nominal fuel mass flow rates greater than 30 kg/h

For nominal fuel mass flow rates greater than 30 kg/h, the following applies.

- a) The pre-purge time shall be fixed at 15 s minimum with an air rate of at least 30 % of the air rate corresponding to the maximum heat input of the appliance to be equipped. This time can be deviated from, provided at least five air volume changes in the combustion chamber are ensured.
- b) Where positively operated registers are situated on the flue gas side, then a) above applies correspondingly.

5.2.5 Ensuring adequate oil pre-heating

If fuel oil pre-heaters are used and are necessary for correct operation, suitable automatic devices shall be installed to ensure that the oil burner is not started before the required fuel oil temperature has been reached and that it is shut down if this temperature is not maintained.

5.3 Spurious light signals

The requirements of IEC 60730-2-5 apply.

5.4 Combustion

The type and design of the oil burner and its atomizing and mixing devices shall ensure combustion in accordance with 5.5 to 5.7. The limiting values given there shall be adhered to.

Post-injection, except when pressure is released, shall be avoided. The oil burner, unless designed for positive pressure start and normal burn conditions, shall be maintained at a combustion chamber pressure of 0 Pa and a minimum boiler resistance, both relative to the operating condition. For pressurized atomizing oil burners that only operate with a pressure of more than 10 Pa in the combustion chamber, the lowest test pressure shall be 0 Pa and the maximum test pressure shall be 10 % greater than the maximum value of the application declared by the manufacturer.

Positive pressure burners that are operated from a pressure range of zero to any positive pressure in the combustion chamber additionally shall still have a stable flame at a pressure of -10 Pa.

For oil burners that are in both the positive and negative pressure ranges, test conditions resulting from the requirements of this subclause apply accordingly.

The requirements of this subclause apply to the combustion pressure of multi-stage burners or modulating oil burners but only for higher nominal inputs. However, the combustion stability test for the oil burners is also extended to establishing the burning behaviour in the case of automatic switching on and off of the individual stages and automatic regulation of the burner input.

5.5 Combustion product quality

5.5.1 General

The measurements are to be carried out when the burner has stabilized except those for which records from the start-up are required.

The requirements of 5.5.2 to 5.5.4 are not applicable for higher boiling petroleum in accordance with ISO 8217-based first raffinates.

5.5.2 Smoke number

For fuel having a viscosity at the burner inlet of 1,6 mm²/s (cSt) up to 6 mm²/s (cSt) at 20 °C, the smoke number shall be

- a) less than or equal to 1 for one-stage burners at all heat inputs, and
- b) less than or equal to 1 for multi-stage and modulating burners, except at the minimum fuel rate, where the smoke number shall be less than 2.

See also Annex A.

5.5.3 Unburnt hydrocarbons

The proportion of unburnt hydrocarbons in the combustion gas shall not exceed 10 ml/m³ except during the first 20 s after release of the fuel. The measurement shall be carried out using the flame ionization detection principle (FID).

See also Annex D.

5.5.4 Emission classes for burners

The emission classes for NO_x and CO are standardized according to Annex B and Annex C, and shall not exceed the values given in Table 2.

Table 2 — Emission classes for NO_x and CO

Class	$Q_{NO_x}^{a,b}$ mg/kWh	Q_{CO}^c mg/kWh
0	> 250	≤ 350
1	≤ 250	≤ 110
2	≤ 185	≤ 110
3	≤ 120	≤ 60

^a No measured value shall exceed that of the next higher class.
^b An arithmetic average value for determining the NO_x class is formed from the measuring points of the working diagram (see Annex B, $\bar{\varphi}_{NO_x,M}$) and shall be within the NO_x class according to Table 2.
^c No single CO value shall exceed the limits for the class.

In European countries, the specific requirements given in normative Annex I apply.

5.6 Combustion quality of the combustion products for other liquid fuels

The values measured in 5.5 are given in the test report.

5.7 Excess air ratio

The values of the excess air ratio, λ , shall not exceed the values specified in Figure 1.

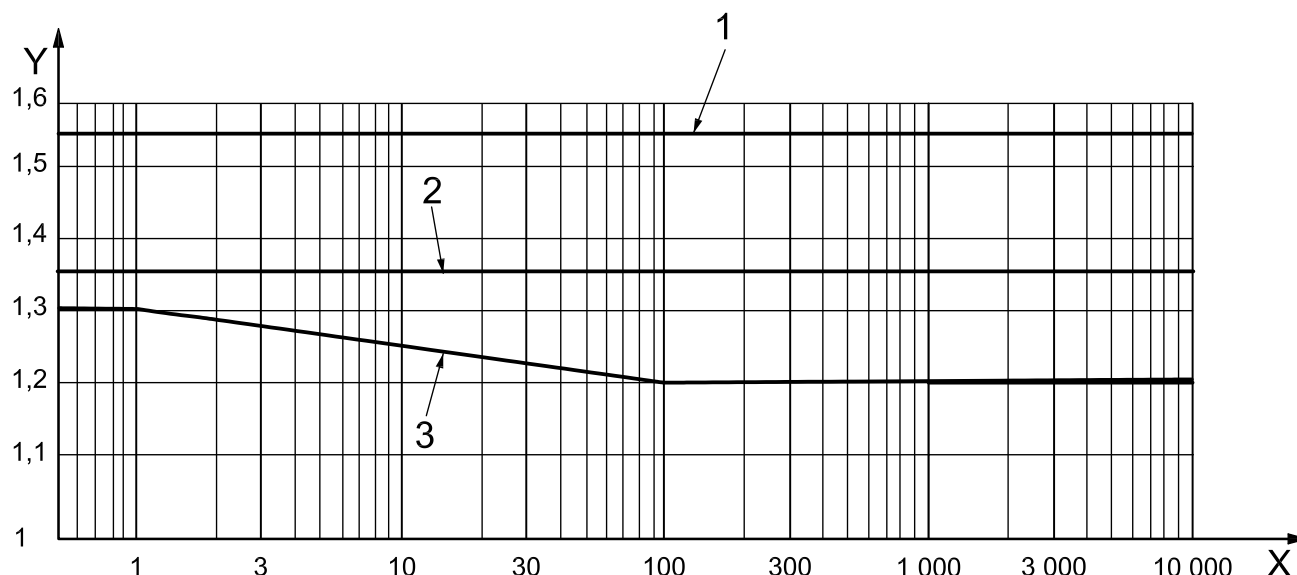

Key

X mass flow rate, kg/h

Y excess air ratio, λ

1 λ_{max} for Q_{Fmin} at a turndown rate > 3: 1

2 λ_{max} for Q_{Fmin} at a turndown rate \leq 3: 1

3 λ_{max} for Q_{Fmax}

Figure 1 — Excess air ratio

5.8 Operational requirements

5.8.1 External soundness of fuel-carrying parts

The fuel-carrying parts of the burner, up to the atomizing device, shall be sound.

Under normal conditions the sealing materials shall remain effective and there shall be no visible signs of fuel leakage.

5.8.2 Resistance of the burner to overheating

Under the conditions specified in 6.7.2.2.2, the component parts of the burner shall not suffer any deterioration other than the superficial alterations inherent in combustion.

5.8.3 Temperatures of the control and safety devices

Under the conditions specified in 6.7.2.2.2, the temperature of the adjusting, control and safety devices shall not exceed the value stated by the manufacturer of the device and their operation shall remain satisfactory.

The surface temperature of knobs and levers intended to be manipulated shall not exceed the ambient temperature by more than

- a) 35 K for metals,
- b) 45 K for porcelain or equivalent materials,
- c) 60 K for plastics or equivalent materials.

5.8.4 Ignition, operation and flame stability

Under the conditions specified in 6.7.5 and 6.7.6, as appropriate, ignition shall be effected correctly and rapidly. The flames shall be stable and shall not create any disturbing noise. A slight tendency to lift at the moment of ignition is permissible, but the flames shall be stable thereafter.

For burners fitted with a range-rating device, these requirements shall be satisfied at the nominal maximum and minimum heat inputs declared by the manufacturer.

5.8.5 Heat input range of the burner

The maximum nominal and minimum nominal heat inputs shall be as stated by the manufacturer to within $\pm 5\%$.

5.8.6 Dual-fuel burner

Safe operation of the burner shall not be affected by the operational state of the control and safety devices intended for the alternative fuel.

5.8.7 Working and test diagrams

5.8.7.1 Working diagram

The working diagram represents the permitted range of application of the burner in terms of the combustion chamber pressure expressed as a function of the burner heat input.

Its boundaries are defined by points 1 to 5 inclusive for single-stage burners [see Figure 8 a)] and 1 to 6 inclusive for multi-stage burners [see Figure 8 b)], determined in accordance with 5.5, 6.2. and Table 4.

The burner operation points shall not exceed the boundaries given by the working diagram.

5.8.7.2 Test diagram

The test diagram represents the ranges of combustion chamber pressure and burner input over which the burner is tested to establish conformity to this International Standard.

It comprises the working diagram and a test zone defined by points Hp1 to Hp3 for single-stage burners [see Figure 8 a)] and Hp1, Hp2, Hp3 and Hp6 for multi-stage burners [see Figure 8 b)].

These points are determined in accordance with 5.5, 6.2, 6.5 and Table 4.

5.8.8 Determination of flame stability and the safe range of operation

The burner shall operate correctly and safely under the test conditions specified in 6.7.

The flames shall be stable without pulsation.

6 Test methods

6.1 General

The tests cover the construction and operating characteristics of burners and are generally carried out in the combustion chambers defined in 6.3. In certain cases, however, they may be carried out on the equipment for which the burner has been designed.

The burner shall be tested with all the components having an effect on its operation and in all specified operating modes.

The construction of the burner shall be such as to prevent any hazard to persons from moving parts.

It shall be verified that the flame supervision and control devices ensure the correct operation of the burner.

In Japan, the specific requirements given in normative Annex J apply.

6.2 Ambient test conditions

The burner shall be installed in a well-ventilated, draught-free environment under the following conditions:

- a) an ambient temperature of $20\text{ °C} \pm 15\text{ °C}$;
- b) an ambient pressure of $101,325\text{ kPa} \pm 4\%$ at sea level;
- c) a humidity of 5 g to 30 g of water/kg of air.

The test results (working diagram, see 6.7.2.2) shall be corrected to reference conditions

- for the ambient temperature of 20 °C ,
- for the ambient pressure of $101,325\text{ kPa}$, and
- for the humidity of 10 g of water/kg of air.

NOTE For the Q_{NO_x} emission correction method, see Annex B.

Other ambient temperatures are acceptable provided that the test results are not affected.

The quality of the air available in the test environment shall not affect the validity of the test parameters measured.

6.3 Combustion test chamber

6.3.1 General

Testing may be carried out in a combustion chamber nominated by the manufacturer. However, in cases where the manufacturer has not nominated a combustion chamber, the tests shall be carried out on a combustion test chamber as specified in 6.3.2. or 6.3.3.

A heat-transfer medium temperature that is as low as possible:

- a) combined with low ambient temperature of the burner parts, provides the most critical condition for the *burner start-up* and the immediate turn-up of the heat input to the maximum with regard to flame lift and pulsation, and higher heat-transfer medium temperatures and burner parts temperature support the burner start-up;

- b) provides the most critical condition for the *combustion quality* with regard to CO, unburned hydrocarbons and smoke on cool walls, and higher heat-transfer medium temperatures support the combustion process.

6.3.2 Test rig for a heat input of less than or equal to 2,4 MW

The test rig shall include test flame tubes (see the examples of Figure 2).

Each flame tube is defined by

- a) its internal diameter (0,225 m, 0,300 m, 0,400 m, 0,500 m, 0,600 m, 0,800 m),
- b) its length, and
- c) its corresponding heat input (see Figure 3).

Individual flame tubes can be operated with a difference of ± 10 % in the given inputs.

The manufacturer shall nominate the flame tube to be used at minimum or maximum input.

The length of the flame tube, l_1 , shall be calculated using Equation (1):

$$l_1 = 0,25 \times \sqrt{\dot{m}} \quad (1)$$

where

\dot{m} is the fuel rate, in kilograms per hour (kg/h);

l_1 is the length of the flame tube in metres (m).

For higher boiling petroleum in accordance with ISO 8217-based first raffinates the length of the combustion chamber shall be increased by 10 %.

The flame tube length is adjusted by means of a sliding rear wall, which moves longitudinally inside the flame tube itself.

At the manufacturer's option, the burners may be tested on a flame tube either with

- a) direct flame operation, or
- b) reversed flame operation.

For direct flame operation, an uncooled steel cylinder sleeve having the same internal diameter as the flame tube combustion chamber and a wall thickness of 3 mm shall be inserted in the combustion chamber inlet so as to seal the entry of the heat exchanger tubes. The length is $l_2 + 30$ mm (see Figure 2).

The flame tube is equipped with a downstream throttle device to enable a variable pressure drop to be created at the combustion chamber outlet or in the flue. The pressure within the combustion chamber shall be adjusted by means of this device.

All walls, with the exception of the front wall, shall be cooled.

The flame tube shall be fitted with sealed windows enabling visual inspection of the flame to be made. It shall be possible to measure the pressure in the flame tube.

NOTE The pressure measurement can be carried out by means of a device fitted in the combustion chamber door (flame tube door).

It is acceptable for the flames to strike the cooled rear wall.

If the manufacturer develops a burner intended to fire into a combustion chamber with dimensions significantly different from those given in Figure 2, then the tests shall be carried out on a typical boiler or on another test flame tube pending the development of a new standard test flame tube. In this case, special mention shall be made in the burner instruction manual.

If the test is carried out on site in the actual application, the test results shall be recognized regardless of the temperature of heat-transfer medium and the position of installation of the burner. At the same time, the heat load rate (kWh/m^3 or kWh/m^2) shall be given in the commissioning report (see 8.4.1).

For burners with a heat input above the values given in Figure 3, the test shall be carried out on a test rig specified by the manufacturer.

For higher boiling petroleum in accordance with ISO 8217-based first raffinates the heat input shall be reduced by 10 % for the same diameter.

Figure 4 shows a schematic representation of the flue gas measurement.

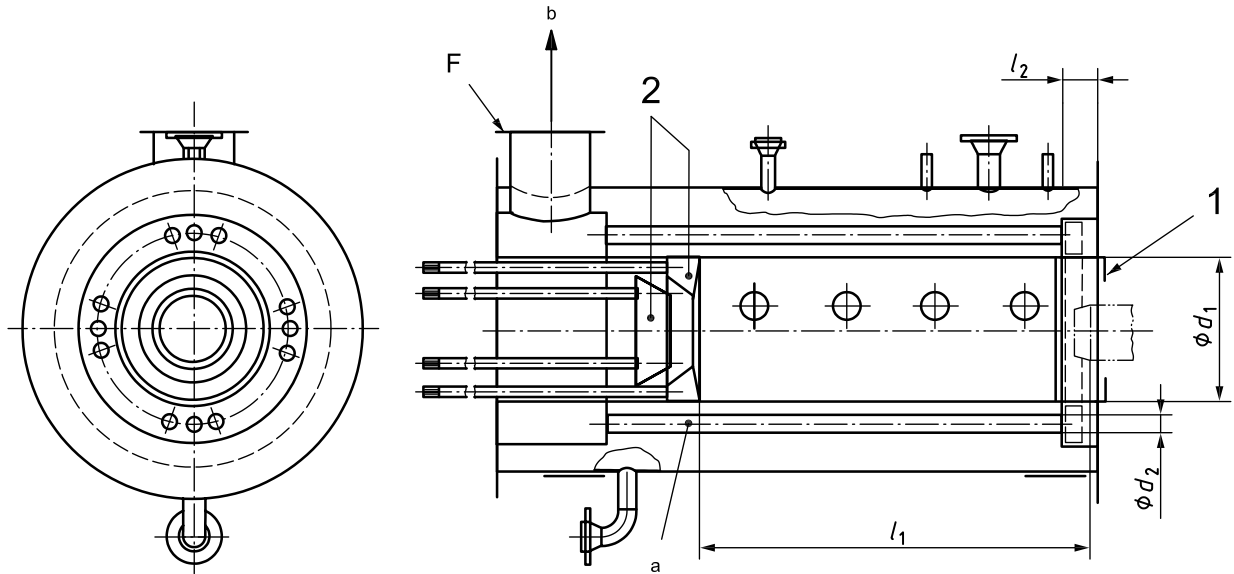

Test flame tube d_1 m	Heat exchanger tube		Number	l_2 mm
	Internal	External		
0,225	16	20	8	60
0,3	21	25	14	80
0,4	36,5	41,5	12	100
0,5	39,5	44,5	26	130
0,6	51,5	57	30	160
0,8	80,9	88,9	28	200

Key

1 steel cylinder sleeve for direct flame operation ($l_2 + 30$ mm)

2 test flame tube rear wall (two parts)

F flue duct flange interface

d_1 diameter of combustion chamber

l_1 length of combustion chamber

a At the manufacturer's option, the test may also be carried out with flame reversal. When the flame is reversed, this shall be clearly stated in the instruction manuals.

b Direction of flue gas flow.

Figure 2 — Test flame tube — Schematic representation

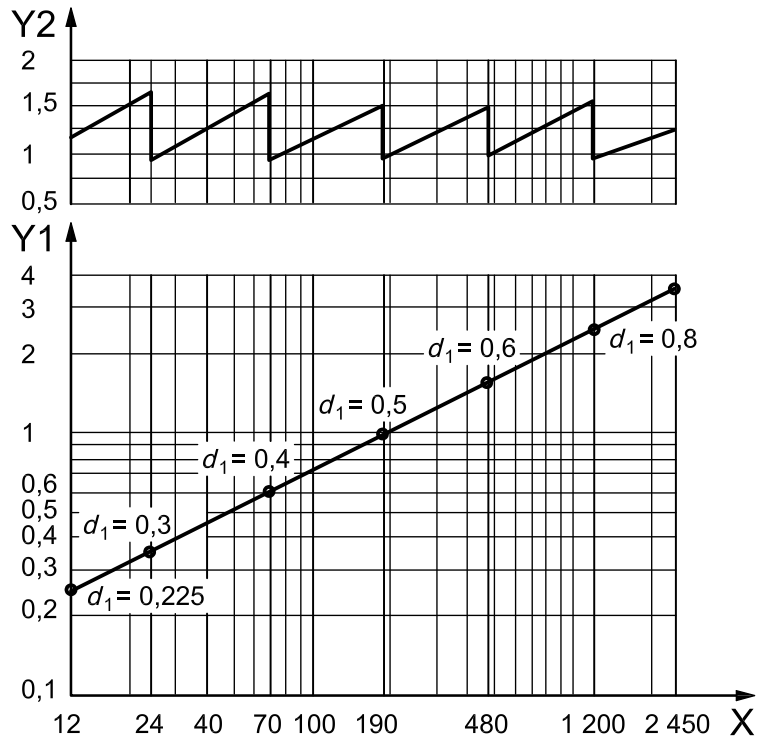

Key

- X heat input, Q_F , kW
- Y1 test flame tube length, m
- Y2 test flame tube firing intensity, MW/m^3
- d_1 test flame tube diameter, m

Figure 3 — Firing intensity, diameter and length of test flame tube as function of heat input

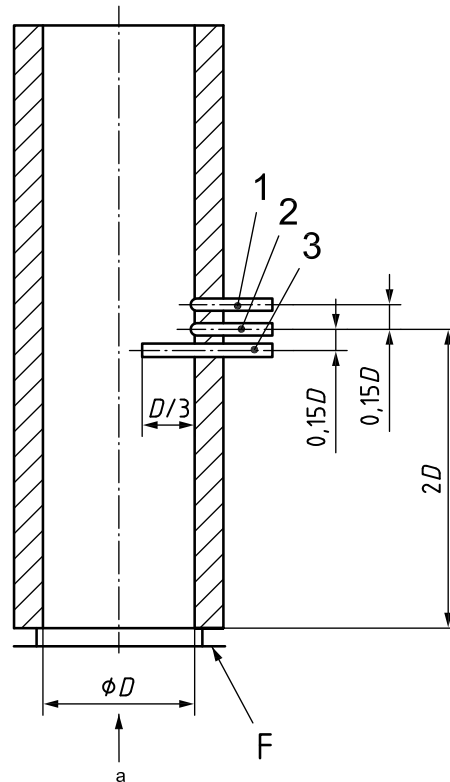

Key

- 1 temperature
- 2 draught/pressure
- 3 flue gas analysis
- D flue gas tube diameter
- F flue duct flange interface
- a Flue gas flow direction.

Figure 4 — Flue gas measurement section — Schematic representation

6.3.3 Test rig for a heat input greater than 2,4 MW

The test rig can be a boiler/oil appliance with a combustion chamber defined by the manufacturer on site.

Each combustion chamber is defined by

- a) its minimum length [see Equation (2) and Figure 5],
- b) its internal minimum diameter [see Equation (3) and Figure 6],
- c) its corresponding heat input, and
- d) heat load rate (kWh/m^3 or kWh/m^2).

If the test is carried out on site in the actual application, the test results shall be recognized regardless of the temperature of the heat-transfer medium and the position of installation of the burner. At the same time, the heat load rate (kWh/m^3 or kWh/m^2) shall be given in the commissioning report (see 8.4.1).

Individual combustion chambers can be operated with a difference of $\pm 5\%$ in the given inputs.

The manufacturer shall define the combustion chambers to be used at minimum and maximum inputs.

The length of the combustion chambers, l_1 , shall be calculated using Equation (2):

$$l_1 = 0,2 \times Q_F^{0,3682} \quad (2)$$

where Q_F is the heat input, in kilowatts (kW).

For higher boiling petroleum in accordance with ISO 8217-based first raffinates, the length of the combustion chamber shall be increased by 10 %.

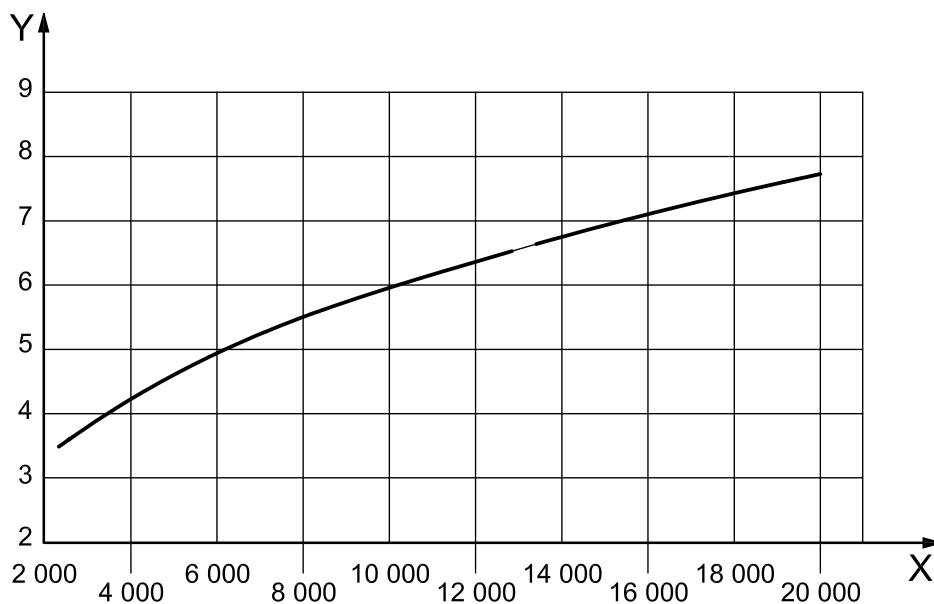

Key

- X heat input, Q_F , kW
- Y length, l_1 , of combustion chamber, m

Figure 5 — Minimum length of combustion chamber as function of heat input

The minimum length should apply if no other length is defined by the manufacturer (see 6.3.1).

At the manufacturer's option, the burner may be tested on a combustion chamber either with

- a) direct flame operation, or
- b) reversed flame operation.

The combustion chamber shall be equipped with a shutter device to enable a variable pressure drop to be created at the combustion chamber outlet or in the flue. The pressure within the combustion chamber shall be adjusted by means of this device.

All walls, with the exception of the front wall, shall be cooled.

The combustion chamber shall be fitted with at least a single sealed window or spy glass enabling visual inspection of the flame to be made. It shall be possible to measure the pressure in the combustion chamber.

NOTE The pressure measurement can be carried out by means of a device fitted in the combustion chamber door.

It is acceptable for the flames to strike the cooled rear wall.

The diameter, d_1 , of the combustion chamber shall be calculated using Equation (3):

$$d_1 = 0,1350^3 \sqrt[3]{\frac{Q_F}{10,1}} \quad (3)$$

where Q_F is the heat input in kilowatts (kW).

For higher boiling petroleum in accordance with ISO 8217-based first raffinates the diameter of the combustion chamber shall be increased by 10 %.

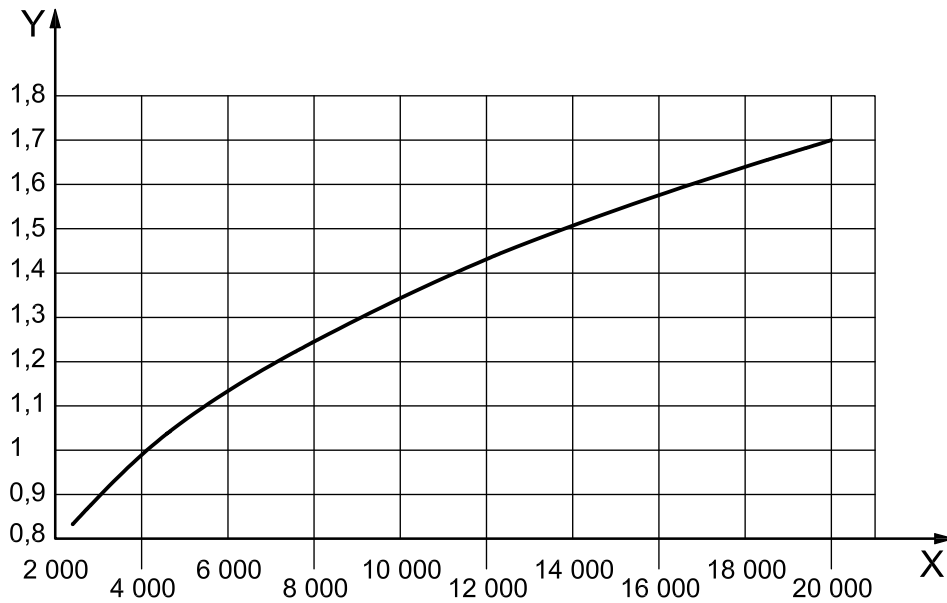

Key

- X heat input, Q_F , kW
- Y diameter, d_1 , of combustion chamber, m

Figure 6 — Minimum diameter of combustion chamber as function of heat input

The minimum diameter should apply if no other diameter is defined by the manufacturer (see 6.3.1).

6.3.4 Heat-transfer medium

The temperature of the heat-transfer medium in the test flame tube is maintained as low as possible, and in all cases in the range of 15 °C to 60 °C during the starting test (see 6.3.1 and 6.7.5).

The heat-transfer medium temperature shall be between 40 °C and 80 °C and thermal equilibrium shall be maintained during the determination of the combustion characteristics (see 5.5 to 5.7, 6.3.1 and 6.7.2.2).

6.3.5 Evacuation of the combustion products

The test flame tube shall be connected to a flue as described in Figure 2.

The combustion products are to be sampled as shown in Figure 4.

When using analysers which measure temperature, pressure and flue gases, measuring points 1 and 2 may be omitted.

6.3.5.1 Electrical supply

The burner shall be supplied with electricity at the nominal voltage, U_N , except where otherwise stated.

6.3.5.2 Installation

The manufacturer shall supply the test laboratory with a burner fitted with all the accessories necessary for the burner's installation according to the manufacturer's instructions.

The burner to be tested shall be connected to the test flame tube as described in Figure 2, and distance l_1 between the flame stabilizer and the adjustable rear wall of the combustion chamber shall be adjusted according to Figure 3 or 5.

Overpressure in the combustion chamber is created by adjusting the shutter device in the rear wall, or any other system placed downstream, either separately or in combination.

For burners operating at a negative pressure in the combustion chamber, an induced draught fan (downstream of the measuring device) is required, or the required values are obtained with the help of a manual adjusting device or an automatic combustion chamber pressure control system.

Burners to be tested on a particular appliance or another test flame tube shall be installed in accordance with the manufacturer's instructions.

6.4 Measuring equipment

6.4.1 General

The measuring equipment shall conform to the tolerances specified in 6.5.1.

6.4.2 Determination of CO₂ or O₂ as well as NO_x, CO and C_xH_y content of the combustion gases

The CO₂ or O₂ content of the combustion gases, required for the calculation of the excess air ratio, is to be determined by means of a suitable apparatus. Continuous measuring apparatus shall be used. The NO_x, CO and C_xH_y contents of the combustion gases are determined similarly.

6.4.3 Determination of the smoke number

The measuring apparatus is described in Annex A.

6.5 Measuring accuracies

6.5.1 Measuring instrument accuracies

The measuring instrument accuracies shall be in accordance with Table 3.

Table 3 — Measuring instrument accuracies

Measurement instrument for:	Accuracy
Pressure	±1 % from full scale
Temperature	±1 K
Mass flow	±0,5 % from full scale
Length	±1 % from full scale
CO ₂ content	±0,1 % volume from full scale
O ₂ content	±0,1 % volume from full scale
CO content	±5 ml/m ³
NO _x content	±5 ml/m ³
C _x H _y content	±5 ml/m ³

6.5.2 Measurement uncertainties

The allowable test measurement uncertainties shall be in accordance with Table 4.

Table 4 — Test measurement uncertainties

Parameter	Uncertainty
Combustion chamber length, l_1	±3 %
Air temperature at burner inlet	±2 K
Combustion chamber pressure during operation	±5 % or 10 Pa
Combustion chamber pressure during start-up	±10 % or 30 Pa
Fuel temperature	±2,5 K
Fuel mass flow rate	±2,5 %
Smoke number	±0,5
CO ₂ content	±0,3 % volume
O ₂ content	±0,3 % volume
CO content	±10 ml/m ³
NO _x content	±10 ml/m ³
C _x H _y content	±10 ml/m ³

6.6 Test conditions

6.6.1 Fuel to be used

The tests shall be carried out with a commercial fuel oil of viscosity 4 mm²/s to 6 mm²/s at 20 °C and nitrogen content less than 200 mg/kg (see Figure 7).

A sample shall be taken of the fuel used before and after the burner test. The sample test results shall meet the requirements of this clause.

For application with other fuels, these shall be tested and the range of viscosity shall be shown on the data-plate.

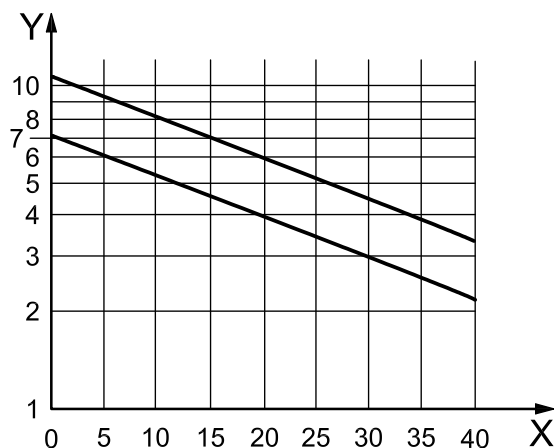

Key

X oil temperature, °C
Y viscosity, mm²/s

Figure 7 — Examples for ranges of test fuel viscosities at 20 °C and viscosity from 4 mm²/s to 6 mm²/s

6.6.2 Testing

Carry out the test as soon as the operating conditions have stabilized. The results shall be in accordance with 5.5 to 5.7.

After each test, the correct starting and ignition of the burner shall be assured and the safety conditions specified in IEC 60730-2-5 shall be met.

6.7 Test programme

6.7.1 General

Prior to its installation on the test rig, the burner shall be checked as to its conformity with the relevant construction documents provided.

6.7.2 Tests to be carried out

6.7.2.1 Setting and duration

According to the method for adjusting the burner, the tests given in 6.7.2.2 shall be carried out for each combustion head.

The burner shall be tested in accordance with the specified load and in conjunction with the specified test equipment. The burner setting shall be such that the requirements of Clause 5 are met.

The test duration shall be

- a) 20 min at the measurement points of the positive pressure area of operation,
- b) 10 min at the measurement points of the negative pressure area of operation.

For each measurement point, values shall be recorded every 5 min.

The instantaneous fuel mass flow rates are noted throughout the duration of each measurement point and their average value given.

6.7.2.2 Tests in accordance with the test diagrams

6.7.2.2.1 General

The tests to be carried out and the adjustments to be made at each test point are detailed in 6.7.2.2.2 to 6.7.2.2.7 (see Figure 8).

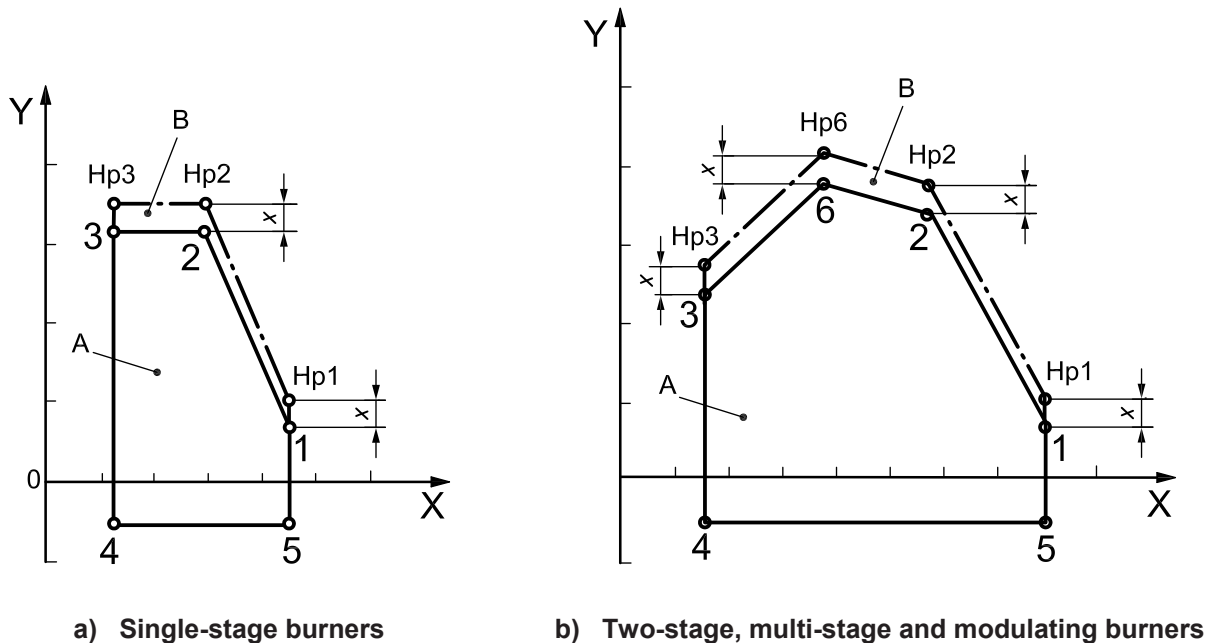

Key

X	throughput, kg/h
Y	pressure, p_F , in combustion chamber, mbar ^a
A	working diagram
B	test diagram
Hp1	maximum throughput at lowest counter pressure in the combustion chamber
Hp2	maximum throughput at maximum counter pressure in the combustion chamber
Hp3	minimum throughput

^a 1 bar = 0,1 MPa = 0,1 N/mm² = 10⁵ N/m².

Hp6	maximum throughput at maximum counter pressure in combustion chamber
4	minimum throughput at depression in the combustion chamber
5	maximum throughput at depression in the combustion chamber
$x = 0,1 p_F$	

Figure 8 — Working and test diagrams for burners

6.7.2.2.2 Tests at test point Hp1

Adjust

- the heat input to maximum nominal value,
- the electrical supply voltage to the nominal value,
- the excess air ratio, λ , to the declared value, and
- the combustion chamber pressure to the lowest counter pressure.

Then perform these tests:

- e) combustion — CO, NO_x, smoke number, C_xH_y and λ (see 5.5);
- f) temperature of control and safety devices (see 5.8.3);
- g) overheating (see 5.8.2);
- h) starting (see 6.7.5);
- i) combustion at corresponding first stage points for two-stage, multi-stage or modulating burners;
- j) at 85 % of nominal voltage (see 6.7.4).

6.7.2.2.3 Tests at test point Hp2

Adjust

- a) the heat input to the declared value,
- b) the electrical supply voltage to the nominal value,
- c) the excess air ratio, λ , to the declared figure, and
- d) the combustion chamber pressure to the relevant value [e.g. maximum value for single-stage burners, see Figure 8 a)].

Then perform these tests:

- e) combustion: CO, NO_x, smoke number, C_xH_y and λ (see 5.5);
- f) starting (see 6.7.5);
- g) combustion at the corresponding first stage point for two-stage, multi-stage or modulating burners.

6.7.2.2.4 Tests at test point Hp3

Adjust

- a) the heat input to minimum nominal value,
- b) the electrical supply voltage to the nominal value,
- c) the excess air ratio, λ , to the declared value, and
- d) the combustion chamber pressurization device to be in the same position as point Hp6. Then test the combustion: CO, NO_x, smoke number, C_xH_y and λ (see 5.5).

6.7.2.2.5 Tests at test point 4

Adjust

- a) following the tests specified in 6.7.2.2.3, and
- b) the combustion chamber pressure to the minimum value. The value may be zero or negative.

Then test the combustion: CO, NO_x, smoke number, C_xH_y and λ (see 5.5).

6.7.2.2.6 Tests at test point 5

Adjust

- a) the heat input to the maximum declared value,
- b) the electrical supply voltage to the nominal value,
- c) the combustion chamber pressure to the minimum value, and
- d) the excess air ratio, λ , to the declared value.

Then test the combustion: CO, NO_x, smoke number, C_xH_y and λ (see 5.5).

6.7.2.2.7 Tests at test point HP6

Adjust

- a) the heat input to the maximum declared value,
- b) the electrical supply voltage to the nominal value,
- c) the combustion chamber pressure to the relevant value (e.g. maximum value for two-stage, multi-stage and modulating burners), and
- d) the excess air ratio, λ , to the declared value.

Then perform these tests:

- e) combustion: CO, NO_x, smoke number, C_xH_y and λ (see 6.7.5);
- f) combustion at the corresponding first stage point for two-stage, multi-stage or modulating burners;
- g) starting of two-stage, multi-stage or modulating burners (see 6.7.5).

6.7.2.2.8 Summary

The measurements to be made and the corresponding requirements and test procedures are given in Table 5.

© ISO 2010

Table 5 — Test summary

Test point	Hp1	Hp2	Hp3	4	5	Hp6	Subclause
$U = 1,0 U_N$	X ^a	X	X	X	X	X	6.7.4
λ^c	X	X	X	X	X	X	5.7
CO \leq limit values ^c	X	X	X	X	X	X	5.5.4
NO _x \leq limit values ^c	X	X	X	X	X	X	5.5.4
Start-up single-stage burner	X	X	—	—	—	—	6.7.5
Start-up two-stage or multi-stage burner at corresponding first stage point	X	X	—	—	—	X	6.7.5
C _x H _y \leq 10 ml/m ³ ^b	X	X	X	X	X	X	5.5.3
Smoke number ^c	X	X	X	X	X	X	5.5.2
Resistance to overheating	X	—	—	—	—	—	5.8.2
Temperature of control and safety devices	X	—	—	—	—	—	5.8.3
<p>^a At the end of the test, which is carried out at the maximum mass flow rate, another test is performed at 85 % of rated voltage. The burner start shall occur in a reliable manner (see 6.7.4).</p> <p>^b Except the first 20 s.</p> <p>^c The tests are also to be carried out at the first-stage points corresponding to the points indicated [see Figures 8 a) and 8 b)], and the relevant classes are to be fixed.</p>							

At the end of the test programme it shall be established that

- a) no leakage is evident in the fuel system,
- b) the operational safety of the control equipment is not impaired through contamination.

6.7.2.3 Functional test

After completion of the test, it shall be ascertained, at room temperature, that the burner materials or components do not exhibit any deformation, maladjustment or degradation.

6.7.3 Result of the completed tests, test report

The results of the tests carried out shall be recorded by means of a diagram of operation (see examples shown in Figure 8). The results of the combustion test shall be represented as a record of measurements and shall be attached to the test report.

6.7.4 Electrical voltage conditions

The tests specified in 6.7.2 shall be carried out with an electrical supply voltage equal to 100 % of the rated voltage.

At the end of the test, carried out at the maximum mass flow rate, another test shall be performed at 85 % of the rated voltage with an exception of three-phase a.c. motors, if any. The burner shall ignite in a reliable manner.

In the case of multi-stage burners, this test shall be carried out at the start rate given by the manufacturer.

6.7.5 Starting test

In the starting test, the pressure amplitudes in the combustion chamber of the test equipment shall be reduced to those of the operating conditions at the end of the starting phase.

The starting phase begins when the fuel is released and ends after 5 s.

Single-stage burners shall be set for measuring points 1 and 2 [see Figure 8 a)] to the combustion values detailed in 6.7.2.2, as well as to the mass flow rate given by the manufacturer, and shall then be switched off. The starting test shall be carried out for measuring points 1 and 2.

Multi-stage burners shall be set for measuring points 1, 2 and 6 [see Figure 8 b)] to the combustion values detailed in 6.7.2.2. The starting test shall be carried out for measuring in the corresponding first stage point.

A starting test in accordance with Figure 9 shall be carried out for burners with mass flow rates less than or equal to 15 kg/h.

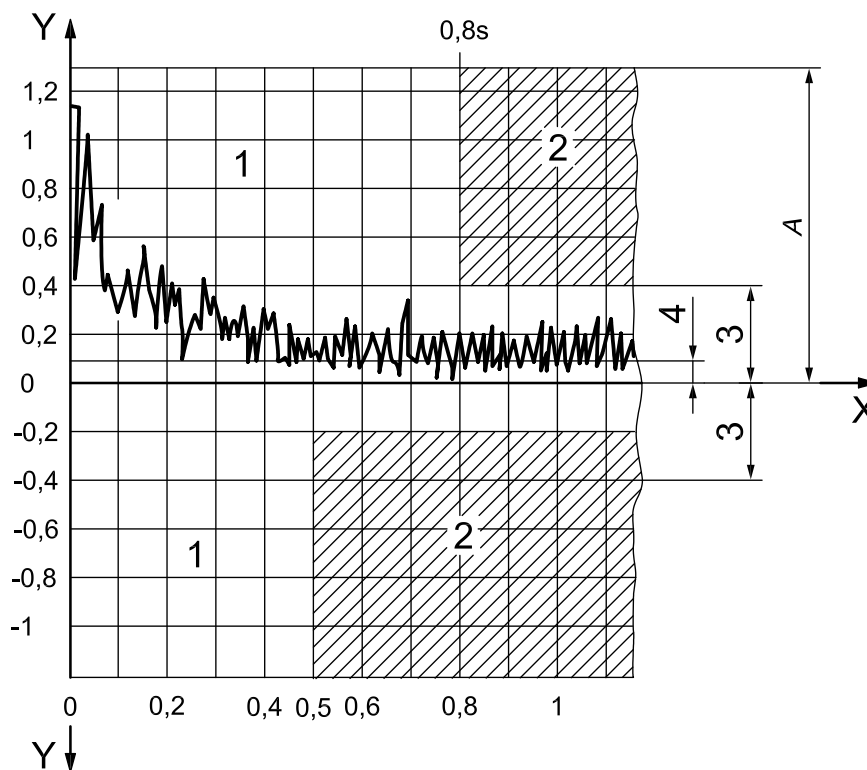

Key

- X time, s
- Y combustion chamber pressure, p_F , kPa
- A maximum pressure amplitude
- 1 admissible
- 2 not admissible
- 3 $0,25 \times A$ or 0,3 kPa
- 4 combustion chamber counter pressure

Figure 9 — Ignition pressure amplitude (e.g. at 0,1 kPa) in combustion chamber (e.g. at point 2 of operational diagram)

The burners shall be started 3 min after switching off, whereby the values of the starting variations in the combustion chamber, at the above-mentioned measuring points, shall reduce within 0,8 s to at least 25 % of the maximum starting value or 0,3 kPa.

Pressure peaks which are less than the combustion pressure but which exceed the maximum starting values by 25 % may occur only during the first 0,5 s. The maximum value of the pressure amplitudes in excess of the combustion chamber pressure is used as reference value.

The behaviour of the burner (i.e. verification of starting amplitudes) shall be recorded by means of a pressure sensor with recording device. The measurement point for the pressures in the combustion chamber shall be on the front plate, above the burner.

The measuring sensor shall be flush with the inner wall of the burner connecting plate. Its length is 250 mm and shall not have an absorptive attenuator. The internal diameter shall be constant up to the pressure sensor.

The measuring system of the pressure sensor up to the record choice shall have a linear frequency range from 0 Hz up to 1 300 Hz. The linearity tolerance shall not exceed 10 % in this range.

6.7.6 Testing during continuous operation in the case of two-stage, multi-stage or modulating burners

For the test the values for the excess air ratio shown in Figure 1 shall be satisfied and the requirements of 6.1 to 6.7.5 shall be met.

Constant operating conditions pertain if it is established that when carrying out two consecutive measurements, the CO₂ content of the combustion gases does not change by more than 0,2 %.

After constant operating conditions have been attained, it shall be checked that

- there is no impermissible temperature increase of the components at maximum load at the end of the test,
- no leaks have appeared in the fuel system,
- there is no contamination adversely affecting the safe operation or efficiency of the supervision devices, and
- there is no impermissible post-injection on shut-down.

See also Figure 10.

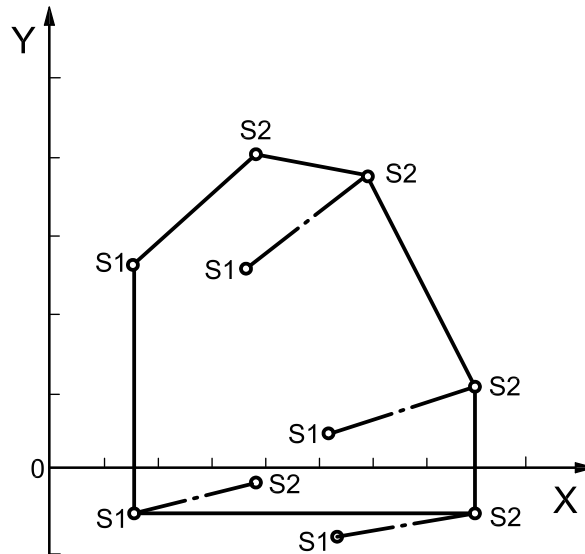

Key

- S1 first stage or min. throughput for modulating burner
- S2 highest stage or max. throughput for modulating burner
- X mass flow rate, kg/h
- Y combustion chamber pressure, p_F , kPa

Figure 10 — Working diagram of operation points and rating of two-stage, multi-stage or modulating burners

6.7.7 Burners with separate fan

For burners with a separately installed fan, the requirements of 6.7.6 are deemed to have been met if the burner is tested with the maximum size and, where appropriate, with the minimum size, fan and with the selection procedure for intermediate fans indicated in the framework of the type test to the laboratory. A different type designation for the burner is not required in this case.

6.8 Replacement of individual parts and equivalent components

Replacement of individual oil burner parts that have been tested with all the required additional devices as one unit is only possible if they are replaced with equivalent parts. The apparatus then still complies with the requirements of this International Standard (see E.2.4).

Components and subgroups are considered as equivalent replacement parts if it has been established that they have the same safety function and suitability.

6.9 Electrical safety

Examination of the electrical equipment and connections of the burner as specified in 5.1.2.2 shall be carried out visually, by functional test or by measurement.

The burner manufacturer shall provide a detailed declaration of conformity showing that the requirements of 5.1.2.2 have been fulfilled.

The electrical connections for, and the correct integration of, the individual components shall be examined by means of the electrical wiring diagram provided by the manufacturer.

7 Conformity evaluation

For conformity evaluation, see Annex E.

If a conformity evaluation is carried out, it should be done by a test laboratory accredited in accordance with ISO/IEC 17025.

If the manufacturer and the test laboratory are identical the requirements of Annex E apply accordingly.

8 Marking, labelling and packaging

8.1 General

The burner, its packaging and other relevant components shall be marked with the information specified in 8.2, 8.3 and 8.5.

8.2 Data plate

Each burner shall have fitted in a visible position after installation — but not after the removal of part of the case — a data plate stating in indelible characters and as a minimum the following:

- a) name, address and/or the trade mark of the manufacturer;
- b) serial number and year of manufacture (coded);
- c) trade name under which the burner is presented for testing;
- d) nominal heat input expressed in kilowatts (kW) and, where necessary, the fuel consumption in kilograms per hour (kg/h);
- e) for range-rated burners, the maximum nominal and minimum nominal heat inputs expressed in kilowatts (kW);
- f) fuel type and/or viscosity range;
- g) electrical supply type (i.e. direct or alternating) and voltage;
- h) burner power consumption.

8.3 Other markings

The burner shall carry a suitable plate or durable label indelibly marked with the following:

“This burner shall be installed in accordance with the rules in force at the place of installation and according to the manufacturer’s instructions.”

The burner shall also carry all useful information relating to any electrical equipment, particularly the voltage and the current to be used and the appropriate insulation code in accordance with IEC 60529.

Permanent warning notices shall be provided in readily visible positions on the burner stating that the burner is to be switched off and the gas supply isolated before any servicing operation is carried out.

8.4 Instructions for application, installation, commissioning, adjustment, maintenance and operation

8.4.1 Application, installation, commissioning and adjustment

The burner shall be accompanied by instructions giving information regarding its correct application, installation, commissioning, adjustment, maintenance and operation, such as the following:

- a) that the burner shall be commissioned prior to automatic operation;
- b) appropriate warning notes shall be included in the instructions;
- c) that each burner shall only be installed, set-up, adjusted and maintained by suitably trained and certified personnel;
- d) that all oil line components shall be assembled and mounted without bending, torque or other mechanical or thermal stress;
- e) a declaration as to which measures are to be taken to minimize the risk of accident throughout the foreseeable lifetime of the burner and its safety equipment;
- f) information about the application of firing aggressive oils (e.g. biofuel);
- g) an indication of how to connect external safety limiters to the burner control system and a declaration as to whether the burner will go only to a safety shut-down or to a non-volatile lock-out.

A commissioning report showing on site measured data noted by qualified and trained technicians is required. The measured data values shall be available on site and shall include, as a minimum, the following:

- a) fuel type;
- b) calorific value;
- c) fuel flow rate;
- d) minimum and maximum heat output rates;
- e) start heat input;
- f) fuel supply pressure;
- g) adjusted fuel pressures;
- h) CO and CO₂ percentage (or O₂ percentage) content of the flue gases;
- i) combustion air temperature;
- j) flue gas temperature;
- k) heat load rate (kWh/m³ or kWh/m²).

All documents shall show a date of issue.

In addition, the instructions shall include a wiring diagram and details of control box sequencing.

The fuel type suitable for the burner shall be stated.

The installation instructions shall contain full details of the intended range of operation as well as the parameters necessary for matching the burner to the appliance (e.g. working field, connection details). In addition, details shall be included on the fuel supply connection for the burner, the burner head, inlet pressure, pressure monitoring and adjustment pressure.

In addition, where the burner has been designed for operation in a combustion chamber whose dimensions are significantly different from those of the test flame tube then this shall be indicated in the instructions for installation.

8.4.2 Operation and maintenance

Each burner shall be accompanied by instructions giving relevant information on its correct operation and maintenance. In each case these documents shall show a date of issue.

A simplified electrical connection diagram shall be made available for display at or near the electrical junction box.

The fuel types suitable for the burner shall be stated.

The operating instructions shall provide information on the mode of use of monitoring devices fitted to the burner. The operating instructions shall also contain details of the measures to be taken in the event of a fault or an emergency.

Concise instructions for the user concerning the procedure for start-up and shut-down of the burner shall be made available for display at or near the burner.

All instructions shall be given in the official language(s) of the direct country or countries of destination.

Provide information regarding the wear parts and adequate changing/lifetime periods in which they have to be exchanged to incorporate adequate safety margins.

8.5 Marking on the packaging

The packaging shall be marked with at least the fuel type and/or viscosity range.

In addition, the burner packaging shall carry a label indelibly marked with

“This burner shall be installed in accordance with the rules in force. Consult the instructions before installation and use of this burner.”

Annex A (normative)

Smoke number

A.1 Apparatus and test method

A.1.1 Pump (manual), capable of drawing a volume of $160 \text{ cm}^3 \pm 5 \%$ through an effective filtering surface of 6 mm diameter in a single action of the pump (i.e. approximately $570 \text{ cm}^3 \pm 5 \%$ per cm^2 of effective filtering surface); the piston stroke of the pump shall be approximately 200 mm.

The tightening of the paper fixing device, carried out with the paper placed in the recess provided, shall give sufficient water-tightness to prevent the formation of condensate and heating during the first operation of the pump.

The distance travelled by the gases from the sampling point to the filtering surface shall not exceed 40 cm, except in the case of special flue gas duct conditions, to be indicated in the test report.

A.1.2 Sampling tube, with an internal diameter of 6 mm.

A.1.3 Filter paper, with a reflection factor of $85 \% \pm 2,5 \%$ determined photometrically. For this, the filter paper shall be placed on a white surface having a reflection factor of 75 % or more.

The passage of air through the filter paper, at a rate of $3 \text{ dm}^3/\text{cm}^2$ per min, shall give a pressure drop of between 2 kPa and 10 kPa.

A.1.4 Smoke number scale, comprising ten printed grades spaced at regular intervals from white to dark grey, consisting of a white material with a reflection factor of $85 \% \pm 2,5 \%$. The reflection of the first sample corresponds to that of the background paper and refers to smoke number 0. The identification number of each of the following grades is equal to a tenth of the reduction rate, expressed in a percentage of the reflection of incident light on the corresponding sample. Number 6, for example, corresponds to a reduction rate of 60 %.

The tolerance for the deviations in reflection factor for each of the points of the scale shall not exceed 3 % of its value.

A.2 Smoke measuring

The test method specified in A.1 may be applied by means of an electronic sampling device, provided that the test index, compared by the person performing the test with the comparison scale or shown as a value by the appliance, corresponds to that method.

A.3 Determination of the smoke number

Loosen the paper fixing device, insert the filter paper in the slot provided in the pump and tighten the device.

Place the sampling probe perpendicular to the flow direction of the combustion gases. Leak-tightness shall be assured between the probe and the wall of the pipe in which the sample is taken. Samples may be taken either with a hand pump or with the aid of an electromechanical pump.

If a hand pump (A.1.1) is used, carry out ten suction actions, each of which shall be regular and of a duration between 2 s and 3 s. Withdraw the tube from the gas duct, unscrew the fixing device and carefully take out the filter paper.

If an electronic smoke measuring device is used, the measuring head is to be placed on the blackening mark such that only the reflections of the blackening mark and no other parts of the filter paper are taken.

Annex B (normative)

Emission measurements and corrections

B.1 Emission measurements

The measurements shall be made in the connecting duct between the combustion chamber and the chimney, beyond the heat exchanger. For accurate sampling, a representative measuring point shall be chosen in the flow of the combustion products, determined by means of multiple measurements.

The measuring methods used shall be stated in the test report.

For the calibration of the instruments for NO_x measurement, the proper operation of the converter (conversion rate) shall be checked.

B.2 Correction of the influence of combustion air temperature and humidity on NO_x emissions

To correct the influence of combustion air temperature and humidity on Q_{NO_x} emissions to reference conditions 10 g/kg for humidity and 20 °C for temperature, Equation (B.1) shall be used:

$$Q_{NO_{xref}} = Q_{NO_x} + (h_{meas} - 10) \times \left[\frac{0,02 \times Q_{NO_x} - 0,34}{1 - 0,02 \times (h_{meas} - 10)} \right] + 0,85 \times (20 - t_{meas}) \quad (B.1)$$

where

Q_{NO_x} is the calculated NO_x content in mg/kWh, measured at h_{meas} and t_{meas} [referring to the energy input, see Equation (C.1)];

h_{meas} is the humidity in dry air during the measurement of Q_{NO_x} in g/kg;

t_{meas} is the temperature of combustion air during the measurement of Q_{NO_x} in °C;

$Q_{NO_{xref}}$ is the value of NO_x emission corrected to the reference conditions (10 g/kg for humidity and 20 °C for temperature), expressed in mg/kWh.

If the ambient conditions differ from the values above, regional experiences for corrections are to be taken into account. Nevertheless, the conditions shall be within the range given in 6.2.

B.3 Correction of the influence of the nitrogen content of fuel oil in case of NO_x emissions

An analysis of the nitrogen content of the fuel oil used for testing shall be carried out. The nitrogen content should not exceed 200 mg/kg.

Equation (B.2) shall be used for the calculation of the correction:

$$Q_{NO_{xcor}} = Q_{NO_{xref}} - N_{meas} \times 0,2 \quad (B.2)$$

where

- $Q_{NO_x,cor}$ is the value of NO_x corrected to the reference conditions of nitrogen of the fuel oil chosen at 0 mg/kg, in mg/kWh;
- $Q_{NO_x,ref}$ is the value of NO_x emission corrected to the reference conditions (10 g/kg for humidity and 20 °C for temperature), expressed in mg/kWh;
- N_{meas} is the value of the nitrogen content of the fuel oil (mg/kg).

For rating that the requirements of this International Standard are fulfilled, the value $Q_{NO_x,cor}$ shall apply.

B.4 NO_x mean value for evaluating the NO_x classes

Determination of the arithmetical NO_x mean value of the working diagram is given by Equation (B.3):

$$\bar{\varphi}_{NO_x, M} = \sum_{i=1}^n \left(\frac{Q_{NO_x,cor,i}}{n} \right) \quad (B.3)$$

where

- $\bar{\varphi}_{NO_x, M}$ is the arithmetical mean value of the measured nitrogen emission limits in the working diagram;
- $Q_{NO_x,cor, i}$ is the corrected NO_x concentration at the points $i = 1 \dots n$ in the working diagram;
- n is the number of points in the working diagram.

Annex C (informative)

Conversion factors

The conversion factors for emissions are calculated from ml/m³ into mg/kWh referring to the energy input using Equations (C.1) and (C.3).

The conversion factors for emissions are calculated from ml/m³ into mg/m³ at O₂ reference gas conditions using Equations (C.2) and (C.4).

$$Q_{\text{NO}_x} = f_{\text{NO}_x,\text{meas}} \times 2,056 \times \left(\frac{21}{21 - f_{\text{O}_2,\text{meas}}} \right) \times \left(\frac{V_{\text{A,th,tr,min}}}{H_i} \right) \quad (\text{C.1})$$

$$Q_{\text{NO}_x} = f_{\text{NO}_x,\text{meas}} \times 2,056 \times \left(\frac{21 - f_{\text{O}_2,\text{ref}}}{21 - f_{\text{O}_2,\text{meas}}} \right) \quad (\text{C.2})$$

$$Q_{\text{CO}} = f_{\text{CO,meas}} \times 1,25 \times \left(\frac{21}{21 - f_{\text{O}_2,\text{meas}}} \right) \times \left(\frac{V_{\text{A,th,tr,min}}}{H_i} \right) \quad (\text{C.3})$$

$$Q_{\text{CO}} = f_{\text{CO,meas}} \times 1,25 \times \left(\frac{21 - f_{\text{O}_2,\text{ref}}}{21 - f_{\text{O}_2,\text{meas}}} \right) \quad (\text{C.4})$$

where

Q_{NO_x} is the calculated NO_x content in mg/kWh or in mg/m³ at 3 % O₂ in dry flue gas, calculated as NO₂;

$f_{\text{NO}_x,\text{meas}}$ is the measured NO_x emission in ml/m³, volumetric;

Q_{CO} is the carbon monoxide content in mg/kWh, referring to the energy input;

$f_{\text{CO,meas}}$ is the measured concentration, expressed in ml/m³ by volume of carbon monoxide in the sample taken during the combustion test;

$f_{\text{O}_2,\text{ref}}$ is the O₂ reference gas condition (3 % oxygen in dry flue gas);

$f_{\text{O}_2,\text{meas}}$ is the measured O₂ concentration in the gaseous combustion products;

2,056 is the density of NO₂ (kg/m³);

1,25 is the density of CO (kg/m³);

H_i is the inferior calorific value;

$V_{\text{A, th, tr, min}}$ is the theoretical reference volume, dry.

Reference values:

H_i is 11,86 kWh/kg;

$V_{A, th, tr, min}$ is 10,46 m³/kg.

For calculation, either the reference or real values of the fuel oil may be used.

Annex D (normative)

FID measuring method for recording the unburnt hydrocarbons

D.1 Measuring system

The measurement shall be carried out using a flame ionization detector (FID).

The complete measuring system shall be controlled at a minimum temperature of 180 °C. The transverse sensitivity of oxygen and other components shall be taken into account.

A mixture of H₂/H_c is recommended as the burning gas.

D.2 Starting

The measuring line shall be periodically cleaned and checked with a neutral gas before testing commences.

Annex E (informative)

Conformity evaluation

E.1 Test laboratories and test samples, procedure

E.1.1 Test laboratories

Atomizing oil burners conformant with this International Standard are subjected to a type test by a test laboratory as specified in ISO/IEC 17025.

E.1.2 Test samples

Each type of oil burner shall be tested as a complete unit.

The suppliers provide certification for the electrical accessories of the oil burner and the control and monitoring devices to state that they meet the requirements of the relevant International Standards.

If a different accessory is used than was previously, its suitability should also be established. Proof is regarded as having been submitted if this accessory has already been tested by one of the test laboratories (where appropriate in a different apparatus) and has been found safe for use.

If one manufacturer produces oil burners of different inputs but of the same design and with the same accessories, generally it is adequate to test two oil burners of different burner inputs. Generally, the smallest and largest burner of one series type are subjected to a complete type test. Intermediate sizes may be covered by a drawing test if the type test has been successful and test certificates are available from the manufacturer for the intermediate sizes. If one of these two requirements is not met, the test laboratory decides on the type of test for the intermediate sizes.

E.2 Types of test and test documents for oil burners

E.2.1 Type test

The type test is a test requested by the manufacturer to establish whether an oil burner meets the requirements of the standard. For this, it is generally sufficient for the manufacturer to make available to the test laboratory two oil burners of different burner inputs from one design series.

If requested, an authorized representative of the manufacturer may be present at the tests.

The type test is carried out as a functional test and as an endurance test as specified in 6.7. The applicant is informed of the result of the test by means of a written report.

E.2.2 Type test in the overall system

At the manufacturer's request the test may be carried out with the burners built into appliances (e.g. heat generators, systems).

E.2.3 Drawing test

The manufacturer may request a drawing test if

- changes or supplements have been made to the burner design compared to the previous design, or
- oil burners of different input stages of the same construction have been manufactured by a manufacturer but proof of conformity with the standard has only been supplied for individual input stages (see E.1.2).

The extent of the drawing test depends on whether the changes resulting from one or the other of the above possibilities has an effect on conformity with this International Standard.

Oil burners having been successfully tested on the basis of a drawing test are regarded as being in conformance with this International Standard.

E.2.4 Supplementary test

The supplementary test is a test to establish the effect on its method of operation of devices subsequently built into the oil burner.

The supplementary test is generally carried out if the design of individual parts of the oil burner has been changed.

The manufacturer should submit an oil burner that has already been tested by the relevant test laboratory for a supplementary test if, following the type tests, it has undergone technical changes which call into question its conformance with this International Standard.

If agreed with a test laboratory, a supplementary test may be dispensed with if it is simply question of a necessary adaptation of type-tested oil burners to a specific installation because of the effects of the fuel, combustion chamber or system.

Here it is assumed that changes to the air ducts, air pressure, nozzle systems and mixing devices, and to air/fuel-control systems are necessary.

These measures are only permitted if

- a) they are carried out by trained personnel,
- b) the flame stability is maintained,
- c) the heat input is not increased,
- d) safety criteria are not diminished,
- e) the combustion characteristic values (e.g. for CO contents, CO₂ contents and smoke number) remain within the permissible limits, and
- f) the success of the measures taken is documented by records for the test laboratory.

E.2.5 Type retest

Anyone may apply for type retesting of oil burners at the competent test laboratory if questioning conformity of the oil burner with this International Standard.

The type retest shall be carried out by one of the accredited independent test laboratories that receive an adequate number of the test samples from a works or commercial store via its representative.

The type retest shall be carried out basically as a type test. If the objections cover one or a few individual requirements of the standard, the type retest may be carried out as a supplementary or drawing test at the discretion of the test laboratory.

If there are deviations from conformity of the oil burner with this International Standard, the manufacturer claiming conformance may be forbidden from putting the type designation on the particular oil burner.

E.2.6 Test documentation for oil burners

The test laboratory requires the manufacturer or operator of the system (applicant) to submit the following documents, in duplicate:

- a) permanent drawings (e.g. photocopies), which should include the necessary cross-sectional diagrams so that they give a clear picture of the design of the oil burner and all its major parts, with the submission of an assembly drawing also recommended;
- b) a photograph of the oil burner;
- c) a description of the oil burner containing details of the type of construction and the design, including instructions for installation and information regarding its input range(s);
- d) information on equipping the oil burner with electrical accessories and their designation, manufacturer and types, including information on which parts belong to the normal equipment;
- e) a declaration by the manufacturer that the electrical accessories and their assembly conform with the relevant International Standards;
- f) details on the type designation of the oil burner;
- g) a declaration by the manufacturer that the materials meet all the chemical, mechanical and thermal requirements;
- h) information on the fuel oil grade specified in the scope, the maximum permissible viscosity and oil mass flow rate for which the oil burner is intended;
- i) information regarding the installed load of the oil burner;
- j) instructions for installation, adjustment and operation of the oil burner and circuit, wiring or function diagrams, with dimensions given in metric units.

Annex F (informative)

Examples of equipping of burners

F.1 Burners less than or equal to 30 kg/h

See Figures F.1 to F.4.

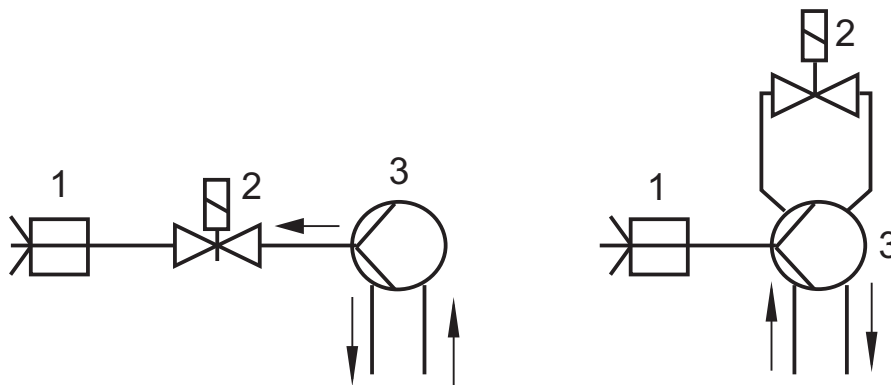

Key

- 1 nozzle
- 2 safety shut-off device
- 3 oil pump

Figure F.1 — One-stage oil burners or two-stage oil burners with pressure variation (one-way or two-way systems)

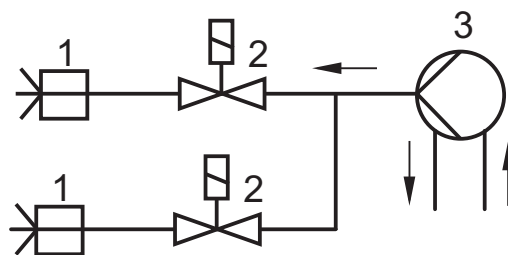

Key

- 1 nozzle
- 2 safety shut-off device
- 3 oil pump

Figure F.2 — Two-stage oil burners with two nozzles

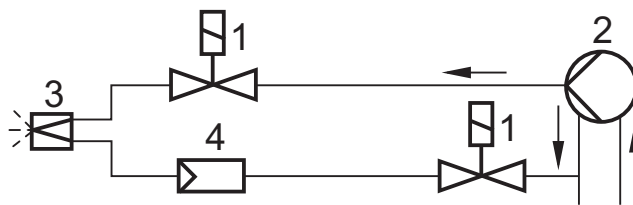

Key

- 1 safety shut-off device
- 2 oil pump
- 3 spill-back nozzle
- 4 output regulator

Figure F.3 — Oil burners with spill-back nozzle and without nozzle shut-off valve

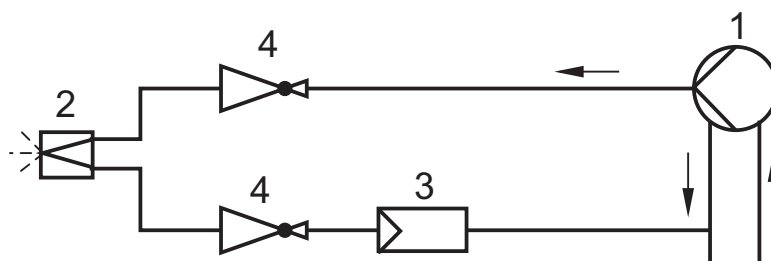

Key

- 1 oil pump
- 2 spill-back nozzle
- 3 output regulator
- 4 nozzle shut-off valve

Figure F.4 — Oil burners with spill-back nozzle and nozzle shut-off valve

F.2 Burners greater than 30 kg/h

See Figures F.5 to F.7.

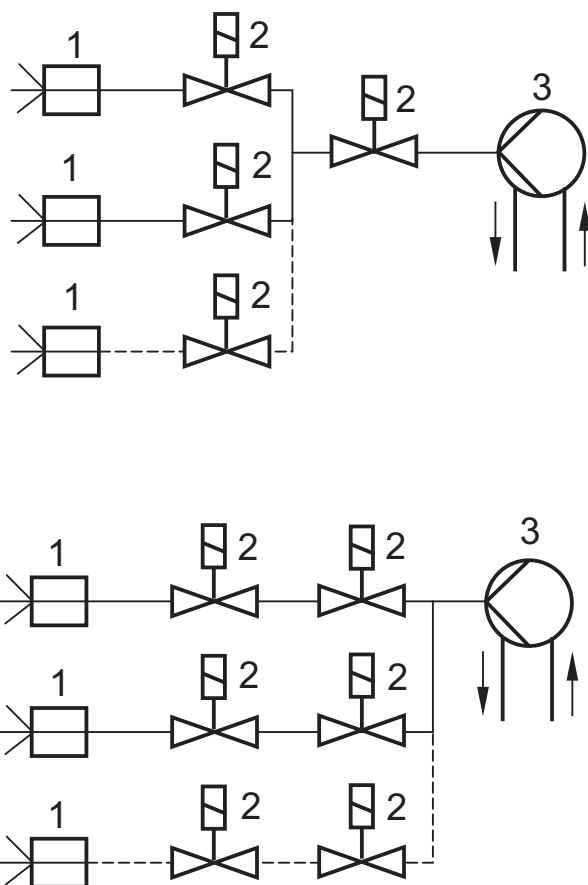

- Key**
- 1 nozzle
 - 2 safety shut-off device
 - 3 oil pump

Figure F.5 — Two-stage oil burners with two nozzles or multi-stage oil burners

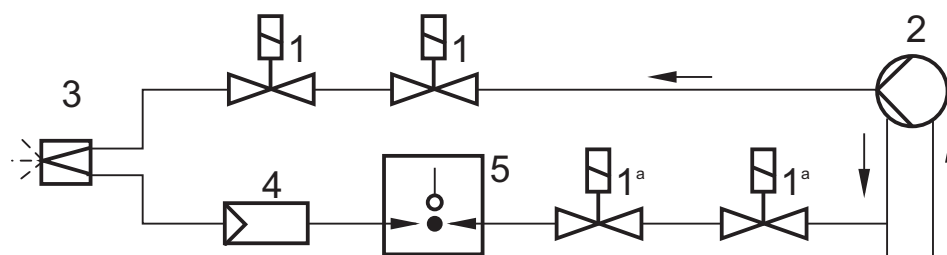

- Key**
- 1 safety shut-off device
 - 2 oil pump
 - 3 spill-back nozzle
 - 4 output regulator
 - 5 pressure switch
 - ^a Check damper or other system, tested in accordance with ISO 23553-1.

Figure F.6 — Oil burners with spill-back nozzle and without nozzle shut-off valve

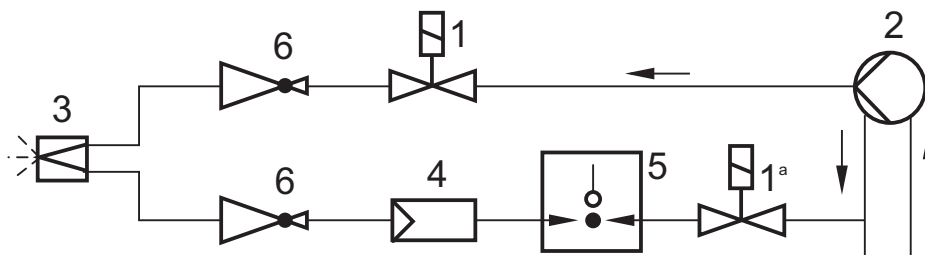

Key

- 1 safety shut-off device
- 2 oil pump
- 3 spill-back nozzle
- 4 output regulator
- 5 pressure switch
- 6 nozzle shut-off valve
- ^a Check damper or other system, tested in accordance with ISO 23553-1.

Figure F.7 — Oil burners with spill-back nozzle and nozzle shut-off valve

Annex G (informative)

Additional recommendations for specific applications

G.1 General

The suitability of a burner in conformance with this International Standard for an application outside the scope of this International Standard should be assessed and agreed between the burner manufacturer and the user, taking into account any local statutory requirements.

G.2 Pre-heating of the combustion air

If a conformant burner is operated with pre-heated combustion air, then the temperature of the combustion air should not exceed 50 K above the ambient temperature.

If operated within this recommended limit:

- surface temperatures of knobs and levers intended to be manipulated should not exceed the ambient temperature by more than the values given in 5.8.3;
- components should not exceed the maximum temperatures declared by the component manufacturer or supplier;
- flame stability should not be affected during initial start-up of the burner at any rate.

Pre-heating of combustion air may limit the working diagram.

G.3 Continuous working of the forced draught fan

Modifications are necessary for the air-proving device to make it possible to check the *no-flow state* prior to start-up (see 5.1.2.9).

G.4 Variable excess of combustion air

The values shown in Figure 1 may not apply for oil burners outside the scope of this International Standard. For example, burners used in drying ovens can require the supply of additional excess air.

The flame should be stable under all conditions and the combustion should be in accordance with this International Standard.

G.5 Burners with spark ignition

For burners with spark ignition it should be guaranteed that under all conditions of operation of the main burner it can be ignited by the spark.

The main flame sensor should be so positioned that it cannot under any circumstances detect the ignition spark.

G.6 Air filtering

In a dusty environment it may be necessary to fit a combustion air inlet filter and the function of the air-proving device may be thus impacted (see 5.1.2.9).

© ISO 2010

Annex H (informative)

Air-proving device check

The operation of the air-proving device is checked alternatively at the lowest or highest input. The air pressure can be changed, among other possibilities, by

- changing the motor speed,
- closing the air damper, or
- closing the air inlet openings.

A non-volatile lock-out occurs before a critical operating mode is reached in the burner operating stage.

During the test on the flame tube the mode of operation of the air-proving device should be checked in reference to the burner design. Installation influences (e.g. flue installation, boiler, installation room or air supply) on the air-proving device and its adjustment have to be taken into account during operation.

Annex I (normative)

Regional requirements specific to European countries

General

Only those subclauses in this International Standard that are affected by requirements specific to European countries have been identified in this annex, numbered correspondingly to the respective subclauses in the main body of the standard.

The requirements of this annex shall ensure a level of safety at least equivalent to that provided by the requirements in the main body of this International Standard.

Requirements

I.5.1.2.8.5 Pressurized pre-heaters

Replaces 5.1.2.8.5:

For pressurized vessels and pre-heaters, the requirements for pressure vessels shall be applied.

Pre-heaters shall be designed for 1,5 times the permissible operating pressure.

If the pre-heater is used in a closed system, an overpressure protection shall be provided.

Functioning of the necessary overpressure protection shall be ensured by suitable temperature.

I.5.5.4 Emission classes for burners

Modifies Table 2:

The CO value given in Table 2 for class 0 shall be less 110 mg/kWh.

Annex J (normative)

Requirements specific to Japan

General

Only those subclauses in this International Standard that are affected by requirements specific to Japan have been identified in this annex, numbered correspondingly to the respective subclauses in the main body of the standard.

The requirements of this annex shall ensure a level of safety at least equivalent to that provided by the requirements in the main body of this International Standard.

For other national requirements not specified in this annex, see the Japanese national standards given in the Bibliography.

Normative references

For the purposes of this annex, the following normative references apply.

JIS G 3452, *Carbon steel pipes for ordinary piping*

JIS G 3454, *Carbon steel pipes for pressure service*

JIS G 3455, *Carbon steel pipes for high pressure service*

JIS G 3456, *Carbon steel pipes for high temperature service*

JIS H 3300, *Copper and copper alloy seamless pipes and tubes*

JIS K 6343, *Rubber hoses for oil discharge*

Requirements

J.5.1.1.1 Materials

Replaces last paragraph of 5.1.1.1:

The pipework material shall be in accordance with JIS G 3452, JIS G 3454, JIS G 3455, JIS G 3456 and JIS H 3300, as appropriate.

J.5.1.2.4 Installation of automatic burner control unit

Replaces 5.1.2.4:

The control panel shall conform with the electrical requirements of IEC 60204-1.

J.5.1.2.5 Rubber hoses and hose assemblies

Replaces first paragraph of 5.1.2.5:

Rubber hoses and hose assemblies shall be in accordance with JIS K 6343.

J.5.1.2.6 Connections

Additional to 5.1.2.6:

For 15A or smaller pipe diameter, threads shall conform to ISO 7-1 for use at the cock's outlet or in a seal plug of a piping joint.

For junctions of taper pipe threads, tapes or liquid sealing materials shall be permitted.

J.5.1.2.10.1 General

Replaces second paragraph of 5.1.2.10.1:

The extinction safety time shall not exceed 4 s.

As specified in JIS B 8415, the extinction safety time, including the closing time for the safety shut-off valve, shall not exceed 5 s.

J.5.2.4 Pre-purging of the combustion chamber

Additional to 5.2.4:

A burner start-up without pre-purge is not permitted.

NOTE Attention is also drawn to national requirements that could apply to specific oil appliances.

J.6 Test methods

Additional to Clause 6:

In burner tests on a substituted actual installation, test conditions which are not appropriate to the actual installation may be converted to the agreed values by agreement of the manufacturers.

Annex K (normative)

Requirements specific to Australia

General

Only those subclauses in this International Standard that are affected by requirements specific to Australia have been identified in this annex, numbered correspondingly to the respective subclauses in the main body of the standard.

The requirements of this annex shall ensure a level of safety at least equivalent to that provided by the requirements in the main body of this International Standard.

For other national requirements not specified in this annex, see the Australian national standards given in the Bibliography.

Normative references

For the purposes of this annex, the following normative references apply.

AS 1375, *Industrial fuel-fired appliances*

Requirements

K.5.2.2 Ignition safety times for start-up

Additional to 5.2.2:

The requirements given in AS 1375 concerning “critical energy” and “critical time” shall also apply.

Annex L (normative)

Requirements specific to Korea

General

Only those subclauses in this International Standard that are affected by requirements specific to Korea have been identified in this annex, numbered correspondingly to the respective subclauses in the main body of the standard.

The requirements of this annex shall ensure a level of safety at least equivalent to that provided by the requirements in the main body of this International Standard.

For other national requirements not specified in this annex, see the Korean national standards given in the Bibliography.

Normative references

For the purposes of this annex, the following normative references apply.

KS B 0429, *General rules for cast iron pipe flanges*

KS D 3507, *Carbon steel pipes for ordinary piping*

KS D 3562, *Carbon steel pipes for pressure service*

KS D 3564, *Carbon steel pipes for high pressure service*

KS D 3570, *Carbon steel pipes for high temperature service*

KS D 5301, *Copper and copper alloy seamless pipes and tubes*

KS M 6546, *Rubber hoses for oil discharge*

Requirements

L.5.1.1.1 Materials

Replaces last paragraph of 5.1.1.1:

The pipe work material shall be in accordance with KS D 3507, KS D 3562, KS D 3564, KS D 3570 and KS D 5301, as appropriate.

L.5.1.2.4 Installation of automatic burner control unit

Replaces 5.1.2.4:

For non-domestic oil applications, the installation and wiring of the burner shall be in accordance with IEC 60204-1.

L.5.1.2.5 Rubber hoses and hose assemblies

Replaces first paragraph of 5.1.2.5:

Rubber hoses and hose assemblies shall be in accordance with KS M 6546.

L.5.1.2.6 Connections

Replaces second paragraph of 5.1.2.6:

For 15A or smaller pipe diameter, threads conformant with ISO 7-1 shall be allowed for use at the cock's outlet or in a seal plug of a piping joint.

For junctions of taper pipe threads, tapes or liquid sealing materials shall be permitted.

Annex M (normative)

Requirements specific to the USA

General

Only those provisions of this International Standard that are affected by requirements specific to the USA have been identified in this annex, using numbers corresponding to those of the respective subclauses in the main body of the standard.

The requirements of this annex shall ensure a level of safety at least equivalent to that provided by the requirements in the main body of this International Standard.

Normative references

For the purposes of this annex, the following normative references apply.

ANSI/ASME B1.20.1, *Pipe Threads, General Purpose (Inch)*

ANSI/ASME B16.1, *Cast Iron Pipe Flanges and Flanged Fittings Class 25, 125, 250, and 800*

NEMA 250, *Enclosures for Electrical Equipment (1000 Volts Maximum)*

UL 372, *Primary Safety Controls for Gas- and Oil-Fired Appliances*

UL 296, *Oil Burners*

UL 795, *Commercial-Industrial Gas Heating Equipment*

ANSI/UL 1998, *Software in Programmable Components*

Requirements

M.5.1.2.6 Connections

Replaces second paragraph of 5.1.2.6:

Threads are required to comply with ANSI/ASME B1.20.1 [national pipe thread taper (NPT)].

Flanges are required to be constructed in accordance with the dimensional specifications for Class 125 cast iron flanges given in ANSI/ASME B16.1.

M.5.1.2.7 Safety shut-off devices and oil pressure switches

Replaces 5.1.2.7.2 and 5.1.2.7.3:

M.5.1.2.7.2 Burners with a flow rate of less than 90 g/h

A burner having an input of less than 90 g/h (340 l/hr) shall be equipped with two safety shut-off valves or one safety shut-off valve, and a nozzle cut-off valve integral to the fuel unit shall be provided.

M.5.1.2.7.3 Burners with a flow rate of greater than 90 g/h

A burner having an input of 90 g/h (340 l/hr) or greater shall be equipped with two safety shut-off valves in series, each with proof of closure interlock function.

M.5.1.2.10 Flame detector devices

Replaces 5.1.2.10.1:

Flame detector devices shall meet the requirements of UL 372, UL 296, UL 795 and ANSI/UL 1998.

The flame detector device shall be suitable for the particular thermal rating and mode of operation of the burner (intermittent or permanent operation). When installed on the burner, it shall conform with protective category NEMA 1 for enclosed conditions, and with protective category NEMA 4 for installations in the open air, in accordance with NEMA 250.

NOTE NEMA 1 exceeds IP 20 requirements and NEMA 4 exceeds IP 65 requirements.

The flame extinction safety time (flame failure response time) shall not be more than 4 s.

Annex N (informative)

Electrical interfaces for burners

See Tables N.1 to N.3.

Table N.1 — Electrical power supply of the burner

Signal	Description	Type of signal	Note	Type of signal for the burner		Type of signal for the appliance		Possible terminal designation
				Input	Output	Input	Output	
1-1	Electrical power supply L1	U_N	Draught fan motor	X			X	X-BU 1-1
1-2	Electrical power supply L2	U_N	Draught fan motor	X			X	X-BU 1-2
1-3	Electrical power supply L3	U_N	Draught fan motor	X			X	X-BU 1-3
1-4	Electrical power supply PE	U_N	Draught fan motor	X			X	X-BU 1-4
1-5	Electrical power supply phase	U_N	Burner control	X			X	X-BU 1-5
1-6	Electrical power supply neutral	U_N	Burner control	X			X	X-BU 1-6
1-7	Electrical power supply PE	U_N	Burner control	X			X	X-BU 1-7
1-8	Electrical power supply L1	U_N	If required for additional burner devices.	X			X	X-BU 1-8
1-9	Electrical power supply L2	U_N		X			X	X-BU 1-9
1-10	Electrical power supply L3	U_N		X			X	X-BU 1-10
1-11	Electrical power supply PE	U_N		X			X	X-BU 1-11

Table N.2 — control signals

Signal	Description	Type of signal	Note	Type of signal for the burner		Type of signal for the appliance		Possible terminal designation
				Input	Output	Input	Output	
2-1	Safety chain	Potential-free	Non-volatile lock-out Signal uncritical for EMC > 50 V	X			X	X-BU 2-1
2-2	Safety chain	Potential-free	Non-volatile lock-out Signal uncritical for EMC > 50 V		X	X		X-BU 2-2
2-3	Release of burner start up	Potential-free	Volatile lock-out Signal uncritical for EMC > 50 V	X			X	X-BU 2-3
2-4	Release of burner start up	Potential-free	Volatile lock-out Signal uncritical for EMC > 50 V		X	X		X-BU 2-4
2-5	Burner request	Potential-free	Regular shut-down Signal uncritical for EMC > 50 V	X			X	X-BU 2-5
2-6	Burner request	Potential-free	Regular shut-down Signal uncritical for EMC > 50 V		X	X		X-BU 2-6
2-7	Burner lock-out	Potential related	– Signal uncritical for EMC > 50 V		X	X		X-BU 2-7
2-8	Burner operation	Potential related	– Signal uncritical for EMC > 50 V		X	X		X-BU 2-8
2-9	Load request signal	Potential-free from load regulator	Com (root) Signal uncritical for EMC > 50 V	X			X	X-BU 2-9
2-10	Load request signal	Potential-free from load regulator	Close (ref. to 2.9) Signal uncritical for EMC > 50 V	X			X	X-BU 2-10
2-11	Load request signal	Potential-free from load regulator	Open (ref. to 2-9) Signal uncritical for EMC > 50 V	X			X	X-BU 2-11
2-12	Stage load request	Potential-free from load regulator	2nd stage (ref. to 2-9) Signal uncritical for EMC > 50 V	X			X	X-BU 2-12

Table N.2 (continued)

Signal	Description	Type of signal	Note	Type of signal for the burner		Type of signal for the appliance		Possible terminal designation
				Input	Output	Input	Output	
2-13	Stage load request	Potential-free from load regulator	3rd stage (ref. to 2-9) Signal uncritical for EMC > 50 V	X			X	X-BU 2-13
2-14	Constant load request	Electrically separated from load regulator	Mod + Signal critical for EMC < 50 V	X			X	X-BU 3-01
2-15	Constant load request	Electrically separated from load regulator	Mod – Signal critical for EMC < 50 V		X	X		X-BU 3-02
2-16	Constant load request	—	Shield Signal critical for EMC < 50 V		X	X		X-BU 3-03
2-17	Pre-selection second fuel	Potential-free	– Signal uncritical for EMC > 50 V	X			X	X-BU 2-14
2-18	Pre-selection second fuel	Potential-free	– Signal uncritical for EMC > 50 V		X	X		X-BU 2-15

Table N.3 — Optional signals

Signal	Description	Type of signal	Note	Type of signal for the burner		Type of signal for the appliance		Possible terminal designation
				Input	Output	Input	Output	
3-1	Load setting feedback signal	EI. separated	+ Signal critical for EMC < 50 V		X	X		X-BU 3-04
3-2	Load setting feedback signal	EI. separated	– Signal critical for EMC < 50 V	X			X	X-BU 3-05
3-3	Load setting feedback signal	—	Shield Signal critical for EMC < 50 V	X			X	X-BU 3-06
3-4	Load setting feedback signal	Potentiometer	A = start Signal critical for EMC < 50 V		X	X		X-BU 3-07
3-5	Load setting feedback signal	Potentiometer	S = slider Signal critical for EMC < 50 V	X			X	X-BU 3-08

Table N.3 (continued)

Signal	Description	Type of signal	Note	Type of signal for the burner		Type of signal for the appliance		Possible terminal designation
				Input	Output	Input	Output	
3-6	Load setting feedback signal	Potentiometer	E = end Signal critical for EMC < 50 V		X	X		X-BU 3-09
3-7	Gas pressure monitor min.	Potential related	0 = good Signal uncritical for EMC > 50 V		X	X		X-BU 4-01
3-8	Gas pressure monitor max.	Potential related	0 = good Signal uncritical for EMC > 50 V		X	X		X-BU 4-02
3-9	Oil pressure monitor min.	Potential related	0 = good Signal uncritical for EMC > 50 V		X	X		X-BU 4-03
3-10	Oil pressure monitor max.	Potential related	0 = good Signal uncritical for EMC > 50 V		X	X		X-BU 4-04
3-11	Gas valve proving system	Potential related	0 = good Signal uncritical for EMC > 50 V		X	X		X-BU 4-05
3-12	Draught fan failure	Potential related	0 = good (motor; frequency inverter, overcurrent) Signal uncritical for EMC > 50 V		X	X		X-BU 4-06
3-13	Burner oil pump	Potential related	0 = good (motor; overcurrent) Signal uncritical for EMC > 50 V		X	X		X-BU 4-07
3-14	Feedback signal for fuel pre-selection	Potential related	0 = fuel 1 Signal uncritical for EMC > 50 V		X	X		X-BU 4-08
3-15	External reset	Potential-free	Contact shut-down = unlock (push-button) Signal uncritical for EMC > 50 V	X			X	X-BU 4-09
3-16	External reset	Potential-free	Contact shut-down = unlock (push button) Signal uncritical for EMC > 50 V		X	X		X-BU 4-10

Bibliography

International Standards

- [1] ISO 14532, *Natural gas — Vocabulary*

Related Japanese national standards

- [2] JIS B 2220, *Steel pipe flanges*
- [3] JIS B 2239, *Cast iron pipe flanges*
- [4] JIS B 2240, *Copper alloy pipe flanges*
- [5] JIS B 2291, *21 MPa slip-on welding pipe flanges for hydraulic use*
- [6] JIS B 2301, *Screwed type malleable cast iron pipe fittings*
- [7] JIS B 2302, *Screwed type steel pipe fittings*
- [8] JIS B 2311, *Steel butt-welding pipe fittings for ordinary use*
- [9] JIS B 2312, *Steel butt-welding pipe fittings*
- [10] JIS B 2313, *Steel plate butt-welding pipe fittings*
- [11] JIS B 2316, *Steel socket-welding pipe fittings*
- [12] JIS B 2351-1, *Metallic tube connections for fluid power and general use — Part 1: 24 degree compression fittings*
- [13] JIS H 3401, *Pipe fittings of copper and copper alloys*
- [14] JIS B 8415, *General safety code for industrial combustion furnaces*

Related Australian national standards

- [15] AS 3000, *Electrical installations*¹⁾

Related Korean national standards

- [16] KS B 1503, *Steel welding pipe flanges*
- [17] KS B 1531, *Screwed type malleable cast iron pipe fittings*
- [18] KS B 1533, *Screwed type steel pipe fittings*
- [19] KS B 1521, *21 MPa slip-on welding pipe flanges for hydraulic*
- [20] KS B 1522, *Steel butt-welding pipe fittings for ordinary use and fuel gas*
- [21] KS B 1541, *Steel butt-welding pipe fittings*

1) Known as the *Australian/New Zealand Wiring Rules*.

- [22] KS B 1542, *Steel socket-welding pipe fittings*
- [23] KS B 1543, *Steel plate butt-welding pipe fittings*
- [24] KS B ISO 8434-1, *Metallic tube connections for fluid power and general use — Part 1: 24 degree compression fittings*
- [25] KS D 5578, *Pipe fittings of copper and copper alloys*

www.bsi.org.uk

ICS 27.060.10

Price based on 76 pages

British Standards Institution (BSI)

BSI is the independent national body responsible for preparing British Standards and other standards-related publications, information and services.

It presents the UK view on standards in Europe and at the international level.

It is incorporated by Royal Charter.

Revisions

British Standards are updated by amendment or revision. Users of British Standards should make sure that they possess the latest amendments or editions.

It is the constant aim of BSI to improve the quality of our products and services. We would be grateful if anyone finding an inaccuracy or ambiguity while using this British Standard would inform the Secretary of the technical committee responsible, the identity of which can be found on the inside front cover.

Tel: +44 (0)20 8996 9001 Fax: +44 (0)20 8996 7001

BSI offers Members an individual updating service called PLUS which ensures that subscribers automatically receive the latest editions of standards.

Tel: +44 (0)20 8996 7669 Fax: +44 (0)20 8996 7001

Email: plus@bsigroup.com

Buying standards

You may buy PDF and hard copy versions of standards directly using a credit card from the BSI Shop on the website www.bsigroup.com/shop. In addition all orders for BSI, international and foreign standards publications can be addressed to BSI Customer Services.

Tel: +44 (0)20 8996 9001 Fax: +44 (0)20 8996 7001

Email: orders@bsigroup.com

In response to orders for international standards, it is BSI policy to supply the BSI implementation of those that have been published as British Standards, unless otherwise requested.

Information on standards

BSI provides a wide range of information on national, European and international standards through its Knowledge Centre.

Tel: +44 (0)20 8996 7004 Fax: +44 (0)20 8996 7005

Email: knowledgecentre@bsigroup.com

Various BSI electronic information services are also available which give details on all its products and services.

Tel: +44 (0)20 8996 7111 Fax: +44 (0)20 8996 7048

Email: info@bsigroup.com

BSI Subscribing Members are kept up to date with standards developments and receive substantial discounts on the purchase price of standards. For details of these and other benefits contact Membership Administration.

Tel: +44 (0)20 8996 7002 Fax: +44 (0)20 8996 7001

Email: membership@bsigroup.com

Information regarding online access to British Standards via British Standards Online can be found at www.bsigroup.com/BSOL

Further information about BSI is available on the BSI website at www.bsigroup.com/standards

Copyright

Copyright subsists in all BSI publications. BSI also holds the copyright, in the UK, of the publications of the international standardization bodies. Except as permitted under the Copyright, Designs and Patents Act 1988 no extract may be reproduced, stored in a retrieval system or transmitted in any form or by any means – electronic, photocopying, recording or otherwise – without prior written permission from BSI. This does not preclude the free use, in the course of implementing the standard of necessary details such as symbols, and size, type or grade designations. If these details are to be used for any other purpose than implementation then the prior written permission of BSI must be obtained. Details and advice can be obtained from the Copyright & Licensing Manager.

Tel: +44 (0)20 8996 7070

Email: copyright@bsigroup.com

BSI Group Headquarters

389 Chiswick High Road London W4 4AL UK

Tel +44 (0)20 8996 9001

Fax +44 (0)20 8996 7001

www.bsigroup.com/standards

raising standards worldwide™

Copyright British Standards Institution
Provided by IHS under license with BSI - Uncontrolled Copy
No reproduction or networking permitted without license from IHS

Not for Resale

