

BS ISO 22663:2015



BSI Standards Publication

# Space data and information transfer systems — Proximity-1 space link protocol — Data link layer

**bsi.**

...making excellence a habit.™

**National foreword**

This British Standard is the UK implementation of ISO 22663:2015. It supersedes BS ISO 22663:2007 which is withdrawn.

The UK participation in its preparation was entrusted to Technical Committee ACE/68, Space systems and operations.

A list of organizations represented on this committee can be obtained on request to its secretary.

This publication does not purport to include all the necessary provisions of a contract. Users are responsible for its correct application.

© The British Standards Institution 2015.  
Published by BSI Standards Limited 2015

ISBN 978 0 580 87628 8

ICS 49.140

**Compliance with a British Standard cannot confer immunity from legal obligations.**

This British Standard was published under the authority of the Standards Policy and Strategy Committee on 31 December 2015.

**Amendments/corrigenda issued since publication**

| Date | Text affected |
|------|---------------|
|------|---------------|

---

---

---

**Space data and information transfer  
systems — Proximity-1 space link  
protocol — Data link layer**

*Systèmes de transfert des informations et données spatiales —  
Protocole pour liaisons spatiales de proximité 1 — Couche de liaisons  
de données*





**COPYRIGHT PROTECTED DOCUMENT**

© ISO 2015, Published in Switzerland

All rights reserved. Unless otherwise specified, no part of this publication may be reproduced or utilized otherwise in any form or by any means, electronic or mechanical, including photocopying, or posting on the internet or an intranet, without prior written permission. Permission can be requested from either ISO at the address below or ISO's member body in the country of the requester.

ISO copyright office  
Ch. de Blandonnet 8 • CP 401  
CH-1214 Vernier, Geneva, Switzerland  
Tel. +41 22 749 01 11  
Fax +41 22 749 09 47  
copyright@iso.org  
www.iso.org

## Foreword

ISO (the International Organization for Standardization) is a worldwide federation of national standards bodies (ISO member bodies). The work of preparing International Standards is normally carried out through ISO technical committees. Each member body interested in a subject for which a technical committee has been established has the right to be represented on that committee. International organizations, governmental and non-governmental, in liaison with ISO, also take part in the work. ISO collaborates closely with the International Electrotechnical Commission (IEC) on all matters of electrotechnical standardization.

International Standards are drafted in accordance with the rules given in the ISO/IEC Directives, Part 2.

The main task of technical committees is to prepare International Standards. Draft International Standards adopted by the technical committees are circulated to the member bodies for voting. Publication as an International Standard requires approval by at least 75 % of the member bodies casting a vote.

Attention is drawn to the possibility that some of the elements of this document may be the subject of patent rights. ISO shall not be held responsible for identifying any or all such patent rights.

ISO 22663 was prepared by the Consultative Committee for Space Data Systems (CCSDS) (as CCSDS 211.0-B-5, December 2013) and was adopted (without modifications except those stated in clause 2 of this International Standard) by Technical Committee ISO/TC 20, *Aircraft and space vehicles*, Subcommittee SC 13, *Space data and information transfer systems*.

This third edition of ISO 22663:2015 cancels and replaces the second edition (ISO 22663:2007), which has been technically revised.





The Consultative Committee for Space Data Systems

---

**Recommendation for Space Data System Standards**

**PROXIMITY-1 SPACE  
LINK PROTOCOL—  
DATA LINK LAYER**

**RECOMMENDED STANDARD**

**CCSDS 211.0-B-5**

**BLUE BOOK**

**December 2013**

## **AUTHORITY**

|           |                               |
|-----------|-------------------------------|
| Issue:    | Recommended Standard, Issue 5 |
| Date:     | December 2013                 |
| Location: | Washington, DC, USA           |

This document has been approved for publication by the Management Council of the Consultative Committee for Space Data Systems (CCSDS) and represents the consensus technical agreement of the participating CCSDS Member Agencies. The procedure for review and authorization of CCSDS documents is detailed in *Organization and Processes for the Consultative Committee for Space Data Systems* (CCSDS A02.1-Y-3), and the record of Agency participation in the authorization of this document can be obtained from the CCSDS Secretariat at the address below.

This document is published and maintained by:

CCSDS Secretariat  
Space Communications and Navigation Office, 7L70  
Space Operations Mission Directorate  
NASA Headquarters  
Washington, DC 20546-0001, USA



## STATEMENT OF INTENT

The Consultative Committee for Space Data Systems (CCSDS) is an organization officially established by the management of its members. The Committee meets periodically to address data systems problems that are common to all participants, and to formulate sound technical solutions to these problems. Inasmuch as participation in the CCSDS is completely voluntary, the results of Committee actions are termed **Recommended Standards** and are not considered binding on any Agency.

This **Recommended Standard** is issued by, and represents the consensus of, the CCSDS members. Endorsement of this **Recommendation** is entirely voluntary. Endorsement, however, indicates the following understandings:

- o Whenever a member establishes a CCSDS-related **standard**, this **standard** will be in accord with the relevant **Recommended Standard**. Establishing such a **standard** does not preclude other provisions which a member may develop.
- o Whenever a member establishes a CCSDS-related **standard**, that member will provide other CCSDS members with the following information:
  - The **standard** itself.
  - The anticipated date of initial operational capability.
  - The anticipated duration of operational service.
- o Specific service arrangements shall be made via memoranda of agreement. Neither this **Recommended Standard** nor any ensuing **standard** is a substitute for a memorandum of agreement.

No later than three years from its date of issuance, this **Recommended Standard** will be reviewed by the CCSDS to determine whether it should: (1) remain in effect without change; (2) be changed to reflect the impact of new technologies, new requirements, or new directions; or (3) be retired or canceled.

In those instances when a new version of a **Recommended Standard** is issued, existing CCSDS-related member standards and implementations are not negated or deemed to be non-CCSDS compatible. It is the responsibility of each member to determine when such standards or implementations are to be modified. Each member is, however, strongly encouraged to direct planning for its new standards and implementations towards the later version of the Recommended Standard.

## **FOREWORD**

Attention is drawn to the possibility that some of the elements of this document may be the subject of patent rights. CCSDS shall not be held responsible for identifying any or all such patent rights.

Through the process of normal evolution, it is expected that expansion, deletion, or modification of this document may occur. This Recommended Standard is therefore subject to CCSDS document management and change control procedures, which are defined in *Organization and Processes for the Consultative Committee for Space Data Systems* (CCSDS A02.1-Y-3). Current versions of CCSDS documents are maintained at the CCSDS Web site:

<http://www.ccsds.org/>

Questions relating to the contents or status of this document should be addressed to the CCSDS Secretariat at the address indicated on page i.

CCSDS RECOMMENDED STANDARD FOR PROXIMITY-1 SPACE DATA LINK PROTOCOL

At time of publication, the active Member and Observer Agencies of the CCSDS were:

Member Agencies

- Agenzia Spaziale Italiana (ASI)/Italy.
- Canadian Space Agency (CSA)/Canada.
- Centre National d’Etudes Spatiales (CNES)/France.
- China National Space Administration (CNSA)/People’s Republic of China.
- Deutsches Zentrum für Luft- und Raumfahrt (DLR)/Germany.
- European Space Agency (ESA)/Europe.
- Federal Space Agency (FSA)/Russian Federation.
- Instituto Nacional de Pesquisas Espaciais (INPE)/Brazil.
- Japan Aerospace Exploration Agency (JAXA)/Japan.
- National Aeronautics and Space Administration (NASA)/USA.
- UK Space Agency/United Kingdom.

Observer Agencies

- Austrian Space Agency (ASA)/Austria.
- Belgian Federal Science Policy Office (BFSP0)/Belgium.
- Central Research Institute of Machine Building (TsNIIMash)/Russian Federation.
- China Satellite Launch and Tracking Control General, Beijing Institute of Tracking and Telecommunications Technology (CLTC/BITTT)/China.
- Chinese Academy of Sciences (CAS)/China.
- Chinese Academy of Space Technology (CAST)/China.
- Commonwealth Scientific and Industrial Research Organization (CSIRO)/Australia.
- Danish National Space Center (DNSC)/Denmark.
- Departamento de Ciência e Tecnologia Aeroespacial (DCTA)/Brazil.
- European Organization for the Exploitation of Meteorological Satellites (EUMETSAT)/Europe.
- European Telecommunications Satellite Organization (EUTELSAT)/Europe.
- Geo-Informatics and Space Technology Development Agency (GISTDA)/Thailand.
- Hellenic National Space Committee (HNSC)/Greece.
- Indian Space Research Organization (ISRO)/India.
- Institute of Space Research (IKI)/Russian Federation.
- KFKI Research Institute for Particle & Nuclear Physics (KFKI)/Hungary.
- Korea Aerospace Research Institute (KARI)/Korea.
- Ministry of Communications (MOC)/Israel.
- National Institute of Information and Communications Technology (NICT)/Japan.
- National Oceanic and Atmospheric Administration (NOAA)/USA.
- National Space Agency of the Republic of Kazakhstan (NSARK)/Kazakhstan.
- National Space Organization (NSPO)/Chinese Taipei.
- Naval Center for Space Technology (NCST)/USA.
- Scientific and Technological Research Council of Turkey (TUBITAK)/Turkey.
- South African National Space Agency (SANSA)/Republic of South Africa.
- Space and Upper Atmosphere Research Commission (SUPARCO)/Pakistan.
- Swedish Space Corporation (SSC)/Sweden.
- Swiss Space Office (SSO)/Switzerland.
- United States Geological Survey (USGS)/USA.

## DOCUMENT CONTROL

| <b>Document</b>    | <b>Title</b>                                                                          | <b>Date</b>      | <b>Status</b>                                                                                                                                                                                                                                                                    |
|--------------------|---------------------------------------------------------------------------------------|------------------|----------------------------------------------------------------------------------------------------------------------------------------------------------------------------------------------------------------------------------------------------------------------------------|
| CCSDS<br>211.0-B-1 | Proximity-1 Space Link Protocol                                                       | October<br>2002  | Original issue,<br>superseded                                                                                                                                                                                                                                                    |
| CCSDS<br>211.0-B-2 | Proximity-1 Space Link Protocol—<br>Data Link Layer                                   | April 2003       | Superseded                                                                                                                                                                                                                                                                       |
| CCSDS<br>211.0-B-3 | Proximity-1 Space Link Protocol—<br>Data Link Layer                                   | May 2004         | Superseded                                                                                                                                                                                                                                                                       |
| CCSDS<br>211.0-B-4 | Proximity-1 Space Link Protocol—<br>Data Link Layer, Recommended<br>Standard, Issue 4 | July 2006        | Superseded                                                                                                                                                                                                                                                                       |
| CCSDS<br>211.0-B-5 | Proximity-1 Space Link Protocol—<br>Data Link Layer, Recommended<br>Standard, Issue 5 | December<br>2013 | Current issue:<br><br>This update includes<br>several improvements and<br>clarifications—<br>accomplishing better<br>alignment and<br>consistency with the other<br>Proximity-1 Blue<br>Books—and the addition<br>of an option for Low-<br>Density Parity-Check<br>(LDPC) codes. |

NOTE – Changes from the previous issue are too numerous to permit markup.

## CONTENTS

| <u>Section</u>                                                                           | <u>Page</u> |
|------------------------------------------------------------------------------------------|-------------|
| <b>1 INTRODUCTION</b> .....                                                              | <b>1-1</b>  |
| 1.1 PURPOSE.....                                                                         | 1-1         |
| 1.2 SCOPE.....                                                                           | 1-1         |
| 1.3 APPLICABILITY.....                                                                   | 1-1         |
| 1.4 RATIONALE.....                                                                       | 1-2         |
| 1.5 CONVENTIONS AND DEFINITIONS.....                                                     | 1-2         |
| 1.6 REFERENCES.....                                                                      | 1-7         |
| <b>2 OVERVIEW</b> .....                                                                  | <b>2-1</b>  |
| 2.1 CONCEPT OF PROXIMITY-1.....                                                          | 2-1         |
| 2.2 OVERVIEW OF SERVICES.....                                                            | 2-6         |
| <b>3 PROTOCOL DATA UNITS</b> .....                                                       | <b>3-1</b>  |
| 3.1 OVERVIEW—CONTEXT OF THE VERSION-3 TRANSFER FRAME.....                                | 3-1         |
| 3.2 VERSION-3 TRANSFER FRAME.....                                                        | 3-1         |
| <b>4 DATA LINK LAYER</b> .....                                                           | <b>4-1</b>  |
| 4.1 FRAME SUBLAYER.....                                                                  | 4-1         |
| 4.2 MEDIUM ACCESS CONTROL SUBLAYER.....                                                  | 4-2         |
| 4.3 DATA SERVICES SUBLAYER.....                                                          | 4-5         |
| 4.4 INPUT/OUTPUT SUBLAYER.....                                                           | 4-7         |
| <b>5 PROXIMITY-1 TIMING SERVICES</b> .....                                               | <b>5-1</b>  |
| 5.1 OVERVIEW.....                                                                        | 5-1         |
| 5.2 TIME TAG RECORDING.....                                                              | 5-1         |
| 5.3 TIME CORRELATION PROCESS.....                                                        | 5-2         |
| 5.4 TRANSFERRING TIME TO A REMOTE ASSET.....                                             | 5-3         |
| <b>6 DATA SERVICES OPERATIONS</b> .....                                                  | <b>6-1</b>  |
| 6.1 OVERVIEW.....                                                                        | 6-1         |
| 6.2 PROXIMITY-1 STATE TABLES.....                                                        | 6-1         |
| 6.3 ELEMENTS AND EVENTS THAT AFFECT STATE STATUS.....                                    | 6-14        |
| 6.4 STATE TRANSITION TABLES AND DIAGRAMS.....                                            | 6-19        |
| 6.5 INTERFACES WITH THE PHYSICAL LAYER (VIA CODING AND<br>SYNCHRONIZATION SUBLAYER)..... | 6-31        |

## CONTENTS (continued)

| <u>Section</u>                                                                                                       | <u>Page</u> |
|----------------------------------------------------------------------------------------------------------------------|-------------|
| 6.6 SENDING OPERATIONS .....                                                                                         | 6-32        |
| 6.7 RECEIVING OPERATIONS .....                                                                                       | 6-34        |
| <b>7 COMMUNICATION OPERATIONS PROCEDURE FOR PROXIMITY LINKS .....</b>                                                | <b>7-1</b>  |
| 7.1 OVERVIEW .....                                                                                                   | 7-1         |
| 7.2 SENDING PROCEDURES (FOP-P) .....                                                                                 | 7-1         |
| 7.3 RECEIVING PROCEDURES (FARM-P) .....                                                                              | 7-7         |
| <b>8 INPUT/OUTPUT SUBLAYER OPERATIONS .....</b>                                                                      | <b>8-1</b>  |
| 8.1 OVERVIEW .....                                                                                                   | 8-1         |
| 8.2 SENDING OPERATIONS .....                                                                                         | 8-1         |
| 8.3 RECEIVING OPERATIONS .....                                                                                       | 8-2         |
| <b>ANNEX A PROTOCOL IMPLEMENTATION CONFORMANCE STATEMENT (PICS) PROFORMA (NORMATIVE) .....</b>                       | <b>A-1</b>  |
| <b>ANNEX B VARIABLE-LENGTH SUPERVISORY PROTOCOL DATA FIELD FORMATS (NORMATIVE) .....</b>                             | <b>B-1</b>  |
| <b>ANNEX C MANAGEMENT INFORMATION BASE PARAMETERS (NORMATIVE) .....</b>                                              | <b>C-1</b>  |
| <b>ANNEX D NOTIFICATIONS TO VEHICLE CONTROLLER (NORMATIVE) ...</b>                                                   | <b>D-1</b>  |
| <b>ANNEX E SECURITY, SANA, AND PATENT CONSIDERATIONS (INFORMATIVE) .....</b>                                         | <b>E-1</b>  |
| <b>ANNEX F NASA MARS SURVEYOR PROJECT 2001 ODYSSEY ORBITER PROXIMITY SPACE LINK CAPABILITIES (INFORMATIVE) .....</b> | <b>F-1</b>  |
| <b>ANNEX G NASA MARS RECONNAISSANCE ORBITER 2005 PROXIMITY SPACE LINK CAPABILITIES (INFORMATIVE) .....</b>           | <b>G-1</b>  |
| <b>ANNEX H INFORMATIVE REFERENCES (INFORMATIVE) .....</b>                                                            | <b>H-1</b>  |
| <b>ANNEX I ABBREVIATIONS AND ACRONYMS (INFORMATIVE) .....</b>                                                        | <b>I-1</b>  |
| <b>ANNEX J PROXIMITY-1 DATA FORMAT HIERARCHY (INFORMATIVE) ....</b>                                                  | <b>J-1</b>  |

### Figure

|                                                          |     |
|----------------------------------------------------------|-----|
| 1-1 Bit Numbering Convention .....                       | 1-6 |
| 1-2 Proximity-1 Rate Terminology .....                   | 1-7 |
| 2-1 Proximity-1 Layered Protocol Model .....             | 2-2 |
| 3-1 Proximity-1 Protocol Data Unit Context Diagram ..... | 3-1 |
| 3-2 Version-3 Transfer Frame .....                       | 3-2 |

## CONTENTS (continued)

| <u>Figure</u>                                                                            | <u>Page</u> |
|------------------------------------------------------------------------------------------|-------------|
| 3-3 Transfer Frame Header .....                                                          | 3-3         |
| 3-4 Proximity-1 Transfer Frame Data Field Contents of a U-Frame.....                     | 3-9         |
| 3-5 Proximity Link Control Word Fields.....                                              | 3-13        |
| 4-1 COP-P Process.....                                                                   | 4-6         |
| 5-1 Proximity Time Tag Recording.....                                                    | 5-2         |
| 5-2 Transferring Time to a Remote Asset.....                                             | 5-5         |
| 6-1 Full Duplex State Transition Diagram.....                                            | 6-20        |
| 6-2 Half Duplex State Transition Diagram.....                                            | 6-25        |
| 6-3 Simplex Operations .....                                                             | 6-31        |
| B-1 Type 1 SPDU Data Field Contents.....                                                 | B-2         |
| B-2 SET TRANSMITTER PARAMETERS Directive.....                                            | B-3         |
| B-3 SET CONTROL PARAMETERS Directive.....                                                | B-6         |
| B-4 SET RECEIVER PARAMETERS Directive .....                                              | B-9         |
| B-5 SET V(R) Directive .....                                                             | B-12        |
| B-6 Report Request.....                                                                  | B-13        |
| B-7 SET PL EXTENSIONS .....                                                              | B-15        |
| B-8 Report Source Spacecraft ID .....                                                    | B-19        |
| B-9 Type 2 SPDU Data Field Contents.....                                                 | B-21        |
| F-1 NASA Mars Surveyor Project 2001 Odyssey<br>SET TRANSMITTER PARAMETERS Directive..... | F-2         |
| F-2 NASA Mars Surveyor Project 2001 Odyssey<br>SET RECEIVER PARAMETERS Directive .....   | F-4         |
| F-3 Proximity Link Control Word Fields.....                                              | F-7         |

### Table

|                                                                                                    |      |
|----------------------------------------------------------------------------------------------------|------|
| 3-1 U-Frame Data Field Construction Rules .....                                                    | 3-4  |
| 3-2 Setting the SCID Field and Source-or-Destination Identifier<br>When the Frame Is Created ..... | 3-6  |
| 3-3 SCID Field and Source-or-Destination Identifier When the<br>Frame Is Received .....            | 3-7  |
| 3-4 Segment Header Sequence Flags.....                                                             | 3-10 |
| 3-5 Fixed-Length Supervisory Protocol Data Unit.....                                               | 3-12 |
| 3-6 Variable-Length Supervisory Protocol Data Unit .....                                           | 3-15 |
| 6-1 Proximity-1 Data Services Operations Roadmap .....                                             | 6-1  |
| 6-2 States Independent of the DUPLEX Variable .....                                                | 6-2  |
| 6-3 States When DUPLEX = Full.....                                                                 | 6-3  |
| 6-4 States When DUPLEX = Half.....                                                                 | 6-4  |
| 6-5 States When DUPLEX = Simplex (Receive or Transmit).....                                        | 6-6  |
| 6-6 Proximity-1 Control Variable Initialization Table .....                                        | 6-16 |

## CONTENTS (continued)

| <u>Table</u>                                                                                                            | <u>Page</u> |
|-------------------------------------------------------------------------------------------------------------------------|-------------|
| 6-7 Full Duplex Session Establishment/Data Services State Transition Table .....                                        | 6-21        |
| 6-8 Full Duplex Communication Change State Table .....                                                                  | 6-23        |
| 6-9 Full Duplex Session Termination State Table .....                                                                   | 6-24        |
| 6-10 Half Duplex Session Establishment and Data Services.....                                                           | 6-26        |
| 6-11 Half Duplex Communication Change State Table .....                                                                 | 6-29        |
| 6-12 Half Duplex Session Termination State Table .....                                                                  | 6-29        |
| 6-13 Simplex State Transition Table .....                                                                               | 6-31        |
| 6-14 Data Source Selection for Output Coded Symbol Stream with<br>TRANSMIT = <i>on</i> and MODULATION = <i>on</i> ..... | 6-33        |



## 1 INTRODUCTION

### 1.1 PURPOSE

The purpose of this Recommended Standard is to specify the Data Link Layer used with the Proximity-1 Data Link Coding and Synchronization Sublayer (reference [5]) and Physical Layer (reference [6]). Proximity space links are defined to be short-range, bi-directional, fixed or mobile radio links, generally used to communicate among probes, landers, rovers, orbiting constellations, and orbiting relays. These links are characterized by short time delays, moderate (not weak) signals, and short, independent sessions.

### 1.2 SCOPE

This Recommended Standard defines the Data Link Layer (Framing, Medium Access Control, Data Services, and Input/Output [I/O] Sublayers). The specifications for the protocol data units, framing, media access control, expedited and sequenced-controlled data transfer, timing service, I/O control, and the procedures for establishing and terminating a session between a caller and responder are defined in this document. The Coding and Synchronization Sublayer is defined in the separate CCSDS Recommended Standard entitled, *Proximity-1 Space Link Protocol—Coding and Synchronization Sublayer* (reference [5]). The Physical Layer is defined in the separate CCSDS Recommended Standard entitled, *Proximity-1 Space Link Protocol—Physical Layer* (reference [6]).

This Recommended Standard does not specify a) individual implementations or products, b) implementation of service interfaces within real systems, c) the methods or technologies required to perform the procedures, or d) the management activities required to configure and control the protocol.

### 1.3 APPLICABILITY

This Recommended Standard applies to the creation of Agency standards and to future data communications over space links between CCSDS Agencies in cross-support situations. It applies also to internal Agency links where no cross support is required. It includes specification of the services and protocols for inter-Agency cross support. It is neither a specification of, nor a design for, systems that may be implemented for existing or future missions.

The Recommended Standard specified in this document is to be invoked through the normal standards programs of each CCSDS Agency and is applicable to those missions for which cross support based on capabilities described in this Recommended Standard is anticipated. Where mandatory capabilities are clearly indicated in sections of this Recommended Standard, they must be implemented when this document is used as a basis for cross support. Where options are allowed or implied, implementation of these options is subject to specific bilateral cross-support agreements between the Agencies involved.

## 1.4 RATIONALE

The CCSDS believes it is important to document the rationale underlying the recommendations chosen, so that future evaluations of proposed changes or improvements will not lose sight of previous decisions. Concepts and rationale behind the decisions that formed the basis for Proximity-1 are documented in the CCSDS Proximity-1 Space Link Green Book (reference [H9]).

## 1.5 CONVENTIONS AND DEFINITIONS

### 1.5.1 DEFINITIONS

#### 1.5.1.1 Terms from the Open Systems Interconnection (OSI) Basic Reference Model

This Recommended Standard makes use of a number of terms defined in reference [1]. In this Recommended Standard those terms are used in a generic sense, i.e., in the sense that those terms are generally applicable to any of a variety of technologies that provide for the exchange of information between real systems. Those terms are as follows:

- a) connection;
- b) Data Link Layer;
- c) entity;
- d) Physical Layer;
- e) protocol control information;
- f) protocol data unit;
- g) real system;
- h) segmenting;
- i) service;
- j) service data unit.

#### 1.5.1.2 Terms Defined in This Recommended Standard

For the purposes of this Recommended Standard, the following definitions also apply. Many other terms that pertain to specific items are defined in the appropriate sections.

**asynchronous data link:** A data link consisting of a sequence of variable-length Proximity Link Transmission Units (PLTUs), which are not necessarily concatenated.

**caller and responder:** Initiator and receiver, respectively, in a Proximity space link session.  
A **caller transceiver** is the initiator of the link establishment process and manager of

CCSDS RECOMMENDED STANDARD FOR PROXIMITY-1 SPACE DATA LINK PROTOCOL

negotiation (if required) of the session. A **responder transceiver** typically receives link establishment parameters from the caller. The caller initiates communication between itself and a responder on a prearranged communications channel with predefined controlling parameters. As necessary, the caller and responder may negotiate the controlling parameters for the session (at some level between fully controlled and completely adaptive).

**COP-P:** Communication Operations Procedure for Proximity links (COP-P). The COP-P includes both the FARM-P and FOP-P of the caller and responder unit.

**enterprise:** A project or undertaking, especially one of some scope, complexity, and risk.

**FARM-P:** Frame Acceptance and Reporting Mechanism for Proximity links, for Sequence Controlled service carried out within the receiver in the Proximity-1 link.

**FOP-P:** Frame Operation Procedure for Proximity links, for ordering the output frames for Sequence Controlled service carried out in the transmitter in the Proximity-1 link.

**forward link:** That portion of a Proximity space link in which the caller transmits and the responder receives (typically a command link).

**hailing:** The persistent activity used to establish a Proximity link by a caller to a responder in either full or half duplex. It does not apply to simplex operations.

**hailing channel:** The forward and return frequency pairs that a caller and responder use to establish physical link communications.

**mission phase:** A mission period during which specified communications characteristics are fixed. The transition between two consecutive mission phases may cause an interruption of the communications services.

**PCID:** Physical Channel ID, carried in transfer frames and in PLCWs. The PCID is intended primarily for a receiving system having two concurrently operating transceiver units (primary and backup, for example), where the PCID can be used to select which receiver processes the received frame. It may identify either of two redundant receivers at the receiving end.

**P-frame:** A Version-3 Transfer Frame that contains only self-identified and self-delimited supervisory protocol data units (compare U-frame).

**physical channel:** The Radio Frequency (RF) channel upon which the stream of symbols is transferred over a space link in a single direction.

**PLCW:** Proximity Link Control Word, the protocol data unit for reporting Sequence Controlled service status via the return link from the responder back to the caller.

CCSDS RECOMMENDED STANDARD FOR PROXIMITY-1 SPACE DATA LINK PROTOCOL

**PLTU:** Proximity Link Transmission Unit, the data unit composed of the Attached Synchronization Marker (ASM), the Version-3 Transfer Frame, and the attached Cyclic Redundancy Check (CRC)-32.

**Port ID:** Identifier of the logical or physical port that is the destination for a user's service data unit.

**protocol object:** Directives, PLCWs, or status reports contained within an SPDU.

**Proximity link:** A full-duplex, half-duplex, or simplex link for the transfer of data between Proximity-1 nodes in a session.

**pseudo packet ID:** The temporary packet ID assigned by the protocol to a user's packet within the segmentation process.

**reconnect:** Process in which the caller attempts to rehaul the responder (because of lack of communication progress) during the data services phase within the ongoing session. Upon entering this state, the FARM-P and FOP-P variables of the caller and responder are not reset (in particular their frame sequence counters).

**resynchronization (COP-P):** Process in which a sequence count anomaly is detected by the caller and the caller forces the responder to readjust its Sequence Controlled frame numbers via the SET V(R) activity.

**return link:** That portion of a Proximity space link in which the responder transmits and the caller receives (typically a telemetry link).

**Routing ID:** Unique identifier of a user's packet through the segmentation and reassembly process. It is an internal identifier used by the I/O Sublayer and it consists of a PCID, Port ID, and pseudo packet ID.

**Sent queue (Sent Frame queue):** Temporarily stored Sequence Controlled frames that have been sent but not yet acknowledged by the receiver.

**session:** A dialog between two or more communicating Proximity link transceivers. A session consists of three distinct operational phases: session establishment, data services (which may include resynchronization and/or reconnect subphases), and session termination. Session termination may be coordinated (through the exchange of no-more-data-to-send directives), or if communication is lost (inability to resynchronize or reconnect), the transceivers should eventually independently conclude the dialog is over.

**space link:** A communications link between transmitting and receiving entities, at least one of which is in space.

**SPDU:** Supervisory Protocol Data Unit, used by the local transceiver either to control or to report status to the remote partnered transceiver. Consists of one or more directives, reports, or PLCWs.

**synchronous channel:** A data channel where the symbol data are continuously modulated onto the channel at a fixed data rate. When no PLTU is available for transmission, Idle data is transmitted to maintain the continuous symbol stream.

**U-frame:** A Version-3 Transfer Frame that contains user data information (compare P-frame).

**vehicle controller:** The entity (e.g., spacecraft control computer) which receives the notifications defined in annex D and potentially acts upon them.

**Version-3 Transfer Frame:** A Proximity-1 transfer frame.

## 1.5.2 NOMENCLATURE

### 1.5.2.1 NORMATIVE TEXT

The following conventions apply for the normative specifications in this Recommended Standard:

- a) the words 'shall' and 'must' imply a binding and verifiable specification;
- b) the word 'should' implies an optional, but desirable, specification;
- c) the word 'may' implies an optional specification;
- d) the words 'is', 'are', and 'will' imply statements of fact.

NOTE – These conventions do not imply constraints on diction in text that is clearly informative in nature.

### 1.5.2.2 INFORMATIVE TEXT

In the normative sections of this document, informative text is set off from the normative specifications either in notes or under one of the following subsection headings:

- Overview;
- Background;
- Rationale;
- Discussion.

### 1.5.3 CONVENTIONS

In this document, the following convention is used to identify each bit in an  $N$ -bit field. The first bit in the field to be transmitted (i.e., the most left-justified when drawing a figure) is defined to be ‘Bit 0’, the following bit is defined to be ‘Bit 1’, and so on up to ‘Bit  $N-1$ ’. When the field is used to express a binary value (such as a counter), the Most Significant Bit (MSB) is the first transmitted bit of the field, i.e., ‘Bit 0’, as shown in figure 1-1.

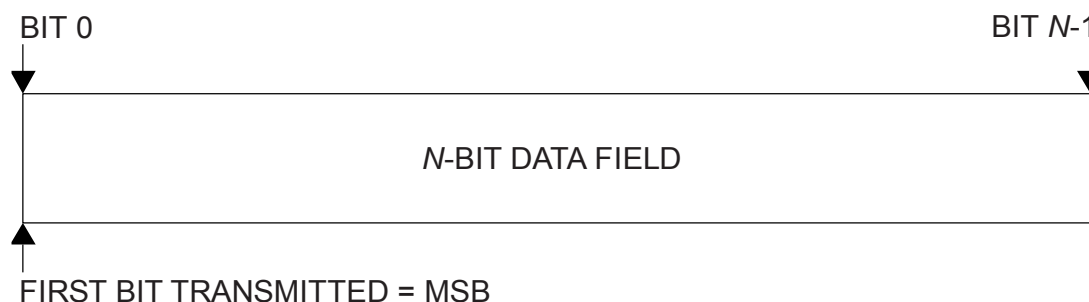

**Figure 1-1: Bit Numbering Convention**

In accordance with standard data-communications practice, data fields are often grouped into 8-bit ‘words’ that conform to the above convention. Throughout this Recommended Standard, such an 8-bit word is called an ‘octet’.

The numbering for octets within a data structure begins with zero. Octet zero is the first octet to be transmitted.

By CCSDS convention, all ‘spare’ bits are permanently set to value ‘zero’.

Throughout this Recommended Standard, directive, parameter, variable, and signal names are presented with all upper-case characters; data-field and Management Information Base (MIB)-parameter names are presented with initial capitalization; values and state names are presented with predominantly lower-case characters, and are italicized.

In Proximity-1, data rate ( $R_d$ ), coded symbol rate ( $R_{cs}$ ), and channel symbol rate ( $R_{chs}$ ) are used to denote respectively:

- the data rate of the bitstream composed by PLTUs and Idle data measured at the encoder input;
- the coded symbol rate measured at the interface between the Coding and Synchronization Sublayer and the Physical Layer; and
- the rate measured at the output of the transmitter.

The terms are used as shown in figure 1-2.

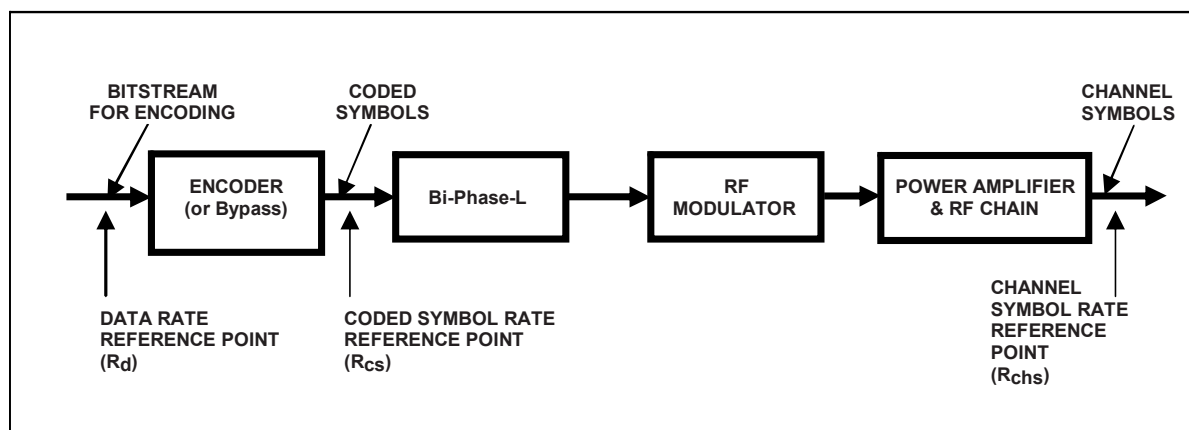

Figure 1-2: Proximity-1 Rate Terminology

## 1.6 REFERENCES

The following publications contain provisions which, through reference in this text, constitute provisions of this document. At the time of publication, the editions indicated were valid. All publications are subject to revision, and users of this document are encouraged to investigate the possibility of applying the most recent editions of the publications indicated below. The CCSDS Secretariat maintains a register of currently valid CCSDS publications.

- [1] *Information Technology—Open Systems Interconnection—Basic Reference Model: The Basic Model*. International Standard, ISO/IEC 7498-1:1994. 2nd ed. Geneva: ISO, 1994.
- [2] *TM Synchronization and Channel Coding*. Issue 2. Recommendation for Space Data System Standards (Blue Book), CCSDS 131.0-B-2. Washington, D.C.: CCSDS, August 2011.
- [3] *CCSDS Global Spacecraft Identification Field Code Assignment Control Procedures*. Issue 6. Recommendation for Space Data System Standards (Blue Book), CCSDS 320.0-B-6. Washington, D.C.: CCSDS, October 2013.
- [4] *Time Code Formats*. Issue 4. Recommendation for Space Data System Standards (Blue Book), CCSDS 301.0-B-4. Washington, D.C.: CCSDS, November 2010.
- [5] *Proximity-1 Space Link Protocol—Coding and Synchronization Sublayer*. Issue 2. Recommendation for Space Data System Standards (Blue Book), CCSDS 211.2-B-2. Washington, D.C.: CCSDS, December 2013.
- [6] *Proximity-1 Space Link Protocol—Physical Layer*. Issue 4. Recommendation for Space Data System Standards (Blue Book), CCSDS 211.1-B-4. Washington, D.C.: CCSDS, December 2013.

## 2 OVERVIEW

### 2.1 CONCEPT OF PROXIMITY-1

Proximity-1 is a bi-directional Space Link Layer protocol for use by space missions. It has been designed to meet the requirements of space missions for efficient transfer of data over various types and characteristics of Proximity space links.

#### 2.1.1 LAYERED MODEL

The Proximity-1 model consists of a Physical Layer (reference [6]) and a Data Link Layer.

Proximity-1 activities are divided between a send side and a receive side. The send side is concerned with the transmitted physical channel, and also with the acquisition of the received physical channel in order to establish a Proximity-1 link. The receive side is concerned with the reception of data on the received physical channel: the input bitstream and the protocol data units it contains.

On the send side, the Data Link Layer is responsible for providing data to be transmitted by the Physical Layer. The operation of the transmitter is state-driven.

On the receive side, the Data Link Layer accepts the serial data output from the receiver and processes the protocol data units received. It accepts directives both from the local vehicle controller and across the Proximity link to control its operations. Once the receiver is turned on, its operation is modeless. It accepts and processes all valid local and remote directives and delivers received service data units to the users.

The interactions of the Proximity-1 layers and associated data and control flows are shown in figure 2-1.

#### 2.1.2 PHYSICAL LAYER

On the send side, the Physical Layer:

- accepts control variables from the Data Link Layer for control of the transceiver;
- accepts a PLTU from the Coding and Synchronization Sublayer for modulation onto the radiated carrier;
- performs the required (as specified by the control variables) channel coding.

On the receive side, the Physical Layer:

- provides status signals (CARRIER\_ACQUIRED and SYMBOL\_INLOCK\_STATUS) to the Data Link Layer;
- outputs the serial coded symbol stream from the receiver's Physical Layer to the Coding and Synchronization Sublayer.



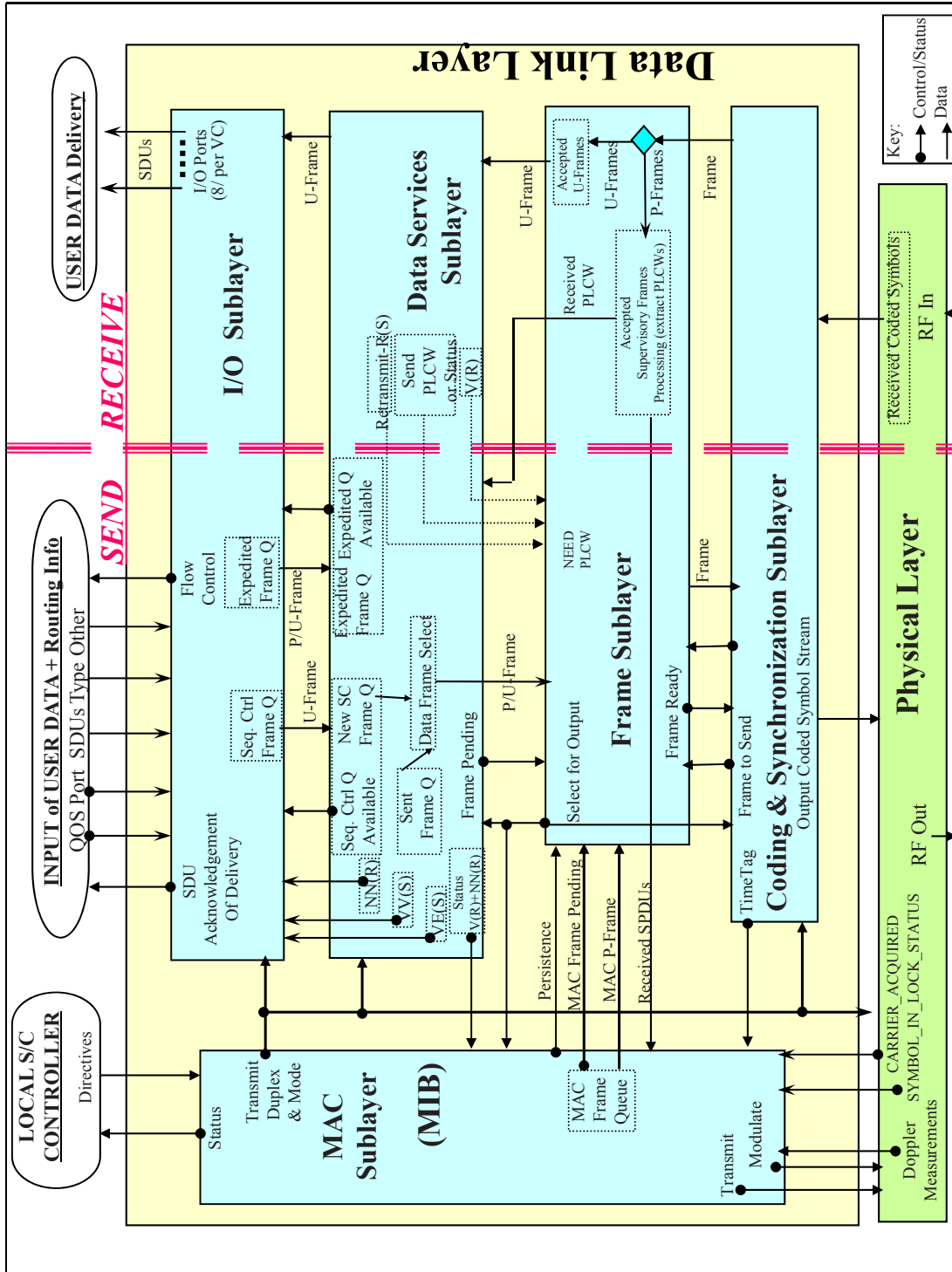

Figure 2-1: Proximity-1 Layered Protocol Model

## **2.1.3 DATA LINK LAYER**

### **2.1.3.1 Sublayers in the Data Link Layer**

There are five component sublayers within the Data Link Layer:

- Coding and Synchronization (C&S) Sublayer;
- Frame Sublayer;
- Medium Access Control (MAC) Sublayer;
- Data Services Sublayer;
- I/O Sublayer.

### **2.1.3.2 Coding and Synchronization Sublayer**

The C&S Sublayer is specified separately in reference [5]. On the send side, the actions of the C&S Sublayer include:

- construction of PLTUs, where each PLTU contains a Version-3 Transfer Frame received from the Frame Sublayer;
- provision of the coded symbol stream (including PLTU and Idle data) to the Physical Layer for inclusion of Idle data, adding channel coding and modulation onto the radiated carrier.

On the receive side, the C&S Sublayer actions include:

- delimiting each PLTU contained in the data output from the receiver in the Physical Layer;
- validation of the PLTUs, including channel decoding;
- for each valid PLTU, delivering the delimited transfer frame to the Frame Sublayer.

On both the send and receive sides, the C&S Sublayer provides time-tagged data on request to support the Proximity-1 timing services.

### **2.1.3.3 Frame Sublayer**

Subsection 4.1 specifies the functions of the Frame Sublayer. On the send side, the Frame Sublayer:

- creates Version-3 Transfer Frames, carrying user data or protocol data (directives and reports) in the frame data field;
- completes the fields in the frame header of a transfer frame;

CCSDS RECOMMENDED STANDARD FOR PROXIMITY-1 SPACE DATA LINK PROTOCOL

- determines the order of frame transmission;
- delivers frames to the C&S Sublayer.

On the receive side, the Frame Sublayer:

- receives frames from the C&S Sublayer;
- completes the frame validation by checking fields in the header of a transfer frame;
- delivers a valid frame to the Data Services Sublayer or to the MAC Sublayer.

#### **2.1.3.4 Medium Access Control Sublayer**

Subsection 4.2 specifies the functions of the MAC Sublayer. The MAC Sublayer:

- controls the establishment, maintenance, and termination of communications sessions for point-to-point communications between Proximity entities;
- accepts Proximity-1 directives both from the local vehicle controller and across the Proximity link to control its operations;
- controls the modification of characteristics, such as data rate changes;
- controls the operational state of the Data Link and Physical Layers, using state control variables (MODE, TRANSMIT, DUPLEX);
- stores and distributes the MIB parameters.

#### **2.1.3.5 Data Services Sublayer**

Subsection 4.3 specifies the functions of the Data Services Sublayer. The Data Services Sublayer includes the COP-P. COP-P provides two qualities of service (Sequence Controlled and Expedited) that determine how reliably data from the sending user are delivered to the receiving user (see 2.2.3).

Section 7 specifies COP-P. On the send side, COP-P defines the FOP-P. On the receive side, COP-P defines the FARM-P.

#### **2.1.3.6 Input/Output Sublayer**

Subsection 4.4 specifies the functions of the I/O Sublayer. The I/O Sublayer provides the user interface between the Proximity-1 protocol and the onboard data systems and applications that use the protocol. On the send side, it accepts user data consisting of Service Data Units (SDUs) and associated routing information. On the receive side it delivers SDUs to the users via frame designated Port IDs.

## 2.1.4 PROTOCOL-UNIQUE FEATURES

### 2.1.4.1 General

The Proximity-1 protocol controls and manages data interchange across the communications link. This Data Link Layer protocol provides the capability to send user data, control reports, and control directives between the transceiver units. The directives are used for selection of communications frequencies, data rates, modulation, coding, and link directionality (full duplex, half duplex, and simplex). The Data Link Layer provides for the transfer of both packets and user-defined data units. All of these units can be transferred using either an Expedited or a Sequence Controlled (reliable) service supportive of applications involving remote space vehicles.

State tables and diagrams describe the actions the protocol takes when responding to events during full-duplex, half-duplex, and simplex operations. (See section 6, Data Services Operations, and section 7, Communication Operations Procedure for Proximity Links.)

The terms ‘transfer frame’ and ‘frame’ in this document refer to the Version-3 Transfer Frame, specified in section 3. Each transfer frame contains a header, which provides information for handling and processing the frame, including its Transfer Frame Data field. This data field contains either SDUs or Supervisory Protocol Data Units (SPDUs).

### 2.1.4.2 Service Data Units

SDUs carry user data from applications in the sending node to applications in the receiving node. A frame with SDU data in its data field is called a user frame (U-frame). The data field of a U-frame can contain an integer number of unsegmented packets, a single packet segment, or a collection of user-provided octets.

### 2.1.4.3 Supervisory Protocol Data Units

SPDUs carry Proximity-1 protocol directives and reports. A frame with SPDUs in its data field is called a protocol frame (P-frame).

Protocol directives are used for configuring and controlling the protocol processor at the receiving node; for the establishment, maintenance, and termination of a communications session; and for the transfer of time-correlation and synchronization data. Protocol reports are used for reporting the configuration and status of the transmitting node.

## 2.1.5 PROXIMITY LINK TRANSMISSION UNIT

The PLTU is the data structure used by the C&S Sublayer. It is flexibly sized to fit its data content, i.e., a variable-length frame containing variable-length packets. The relationship of the frame to the PLTU is shown in figure 3-1.

The PLTU is intended for use on links characterized by short time delays, moderate (not weak) signals, and short, independent sessions. These link characteristics determine the type of Attached Synchronization Marker (ASM) (24-bit), with its associated bit error tolerance for synchronization. A PLTU includes a 32-bit Cyclic Redundancy Check (CRC) for detection of transmission errors. The specification of the PLTU is in reference [5].

Symbol synchronization is maintained in the data channel by the insertion of an idle sequence between PLTUs, and these variable-length PLTUs are only inserted into the data link when a physical connection has been achieved.

### **2.1.6 ADDRESSING**

A triad of addressing capabilities is incorporated for specific functionality within the link. The Spacecraft Identifier (SCID) identifies the source or destination of transfer frames transported in the link connection based upon the Source-or-Destination Identifier. The Physical Channel Identifier (PCID) may identify either of two redundant receivers at the receiving end, capable of supporting both the Sequence Controlled and Expedited services. The Port ID provides the means to route user data internally (at the transceiver's output interface) to specific logical ports, such as applications or transport processes, or to physical ports, such as onboard buses or physical connections (including hardware command decoders).

### **2.1.7 PROTOCOL DESCRIPTION**

The Proximity-1 protocol is described in terms of:

- a) the services provided to the users (transfer of SDUs);
- b) the Protocol Data Units (PDUs);
- c) the protocol directives and reports (SPDUs described in 3.2.4);
- d) the procedures performed by the protocol as described in the state tables.

This protocol specification also defines the requirements for the underlying services provided by the lower layers.

## **2.2 OVERVIEW OF SERVICES**

### **2.2.1 COMMON FEATURES OF SERVICES**

Proximity-1 provides users with data transfer services known as Space Data Link Proximity-1 services. When a user, such as the spacecraft vehicle controller, supplies an SDU for transfer, the user also specifies:

- the PCID;

- the service quality (Sequence Controlled service or Expedited service);
- the Port ID of the destination port.

## 2.2.2 SERVICE TYPES

### 2.2.2.1 General

The Proximity-1 protocol provides data transfer services and timing services. There are two data transfer services: the first accepts and delivers packets, while the second accepts and delivers user-defined data. The timing service provides time tagging upon ingress/egress of selected PLTUs and the transfer of time from sender to receiver. (See 5.1 for details on the Proximity-1 timing service.)

#### 2.2.2.2 CCSDS Packet Delivery Service

The packet delivery service provides for the transfer of packets across the Proximity space link. The packets have a Packet Version Number (PVN) authorized by CCSDS (see reference [H8]). These include CCSDS Space Packets and Encapsulation Packets.

If a packet is greater than the maximum frame data field size it is segmented before being inserted into multiple transfer frames: the packet is reassembled for delivery to the receiving user. When packets are smaller than the maximum frame data field size allowed in the link, then one or more packets can be placed in a single frame.

In this service the delivery process makes use of the Port ID to identify the specific physical or logical port through which the packet is to be routed.

#### 2.2.2.3 User Defined Data Delivery Service

The user-defined data delivery service provides for the transfer of a single user's collection of octets across the Proximity space link. The SDU is an octet-aligned data unit, the format of which is unknown to the service. The service does not use any information from the contents of the SDU.

The SDU is placed in one or more frames as required based upon the size of the SDU. If the SDU is transferred in multiple frames, the service delivers the octets from each frame when the frame is received. Unlike the packet delivery service, the user-defined data delivery service does not reassemble the SDU.

In this service the delivery process makes use of the Port ID to identify the specific physical or logical port through which the octets are to be routed.

#### 2.2.2.4 Timing Services

The Proximity-1 protocol specifies two timing services for both time tagging transfer frames in support of time correlation as well as transferring time to a remote asset. (See section 5.)

### 2.2.3 SERVICE QUALITIES

#### 2.2.3.1 General

The Proximity-1 data services protocol provides two qualities of service (Sequence Controlled and Expedited) that determine how reliably SDUs supplied by the sending user are delivered to the receiving user. The controlling procedure is called COP-P and consists of a FOP-P, used on the sending side of the service, and a FARM-P, used on the receiving side of the service.

Each data transfer with one of the data transfer services has a service quality associated with it. Packetized data units that are larger than the maximum frame size in asynchronous frames can be transferred only by using the segmentation process, utilizing either the Sequence Controlled service or the Expedited service.

#### 2.2.3.2 Sequence Controlled Service

The Sequence Controlled service ensures that data are reliably transferred across the space link and delivered in order, without gaps, errors, or duplications within a single communication session without COP-P resynchronization during the session (see 4.3.2). This service is based on a 'go-back-n' type of Automatic Repeat Queuing (ARQ) procedure that utilizes sequence-control mechanisms of both sending and receiving ends and a standard report (PLCW) returned from the receiving end to the sending end.

SDUs supplied by a sending user for transfer with the Sequence Controlled quality of service are inserted into transfer frames as required and transmitted on a physical channel in the order in which they are presented. SDUs are passed to the receiving user via the identified port. The retransmission mechanism ensures with a high probability of success that:

- a) no SDU is lost;
- b) no SDU is duplicated;
- c) no SDU is delivered out of sequence.

#### 2.2.3.3 Expedited Service

The Expedited service is nominally used with upper-layer protocols that provide their own retransmission features, or in exceptional operational circumstances such as during spacecraft recovery operations.

Expedited SDUs supplied by the sending user are transmitted without ARQ. At the sending end, Expedited SDUs are transmitted on specified physical channels independently of the Sequence Controlled SDUs waiting to be transmitted on the same physical channel. At the receiving end, the SDUs are passed to the receiving user via the identified port. It should be noted that Expedited SDUs may be sent once or multiple times, but they are not sent again as a result of a request for retransmission. If such a request occurs it is performed outside the purview of the protocol.

There is no guarantee that all Expedited SDUs will be delivered to the receiving user. If the packet delivery service is used to transfer packets using segmentation in the Expedited service, then the service delivers only complete packets to the user.

NOTE – In Expedited service the capability is provided to deliver portions of user-defined data units that are greater than the maximum frame size allowed for the link.



### 3 PROTOCOL DATA UNITS

#### 3.1 OVERVIEW—CONTEXT OF THE VERSION-3 TRANSFER FRAME

Figure 3-1 is the Proximity-1 protocol data unit context diagram.

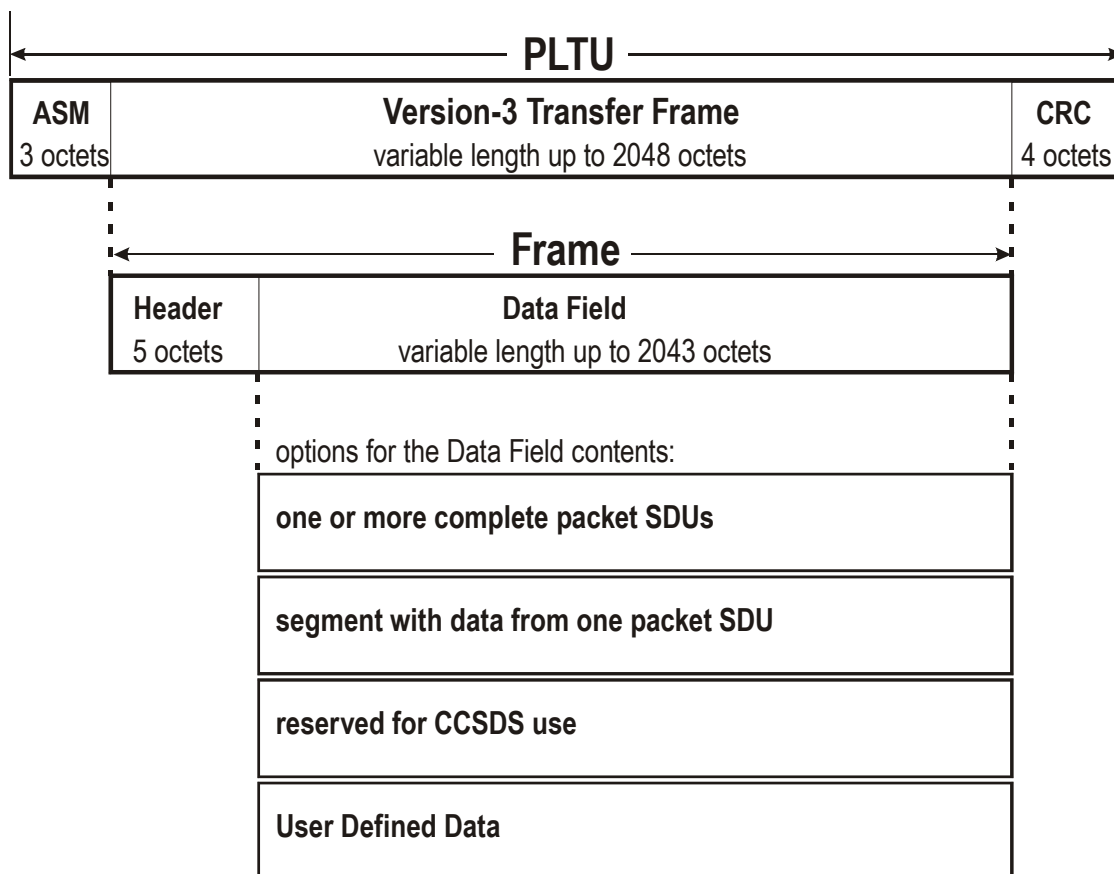

**Figure 3-1: Proximity-1 Protocol Data Unit Context Diagram**

Annex J contains more a detailed decomposition of the Proximity-1 data formats.

#### 3.2 VERSION-3 TRANSFER FRAME

##### 3.2.1 VERSION-3 TRANSFER FRAME STRUCTURE

A Version-3 Transfer Frame shall encompass the following fields, positioned contiguously, in the following sequence:

- a) Transfer Frame Header (5 octets, mandatory);
- b) Transfer Frame Data field (up to 2043 octets).

## NOTES

- 1 The Version-3 Transfer Frame is the PDU transmitted from the send side of the Frame Sublayer at one end of a link to the receive side of the Frame Sublayer at the other end of the link.
- 2 The maximum transfer frame length allowed by a particular spacecraft or ground implementation on a particular physical channel may be less than the maximum specified here.
- 3 The composition of the Version-3 Transfer Frame is shown in figure 3-2.

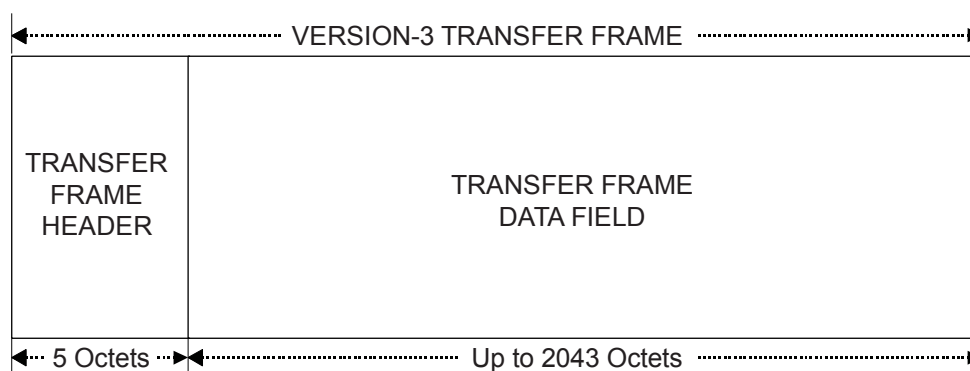

**Figure 3-2: Version-3 Transfer Frame**

### 3.2.2 TRANSFER FRAME HEADER

#### 3.2.2.1 Summary of Header Fields

The Transfer Frame Header is mandatory and shall consist of ten mandatory fields, positioned contiguously, in the following sequence:

- a) Transfer Frame Version Number (2 bits);
- b) Quality of Service (QoS) Indicator (1 bit);
- c) PDU Type ID (1 bit);
- d) Data Field Construction Identifier (DFC ID) (2 bits);
- e) Spacecraft Identifier (SCID) (see reference [3]) (10 bits);
- f) Physical Channel Identifier (PCID) (1 bit);
- g) Port ID (3 bits);
- h) Source-or-Destination Identifier (1 bit);
- i) Frame Length (11 bits);

j) Frame Sequence Number (interpretation is QoS dependent) (8 bits).

NOTE – The format of the Transfer Frame Header is shown in figure 3-3.

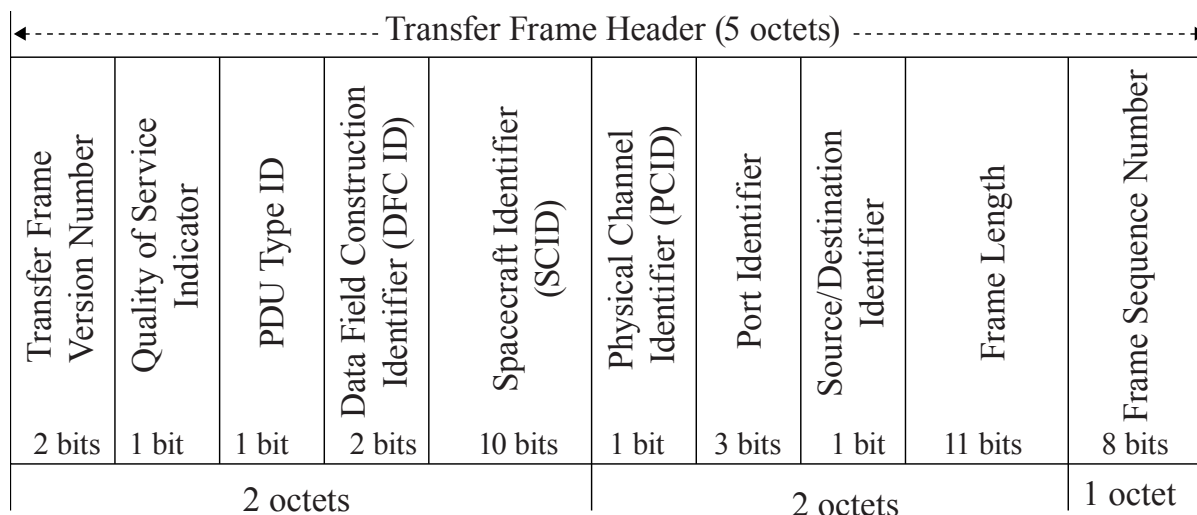

Figure 3-3: Transfer Frame Header

### 3.2.2.2 Transfer Frame Version Number

3.2.2.2.1 Bits 0–1 of the Transfer Frame Header shall contain the Transfer Frame Version Number.

3.2.2.2.2 The Transfer Frame Version Number field shall contain the binary value ‘10’.

NOTE – This Recommended Standard defines the Version-3 Transfer Frame. For other transfer frames defined by CCSDS for use with other protocols (see references [H6] and [H7]).

### 3.2.2.3 Quality of Service Indicator

3.2.2.3.1 Bit 2 of the Transfer Frame Header shall contain the QoS Indicator.

3.2.2.3.2 The QoS Indicator shall indicate the transfer service:

- a) The QoS Indicator is set to ‘0’ for a frame on the Sequence Controlled service.
- b) The QoS Indicator is set to ‘1’ for a frame on the Expedited service.

NOTE – At the receiving end, the COP-P procedures check the frame sequence number of frames on the Sequence Controlled service. Frames on the Expedited service bypass the sequence number check.

### 3.2.2.4 PDU Type ID

3.2.2.4.1 Bit 3 of the Transfer Frame Header shall contain the PDU Type ID.

3.2.2.4.2 The PDU Type ID shall specify whether the Transfer Frame Data field is conveying protocol supervisory data or user data information.

- a) The PDU Type ID is set to '0' when the Transfer Frame Data field contains user data.
- b) The PDU Type ID is set to '1' when the Transfer Frame Data field contains SPDUs.

#### NOTES

- 1 When the PDU Type ID is '0', the Data Field Construction ID indicates the arrangement of user data in the Transfer Frame Data field.
- 2 The SPDUs are specified in 3.2.4.
- 3 A frame with PDU Type ID '0' is called a U-frame, and a frame with PDU Type ID '1' is called a P-frame.

### 3.2.2.5 Data Field Construction ID

3.2.2.5.1 Bits 4–5 of the Transfer Frame Header shall contain the DFC ID.

3.2.2.5.2 In a P-frame, the DFC ID is not used and shall be set to the binary value '00'.

3.2.2.5.3 In a U-Frame, the DFC ID shall indicate the contents of the Transfer Frame Data field as defined in table 3-1.

**Table 3-1: U-Frame Data Field Construction Rules**

| DFC ID | Frame Data Field Content                        | Subsection |
|--------|-------------------------------------------------|------------|
| '00'   | Packets (integer number of unsegmented packets) | 3.2.3.2    |
| '01'   | Segment Data (a complete or segmented packet)   | 3.2.3.3    |
| '10'   | Reserved for future CCSDS definition            | 3.2.3.4    |
| '11'   | User Defined Data                               | 3.2.3.5    |

### 3.2.2.6 Spacecraft Identifier

**3.2.2.6.1** Bits 6–15 of the Transfer Frame Header shall contain the SCID.

**3.2.2.6.2** The 10-bit SCID shall provide the identification of the spacecraft that is either the source or the destination of the data contained in the transfer frame.

#### NOTES

- 1 The Source-or-Destination Identifier specified in 3.2.2.9 indicates whether the SCID identifies the source or destination spacecraft.
- 2 The procedures for the assignment of SCID values for use in Proximity-1 transfer frames are specified in reference [3].

### 3.2.2.7 Physical Channel Identifier

**3.2.2.7.1** Bit 16 of the Transfer Frame Header shall contain the PCID.

#### NOTES

- 1 The PCID is intended primarily for a receiving system having two concurrently operating transceiver units (primary and backup, for example), where the PCID can be used to select which receiver processes the received frame.
- 2 An implementation could treat the PCID as a ‘don’t care’ value and receive both PCID 0 and PCID 1, using the same set of MIB parameters and all state machines, including COP-P, for frames with either value.
- 3 For simplification of operations, if the receiving spacecraft has only one transponder powered at a time, the PCID should not be used for selection of the transponder.

**3.2.2.7.2** If an implementation distinguishes between the two PCID values, each PCID physical channel shall have a completely separate set of MIB parameters and all state machines, including COP-P.

### 3.2.2.8 Port Identifier

**3.2.2.8.1** Bits 17–19 of the Transfer Frame Header shall contain the Port ID.

**3.2.2.8.2** In a P-frame, the Port ID is not used and shall be set to the value ‘0’.

**3.2.2.8.3** In a U-frame, the Port ID shall identify the output port to which the I/O Sublayer delivers the SDUs contained in the frame.

## NOTES

- 1 The Port ID can be used to address different physical or logical connection ports to which user data are routed. For example, a Port ID could designate a physical data port, such as a port to a spacecraft bus, or it could designate a process within the connected command and data handling system.
- 2 There are eight ports, with Port ID values 0 through 7. CCSDS reserved Port ID values are specified in reference [H8].
- 3 The ports are independent of the physical channel assignment. Therefore, all SDUs that are addressed to the same Port ID are delivered to the same port, even if they are transferred with different PCIDs.

### 3.2.2.9 Source-or-Destination Identifier

**3.2.2.9.1** Bit 20 of the Transfer Frame Header shall contain the Source-or-Destination Identifier.

**3.2.2.9.2** The sending node shall set the Source-or-Destination Identifier to indicate the contents of the SCID field as shown in table 3-2.

**Table 3-2: Setting the SCID Field and Source-or-Destination Identifier When the Frame Is Created**

| Source-or-Destination Identifier Value | SCID Field Contents                                                     | Transmitted SCID                      |
|----------------------------------------|-------------------------------------------------------------------------|---------------------------------------|
| 0 (= <i>source</i> )                   | SCID of spacecraft that is sending the frame over this link             | MIB parameter<br>Local Spacecraft ID  |
| 1 (= <i>destination</i> )              | SCID of spacecraft that is intended to receive the frame over this link | MIB parameter<br>Remote Spacecraft ID |

**3.2.2.9.3** The behavior of a receiving node with respect to the SCID field and Source-or-Destination Identifier shall be as shown in table 3-3.

**Table 3-3: SCID Field and Source-or-Destination Identifier When the Frame Is Received**

| Source-or-Destination Identifier Value | Test_Source Value           | SCID Used to Validate              | Subsection(s) That Specify Behavior |
|----------------------------------------|-----------------------------|------------------------------------|-------------------------------------|
| 0 (= source)                           | <i>true</i>                 | MIB parameter Remote Spacecraft ID | 6.2.4.2; 6.7.2 c)                   |
| 0 (= source)                           | <i>false</i>                | No test is performed               | 6.2.4.2; 6.7.2 c)                   |
| 1 (= destination)                      | <i>true</i> or <i>false</i> | MIB Parameter Local Spacecraft ID  | 6.7.2 b)                            |

NOTE – Assignment procedures for SCIDs in Proximity-1 transfer frames are controlled by reference [3].

### 3.2.2.10 Frame Length

**3.2.2.10.1** Bits 21–31 of the Transfer Frame Header shall contain the Frame Length.

**3.2.2.10.2** This 11-bit field shall contain a length count  $C$ , which equals one fewer than the total number of octets in the transfer frame.

- a) The count shall be measured from the first octet of the Transfer Frame Header to the last octet of the Transfer Frame Data field.
- b) The length count  $C$  is expressed as:  $C = (\text{total number of octets in the transfer frame}) - 1$ .

NOTE – The size of the Frame Length field limits the maximum length of a transfer frame to 2048 octets ( $C = 2047$ ). The minimum length is 5 octets ( $C = 4$ ).

### 3.2.2.11 Frame Sequence Number (Sequence Controlled or Expedited)

**3.2.2.11.1** Bits 32–39 of the Transfer Frame Header shall contain the Frame Sequence Number (FSN).

**3.2.2.11.2** The FSN shall increment monotonically and independently for the set of frames assigned to a PCID that are associated with the Sequence Controlled service (QoS Indicator set to '0'). In this case, the FSN is called the Sequence\_Controlled\_FSN (SEQ\_CTRL\_FSN).

**3.2.2.11.3** The FSN shall increment monotonically for the set of frames assigned to a PCID that are associated with the Expedited service (QoS Indicator set to '1'). In this case, the FSN is called the Expedited\_FSN (EXP\_FSN).

## NOTES

- 1 The FSN (controlled within the Data Services Sublayer) for each service is initialized to '0' by the SET INITIALIZE MODE directive (see 6.3.3.1.1.2).
- 2 The SEQ\_CTRL\_FSN enables the Sequence Controlled process to number sequentially and then check the sequence of incoming Sequence Controlled transfer frames.
- 3 The EXP\_FSN is not used in the frame validation process but is required for correlations associated with timing services.
- 4 The FSN is PCID-dependent for both the Sequence Controlled and Expedited services.

### 3.2.3 TRANSFER FRAME DATA FIELD

#### 3.2.3.1 General

The Transfer Frame Data field shall:

- a) follow, without gap, the Transfer Frame Header;
- b) be of variable length;
- c) contain from zero octets up to the lesser of
  - 1) 2043 octets (maximum frame length of 2048 less 5 octets for the frame header),  
or
  - 2) the MIB parameter Maximum\_Frame\_Length less 5 octets;
- d) contain either an integer number of octets of data corresponding to one or more SDUs (U-frame), or an integer number of octets of protocol information (P-frame).

NOTE – In a U-frame, the Transfer Frame Data field contains SDU data and other data fields based upon the DFC ID. (See figure 3-4.)



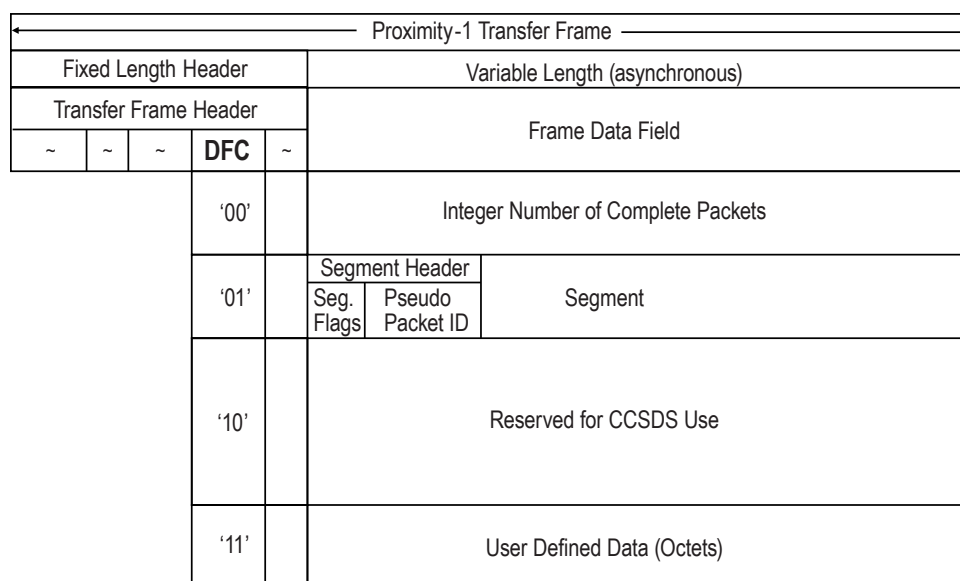

Figure 3-4: Proximity-1 Transfer Frame Data Field Contents of a U-Frame

### 3.2.3.2 Packets in a U-frame

3.2.3.2.1 When the DFC ID field of a U-frame contains the binary value '00', the Frame Data field shall consist of an integer number of packets each designated to the same Port ID and PCID (see figure 3-4).

3.2.3.2.2 The first bit of the Frame Data field shall be the first bit of a packet header.

### 3.2.3.3 Segment Data Units in a U-frame

3.2.3.3.1 When the DFC ID field of a U-frame contains the binary value '01', the Frame Data field shall contain a segment data unit consisting of an 8-bit segment header followed by a segment of a packet (see figure 3-4).

3.2.3.3.2 The contents of the segment header and segment data field shall be as follows:

- a) bits 0 and 1 of the segment header compose the sequence flags, which identify the position of the segment relative to the packet of which the segment is a part as specified in table 3-4;
- b) the remaining 6 bits of the segment header compose an identifier field, the pseudo packet identifier, which is adaptively used to associate all the segments of a packet data unit;
- c) segments are placed into the data link in the following order:
  - 1) segments of the same packet shall be sent in frames of the same PCID and Port ID,

- 2) segments from another packet may be interspersed but only in frames containing a different PCID or Port ID.

**Table 3-4: Segment Header Sequence Flags**

| Sequence Flags | Interpretation                                     |
|----------------|----------------------------------------------------|
| '01'           | first segment                                      |
| '00'           | continuing segment                                 |
| '10'           | last segment                                       |
| '11'           | no segmentation (i.e., contains the entire packet) |

**3.2.3.3.3** Prior to delivery to the user, the Data Link Layer shall re-assemble all the segments using the same Routing ID, i.e., using the same PCID, Port ID, and pseudo packet ID, into a packet.

NOTE – Subsection 1.5.1.2 should be consulted for the definitions of Routing ID and pseudo packet ID.

**3.2.3.3.4** Only complete packets shall be delivered to the user.

**3.2.3.3.5** The accumulated packet shall be discarded and this event shall be logged into the session accountability report whenever any of the following errors occur:

- a) the packet length field does not agree with the number of bytes received and aggregated from the segments;
- b) the first segment received for a Routing ID is not the start segment of the data unit;
- c) the last segment for a Routing ID is not received before the starting segment of a new packet is received.

#### **3.2.3.4 CCSDS Reserved Value (U-frame)**

In a U-frame, the binary value '10' for the DFC ID field is reserved by CCSDS and shall not be used.

#### **3.2.3.5 User-Defined Data in a U-frame**

When the DFC ID field of a U-frame contains the binary value '11', the Frame Data field shall consist of user-defined data (see figure 3-4).

NOTE – The user can choose to transmit only Transfer Frame Headers with the Frame Data field consisting of zero octets.

### 3.2.3.6 Transfer Frame Data Field Contents in a P-frame

In a P-frame, the Transfer Frame Data field shall consist of Supervisory PDUs (SPDUs).

NOTE – SPDUs are specified in 3.2.4.

## 3.2.4 SUPERVISORY PDU

### 3.2.4.1 Overview

The protocol data units discussed below are used by the local transceiver either for local control within the transceiver, or for reporting status to and controlling the remote transceiver.

SPDUs are of either fixed or variable length based upon the value of the SPDU format ID. Currently there is only one fixed-length SPDU defined, i.e., PLCW. Variable-length SPDUs provide the capability for concatenating and multiplexing protocol objects, i.e., directives and status reports. Each SPDU Type is further described in tables 3-5 and 3-6.

SPDUs can be transmitted using only the Expedited QoS (QoS = '1').

SPDUs are all self-identifying and self-delimiting. Only variable-length SPDUs further decompose into specific types of supervisory directives or reports. (See annex B for the detailed specification of variable-length SPDUs.)

### 3.2.4.2 General

**3.2.4.2.1** Fixed-length SPDUs shall consist of the following fields positioned contiguously in the following sequence:

- a) SPDU Header (2 bits) consisting of:
  - 1) SPDU Format ID (1 bit),
  - 2) SPDU Type Identifier (1 bit);
- b) SPDU Data field (14 bits) consisting of either the data field of a fixed-length PLCW or the data field of a CCSDS-reserved SPDU.

**3.2.4.2.2** Variable-length SPDUs shall consist of the following fields positioned contiguously in the following sequence:

- a) SPDU Header (1 octet) consisting of:
  - 1) SPDU Format ID (1 bit),
  - 2) SPDU Type Identifier (3 bits),

- 3) Data Field Length (4 bits) (this represents the actual number of octets in the data field of the SPDU);

NOTE – Data Field Length is not a ‘length minus one’ field.

- b) Supervisory Data field (variable length, i.e., 0 to 15 octets) consisting of one or more supervisory directives or status reports of the same SPDU type.

### 3.2.4.3 Fixed-Length SPDU

#### 3.2.4.3.1 General

A ‘1’ in the SPDU Format ID field shall identify a 16-bit fixed-length SPDU. This format provides for only two fixed SPDUs (see table 3-5), which shall be differentiated by the SPDU Type Identifier field:

- a) a ‘0’ in the SPDU Type Identifier field identifies the SPDU as a PLCW;  
b) a ‘1’ in the SPDU Type Identifier field is reserved for future CCSDS specification.

**Table 3-5: Fixed-Length Supervisory Protocol Data Unit**

| Fixed-Length SPDU<br>(16 bits) | SPDU Header (2 bits)            |                                       | SPDU Data (14 bits)                                                                           |
|--------------------------------|---------------------------------|---------------------------------------|-----------------------------------------------------------------------------------------------|
|                                | SPDU<br>Format<br>ID<br>(Bit 0) | SPDU<br>Type<br>Identifier<br>(Bit 1) | (Contains 1 protocol object, i.e.,<br>directive or report or PLCW)<br><br>(Bits 2 through 15) |
| Type F1                        | ‘1’                             | ‘0’                                   | Fixed Length PLCW<br>(see 3.2.4.3.2)                                                          |
| Type F2                        | ‘1’                             | ‘1’                                   | Reserved for CCSDS Use                                                                        |

#### 3.2.4.3.2 Type F1 SPDU: Proximity Link Control Word

##### 3.2.4.3.2.1 General

**3.2.4.3.2.1.1** The PLCW shall consist of seven fields positioned contiguously in the following sequence (described from least significant bit, Bit 15, to most significant bit, Bit 0—see figure 3-5):

- a) Report Value (8 bits);  
b) Expedited Frame Counter (3 bits);

- c) Reserved Spare (1 bit);
- d) PCID (1 bit);
- e) Retransmit Flag (1 bit);
- f) SPDU Type Identifier (1 bit);
- g) SPDU Format ID (1 bit).

**3.2.4.3.2.1.2** The PLCW shall be transmitted using the Expedited QoS (see 3.2.2.3).

NOTE – The structural components of the PLCW are shown in figure 3-5. (See F4.3 for NASA Mars Surveyor Project 2001 Odyssey PLCW definition.)

|                                   |                                         |                                      |                   |                                |                                             |                                 |        |
|-----------------------------------|-----------------------------------------|--------------------------------------|-------------------|--------------------------------|---------------------------------------------|---------------------------------|--------|
| Bit 0                             |                                         |                                      |                   |                                |                                             |                                 | Bit 15 |
| SPDU Header                       |                                         | SPDU Data Field                      |                   |                                |                                             |                                 |        |
| SPDU<br>Format<br>ID<br><br>1 bit | SPDU<br>Type<br>Identifier<br><br>1 bit | Retrans-<br>mit<br>Flag<br><br>1 bit | PCID<br><br>1 bit | Reserved<br>Spare<br><br>1 bit | Expedited<br>Frame<br>Counter<br><br>3 bits | Report Value<br>(FSN)<br>8 bits |        |

**Figure 3-5: Proximity Link Control Word Fields**

### 3.2.4.3.2.2 Report Value

**3.2.4.3.2.2.1** Bits 8–15 of the PLCW shall contain the Report Value.

**3.2.4.3.2.2.2** The Report Value field shall contain the value of V(R) (see 7.3.2).

**3.2.4.3.2.2.3** Separate Report Values shall be reported for each physical channel independent of the I/O port.

### 3.2.4.3.2.3 Expedited Frame Counter

**3.2.4.3.2.3.1** Bits 5–7 of the PLCW shall contain the EXPEDITED\_FRAME\_COUNTER.

**3.2.4.3.2.3.2** The EXPEDITED\_FRAME\_COUNTER shall provide a modulo-8 counter indicating that Expedited frames have been received.

### 3.2.4.3.2.4 Reserved Spare

**3.2.4.3.2.4.1** Bit 4 of the PLCW shall contain a Reserved Spare bit.

**3.2.4.3.2.4.2** The Reserved Spare bit field shall be set to '0'.

### **3.2.4.3.2.5 Physical Channel Identification**

**3.2.4.3.2.5.1** Bit 3 of the PLCW shall contain the PCID field.

**3.2.4.3.2.5.2** The 1-bit PCID field shall contain the PCID of the physical channel with which this report is associated. (See 6.2.3.10, 'RECEIVING\_PCID\_BUFFER'.)

NOTE – Each PCID in use has its own PLCW reporting activated.

### **3.2.4.3.2.6 PLCW Retransmit Flag**

**3.2.4.3.2.6.1** Bit 2 of the PLCW shall contain the PLCW Retransmit Flag.

**3.2.4.3.2.6.2** A setting of '0' in the PLCW Retransmit Flag shall indicate that there are no outstanding frame rejections in the sequence received so far, and thus retransmissions are not required.

**3.2.4.3.2.6.3** A setting of '1' in the PLCW Retransmit Flag shall indicate that a received frame left a frame sequence number gap and that a retransmission of the expected frame is required.

## **3.2.4.4 Variable-Length SPDU**

### **3.2.4.4.1 General**

A '0' in the SPDU Format ID field shall identify a variable-length SPDU data field, which may contain from 0 to 15 octets of supervisory data.

NOTE – This form of SPDU uses bits 1 through 3 of the SPDU header to identify one of eight possible SPDU types, summarized in table 3-6. Currently three of these eight types are defined in the following two subsections. The remainder are reserved for future CCSDS specification.

**Table 3-6: Variable-Length Supervisory Protocol Data Unit**

| Variable-Length SPDU | SPDU Header (1 octet, fixed) |                                   |                                          | SPDU Data Field (0-15 octets)                                    |
|----------------------|------------------------------|-----------------------------------|------------------------------------------|------------------------------------------------------------------|
|                      | Format ID (Bit 0)            | SPDU Type Identifier (Bits 1,2,3) | Length of SPDU Data Field (Bits 4,5,6,7) | (Contains 1 or more protocol objects, i.e., directives, reports) |
| Type 1               | ‘0’                          | ‘000’                             | Length in Octets                         | Directives/Reports (see note)                                    |
| Type 2               | ‘0’                          | ‘001’                             | "                                        | TIME DISTRIBUTION PDU                                            |
| Type 3               | ‘0’                          | ‘010’                             | "                                        | Status Reports                                                   |
| Type 4               | ‘0’                          | ‘011’                             | "                                        | Reserved for CCSDS Use                                           |
| Type 5               | ‘0’                          | ‘100’                             | "                                        | Reserved for CCSDS Use                                           |
| Type 6               | ‘0’                          | ‘101’                             | "                                        | Reserved for CCSDS Use                                           |
| Type 7               | ‘0’                          | ‘110’                             | "                                        | Reserved for CCSDS Use                                           |
| Type 8               | ‘0’                          | ‘111’                             | "                                        | Reserved for CCSDS Use                                           |

NOTE – Directives and Reports can be multiplexed within the SPDU Data Field.

#### 3.2.4.4.2 Type 1 SPDU: Directives/Reports

An SPDU Type Identifier equal to ‘000’ shall identify a Type 1 SPDU with a data field containing from zero to seven 16-bit concatenated and multiplexed protocol objects, i.e., directives or reports.

NOTE – Variable-length SPDU Types are shown in table 3-6. Formats of variable-length SPDU data fields are defined in annex B.

#### 3.2.4.4.3 Type 2 SPDU: TIME DISTRIBUTION PDU

**3.2.4.4.3.1** An SPDU Type Identifier equal to ‘001’ shall identify a Type 2 SPDU with a data field containing from 1 to 15 octets of TIME DISTRIBUTION supervisory data.

**3.2.4.4.3.2** Octet 0 of the data field shall contain the TIME DISTRIBUTION directive type, followed by the actual time field value (1 to 14 octets).

NOTE – Variable-length SPDU Types are shown in table 3-6. Formats of variable-length SPDU data fields are defined in annex B.

#### **3.2.4.4.4 Type 3 SPDU: Status Reports**

An SPDU Type Identifier equal to '010' shall identify a Type 3 SPDU with a data field containing from 0 to 15 octets of Status Report information.

#### NOTES

- 1 The format of these reports is enterprise specific and is left up to the implementation.
- 2 Provision is made in the protocol to identify when a status report is required (NEED\_STATUS\_REPORT) and when a status report is requested (see Type 1 SPDU Report Request, B1.6).



## 4 DATA LINK LAYER

### 4.1 FRAME SUBLAYER

#### 4.1.1 FRAME SUBLAYER FUNCTIONS

4.1.1.1 At the sending end, the Frame Sublayer shall perform the following functions:

- a) accept frames supplied by the Data Services and MAC Sublayers and modify field values as necessary;
- b) formulate PLCWs and status reports as needed and incorporate them into a P-frame;
- c) determine the order of frame transmission;
- d) transfer the frames to the C&S Sublayer.

4.1.1.2 At the receiving end, the Frame Sublayer shall perform the following functions:

- a) receive a frame from the C&S Sublayer;
- b) validate that the received frame is a Version-3 Transfer Frame;
- c) validate that the frame should be accepted by the local transceiver based on the Spacecraft ID field and the Source-or-Destination ID of the transfer frame;
- d) if the frame is a valid U-frame, route it to the Data Services Sublayer;
- e) if the frame is a valid P-frame, route the contents of the frame (SPDUs) to the MAC Sublayer;
- f) if the frame is a valid P-frame and contains a PLCW, route the PLCW to the Data Services Sublayer.

#### 4.1.2 FRAME SELECTION FOR OUTPUT PROCESSING AT THE SENDING END

##### 4.1.2.1 Overview

The Frame Sublayer provides the control for formulating the frame headers and the SPDU data for transmission. The frame is delivered to the C&S Sublayer to be assembled into a PLTU prior to delivery to the Physical Layer.

##### 4.1.2.2 Frame Multiplexing Process Control

4.1.2.2.1 Frames shall be generated and sent when the TRANSMIT parameter (6.2.2.3) is set to *on*. When the PLTU contents are ready for transmission and while TRANSMIT is *on*, the data shall be transferred to the C&S Sublayer for processing.

**4.1.2.2.2** When either `NEED_PLCW` or `NEED_STATUS_REPORT` (6.2.3.6) is set to *true*, the required status and/or PLCW data shall be generated and inserted into a P-frame for delivery.

### 4.1.2.3 Frame Selection

Each time a frame is to be dispatched to the C&S Sublayer, its selection from a series of sources shall be based on the following priority scheme:

- a) first priority is given to a frame from the MAC queue in the MAC Sublayer;
- b) second priority is given to a PLCW or status report, if `U-frame_last_sent` is *true*;
- c) third priority is given to an Expedited frame from the Expedited Frame queue in the I/O Sublayer;
- d) fourth priority is given to a Sequence Controlled frame, first from the Sent queue if required, and then from the Sequence Controlled Frame queue in the I/O Sublayer;
- e) fifth priority is given to a PLCW or status report, if `U-frame_last_sent` is *false*.

#### NOTES

- 1 `U-frame_last_sent` is set to *true* on session initialization.
- 2 `U-frame_last_sent` is set to *false* whenever a PLCW or Status\_report is sent.
- 3 `U-frame_last_sent` is set to *true* for all other frames sent.
- 4 When `PERSISTENCE` is true, only supervisory protocol frames from the MAC queue are sent. (See 4.2.2.5.1.)

## 4.2 MEDIUM ACCESS CONTROL SUBLAYER

### 4.2.1 OVERVIEW

The MAC Sublayer is responsible for the establishment and termination of each communications session. It is also responsible for any operational changes in the Physical Layer configuration made during the data services phase.

Some of the operations performed by the MAC Sublayer require a ‘handshaking’ process between the sending transceiver and the responding transceiver. This handshake is often based upon interpretation of values of the Physical Layer control signals, i.e., `CARRIER_ACQUIRED` and `SYMBOL_INLOCK_STATUS`. Because of the potential for loss of an inter-transceiver control message because of corruption across the space link, MAC control activities require a ‘persistence’ process to ensure that the expected results of an activity are verified before any other activity is started. This process is generically defined as a persistent activity.

## 4.2.2 MAC CONTROL MECHANISMS

### 4.2.2.1 Overview

The following mechanisms are used to coordinate and control operations between the MAC and other sublayers.

### 4.2.2.2 PERSISTENCE

#### 4.2.2.3 Discussion

A persistent activity is a process for ensuring reliable communication between a caller and a responder using the Expedited QoS while transmitting from the MAC queue. Because of the potential for frame loss due to corruption across the space link, these MAC control activities require a persistence process to ensure that supervisory protocol directives are received and acted upon correctly.

Persistence activities can be linked in series to accomplish a task, but persistence applies to only a single activity at a time. Each persistent activity is named and consists of one or more actions (e.g., issuing selective directives), followed by a WAITING\_PERIOD during which a specific RESPONSE is expected. The protocol defines three persistent activities: hailing, i.e., session establishment (see 6.2.4 and tables 6-8 and 6-11); COMM\_CHANGE (see 6.2.4 and tables 6-9 and 6-12); and resynchronization (see 7.2.3.2 and 7.2.3.3).

#### 4.2.2.4 Persistence Activity Parameters

The parameters associated with a persistent activity are described below; their values vary based on the activity to be performed, and are defined per activity in the MIB (see annex C):

- a) ACTIVITY: the name of the persistent activity;
- b) WAITING\_PERIOD: the amount of time specified for the RESPONSE to be received before the process declares that the activity is to be either repeated or aborted;
- c) RESPONSE: the acknowledgement by the responder that the persistent activity has been accepted;
- d) NOTIFICATION: the message provided to the local vehicle controller, e.g., spacecraft C&DH by the caller and responder upon success or failure of the persistent activity;
- e) LIFETIME: the time period during which the persistent activity will be repeated until the expected RESPONSE is detected.

NOTE – The LIFETIME can be locally defined in terms of a duration or a maximum number of times this activity will be repeated before the activity is aborted.

#### 4.2.2.5 Persistent Activity Process

4.2.2.5.1 Upon initiation of a persistent activity, the PERSISTENCE signal shall be set to *true*.

4.2.2.5.2 While PERSISTENCE is *true* the Frame Sublayer shall select frames only from the MAC queue for output.

4.2.2.5.3 The success or failure of the activity shall be determined by the detection of the expected RESPONSE within the activity's LIFETIME.

4.2.2.5.4 If the RESPONSE is not detected within the activity's LIFETIME, the activity shall be deemed failed and aborted.

4.2.2.5.5 NOTIFICATION of the activity's success or failure shall be communicated back to the vehicle controller, at which time the PERSISTENCE signal shall be set to *false*.

#### 4.2.2.6 MAC\_FRAME\_PENDING

4.2.2.6.1 The MAC\_FRAME\_PENDING parameter shall be provided from the MAC Sublayer to the Frame Sublayer.

4.2.2.6.2 The MAC\_FRAME\_PENDING shall be set to *true* when a complete frame is loaded into the MAC queue.

4.2.2.6.3 MAC\_FRAME\_PENDING shall be set to *false* when the last bit of the frame is extracted from the MAC queue.

#### 4.2.3 DIRECTIVE DECODER

Implementations of the Proximity-1 Space Link Protocol shall include a Directive Decoder function for processing supervisory protocol directives defined in 3.2.4 and annex B.

NOTE – The Directive Decoder is a function that decodes supervisory protocol directives received either from the local Proximity link controller or from the remote vehicle controller. The directive decoder processes the received directives, setting the configuration (state and parameters) of both the Physical and Data Link Layers.

#### 4.2.4 MAC BUFFERS

##### 4.2.4.1 SENT\_TIME\_BUFFER

The SENT\_TIME\_BUFFER shall store all of the egress clock times, associated frame sequence numbers, and QoS Indicator when time tag data is collected.

#### 4.2.4.2 RECEIVE\_TIME\_BUFFER

The RECEIVE\_TIME\_BUFFER shall store all of the ingress clock times, associated frame sequence numbers, and QoS Indicator when time tag data is collected.

NOTE – Management of the MAC buffers is an implementation detail.

### 4.3 DATA SERVICES SUBLAYER

#### 4.3.1 OVERVIEW OF FUNCTIONALITY

##### 4.3.1.1 Send Side Functionality

The send side:

- a) runs the FOP-P process;
- b) processes received PLCWs;
- c) acknowledges delivery of complete SDUs to the I/O Sublayer;
- d) provides frame accountability to the I/O Sublayer;
- e) accepts either an Expedited or a Sequence Controlled frame from the I/O Sublayer.

##### 4.3.1.2 Receive Side Functionality

The receive side:

- a) runs the FARM-P process;
- b) accepts U-frames from the Frame Sublayer.

#### 4.3.2 GENERAL

4.3.2.1 The Data Services Sublayer shall control the order of transfer of the user data (including user-supplied directives) that are to be transmitted within the session.

4.3.2.2 The Data Services Sublayer shall provide the following two qualities of service:

- a) Expedited service shall ensure transmission without errors of Expedited frame data in the order received;
- b) Sequence Controlled service shall guarantee that data within a communication session are delivered in order without errors, gaps, or duplications.

#### NOTES

CCSDS RECOMMENDED STANDARD FOR PROXIMITY-1 SPACE DATA LINK PROTOCOL

- 1 The guarantee of reliable data delivery by the Sequence Controlled service is constrained to a single communication session without COP-P resynchronization. Sessions in which COP-P resynchronization occurs may result in duplicate or lost data, because of factors outside the scope of the Proximity-1 protocol.
- 2 The mechanisms provided in this specification will not eliminate duplicate data associated with the transition between the end of one session and the beginning of the next. Elimination of this problem is left to the controlling data system.
- 3 These services are provided by COP-P. The Data Services sending operations are described in 7.2, and the Data Services receiving operations are described in 7.3.

### 4.3.3 OVERVIEW OF THE COP-P PROTOCOL

The COP-P protocol is used with one Sender Node, one Receiver Node, and a direct link between them. The sender delivers frames to the receiver. The receiver accepts all valid Expedited frames, and valid Sequence Controlled frames that arrive in sequence. The receiver provides feedback to the sender in the form of a PLCW. The sender uses this feedback to retransmit Sequence Controlled frames when necessary. Expedited frames are never retransmitted by the COP-P protocol.

Concurrent bi-directional data transfer is a capability. In this case, each node has both sender and receiver functionality as shown in figure 4-1, COP-P Process.

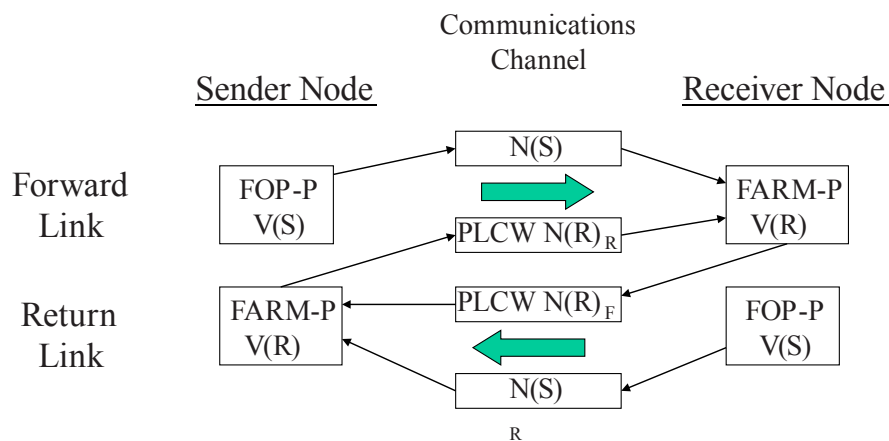

Notes:

- 1 The User data frames (U-frames) in the forward link contain the frame sequence number  $N(S)_F$ . The U-frames in the return link contain the frame sequence number  $N(S)_R$ .
- 2 The PLCW Supervisory protocol frames (P-frames) in the forward link are reporting return link progress and contain the frame sequence number  $N(R)_R$ . The P-frames in the return link are reporting forward link progress and contain the frame sequence number,  $N(R)_F$ .

**Figure 4-1: COP-P Process**

Both the Sender Node and the Receiver Node contain two types of procedures: the send side procedures, i.e., the FOP-P; and the receive side procedures, i.e., the FARM-P.

The FOP-P drives the Expedited and Sequence Controlled services. It is responsible for ordering and multiplexing the user-supplied data and maintaining synchronization with the FARM-P. It initiates a retransmission when required. If a valid PLCW is not received in a reasonable time period (defined by the MIB parameter, *Synch\_Timeout*), the Sender Node's FOP-P notifies the local controller that it is not synchronized with the Receiver Node's FARM-P. If the MIB parameter *Resync\_Local* equals *false*, it is the responsibility of the local controller to decide how synchronization will be re-established. Otherwise, the Sender Node's FOP-P forces a resynchronization by executing the SET V(R) activity.

The FARM-P is data-driven, i.e., it simply reacts to what it receives from the FOP-P and provides appropriate feedback via the PLCW. The FARM-P utilizes the services of the C&S Sublayer to verify that the frame was received error free. The FARM-P depends upon the Frame Sublayer to verify that the frame is a valid Version-3 Transfer Frame and that it should be accepted for processing by the Data Services Sublayer.

The FOP-P and FARM-P procedures control both Expedited and Sequence Controlled qualities of service.

#### 4.3.4 DISCUSSION—INTERFACE TO HIGHER SUBLAYER

FOP-P provides frame level accounting, i.e., V(S) and VE(S) to the I/O Sublayer for every Sequence Controlled and Expedited frame it numbers.

### 4.4 INPUT/OUTPUT SUBLAYER

#### 4.4.1 FUNCTIONS

##### 4.4.1.1 Sending. The I/O Sublayer shall

- a) accept for transfer the data for which the user specifies:
  - 1) the required QoS,
  - 2) the output Port ID,
  - 3) PDU type (user data or protocol directives),
  - 4) the frame data field construction rules to build a Version-3 Transfer Frame (see 3.2.2.5),
  - 5) *Remote\_Spacecraft\_ID*,
  - 6) PCID,
  - 7) Source-or-Destination Identifier;

CCSDS RECOMMENDED STANDARD FOR PROXIMITY-1 SPACE DATA LINK PROTOCOL

- b) using the value of the MIB parameters `Maximum_Packet_Size` and `Maximum_Frame_Length` (see annex C), organize the received data (including metadata) to form the Frame Data Unit and the Transfer Frame Header (frame sequence number shall be set to null);

NOTE – This process determines how to integrate the received packets into the frames. It includes segmenting packets (asynchronous data links) when their size is too large to fit within the maximum allowed frame size.

- c) notify the user when an Expedited SDU is radiated;
- d) notify the user when a Sequence Controlled SDU has been successfully transferred across the communications channel.

**4.4.1.2** Receiving. The I/O Sublayer shall

- a) receive U-frames accepted via the lower sublayers;
- b) assemble received segments into packets and verify that each packet is complete;
- c) deliver only complete packets to the user (length of the rebuilt packet must match packet length field), and discard incomplete packets;
- d) deliver the packets/user-defined data via the specified output Port ID in the U-frame header.

**4.4.2 INTERFACE TO THE LOWER SUBLAYERS**

**4.4.2.1** For received U-frames the I/O Sublayer shall provide two queues, Expedited queue and Sequence Controlled queue, capable of supporting the maximum data rate expected using the communications channel with that transceiver.

**4.4.2.2** The I/O Sublayer shall

- a) pass SDUs that require the Sequence Controlled service via the Sequence Controlled queue;
- b) pass SDUs that require the Expedited service via the Expedited queue.

**4.4.2.3** For Sequence Controlled service, the I/O Sublayer shall

- a) maintain an association between each SDU provided to the Data Services Sublayer and the frame sequence number of the frame which contains the last octet of that SDU;
- b) evaluate  $NN(R)$  (see 7.2.2) to validate that a complete SDU was received from the Data Services Sublayer;
- c) notify the user when acknowledged transfer of the SDU has been accomplished.



#### 4.4.3 I/O SUBLAYER QUEUES AND ASSOCIATED CONTROL SIGNALS

**4.4.3.1** While any data units are stored within the Sequence Controlled Frame queue, `SEQUENCE_CONTROLLED_FRAME_AVAILABLE` shall be *true*; otherwise, it shall be *false*.

NOTE – The Sequence Controlled Frame queue contains Sequence Controlled frames that are ready for transmission but have not yet been sent. This name is abbreviated to ‘SEQ queue’ in FOP-P State Table Events (7.2.3).

**4.4.3.2** While any data units are stored within the Expedited Frame queue, `EXPEDITED_FRAME_AVAILABLE` shall be *true*; otherwise, it shall be *false*.

NOTE – The Expedited Frame queue contains Expedited frames that are ready for transmission but have not yet been sent. This name is abbreviated to ‘EXP queue’ in FOP-P State Table Events (7.2.3).

**4.4.3.3** When the Data Services Sublayer extracts a frame from either queue, that frame is permanently removed from the queue, and the appropriate frame available parameter is re-evaluated.

NOTE – The local directive, `CLEAR QUEUE (Queue Type)` allows for the clearing of frames based upon the queue type specified in the directive.

## 5 PROXIMITY-1 TIMING SERVICES

### 5.1 OVERVIEW

The Proximity-1 protocol specifies two timing services for both time tagging transfer frames as well as transferring time to a remote asset. These two timing services can support a time correlation function that is outside the scope of this specification. They are specified here solely in an abstract sense and specify the information made available to the user in order to execute this functionality. The way in which a specific implementation makes this information available is not constrained by this specification. In addition to the parameters specified below, an implementation can provide other parameters to the service user (e.g., parameters for controlling the service, monitoring performance, facilitating diagnosis, and so on).

### 5.2 TIME TAG RECORDING

NOTE – The following method specifies the time tagging of Proximity-1 transfer frames exchanged between two Proximity-1 transceivers (initiator/responder) upon ingress to and egress from a Proximity transceiver (two-way) depicted in figure 5-1, Proximity Time Tag Recording.

**5.2.1** When time tagging is active, a Proximity-1 transceiver shall record the time of the trailing edge of the last bit of the ASM of every incoming and every outgoing Proximity-1 transfer frame of any type when available as required in reference [5].

**5.2.2** The egress/ingress captured time tags shall correspond to when the trailing edge of the last bit of the ASM of the outgoing/received PLTU crosses the clock capture point (defined by the implementation) within the transceiver.

**5.2.3** All recorded time tags shall be correlatable to when the trailing edge of the last bit of the ASM of the outgoing/received PLTU crossed the time reference point.

**5.2.4** The reference point for all timing calculations shall be defined by the enterprise.

**5.2.5** Timing services require the transceiver's MODE to be *active* and operating in the Data Services Sublayer.

NOTE – Timing services can occur in full, half-duplex, or simplex operations. Timing services can occur concurrently with other data transfer activities.

**5.2.6** To perform time tag capture, the vehicle controller shall instruct the initiating transceiver (initiator) to build and send a SET CONTROL PARAMETERS directive to the responder to capture its time tag measurements.

**5.2.7** After processing this instruction/directive, the MAC Sublayer of both transceivers shall capture the local time reference and associated frame sequence numbers over the commanded interval (i.e., for the number of frames defined within the Time Sample Field of

the directive) as depicted in figure 5-1 and package the collection of time tags and metadata (time + sequence number + direction + QoS Indicator) for transfer to the time correlation process.

NOTES

- 1 MAC buffer requirements for ingress and egress clock times are specified in 4.2.4.
- 2 The way in which these two data sets are built and possibly transferred and correlated is outside the scope of this specification (though some comments on time correlation follow below).

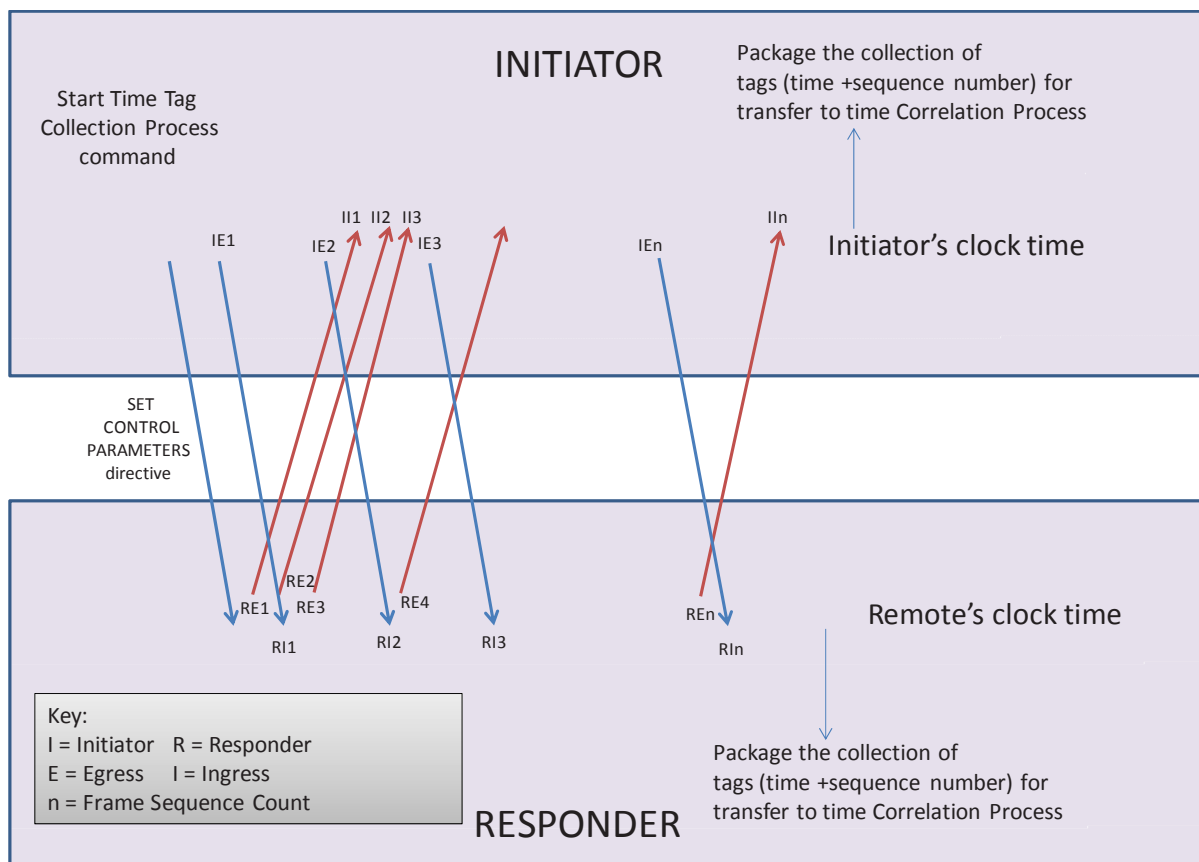

Figure 5-1: Proximity Time Tag Recording

5.3 TIME CORRELATION PROCESS

NOTE – When time correlation data sets can be transferred, the time correlation process can be performed. The actual implementation details of this process are outside the scope of this specification.

The time correlation process shall have access to the following information:

CCSDS RECOMMENDED STANDARD FOR PROXIMITY-1 SPACE DATA LINK PROTOCOL

- a) both initiator and responder's data sets (time tags, sequence counts, direction, QoS Indicator);
- b) the relationship of one of the transceiver's clocks to UTC;
- c) all applicable path losses and delays associated with the end-to-end time tagging process;

NOTES

- 1 It is up to the spacecraft implementer to measure and evaluate impact of all path losses and delays between the antenna and the radio antenna port.
  - 2 It is up to the radio implementer to measure and evaluate impact of all path losses and delays internal to the radio.
  - 3 The internal radio path delays are a function of the applied encoding option, symbol rate, modulation/demodulation mode, etc., and possibly implementation dependent elements (e.g., hardware type and configuration).
- d) time code formats per transceiver (reference [4]).

NOTES

- 1 Time tag direction is labeled as either egress or ingress.
- 2 Simultaneous collection of time tag data in both directions provides accuracy.

## 5.4 TRANSFERRING TIME TO A REMOTE ASSET

**5.4.1** A Proximity-1 transceiver shall provide the capability of distributing time to a remote asset.

NOTES

- 1 Independently from the capabilities of implementing the time correlation process, Proximity-1 systems have the possibility of coordinating their time reference.
- 2 In order to transfer accurate time to a remote asset (i.e., the responder), the initiator needs to maintain a correlation to the master clock for the enterprise and its local Proximity clock.

**5.4.2** The method for transferring time to a remote asset shall consist of the following steps (see figure 5-2):

**5.4.2.1** Optionally,

CCSDS RECOMMENDED STANDARD FOR PROXIMITY-1 SPACE DATA LINK PROTOCOL

- a) prior to the desired transfer of enterprise time to a remote node, the initiator's vehicle controller, based upon the mission's accuracy requirements, shall acquire/determine the one-way light time between itself and the remote node for the instant that the transfer is initiated;
- b) the vehicle controller shall add that amount of time to the enterprise time for when the transfer is initiated;
- c) this computed time shall be formatted as a CCSDS Unsegmented Time Code (reference [4]).

**5.4.2.2** At the desired time the vehicle controller shall command its transceiver to formulate a TIME DISTRIBUTION directive including the predetermined enterprise time, the internal sender path delay, and (if used) One Way Light Time (OWLT) propagation delay that is to be transmitted over the Proximity link.

**5.4.2.3** The initiator shall then transmit the TIME DISTRIBUTION directive.

**5.4.2.4** Upon receipt of the TIME DISTRIBUTION directive, the responder shall set its clock to the transmitted enterprise time and optionally determine based upon the mission's accuracy requirements, whether it needs to add the sender path delay, OWLT, and its own path delay to the transmitted enterprise time before applying it.

NOTE – To distribute time more accurately to a remote asset, the above-mentioned method requires that the following information be known:

- a) the initiator's time accuracy error;
- b) the maximum delay from the time of the vehicle controller's request until the TIME DISTRIBUTION directive is transmitted;
- c) the accuracy of the OWLT computation;
- d) the delay from the time of receipt of the TIME DISTRIBUTION directive until it is loaded into the remote system master clock.

CCSDS RECOMMENDED STANDARD FOR PROXIMITY-1 SPACE DATA LINK PROTOCOL

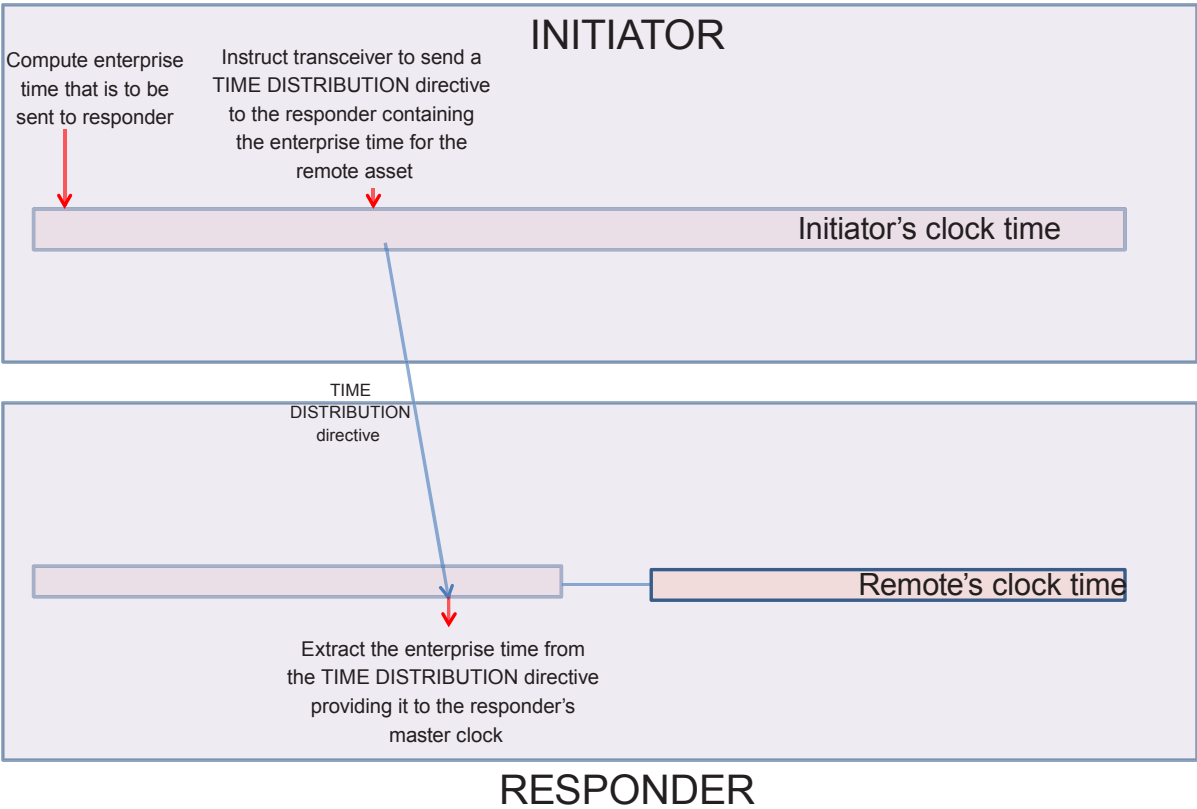

**Figure 5-2: Transferring Time to a Remote Asset**

## 6 DATA SERVICES OPERATIONS

### 6.1 OVERVIEW

Section 6 consists of a comprehensive set of state tables, state variable descriptions, and state diagrams for Proximity-1 data services operations. Table 6-1 provides a roadmap to help navigate through this section.

**Table 6-1: Proximity-1 Data Services Operations Roadmap**

| Operations  | Applicable Proximity-1 State Tables | Applicable State Transition Tables                                                                                        | Applicable State Transition Diagram |
|-------------|-------------------------------------|---------------------------------------------------------------------------------------------------------------------------|-------------------------------------|
| Full Duplex | Tables 6-2, 6-3                     | Session Establishment and Data Services: table 6-7<br><br>COMM_CHANGE: table 6-8<br><br>Session Termination: table 6-9    | Full Duplex Operations: figure 6-1  |
| Half Duplex | Tables 6-2, 6-4                     | Session Establishment and Data Services: table 6-10<br><br>COMM_CHANGE: table 6-11<br><br>Session Termination: table 6-12 | Half Duplex Operations: figure 6-2  |
| Simplex     | Tables 6-2, 6-5                     | Simplex State Transition Table: table 6-13                                                                                | Simplex Operations: figure 6-3      |

### 6.2 PROXIMITY-1 STATE TABLES

#### 6.2.1 OVERVIEW

The operating states for the Proximity-1 protocol are shown in tables 6-2 through 6-5. These states are dependent on four state-controlling variables: MODE, DUPLEX, TRANSMIT (T), and SUB-STATE (SS). The Receive and Send State Descriptions consist of the values *off*, *on*, *synchronous* (channel), and *asynchronous* (channel). Currently, Proximity-1 is solely defined for asynchronous data links. (See 1.5.1.2 for these definitions.)

Table 6-2: States Independent of the DUPLEX Variable

| State Name | State Description | Receive State Desc. | Send State Desc. | MODE                | T          | SS | Description                                                                                                                                                                                                                                                                                                                                                                                                                    |
|------------|-------------------|---------------------|------------------|---------------------|------------|----|--------------------------------------------------------------------------------------------------------------------------------------------------------------------------------------------------------------------------------------------------------------------------------------------------------------------------------------------------------------------------------------------------------------------------------|
| S1         | Inactive          | <i>off</i>          | <i>off</i>       | <i>inactive</i>     | <i>off</i> | 0  | The only actions that are permitted in state S1 are those in response to local directives. In this state the Data Services operational variables and MIB parameter values can be modified and their status read via local directives from the local controller. When the protocol enters this state the variables identified in table 6-6 are initialized. The Local SET INITIALIZE MODE directive forces entry to this state. |
| S2         | Waiting for Hail  | <i>on</i>           | <i>off</i>       | <i>connecting-L</i> | <i>off</i> | 0  | In this state, receiving operations are enabled. FARM-P operations are enabled but only for processing received supervisory directives; i.e., transfer frame header PDU TYPE ID = '1'. It should be noted that only receiving operations are enabled so that transmission is not permitted.                                                                                                                                    |
| S80        | Reconnect         | <i>on</i>           | <i>off</i>       | <i>active</i>       | <i>off</i> | 0  | In this state, the caller attempts to maintain the current Prox-1 session by reconnecting with the responder as follows: the caller's transmitter is turned off (for Drop_Carrier_Duration) to force the responder to drop carrier lock and transition into State S2: Waiting for Hail. The FARM-P and FOP-P variables of the caller and responder are not reset.                                                              |



CCSDS RECOMMENDED STANDARD FOR PROXIMITY-1 SPACE DATA LINK PROTOCOL

Table 6-3: States When DUPLEX = Full

| State Name | State Description        | Receive State Desc. | Send State Desc. | MODE                | T          | SS | Description                                                                                                                                                                                                                                                                                  |
|------------|--------------------------|---------------------|------------------|---------------------|------------|----|----------------------------------------------------------------------------------------------------------------------------------------------------------------------------------------------------------------------------------------------------------------------------------------------|
| S31        | Start Hail Action        | <i>on</i>           | <i>async</i>     | <i>connecting-T</i> | <i>on</i>  | 1  | In this state the Hail activity starts with the radiation of the carrier signal.                                                                                                                                                                                                             |
| S32        | Send Hail Acquisition    | <i>on</i>           | <i>async</i>     | <i>connecting-T</i> | <i>on</i>  | 2  | In this state the idle pattern is radiated to achieve symbol lock with the hailed remote unit.                                                                                                                                                                                               |
| S33        | Send Hail Directives     | <i>on</i>           | <i>async</i>     | <i>connecting-T</i> | <i>on</i>  | 3  | In this state the HAIL directives: (if present) SET_PL EXTENSIONS, SET_TRANSMITTER_PARAMETERS (if present), SET_PL EXTENSIONS, SET_RECEIVER_PARAMETERS) in that order are radiated in one Proximity-1 transfer frame to initiate a session with the hailed remote unit, i.e., the responder. |
| S34        | Send Hail Tail           | <i>on</i>           | <i>async</i>     | <i>connecting-T</i> | <i>on</i>  | 4  | In this state the idle pattern is radiated to allow the HAIL directives to be received and processed through the decoding chain of the responder.                                                                                                                                            |
| S35        | Wait for Hail Response   | <i>on</i>           | <i>async</i>     | <i>connecting-T</i> | <i>off</i> | 5  | In this state the transmitter is turned off and the receiver awaits a response from the hailed remote unit.                                                                                                                                                                                  |
| S41        | Radiate Carrier Only     | <i>on</i>           | <i>sync</i>      | <i>active</i>       | <i>on</i>  | 1  | In this state the receiver is <i>on</i> and ready to process all received data while the transmission process is started with carrier radiation only.                                                                                                                                        |
| S42        | Radiate Acquisition Idle | <i>on</i>           | <i>sync</i>      | <i>active</i>       | <i>on</i>  | 2  | In this state the receiver is <i>on</i> and processing all received data while the transmission process is trying to achieve bit lock with a potential partnered transceiver, i.e., the caller transceiver.                                                                                  |

CCSDS RECOMMENDED STANDARD FOR PROXIMITY-1 SPACE DATA LINK PROTOCOL

| State Name | State Description | Receive State Desc. | Send State Desc. | MODE          | T         | SS | Description                                                                                                                                                                                                              |
|------------|-------------------|---------------------|------------------|---------------|-----------|----|--------------------------------------------------------------------------------------------------------------------------------------------------------------------------------------------------------------------------|
| S40        | Data services     | <i>on</i>           | <i>sync</i>      | <i>active</i> | <i>on</i> | 0  | In this state data transfer services controlled by the COP-P protocol are conducted with a partnered transceiver.                                                                                                        |
| S48        | COMM_CHANGE       | <i>on</i>           | <i>sync</i>      | <i>active</i> | <i>on</i> | 6  | This state is involved with the protocol actions required to perform a data rate or frequency change with a partnered transceiver. This state contains numerous sub-states whose transitions are described in table 6-8. |
| S45        | Terminating Tail  | <i>on</i>           | <i>sync</i>      | <i>active</i> | <i>on</i> | 4  | In this state the receiver is <i>on</i> and processing all received data while the transmission process is terminating. (See table 6-9.)                                                                                 |

Table 6-4: States When DUPLEX = Half

| State Name | State Description     | Receive State Desc. | Send State Desc. | MODE                | T         | SS | Description                                                                                    |
|------------|-----------------------|---------------------|------------------|---------------------|-----------|----|------------------------------------------------------------------------------------------------|
| S11        | Start Hail Action     | <i>off</i>          | <i>async</i>     | <i>connecting-T</i> | <i>on</i> | 1  | In this state the Hail activity starts with the radiation of the carrier signal.               |
| S12        | Send Hail Acquisition | <i>off</i>          | <i>async</i>     | <i>connecting-T</i> | <i>on</i> | 2  | In this state the idle pattern is radiated to achieve symbol lock with the hailed remote unit. |

CCSDS RECOMMENDED STANDARD FOR PROXIMITY-1 SPACE DATA LINK PROTOCOL

| State Name | State Description        | Receive State Desc. | Send State Desc. | MODE                | T          | SS | Description                                                                                                                                                                                                                                                                                                       |
|------------|--------------------------|---------------------|------------------|---------------------|------------|----|-------------------------------------------------------------------------------------------------------------------------------------------------------------------------------------------------------------------------------------------------------------------------------------------------------------------|
| S13        | Send Hail Directives     | <i>off</i>          | <i>async</i>     | <i>connecting-T</i> | <i>on</i>  | 3  | In this state the HAIL directives: (if present) SET_PL EXTENSIONS (transmit), SET_TRANSMITTER_PARAMETERS (if present), SET_PL EXTENSIONS (receive), SET_RECEIVER_PARAMETERS) in that order are radiated in one Proximity-1 transfer frame to initiate a session with the hailed remote unit, i.e., the responder. |
| S14        | Send Hail Tail           | <i>off</i>          | <i>async</i>     | <i>connecting-T</i> | <i>on</i>  | 4  | In this state the idle pattern is radiated to allow the HAIL directives to be received and processed through the decoding chain of the responder.                                                                                                                                                                 |
| S36        | Wait for Hail Response   | <i>on</i>           | <i>off</i>       | <i>connecting-T</i> | <i>off</i> | 5  | In this state the transceiver awaits a response from the called remote unit.                                                                                                                                                                                                                                      |
| S51        | Radiate Carrier Only     | <i>off</i>          | <i>sync</i>      | <i>active</i>       | <i>on</i>  | 1  | In this state the transmission process is started with carrier radiation only.                                                                                                                                                                                                                                    |
| S52        | Radiate Acquisition Idle | <i>off</i>          | <i>sync</i>      | <i>active</i>       | <i>on</i>  | 2  | In this state the transmission process is trying to achieve symbol lock with a potential partnered transceiver.                                                                                                                                                                                                   |
| S50        | Data Services (send)     | <i>off</i>          | <i>sync</i>      | <i>active</i>       | <i>on</i>  | 0  | In this state the user data transmission process functions.                                                                                                                                                                                                                                                       |
| S54        | Terminate Reply          | <i>off</i>          | <i>sync</i>      | <i>active</i>       | <i>on</i>  | 3  | In this state the transmission process is sending the termination directive.                                                                                                                                                                                                                                      |
| S55        | Tail before Quit         | <i>off</i>          | <i>sync</i>      | <i>active</i>       | <i>on</i>  | 7  | In this state the transmission process is sending the terminating tail sequence bits.                                                                                                                                                                                                                             |

CCSDS RECOMMENDED STANDARD FOR PROXIMITY-1 SPACE DATA LINK PROTOCOL

| State Name | State Description         | Receive State Desc. | Send State Desc. | MODE          | T          | SS | Description                                                                                                                     |
|------------|---------------------------|---------------------|------------------|---------------|------------|----|---------------------------------------------------------------------------------------------------------------------------------|
| S56        | Token Pass or COMM_CHANGE | <i>off</i>          | <i>sync</i>      | <i>active</i> | <i>on</i>  | 6  | In this state the transmission process is sending either a token or the COMM_CHANGE directive.                                  |
| S58        | Tail before Switch        | <i>off</i>          | <i>sync</i>      | <i>active</i> | <i>on</i>  | 4  | In this state the transmission process is sending the terminating tail sequence bits.                                           |
| S60        | Data Services (receive)   | <i>on</i>           | <i>off</i>       | <i>active</i> | <i>off</i> | 0  | In this state the receiver is processing received data.                                                                         |
| S61        | Awaiting First Frame      | <i>on</i>           | <i>off</i>       | <i>active</i> | <i>off</i> | 1  | In this state the receiver is <i>on</i> , waiting receipt of the first frame for processing.                                    |
| S62        | Wait for Carrier          | <i>on</i>           | <i>off</i>       | <i>active</i> | <i>off</i> | 2  | In this state the receiver is <i>on</i> , waiting for the CARRIER_ACQUIRED Physical Layer signal to transition to <i>true</i> . |

Table 6-5: States When DUPLEX = Simplex (Receive or Transmit)

| State Name | State Description | Receive State Desc. | Send State Desc. | MODE          | T          | SS | Description                                                                                          |
|------------|-------------------|---------------------|------------------|---------------|------------|----|------------------------------------------------------------------------------------------------------|
| S71        | Simplex Transmit  | <i>off</i>          | <i>on</i>        | <i>active</i> | <i>on</i>  | 0  | In this state only the transmission operations are enabled while receiving operations are inhibited. |
| S72        | Simplex Receive   | <i>on</i>           | <i>off</i>       | <i>active</i> | <i>off</i> | 0  | In this state only the receiving operations are enabled while transmission operations are inhibited. |

## 6.2.2 STATE CONTROL VARIABLES

NOTE – These variables are contained within the Proximity-1 State Tables: MODE, DUPLEX, TRANSMIT, and SUB-STATE.

### 6.2.2.1 MODE

The MODE parameter provides control information for operations within the Data Link Layer, and control operations within the Physical Layer. The following states of MODE (set via the local SET MODE directive) shall be allowed:

- a) **inactive**: In the Inactive state the transceiver's transmitter and receiver are both turned off.
- b) **connecting-T**: In the Physical Layer, the connecting-transmit state in full duplex dictates that the receiver (sequentially in half duplex) and transmitter are powered on and enabled to process received frames, and that the transmitter is enabled for asynchronous channel operations. (In half duplex, only the transmitter is powered on.) The Hail activity is conducted while MODE is *connecting-T*.
- c) **connecting-L**: In the connecting-listen state, the receiver is powered on and enabled to process received frames while the transmitter is turned off.
- d) **active**: In the Active state when DUPLEX is 'full' the receiver is powered on and enabled to process received frames; the transmitter is enabled for synchronous channel operations responding to the control of the TRANSMIT parameter.

NOTE – The local SET INITIALIZE MODE directive puts MODE into the inactive state and initializes the COP-P variables described in 6.3.3.1.1.2, SET INITIALIZE MODE.

### 6.2.2.2 DUPLEX

The DUPLEX parameter identifies the physical channel communications characteristics so that the protocol can perform within the transceiver's operational constraints. The following values of DUPLEX (set via the local SET DUPLEX directive) shall be allowed:

- a) **full**: Both the receiver and transmitter are simultaneously enabled.
- b) **half**: Operation switches between receiving and transmitting within a communications session, with only the receiver or the transmitter enabled at one time.
- c) **simplex transmit**: The transmitter is enabled but not the receiver.
- d) **simplex receive**: The receiver is enabled but not the transmitter.

### 6.2.2.3 TRANSMIT

The TRANSMIT parameter is used to control Physical Layer operations when MODE is not equal to *inactive*. The following two states for TRANSMIT shall be allowed:

- a) *off*: The Physical Layer is signaled to transition the transmitter to *off*.
- b) *on*: The Physical Layer is signaled to transition the transmitter to *on*.

### 6.2.2.4 SS (SUB-STATE)

The SS variable shall be used

- a) to keep track of sequencing through Proximity-1 states in response to events in order to uniquely identify these states;
- b) to determine what data to load into the output FIFO (see table 6-14).

## 6.2.3 OPERATIONAL CONTROL VARIABLES

### 6.2.3.1 X (Session Termination)

X (Session Termination) shall be used to track the sub-states of the full and half duplex session termination process. In half duplex, it is shared between receive and transmit functionality. The values and definitions of the states of X are as follows:

- a) X=0: Bi-directional data passing in progress. Neither transceiver has declared that it is out of data to send. Used in full and half duplex.
- b) X=1: Local transceiver informed that there is locally no more data to send, i.e., LOCAL\_NO\_MORE\_DATA (LNMD). Used in half duplex only.
- c) X=2: Local transceiver has received the LNMD local directive and is sending the REMOTE\_NO\_MORE\_DATA (RNMD) directive to the remote transceiver. When an RNMD directive is received in this state, session termination begins. Used in full and half duplex.
- d) X=3: Local transceiver has data to send and it has received an RNMD directive from the remote transceiver. Used in half duplex only.
- e) X=4: Local transceiver has received the RNMD directive. When there is locally no more data to send, an RNMD directive is sent to the remote transceiver. Used in full and half duplex.
- f) X=5: Both local and remote transceivers have no more data to send. Once the RNMD directive is sent, the session is terminated and X is reset to 0. Used in full and half duplex.

### 6.2.3.2 Y (COMM\_CHANGE)

Y (COMM\_CHANGE) shall be used to track the sub-states during the commanding of a Physical Layer communications change. In half duplex, it is set on the transmit side and reset on the receive side. The values and the states of Y are as follows:

- a) Y=0: No COMM\_CHANGE in progress.
- b) Y=1: Local directive received to initiate the COMM\_CHANGE.
- c) Y=2: COMM\_CHANGE directive being sent across the Proximity link.
- d) Y=3: COMM\_CHANGE directive sent, and now waiting for the COMM\_CHANGE acknowledgement.
- e) Y=4: Receive the Remote COMM\_CHANGE Directive (RCCD). Used only in full duplex.
- f) Y=5: Act upon the received RCCD. Used only in full duplex.

### 6.2.3.3 Z (SYMBOL\_INLOCK\_STATUS)

Z (SYMBOL\_INLOCK\_STATUS) shall be used during a Physical Layer communications change to track nondeterministic events within State 48 (COMM\_CHANGE in Data Services), as follows:

- a) Z=0: SYMBOL\_INLOCK\_STATUS has not transitioned to *false*;
- b) Z=1: SYMBOL\_INLOCK\_STATUS has transitioned to *false*.

### 6.2.3.4 MODULATION

MODULATION is an interface variable with the Physical Layer which shall control the modulation of the transmitted carrier. When MODULATION=*on*, the coded symbols are modulated onto the radiated carrier; when MODULATION=*off*, the radiated output is not modulated (i.e., carrier only).

### 6.2.3.5 PERSISTENCE

NOTE – Persistence is specified in 4.2.2.2.

### 6.2.3.6 NEED\_PLCW and NEED\_STATUS\_REPORT

**6.2.3.6.1** NEED\_PLCW and NEED\_STATUS\_REPORT shall be used in the data selection for output process to determine if a PLCW or status report should be sent. Where applicable these variables shall be set to *true*:

CCSDS RECOMMENDED STANDARD FOR PROXIMITY-1 SPACE DATA LINK PROTOCOL

- a) at initialization;
- b) by events in the state transition processes;
- c) by PLCW TIMER; and
- d) by actions within the COP-P.

**6.2.3.6.2** NEED\_PLCW shall be set to *false* when a PLCW is selected for output. NEED\_STATUS\_REPORT shall be set to *false* when a status report is selected for output.

### **6.2.3.7 REMOTE\_SCID\_BUFFER**

REMOTE\_SCID\_BUFFER holds the value of the spacecraft ID that shall be used in testing all frames whose Source-or-Destination ID is set to *destination*.

### **6.2.3.8 COMMUNICATION\_VALUE\_BUFFER**

COMMUNICATION\_VALUE\_BUFFER shall be used to hold the communication values for the HAIL and COMM\_CHANGE directives and operations.

### **6.2.3.9 RECEIVING\_SCID\_BUFFER**

RECEIVING\_SCID\_BUFFER shall be used in the frame validation process to compare a received spacecraft ID value with that held within this buffer. This buffer may be loaded by a directive from the local vehicle controller, or it may be loaded with the spacecraft ID contained in the first valid received frame.

### **6.2.3.10 RECEIVING\_PCID\_BUFFER**

RECEIVING\_PCID\_BUFFER shall be used in the frame reception process. This buffer shall be loaded with the PCID contained in the first valid received frame.

## **6.2.4 MIB PARAMETERS**

### **6.2.4.1 Local\_Spacecraft\_ID**

Local\_Spacecraft\_ID shall contain the value of the spacecraft ID for this local spacecraft.

### **6.2.4.2 Test\_Source**

The Test\_Source parameter shall be used to determine whether the SCID field in received frames whose Source-or-Destination IDs are set to *source* is to be validated:



- a) Test\_Source=*false*: no test shall be performed;
- b) Test\_Source=*true*:
  - 1) if the RECEIVING\_SCID\_BUFFER is non-zero, i.e., contains a valid SCID, a test shall be performed;
  - 2) if the RECEIVING\_SCID\_BUFFER is zero, the value of the SCID field in the header of the first received frame whose Source-or-Destination ID is *source* shall be loaded into RECEIVING\_SCID\_BUFFER and thereafter used for validation for the remainder of the session. (See also related section 6.7.2.)

#### 6.2.4.3 Carrier\_Only\_Duration

Carrier\_Only\_Duration represents the time that shall be used to radiate an unmodulated carrier at the beginning of a transmission.

#### 6.2.4.4 Acquisition\_Idle\_Duration

Acquisition\_Idle\_Duration represents the time that shall be used to radiate the idle sequence pattern after carrier only to enable the receiving transceiver to achieve symbol synchronization and decoder lock.

#### 6.2.4.5 Tail\_Idle\_Duration

Tail\_Idle\_Duration represents the time that shall be used to radiate the idle sequence pattern at the end of a transmission to enable the receiving transceiver to process the last transmitted frame (i.e., push the data through the decoders).

NOTE – The time value for the Tail\_Idle\_Duration parameter can be calculated from the number of idle bits that need to be sent.

#### 6.2.4.6 Carrier\_Loss\_Timer\_Duration

Carrier\_Loss\_Timer\_Duration shall contain the value loaded into the CARRIER\_LOSS\_TIMER based upon the conditions defined in 6.3.1.3 (CARRIER\_LOSS\_TIMER and Associated Events).

#### 6.2.4.7 Comm\_Change\_Waiting\_Period

Comm\_Change\_Waiting\_Period represents the time that the caller shall wait for the Comm\_Change\_Response to the COMM\_CHANGE directive.

#### **6.2.4.8 Comm\_Change\_Response**

Comm\_Change\_Response shall be used by the responder to acknowledge that the persistent activity has been accepted. (For the full-duplex Comm\_Change\_Response see table 6-8, Events E17 and E20. For the Half Duplex Comm\_Change\_Response, see table 6-11, Event E68.)

#### **6.2.4.9 Comm\_Change\_Notification**

Comm\_Change\_Notification shall be provided to the local vehicle controller, e.g., spacecraft C&DH, by the caller and/or responder upon success or failure of the COMM\_CHANGE activity. (See annex D, Notifications to Vehicle Controller.)

#### **6.2.4.10 Comm\_Change\_Lifetime**

**6.2.4.10.1** Comm\_Change\_Lifetime shall represent the time period during which the COMM\_CHANGE activity shall be repeated until the MAC Sublayer detects the expected Comm\_Change\_Response.

**6.2.4.10.2** The Comm\_Change\_Lifetime may be locally defined in terms of a duration or a maximum number of times this activity is to be repeated before the activity is aborted.

#### **6.2.4.11 Hail\_Wait\_Duration**

Hail\_Wait\_Duration shall represent the time that the initiating transceiver (caller) waits for a response to the Hail.

#### **6.2.4.12 Hail\_Response**

Hail\_Response shall be used by the responder to acknowledge that the persistent activity has been accepted. In this case, either a valid transfer frame has been received or SYMBOL\_INLOCK\_STATUS (Physical Layer) = *true* (implementation option). (For full duplex, see table 6-7, Event 9; for half duplex, see table 6-10, Event 37.)

#### **6.2.4.13 Hail\_Notification**

Hail\_Notification shall be provided to the local vehicle controller, e.g., spacecraft C&DH, by the caller and/or responder upon success or failure of the persistent activity. (See also annex D, Notifications to Vehicle Controller).

#### **6.2.4.14 Hail\_Lifetime**

**6.2.4.14.1** Hail\_Lifetime represents the time period during which the persistent activity shall be repeated until the MAC detects the expected Hail\_Response.

**6.2.4.14.2** The Hail\_Lifetime may be locally defined in terms of a duration or a maximum number of times this activity is to be repeated before the activity is aborted.

#### **6.2.4.15 Discussion—Hailing\_Channel**

The hailing channel is enterprise specific. The default configuration of the Physical Layer parameters (established by the enterprise) defines the hailing channel frequencies that enable two transceivers to initially communicate (via a demand or negotiation process) so that they can establish a configuration for the data services portion of the session. Hailing channel assignments are defined in the Physical Layer.

#### **6.2.4.16 Hailing\_Data\_Rate**

Hailing\_Data\_Rate shall represent the data rate assigned during the Hail activity.

NOTE – Proximity data rates are defined in the Physical Layer.

#### **6.2.4.17 Send\_Duration**

Send\_Duration represents the maximum time that the half-duplex transmitter shall transmit data before it relinquishes the token (transfers to receive).

#### **6.2.4.18 Receive\_Duration**

Receive\_Duration represents the maximum time that the half-duplex receiver is anticipating that the sending side shall be transmitting.

#### **6.2.4.19 PLCW\_Repeat\_Interval**

**6.2.4.19.1** PLCW\_Repeat\_Interval shall represent the maximum transmission time between successive PLCWs, even if PLCWs are not required for Sequence Control operations.

**6.2.4.19.2** A zero value shall represent an infinite time period.

## 6.3 ELEMENTS AND EVENTS THAT AFFECT STATE STATUS

### 6.3.1 TIMERS

#### 6.3.1.1 General

6.3.1.1.1 All timers shall use the MIB parameter `Interval_Clock`.

NOTE – `Interval_Clock` is a frequency (e.g., 100 Hz) that is used for interval timing.

6.3.1.1.2 The following behavior applies to all timers:

- the timer shall count down when it is not equal to ‘zero’;
- when the timer equals ‘1’, the event associated with the timer shall occur;
- when the timer equals ‘zero’ it shall be in an inactive state;
- the timer may be reset to ‘zero’ by specific actions identified in the state transition tables.

#### 6.3.1.2 Wait Timer (WT) and Its Associated Events

The values loaded into the timer shall represent a desired time value consistent with the Interval Clock frequency. The timer shall be loaded with the required MIB parameter value (see state tables), and shall be counted down using the `Interval_Clock`. The value in the timer shall be counted down until underflow.

#### 6.3.1.3 CARRIER\_LOSS\_TIMER and Associated Events

6.3.1.3.1 The `CARRIER_LOSS_TIMER` contains the duration during which the session shall be maintained even though the carrier is no longer present.

NOTE – This mechanism is intended to reduce complexities from momentary (short term) carrier loss due to multipath or obstacles in the communications path. When `CARRIER_LOSS_TIMER` counts down to 1, signaling that either the spacecraft is no longer in view or the RF null was larger than expected, the vehicle controller (see annex D) is notified and decides whether to terminate or continue the session via the reconnect process (see 1.5.1.2).

6.3.1.3.2 The `CARRIER_LOSS_TIMER` shall be loaded with the value contained in the MIB parameter `Carrier_Loss_Timer_Duration` and down counting shall be enabled when the following conditions are simultaneously satisfied:

- a) the `CARRIER_ACQUIRED` (Physical Layer) signal is *false*;
- b) the `CARRIER_LOSS_TIMER` value is ‘0’;
- c) `MODE` = *active*;

d) either [DUPLEX = *full* or (DUPLEX = *half* .AND. TRANSMIT = *off*)].

**6.3.1.3.3** The CARRIER\_LOSS\_TIMER shall be reset to ‘zero’ when the CARRIER\_ACQUIRED (Physical Layer) signal is *true*.

### **6.3.1.4 PLCW Timer and Associated Events**

**6.3.1.4.1** The PLCW\_TIMER shall be used periodically to request the issuance of a PLCW.

**6.3.1.4.2** When the PLCW\_TIMER=‘1’, the NEED\_PLCW variable shall be set *true*.

**6.3.1.4.3** The timer shall be loaded with the value in the MIB parameter PLCW\_Repeat\_Interval whenever a PLCW is transmitted (see the COP-P state tables in section 7 for when the NEED\_PLCW variable is set to *true*).

NOTE – The PLCW\_TIMER does not appear in the state transition tables.

## **6.3.2 OUTPUT FIFO**

### **6.3.2.1 Overview**

The Output FIFO is a FIFO cache for the storage of bits that are serially output to the C&S Sublayer for encoding. The channel coding options of the C&S Sublayer (e.g., convolutional coding) are applied to the data from the output FIFO before transmission by the Physical Layer.

### **6.3.2.2 General**

The FIFO shall be filled with data per the specification defined in table 6-14. The ‘Output FIFO = empty’ signals that no data are contained within the FIFO, and more data needs to be input to the FIFO to keep the output bit stream synchronous.

### **6.3.2.3 No\_Frames\_Pending**

The No\_Frames\_Pending event shall occur when the Output FIFO becomes empty and there are no frames selectable for output.

## **6.3.3 DIRECTIVES**

### **6.3.3.1 Local Directives**

NOTE – Local directives are sent internally, i.e., not across the Proximity link.

### 6.3.3.1.1 SET MODE

6.3.3.1.1.1 SET MODE shall assign values to the MODE parameter (6.2.2.1) as follows:

- a) *connecting-L*;
- b) *connecting-T*;
- c) *active*;
- d) *inactive* (see 6.3.3.1.1.2).

6.3.3.1.1.2 SET MODE *inactive* shall initialize the variables in table 6-6 to the values indicated.

**Table 6-6: Proximity-1 Control Variable Initialization Table**

| Variables                                                                          | Value                  |
|------------------------------------------------------------------------------------|------------------------|
| TRANSMIT, MODULATION, PERSISTENCE                                                  | <i>off, off, false</i> |
| SS, X, Y and Z                                                                     | 0                      |
| WAIT TIMER (WT), CARRIER_LOSS_TIMER, PLCW_TIMER                                    | 0                      |
| SEQUENCE CONTROLLED (SEQ_CTRL_FSN) AND EXPEDITED FRAME SEQUENCE COUNTERS (EXP_FSN) | 0                      |

### 6.3.3.1.2 SET INITIALIZE MODE

SET INITIALIZE MODE shall use SET MODE *inactive* to place MODE into the *inactive* state and trigger the COP-P events SE0 and RE0 described in the state tables in 7.2.3.3 and 7.3.1.

### 6.3.3.1.3 LOCAL COMM\_CHANGE (LCCD)

Local COMM\_CHANGE shall use SET TRANSMITTER PARAMETERS and SET RECEIVER PARAMETERS (and possibly SET PL EXTENSIONS for transmit and receive) to initiate a change in one or more communications channel parameters.

NOTE – The Remote COMM\_CHANGE Directive (RCCD) uses the SET TRANSMITTER PARAMETERS and SET RECEIVER PARAMETERS directives (and possibly the SET PL EXTENSIONS directives for transmit and receive) and is sent across the Proximity link.

#### **6.3.3.1.4 LOAD COMMUNICATIONS VALUE BUFFER**

LOAD COMMUNICATIONS VALUE BUFFER shall load the values for the remote transmitter and receiver associated with either the Hail, COMM\_CHANGE, or half-duplex receiver/transmitter switching activities.

#### **6.3.3.1.5 LOCAL\_NO\_MORE\_DATA (LNMD)**

LOCAL\_NO\_MORE\_DATA shall inform the transceiver that the local data source has no more data to send.

NOTE – This directive initiates the session termination process.

#### **6.3.3.1.6 SET DUPLEX**

SET DUPLEX shall configure the local transmitter and/or receiver for either full-duplex, half-duplex, or simplex operations.

#### **6.3.3.1.7 SET RECEIVING SCID BUFFER**

SET RECEIVING SCID BUFFER shall be used by the vehicle controller to load the RECEIVING\_SCID\_BUFFER.

#### **6.3.3.1.8 READ STATUS**

READ STATUS shall selectively read the local status registers and buffers (including timing services) within the transceiver.

### **6.3.3.2 Remote Directives**

#### **6.3.3.2.1 Overview**

Remote directives are sent over the Proximity link from the local transceiver to the remote transceiver. SET TRANSMITTER PARAMETERS, SET RECEIVER PARAMETERS, and SET PL EXTENSIONS (as described below) can be used for both the HAIL directive and for Physical Layer communication changes. SET CONTROL PARAMETERS is used to 1) swap receive/transmit functionality in half-duplex, 2) terminate the session, 3) change duplex, and 4) set up the timing service.

### 6.3.3.2.2 SET TRANSMITTER PARAMETERS

**6.3.3.2.3** SET TRANSMITTER PARAMETERS shall be used to set the transmission parameters that control the data rate, encoding, modulation, and frequency in the transceiver receiving the directive.

**6.3.3.2.4** Upon receipt, the transceiver shall use the local directive SET MODE *active* to put the receiver's MODE parameter into the *active* state.

NOTE – This directive is formulated using the values contained in the sender's COMMUNICATION VALUE BUFFER. (See annex B for a complete definition.)

### 6.3.3.2.5 SET RECEIVER PARAMETERS

**6.3.3.2.5.1** SET RECEIVER PARAMETERS shall be used to set the receiver parameters that control the data rate, decoding, modulation, and frequency in the transceiver receiving the directive.

**6.3.3.2.5.2** Upon receipt, the transceiver shall use the local directive SET MODE *active* to put the receiver's MODE parameter into the *active* state.

NOTE – This directive is formulated using the values contained in the sender's COMMUNICATION VALUE BUFFER. (See annex B for a complete definition.)

### 6.3.3.2.6 SET PL EXTENSIONS

SET PL EXTENSIONS directive shall be used to enable or disable additional parameters.

NOTE – This directive is provided for compatibility between transceivers with Physical Layer and C&S Sublayer extensions in addition to those discussed in this Proximity-1 Recommended Standard.

### 6.3.3.2.7 SET CONTROL PARAMETERS

NOTE – This directive provides the capability of changing zero or more Proximity-1 control parameters at a time. (See annex B for a complete definition.)

SET CONTROL PARAMETERS shall be used to transmit operational control information during a session. It includes the following fields:

- a) **Token Field:** When this field is non-zero, it shall notify the recipient that the sender is relinquishing the half-duplex 'Send Token' and is switching to receive.
- b) **Remote\_No\_More\_Data Field (RNMD):** When this field is non-zero, it shall notify the recipient that the sending spacecraft has no more data to send, and that the session may be terminated when the recipient also has no more data to send.



- c) **Duplex Field:** When this field is non-zero, it shall notify the recipient to change communication directionality (*full, half, simplex-transmit, simplex-receive*).
- d) **Time Sample Field:** When this field is non-zero it shall notify the recipient to capture the time, sequence number, direction, and QoS Indicator for the next n frames received and transmitted (where 'n' is the value, i.e., number of frames contained within the Time Sample Field).

## 6.4 STATE TRANSITION TABLES AND DIAGRAMS

### 6.4.1 OVERVIEW

The following subsections contain State Transition Tables and State Transition Diagrams which should be read in conjunction with one another for completeness.

The State Transition Diagrams are intended to illustrate transitions from one state to another, and the events that trigger them. States are shown in boxes. Events that cause transitions from one state to a resultant state are given in italic text beside arrows that indicate the transition between states.

States, which have a descriptive title, are assigned the letter S and a number in the State Transition Tables. These tables are organized by event number in column 1. Column 2 describes the event that causes the state to transition from the starting state (column 3) to the resulting state (column 4). Column 5 contains any additional actions (in addition to what is described in tables 6-2 through 6-5) that take place as a result of entering that state.

The diagrams do not show all possible states for reasons of simplicity and clarity. For completeness, the State Transition Tables and accompanying text contain a description of all states and events not included in the diagrams.

### 6.4.2 FULL DUPLEX OPERATIONS

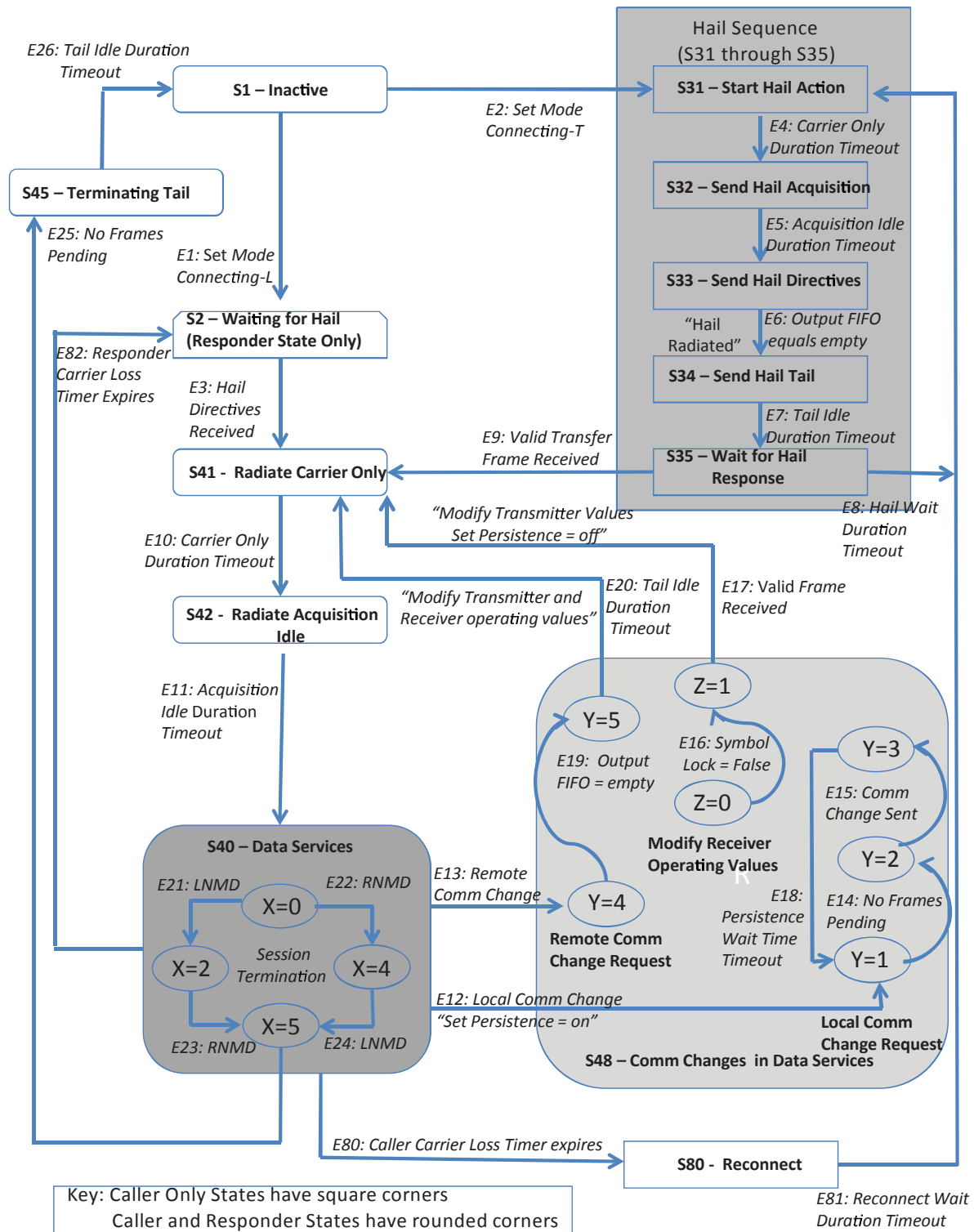

Figure 6-1: Full Duplex State Transition Diagram

**Table 6-7: Full Duplex Session Establishment/Data Services State Transition Table**

| Event No. | Event Causing the Transition (Description)                                                                                                                                   | Starting State (from) | Resulting State (to) | Action(s) in Addition to Tables 6-2, 6-3 and Comments                                                                                                                                                              |
|-----------|------------------------------------------------------------------------------------------------------------------------------------------------------------------------------|-----------------------|----------------------|--------------------------------------------------------------------------------------------------------------------------------------------------------------------------------------------------------------------|
| E1        | Local Directive - SET MODE <i>connecting-L</i>                                                                                                                               | S1                    | S2                   |                                                                                                                                                                                                                    |
| E2        | Local Directive - SET MODE <i>connecting-T</i>                                                                                                                               | S1                    | S31                  | - WT=Carrier_Only_Duration<br>- Set PERSISTENCE= <i>true</i><br>- Form and load HAIL directives into Comm Value Buffer                                                                                             |
| E3        | HAIL Directives Received<br>Receive (if present) SET PL EXTENSIONS (TX), SET_TRANSMITTER_PARAMETERS, (if present) SET PL EXTENSIONS (RX), SET_RECEIVER_PARAMETERS Directives | S2                    | S41                  | - WT=Carrier_Only_Duration<br>- Set TRANSMIT = <i>on</i><br>- Set NEED_PLCW= <i>true</i><br>- Set Receiver and Transmitter parameters per HAIL directives<br>- Send Hail_Notification to C&DH                      |
| E4        | WT=1 Carrier_Only_Duration Timeout                                                                                                                                           | S31                   | S32                  | - WT=Acquisition_Idle_Duration<br>- Set MODULATION= <i>on</i>                                                                                                                                                      |
| E5        | WT=1 Acquisition_Idle_Duration Timeout                                                                                                                                       | S32                   | S33                  | - Radiate Hail<br>Transmit (if present) SET PL EXTENSIONS (TX), SET_TRANSMITTER_PARAMETERS, (if present) SET PL EXTENSIONS (RX), SET_RECEIVER_PARAMETERS Directives                                                |
| E6        | Output FIFO=empty                                                                                                                                                            | S33                   | S34                  | <b>Hail Radiated</b><br>- WT=Tail_Idle_Duration                                                                                                                                                                    |
| E7        | WT=1 Tail_Idle_Duration Timeout                                                                                                                                              | S34                   | S35                  | - WT=Hail_Wait_Duration (see 6.2.4.11)<br>- Set TRANSMIT = <i>off</i>                                                                                                                                              |
| E8        | WT=1 Hail_Wait_Duration Timeout                                                                                                                                              | S35                   | S31                  | - WT=Carrier_Only_Duration<br>- Set MODULATION= <i>off</i><br>- Set TRANSMIT = <i>on</i><br>- If CARRIER ONLY RECEIVED, send carrier received notification to C&DH                                                 |
| E9        | Valid Transfer Frame Received<br>(or SYMBOL_INLOCK_STATUS= <i>true</i> —implementation option. See Hail_Response MIB parameter.)                                             | S35                   | S41                  | - Set Transmitter values from Comm Value Buffer<br>- WT=Carrier_Only_Duration<br>- Set MODULATION= <i>off</i><br>- Set TRANSMIT = <i>on</i><br>- Set PERSISTENCE= <i>false</i><br>- Send Hail_Notification to C&DH |

CCSDS RECOMMENDED STANDARD FOR PROXIMITY-1 SPACE DATA LINK PROTOCOL

| Event No.                                                                                                                                                                                                                                                                                                                                                                  | Event Causing the Transition (Description) | Starting State (from) | Resulting State (to) | Action(s) in Addition to Tables 6-2, 6-3 and Comments                                                                                                                                                                                                                                                                    |
|----------------------------------------------------------------------------------------------------------------------------------------------------------------------------------------------------------------------------------------------------------------------------------------------------------------------------------------------------------------------------|--------------------------------------------|-----------------------|----------------------|--------------------------------------------------------------------------------------------------------------------------------------------------------------------------------------------------------------------------------------------------------------------------------------------------------------------------|
| E10                                                                                                                                                                                                                                                                                                                                                                        | WT=1 Carrier_Only_Duration Timeout         | S41                   | S42                  | - WT=Acquisition_Idle_Duration<br>- Set MODULATION= <i>on</i>                                                                                                                                                                                                                                                            |
| E11                                                                                                                                                                                                                                                                                                                                                                        | WT=1 Acquisition_Idle_Duration Timeout     | S42                   | S40                  | <i>Data Service begins</i>                                                                                                                                                                                                                                                                                               |
| E80                                                                                                                                                                                                                                                                                                                                                                        | Caller's CARRIER_LOSS_TIMER expires        | S40                   | S80                  | - WT=Reconnect_Wait_Duration<br>- Set TRANSMIT = <i>off</i><br>- Reconfigure caller's Transceiver back to initial Hail settings as detailed in the SET TRANSMITTER and SET RECEIVER PARAMETERS directives (and SET PL EXTENSIONS if present)<br>- Utilize (do not reset) existing FARM-P and FOP-P variable values       |
| E81                                                                                                                                                                                                                                                                                                                                                                        | WT=1 Reconnect_Wait_Duration Timeout       | S80                   | S31                  | - Set TRANSMIT = <i>on</i><br>WT=Carrier_Only_Duration<br>- Set PERSISTENCE= <i>true</i><br>- Form and load HAIL directives into Comm Value Buffer<br>- Implementations may consider alternative values for: Carrier_Only_Duration, Acquisition_Idle_Duration, Tail_Idle_Duration, Hail_Wait_Duration for reconnections. |
| E82                                                                                                                                                                                                                                                                                                                                                                        | Responder's CARRIER_LOSS_TIMER expires     | S40                   | S2                   | - Set TRANSMIT = <i>off</i><br>- Reconfigure responder's transceiver back to initial Hail settings as detailed in the SET TRANSMITTER and SET RECEIVER PARAMETERS directives (and SET PL EXTENSIONS if present)<br>- Utilize (do not reset) existing FARM-P and FOP-P variable values                                    |
| <p>NOTE – FOP-P Data operations (7.2) occur within State 40. FARM-P operations (7.3) occur in States 40, 41, 42 and 48 whenever MODE is active and the receiver is on. Comm Value Buffer is the local MAC buffer used for staging the transmit and receive parameters in support of the hailing and COMM_CHANGE directives. Values can be sent in locally or remotely.</p> |                                            |                       |                      |                                                                                                                                                                                                                                                                                                                          |

**Table 6-8: Full Duplex Communication Change State Table**

| Event No.                                                                                                     | Event Causing the Transition (Description) | Starting State (from) | Resulting State (to) | Action(s) in Addition to Tables 6-2, 6-3 and Comments                                                                                                                                                                   |
|---------------------------------------------------------------------------------------------------------------|--------------------------------------------|-----------------------|----------------------|-------------------------------------------------------------------------------------------------------------------------------------------------------------------------------------------------------------------------|
| E12                                                                                                           | Local COMM_CHANGE Request                  | S40(Y=0)              | S48(Y=1)             | - Set Y=1<br>- Set PERSISTENCE= <i>true</i>                                                                                                                                                                             |
| E13                                                                                                           | Remote COMM_CHANGE Request                 | S40(Y=0)              | S48(Y=4)             | - Set Y=4<br>- Set PERSISTENCE= <i>true</i>                                                                                                                                                                             |
| E14                                                                                                           | No Frames Pending                          | S48(Y=1)              | S48(Y=2)             | - Form and Send Remote COMM_CHANGE Directive (RCCD)<br>- Set Y=2                                                                                                                                                        |
| E15                                                                                                           | Output FIFO=empty (COMM_CHANGE sent)       | S48(Y=2)              | S48(Y=3)             | - WT=Persistence_Wait_Time<br>- Set Y=3                                                                                                                                                                                 |
| E16                                                                                                           | Symbol Lock = <i>false</i>                 | S48(Y=1 or 2 or 3)    | S48(Z=1)             | - Set Z=1<br>- SET_RECEIVER_PARAMETERS from Comm Value Buffer                                                                                                                                                           |
| E17                                                                                                           | Valid Frame Received and Z=1               | S48(Z=1)              | S41                  | - Set Y=0<br>- Set PERSISTENCE= <i>false</i> ,<br>- Set Z=0<br>- SET_TRANSMITTER_PARAMETERS from Comm Value Buffer<br>- WT=Carrier_Only_Duration<br>- Set MODULATION= <i>off</i>                                        |
| E18                                                                                                           | WT=1 Persistence_Wait_Time Timeout         | S48(Y=3)              | S48(Y=1)             | - Set Y=1<br><i>No Response to RCCD received yet</i>                                                                                                                                                                    |
| E19                                                                                                           | Output FIFO = empty                        | S48(Y=4)              | S48(Y=5)             | - WT=Tail_Idle_Duration<br>- Set Y=5                                                                                                                                                                                    |
| E20                                                                                                           | WT=1 Tail_Idle_Duration Timeout            | S48(Y=5)              | S41                  | - Set Y=0<br>- Set PERSISTENCE= <i>false</i><br>- SET_TRANSMITTER_PARAMETERS & SET_RECEIVER_PARAMETERS into Comm Value Buffer<br>- Set NEED_PLCW= <i>true</i><br>- WT=Carrier_Only_Duration, Set MODULATION= <i>off</i> |
| NOTE – X, Y, Z are sub-state variables used in the process of session termination (X) and COMM_CHANGE (Y, Z). |                                            |                       |                      |                                                                                                                                                                                                                         |

**Table 6-9: Full Duplex Session Termination State Table**

| Event No.                                                                                                                                                  | Event Causing the Transition (Description)                                           | Starting State (from) | Resulting State (to) | Action(s) in Addition to Tables 6-2, 6-3 and Comments                                                                                                                                                                  |
|------------------------------------------------------------------------------------------------------------------------------------------------------------|--------------------------------------------------------------------------------------|-----------------------|----------------------|------------------------------------------------------------------------------------------------------------------------------------------------------------------------------------------------------------------------|
| E21                                                                                                                                                        | Receive LNMD (X=0)                                                                   | S40(X=0)              | S40(X=2)             | - Form and Load RNMD directive into the MAC queue<br>- Set X=2<br>- Send RNMD                                                                                                                                          |
| E22                                                                                                                                                        | Receive RNMD (X=0)                                                                   | S40(X=0)              | S40(X=4)             | - Set X=4                                                                                                                                                                                                              |
| E23                                                                                                                                                        | Receive RNMD (X=2)                                                                   | S40(X=2)              | S40(X=5)             | - Set X=5<br><i>Begin Termination Process</i>                                                                                                                                                                          |
| E24                                                                                                                                                        | Receive LNMD (X=4)                                                                   | S40(X=4)              | S40(X=5)             | - Form and Load RNMD directive into MAC queue<br>- Set X=5<br>- Send RNMD                                                                                                                                              |
| E25                                                                                                                                                        | No_Frames_Pending (X=5)                                                              | S40(X=5)              | S45                  | - WT=Tail_Idle_Duration                                                                                                                                                                                                |
| E26                                                                                                                                                        | WT=1 Tail_Idle_Duration Timeout                                                      | S45                   | S1                   | - Local directive SET MODE <i>inactive</i><br>- Notify vehicle controller: End of Session(# octets received)                                                                                                           |
| E28                                                                                                                                                        | Receive a Local SET MODE= <i>Inactive</i> Directive or SET INITIALIZE MODE Directive | Any state             | S1                   | SET MODE <i>inactive</i><br>- Notify vehicle controller: End of Session (# octets received)<br>NOTES<br>1 Not Shown on full-duplex transition diagram.<br>2 E28 initializes Prox-1 control variables. (See table 6-6.) |
| NOTE – LNMD = LOCAL_NO_MORE_DATA Directive received from the local controller; RNMD is the REMOTE_NO_MORE_DATA Directive received over the Proximity link. |                                                                                      |                       |                      |                                                                                                                                                                                                                        |

### 6.4.3 HALF DUPLEX OPERATIONS

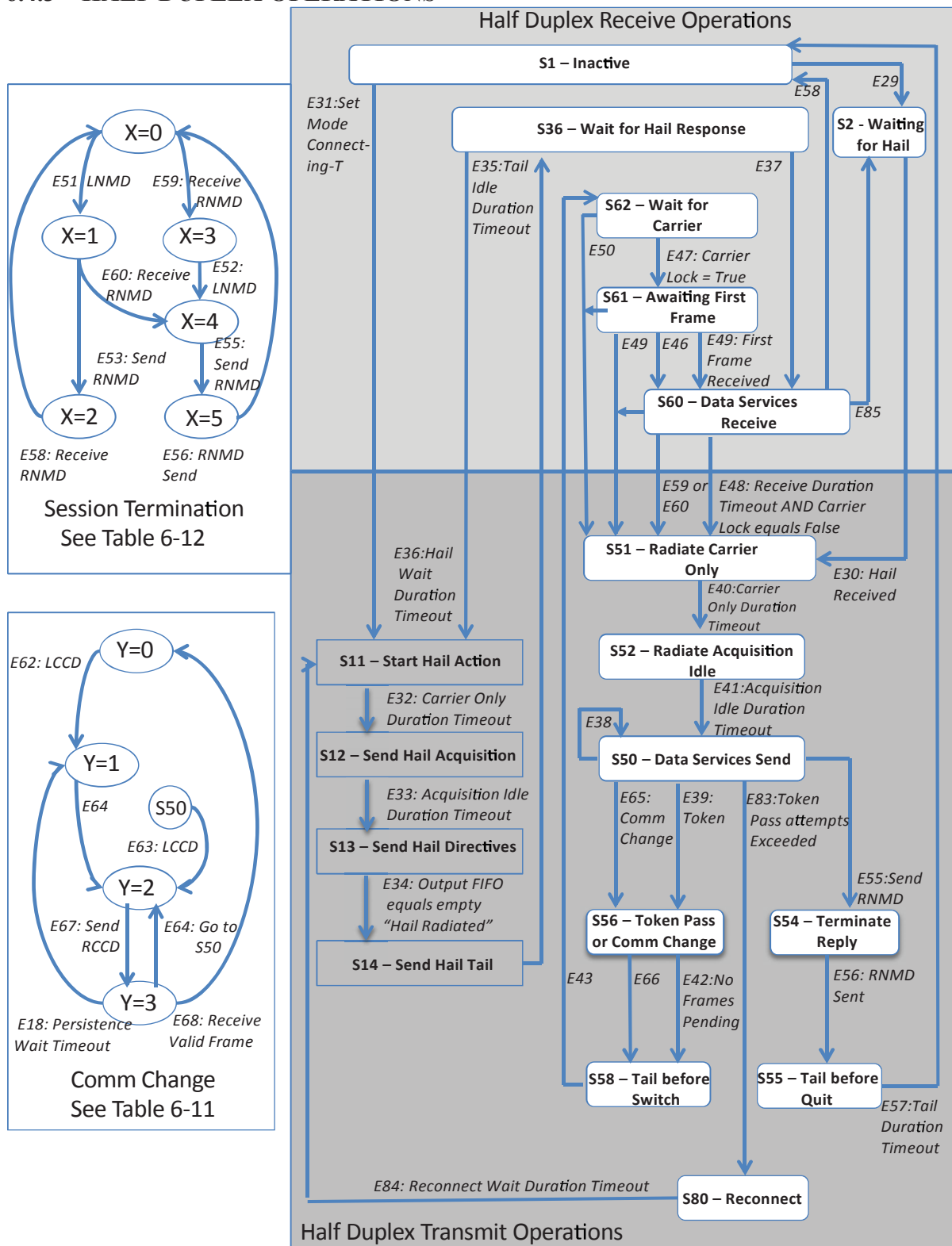

Figure 6-2: Half Duplex State Transition Diagram

**Table 6-10: Half Duplex Session Establishment and Data Services**

| Event No. | Event Causing the Transition (Description)                                                                                                                                    | Starting State (from) | Resulting State (to) | Action(s) in Addition to Tables 6-2, 6-4 and Comments                                                                                                                                 |
|-----------|-------------------------------------------------------------------------------------------------------------------------------------------------------------------------------|-----------------------|----------------------|---------------------------------------------------------------------------------------------------------------------------------------------------------------------------------------|
| E29       | Local Directive - SET MODE <i>connecting-L</i>                                                                                                                                | S1                    | S2                   | - Set NEED_PLCW= <i>true</i>                                                                                                                                                          |
| E30       | Hail Received<br>Receive (if present) SET PL EXTENSIONS (TX),<br>SET_TRANSMITTER_PARAMETERS,<br>(if present) SET PL EXTENSIONS (RX),<br>SET_RECEIVER_PARAMETERS<br>Directives | S2                    | S51                  | - WT=Carrier_Only_Duration<br>- Set Receiver and Transmitter values per HAIL directives<br>- Set TRANSMIT = <i>on</i><br>- Send Hail_Notification to C&DH                             |
| E31       | Local Directive – SET MODE <i>connecting-T</i>                                                                                                                                | S1                    | S11                  | - WT=Carrier_Only_Duration<br>- Load HAIL directives to Comm Value Buffer<br>- Set PERSISTENCE = <i>true</i><br>- Set Receiver Values per HAIL directive                              |
| E32       | WT=1 Carrier_Only_Duration Timeout                                                                                                                                            | S11                   | S12                  | - WT=Acquisition_Idle_Duration<br>- Set MODULATION = <i>on</i>                                                                                                                        |
| E33       | WT=1 Acquisition_Idle_Duration Timeout                                                                                                                                        | S12                   | S13                  | - Radiate Hail<br>Transmit (if present) SET PL EXTENSIONS (TX),<br>SET_TRANSMITTER_PARAMETERS,<br>(if present) SET PL EXTENSIONS (RX),<br>SET_RECEIVER_PARAMETERS<br>Directives       |
| E34       | Output FIFO=empty                                                                                                                                                             | S13                   | S14                  | <b>Hail Radiated</b><br>- WT=Tail_Idle_Duration                                                                                                                                       |
| E35       | WT=1 Tail_Idle_Duration Timeout                                                                                                                                               | S14                   | S36                  | - WT=Hail_Wait_Duration (see 6.2.4.11)<br>- Set MODULATION = <i>off</i><br>- Set TRANSMIT = <i>off</i>                                                                                |
| E36       | WT=1 Hail_Wait_Duration Timeout                                                                                                                                               | S36                   | S11                  | - Set TRANSMIT = <i>on</i><br>- WT=Carrier_Only_Duration<br>- Set Load HAIL directives to Comm Value Buffer<br>- If CARRIER ONLY RECEIVED, send carrier received notification to C&DH |



CCSDS RECOMMENDED STANDARD FOR PROXIMITY-1 SPACE DATA LINK PROTOCOL

| Event No. | Event Causing the Transition (Description)                                                                                      | Starting State (from) | Resulting State (to) | Action(s) in Addition to Tables 6-2, 6-4 and Comments                                                                                                                                         |
|-----------|---------------------------------------------------------------------------------------------------------------------------------|-----------------------|----------------------|-----------------------------------------------------------------------------------------------------------------------------------------------------------------------------------------------|
| E37       | Valid Transfer Frame Received (or SYMBOL_INLOCK_STATUS = <i>true</i> )—implementation option. See Hail_Response MIB parameter.) | S36                   | S60                  | - Set Transmitter values per Comm Value Buffer<br>- Set PERSISTENCE= <i>false</i> ( <i>get ready for next transmit contact</i> )<br>- WT=Receive_Duration<br>- Send Hail_Notification to C&DH |
| E38       | (Transmit Timer Event – End of Send Period)<br>WT=1 Send_Duration Timeout                                                       | S50                   | S50<br>Y = 0         | - Set PERSISTENCE= <i>true</i><br><i>Setting PERSISTENCE blocks the transmission of data from data services. Now only send from the MAC queue. Therefore, no frames pending occurs.</i>       |
| E39       | No Frames Pending AND. Y=0 .AND. NEED_PLCW is <i>false</i>                                                                      | S50<br>Y=0            | S56                  | - Form and load the token via SET CONTROL PARAMETERS Directive into the MAC queue                                                                                                             |
| E40       | WT=1 Carrier_Only_Duration Timeout                                                                                              | S51                   | S52                  | - WT=Acquisition_Idle_Duration<br>- Set MODULATION= <i>on</i>                                                                                                                                 |
| E41       | (End of Acquire)<br>WT=1 Acquisition_Idle_Duration Timeout                                                                      | S52                   | S50                  | - WT=Send_Duration                                                                                                                                                                            |
| E42       | No Frames Pending (Y=0)                                                                                                         | S56, Y=0              | S58                  | - WT=Tail_Idle_Duration                                                                                                                                                                       |
| E43       | WT=1 Tail_Idle_Duration Timeout .AND. Y≠2                                                                                       | S58<br>Y≠2            | S62                  | - WT=Receive_Duration<br>- Set PERSISTENCE= <i>false</i><br>- Set MODULATION= <i>off</i><br>- Switch transmit to receive                                                                      |
| E44       | WT=1 Receive_Duration Timeout .AND. Carrier Lock= <i>true</i>                                                                   | S60                   | S60                  | - WT=Receive_Duration<br>- Notify vehicle controller: Sender exceeded prescribed transmission interval                                                                                        |
| E45       | WT=1 Receive_Duration Timeout .AND. Carrier Lock= <i>true</i>                                                                   | S61                   | S61                  | - WT=Receive_Duration<br>- Notify vehicle controller: No data transferred during contact period                                                                                               |
| E46       | Receive Valid frame .AND. Y≠3                                                                                                   | S61<br>Y≠3            | S60                  |                                                                                                                                                                                               |
| E47       | Carrier Lock = <i>true</i>                                                                                                      | S62                   | S61                  |                                                                                                                                                                                               |

CCSDS RECOMMENDED STANDARD FOR PROXIMITY-1 SPACE DATA LINK PROTOCOL

| Event No. | Event Causing the Transition (Description)                                                                                                      | Starting State (from) | Resulting State (to) | Action(s) in Addition to Tables 6-2, 6-4 and Comments                                                                                                                                                                                                                                                                                |
|-----------|-------------------------------------------------------------------------------------------------------------------------------------------------|-----------------------|----------------------|--------------------------------------------------------------------------------------------------------------------------------------------------------------------------------------------------------------------------------------------------------------------------------------------------------------------------------------|
| E48       | WT=1 Receive_Duration Timeout<br>.AND. Carrier Lock = <i>false</i>                                                                              | S60                   | S51                  | - WT=Carrier_Only_Duration<br><i>back-up action for missed token</i><br>- Switch receive to transmit                                                                                                                                                                                                                                 |
| E49       | Receive Token - SET CONTROL PARAMETERS Directive                                                                                                | S60/S61               | S51                  | - WT=Carrier_Only_Duration<br>- Switch receive to transmit                                                                                                                                                                                                                                                                           |
| E50       | WT=1 Receive_Duration Timeout<br>.AND. Carrier Lock = <i>false</i>                                                                              | S62/S61               | S51                  | - WT=Carrier_Only_Duration<br>- Notify vehicle controller: S62:<br>No carrier received for contact period<br>S61: No data transferred during contact period<br>- Switch receive to transmit                                                                                                                                          |
| E83       | Token Pass attempts exceeded (Maximum_Failed-Token_Passes)                                                                                      | S50                   | S80                  | -<br>WT=Reconnect_Wait_Duration<br>- Set TRANSMIT = <i>off</i><br>- Reconfigure caller's Transceiver back to initial Hail settings as detailed in the SET TRANSMITTER and SET RECEIVER PARAMETERS directives<br>- Utilize (do not reset) existing FARM-P and FOP-P variable values                                                   |
| E84       | WT=1 Reconnect_Wait_Duration Timeout                                                                                                            | S80                   | S11                  | - Set TRANSMIT = <i>on</i><br>WT=Carrier_Only_Duration<br>- Set PERSISTENCE= <i>true</i><br>- Form and load HAIL directives into Comm Value Buffer<br>- Implementations may consider alternative values for:<br>Carrier_Only_Duration,<br>Acquisition_Idle_Duration,<br>Tail_Idle_Duration,<br>Hail_Wait_Duration for reconnections. |
| E85       | Responder's CARRIER_LOSS_TIMER expires                                                                                                          | S60                   | S2                   | - Set TRANSMIT = <i>off</i><br>- Utilize (do not reset) existing FARM-P and FOP-P variable values                                                                                                                                                                                                                                    |
| NOTE      | - FOP-P Data operations occur within State 50 and are described in 7.2. FARM-P operations occur within States 60 and 61 are described in 7.3.1. |                       |                      |                                                                                                                                                                                                                                                                                                                                      |

**Table 6-11: Half Duplex Communication Change State Table**

| Event No. | Event Causing the Transition (Description)                  | Starting State (from)                 | Resulting State (to)   | Additional Action(s) and Comments                                                                |
|-----------|-------------------------------------------------------------|---------------------------------------|------------------------|--------------------------------------------------------------------------------------------------|
| E62       | Receive Local COMM_CHANGE Directive (LCCD)                  | Any State other than State S50<br>Y=0 | No State Change<br>Y=1 | - Load SET TRANSMITTER/SET RECEIVER PARAMETERS Directives values into Comm Value Buffer          |
| E63       | Receive Local COMM_CHANGE Directive (LCCD)                  | S50                                   | S50<br>Y=2             | - Set PERSISTENCE= <i>true</i><br>- SET RECEIVER PARAMETERS from Comm Value Buffer               |
| E64       | Transition to State 50                                      | Y=1 .OR.<br>Y=3                       | S50<br>Y=2             | - Set Y=2, Set PERSISTENCE= <i>true</i><br>- SET RECEIVER PARAMETERS from Comm Value Buffer      |
| E65       | No Frames Pending .AND. Y=2                                 | S50<br>Y=2                            | S56                    | - Form and load into the Comm Value Buffer the COMM_CHANGE Directives                            |
| E66       | No Frames Pending                                           | S56<br>Y=2                            | S58<br>Y=2             | - WT=Tail_Idle_Duration<br>COMM_CHANGE <i>Sent</i>                                               |
| E67       | WT=1<br>Tail_Idle_Duration Timeout .AND.<br>Y=2             | S58<br>Y=2                            | S62<br>Y=3             | -WT=Receive_Duration<br>- Switch transmit to receive                                             |
| E47       | Carrier Lock = <i>true</i>                                  | S62                                   | S61                    | <i>Same event - provided for clarity</i>                                                         |
| E68       | Receive Valid Frame                                         | S61<br>Y=3                            | S60<br>Y=0             | - SET TRANSMITTER PARAMETERS from Comm Value Buffer<br>- Set Y=0<br>- PERSISTENCE= <i>false</i>  |
| E69       | Receive COMM_CHANGE (Not Shown in State Transition Diagram) | S60/S61                               | S51                    | - Set Transmitter and Receiver Parameters into Comm Value Buffer<br>- Set NEED_PLCW= <i>true</i> |

**Table 6-12: Half Duplex Session Termination State Table**

| Event No. | Event Causing the Transition (Description) | Starting State (from) | Resulting State (to) | Additional Action(s) and Comments |
|-----------|--------------------------------------------|-----------------------|----------------------|-----------------------------------|
| E51       | Receive LNMD (can be received at any time) | X=0                   | X=1                  | - Set X=1                         |
| E52       | Receive LNMD (can be received at any time) | X=3                   | X=4                  | - Set X=4                         |
| E53       | No Frames Pending .AND. X=1                | S50                   | S50                  | - Form and Load RNMD into the     |

CCSDS RECOMMENDED STANDARD FOR PROXIMITY-1 SPACE DATA LINK PROTOCOL

| Event No. | Event Causing the Transition (Description)         | Starting State (from) | Resulting State (to) | Additional Action(s) and Comments                                                                                                                        |
|-----------|----------------------------------------------------|-----------------------|----------------------|----------------------------------------------------------------------------------------------------------------------------------------------------------|
|           |                                                    | X=1                   | X=2                  | MAC queue,<br>- Set X=2<br>- Send RNMD                                                                                                                   |
| E55       | No Frames Pending .AND. X=4                        | S50<br>X=4            | S54<br>X=5           | - Form and Load RNMD into the MAC queue,<br>- Set X=5; Send RNMD                                                                                         |
| E56       | No Frames Pending .AND. X=5                        | S54<br>X=5            | S55<br>X=0           | - WT=Tail_Idle_Duration<br>- Set X=0<br><i>Transmission of RNMD complete</i>                                                                             |
| E57       | WT=1 Tail_Duration Timeout                         | S55                   | S1                   | - SET MODE Inactive<br>- Notify vehicle controller: End of Session(# octets received)                                                                    |
| E58       | Receive RNMD .AND. X=2                             | S60/S61<br>X=2        | S1<br>X=0            | - SET MODE <i>Inactive</i><br>- Set X=0<br><i>Both nodes have no more data to send; Notify vehicle controller: End of Session(# octets received)</i>     |
| E59       | Receive RNMD .AND. X=0                             | S60/S61<br>X=0        | S51<br>X=3           | - Set X=3<br><i>WT = Carrier_Duration_Only</i>                                                                                                           |
| E60       | Receive RNMD .AND. X=1                             | S60/S61<br>X=1        | S51<br>X=4           | - Set X=4<br><i>WT = Carrier_Duration_Only</i>                                                                                                           |
| E61       | Receive a Local SET MODE <i>Inactive</i> directive | any                   | S1                   | - SET MODE <i>Inactive</i><br>- Notify vehicle controller: End of Session(# octets received)<br><i>Not shown on half duplex state transition diagram</i> |

#### 6.4.4 SIMPLEX OPERATIONS

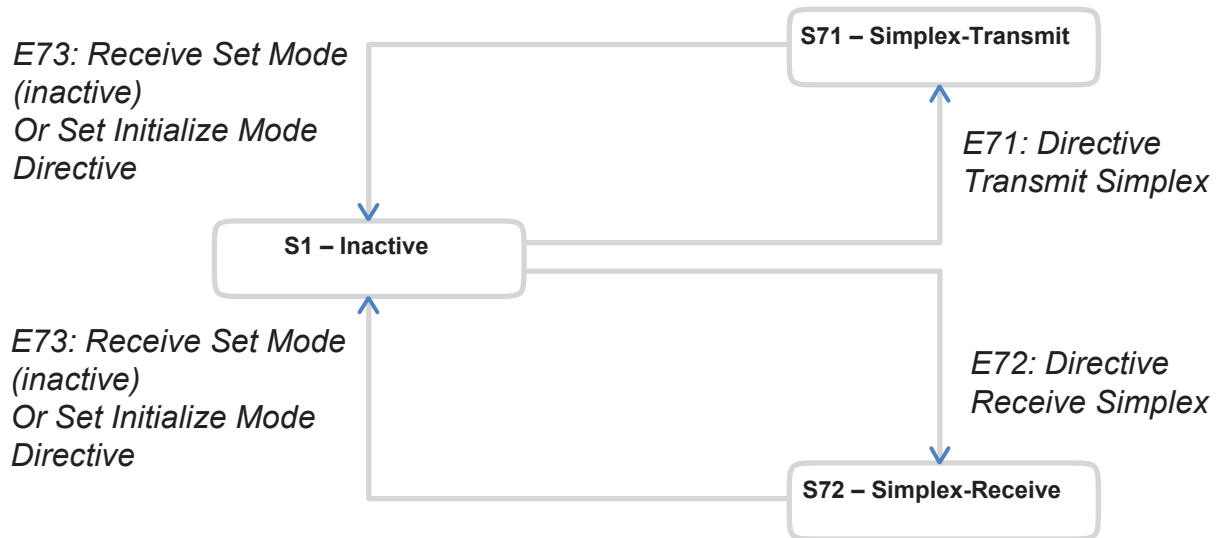

Figure 6-3: Simplex Operations

Table 6-13: Simplex State Transition Table

| Event No | Starting State (from) | Resulting State (to) | Event Causing the Transition (Description)           | Action(s) in addition to Tables 6-2, 6-5                                                                           |
|----------|-----------------------|----------------------|------------------------------------------------------|--------------------------------------------------------------------------------------------------------------------|
| E71      | S1                    | S71                  | Receive Directive - Transmit Simplex                 | - Set DUPLEX = <i>Simplex transmit</i><br>- Set TRANSMIT = <i>on</i><br>- Local Directive SET MODE = <i>active</i> |
| E72      | S1                    | S72                  | Receive Directive - Receive Simplex                  | - Set DUPLEX = <i>Simplex receive</i><br>- Set TRANSMIT = <i>off</i><br>- Local Directive SET MODE = <i>active</i> |
| E73      | S71 or S72            | S1                   | Receive a Local SET MODE = <i>Inactive</i> Directive | - Notify vehicle controller: End of Session(# octets received)                                                     |

### 6.5 INTERFACES WITH THE PHYSICAL LAYER (VIA CODING AND SYNCHRONIZATION SUBLAYER)

#### 6.5.1 OUTPUT INTERFACES

**6.5.1.1** The TRANSMIT parameter (6.2.2.3) shall be set to *on* to signal the transceiver to turn its transmitter ‘on’.

**6.5.1.2** The Frame Sublayer shall output frames via the C&S Sublayer ChannelAccess.request service primitive.

**6.5.1.3** The MODULATION parameter (6.2.3.4) shall be set to *on* to signal the transceiver to modulate the carrier with the coded symbols provided on the Output coded symbol stream (see 6.6.3).

## 6.5.2 INPUT INTERFACES

The Physical Layer provides information about carrier and symbol lock status via the CARRIER\_ACQUIRED (see 6.3.1.3) and SYMBOL\_INLOCK\_STATUS (see 6.2.3.3) parameters, respectively. The values of these parameters shall be interpreted as follows:

- a) CARRIER\_ACQUIRED = *true* indicates that the receiver has acquired a carrier signal;
- b) SYMBOL\_INLOCK\_STATUS = *true* indicates that symbol synchronization has been acquired.

NOTE – The C&S layer receives a coded symbol stream from the Physical Layer and delivers frames to the Frame Sublayer.

## 6.6 SENDING OPERATIONS

### 6.6.1 SESSION ESTABLISHMENT

**6.6.1.1** Local SET TRANSMITTER PARAMETERS and Local SET RECEIVER PARAMETERS directives (and, if needed, Local SET PL EXTENSIONS directives) shall be used to set the local transceiver to the desired physical configuration.

**6.6.1.2** If required for the session, the Test\_Source MIB parameter shall be loaded.

**6.6.1.3** A Local SET MODE (*connecting-T*) directive shall initiate the Hail activity and start the session establishment process (see 6.4.2 for full-duplex operation and 6.4.3 for half-duplex operation).

### 6.6.2 DISCUSSION

Once a frame is ready for output, at the C&S Sublayer, an ASM is prepended, and a CRC is computed and appended to the frame. The output coded symbol stream is formulated for radiation in accordance with table 6-14.

An idle pattern generated by an Idle Pattern Generator (described in reference [5]) is used for acquisition periods, i.e., periods when no frames are available for transmission, as well as for providing a tail stream (which provides the added bits required to push the data through the receiving and decoding processes at the remote terminus of the link).

### 6.6.3 OUTPUT CODED SYMBOL STREAM FORMULATION

**Table 6-14: Data Source Selection for Output Coded Symbol Stream with TRANSMIT = *on* and MODULATION = *on***

| Based Upon the Values Below,<br>Take the Following Action |                 |              |                               |                | Action                     |
|-----------------------------------------------------------|-----------------|--------------|-------------------------------|----------------|----------------------------|
| SS<br>(SUB-<br>STATE)                                     | SPDU<br>Pending | PERSISTENCE  | NEED_<br>PLCW<br>or<br>Status | SDU<br>Pending |                            |
| 2, 4, or 7                                                | X               | X            | X                             | X              | IDLE (Acquisition or Tail) |
| 0, 3, or 6                                                | <i>true</i>     | X            | X                             | X              | ASM+P-frame(SPDU)+CRC      |
| 0, 3, or 6                                                | <i>false</i>    | <i>true</i>  | X                             | X              | IDLE                       |
| 0, 3, 6                                                   | <i>false</i>    | <i>false</i> | <i>true</i>                   | X              | ASM+PLCW/Status +CRC       |
| 0, 3, or 6                                                | <i>false</i>    | <i>false</i> | <i>false</i>                  | <i>true</i>    | ASM+U-frame(SDU) +CRC      |
| 0, 3, or 6                                                | <i>false</i>    | <i>false</i> | <i>false</i>                  | <i>false</i>   | IDLE                       |

#### NOTES

- 1 X means do not care what the value is.
- 2 SPDU Pending is *true* if there is a supervisory protocol data unit available to send.
- 3 SDU Pending is *true* if there is a service data unit (user data) available to send.
- 4 When NEED\_PLCW is *true*, NEED\_STATUS\_REPORT can optionally be set to *true*, enabling the generation and transmission of a status report as well.
- 5 PERSISTENCE is a variable used for selected Supervisory protocol activities. (See 4.2.2.2.)
- 6 The selection of an SDU issues an extract data unit request to the FOP-P. (See FOP-P data selection, described in 7.2.)
- 7 SS = 1 indicates transmit carrier only.
- 8 SS = 5 indicates TX off, RX waiting for response.

### 6.6.4 DISCUSSION—PROVISION OF U-FRAME FOR SELECTION

The provision of a U-frame for selection through use of the procedures contained in table 6-14 is defined in the FOP-P portion of the COP-P specification (see 7.2). Operations on a single PCID are described in this specification. The simultaneous use of multiple PCIDs is possible, but concurrent COP-P procedures are required and the reporting is then required to contain the status for each PCID. Data prioritization and its multiplexing for selection into the output coded symbol stream of simultaneous multiple PCID operations as specified above is outside the scope of this document.

## 6.6.5 DISCUSSION—EVENTS RELATED TO DATA HANDLING ACTIVITIES

NEED\_PLCW is set to *false* whenever a PLCW is chosen for output (6.2.3.6.2). NEED\_STATUS\_REPORT is set to *false* whenever a status report is chosen for output (6.2.3.6.2). No\_Frames\_Pending (6.3.2.3) occurs when none of the conditions for selecting an SPDU (including a PLCW) or U-frame is satisfied. Output FIFO = empty (6.3.2.2) is *true* when the last bit contained within the Output FIFO is extracted.

## 6.7 RECEIVING OPERATIONS

### 6.7.1 FRAME RECEPTION

**6.7.1.1** Establishment of physical channel characteristics and initialization of receiving procedures shall be accomplished via a SET MODE (*connecting-L*) or SET MODE (*connecting-T*) local directive (see 6.3.3.1.1 and 6.2.2.1).

**6.7.1.2** The Frame Sublayer shall accept for validation frames delivered via the C&S Sublayer ChannelAccess.indication service primitive (see reference [5], annex B).

#### NOTES

- 1 When the Receive State is *on*, the received (optionally decoded) bitstream is processed by the C&S Sublayer to delimit the contained frames (this process requires frame synchronization and frame length determination using the frame header length field).
- 2 The delimited frame and the attached CRC-32 are processed by the C&S Sublayer to determine if the frame contains errors. Erred frames are rejected as invalid.

### 6.7.2 FRAME VALIDATION

Frame Validation Criteria shall be as follows:

- a) If the Frame Version Number does not equal binary '10', the frame is rejected as invalid.
- b) If the Spacecraft ID field in the transfer frame header does not contain the value of the Local\_Spacecraft\_ID (MIB parameter) when the Source-or-Destination Identifier value equals '1', i.e., *destination*, the frame is rejected as invalid.
- c) If the Spacecraft ID field in the transfer frame header does not contain the value equal to the RECEIVING\_SCID\_BUFFER for all frames received (i.e., Remote\_Spacecraft\_ID, MIB parameter) when the RECEIVING\_SCID\_BUFFER is non-zero and the Source-or-Destination Identifier value equals '0', i.e., *source*, and Test\_Source is *true*, a session violation has occurred and the vehicle controller is notified (see annex D). When the RECEIVING\_SCID\_BUFFER is zero and Test\_Source is *true*, the value of the SCID field in the header of the first received



frame whose Source-or-Destination ID is *source* is loaded into RECEIVING\_SCID\_BUFFER and thereafter used for validation for the remainder of the session. (See also related 6.2.4.2.)

NOTE – The EXPEDITED\_FRAME\_COUNTER increments for each validated Expedited frame received.

## **6.7.3 VALIDATED FRAME PROCESSING**

### **6.7.3.1 Validated U-Frames**

Validated received U-frames shall be processed per the COP-P process described in 4.3.3.

### **6.7.3.2 Validated P-Frames**

**6.7.3.2.1** Validated P-frames shall be processed by first delimiting the contained SPDUs.

**6.7.3.2.2** PLCWs contained within SPDUs shall be transferred to the COP-P processor.

**6.7.3.2.3** All other reports or directives shall be processed for protocol actions.

## 7 COMMUNICATION OPERATIONS PROCEDURE FOR PROXIMITY LINKS

### 7.1 OVERVIEW

An important overview of the COP-P protocol is provided in 4.3.3.

The sending and receiving procedures for COP-P use single octet variables that are modulo-256 counters. When subtracting or comparing any two of these variables, special handling is required:

- Subtraction: The difference,  $A-B$ , is the number of times  $B$  needs to be incremented to reach  $A$ .
- Comparison:  $B < A$  is true if the difference,  $A-B$ , is between 1 and 127.  
 $B > A$  is true if the difference,  $A-B$ , is between 128 and 255.  
 $B = A$  is true if the difference,  $A-B$ , is 0.

### 7.2 SENDING PROCEDURES (FOP-P)

#### 7.2.1 QUEUE

The FOP-P shall maintain a single output queue.

#### NOTES

- 1 The **Sent Frame queue** contains Sequence Controlled frames that have been sent but not yet acknowledged by the receiver. (This name is abbreviated to ‘Sent queue’ in the state table).
- 2 The local directive CLEAR QUEUE (*Queue Type*) allows for the clearing of frames within a specified queue.

#### 7.2.2 FOP-P VARIABLES

FOP-P variables are:

- a) VE(S): an 8-bit positive integer whose value shall represent the sequence number (modulo 256) of the next Expedited frame to be sent.
- b) V(S): an 8-bit positive integer whose value shall represent the sequence number (modulo 256) of the next new Sequence Controlled frame to be sent.

CCSDS RECOMMENDED STANDARD FOR PROXIMITY-1 SPACE DATA LINK PROTOCOL

- c) VV(S): an 8-bit positive integer whose value shall represent the sequence number (modulo 256) to be assigned to the next Sequence Controlled frame to be sent. It equals V(S) unless a retransmission is in-progress.
- d) N(R): an 8-bit positive integer that is a copy of the Report Value (see 3.2.4) from the current PLCW. It shall represent the sequence number plus one (modulo 256) of the last Sequence Controlled frame acknowledged by the receiver.
- e) NN(R): an 8-bit positive integer system variable known both inside and outside of the FOP-P state table. It shall contain a copy of the Report Value from the previous valid PLCW.
- f) R(R): a Boolean variable (i.e., its value is either *true* or *false*) that is a copy of the Retransmit Flag from the current PLCW. It shall indicate whether or not Sequence Controlled frame(s) need to be retransmitted.
- g) RR(R): a Boolean variable that is a copy of the Retransmit Flag from the previous valid PLCW.
- h) NEED\_PLCW/NEED\_STATUS\_REPORT: Boolean system variables known both inside and outside of the FOP-P state table. (See 6.2.3.6 for complete usage.) They shall indicate whether or not a new PLCW or status report needs to be sent (the PLCW needs to be sent whenever its contents change).
- i) SYNCH\_TIMER: a countdown timer that contains the time a sender shall wait to receive a valid PLCW from a receiver before taking action to synchronize with the receiver. The MIB parameter associated with this timer, Synch\_Timeout, represents a desired time value consistent with the Interval Clock frequency (see 6.3). The SYNCH\_TIMER counts down when its value is non-zero. When the SYNCH\_TIMER counts down to 1, the SYNCH\_TIMER expires and the Start Local Resync Event, SE6 is triggered. Subsequently, the timer then underflows to zero, which is the inactive state for the timer.
- j) RESYNC: a Boolean variable that tracks the status of resynchronization within the COP-P. This variable is set to *true* when the SET V(R) activity occurs, indicating that FOP-P is resynchronizing. It is reset to *false* by the End Local Resync event, SE7.

## 7.2.3 FOP-P STATE TABLE EVENTS

### 7.2.3.1 General Procedures

7.2.3.1.1 ‘Initialize’ shall set the following variables to the indicated values:

- a) V(S) = VE(S) = VV(S) = NN(R) = N(R) = 0;
- b) R(R) = RR(R) = RESYNC = *false*;
- c) NEED\_PLCW = NEED\_STATUS\_REPORT = *true*;

d) CLEAR QUEUE (*Sent queue*); CLEAR QUEUE (*Seq queue*).

**7.2.3.1.2** ‘Remove acknowledged frames from Sent queue’ shall remove  $n$  frames from the Sent queue, where  $n = N(R) - NN(R)$  (i.e., the number of times that  $NN(R)$  has to be incremented to reach  $N(R)$ ).

**7.2.3.1.3** ‘Start SYNCH\_TIMER’ shall, if SYNCH\_TIMER is equal to ‘0’, set SYNCH\_TIMER to the value of the MIB parameter Synch\_Timeout.

NOTE – If the value of Synch\_Timeout is ‘0’, then the SYNCH\_TIMER never expires.

**7.2.3.1.4** ‘Clear SYNCH\_TIMER’ shall set the SYNCH\_TIMER value to ‘0’.

NOTE – This does not trigger a resynchronization.

**7.2.3.1.5** ‘Store this PLCW’ shall

- a) assign the value of  $N(R)$  to  $NN(R)$ ;
- b) assign the value of  $R(R)$  to  $RR(R)$ .

**7.2.3.1.6** ‘Send EXP (Expedited) Frame’ shall

- a) remove frame from EXP queue;
- b) assign  $VE(S)$  to the frame;
- c) increment  $VE(S)$ ;
- d) report  $VE(S)$  to the I/O Sublayer;
- e) transfer this frame to the Frame Sublayer.

**7.2.3.1.7** ‘Resend SEQ (Sequence Controlled) Frame’ shall

- a) copy frame number  $VV(S)$  from the Sent queue;
- b) increment  $VV(S)$ ;
- c) transfer this frame to the Frame Sublayer.

**7.2.3.1.8** ‘Send New SEQ Frame’ shall

- a) remove frame from SEQ queue;
- b) assign  $V(S)$  to the frame;
- c) insert a copy of the frame to the end of the Sent queue;
- d) increment  $V(S)$ ;
- e) increment  $VV(S)$ ;

CCSDS RECOMMENDED STANDARD FOR PROXIMITY-1 SPACE DATA LINK PROTOCOL

- f) report V(S) to the I/O Sublayer;
- g) transfer this frame to the Frame Sublayer.

### 7.2.3.2 SET V(R) Persistent Activity

NOTE – The SET V(R) persistent activity (including setup of the MIB parameters before the execution of this activity) is defined below. (See 4.2.2.2, ‘Persistene’ for a general overview of how the MIB parameters relate to the persistent activity.)

**7.2.3.2.1** Configure the SET V(R) persistent activity. The MIB Parameters that shall be used for setup are:

- a) Activity is SET V(R), i.e., Resync;
- b) Resync\_Waiting\_Period (implementation specific) is the amount of time specified for the Resync\_Response to be received before the process declares that this activity is to be either repeated or aborted;
- c) Resync\_Response is the acknowledgement from the Receiver Node that the SET V(R) directive has been accepted, i.e., a valid PLCW with report value of N(R) = NN(R) and R(R) = *false* has been received, when RESYNC = *true* (see State S2, Event SE2, FOP-P State table);
- d) Resync\_Notification is a notification to inform the vehicle controller of success or failure of resynchronization;
- e) Resync\_Lifetime (implementation specific) is the time period during which the Resynchronization activity shall be repeated until the Resync\_Response is detected;
- f) Resync\_Local is set to *true*.

**7.2.3.2.2** Execute the SET V(R) persistent activity. The following shall occur:

- a) the FOP-P requests a SET V(R) Persistent Activity by setting RESYNC = *true* (see state S1, event SE4 in the FOP-P state table);
- b) the MAC Sublayer builds a SET V(R) directive by: 1) copying NN(R) into the SEQ\_CTRL\_FSN field within the SET V(R) directive and 2) setting the PCID field in the SET V(R) directive to the value associated with this FOP-P;
- c) the MAC Sublayer loads this directive into the MAC queue for transmission and sets MAC\_FRAME\_PENDING = *true*;
- d) the MAC Sublayer sets PERSISTENCE = *true*;

NOTE – This initiates the SET V(R) persistent activity.

- e) the FOP-P terminates the SET V(R) Persistent Activity when the SET V(R) Resync\_Response is received or when the Resync\_Lifetime expires. (See 7.2.3.2.1 c.)

### 7.2.3.3 FOP-P State Table

| Event Number/Name                                                                       | Resulting Action in State S1 Active                                                                                                                                                                                                                                                                                                                                                                                                                                   | Resulting Action in State S2 Resync                                                                |
|-----------------------------------------------------------------------------------------|-----------------------------------------------------------------------------------------------------------------------------------------------------------------------------------------------------------------------------------------------------------------------------------------------------------------------------------------------------------------------------------------------------------------------------------------------------------------------|----------------------------------------------------------------------------------------------------|
| SE0<br>At Session Startup<br>(see note 1)                                               | <i>Initialize.</i><br>(see note 2)                                                                                                                                                                                                                                                                                                                                                                                                                                    | N/A                                                                                                |
| SE1<br>Frame Sublayer<br>needs frame to<br>transmit<br>(see note 3)<br><br>(see note 4) | If Expedited_Frame_Available=true<br><i>Send EXP Frame.</i><br>Else if VV(S) < V(S)<br># Continue the in-progress retransmission:<br><i>Resend SEQ Frame.</i><br>Else if<br>(SEQUENCE_CONTROLLED_FRAME_AVAILABLE=true and V(S)-NN(R)<Transmission_Window)<br><i>Send New SEQ Frame.</i><br>Else if NN(R) < V(S)<br># Initiate a Progressive Retransmission:<br>VV(S)=NN(R)<br><i>Resend SEQ Frame.</i><br>Else<br># There is no Data Services frame to send.<br>Endif | N/A                                                                                                |
| SE2<br>Valid PLCW Received<br>(see note 5)                                              | If N(R) > NN(R)<br><i>Remove acknowledged frames from Sent queue.</i><br>Endif<br>If R(R) = true or N(R)>VV(S)<br>VV(S) = N(R)<br>Endif<br><i>Store this PLCW.</i><br><i>Clear SYNCH_TIMER.</i>                                                                                                                                                                                                                                                                       | If R(R) = false and<br>N(R)=NN(R)<br>Resync=false<br>Persistence=false<br><b>State=S1</b><br>Endif |
| SE3<br>Invalid PLCW<br>Received<br>(see note 5)                                         | <i>Start SYNCH_TIMER.</i><br>VV(S) = NN(R)                                                                                                                                                                                                                                                                                                                                                                                                                            | Ignore                                                                                             |
| SE4<br>Synch-timer<br>Expired<br>(see note 6)                                           | Notify vehicle controller that<br><i>SYNCH_TIMER</i> expired (see annex D).<br>If Resync_Local (MIB parameter) = true<br>RR(R)=false<br>Resync=true<br><b>State=S2</b><br>Endif                                                                                                                                                                                                                                                                                       | N/A                                                                                                |
| SE5<br>Set<br>Transmission_Window<br>Request                                            | Accept.<br>Set.                                                                                                                                                                                                                                                                                                                                                                                                                                                       | Accept.<br>Set.                                                                                    |

CCSDS RECOMMENDED STANDARD FOR PROXIMITY-1 SPACE DATA LINK PROTOCOL

| Event Number/Name                | Resulting Action in State S1 Active | Resulting Action in State S2 Resync              |
|----------------------------------|-------------------------------------|--------------------------------------------------|
| SE6<br>Set Synch_Timeout Request | Accept.<br>Set.                     | Accept.<br>Set.                                  |
| SE7<br>Reset Request             | Accept.<br><i>Initialize.</i>       | Accept.<br><i>Initialize.</i><br><b>State=S1</b> |
| SE8<br>Invalid Request           | Reject.                             | Reject.                                          |

NOTES

- 1 At each session startup, the FOP-P enters state S1 and triggers event SE0 before allowing any other events to occur. If subsequent reconnection is desired without starting a new session, the FOP-P can continue data services by maintaining and using the current state of the FOP-P variables.
- 2 Procedures are in italics and are described in 7.2.3.1; comments are preceded by the '#' sign.
- 3 'Progressive Retransmission' causes the frames on the Sent queue to be retransmitted.
- 4 Transmission\_Window (MIB parameter): The maximum number of Sequence Controlled frames that can be unacknowledged at any given time. For example, if the Transmission\_Window is 10 and the sender sends 10 Sequence Controlled frames, the sender must wait for at least one of those frames to be acknowledged by the receiver before it can send any additional Sequence Controlled frames. The value of Transmission\_Window cannot exceed 127. When selecting a value for this parameter, the system designer should consider the latency involved whenever frames are required to be retransmitted from the Sent queue before a new Sequence Controlled frame can be transmitted.
- 5 An incoming PLCW is invalid if any of these conditions is true:
  - a) PLCW does not match PLCW format.
  - b)  $N(R) < NN(R)$  'Invalid N(R)—too small'
  - c)  $N(R) > V(S)$  'Invalid N(R)—too large'
  - d)  $R(R) = true$  and  $N(R) = V(S)$  'Retransmit is set though all frames are acknowledged'
  - e)  $R(R) = false$  and  $RR(R) = true$  and  $N(R) = NN(R)$  'Retransmit has cleared though no new frames are acknowledged'

Otherwise, the PLCW is valid.
- 6 Setting  $Resync = true$  causes a Set V(R) persistent activity to be initiated (see 7.2.3.2, 4.2.2.2, and annex D).

## 7.3 RECEIVING PROCEDURES (FARM-P)

### 7.3.1 FARM-P STATE TABLE

| Events                                                 | Event #/Name                                                     | Action                                                                                                                 |
|--------------------------------------------------------|------------------------------------------------------------------|------------------------------------------------------------------------------------------------------------------------|
| 'Entered this state' at each session startup           | <b>RE0</b><br><b>Initialization</b>                              | R(S) = <i>false</i> ;<br>V(R) = 0;<br>EXPEDITED_FRAME_COUNTER = 0;<br>NEED_PLCW AND NEED_STATUS_REPORT = <i>true</i> ; |
| Invalid frame arrives                                  | <b>RE1</b><br><b>Invalid Frame</b>                               | Discard the frame;                                                                                                     |
| Valid 'SET V(R)' directive arrives                     | <b>RE2</b><br><b>SET V(R)</b>                                    | R(S) = <i>false</i> ;<br>Set V(R) to the SEQ_CTRL_FSN in the directive;<br>NEED_PLCW = <i>true</i> ;                   |
| Valid Expedited frame arrives                          | <b>RE3</b><br><b>Valid Expedited Frame</b>                       | Accept/Pass the frame to I/O Sublayer;<br>Increment EXPEDITED_FRAME_COUNTER;                                           |
| Valid Sequence Controlled frame arrives,<br>N(S)= V(R) | <b>RE4</b><br><b>Sequence Frame</b><br><b>'in-sequence'</b>      | Accept/Pass the frame to I/O Sublayer;<br>R(S) = <i>false</i> ;<br>Increment V(R);<br>NEED_PLCW = <i>true</i> ;        |
| Valid Sequence Controlled frame arrives,<br>N(S)>V(R)  | <b>RE5</b><br><b>Sequence Frame</b><br><b>'gap detected'</b>     | Discard the frame;<br>R(S) = <i>true</i> ;<br>NEED_PLCW = <i>true</i> ;                                                |
| Valid Sequence Controlled frame arrives,<br>N(S)<V(R)  | <b>RE6</b><br><b>Sequence Frame</b><br><b>'already received'</b> | Discard the frame;                                                                                                     |
| Frame Sublayer requests content for PLCW               | <b>RE7</b><br><b>Report PLCW contents</b>                        | Report value of R(S), V(R), and EXPEDITED_FRAME_COUNTER;                                                               |

### 7.3.2 INTERNAL FARM-P VARIABLES

The internal FARM-P variables shall be:

- a) V(R): an 8-bit positive integer whose value represents the sequence number plus one (modulo 256) of the last Sequence Controlled frame acknowledged by the receiver;
- b) R(S): a Boolean variable (i.e., its value is either *true* or *false*) that is copied to the PLCW, indicating whether or not Sequence Controlled frames need to be retransmitted;
- c) N(S): an 8-bit positive integer whose value represents the sequence number (modulo 256) contained in the transfer frame header of the Proximity-1 Frame;



- d) EXPEDITED\_FRAME\_COUNTER: a 3-bit positive integer whose value represents the number of Expedited frames received (modulo 8). This counter can be used by the receiver to keep track of the number of Expedited frames received over a communications session.

### **7.3.3 INTERFACE TO THE I/O LAYER**

FARM-P shall pass valid Expedited and valid in-sequence U-frames to the I/O Sublayer (4.4).

NOTE – At the I/O Sublayer these frames are buffered, assembled into packets as required, and then delivered via the specified output port.

## 8 INPUT/OUTPUT SUBLAYER OPERATIONS

### 8.1 OVERVIEW

The I/O Sublayer provides the interface with the spacecraft data provider and data recipient. This section describes operations with a single user data source and single physical channel. It should be noted that implementations are not limited to a single data source. The fundamental role of the I/O Sublayer is to form the frame data units for transfer across the link, and to pass received data units out to the physical and logical destinations identified in the received frame.

### 8.2 SENDING OPERATIONS

NOTE – The sending side of the I/O Sublayer interfaces with the data supplier.

At the sending side, the I/O Sublayer:

- a) shall provide the procedures that accept the user service data units and prepare them for transfer across the communications channel;
- b) may be required to parse large input packets into segments compatible with the maximum frame data size allowed in the asynchronous link;
- c) shall assemble the data units for inclusion into frames in accordance with the restrictions imposed by various MIB parameters;
- d) shall receive the user service data unit along with its routing and control instructions;

NOTE – These instructions are required for the formulation of the frame header and to determine whether data units can be combined into the same frame or not. The frame construction rules in section 3 imply that all data units within the same frame must be addressed to the same spacecraft destination, contain the same PDU type ID, the same physical channel ID, the same output Port ID, have the same QoS and must be of the same service data unit type (DFC ID).

- e) shall have the responsibility to inform the data supplier which service data units were transmitted and, in the case of Sequence Controlled service, which data units were acknowledged as received by the communications partner.

NOTE – This notification is essential to enable reliable data service operations across multiple sessions, if desired. Sending operations also includes Simplex-Transmit.

### **8.3 RECEIVING OPERATIONS**

NOTE – The receiving side of the I/O Sublayer interfaces has a multitude of possible interfaces with the spacecraft. One of eight possible output ports can be identified in the frame using the Port ID field.

**8.3.1** At the receiver side, the role of the I/O Sublayer shall be to route a received ‘complete’ data unit to the identified port.

**8.3.2** When segmentation is used, the I/O Sublayer shall accept received segments and try to re-assemble the user’s data unit.

**8.3.3** The I/O Sublayer shall deliver only completely reassembled data units; i.e., partial data units are not delivered to the end user.

NOTE – Receiving operations also includes Simplex-Receive.

## ANNEX A

### PROTOCOL IMPLEMENTATION CONFORMANCE STATEMENT (PICS) PROFORMA

#### (NORMATIVE)

#### A1 INTRODUCTION

##### A1.1 OVERVIEW

This annex provides the Protocol Implementation Conformance Statement (PICS) Requirements List (RL) for an implementation of *Proximity-1 Space Link Protocol—Data Link Layer* (CCSDS 211.0-B-5). The PICS for an implementation is generated by completing the RL in accordance with the instructions below. An implementation claiming conformance must satisfy the mandatory requirements referenced in the RL.

The RL support column in this annex is blank. An implementation's completed RL is called the PICS. The PICS states which capabilities and options have been implemented. The following can use the PICS:

- the implementer, as a checklist to reduce the risk of failure to conform to the standard through oversight;
- a supplier or potential acquirer of the implementation, as a detailed indication of the capabilities of the implementation, stated relative to the common basis for understanding provided by the standard PICS proforma;
- a user or potential user of the implementation, as a basis for initially checking the possibility of interworking with another implementation (it should be noted that, while interworking can never be guaranteed, failure to interwork can often be predicted from incompatible PICSes);
- a tester, as the basis for selecting appropriate tests against which to assess the claim for conformance of the implementation.

##### A1.2 ABBREVIATIONS AND CONVENTIONS

The RL consists of information in tabular form. The status of features is indicated using the abbreviations and conventions described below.

###### Item Column

The item column contains sequential numbers for items in the table.

NOTE – The item-number prefix 'DLL' = 'Data Link Layer'.

### Feature Column

The feature column contains a brief descriptive name for a feature. It implicitly means ‘Is this feature supported by the implementation?’

### Status Column

The status column uses the following notations:

|       |                                                                                                            |
|-------|------------------------------------------------------------------------------------------------------------|
| M     | mandatory.                                                                                                 |
| O     | optional.                                                                                                  |
| O.<n> | optional, but support of at least one of the group of options labeled by the same numeral <n> is required. |

### Support Column Symbols

The support column is to be used by the implementer to state whether a feature is supported by entering Y, N, or N/A, indicating:

|     |                                          |
|-----|------------------------------------------|
| Y   | Yes, supported by the implementation.    |
| N   | No, not supported by the implementation. |
| N/A | Not applicable.                          |

The support column should also be used, when appropriate, to enter values supported for a given capability.

## **A1.3 INSTRUCTIONS FOR COMPLETING THE RL**

An implementer shows the extent of compliance to the Recommended Standard by completing the RL; that is, the state of compliance with all mandatory requirements and the options supported are shown. The resulting completed RL is called a PICS. The implementer shall complete the RL by entering appropriate responses in the support or values supported column, using the notation described in A1.2. If a conditional requirement is inapplicable, N/A should be used. If a mandatory requirement is not satisfied, exception information must be supplied by entering a reference  $X_i$ , where  $i$  is a unique identifier, to an accompanying rationale for the noncompliance.

## A2 PICS PROFORMA FOR PROXIMITY-1 SPACE LINK PROTOCOL—DATA LINK LAYER (CCSDS 211.0-B-5)

### A2.1 GENERAL INFORMATION

#### A2.1.1 Identification of PICS

|                                              |  |
|----------------------------------------------|--|
| Date of Statement (DD/MM/YYYY)               |  |
| PICS serial number                           |  |
| System Conformance statement cross-reference |  |

#### A2.1.2 Identification of Implementation Under Test (IUT)

|                        |  |
|------------------------|--|
| Implementation name    |  |
| Implementation version |  |
| Special Configuration  |  |
| Other Information      |  |

#### A2.1.3 Identification of Supplier

|                                                                                                                          |  |
|--------------------------------------------------------------------------------------------------------------------------|--|
| Supplier                                                                                                                 |  |
| Contact Point for Queries                                                                                                |  |
| Implementation Name(s) and Versions                                                                                      |  |
| Other information necessary for full identification, e.g., name(s) and version(s) for machines and/or operating systems; |  |
| System Name(s)                                                                                                           |  |

#### A2.1.4 Identification of Specification

|                                                                                                                                                                                                                                                |                |
|------------------------------------------------------------------------------------------------------------------------------------------------------------------------------------------------------------------------------------------------|----------------|
| CCSDS 211.0-B-5                                                                                                                                                                                                                                |                |
| Have any exceptions been required?                                                                                                                                                                                                             | Yes [ ] No [ ] |
| <p>NOTE – A YES answer means that the implementation does not conform to the Recommended Standard. Non-supported mandatory capabilities are to be identified in the PICS, with an explanation of why the implementation is non-conforming.</p> |                |

## A2.2 REQUIREMENTS LIST

| <b>Version-3 Transfer Frame</b> |                                                          |                  |               |                       |                |
|---------------------------------|----------------------------------------------------------|------------------|---------------|-----------------------|----------------|
| <b>Item</b>                     | <b>Description</b>                                       | <b>Reference</b> | <b>Status</b> | <b>Values Allowed</b> | <b>Support</b> |
| DLL-1                           | Version-3 Transfer Frame                                 | 3.2.1            | M             |                       |                |
| DLL-2                           | Transfer Frame Header                                    | 3.2.2            | M             |                       |                |
| DLL-3                           | Transfer Frame Version Number                            | 3.2.2.2          | M             | 2                     |                |
| DLL-4                           | Quality of Service Indicator                             | 3.2.2.3          | M             | 0, 1                  |                |
| DLL-5                           | PDU Type ID                                              | 3.2.2.4          | M             | 0, 1                  |                |
| DLL-6                           | Data Field Construction ID                               | 3.2.2.5          | M             | 0–3                   |                |
| DLL-7                           | Spacecraft Identifier (SCID)                             | 3.2.2.6          | M             | 0–1023                |                |
| DLL-8                           | Physical Channel Identifier (PCID)                       | 3.2.2.7          | M             | 0, 1                  |                |
| DLL-9                           | Port Identifier                                          | 3.2.2.8          | M             | 0–7                   |                |
| DLL-10                          | Source-or-Destination Identifier                         | 3.2.2.9          | M             | 0, 1                  |                |
| DLL-11                          | Frame Length                                             | 3.2.2.10         | M             | 4–2047                |                |
| DLL-12                          | Frame Sequence Number (Sequence Controlled or Expedited) | 3.2.2.11         | M             | 0–255                 |                |
| DLL-13                          | Transfer Frame Data Field                                | 3.2.3            | M             | 0–2043 octets         |                |
| DLL-14                          | PACKETS in a U-Frame (DFC ID = 0)                        | 3.2.3.2          | O.1           |                       |                |
| DLL-15                          | SEGMENT DATA UNITS in a U-Frame (DFC ID = 1)             | 3.2.3.3          | O.1           |                       |                |
| DLL-16                          | CCSDS RESERVED FIELD (U-Frame) (DFC ID = 2)              | 3.2.3.4          | O.1           |                       |                |
| DLL-17                          | USER-DEFINED DATA in a U-Frame (DFC ID = 3)              | 3.2.3.5          | O.1           |                       |                |
| DLL-18                          | Transfer Frame Data Field Contents in a P-frame          | 3.2.3.6          | M             |                       |                |

O.1 For the Transfer Frame Data Field at least one must be chosen.

| <b>Supervisory PDU (SPDU)</b> |                                                  |                  |               |                       |                |
|-------------------------------|--------------------------------------------------|------------------|---------------|-----------------------|----------------|
| <b>Item</b>                   | <b>Description</b>                               | <b>Reference</b> | <b>Status</b> | <b>Values Allowed</b> | <b>Support</b> |
| DLL-19                        | SUPERVISORY PDU (SPDU)                           | 3.2.4            | M             |                       |                |
| DLL-20                        | Fixed-length SPDU                                | 3.2.4.2.1        | M             |                       |                |
| DLL-21                        | Variable-length SPDU                             | 3.2.4.4          | M             |                       |                |
| DLL-22                        | Variable-Length SPDU Type 1 (Directives/Reports) | 3.2.4.2.2, B1    | M             |                       |                |
| DLL-23                        | Variable-Length SPDU Type 2: Time Distribution   | 3.2.4.4.3, B2    | O             |                       |                |
| DLL-24                        | Variable-Length SPDU Type 3: Status Reports      | 3.2.4.4.4        | O             |                       |                |

CCSDS RECOMMENDED STANDARD FOR PROXIMITY-1 SPACE DATA LINK PROTOCOL

| <b>Data Link Layer</b> |                                        |                  |               |                       |                |
|------------------------|----------------------------------------|------------------|---------------|-----------------------|----------------|
| <b>Item</b>            | <b>Description</b>                     | <b>Reference</b> | <b>Status</b> | <b>Values Allowed</b> | <b>Support</b> |
| DLL-25                 | Frame Sub-Layer Functions              | 4.1.1            | M             |                       |                |
| DLL-26                 | Sending End Frame Selection for Output | 4.1.2            | M             |                       |                |

| <b>Medium Access Control (MAC) Sublayer</b> |                        |                  |               |                       |                |
|---------------------------------------------|------------------------|------------------|---------------|-----------------------|----------------|
| <b>Item</b>                                 | <b>Description</b>     | <b>Reference</b> | <b>Status</b> | <b>Values Allowed</b> | <b>Support</b> |
| DLL-27                                      | Persistence            | 4.2.2.2          | M             |                       |                |
| DLL-28                                      | MAC Control Mechanisms | 4.2.2            | M             |                       |                |
| DLL-29                                      | Directive Decoder      | 4.2.3            | M             |                       |                |
| DLL-30                                      | MAC buffers            | 4.2.4            | M             |                       |                |
| DLL-31                                      | SENT_TIME_BUFFER       | 4.2.4.1          | M             |                       |                |
| DLL-32                                      | RECEIVE_TIME_BUFFER    | 4.2.4.2          | M             |                       |                |

| <b>Data Services Sublayer</b> |                                         |                  |               |                       |                |
|-------------------------------|-----------------------------------------|------------------|---------------|-----------------------|----------------|
| <b>Item</b>                   | <b>Description</b>                      | <b>Reference</b> | <b>Status</b> | <b>Values Allowed</b> | <b>Support</b> |
| DLL-33                        | Send Side Functionality                 | 4.3.1.1          | M             |                       |                |
| DLL-34                        | Receive Side Functionality              | 4.3.1.2          | M             |                       |                |
| DLL-35                        | Order in which User Data is transferred | 4.3.2.1          | M             |                       |                |
| DLL-36                        | Two Qualities of Service                | 4.3.2.2          | M             |                       |                |



CCSDS RECOMMENDED STANDARD FOR PROXIMITY-1 SPACE DATA LINK PROTOCOL

| <b>I/O Interface Sublayer</b>                  |                                                              |                  |               |                       |                |
|------------------------------------------------|--------------------------------------------------------------|------------------|---------------|-----------------------|----------------|
| <b>Item</b>                                    | <b>Description</b>                                           | <b>Reference</b> | <b>Status</b> | <b>Values Allowed</b> | <b>Support</b> |
| <b>Send Side</b>                               |                                                              |                  |               |                       |                |
| DLL-37                                         | Accept user data for transfer                                | 4.4.1.1 a)       | M             |                       |                |
| DLL-38                                         | Form the Frame Data Unit and the Transfer Frame Header       | 4.4.1.1 b)       | M             |                       |                |
| DLL-39                                         | Expedited SDU is radiated                                    | 4.4.1.1 c)       | M             |                       |                |
| DLL-40                                         | Transfer of a Sequence Controlled SDU                        | 4.4.1.1 d)       | M             |                       |                |
| <b>Receive Side</b>                            |                                                              |                  |               |                       |                |
| DLL-41                                         | Output SDUs                                                  | 4.4.1.2 a)       | M             |                       |                |
| DLL-42                                         | Assemble segments/verify packets                             | 4.4.1.2 b)       | M             |                       |                |
| DLL-43                                         | Deliver only complete packets                                | 4.4.1.2 c)       | M             |                       |                |
| DLL-44                                         | Deliver the packets/user-defined data                        | 4.4.1.2 d)       | M             |                       |                |
| <b>Interface to the Lower Sublayers</b>        |                                                              |                  |               |                       |                |
| DLL-45                                         | SDUs to appropriate Queues (Sequence or Expedited)           | 4.4.2.1          | M             |                       |                |
| DLL-46                                         | Existence of Expedited queue and Sequence Controlled queue   | 4.4.2.1          | M             |                       |                |
| DLL-47                                         | Association between SDU and frame sequence number            | 4.4.2.3          | M             |                       |                |
| DLL-48                                         | Evaluation of NNR for complete SDU transfer                  | b)               | M             |                       |                |
| <b>I/O Sublayer Queues and Control Signals</b> |                                                              |                  |               |                       |                |
| DLL-49                                         | Data units stored within the Sequence Controlled Frame queue | 4.4.3.1          | M             |                       |                |
| DLL-50                                         | Data units stored within the Expedited Frame queue           | 4.4.3.2          | M             |                       |                |
| DLL-51                                         | Frame extraction from either queue                           | 4.4.3.3          | M             |                       |                |

CCSDS RECOMMENDED STANDARD FOR PROXIMITY-1 SPACE DATA LINK PROTOCOL

| Proximity-1 Timing Services         |                                                  |           |        |                |         |
|-------------------------------------|--------------------------------------------------|-----------|--------|----------------|---------|
| Item                                | Description                                      | Reference | Status | Values Allowed | Support |
| Time Tag Recording                  |                                                  |           |        |                |         |
| DLL-52                              | Time Tagged Bit                                  | 5.2.1     | M      |                |         |
| DLL-53                              | Time Tag Event                                   | 5.2.2     | M      |                |         |
| DLL-54                              | Time Tags relationship to time reference point   | 5.2.3     | M      |                |         |
| DLL-55                              | Enterprise defined time reference point          | 5.2.4     | M      |                |         |
| DLL-56                              | Operational Mode                                 | 5.2.5     | M      |                |         |
| DLL-57                              | Initiate Time Tag Collection                     | 5.2.6     | M      |                |         |
| DLL-58                              | Capture and Package Time Tags + Meta Data        | 5.2.7     | M      |                |         |
| DLL-59                              | Time Correlation Process                         | 5.3       | O      |                |         |
| Transferring Time to a Remote Asset |                                                  |           |        |                |         |
| DLL-60                              | Time Distribution                                | 5.4.1     | M      |                |         |
| DLL-61                              | Compute Enterprise Time                          | 5.4.2.1   | O      |                |         |
| DLL-62                              | Send Side: Formulate Time Distribution Directive | 5.4.2.2   | M      |                |         |
| DLL-63                              | Send Side: Transmit Time Distribution Directive  | 5.4.2.3   | M      |                |         |
| DLL-64                              | Receive Side: Time Distribution Directive        | 5.4.2.4   | M      |                |         |

| State Control Variables |             |           |        |                                                                       |         |
|-------------------------|-------------|-----------|--------|-----------------------------------------------------------------------|---------|
| Item                    | Description | Reference | Status | Values Allowed                                                        | Support |
| DLL-65                  | Mode        | 6.2.2.1   | M      | inactive,<br><i>connecting-T</i> ,<br><i>connecting-L</i> ,<br>active |         |
| DLL-66                  | DUPLEX      | 6.2.2.2   | M      | full, half,<br>simplex<br>transmit,<br>simplex<br>receive             |         |
| DLL-67                  | TRANSMIT    | 6.2.2.3   | M      | on, off                                                               |         |
| DLL-68                  | SUB-STATE   | 6.2.2.4   | M      | 0-7                                                                   |         |

CCSDS RECOMMENDED STANDARD FOR PROXIMITY-1 SPACE DATA LINK PROTOCOL

| <b>Operational Control Variables</b> |                                     |                  |               |                       |                |
|--------------------------------------|-------------------------------------|------------------|---------------|-----------------------|----------------|
| <b>Item</b>                          | <b>Description</b>                  | <b>Reference</b> | <b>Status</b> | <b>Values Allowed</b> | <b>Support</b> |
| DLL-69                               | Session Termination                 | 6.2.3.1          | M             | 0–5                   |                |
| DLL-70                               | COMM_CHANGE                         | 6.2.3.2          | M             | 0–5                   |                |
| DLL-71                               | SYMBOL_INLOCK_STATUS                | 6.2.3.3          | M             | 0, 1                  |                |
| DLL-72                               | Modulation                          | 6.2.3.4          | M             | on, off               |                |
| DLL-73                               | Persistence                         | 4.2.2.2          | M             | true, false           |                |
| DLL-74                               | NEED_PLCW and<br>NEED_STATUS_REPORT | 6.2.3.6          | M             | true, false           |                |
| DLL-75                               | REMOTE_SCID_BUFFER                  | 6.2.3.7          | M             | 0–1023                |                |
| DLL-76                               | COMMUNICATION_VALUE_BUFFER          | 6.2.3.8          | M             |                       |                |
| DLL-77                               | RECEIVING_SCID_BUFFER               | 6.2.3.9          | M             | 0–1023                |                |
| DLL-78                               | RECEIVING_PCID_BUFFER               | 6.2.3.10         | M             | 0, 1                  |                |

| <b>Elements And Events That Affect State Status</b> |                                             |                  |               |                       |                |
|-----------------------------------------------------|---------------------------------------------|------------------|---------------|-----------------------|----------------|
| <b>Item</b>                                         | <b>Description</b>                          | <b>Reference</b> | <b>Status</b> | <b>Values Allowed</b> | <b>Support</b> |
| DLL-79                                              | Interval_Clock                              | 6.3.1.1.1        | M             |                       |                |
| DLL-80                                              | WAIT_TIMER (WT) and<br>Associated Events    | 6.3.1.2          | M             |                       |                |
| DLL-81                                              | CARRIER_LOSS_TIMER and<br>Associated Events | 6.3.1.3          | M             |                       |                |
| DLL-82                                              | PLCW_TIMER and Associated<br>Events         | 6.3.1.4          | M             |                       |                |
| DLL-83                                              | OUTPUT_FIFO                                 | 6.3.2.2          | M             |                       |                |
| DLL-84                                              | NO_FRAMES_PENDING                           | 6.3.2.3          | M             |                       |                |

CCSDS RECOMMENDED STANDARD FOR PROXIMITY-1 SPACE DATA LINK PROTOCOL

| <b>Directives</b> |                                                          |                  |               |                       |                |
|-------------------|----------------------------------------------------------|------------------|---------------|-----------------------|----------------|
| <b>Item</b>       | <b>Description</b>                                       | <b>Reference</b> | <b>Status</b> | <b>Values Allowed</b> | <b>Support</b> |
| DLL-85            | Local Directives                                         | 6.3.3.1          | M             |                       |                |
| DLL-86            | SET MODE                                                 | 6.3.3.1.1        | M             |                       |                |
| DLL-87            | SET INITIALIZE MODE                                      | 6.3.3.1.1.2      | M             |                       |                |
| DLL-88            | Local COMM_CHANGE (LCCD)                                 | 6.3.3.1.3        | M             |                       |                |
| DLL-89            | LOAD COMMUNICATIONS VALUE BUFFER                         | 6.3.3.1.4        | M             |                       |                |
| DLL-90            | LOCAL_NO_MORE_DATA (LNMD)                                | 6.3.3.1.5        | O             |                       |                |
| DLL-91            | SET DUPLEX                                               | 6.3.3.1.6        | M             |                       |                |
| DLL-92            | SET RECEIVING SCID BUFFER                                | 6.3.3.1.7        | M             |                       |                |
| DLL-93            | READ STATUS                                              | 6.3.3.1.8        | O             |                       |                |
| DLL-94            | Remote directives                                        | 6.3.3.2          | M             |                       |                |
| DLL-95            | SET TRANSMITTER PARAMETERS directive                     | 6.3.3.2.2        | M             |                       |                |
| DLL-96            | SET RECEIVER PARAMETERS directive                        | 6.3.3.2.5        | M             |                       |                |
| DLL-97            | SET PL_EXTENSIONS directive                              | 6.3.3.2.6        | M             |                       |                |
| DLL-98            | The Set CONTROL PARAMETERS directive (Time Sample Field) | 6.3.3.2.7        | M             |                       |                |
| DLL-99            | Initialized values of Proximity-1 control variables      | Table 6-6        | M             |                       |                |

| <b>Duplex/Simplex Operations</b> |                        |                               |               |                       |                |
|----------------------------------|------------------------|-------------------------------|---------------|-----------------------|----------------|
| <b>Item</b>                      | <b>Description</b>     | <b>Reference</b>              | <b>Status</b> | <b>Values Allowed</b> | <b>Support</b> |
| DLL-100                          | Full duplex operations | 6.4.2, Tables 6-7, 6-8, 6-9   | M             |                       |                |
| DLL-101                          | Half duplex operations | 6.4.3, Table 6-10, 6-11, 6-12 | O             |                       |                |
| DLL-102                          | Simplex operations     | 6.4.4, Table 6-13             | O             |                       |                |

CCSDS RECOMMENDED STANDARD FOR PROXIMITY-1 SPACE DATA LINK PROTOCOL

| Interfaces with the Physical Layer |                                          |                         |        |                |         |
|------------------------------------|------------------------------------------|-------------------------|--------|----------------|---------|
| Item                               | Description                              | Reference               | Status | Values Allowed | Support |
| DLL-103                            | Output Interfaces                        | 6.5.1                   | M      |                |         |
| DLL-104                            | The TRANSMIT parameter                   | 6.5.1.1                 | M      | On, Off        |         |
| DLL-105                            | Frame output                             | 6.5.1.2                 | M      |                |         |
| DLL-106                            | The MODULATION parameter                 | 6.5.1.3                 | M      | On, Off        |         |
| DLL-107                            | Input interfaces                         | 6.5.2                   | M      |                |         |
| Sending Operations                 |                                          |                         |        |                |         |
| DLL-108                            | Session Establishment                    | 6.6.1                   | M      |                |         |
| DLL-109                            | Reset NEED_PLCW or<br>NEED_STATUS_REPORT | 6.2.3.6.2–<br>6.2.3.6.2 | M      | True,<br>False |         |
| DLL-110                            | Setting No_Frames_Pending                | 6.3.2.3                 | M      | True,<br>False |         |
| DLL-111                            | Setting OUTPUT_FIFO=empty                | 6.3.2.2                 | M      | True,<br>False |         |
| Receiving Operations               |                                          |                         |        |                |         |
| DLL-112                            | Frame Reception                          | 6.7.1                   | M      |                |         |
| DLL-113                            | Frame Validation Criteria                | 6.7.2                   | M      |                |         |
| DLL-114                            | Validated Frame Processing               | 6.7.3                   | M      |                |         |

CCSDS RECOMMENDED STANDARD FOR PROXIMITY-1 SPACE DATA LINK PROTOCOL

| <b>Communication Operations Procedure for Proximity Links COP-P</b> |                                                                                                              |                  |               |                       |                |
|---------------------------------------------------------------------|--------------------------------------------------------------------------------------------------------------|------------------|---------------|-----------------------|----------------|
| <b>Item</b>                                                         | <b>Description</b>                                                                                           | <b>Reference</b> | <b>Status</b> | <b>Values Allowed</b> | <b>Support</b> |
| DLL-115                                                             | Implement COP-P Protocol                                                                                     | 7, 4.3.3         | M             |                       |                |
| DLL-116                                                             | DATA SERVICES OPERATIONS (COP-P): Modulo-256 counters will be used for sequence number in the COP-P protocol | 7                | M             |                       |                |
| DLL-117                                                             | SENDING PROCEDURES (FOP-P)                                                                                   | 7.2              | M             |                       |                |
| DLL-118                                                             | The FOP-P Sent Frame Queue                                                                                   | 7.2.1            | M             |                       |                |
| <b>FOP-P Variables</b>                                              |                                                                                                              |                  |               |                       |                |
| DLL-119                                                             | VE(S)                                                                                                        | 7.2.2 a)         | M             |                       |                |
| DLL-120                                                             | V(S)                                                                                                         | 7.2.2 b)         | M             |                       |                |
| DLL-121                                                             | VV(S)                                                                                                        | 7.2.2 c)         | M             |                       |                |
| DLL-122                                                             | N(R):                                                                                                        | 7.2.2 d)         | M             |                       |                |
| DLL-123                                                             | NN(R):                                                                                                       | 7.2.2 e)         | M             |                       |                |
| DLL-124                                                             | R(R):                                                                                                        | 7.2.2 f)         | M             |                       |                |
| DLL-125                                                             | RR(R):                                                                                                       | 7.2.2 g)         | M             |                       |                |
| DLL-126                                                             | NEED_PLCW/NEED_STATUS_REPORT                                                                                 | 7.2.2 h)         | M             |                       |                |
| DLL-127                                                             | SYNCH_TIMER                                                                                                  | 7.2.2 i)         | M             |                       |                |
| DLL-128                                                             | RESYNC                                                                                                       | 7.2.2 j)         | M             |                       |                |
| DLL-129                                                             | FOP-P General Procedures                                                                                     | 7.2.3.1          | M             |                       |                |
| DLL-130                                                             | Set V(R) persistent activity                                                                                 | 7.2.3.2          | M             |                       |                |
| DLL-131                                                             | Configure the SET V(R) persistent activity                                                                   | 7.2.3.2.1        | M             |                       |                |
| DLL-132                                                             | Execute the SET V(R) persistent activity                                                                     | 7.2.3.2.2        | M             |                       |                |
| DLL-133                                                             | FOP-P State Table                                                                                            | 7.2.3.3          | M             |                       |                |
| DLL-134                                                             | DATA SERVICES RECEIVING OPERATIONS                                                                           | 7.3              | M             |                       |                |
| DLL-135                                                             | FARM-P STATE TABLE                                                                                           | 7.3.1            | M             |                       |                |
| <b>INTERNAL FARM-P PARAMETERS</b>                                   |                                                                                                              |                  |               |                       |                |
| DLL-136                                                             | V(R):                                                                                                        | 7.3.2 a)         | M             |                       |                |
| DLL-137                                                             | R(S):                                                                                                        | 7.3.2 b)         | M             |                       |                |
| DLL-138                                                             | N(S):                                                                                                        | 7.3.2 c)         | M             |                       |                |
| DLL-139                                                             | EXPEDITED_FRAME_COUNTER                                                                                      | 7.3.2 d)         | M             |                       |                |
| DLL-140                                                             | INTERFACE TO THE I/O SUBLAYER                                                                                | 7.3.3            | M             |                       |                |

| <b>Input/Output (I/O) Sublayer Operations</b> |                      |                  |               |                       |                |
|-----------------------------------------------|----------------------|------------------|---------------|-----------------------|----------------|
| <b>Item</b>                                   | <b>Description</b>   | <b>Reference</b> | <b>Status</b> | <b>Values Allowed</b> | <b>Support</b> |
| DLL-141                                       | Sending Operations   | 8.2              | M             |                       |                |
| DLL-142                                       | Receiving Operations | 8.3              | M             |                       |                |

CCSDS RECOMMENDED STANDARD FOR PROXIMITY-1 SPACE DATA LINK PROTOCOL

| <b>Variable-length Supervisory Protocol Data Field Formats</b> |                                          |                  |               |                       |                |
|----------------------------------------------------------------|------------------------------------------|------------------|---------------|-----------------------|----------------|
| <b>Item</b>                                                    | <b>Description</b>                       | <b>Reference</b> | <b>Status</b> | <b>Values Allowed</b> | <b>Support</b> |
| DLL-143                                                        | SET TRANSMITTER<br>PARAMETERS Directive  | B1.2             | M             |                       |                |
| DLL-144                                                        | SET CONTROL<br>PARAMETERS Directive      | B1.3             | M             |                       |                |
| DLL-145                                                        | SET RECEIVER<br>PARAMETERS Directive     | B1.4             | M             |                       |                |
| DLL-146                                                        | SET V(R) Directive                       | B1.5             | M             |                       |                |
| DLL-147                                                        | REPORT REQUEST Directive                 | B1.6             | O             |                       |                |
| DLL-148                                                        | SET PL EXTENSIONS<br>Directive           | B1.7             | M             |                       |                |
| DLL-149                                                        | REPORT SOURCE<br>SPACECRAFT ID Directive | B1.8             | O             |                       |                |

CCSDS RECOMMENDED STANDARD FOR PROXIMITY-1 SPACE DATA LINK PROTOCOL

| <b>Management Information Base (MIB) Parameters (alphabetical)</b> |                             |                       |               |                       |                |
|--------------------------------------------------------------------|-----------------------------|-----------------------|---------------|-----------------------|----------------|
| <b>Item</b>                                                        | <b>Description</b>          | <b>Reference</b>      | <b>Status</b> | <b>Values Allowed</b> | <b>Support</b> |
| DLL-150                                                            | Acquisition_Idle_Duration   | 6.2.4.4               | M             |                       |                |
| DLL-151                                                            | Carrier_Loss_Timer_Duration | 6.2.4.6               | M             |                       |                |
| DLL-152                                                            | Carrier_Only_Duration       | 6.2.4.3               | M             |                       |                |
| DLL-153                                                            | Comm_Change_Lifetime        | 6.2.4.10              | M             |                       |                |
| DLL-154                                                            | Comm_Change_Notification    | 6.2.4.9               | M             |                       |                |
| DLL-155                                                            | Comm_Change_Response        | 6.2.4.8               | M             |                       |                |
| DLL-156                                                            | Comm_Change_Waiting_Period  | 6.2.4.7               | M             |                       |                |
| DLL-157                                                            | Hail_Lifetime               | 6.2.4.14              | M             |                       |                |
| DLL-158                                                            | Hail_Notification           | 6.2.4.13              | M             |                       |                |
| DLL-159                                                            | Hail_Response               | 6.2.4.12              | M             |                       |                |
| DLL-160                                                            | Hail_Wait_Duration          | 6.2.4.11              | M             |                       |                |
| DLL-161                                                            | Hailing_Channel             | 6.2.4.15              | M             |                       |                |
| DLL-162                                                            | Hailing_Data_Rate           | 6.2.4.16              | M             |                       |                |
| DLL-163                                                            | Interval_Clock              | 6.3.1.1.1             | M             |                       |                |
| DLL-164                                                            | Local_PCID                  | 3.2.2.7               | M             |                       |                |
| DLL-165                                                            | Local_Spacecraft_ID         | 3.2.2.9.3             | M             |                       |                |
| DLL-166                                                            | Maximum_Failed-Token_Passes | 6.4.3,<br>Table 6-10  | O             |                       |                |
| DLL-167                                                            | Maximum_Frame_Length        | 3.2.3.1               | M             |                       |                |
| DLL-168                                                            | Maximum_Packet_Size         | 4.4.1.1               | M             |                       |                |
| DLL-169                                                            | Persistence_Wait_Time       | 6.4.2,<br>Table 6-8   | M             |                       |                |
| DLL-170                                                            | PLCW_Repeat_Interval        | 6.2.4.19              | M             |                       |                |
| DLL-171                                                            | Receive_Duration            | 6.2.4.18              | O             |                       |                |
| DLL-172                                                            | Drop_Carrier_Duration       | 6.2.1,<br>Table 6-2   | M             |                       |                |
| DLL-173                                                            | Remote_PCID                 | 3.2.2.7               | M             |                       |                |
| DLL-174                                                            | Remote_Spacecraft_ID        | 3.2.2.9.3             | M             |                       |                |
| DLL-175                                                            | Resync_Local                | 7.2.3.2.1,7.<br>2.3.3 | M             |                       |                |
| DLL-176                                                            | Resync_Lifetime             | 7.2.3.2               | M             |                       |                |
| DLL-177                                                            | Resync_Notification         | 7.2.3.2               | M             |                       |                |
| DLL-178                                                            | Resync_Response             | 7.2.3.2               | M             |                       |                |
| DLL-179                                                            | Resync_Waiting_Period       | 7.2.3.2               | M             |                       |                |
| DLL-180                                                            | Send_Duration               | 6.2.4.17              | O             |                       |                |
| DLL-181                                                            | Source_Destination_ID       | 3.2.2.9               | M             |                       |                |
| DLL-182                                                            | Synch_Timeout               | 7.2.2                 | M             |                       |                |
| DLL-183                                                            | Tail_Idle_Duration          | 6.2.4.5               | M             |                       |                |
| DLL-184                                                            | Test_Source                 | 6.2.4.2               | M             |                       |                |
| DLL-185                                                            | Transmission_Window         | 7.2.3.3               | M             |                       |                |



CCSDS RECOMMENDED STANDARD FOR PROXIMITY-1 SPACE DATA LINK PROTOCOL

| <b>Notifications to Vehicle Controller</b> |                                                                |                  |               |                       |                |
|--------------------------------------------|----------------------------------------------------------------|------------------|---------------|-----------------------|----------------|
| <b>Item</b>                                | <b>Description</b>                                             | <b>Reference</b> | <b>Status</b> | <b>Values Allowed</b> | <b>Support</b> |
| DLL-186                                    | 1 RESULT OF PERSISTENT ACTIVITY                                | Annex D #1       | M             |                       |                |
| DLL-187                                    | 2 STATE CONTROL STATUS                                         | Annex D #2       | M             |                       |                |
| DLL-188                                    | 3 INVALID FRAME SOURCE                                         | Annex D #3       | M             |                       |                |
| DLL-189                                    | 4 TIMING SERVICES INSTANCE                                     | Annex D #4       | M             |                       |                |
| DLL-190                                    | 5 NO CARRIER RECEIVED - HALF DUPLEX                            | Annex D #5       | O             |                       |                |
| DLL-191                                    | 6 NO DATA TRANSFERRED - HALF DUPLEX                            | Annex D #6       | O             |                       |                |
| DLL-192                                    | 7 SENDER EXCEEDED PRESCRIBED TRANSMISSION PERIOD - HALF DUPLEX | Annex D #7       | O             |                       |                |
| DLL-193                                    | 8 COP-P LOSS OF SYNCHRONIZATION                                | Annex D #8       | M             |                       |                |
| DLL-194                                    | 9 CARRIER_LOSS_TIMER UNDERFLOWS                                | Annex D #9       | M             |                       |                |
| DLL-195                                    | 10 END OF SESSION(# octets received)                           | Annex D #10      | M             |                       |                |
| DLL-196                                    | 11 CARRIER ONLY RECEIVED                                       | Annex D #11      | M             |                       |                |

## ANNEX B

### VARIABLE-LENGTH SUPERVISORY PROTOCOL DATA FIELD FORMATS

#### (NORMATIVE)

#### NOTES

- 1 Table 3-6 should be consulted for a complete overview of the variable-length SPDU structure including the SPDU header and SPDU data field. This annex specifies the format of the data field only.
- 2 The Directive Type field is defined from bits 13 through 15, inclusive, in order to maintain backward compatibility with the NASA Mars Surveyor Project 2001 Odyssey orbiter.

#### **B1 SPDU TYPE 1: DIRECTIVE/REPORT/PLCW SPDU DATA FIELD**

##### **B1.1 GENERAL**

**B1.1.1** The Directive/Report/PLCW SPDU shall be used for space link supervisory configuration and control of the transceiver and its operation.

**B1.1.2** The SPDU data field shall be a container that can hold up to seven sixteen-bit discrete self-delimiting and self-identifying directives:

- a) each directive shall have a specific functionality;
- b) each directive shall be sixteen bits in length and shall be self identified by the value in the Directive Type field (contained in bits 13, 14, and 15 of the directive);
- c) the directives shall be concatenated without intervening bits within the data field.

NOTE – Figure B-1 shows the Type 1 SPDU Data Field Contents.

CCSDS RECOMMENDED STANDARD FOR PROXIMITY-1 SPACE DATA LINK PROTOCOL

|                                                                |                |                                   |                   |                           |                     |                          |  |                          |               | Directive Type<br>3 bits (13,14,15) |
|----------------------------------------------------------------|----------------|-----------------------------------|-------------------|---------------------------|---------------------|--------------------------|--|--------------------------|---------------|-------------------------------------|
| Mode (0,1,2)                                                   |                | Data Rate (3,4,5,6)               |                   | Modulation (7)            |                     | Data Encoding (8,9)      |  | Frequency (10,11,12)     |               | '000' = SET TRANSMITTER PARAMETERS  |
| Time Sample (0,1,2,3,4,5)                                      |                | Duplex (6,7,8)                    |                   | Reserved (9,10)           |                     | Remote No More Data (11) |  | Token (12)               |               | '001' = SET CONTROL PARAMETERS      |
| Mode (0,1,2)                                                   |                | Data Rate (3,4,5,6)               |                   | Modulation (7)            |                     | Data Decoding (8,9)      |  | Frequency (10,11,12)     |               | '010' = SET RECEIVER PARAMETERS     |
| Receiver Frame Sequence Number (SEQ_CTRL_FSN)(0,1,2,3,4,5,6,7) |                |                                   |                   |                           |                     | Reserved (8,9,10,11,12)  |  |                          |               | '011' = Set V(R)                    |
| Reserved (0,1,2)                                               |                | Status Report Request (3,4,5,6,7) |                   | Time-Tag Request (8,9,10) |                     | PCID 0 PLCW Request (11) |  | PCID 1 PLCW Request (12) |               | '100' = Report Request              |
|                                                                |                |                                   |                   |                           |                     |                          |  |                          |               | '101' = Reserved                    |
| Direction (0)                                                  | Freq Table (1) | Rate Table (2)                    | Carrier Mod (3,4) | Data Mod (5,6)            | Mode Select (7,8)   | scrambler (9,10)         |  | Diff. Encoding (11)      | R-S Code (12) | '110' = SET PL EXTENSIONS           |
| Source Spacecraft ID (0,1,2,3,4,5,6,7,8,9)                     |                |                                   |                   |                           | Reserved (10,11,12) |                          |  |                          |               | '111' = Report Source SCID          |

Figure B-1: Type 1 SPDU Data Field Contents

## B1.2 SET TRANSMITTER PARAMETERS DIRECTIVE

### B1.2.1 General

The SET TRANSMITTER PARAMETERS directive shall consist of six fields, positioned contiguously in the following sequence (described from least significant bit, Bit 15, to most significant bit, Bit 0):

- a) Directive Type (3 bits);
- b) Transmitter Frequency (3 bits);
- c) Transmitter Data Encoding (2 bits);
- d) Transmitter Modulation (1 bit);
- e) Transmitter Data Rate (4 bits);
- f) Transmitter (TX) Mode (3 bits).

NOTE – The structural components of the SET TRANSMITTER PARAMETERS directive are shown in figure B-2.

|                   |                        |                        |                            |                        |                          |
|-------------------|------------------------|------------------------|----------------------------|------------------------|--------------------------|
| Bit 0             |                        |                        |                            |                        | Bit 15                   |
| TX Mode<br>3 bits | TX Data Rate<br>4 bits | TX Modulation<br>1 bit | TX Data Encoding<br>2 bits | TX Frequency<br>3 bits | Directive Type<br>3 bits |
| 0,1,2             | 3,4,5,6                | 7                      | 8,9                        | 10,11,12               | 13,14,15                 |

**Figure B-2: SET TRANSMITTER PARAMETERS Directive**

## B1.2.2 Directive Type

**B1.2.2.1** Bits 13–15 of the SET TRANSMITTER PARAMETERS directive shall contain the Directive Type.

**B1.2.2.2** The 3-bit Directive Type field identifies the type of protocol control directive and shall contain the binary value ‘000’ for the SET TRANSMITTER PARAMETERS directive.

## B1.2.3 Transmitter Frequency

### B1.2.3.1 General

Bits 10–12 of the SET TRANSMITTER PARAMETERS directive shall be used to set the transmitter frequency of the partnered transceiver to the desired value.

### B1.2.3.2 Return Transmitter Frequency (e.g., Orbiter as Initiator; Landed Asset as Responder)

In the context of the forward link, this 3-bit field shall define the transmit frequency of the responder. Actual frequency assignments are given in the Physical Layer (see reference [6]).

|       |       |       |       |       |       |       |       |
|-------|-------|-------|-------|-------|-------|-------|-------|
| ‘000’ | ‘001’ | ‘010’ | ‘011’ | ‘100’ | ‘101’ | ‘110’ | ‘111’ |
| Ch0R  | Ch1R  | Ch2R  | Ch3R  | Ch4R  | Ch5R  | Ch6R  | Ch7R  |

## B1.2.4 Transmitter Data Encoding

Bits 8–9 of the SET TRANSMITTER PARAMETERS directive shall contain the following coding options:

- a) ‘00’ = LDPC(2048,1024) rate 1/2 code (see reference [2]);
- b) ‘01’ = Convolutional Code(7,1/2) (G2 vector inverted) with attached CRC-32 (see reference [5]);

CCSDS RECOMMENDED STANDARD FOR PROXIMITY-1 SPACE DATA LINK PROTOCOL

- c) '10' = Bypass all codes;
- d) '11' = Concatenated (R-S(204,188), CC(7,1/2)) Codes.

NOTE – R-S(204,188) with CC(7,1/2) code is an ETSI standard. This option is not required for cross support. (See reference [H1] for more details.)

### B1.2.5 Transmitter Modulation

Bit 7 of the SET TRANSMITTER PARAMETERS directive shall contain the transmission modulation options:

- a) '0' = Coherent frequency PSK;
- b) '1' = Non-coherent frequency PSK.

### B1.2.6 Transmitter Data Rate

**B1.2.6.1** Bits 3–6 of the SET TRANSMITTER PARAMETERS directive shall contain one of the following transmission data rates (rates in kb/s, e.g., 4 = 4000 b/s) prior to encoding.

NOTE – Because of the NASA Mars Surveyor Project 2001 Odyssey implementation, there is an added constraint on the use of the values in the Data Rate field for 8, 32, 128, 256 kb/s. Data rate selection is linked to the modulation field value as shown in the tables below. NC indicates non-coherent PSK, and C indicates coherent PSK. R1 through R4 indicate the field is reserved for future definition by the CCSDS. 1, 512, 1024, and 2048 kb/s data rates can only be selected using the SET PL EXTENSIONS directive (see B1.7).

#### B1.2.6.2 Ordered by Data Rate:

|        |        |        |        |        |        |        |        |        |        |        |        |        |        |        |        |
|--------|--------|--------|--------|--------|--------|--------|--------|--------|--------|--------|--------|--------|--------|--------|--------|
| '1000' | '1001' | '0000' | '0001' | '1100' | '0010' | '0011' | '1101' | '0100' | '0101' | '0110' | '0111' | '1010' | '1011' | '1110' | '1111' |
| 2      | 4      | 8 NC   | 8 C    | 16     | 32 NC  | 32 C   | 64     | 128 NC | 128 C  | 256 NC | 256 C  | R1     | R2     | R3     | R4     |

CCSDS RECOMMENDED STANDARD FOR PROXIMITY-1 SPACE DATA LINK PROTOCOL

**B1.2.6.3** Ordered by Bit pattern:

|        |        |        |        |        |        |        |        |        |        |        |        |        |        |        |        |
|--------|--------|--------|--------|--------|--------|--------|--------|--------|--------|--------|--------|--------|--------|--------|--------|
| '0000' | '0001' | '0010' | '0011' | '0100' | '0101' | '0110' | '0111' | '1000' | '1001' | '1010' | '1011' | '1100' | '1101' | '1110' | '1111' |
| 8 NC   | 8 C    | 32 NC  | 32 C   | 128 NC | 128 C  | 256 NC | 256 C  | 2      | 4      | R1     | R2     | 16     | 64     | R3     | R4     |

**B1.2.6.4** Proximity-1 coded symbol ( $R_{cs}$ ) and data rate ( $R_d$ ) table:

| Prox-1 Coded<br>Symbol Rates<br>( $R_{cs}$ ) | Prox-1 Uncoded<br>Data Rates ( $R_d$ )<br>$R_d = R_{cs}$ | Prox-1 Convolutionally<br>Coded Data Rates ( $R_d$ )<br>$R_d = .5 * R_{cs}$ | Prox-1 LDPC computed<br>data rates ( $R_d$ )<br>$R_d = .48484 * R_{cs}$ |
|----------------------------------------------|----------------------------------------------------------|-----------------------------------------------------------------------------|-------------------------------------------------------------------------|
| 1000                                         | 1000                                                     | N/A                                                                         | N/A                                                                     |
| 2000                                         | 2000                                                     | 1000                                                                        | 969.6969697                                                             |
| 4000                                         | 4000                                                     | 2000                                                                        | 1939.393939                                                             |
| 8000                                         | 8000                                                     | 4000                                                                        | 3878.787879                                                             |
| 16000                                        | 16000                                                    | 8000                                                                        | 7757.575758                                                             |
| 32000                                        | 32000                                                    | 16000                                                                       | 15515.15152                                                             |
| 64000                                        | 64000                                                    | 32000                                                                       | 31030.30303                                                             |
| 128000                                       | 128000                                                   | 64000                                                                       | 62060.60606                                                             |
| 256000                                       | 256000                                                   | 128000                                                                      | 124121.2121                                                             |
| 512000                                       | 512000                                                   | 256000                                                                      | 248242.4242                                                             |
| 1024000                                      | 1024000                                                  | 512000                                                                      | 496484.8485                                                             |
| 2048000                                      | 2048000                                                  | 1024000                                                                     | 992969.697                                                              |
| 4096000                                      | N/A                                                      | 2048000                                                                     | 1985939.394                                                             |

**B1.2.6.5** 1, 512, 1024, and 2048 kb/s data rates can only be selected using the SET PL EXTENSIONS directive (see B1.7).

**B1.2.7 Transmitter Mode**

Bits 0–2 of the SET TRANSMITTER PARAMETERS directive shall contain the Transmitter Mode options. This field identifies the operating mode of the transmitter:

- a) '000' = Mission Specific;
- b) '001' = Proximity-1 Protocol;
- c) '010' = Mission Specific;
- d) '011' = Mission Specific;
- e) '100' = Mission Specific;

CCSDS RECOMMENDED STANDARD FOR PROXIMITY-1 SPACE DATA LINK PROTOCOL

- f) '101' = Mission Specific;
- g) '110' = Reserved by CCSDS;
- h) '111' = Reserved by CCSDS.

NOTE – Annex F should be consulted for NASA Mars Survey Project 2001 Odyssey Orbiter Transmitter Mode mission-specific values.

### B1.3 SET CONTROL PARAMETERS

#### B1.3.1 General

**B1.3.1.1** The SET CONTROL PARAMETERS directive shall consist of six fields, positioned contiguously in the following sequence (described from least significant bit, Bit 15, to most significant bit, Bit 0):

- a) Directive Type (3 bits);
- b) Token (1 bit);
- c) Remote No More Data (1 bit);
- d) Reserved (2 bits);
- e) Duplex (3 bits);
- f) Time Sample (6 bits).

**B1.3.1.2** This directive is used to set from zero to four control parameters at a time: 1) setting the token for half-duplex operations; 2) setting the Remote No More Data condition for session termination in full or half duplex; 3) setting the Duplex parameter; 4) setting the number of time samples to be taken during timing services.

NOTE – The structural components of the SET CONTROL PARAMETERS directive are shown in figure B-3.

|                       |                  |                    |                                 |                |                          |
|-----------------------|------------------|--------------------|---------------------------------|----------------|--------------------------|
| Bit 0                 |                  |                    | Bit 15                          |                |                          |
| Time Sample<br>6 bits | Duplex<br>3 bits | Reserved<br>2 bits | Remote No<br>More Data<br>1 bit | Token<br>1 bit | Directive Type<br>3 bits |
| 0,1,2,3,4,5           | 6,7,8            | 9,10               | 11                              | 12             | 13,14,15                 |

**Figure B-3: SET CONTROL PARAMETERS Directive**

### **B1.3.2 Directive Type**

**B1.3.2.1** Bits 13–15 of the SET CONTROL PARAMETERS directive shall contain the Directive Type.

**B1.3.2.2** The 3-bit Directive Type field identifies the type of protocol control directive and shall contain the binary value ‘001’ to identify the SET CONTROL PARAMETERS directive.

### **B1.3.3 Token**

Bit 12 of the SET CONTROL PARAMETERS directive shall contain the value of the Token field as follows:

- a) ‘0’ = No Change;
- b) ‘1’ = Transmit.

NOTE – This field either notifies the remote node that there is no change in who has permission to transmit (i.e., ignore this field) or commands the remote node to the transmit state.

### **B1.3.4 Remote No More Data**

Bit 11 of the SET CONTROL PARAMETERS directive shall contain the Remote No More Data field as follows:

- a) ‘0’ = No Change;
- b) ‘1’ = Remote Node has No More Data to Send (RNMD).

NOTE – This field either notifies the recipient node that there is no change in the remote node’s data state (i.e., ignore this field) or notifies the recipient node that the remote node has no more data to send, in which case the session may be terminated when the recipient node locally has no more data to send.

### **B1.3.5 Reserved**

Bits 9-10 of the SET CONTROL PARAMETERS directive shall contain spares and be set to ‘all zero’.

### **B1.3.6 Duplex**

Bits 6-8 of the SET CONTROL PARAMETERS directive shall contain the Duplex field as follows:

- a) ‘000’ = No Change;



CCSDS RECOMMENDED STANDARD FOR PROXIMITY-1 SPACE DATA LINK PROTOCOL

- b) '001' = Full Duplex;
- c) '010' = Half Duplex;
- d) '011' = Simplex Transmit;
- e) '100' = Simplex Receive;
- f) '101' = Reserved;
- g) '110' = Reserved;
- h) '111' = Reserved.

NOTE – This field either notifies the recipient node that there is no change in the remote node's Duplex state (i.e., ignore this field) or notifies the recipient node to change the directionality of communication accordingly.

### B1.3.7 Time Sample

Bits 0-5 of the SET CONTROL PARAMETERS directive shall contain the Time Sample field. When this field is non-zero, it notifies the recipient to capture the time and frame sequence number (associated with the Proximity timing service, see section 5) for the next  $n$  frames received, where  $n$  is the number of Proximity transfer frames contained within the Time Sample Field.

## B1.4 SET RECEIVER PARAMETERS DIRECTIVE

### B1.4.1 General

The SET RECEIVER PARAMETERS directive shall consist of six fields, positioned contiguously in the following sequence (described from least significant bit, Bit 15, to most significant bit, Bit 0):

- a) Directive Type (3 bits);
- b) Receiver Frequency (3 bits);
- c) Receiver Data Decoding (2 bits);
- d) Receiver Modulation (1 bit);
- e) Receiver Data Rate (4 bits);
- f) Receiver (RX) Mode (3 bits).

NOTE – The structural components of the SET RECEIVER PARAMETERS directive are shown in figure B-4.

|                      |                      |                           |                               |                           |                          |        |
|----------------------|----------------------|---------------------------|-------------------------------|---------------------------|--------------------------|--------|
| Bit 0                |                      |                           |                               |                           |                          | Bit 15 |
| RX<br>Mode<br>3 bits | RX<br>Rate<br>4 bits | RX<br>Modulation<br>1 bit | RX<br>Data Decoding<br>2 bits | RX<br>Frequency<br>3 bits | Directive Type<br>3 bits |        |
| 0,1,2                | 3,4,5,6              | 7                         | 8,9                           | 10,11,12                  | 13,14,15                 |        |

**Figure B-4: SET RECEIVER PARAMETERS Directive**

## B1.4.2 Directive Type

**B1.4.2.1** Bits 13–15 of the SET RECEIVER PARAMETERS directive shall contain the Directive Type.

**B1.4.2.2** The 3-bit Directive Type field identifies the type of protocol control directive and shall contain the binary value ‘010’ for the SET RECEIVER PARAMETERS directive.

## B1.4.3 Receiver Frequency

### B1.4.3.1 General

Bits 10–12 of the SET RECEIVER PARAMETERS directive shall be used to set the receiver frequency of the partnered transceiver to the desired value.

### B1.4.3.2 Forward Receive Frequency (e.g., Orbiter as Initiator; Landed Asset as Responder)

In the context of the forward link, this 3-bit field shall define the receive frequency of the responder. Actual frequency assignments are given in the Physical Layer (see reference [6]).

|       |       |       |       |       |       |       |       |
|-------|-------|-------|-------|-------|-------|-------|-------|
| ‘000’ | ‘001’ | ‘010’ | ‘011’ | ‘100’ | ‘101’ | ‘110’ | ‘111’ |
| Ch0F  | Ch1F  | Ch2F  | Ch3F  | Ch4F  | Ch5F  | Ch6F  | Ch7F  |

## B1.4.4 Receiver Data Decoding

Bits 8–9 of the SET RECEIVER PARAMETERS directive shall contain the following coding options:

‘00’ = LDPC (2048,1024) rate 1/2 code (see reference [2]);

‘01’ = Convolutional Code(7,1/2) (G2 vector inverted) with attached CRC-32 (see reference [5]);

‘10’ = Bypass all codes;

CCSDS RECOMMENDED STANDARD FOR PROXIMITY-1 SPACE DATA LINK PROTOCOL

‘11’ = Concatenated R-S(204,188), CC(7,1/2).

NOTE – R-S(204,188) with CC(7,1/2) code is an ETSI standard. This option is not required for cross support. (See reference [H1] for more details.)

**B1.4.5 Receiver Modulation**

Bit 7 of the SET RECEIVER PARAMETERS directive shall contain the following transmission modulation options:

- a) ‘0’ = Coherent frequency PSK;
- b) ‘1’ = Non-coherent frequency PSK.

**B1.4.6 Receiver Data Rate**

**B1.4.6.1** Bits 3–6 of the SET RECEIVER PARAMETERS directive shall contain one of the following receiver data rates (rates in kb/s, e.g., 4 = 4000 b/s) after decoding.

NOTE – Because of the NASA Mars Surveyor Project 2001 Odyssey implementation, there is an added constraint on the use of the values in the Data Rate field for 8, 32, 128, and 256 kb/s. Data rate selection is linked to the modulation field value as shown in the tables below (‘NC’ indicates non-coherent, and c indicates coherent). R1 through R4 indicates the field is reserved for future definition by the CCSDS. 1, 512, 1024, and 2048 kb/s data rates can only be selected using the SET PL EXTENSIONS directive (see B1.7).

**B1.4.6.2** Ordered by Data Rate:

|        |        |        |        |        |        |        |        |        |        |        |        |        |        |        |        |
|--------|--------|--------|--------|--------|--------|--------|--------|--------|--------|--------|--------|--------|--------|--------|--------|
| ‘1000’ | ‘1001’ | ‘0000’ | ‘0001’ | ‘1100’ | ‘0010’ | ‘0011’ | ‘1101’ | ‘0100’ | ‘0101’ | ‘0110’ | ‘0111’ | ‘1010’ | ‘1011’ | ‘1110’ | ‘1111’ |
| 2      | 4      | 8 NC   | 8 C    | 16     | 32 NC  | 32 C   | 64     | 128 NC | 128 C  | 256 NC | 256 C  | R1     | R2     | R3     | R4     |

**B1.4.6.3** Ordered by Bit pattern:

|        |        |        |        |        |        |        |        |        |        |        |        |        |        |        |        |
|--------|--------|--------|--------|--------|--------|--------|--------|--------|--------|--------|--------|--------|--------|--------|--------|
| ‘0000’ | ‘0001’ | ‘0010’ | ‘0011’ | ‘0100’ | ‘0101’ | ‘0110’ | ‘0111’ | ‘1000’ | ‘1001’ | ‘1010’ | ‘1011’ | ‘1100’ | ‘1101’ | ‘1110’ | ‘1111’ |
| 8 NC   | 8 C    | 32 NC  | 32 C   | 128 NC | 128 C  | 256 NC | 256 C  | 2      | 4      | R1     | R2     | 16     | 64     | R3     | R4     |

CCSDS RECOMMENDED STANDARD FOR PROXIMITY-1 SPACE DATA LINK PROTOCOL

**B1.4.6.4** Proximity-1 coded symbol ( $R_{cs}$ ) and data rate ( $R_d$ ) table:

| Prox-1 Coded<br>Symbol Rates<br>( $R_{cs}$ ) | Prox-1 Uncoded<br>Data Rates ( $R_d$ )<br>$R_d = R_{cs}$ | Prox-1 Convolutionally<br>Coded Data Rates ( $R_d$ )<br>$R_d = .5 * R_{cs}$ | Prox-1 LDPC Computed<br>Data Rates ( $R_d$ )<br>$R_d = .48484 * R_{cs}$ |
|----------------------------------------------|----------------------------------------------------------|-----------------------------------------------------------------------------|-------------------------------------------------------------------------|
| 1000                                         | 1000                                                     | N/A                                                                         | N/A                                                                     |
| 2000                                         | 2000                                                     | 1000                                                                        | 969.6969697                                                             |
| 4000                                         | 4000                                                     | 2000                                                                        | 1939.393939                                                             |
| 8000                                         | 8000                                                     | 4000                                                                        | 3878.787879                                                             |
| 16000                                        | 16000                                                    | 8000                                                                        | 7757.575758                                                             |
| 32000                                        | 32000                                                    | 16000                                                                       | 15515.15152                                                             |
| 64000                                        | 64000                                                    | 32000                                                                       | 31030.30303                                                             |
| 128000                                       | 128000                                                   | 64000                                                                       | 62060.60606                                                             |
| 256000                                       | 256000                                                   | 128000                                                                      | 124121.2121                                                             |
| 512000                                       | 512000                                                   | 256000                                                                      | 248242.4242                                                             |
| 1024000                                      | 1024000                                                  | 512000                                                                      | 496484.8485                                                             |
| 2048000                                      | 2048000                                                  | 1024000                                                                     | 992969.697                                                              |
| 4096000                                      | N/A                                                      | 2048000                                                                     | 1985939.394                                                             |

NOTE – 1, 512, 1024, and 2048 kb/s data rates can only be selected using the SET PL EXTENSIONS directive (see B1.7).

**B1.4.7 Receiver Mode**

Bits 0–2 of the SET RECEIVER PARAMETERS directive shall contain the receiver mode options. This field identifies the operating mode of the receiver:

- a) '000' = Mission Specific;
- b) '001' = Proximity-1 Protocol;
- c) '010' = Mission Specific;
- d) '011' = Mission Specific;
- e) '100' = Mission Specific;
- f) '101' = Mission Specific;
- g) '110' = Reserved by CCSDS;
- h) '111' = Reserved by CCSDS.

NOTE – Annex F should be consulted for NASA Mars Survey Project 2001 Odyssey Orbiter Receiver Mode mission-specific values.

## B1.5 SET V(R) DIRECTIVE

### B1.5.1 General

The SET V(R) directive shall consist of three fields, positioned contiguously in the following sequence (described from least significant bit, Bit 15, to most significant bit, Bit 0):

- a) Directive Type (3 bits);
- b) Spare (5 bits);
- c) Receiver Frame Sequence Number (SEQ\_CTRL\_FSN) (8 bits).

NOTE – The structural components of the SET V(R) directive are shown in figure B-5.

| Bit 0                                                    |                 | Bit 15                   |
|----------------------------------------------------------|-----------------|--------------------------|
| Receiver Frame Sequence Number<br>SEQ_CTRL_FSN<br>8 bits | Spare<br>5 bits | Directive Type<br>3 bits |
| 0,1,2,3,4,5,6,7                                          | 8,9,10,11,12    | 13,14,15                 |

Figure B-5: SET V(R) Directive

### B1.5.2 Directive Type

**B1.5.2.1** Bits 13–15 of the SET V(R) directive shall contain the Directive Type.

**B1.5.2.2** The 3-bit Directive Type field identifies the type of protocol control directive and shall contain the binary value ‘011’ to identify the SET V(R) directive.

### B1.5.3 Spare

Bits 8–12 of the SET V(R) directive shall contain spare bits, set to ‘all zero’.

### B1.5.4 Receiver Frame Sequence Number

Bits 0–7 of the SET V(R) directive shall contain the value of the Frame Sequence Number (SEQ\_CTRL\_FSN) to which the receiving unit of the partnered transceiver is to be set.

## B1.6 REPORT REQUEST DIRECTIVE

### B1.6.1 General

The REPORT REQUEST directive is the mechanism by which either (1) a status report, (2) a time-tag, or (3) a PLCW per PCID can be requested of a Proximity-1 node. It shall consist of seven fields, positioned contiguously in the following sequence (described from least significant bit, Bit 15, to most significant bit, Bit 0):

- a) Directive Type (3 bits);
- b) PCID 1 PLCW Request (1 bit);
- c) PCID 0 PLCW Request (1 bit);
- d) Time-Tag Request (3 bits);
- e) Status Request (5 bits);
- f) Spare (3 bits).

NOTE – The structural components of the REPORT REQUEST directive are shown in figure B-6.

| Bit 0  |                       |                  | Bit 15              |                     |                |
|--------|-----------------------|------------------|---------------------|---------------------|----------------|
| Spare  | Status Report Request | Time-Tag Request | PCID 0 PLCW Request | PCID 1 PLCW Request | Directive Type |
| 3 bits | 5 bits                | 3 bit            | 1 bit               | 1 bit               | 3 bits         |
| 0,1,2  | 3,4,5,6,7             | 8,9,10           | 11                  | 12                  | 13,14,15       |

Figure B-6: Report Request

### B1.6.2 Directive Type

**B1.6.2.1** Bits 13–15 of the REPORT REQUEST directive shall contain the Directive Type.

**B1.6.2.2** The 3-bit Directive Type field identifies the type of protocol control directive and shall contain the binary value ‘100’.

### B1.6.3 Physical Channel ID 1 PLCW Report Request Field

Bit 12 of the REPORT REQUEST directive shall indicate whether a PLCW report for PCID 1 is required:

- a) ‘1’ = PLCW report is needed for PCID 1; transmit this report on the same PCID that the report request arrived on.

CCSDS RECOMMENDED STANDARD FOR PROXIMITY-1 SPACE DATA LINK PROTOCOL

- b) '0' = PLCW report is not required.

#### **B1.6.4 Physical Channel ID 0 PLCW Report Request Field**

Bit 11 of the REPORT REQUEST directive shall indicate whether a PLCW report for PCID 0 is required:

- a) '1' = PLCW report is needed for PCID 0; Transmit this report on the same PCID that the report request arrived on.
- b) '0' = PLCW report is not required.

#### **B1.6.5 Time-Tag Request Field**

Bits 8–10 of the directive, if set to a value other than '000', shall indicate a request to the remote transceiver to initiate a Proximity-1 time tag exchange (see section 5).

#### **B1.6.6 Status Report Request**

**B1.6.6.1** The value contained in bits 3–7 of the REPORT REQUEST directive shall indicate the type of status report desired.

**B1.6.6.2** If set to '00000', a status report is not required.

**B1.6.6.3** The types of status reports are reserved for CCSDS use.

#### **B1.6.7 Spares**

Bits 0–2 of the REPORT REQUEST directive shall contain spare bits set to 'all zero'.

### **B1.7 SET PL EXTENSIONS**

The SET PL EXTENSIONS directive is the mechanism by which additional Physical Layer parameters can be enabled or disabled. This directive is transferred across the Proximity link from the local transceiver to the remote transceiver. This directive is provided for compatibility between transceivers with extensions in addition to those discussed in this Proximity-1 Recommended Standard.

#### **B1.7.1 General**

The SET PL EXTENSIONS directive shall consist of ten fields, positioned contiguously in the following sequence (described from least significant bit, Bit 15, to most significant bit, Bit 0):

- a) Directive Type (3 bits);

CCSDS RECOMMENDED STANDARD FOR PROXIMITY-1 SPACE DATA LINK PROTOCOL

- b) R-S Code (1 bit);
- c) Differential Mark Encoding (1 bit);
- d) Scrambler (2 bits);
- e) Mode Select (2 bits);
- f) Data Modulation (2 bits);
- g) Carrier Modulation (2 bits);
- h) Rate Table (1 bit);
- i) Frequency Table (1 bit);
- j) Direction (1 bit).

NOTE – The structural components of the SET PL EXTENSIONS directive are shown in figure B-7.

| Bit 0     |            |            |             |          |             |           | Bit 15                     |          |                |
|-----------|------------|------------|-------------|----------|-------------|-----------|----------------------------|----------|----------------|
| Direction | Freq Table | Rate Table | Carrier MOD | Data MOD | Mode Select | Scrambler | Differential Mark Encoding | R-S Code | Directive Type |
| 1 bit     | 1 bit      | 1 bit      | 2 bits      | 2 bits   | 2 bits      | 2 bits    | 1 bit                      | 1 bit    | 3 bits         |
| (0)       | (1)        | (2)        | (3,4)       | (5,6)    | (7,8)       | (9,10)    | (11)                       | (12)     | 13,14,15       |

**Figure B-7: SET PL EXTENSIONS**

### B1.7.2 Directive Type

**B1.7.2.1** Bits 13–15 of the SET PL EXTENSIONS directive shall contain the Directive Type.

**B1.7.2.2** The 3-bit Directive Type field identifies the directive type and shall contain the binary value ‘110’.

### B1.7.3 Reed-Solomon Code

Bit 12 of the SET PL EXTENSIONS directive shall indicate which R-S Code is used:

- a) ‘0’ = R-S(204,188) code;
- b) ‘1’ = R-S(255,239) code.

Neither of these R-S Codes is specified by CCSDS in other Recommended Standards and therefore they are not required for cross-support.



#### **B1.7.4 Differential Mark Encoding**

Bit 11 of the SET PL EXTENSIONS directive shall indicate whether Differential Mark Encoding is enabled:

- a) '0' = No differential encoding;
- b) '1' = Differential encoding enabled. The current data bit is exclusive ORed with the previously transmitted bit to determine the value of the current transmitted bit. When the current data bit is a '1', then the current encoder output bit level changes relative to the previous output value. If the data bit is a '0', then the current encoder output bit level remains constant relative to the previous output value. (See table below.)

Option b) is not required for cross-support except for those missions required to interoperate with NASA MRO. (See annex G.)

#### **B1.7.5 Scrambler**

Bits 9-10 of the SET PL EXTENSIONS directive shall indicate if and what type of digital bit scrambling is used:

- a) '00' = Bypass all bit scrambling;
- b) '01' = CCITT bit scrambling enabled (see reference [H2]);
- c) '10' = Bypass all bit scrambling;
- d) '11' = IESS bit scrambling enabled (see reference [H3]).

None of these Scrambler options are specified by CCSDS in other Recommended Standards and therefore they are not required for cross-support.

#### **B1.7.6 Mode Select**

Bits 7-8 of the SET PL EXTENSIONS directive shall indicate the type of carrier suppression used:

- a) '00' = Suppressed Carrier (Requires transmit side utilize Modulation Index of 90° and transmit/receive sides utilize Differential Mark Encoding/Decoding);
- b) '01' = Residual Carrier;
- c) '10' = Reserved;
- d) '11' = Reserved.

Option a) is not required for cross-support except for those missions required to interoperate with NASA MRO. (See annex G.)

### B1.7.7 Data Modulation

Bits 5-6 of the SET PL EXTENSIONS directive shall indicate the type of data modulation used:

- a) '00' = NRZ-L;
- b) '01' = Bi-Phase-Level (Manchester);
- c) '10' = Reserved;
- d) '11' = Reserved.

Option a) is not required for cross-support except for those missions required to interoperate with NASA MRO. (See annex G.)

### B1.7.8 Carrier Modulation

Bits 3-4 of the SET PL EXTENSIONS directive shall indicate the type of carrier modulation to be used:

- a) '00' = No Modulation;
- b) '01' = PSK;
- c) '10' = FSK;
- d) '11' = QPSK.

Options c) and d) are not required for cross-support.

### B1.7.9 Rate Table

Bit 2 of the SET PL EXTENSIONS directive shall indicate which set of data rates prior to encoding shall be used.

- a) '0' = Default Set defined in the Data Rate Field of the SET TRANSMITTER PARAMETERS and SET RECEIVER PARAMETERS Directives in this annex;
- b) '1' = Extended Physical Layer Data Rate Set defined below.

|                   |                     |                      |                   |
|-------------------|---------------------|----------------------|-------------------|
| '0000' = 1000 b/s | '0100' = 16000 b/s  | '1000' = 256000 b/s  | '1100' = Reserved |
| '0001' = 2000 b/s | '0101' = 32000 b/s  | '1001' = 512000 b/s  | '1101' = Reserved |
| '0010' = 4000 b/s | '0110' = 64000 b/s  | '1010' = 1024000 b/s | '1110' = Reserved |
| '0011' = 8000 b/s | '0111' = 128000 b/s | '1011' = 2048000 b/s | '1111' = Reserved |

Option a) is required for cross-support. Option b) is required for cross-support for data rates less than 2000 b/s and greater than 256000 b/s.

CCSDS RECOMMENDED STANDARD FOR PROXIMITY-1 SPACE DATA LINK PROTOCOL

**B1.7.10 Proximity-1 coded symbol ( $R_{cs}$ ) and data rate ( $R_d$ ) table:**

| Prox-1 Coded<br>Symbol Rates<br>( $R_{cs}$ ) | Prox-1 Uncoded<br>Data Rates ( $R_d$ )<br>$R_d = R_{cs}$ | Prox-1 Convolutionally<br>Coded Data Rates ( $R_d$ )<br>$R_d = .5 * R_{cs}$ | Prox-1 LDPC Computed<br>Data Rates ( $R_d$ )<br>$R_d = .48484 * R_{cs}$ |
|----------------------------------------------|----------------------------------------------------------|-----------------------------------------------------------------------------|-------------------------------------------------------------------------|
| 1000                                         | 1000                                                     | N/A                                                                         | N/A                                                                     |
| 2000                                         | 2000                                                     | 1000                                                                        | 969.6969697                                                             |
| 4000                                         | 4000                                                     | 2000                                                                        | 1939.393939                                                             |
| 8000                                         | 8000                                                     | 4000                                                                        | 3878.787879                                                             |
| 16000                                        | 16000                                                    | 8000                                                                        | 7757.575758                                                             |
| 32000                                        | 32000                                                    | 16000                                                                       | 15515.15152                                                             |
| 64000                                        | 64000                                                    | 32000                                                                       | 31030.30303                                                             |
| 128000                                       | 128000                                                   | 64000                                                                       | 62060.60606                                                             |
| 256000                                       | 256000                                                   | 128000                                                                      | 124121.2121                                                             |
| 512000                                       | 512000                                                   | 256000                                                                      | 248242.4242                                                             |
| 1024000                                      | 1024000                                                  | 512000                                                                      | 496484.8485                                                             |
| 2048000                                      | 2048000                                                  | 1024000                                                                     | 992969.697                                                              |
| 4096000                                      | N/A                                                      | 2048000                                                                     | 1985939.394                                                             |

**B1.7.11 Frequency Table**

**B1.7.11.1 General**

Bit 1 of the SET PL EXTENSIONS directive shall indicate what set of frequencies is to be used:

- a) '0' = Channels 0 – 7 defined in the Frequency Field of the SET TRANSMITTER PARAMETERS and SET RECEIVER PARAMETERS Directives and specifically in the Proximity-1 Physical Layer;
- b) '1' = Channels 8 – 15 defined in the Extended Physical Layer Frequency Set defined below.

**B1.7.11.2 Forward Link (e.g., Orbiter as Initiator; Landed Asset as Responder)**

In the context of the forward link, this 3-bit field shall define the receive frequency of the responder. Actual frequency assignments are given in the Physical Layer (see reference [6]).

|       |       |       |       |       |       |       |       |
|-------|-------|-------|-------|-------|-------|-------|-------|
| '000' | '001' | '010' | '011' | '100' | '101' | '110' | '111' |
| Ch8F  | Ch9F  | Ch10F | Ch11F | Ch12F | Ch13F | Ch14F | Ch15F |

### B1.7.11.3 Return Link (e.g., Orbiter as Initiator; Landed Asset as Responder)

In the context of the return link, this 3-bit field shall define the transmit frequency of the responder. Actual frequency assignments are given in the Physical Layer (see reference [6]).

|       |       |       |       |       |       |       |       |
|-------|-------|-------|-------|-------|-------|-------|-------|
| '000' | '001' | '010' | '011' | '100' | '101' | '110' | '111' |
| Ch8R  | Ch9R  | Ch10R | Ch11R | Ch12R | Ch13R | Ch14R | Ch15R |

### B1.7.12 Direction

Bit 0 of the SET PL EXTENSIONS directive shall indicate if the fields in this directive apply to the transmit or receive side of the transceiver:

- a) '0' = transmit side;
- b) '1' = receive side.

## B1.8 REPORT SOURCE SPACECRAFT ID

### B1.8.1 General

The REPORT SOURCE SPACECRAFT ID is the mechanism by which the local transceiver can provide status of its source spacecraft ID to the remote transceiver across the Proximity link. It shall consist of three fields, positioned contiguously in the following sequence (described from least significant bit, Bit 15, to most significant bit, Bit 0):

- a) Directive Type (3 bits);
- b) Reserved (3 bits);
- c) Source Spacecraft ID (10 bits).

NOTE – The structural components of the REPORT SOURCE SPACECRAFT ID are shown in figure B-8.

|                                 |                                      |
|---------------------------------|--------------------------------------|
| Bit 0                           | Bit 15                               |
| Source Spacecraft ID<br>10 bits | Reserved<br>3 bits                   |
| 0,1,2,3,4,5,6,7,8,9             | 10,11,12                             |
|                                 | Directive Type<br>3 bits<br>13,14,15 |

**Figure B-8: Report Source Spacecraft ID**

## **B1.8.2 Directive Type**

**B1.8.2.1** Bits 13–15 of the REPORT SOURCE SPACECRAFT ID status report shall contain the Directive Type.

**B1.8.2.2** The 3-bit Directive Type field identifies the type of status report and shall contain the binary value ‘111’.

## **B1.8.3 Reserved**

Bits 10–12 of the REPORT SOURCE SPACECRAFT ID status report shall contain reserved bits, set to ‘all zero’.

## **B1.8.4 Source Spacecraft ID**

Bits 0-9 of the REPORT SOURCE SPACECRAFT ID status report shall contain the SCID of the source of the transfer frame.

## **B2 SPDU TYPE 2: TIME DISTRIBUTION SPDU DATA FIELD**

NOTE – Table 3-6 should be consulted for a complete overview of the variable-length SPDU structure including the SPDU header and SPDU data field.

### **B2.1 GENERAL**

**B2.1.1** The TIME DISTRIBUTION SPDU data field is the container that describes both the type and value of the time entity for distribution.

**B2.1.2** A single TIME DISTRIBUTION directive shall be contained within a TIME DISTRIBUTION SPDU.

**B2.1.3** The format of the TIME DISTRIBUTION SPDU data field shall consist of four fields, positioned contiguously, in the following sequence:

- a) TIME DISTRIBUTION Directive Type (1 octet);
- b) Transceiver Clock (8 octets);
- c) Send Side Delay (3 octets);
- d) One-Way-Light-Time (3 octets);

All time code fields in this directive shall comply with the CCSDS Unsegmented Time Code format (reference [4]).

NOTE – The structural components of the TIME DISTRIBUTION SPDU data field are shown in figure B-9.

|                   |                      |                    |                        |
|-------------------|----------------------|--------------------|------------------------|
| Octet 0           |                      |                    | Octet 14               |
| Directive<br>Type | Transceiver<br>Clock | Send Side<br>Delay | One-Way-<br>Light-Time |
| 1 Octet           | 8 Octets             | 3 Octets           | 3 Octets               |

**Figure B-9: Type 2 SPDU Data Field Contents**

## B2.2 TIME DISTRIBUTION DIRECTIVE TYPE

**B2.2.1** Octet 0 of the TIME DISTRIBUTION SPDU data field shall contain the TIME DISTRIBUTION Directive Type field indicating the function to be performed (if any) with the time contents.

**B2.2.2** TIME DISTRIBUTION Types are:

- a) '00000000' = NULL;
- b) '00000001' = TIME TRANSFER;
- c) all others = Reserved for CCSDS use.

## B2.3 TRANSCEIVER CLOCK

**B2.3.1** When the Time Distribution Type equals TIME TRANSFER,

- a) octet 1 through octet 8 shall contain the value of the clock corresponding to when the trailing edge of the last bit of the ASM of the transmitted PLTU crosses the clock capture point within the transceiver;
- b) this time code field shall be divided into 5 octets of coarse time and 3 octets of fine time. (See reference [4].)

**B2.3.2** Otherwise, this field shall contain reserved bits, set to 'all zero'.

## B2.4 SEND SIDE DELAY

**B2.4.1** When the Time Distribution Type equals TIME TRANSFER,

- a) octet 9 through octet 11 shall contain the delay time between the transceiver internal clock capture point and when the trailing edge of the last bit of the ASM of the transmitted PLTU crossed the time reference point (see section 5, 'Proximity-1 Timing Services');

- b) this time code field shall be divided into 1 octet of coarse time and 2 octets of fine time. (See reference [4].)

**B2.4.2** Otherwise, this field shall contain reserved bits, set to ‘all zero’.

## **B2.5 ONE WAY LIGHT TIME**

**B2.5.1** When the Time Distribution Type equals TIME TRANSFER, and when the mission has decided OWLT should be used,

- a) octet 12 through octet 14 shall contain the calculated one way light time between the instance that the trailing edge of the last bit of the ASM of the transmitted PLTU crosses the time reference point of the initiator node to the time reference point of the destination node;
- b) this time code field shall be divided into 1 octet of coarse time and 2 octets of fine time. (See reference [4].)

**B2.5.2** Otherwise, this field shall contain reserved bits, set to ‘all zero’.

## ANNEX C

### MANAGEMENT INFORMATION BASE PARAMETERS

#### (NORMATIVE)

This table lists each MIB parameter in the document along with how it is used and in what layer or sublayer it is used. Values for the Layer column are: P = Physical, C = C&S, F = Frame, M = MAC, D = Data Services, I = I/O. Parameter Definitions are provided where they are referenced in the specification.

| Parameter                   | Use                                                                                                                      | Layer |
|-----------------------------|--------------------------------------------------------------------------------------------------------------------------|-------|
| Acquisition_Idle_Duration   | Mandatory. Used in full-, half-duplex, and simplex session establishment and COMM_CHANGE. Session static. (See 6.2.4.4.) | P, M  |
| Carrier_Loss_Timer_Duration | Mandatory. Used in full- and half-duplex operations. Session static. (See 6.2.4.6.)                                      | D     |
| Carrier_Only_Duration       | Mandatory. Used in full-, half-duplex, and simplex session establishment and COMM_CHANGE. Session static. (See 6.2.4.3.) | P, M  |
| Comm_Change_Lifetime        | Mandatory. Used in the COMM_CHANGE persistent activity. Session static. (See 6.2.4.10.)                                  | M     |
| Comm_Change_Notification    | Mandatory. Used in the COMM_CHANGE persistent activity. Session static. (See 6.2.4.9.)                                   | M     |
| Comm_Change_Response        | Mandatory. Used in the COMM_CHANGE persistent activity. Session static. (See 6.2.4.8.)                                   | M     |
| Comm_Change_Waiting_Period  | Mandatory. Used in the COMM_CHANGE persistent activity. Session static. (See 6.2.4.7.)                                   | M     |
| Hail_Lifetime               | Mandatory. Used in the hailing persistent activity. Session static. (See 6.2.4.14.)                                      | M     |
| Hail_Notification           | Mandatory. Used in the hailing persistent activity. Session static. (See 6.2.4.13.)                                      | M     |



CCSDS RECOMMENDED STANDARD FOR PROXIMITY-1 SPACE DATA LINK PROTOCOL

| Parameter                   | Use                                                                                                                                                                                                                 | Layer |
|-----------------------------|---------------------------------------------------------------------------------------------------------------------------------------------------------------------------------------------------------------------|-------|
| Hail_Response               | Mandatory. Used in the hailing persistent activity. Session static. (See 6.2.4.12.)                                                                                                                                 | M     |
| Hail_Wait_Duration          | Mandatory. Used in the hailing persistent activity. Session static. (See 6.2.4.11.)                                                                                                                                 | M     |
| Hailing_Channel             | Mandatory. Channel assignment used in the hailing persistent activity during link establishment. Session static. (See 6.2.4.15.)                                                                                    | P,M   |
| Hailing_Data_Rate           | Mandatory. Data rate used in the hailing persistent activity during link establishment. Session static. (See 6.2.4.16.)                                                                                             | P,M   |
| Interval_Clock              | Mandatory. A frequency (e.g., 100 Hz) that is used for interval timing. Session static. (See 6.3.)                                                                                                                  | C     |
| Local_PCID                  | Optional. Used to set the value of the local receiver's PCID.                                                                                                                                                       | M     |
| Local_Spacecraft_ID         | Mandatory. Used as a frame validation check when Source-or-Destination ID equals <i>source</i> . Session static. (See 3.2.2.9.3.)                                                                                   | M     |
| Maximum_Failed-Token_Passes | Optional. Half-duplex. Defines the maximum number of times the transceiver is allowed to cycle through S50->S56->S58->S62->E50->S51->S52->S50 before E83 is triggered forcing the transceiver into S80 (reconnect). | D     |
| Maximum_Frame_Length        | Mandatory. Defines the maximum size Proximity-1 transfer frame transferred between nodes. Link efficiency at various data rates may require varying frame lengths. Session dynamic. (See 3.2.3.1.)                  | F     |
| Maximum_Packet_Size         | Mandatory if packets are used. Maximum size of a packet in octets. Used in the segmentation process. Session static. (See 4.4.1.1.)                                                                                 | I     |

CCSDS RECOMMENDED STANDARD FOR PROXIMITY-1 SPACE DATA LINK PROTOCOL

| Parameter             | Use                                                                                                                                                                                                                                                                                                                                             | Layer   |
|-----------------------|-------------------------------------------------------------------------------------------------------------------------------------------------------------------------------------------------------------------------------------------------------------------------------------------------------------------------------------------------|---------|
| Persistence_Wait_Time | Mandatory. Defines the maximum amount of time the initiating transceiver stays in persistence until either (1) it receives an acknowledgement from the remote transceiver that the COMM_CHANGE was acted upon, or (2) the wait timer times out. (See table 6-8, 'Full Duplex Communication Change State Table'.)                                | M       |
| PLCW_Repeat_Interval  | Mandatory. Used in COP-P. Session static. (See 6.2.4.19.)                                                                                                                                                                                                                                                                                       | D       |
| Receive_Duration      | Mandatory. Used in half-duplex data services. Session static. (See 6.2.4.18.)                                                                                                                                                                                                                                                                   | D       |
| Drop_Carrier_Duration | Mandatory. Used in full and half-duplex data services. The caller drops the carrier for this defined amount of time. Used to force the responder to lose carrier lock and therefore transition to State S2: Waiting for Hail. Session static. (See 6.4.2.)                                                                                      | D       |
| Remote_PCID           | Mandatory. Used to identify the powered receiver used by the remote transceiver.                                                                                                                                                                                                                                                                | M       |
| Remote_Spacecraft_ID  | Mandatory. Used to address one or several remote spacecraft as opposed to the local spacecraft. Session dynamic. (See 3.2.2.9.3.)                                                                                                                                                                                                               | F,M,D,I |
| Resync_Local          | Mandatory. If Resync_Local equals <i>false</i> , it is the responsibility of the local controller to decide how synchronization will be re-established. Otherwise, if <i>true</i> , the Sender Node's FOP-P forces synchronization by requesting a SET V(R) persistent activity. Session static. (See 7.2.3.2, 'SET V(R) Persistent Activity'.) | D       |
| Resync_Lifetime       | Mandatory. Used in the FOP-P SET V(R) persistent activity. Session static. (See 7.2.3.2.)                                                                                                                                                                                                                                                       | M,D     |
| Resync_Notification   | Mandatory. Used in the FOP-P SET V(R) persistent activity. Session static. (See 7.2.3.2.)                                                                                                                                                                                                                                                       | M,D     |

CCSDS RECOMMENDED STANDARD FOR PROXIMITY-1 SPACE DATA LINK PROTOCOL

| Parameter             | Use                                                                                                                                          | Layer |
|-----------------------|----------------------------------------------------------------------------------------------------------------------------------------------|-------|
| Resync_Response       | Mandatory. Used in the FOP-P SET V(R) persistent activity. Session static. (See 7.2.3.2.)                                                    | M,D   |
| Resync_Waiting_Period | Mandatory. Used in the FOP-P SET V(R) persistent activity. Session static. (See 7.2.3.2.)                                                    | M,D   |
| Send_Duration         | Mandatory. Used in half-duplex data services. Session static. (See 6.2.4.17.)                                                                | D     |
| Source_Destination_ID | Mandatory. '0'= Source SCID; '1'=Destination SCID. Session Static. (See 3.2.2.9.)                                                            | M     |
| Synch_Timeout         | Mandatory. Defines the value to which the SYNCH_TIMER is initialized or reinitialized. Session static. (See 7.2.2.)                          | D     |
| Tail_Idle_Duration    | Mandatory. Used in full-, half-duplex, and simplex session establishment and COMM_CHANGE. Session static. (See 6.2.4.5.)                     | P, M  |
| Test_Source           | Mandatory. Used in the verification of the spacecraft ID when the Source-or-Destination ID is <i>source</i> . Session static. (See 6.2.4.2.) | F     |
| Transmission_Window   | Mandatory. Sets the maximum size of the transmission window for the COP-P. Session static. (See 7.2.3.3, note 3.)                            | D     |

## ANNEX D

### NOTIFICATIONS TO VEHICLE CONTROLLER

#### (NORMATIVE)

This table summarizes all of the conditions throughout the document under which the vehicle controller is notified from within the protocol.

| Number | Condition                                                                                                                                                                                                                                      | Reference                                                                                                         |
|--------|------------------------------------------------------------------------------------------------------------------------------------------------------------------------------------------------------------------------------------------------|-------------------------------------------------------------------------------------------------------------------|
| 1      | RESULT OF PERSISTENT ACTIVITY<br>Notification of the success or failure of a persistent activity.                                                                                                                                              | (See 4.2.2.2, 'Persistence'.)                                                                                     |
| 2      | STATE CONTROL STATUS<br>Status of the Proximity-1 State Control Variables.                                                                                                                                                                     | (See state tables contained in section 6.)                                                                        |
| 3      | INVALID FRAME SOURCE<br>When the SCID field and RECEIVING_SCID_BUFFER disagree, and Test_Source is <i>true</i> , then a session violation has occurred and the vehicle controller shall be notified.                                           | (See 6.7, 'RECEIVING OPERATIONS'.)                                                                                |
| 4      | TIMING SERVICES INSTANCE<br>At the end of receiving the SET CONTROL PARAMETERS ( <i>time sample</i> ) directives, the recipient transceiver notifies its vehicle controller that Proximity time tags and frame sequence numbers are available. | (See section 5, 'Proximity-1 Timing Services'.)                                                                   |
| 5      | NO CARRIER RECEIVED—HALF DUPLEX                                                                                                                                                                                                                | State table 6-10, Event 50.                                                                                       |
| 6      | NO DATA TRANSFERRED—HALF DUPLEX                                                                                                                                                                                                                | State table 6-10, Event 45, E50                                                                                   |
| 7      | SENDER EXCEEDED PRESCRIBED TRANSMISSION PERIOD—HALF DUPLEX                                                                                                                                                                                     | State table 6-10, Event 44.                                                                                       |
| 8      | COP-P LOSS OF SYNCHRONIZATION<br>When FOP-P detects out-of-synchronization condition (SYNCH_TIMER Expires).                                                                                                                                    | (See 7.2.3.3, 'FOP-P State Table', Event SE4.)                                                                    |
| 9      | CARRIER_LOSS_TIMER UNDERFLOWS                                                                                                                                                                                                                  | State table 6-9, Event 27.                                                                                        |
| 10     | END OF SESSION(# octets received)<br>Notify the vehicle controller of the number of octets received during the session.                                                                                                                        | State table 6-9, Events E26, E27, E28.<br>State table 6-12, Events E57, E58, E61.<br>State table 6-13, Event E73. |
| 11     | CARRIER ONLY RECEIVED<br>Caller notifies vehicle controller that carrier only was detected immediately after the 'Wait for Hail Response' state terminated.                                                                                    | State table 6-7, Event E8.<br>State table 6-10, Event E36.                                                        |

## **ANNEX E**

### **SECURITY, SANA, AND PATENT CONSIDERATIONS**

#### **(INFORMATIVE)**

#### **E1 SECURITY CONSIDERATIONS**

##### **E1.1 SECURITY BACKGROUND**

It may be required that security services be applied to the payloads carried by IP datagrams over CCSDS space links. The specification of such security services is outside the scope of this document but is discussed in the following subsections.

If there is a reason to believe that non-authorized entities might be able to view or obtain the payload data, and if there is a need to ensure that non-authorized entities not be able to view or obtain the data, then confidentiality needs to be applied. If there is a need to ensure that the payload data has not been modified in transit without such modification being recognized, then integrity needs to be applied. If the authenticity of the source of the payload data is required (e.g., the payload contains a command), then authentication needs to be applied. It is possible for a single datagram to require all three security services to ensure that the payload is not disclosed, not altered, and authentic.

##### **E1.2 SECURITY CONCERNS**

As stated in the previous subsection, various security services might need to be applied to the IP datagram depending on the threat, the mission security policy(s), and the desire of the mission planners. While these security concerns are valid, they are outside the scope of this document. This document assumes that either upper or lower layers of the OSI model will provide the security services. That is, if authenticity at the granularity of a specific user is required, it is best applied at the Application Layer. If less granularity is required, it could be applied at the Network or Data Link Layers. If integrity is required, it can be applied at either the Application, Network, or Data Link Layer. If confidentiality is required, it can be applied at either the Application Layer, the Network Layer, or the Data Link Layer. Reference [H4] provides more information regarding the choice of service and where it can be implemented.

##### **E1.3 POTENTIAL THREATS AND ATTACK SCENARIOS**

Without authentication, unauthorized commands or software might be uploaded to a spacecraft or data retrieved from a source masquerading as the spacecraft. Without integrity, corrupted commands or software might be uploaded to a spacecraft. Without integrity, corrupted telemetry might be retrieved from a spacecraft, and the result could be that an

incorrect course of action is taken. Sensitive or private information might be disclosed to an eavesdropper if confidentiality is not applied to the data.

#### **E1.4 CONSEQUENCES OF NOT APPLYING SECURITY**

The security services are out of scope of this document and should be applied at layers above or below those specified in this document. However, should there be a requirement for authentication, and if it is not implemented, unauthorized commands or software might be loaded onto a spacecraft. If integrity is not implemented, erroneous commands or software might be loaded onto a spacecraft, potentially resulting in the loss of the mission. If confidentiality is not implemented, data flowing to or from a spacecraft might be visible to unauthorized entities, resulting in disclosure of sensitive or private information.

#### **E2 SANA CONSIDERATION**

The current issue of this Recommended Standard does not require any action from SANA. Existing SANA registries created in support of previous issues of this Recommended Standard should continue to be maintained.

#### **E3 PATENT CONSIDERATIONS**

No patents are known to apply to this Recommended Standard. Information concerning patent rights and licensing for LDPC coding is contained in annex B of reference [2].

## ANNEX F

### NASA MARS SURVEYOR PROJECT 2001 ODYSSEY ORBITER PROXIMITY SPACE LINK CAPABILITIES

#### (INFORMATIVE)

NOTE – The following capability is being used by the NASA Mars Surveyor Project 2001 Odyssey orbiter and is being provided for information only.

#### F1 TONE BEACON MODE

**F1.1** The Tone Beacon Mode configures the transceiver to transmit a CW tone. This mode can be used to signal microprobes to transmit their data to the orbiter. Addressing of multiple microprobes is accomplished by using four unique CW frequencies. Microprobes can respond in any transmit configuration compatible with valid orbiter receive configurations.

**F1.2** The four orbiter CW beacon frequencies are:

- a) 437.1000 MHz;
- b) 440.7425 MHz;
- c) 444.3850 MHz;
- d) 448.0275 MHz.

**F1.3** The lander CW beacon frequency is 401.585625.

**F1.4** The Tone Beacon Mode can be used to perform Doppler measurements. The orbiter can provide a CW tone at 437.1 MHz and the lander can coherently transpond with the CW tone at 401.585625 MHz.

#### F2 TRANSMIT STANDBY MODE

Transmit Standby mode prevents the transceiver from transmitting. This is the default mode when multiple landed elements are within the field of view of an orbiter hailing. It prevents interference caused by several landed elements responding simultaneously.

#### F3 CONVOLUTIONAL CODE IMPLEMENTATION

The rate 1/2, constraint-length 7 convolutional code employed does not contain symbol inversion on the output path of connection vector G2 as specified in reference [2]. In order

to be compatible with the NASA Mars Surveyor Project 2001 Odyssey orbiter, implementations will need to set the encoding data parameter field of the SET TRANSMITTER PARAMETERS and SET RECEIVER PARAMETERS directives as indicated in C4 in the directives below.

#### F4 DIRECTIVE AND PROTOCOL DATA UNITS

NOTE – The SET TRANSMITTER PARAMETERS and SET RECEIVER PARAMETERS directives are always transmitted together.

##### F4.1 SET TRANSMITTER PARAMETERS DIRECTIVE

###### F4.1.1 General

The SET TRANSMITTER PARAMETERS directive consists of six fields, positioned contiguously in the following sequence (described from least significant bit, Bit 15, to most significant bit, Bit 0):

- a) Set Directive Type (3 bits);
- b) Transmitter Frequency (3 bits);
- c) Transmitter Data Encoding (2 bits);
- d) Transmitter Modulation (1 bit);
- e) Transmitter Data Rate (4 bits);
- f) Transmitter Mode (3 bits).

NOTE – The structural components of the SET TRANSMITTER PARAMETERS directive are shown in figure F-1.

| Bit 0             |                        |                        | Bit 15                     |                        |                              |
|-------------------|------------------------|------------------------|----------------------------|------------------------|------------------------------|
| TX Mode<br>3 bits | TX Data Rate<br>4 bits | TX Modulation<br>1 bit | TX Data Encoding<br>2 bits | TX Frequency<br>3 bits | Set Directive Type<br>3 bits |
| 0,1,2             | 3,4,5,6                | 7                      | 8,9                        | 10,11,12               | 13,14,15                     |

**Figure F-1: NASA Mars Surveyor Project 2001 Odyssey SET TRANSMITTER PARAMETERS Directive**

###### F4.1.2 Set Directive Type

**F4.1.2.1** Bits 13–15 of the SET TRANSMITTER PARAMETERS directive contain the Set Directive Type.



**F4.1.2.2** The 3-bit Set Directive Type field identifies the type of protocol control directive and contains the binary value '000' for the SET TRANSMITTER PARAMETERS directive.

### F4.1.3 Transmitter Frequency

**F4.1.3.1** Bits 10–12 of the SET TRANSMITTER PARAMETERS directive are used to set the transmitter frequency of the partnered transceiver to the desired value.

**F4.1.3.2** This 3-bit field contains the value '000' indicating that the responder's transmit return frequency, 401.585625 MHz, is used.

### F4.1.4 Transmitter Data Encoding

Bits 8–9 of the SET TRANSMITTER PARAMETERS directive contain the following coding options:

- a) '00' = Scrambler;
- b) '01' = Convolutional Code (7,1/2) without G2 inverter (CRC-32 attached);
- c) '10' = Bypass Convolutional Code;
- d) '11' = N/A.

### F4.1.5 Transmitter Modulation

Bit 7 of the SET TRANSMITTER PARAMETERS directive contains the transmission modulation options:

- a) '1' = PSK;
- b) '0' = PSK Coherent.

### F4.1.6 Transmitter Data Rate

Bits 3–6 of the SET TRANSMITTER PARAMETERS directive contain the transmitter data rate.

|        |        |        |        |        |        |        |        |        |        |        |        |        |        |        |        |
|--------|--------|--------|--------|--------|--------|--------|--------|--------|--------|--------|--------|--------|--------|--------|--------|
| '0000' | '0001' | '0010' | '0011' | '0100' | '0101' | '0110' | '0111' | '1000' | '1001' | '1010' | '1011' | '1100' | '1101' | '1110' | '1111' |
| 8 NC   | 8 C    | 32 NC  | 32 C   | 128 NC | 128 C  | 256 NC | 256 C  | N/A    | N/A    | N/A    | N/A    | N/A    | N/A    | N/A    | N/A    |

NOTE – Rates are in kb/s, e.g., 4 = 4000 b/s; C indicates PSK coherent modulation, and NC indicates PSK non-coherent modulation.

### F4.1.7 Transmitter Mode

F4.1.7.1 Bits 0–2 of the SET TRANSMITTER PARAMETERS directive contain the transmitter mode options:

- a) '000' = Standby;
- b) '001' = Sequence Controlled;
- c) '010' = Expedited;
- d) '011' = Unreliable Bitstream;
- e) '100' = Tone Beacon;
- f) '101' = Canister Mode.

## F4.2 SET RECEIVER PARAMETERS DIRECTIVE

### F4.2.1 General

The SET RECEIVER PARAMETERS directive consists of six fields, positioned contiguously in the following sequence (described from least significant bit, Bit 15, to most significant bit, Bit 0):

- a) Set Directive Type (3 bits);
- b) Receiver Frequency (3 bits);
- c) Receiver Data Decoding (2 bits);
- d) Receiver Modulation (1 bit);
- e) Receiver Data Rate (4 bits);
- f) Receiver Mode (3 bits).

NOTE – The structural components of the SET RECEIVER PARAMETERS directive are shown in figure F-2.

| Bit 0             |                   |                        | Bit 15                     |                        |                              |
|-------------------|-------------------|------------------------|----------------------------|------------------------|------------------------------|
| RX Mode<br>3 bits | RX Rate<br>4 bits | RX Modulation<br>1 bit | RX Data Decoding<br>2 bits | RX Frequency<br>3 bits | Set Directive Type<br>3 bits |
| 0,1,2             | 3,4,5,6           | 7                      | 8,9                        | 10,11,12               | 13,14,15                     |

**Figure F-2: NASA Mars Surveyor Project 2001 Odyssey SET RECEIVER PARAMETERS Directive**

## F4.2.2 Set Directive Type

**F4.2.2.1** Bits 13–15 of the SET RECEIVER PARAMETERS directive contain the directive type.

**F4.2.2.2** The 3-bit Set Directive Type field identifies the type of protocol control directive and contains the binary value ‘010’ for the SET RECEIVER PARAMETERS directive.

## F4.2.3 Receiver Frequency

**F4.2.3.1** Bits 10–12 of the SET RECEIVER PARAMETERS directive are used to set the receiver frequency of the partnered transceiver to the desired value.

**F4.2.3.2** This 3-bit field contains the value ‘000’ indicating that the responder’s receive forward frequency is set to 437.1 MHz.

## F4.2.4 Receiver Data Decoding

Bits 8–9 of the SET RECEIVER PARAMETERS directive contains the following coding options:

- a) ‘00’ = Scrambler;
- b) ‘01’ = Convolutional Code (7,1/2) without G2 Inverter (CRC-32 attached);
- c) ‘10’ = Bypass Convolutional Code;
- d) ‘11’ = N/A.

## F4.2.5 Receiver Modulation

Bit 7 of the SET RECEIVER PARAMETERS directive contains the receiver modulation options:

- a) ‘1’ = PSK;
- b) ‘0’ = PSK Coherent.

## F4.2.6 Receiver Data Rate

Bits 3–6 of the SET RECEIVER PARAMETERS directive contains the receiver data rate.

|        |        |        |        |        |        |        |        |        |        |        |        |        |        |        |        |
|--------|--------|--------|--------|--------|--------|--------|--------|--------|--------|--------|--------|--------|--------|--------|--------|
| ‘0000’ | ‘0001’ | ‘0010’ | ‘0011’ | ‘0100’ | ‘0101’ | ‘0110’ | ‘0111’ | ‘1000’ | ‘1001’ | ‘1010’ | ‘1011’ | ‘1100’ | ‘1101’ | ‘1110’ | ‘1111’ |
| 8 NC   | 8 C    | 32 NC  | 32 C   | 128 NC | 128 C  | 256 NC | 256 C  | N/A    | N/A    | N/A    | N/A    | N/A    | N/A    | N/A    | N/A    |

NOTE – Rates are in kb/s, e.g., 4 = 4000 b/s; C indicates PSK coherent modulation, and NC indicates PSK non-coherent modulation.

#### **F4.2.7 Receiver Mode**

Bits 0–2 of the SET RECEIVER PARAMETERS directive contain the Receiver Mode options:

- a) '000' = Standby;
- b) '001' = Sequence Controlled;
- c) '010' = Expedited;
- d) '011' = Unreliable Bitstream;
- e) '100' = Tone Beacon.

### **F4.3 PROXIMITY LINK CONTROL WORD**

#### **F4.3.1 General**

**F4.3.1.1** The PLCW consists of seven fields (see figure F-3), positioned contiguously, and described from least (Bit 15) to most significant bit (Bit 0) in the following sequence:

- a) Report Value (8 bits);
- b) Expedited Frame Counter (3 bits);
- c) Reserved Spare (1 bit);
- d) PCID (1 bit);
- e) Retransmit Flag (1 bit);
- f) SPDU Type Identifier (1 bit);
- g) SPDU Format ID (1 bit).

**F4.3.1.2** The PLCW is transmitted using the Expedited QoS.

NOTE – At the time of the implementation of the Proximity-1 Protocol for NASA Mars Surveyor Project 2001 Odyssey the PCID field was called VCID. However, the functionality of that implementation is equivalent to a Physical Channel ID.

|                                   |                                         |                                      |                   |                                |                                             |                                 |        |
|-----------------------------------|-----------------------------------------|--------------------------------------|-------------------|--------------------------------|---------------------------------------------|---------------------------------|--------|
| Bit 0                             |                                         |                                      |                   |                                |                                             |                                 | Bit 15 |
| SPDU Header                       |                                         | SPDU Data Field                      |                   |                                |                                             |                                 |        |
| SPDU<br>Format<br>ID<br><br>1 bit | SPDU<br>Type<br>Identifier<br><br>1 bit | Retrans-<br>mit<br>Flag<br><br>1 bit | PCID<br><br>1 bit | Reserved<br>Spare<br><br>1 bit | Expedited<br>Frame<br>Counter<br><br>3 bits | Report Value<br>(FSN)<br>8 bits |        |

**Figure F-3: Proximity Link Control Word Fields**

### F4.3.2 Report Value

**F4.3.2.1** Bits 8–15 of the PLCW contains the Report Value.

**F4.3.2.2** The Report Value field contains the next Sequence Controlled Frame Sequence Number (SEQ\_FSN), i.e., N(R).

**F4.3.2.3** Separate Report Values are maintained for each PCID independent of the I/O port.

### F4.3.3 Expedited Frame Counter

**F4.3.3.1** Bits 5–7 of the PLCW contain the EXPEDITED\_FRAME\_COUNTER.

**F4.3.3.2** The EXPEDITED\_FRAME\_COUNTER provides a modulo-8 counter indicating that Expedited frames have been received. This value is set to ‘all zero’, indicating that it is not used.

### F4.3.4 Reserved Spare

**F4.3.4.1** Bit 4 of the PLCW contains a Reserved Spare bit.

**F4.3.4.2** The Reserved Spare bit field is set to ‘0’.

### F4.3.5 Physical Channel Identification

**F4.3.5.1** Bit 3 of the PLCW contains the PCID field.

**F4.3.5.2** The 1-bit PCID field contains the PCID of the physical channel with which this report is associated. The PCID field is set to ‘0’, indicating PCID 0.

NOTE – Each PCID in use has its own PLCW reporting activated.

### **F4.3.6 PLCW Retransmit Flag**

**F4.3.6.1** Bit 2 of the PLCW contains the PLCW Retransmit Flag.

**F4.3.6.2** The PLCW Retransmit Flag is always '0'.

**F4.3.6.3** A lack of increment in the Report Value indicates that a received frame failed a frame acceptance check and that a retransmission of the expected frame is required.

### **F4.3.7 SPDU Type Identifier**

**F4.3.7.1** Bit 1 of the PLCW contains the SPDU Type Identifier.

**F4.3.7.2** The 1-bit SPDU Type Identifier field identifies SPDU type as a PLCW and contains the binary value '0'.

### **F4.3.8 SPDU Format ID**

**F4.3.8.1** Bit 0 of the PLCW contains the SPDU Format ID.

**F4.3.8.2** The 1-bit SPDU format ID field indicates that the length of the SPDU is fixed and contains the binary value '1'.

## ANNEX G

### NASA MARS RECONNAISSANCE ORBITER 2005 PROXIMITY SPACE LINK CAPABILITIES

#### (INFORMATIVE)

NOTE – For Proximity-1 symbol rates above 512 ks/s, projects planning to interoperate with NASA MRO should consider using NRZ-L instead of Bi-Phase-L unless the performance achievable with Bi-Phase-L is sufficient for the project concerned.

#### **Residual Carrier vs. Suppressed Carrier:**

The Electra radio is capable of modulating and demodulating data in both residual carrier and suppressed carrier modes. For residual carrier operations, some portion of the transmitted signal power is retained in a tone carrier at the center frequency of the data channel. Typically the modulation index is set at 60 degrees which results in 25 percent of the transmitted power going into the carrier tone and 75 percent of the transmitted power going into the modulated data symbols.

For residual carrier mode, the transmitted symbols are Bi-Phase-L encoded (i.e., Manchester coding), which produces a data spectrum with a null at the center frequency. The carrier tone then appears in this spectral null making it much easier for a standard carrier tracking loop to acquire and track the carrier tone. The carrier phase established a phase reference which is used to demodulate the phase encoded symbol data. The Manchester coding has the added benefit of producing a 180-degree signal phase transition in the middle of every transmitted symbol. This regular phase transition pattern provides consistent acquisition and tracking of symbol timing in the demodulation process. This is standard practice of residual carrier BPSK modulation.

For the suppressed carrier mode, the transmitted symbols are Non-Return to Zero-Level (NRZ-L) phase encoded and all of the transmit power goes into the data modulation. The modulation index is 90 degrees. Since there is no residual carrier to establish a phase reference at the receive end, a Costas loop is used to reconstruct an equivalent phase reference from the data signal. The phase reference out of the Costas loop has a 180-degree phase ambiguity, since the Costas loop can equally likely phase lock on the originally transmitted reference phase or its 180 degree phase inversion. Thus it is typical for suppressed carrier operations also to use differential bit encoding. Differential bit encoding uses the bit transitions of the source data as the information content to be transmitted. A differential decoder at the receive end of the link unwraps this encoding while simultaneously eliminating the impact of the 180-degree phase ambiguity. (See the note on Differential Encoding for more information.)

For any particular symbol rate, suppressed carrier mode puts 1.25 dB more signal power into the modulated data when compared to the residual carrier mode using a 60-degree

modulation index. This translates almost directly into 1.25 dB of additional link performance with the operational caveats described earlier. The question then becomes, When should one ever use the residual carrier mode? It turns out that the residual carrier loop has a practical tracking loop Signal to Noise Ratio (SNR) threshold of 7 dB. To obtain equivalent performance from the Costas loop requires a loop SNR of 16 dB. Low loop SNR can occur in low power situations or, most typically for operations, at lower data rates. Link designers should evaluate predicts for total received signal power, link Doppler dynamics, required signal acquisition times, and carrier or Costas tracking loop bandwidth to estimate the minimum loop SNR the link will see. The general rule then is: if loop SNR is high enough to operate a Costas loop, then suppressed carrier operation will provide better Bit Error Rate (BER) vs. Received Signal Level (RSL) performance.

For some emergency situations or critical events like Entry, Descent, and Landing (EDL) where low data rates are used and signal levels are known to be very low or have high uncertainty it can be a risk mitigator to specify residual carrier operations.

Some relay radios, e.g., the Cincinnati-Electronics CE-505 radio on the NASA Mars Odyssey, support only residual carrier operations, and thus the Electra radio is operated in residual carrier mode as a matter of functional compatibility with relay partners that use these radios.

#### NRZ-L vs. Bi-Phase-L Modulation:

The Electra radio supports two standard symbol modulations, NRZ-L and Bi-Phase-L. NRZ-L. NRZ-L is a symbol transmission code where an input binary data value of '1' is represented by an output transmission symbol value of '1' and an input binary data value of '0' is represented by an output transmission symbol value of '-1'. There is no 'rest' state or 'zero' state for this transmission code; thus the name, 'non-return to zero'. Since there is no idle time or idle state between transmission symbols, there is no guarantee of a signal phase transition between symbols. The extreme case would be the transmission of a long string of all '1's or all '0's. To assist symbol synchronization at the receive end, the NRZ-L mode is commonly used with a data scrambler to eliminate long strings to '1's or '0's from the transmission stream. In this case a compatible descrambler is used on the receive end of the link. The encoding diagram, taken from Wikipedia, is shown below.

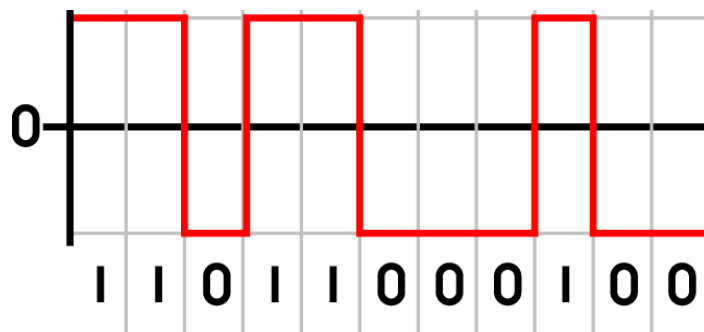

An alternative transmission symbol encoding is Bi-Phase-L, a.k.a. Manchester. Manchester is a symbol transmission code where an input binary data value of '1' is represented by an



output transmission symbol with a value of '1' for the first half of the symbol time and a value of '-1' for second half of the symbol time. Conversely, an input binary data value of '0' is represented by an output transmission symbol with a value of '-1' for the first half of the symbol time and a value of '1' for the second half of the symbol time. The encoding diagram, taken from Wikipedia, is shown below.

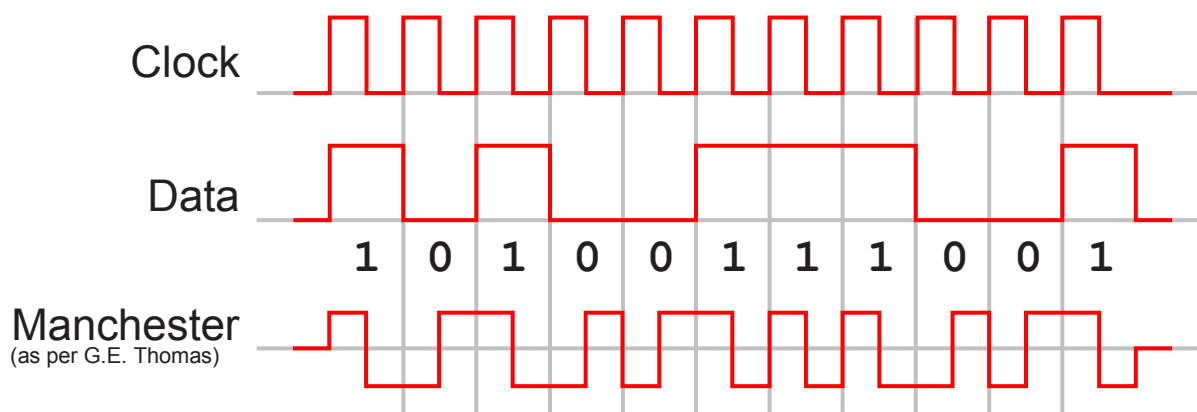

For phase modulation, Manchester coding results in two phase states for each encoded symbol or Bi-Phase-L symbols. The mid-symbol phase transition for every symbol makes recovery of the symbol clock very easy. Another advantage of Manchester phase modulation is that the resulting spectrum produces a null at center frequency, making it very convenient to use with a residual carrier at the center frequency. The downside to Manchester is that the extra half symbol transition produces a broader spectrum. For any fixed symbol rate, Manchester uses roughly twice the spectrum as an equivalent NRZ-L encoded symbol stream.

### Differential Encoding:

Some of the modes of demodulation and channel decoding within Electra can result in a sign inversion or sign ambiguity in the demodulated and decoded data stream. The Costas loop is equally likely to lock up on the 180-degree phase point or the 0 degree phase point relative to the originally transmitted spectrum and there is no intrinsic indication of which lock point was achieved. If the 180 degrees is the lock point of the loop, the resulting demodulated data is sign inverted.

A common solution is to employ differential encoding of the form,  $B(n) = \text{XOR}(A(n), B(n-1))$ , where  $A$  is the original data sequence and  $B$  is the differentially encoded data stream that is transmitted. The compatible decoder is of the form,  $C(n) = \text{XOR}(B(n), B(n-1))$ , where  $B$  is the received data symbol stream and  $C$  is the differentially decoded output.  $C(n)$  will equal  $A(n)$  if there are no errors in the  $B(n)$  sequence. It should be noted that the output sequence  $C$  is dependent only on the phase transitions of the received symbol stream. Thus a 180-degree phase shift or equivalent binary inversion of the  $B$  data stream will result in the same  $C$  bit stream output with the possible exception of the first bit. The operational expense of differential encoding/decoding is an extra bit error added to the any string of demodulation errors. So a single demodulation bit  $B(I)$  that is in error produces a double bit error in the

CCSDS RECOMMENDED STANDARD FOR PROXIMITY-1 SPACE DATA LINK PROTOCOL

decoded bit stream C out of the differential decoder. Two consecutive demodulation bit errors, B(i) and B(i+1) become three consecutive bit errors in the decoded bit stream C out of the differential decoder and so on.

On the MRO Electra, Viterbi decoding is performed by the TEMIC chip inside the radio. The Proximity-1 CCSDS standard k=7, rate 1/2 convolutional code (see reference [5]) specifies the inversion of every other symbol out of the encoder. In particular the G2 symbols are always inverted. The TEMIC chip follows a commercial code standard that does NOT invert every other symbol, and it cannot decode at G2 inverted symbol stream without some extra bit manipulation between the demodulator and the decoder. **The extra manipulations create a sign ambiguity in the resulting output of the Viterbi decoded data, and so for proper decoding of the CCSDS Proximity-1 k=7, rate 1/2 convolutional standard, G2 inverted convolutional code, users are recommended to use differential encoding.**

|                                               |                                                   | Null Start | A0 | A1 | A2 | A3 | A4 | A5 | A6 | A7 | A8 |
|-----------------------------------------------|---------------------------------------------------|------------|----|----|----|----|----|----|----|----|----|
| Initial Data Bit stream                       | Call the original data the "A" stream             | 0          | 1  | 1  | 0  | 1  | 1  | 1  | 0  | 0  | 1  |
| Diff. Encoding, XOR, B(n) = XOR[A(n), B(n-1)] | Call the differential encoded data the "B" stream | 0          | 1  | 0  | 0  | 1  | 0  | 1  | 1  | 1  | 0  |
| Diff Decoding, XOR, C(n) = XOR[B(n), B(n-1)]  | Call the differential decoded data the "C" stream | 0          | 1  | 1  | 0  | 1  | 1  | 1  | 0  | 0  | 1  |

**FSK Modulation:**

FSK modulation is currently not implemented on the NASA MRO Electra transceiver.

**QPSK Modulation:**

QPSK modulation is currently not implemented on the NASA MRO Electra transceiver.

## ANNEX H

### INFORMATIVE REFERENCES

#### (INFORMATIVE)

NOTE – References [H1]-[H3] define Physical Layer techniques that are not part of the Proximity-1 Physical Layer specification. They are included here so that transceivers with an extended Physical Layer can interoperate.

- [H1] *Digital Video Broadcasting (DVB); Framing Structure, Channel Coding and Modulation for 11/12 GHz Satellite Services*. ETSI EN 300 421 V1.1.2 (1997-08). Sophia-Antipolis: ETSI, 1997.
- [H2] *A 48/56/64 kbit/s Data Circuit-Terminating Equipment Standardized for Use on Digital Point-to-Point Leased Circuits*. ITU-T Recommendation V.38. Geneva: ITU, 1996.
- [H3] *Performance Characteristics for Intermediate Data Rate Digital Carriers Using Convolutional Encoding/Viterbi Encoding*. Rev. 10. IESS 308. Washington, DC: INTELSAT, 2000.
- [H4] *The Application of CCSDS Protocols to Secure Systems*. Issue 2. Report Concerning Space Data System Standards (Green Book), CCSDS 350.0-G-2. Washington, D.C.: CCSDS, January 2006.
- [H5] *Communications Operation Procedure-1*. Issue 2. Recommendation for Space Data System Standards (Blue Book), CCSDS 232.1-B-2. Washington, D.C.: CCSDS, September 2010.
- [H6] *TC Space Data Link Protocol*. Issue 2. Recommendation for Space Data System Standards (Blue Book), CCSDS 232.0-B-2. Washington, D.C.: CCSDS, September 2010.
- [H7] *TM Space Data Link Protocol*. Issue 1. Recommendation for Space Data System Standards (Blue Book), CCSDS 132.0-B-1. Washington, D.C.: CCSDS, September 2003.
- [H8] Space Assigned Numbers Authority (SANA). <http://sanaregistry.org/>.
- [H9] *Proximity-1 Space Link Protocol—Rationale, Architecture, and Scenarios*. Issue 2. Report Concerning Space Data System Standards (Green Book), CCSDS 210.0-G-2. Washington, D.C.: CCSDS, December 2013.

**ANNEX I**  
**ABBREVIATIONS AND ACRONYMS**  
**(INFORMATIVE)**

|        |                                                    |
|--------|----------------------------------------------------|
| a.k.a. | also known as                                      |
| ARQ    | Automatic Repeat Queuing                           |
| ASM    | Attached Synchronization Marker                    |
| BER    | Bit Error Rate                                     |
| BPSK   | Binary Phase Shift Keying                          |
| C&DH   | Command and Data Handling                          |
| C&S    | Coding and Synchronization                         |
| CCSDS  | Consultative Committee for Space Data Systems      |
| CDS    | Command and Data Handling System                   |
| COP-P  | Communication Operations Procedure-Proximity       |
| CRC    | Cyclic Redundancy Check                            |
| CW     | Continuous Wave                                    |
| DFC ID | Data Field Construction Identifier                 |
| EDL    | Entry, Descent, and Landing                        |
| ETSI   | European Telecommunications Standards Institute    |
| FARM-P | Frame Acceptance and Reporting Mechanism-Proximity |
| FIFO   | First In First Out                                 |
| FOP-P  | Frame Operations Procedure-Proximity               |
| FSK    | Frequency Shift Keying                             |
| FSN    | Frame Sequence Number                              |
| I/O    | Input/Output                                       |
| ITU    | International Telecommunications Union             |
| LCCD   | Local COMM_CHANGE Directive                        |
| LDPC   | Low Density Parity Check                           |

CCSDS RECOMMENDED STANDARD FOR PROXIMITY-1 SPACE DATA LINK PROTOCOL

|         |                                                           |
|---------|-----------------------------------------------------------|
| LNMD    | Local No More Data                                        |
| MAC     | Medium Access Control                                     |
| MIB     | Management Information Base                               |
| MRO     | Mars Reconnaissance Orbiter                               |
| MSB     | Most Significant Bit                                      |
| N(R)    | Last acknowledged frame sequence number +1                |
| N(S)    | Frame Sequence Number within the Proximity-1 Frame Header |
| NN(R)   | Previous acknowledged frame sequence number +1            |
| NRZ-L   | Non-Return to Zero-Level                                  |
| OSI     | Open Systems Interconnection                              |
| OWLT    | One Way Light Time                                        |
| PCID    | Physical Channel ID                                       |
| PDU     | Protocol Data Unit                                        |
| P-frame | Supervisory/Protocol Frame                                |
| PLCW    | Proximity Link Control Word                               |
| PLTU    | Proximity Link Transmission Unit                          |
| PSK     | Phase Shift Keyed                                         |
| PVN     | Packet Version Number                                     |
| QoS     | Quality of Service                                        |
| QPSK    | Quadrature Phase Shift Keying                             |
| RF      | Radio Frequency                                           |
| R-S     | Reed-Solomon                                              |
| RNMD    | Remote_No_More_Data                                       |
| RSL     | Received Signal Level                                     |
| RX      | Receive/Receiver                                          |
| SANA    | Space Assigned Numbers Authority                          |
| SCID    | Spacecraft Identifier                                     |
| SCPS-NP | Space Communications Protocol Standards-Network Protocol  |
| SDU     | Service Data Unit                                         |

CCSDS RECOMMENDED STANDARD FOR PROXIMITY-1 SPACE DATA LINK PROTOCOL

|         |                                                                        |
|---------|------------------------------------------------------------------------|
| SNR     | Signal to Noise Ratio                                                  |
| SPDU    | Supervisory Protocol Data Unit                                         |
| SS      | Sub-State                                                              |
| TCP     | Time Correlation Packet                                                |
| TX      | Transmit/Transmitter                                                   |
| UDD     | User-Defined Data                                                      |
| U-frame | User Data Frame                                                        |
| UHF     | Ultra High Frequency                                                   |
| V(S)    | Value of the next Sequence Controlled Frame Sequence Number to be sent |
| VCID    | Virtual Channel Identification                                         |
| VE(S)   | Value of the next Expedited Frame Sequence Number to be sent           |

ANNEX J

PROXIMITY-1 DATA FORMAT HIERARCHY

(INFORMATIVE)

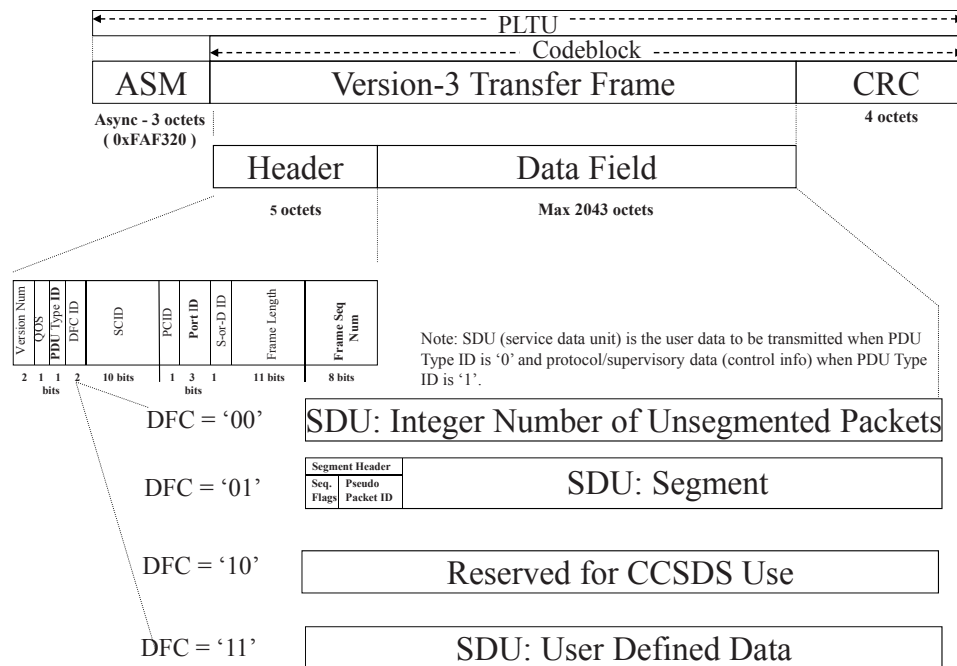

---

---

**ICS 49.140**

Price based on 151 pages





# British Standards Institution (BSI)

BSI is the national body responsible for preparing British Standards and other standards-related publications, information and services.

BSI is incorporated by Royal Charter. British Standards and other standardization products are published by BSI Standards Limited.

## About us

We bring together business, industry, government, consumers, innovators and others to shape their combined experience and expertise into standards-based solutions.

The knowledge embodied in our standards has been carefully assembled in a dependable format and refined through our open consultation process. Organizations of all sizes and across all sectors choose standards to help them achieve their goals.

## Information on standards

We can provide you with the knowledge that your organization needs to succeed. Find out more about British Standards by visiting our website at [bsigroup.com/standards](http://bsigroup.com/standards) or contacting our Customer Services team or Knowledge Centre.

## Buying standards

You can buy and download PDF versions of BSI publications, including British and adopted European and international standards, through our website at [bsigroup.com/shop](http://bsigroup.com/shop), where hard copies can also be purchased.

If you need international and foreign standards from other Standards Development Organizations, hard copies can be ordered from our Customer Services team.

## Subscriptions

Our range of subscription services are designed to make using standards easier for you. For further information on our subscription products go to [bsigroup.com/subscriptions](http://bsigroup.com/subscriptions).

With **British Standards Online (BSOL)** you'll have instant access to over 55,000 British and adopted European and international standards from your desktop. It's available 24/7 and is refreshed daily so you'll always be up to date.

You can keep in touch with standards developments and receive substantial discounts on the purchase price of standards, both in single copy and subscription format, by becoming a **BSI Subscribing Member**.

**PLUS** is an updating service exclusive to BSI Subscribing Members. You will automatically receive the latest hard copy of your standards when they're revised or replaced.

To find out more about becoming a BSI Subscribing Member and the benefits of membership, please visit [bsigroup.com/shop](http://bsigroup.com/shop).

With a **Multi-User Network Licence (MUNL)** you are able to host standards publications on your intranet. Licences can cover as few or as many users as you wish. With updates supplied as soon as they're available, you can be sure your documentation is current. For further information, email [bsmusales@bsigroup.com](mailto:bsmusales@bsigroup.com).

## BSI Group Headquarters

389 Chiswick High Road London W4 4AL UK

## Revisions

Our British Standards and other publications are updated by amendment or revision.

We continually improve the quality of our products and services to benefit your business. If you find an inaccuracy or ambiguity within a British Standard or other BSI publication please inform the Knowledge Centre.

## Copyright

All the data, software and documentation set out in all British Standards and other BSI publications are the property of and copyrighted by BSI, or some person or entity that owns copyright in the information used (such as the international standardization bodies) and has formally licensed such information to BSI for commercial publication and use. Except as permitted under the Copyright, Designs and Patents Act 1988 no extract may be reproduced, stored in a retrieval system or transmitted in any form or by any means – electronic, photocopying, recording or otherwise – without prior written permission from BSI. Details and advice can be obtained from the Copyright & Licensing Department.

## Useful Contacts:

### Customer Services

**Tel:** +44 845 086 9001

**Email (orders):** [orders@bsigroup.com](mailto:orders@bsigroup.com)

**Email (enquiries):** [cservices@bsigroup.com](mailto:cservices@bsigroup.com)

### Subscriptions

**Tel:** +44 845 086 9001

**Email:** [subscriptions@bsigroup.com](mailto:subscriptions@bsigroup.com)

### Knowledge Centre

**Tel:** +44 20 8996 7004

**Email:** [knowledgecentre@bsigroup.com](mailto:knowledgecentre@bsigroup.com)

### Copyright & Licensing

**Tel:** +44 20 8996 7070

**Email:** [copyright@bsigroup.com](mailto:copyright@bsigroup.com)



...making excellence a habit.™