

BS ISO 19631:2015



BSI Standards Publication

Aerospace series — Tube fittings for fluid systems, 5 080 psi (35 000 kPa) — Qualification specification

bsi.

...making excellence a habit.™

National foreword

This British Standard is the UK implementation of ISO 19631:2015.

The UK participation in its preparation was entrusted to Technical Committee ACE/69, Aerospace hydraulic systems, fluids and components.

A list of organizations represented on this committee can be obtained on request to its secretary.

This publication does not purport to include all the necessary provisions of a contract. Users are responsible for its correct application.

© The British Standards Institution 2015.

Published by BSI Standards Limited 2015

ISBN 978 0 580 73623 0

ICS 49.080

Compliance with a British Standard cannot confer immunity from legal obligations.

This British Standard was published under the authority of the Standards Policy and Strategy Committee on 30 September 2015.

Amendments/corrigenda issued since publication

Date	Text affected
------	---------------

INTERNATIONAL
STANDARD

ISO
19631

First edition
2015-09-01

**Aerospace series — Tube fittings for
fluid systems, 5 080 psi (35 000 kPa)
— Qualification specification**

*Série aérospatiale — Raccordements de tubes pour les systèmes
fluides, 5 080 psi (35 000 kPa) — Spécification de qualification*



Reference number
ISO 19631:2015(E)



COPYRIGHT PROTECTED DOCUMENT

© ISO 2015, Published in Switzerland

All rights reserved. Unless otherwise specified, no part of this publication may be reproduced or utilized otherwise in any form or by any means, electronic or mechanical, including photocopying, or posting on the internet or an intranet, without prior written permission. Permission can be requested from either ISO at the address below or ISO's member body in the country of the requester.

ISO copyright office
Ch. de Blandonnet 8 • CP 401
CH-1214 Vernier, Geneva, Switzerland
Tel. +41 22 749 01 11
Fax +41 22 749 09 47
copyright@iso.org
www.iso.org

Contents

Page

Foreword	iv
Introduction	v
1 Scope	1
2 Normative references	1
3 Requirements	1
3.1 Qualification.....	1
3.1.1 Manufacturer qualification.....	1
3.1.2 Product qualification.....	2
3.2 Materials.....	2
3.2.1 Fittings.....	2
3.2.2 Tubing.....	2
3.2.3 Testfluid.....	2
3.3 Environmental conditions.....	3
3.3.1 Pressures.....	3
3.3.2 Temperature.....	3
3.4 Design and manufacture.....	3
3.4.1 Fluid passages.....	3
3.5 Performance.....	3
3.5.1 Specimen preparation.....	3
3.5.2 Proof pressure.....	4
3.5.3 Gaseous pressure.....	4
3.5.4 Hydraulic impulse resistance.....	4
3.5.5 Ultimate pressure.....	5
3.5.6 Flexure fatigue resistance.....	5
3.5.7 Re-use capability.....	5
3.5.8 Tensile load capability.....	6
3.5.9 Thermal shock.....	6
3.5.10 Over-tightening.....	6
3.5.11 Electrical conductivity.....	6
3.5.12 Salt spray.....	7
3.5.13 Vibration.....	7
3.5.14 Fire test.....	11
3.5.15 System pressure test.....	11
3.5.16 Fuel ageing.....	12
3.5.17 Hydraulic fluid ageing.....	12
3.5.18 Tube twisting.....	12
3.5.19 Fitting/tube rotation torque.....	13
3.5.20 Stress corrosion.....	14
3.5.21 Lightning strike.....	16
Annex A (normative) Equivalent materials and processes	18
Bibliography	20

Foreword

ISO (the International Organization for Standardization) is a worldwide federation of national standards bodies (ISO member bodies). The work of preparing International Standards is normally carried out through ISO technical committees. Each member body interested in a subject for which a technical committee has been established has the right to be represented on that committee. International organizations, governmental and non-governmental, in liaison with ISO, also take part in the work. ISO collaborates closely with the International Electrotechnical Commission (IEC) on all matters of electrotechnical standardization.

The procedures used to develop this document and those intended for its further maintenance are described in the ISO/IEC Directives, Part 1. In particular the different approval criteria needed for the different types of ISO documents should be noted. This document was drafted in accordance with the editorial rules of the ISO/IEC Directives, Part 2 (see www.iso.org/directives).

Attention is drawn to the possibility that some of the elements of this document may be the subject of patent rights. ISO shall not be held responsible for identifying any or all such patent rights. Details of any patent rights identified during the development of the document will be in the Introduction and/or on the ISO list of patent declarations received (see www.iso.org/patents).

Any trade name used in this document is information given for the convenience of users and does not constitute an endorsement.

For an explanation on the meaning of ISO specific terms and expressions related to conformity assessment, as well as information about ISO's adherence to the WTO principles in the Technical Barriers to Trade (TBT) see the following URL: [Foreword - Supplementary information](#)

The committee responsible for this document is ISO/TC 20, *Aircraft and space vehicles*, Subcommittee SC 10, *Aerospace fluid systems and components*.

Introduction

This International Standard establishes the basic performance for 5 080 psi (35 000 kPa) tube fitting assemblies used in aerospace fluid systems.

The test requirements are intended to satisfy the most strenuous demands encountered in a high-performance aircraft hydraulic system.

International Standards use the International System of units (SI); however, large segments of the aerospace industry make use of other measurement systems as a matter of common working practice.

All dimensions and units used in this International Standard are given in SI units, with other units also indicated for the convenience of the user.

The decimal sign used in International Standards is the comma (","); however, the comma is not used in common working practice with non-SI dimensions. Therefore, in common with many other aerospace standards, the decimal point (".") is used in this International Standard when providing dimensions in inch-pound units.

NOTE The use of non-SI units and the decimal point in this International Standard does not constitute general acceptance of measurement systems other than SI within International Standards.

Aerospace series — Tube fittings for fluid systems, 5 080 psi (35 000 kPa) — Qualification specification

1 Scope

This International Standard specifies performance and quality requirements for the qualification and manufacture of standard tube fittings to ensure reliable performance in aircraft hydraulic 5 080 psi (35 000 kPa) systems.

This International Standard specifies baseline criteria for the design and manufacture of system fittings that are qualification tested on engines.

This International Standard covers fittings from size -04 to -20 used for the following:

- separable/permanent pipe end fittings;
- permanent connection fittings;
- separable connection fittings.

This International Standard covers fittings of the temperature types and pressure classes specified in ISO 6771.

2 Normative references

The following documents, in whole or in part, are normatively referenced in this document and are indispensable for its application. For dated references, only the edition cited applies. For undated references, the latest edition of the referenced document (including any amendments) applies.

ISO 2685, *Aircraft — Environmental test procedure for airborne equipment — Resistance to fire in designated fire zones*

ISO 6772, *Aerospace — Fluid systems — Impulse testing of hydraulic hose, tubing and fitting assemblies*

ISO 6773, *Aerospace — Fluid systems — Thermal shock testing of piping and fittings*

ISO 7137, *Aircraft — Environmental conditions and test procedures for airborne equipment*

ISO 7257, *Aircraft — Hydraulic tubing joints and fittings — Rotary flexure test*

ISO 10583:1993, *Aerospace fluid systems — Test methods for tube/fitting assemblies*

EUROCAE ED-14E/RTCA DO-160E, Section 22, *Lightning Induced transient Susceptibility*

3 Requirements

3.1 Qualification

Fittings claiming conformity with this International Standard shall be representative of products, which have successfully met the requirements and have passed the tests in this International Standard.

3.1.1 Manufacturer qualification

Manufacturer approval shall be granted by purchaser qualification procedure.

Outside agency procedure can be used if no specific procedure exists (see [Annex A, Table A.3, Procedure 1](#)).

3.1.2 Product qualification

Product approval shall be granted by purchaser qualification procedure.

Outside agency procedure can be used if no specific procedure exists (see [Annex A, Table A.3, Procedure 1](#)).

3.2 Materials

3.2.1 Fittings

Fitting parts shall be manufactured from materials as given in [Table 1](#) or equivalent passing the specified tests. The various materials shall be used according to the pressure and temperature requirements of the system, as shown in [Table 2](#).

Table 1 — Materials for fittings

Material	Type ^a	Material code	Starting stock
Titanium alloy	I, II, III	T	Bar, forgings, or rings
Corrosion-resistant steel	I, II, III, IV	V	Bar, forgings, or rings
Other	To be defined	To be defined	To be defined

^a Temperature types and system pressure classes are defined in ISO 6771.

Magnesium and magnesium alloy shall not be used.

3.2.2 Tubing

Table 2 — Materials for tubing

Material	Material code	Starting stock
Titanium alloy	T	Hollows
Corrosion-resistant steel	V	Hollows
Other	To be defined	To be defined

3.2.3 Testfluid

Unless otherwise specified, fluid for testing shall be used in accordance with [Annex A, Table A.1](#).

3.3 Environmental conditions

3.3.1 Pressures

Table 3 — Pressure test requirements, 35 000 kPa (5 080 psi) fittings

Dimensions in SI-metric (and imperial) units

Fitting and tube size ^a	Design operating pressure (DOP)		Proof pressure (2 × DOP)		Burst pressure (3 × DOP)	
	kPa	(psi)	kPa	(psi)	kPa	(psi)
04	35 000	(5 080)	70 000	(10 160)	105 000	(15 240)
06						
08						
10						
12						
16						
20						

^a Dash size in 1/16 in, example: 08 = 8/16 in diameter.

3.3.2 Temperature

3.3.2.1 Ambient Air: -54 °C to +135 °C

3.3.2.2 Hydraulic Fluid: -54 °C to +135 °C

3.4 Design and manufacture

3.4.1 Fluid passages

On fittings where the fluid passage is drilled from each end, the offset between the drilled holes at the meeting point shall not exceed 0,25 mm (0.10 in). It shall be possible to pass through the fitting passage a ball whose diameter is 0,37 mm (0.015 in) less than the minimum diameter specified for the passage.

Angular misalignment shall not exceed 1° for straight fittings and 2° for shaped fittings.

3.5 Performance

The tubing/fitting assembly shall be capable of meeting the performance requirements specified in [3.5.1](#) to [3.5.21](#).

3.5.1 Specimen preparation

Test specimens shall be assembled as specified in [Table 11](#). Sleeve installations on the tube end shall be in accordance with user instructions.

The fitting shall be assembled to tightening torques given by purchaser procurement specification, using the maximum installing torque for half of the test specimens and the minimum torque for the other half.

3.5.1.1 Lubricants

Hydraulic system fittings shall be assembled using system fluid as lubricant on the union thread and sleeve shoulder only. No lubricant on the sealing surfaces (especially during pneumatic leakage testing) is allowed.

3.5.1.2 Qualification inspection

Test assemblies shall consist of the parts specified in [3.5.1](#). Tests shall be conducted in accordance with [Table 11](#) and with ISO 10583 for each size and material for which qualification is required.

Fittings claiming conformity with this specification shall be considered qualified if they are manufactured to the same dimensions, using the same materials and processes as products that have successfully met the requirements and have passed the tests in this specification.

3.5.2 Proof pressure

When testing in accordance with ISO 10583:1993, 5.1, the test assembly shall withstand the proof pressure specified in [Table 3](#) without leakage, evidence of permanent deformation, or other malfunction that might affect the ability to disconnect or connect the joint in the normal manner (to the interface point by hand and then using the specified range of torque values).

Specimens to be proof tested are given in [Table 11](#).

3.5.3 Gaseous pressure

When tested in accordance with ISO 10583:1993, 5.2, assemblies shall pass the gaseous pressure test to the DOP specified in [Table 3](#) without leakage or other failure.

Specimens to be gaseous pressure tested are given in [Table 11](#).

3.5.4 Hydraulic impulse resistance

Six specimens shall be tested with the following distribution:

- 2 non aged specimens;
- 2 fuel aged specimens as per [3.5.16](#);
- 2 hydraulic fluid aged specimens as per [3.5.17](#).

When tested in accordance with ISO 6772 and ISO 10583:1993, 5.3, the test assembly shall withstand, without leakage, 300 000 impulse pressure cycles with pressure peaks specified and temperatures in [Table 4](#).

Table 4 — Peak pressure and temperature

Peak pressure % of nominal pressure	Peak pressure kPa (psi)	Maximum ambient temperature	Minimum ambient tem- perature
150	52 500 (7 620)	+94 °C (+201 °F)	-40 °C (-40 °F)

After hydraulic impulse test, three specimens (1 non aged, 1 fuel aged, and 1 hydraulic fluid aged) shall be tested at nominal torque and pass the pressure tests as per [3.5.3](#) and [3.5.15](#).

For margin evaluation, testing is to be continued on the other three specimens at +110 °C (+230 °F) up to failure or completion 450 000 cycles.

Specimens which passed these additional cycles shall pass to minimum burst pressure test as per [3.5.5](#).

Specimens to be impulse tested are given in [Table 11](#).

3.5.5 Ultimate pressure

When tested as follows, the test assemblies shall be pressurized to the burst pressure specified in [Table 3](#) and held at that pressure for 3 min after stabilization of the pressure. The pressure shall then be increased at a rate of 137 894 kPa/min \pm 34 474 kPa/min (20 000 psi/min \pm 5 000 psi/min) until failure occurs. No burst, slippage, leakage, or other failure shall occur at a pressure below 4 \times DOP.

Seven specimens shall be tested to failure with the following distribution:

- Two non aged specimens shall be tested at +94 °C (+201 °F).
- Two aged specimens after salt spray as per [3.5.11](#) at +94 °C (+201 °F).
- Three specimens from hydraulic impulse resistant ([3.5.3](#)) at room temperature.

Specimens to be ultimate pressure tested are given in [Table 11](#).

3.5.6 Flexure fatigue resistance

When tested in accordance with ISO 7257 and ISO 10583:1993, 5.5, test assemblies shall not fail.

Eight specimens with straight unions shall be tested. Two specimens shall withstand 10⁷ flexure cycles with a bending stress level defined in [Table 5](#). The other specimens shall be used to produce a S-N curve as described in ISO 7257.

Table 5 — Test requirements for testing on titanium pipes

Fitting size	DOP		Dynamic bending stress for titanium tubes ^a	
	kPa	(psi)	+0 %/-10 % kPa	(psi)
04	35 000	(5 080)	137 900	(20 000)
06			131 000	(19 000)
08			124 100	(18 000)
10			117 200	(17 000)
12			110 300	(16 000)
16			103 400	(15 000)
20			96 500	(14 000)

^a Bending stresses for other tube materials shall be calculated with the same deflection.

Specimens to be fatigue flexure tested are given in [Table 11](#).

3.5.7 Re-use capability

Two specimens shall be tested (only end fittings and separable fittings shall be tested).

When tested in accordance with ISO 10583:1993, 5.7.2, there shall be none of the following defects:

- leakage during any of the proof pressure tests, when tested in accordance with [3.5.2](#);
- inability to assemble the fitting to the interface point by hand;
- nut deformation preventing engagement of the nut hexagon with an open-end wrench;
- gaseous leakage following final assembly, when tested in accordance with [3.5.3](#).

Specimens to be re-use tested are given in [Table 11](#).

3.5.8 Tensile load capability

Unless otherwise specified in the purchaser procurement specification, when tested in accordance with ISO 10583:1993, 5.8, assemblies shall withstand, without pressure, the axial loads specified in [Table 6](#) without rupture.

Table 6 — Minimum tensile strength

Fitting size ^a	Tube outside diameter		Tensile strength	
	Mm	(in)	N	(lbs)
04	6,35	(0.250)	4 895	(1 100)
06	9,53	(0.375)	12 460	(2 244)
08	12,7	(0.500)	20 915	(4 700)
10	15,88	(0.625)	35 155	(7 900)
12	19,05	(0.750)	52 955	(11 900)
16	25,4	(1.000)	74 537	(16 750)
20	31,75	(1.250)	112 000	(25 169)

^a Dash size in 1/16 in, example: 08 = 8/16 inch diameter.

Specimens to be tensile tested are given in [Table 11](#).

3.5.9 Thermal shock

Test procedure and acceptance criteria are described in ISO 6773. Two specimens shall be tested.

Temperatures used shall be:

- High temperature: +94 °C (+201 °F)
- Low temperature: -40 °C (-40 °F)

Specimens to be thermal shock tested are given in [Table 11](#).

3.5.10 Over-tightening

Two specimens shall be tested (only end fittings and separable fittings shall be tested).

When tightened with 1,5 times the nominal tightening torque specified in [Table A.4](#) or 1,5 times the maximum torque tightening as defined by the purchaser, there shall be none of the following defects:

- leakage during proof pressure test (see [3.5.2](#));
- leakage during gaseous pressure test (see [3.5.3](#)).

Specimens to be over tightening tested are given in [Table 11](#).

3.5.11 Electrical conductivity

The aim of this test is to measure the electrical conductivity before and after the salt spray test (see [3.5.12](#)).

Specimens shall be assembled with the minimum torque values specified in [Table A.4](#).

Two specimens shall be tested.

A resistance of 10 mΩ maximum is permissible between two tubes connected to the fitting.

Each measurement shall be carried out twice for each test sample in order to confirm the value.

Milli-Ohm-meter with 4-measurement test points can be used with a direct current of 1 A minimum with measurement accuracy of 1 %.

Specimens to be electrical conductivity tested are given in [Table 11](#).

3.5.12 Salt spray

Unless otherwise specified, a salt spray test according to ISO 7137, test procedure 1.9, shall be performed with two specimens of each size for a minimum of 56 days.

ISO 7137 procedure: the exposure to the salt fog for a period of 48 hours and then the storage in an ambient temperature for 48 hours for drying, should be repeated in order to reach a minimum of 56 days.

These specimens shall be subjected to electrical conductivity test and minimum burst pressure test as per [3.5.11](#) and [3.5.5](#).

Specimens to be salt spray tested are given in [Table 11](#).

3.5.13 Vibration

3.5.13.1 Test assembly configuration

Test assemblies shall be installed on a test fixture as illustrated in [Figure 1](#) and [Table 7](#).

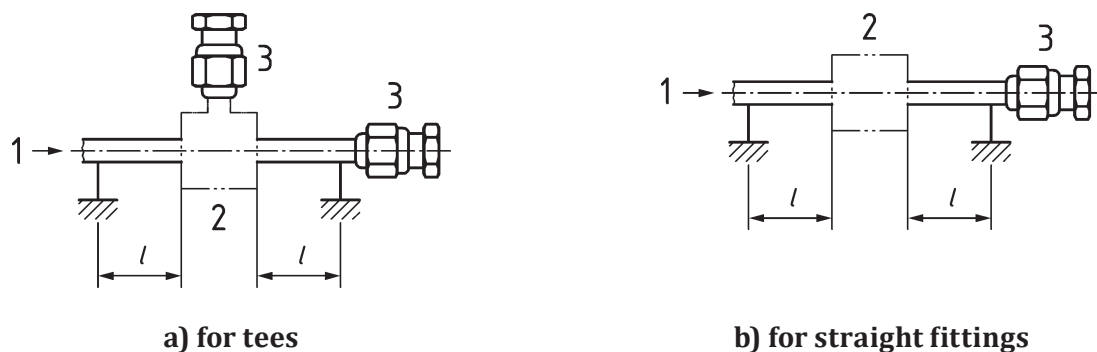

Key

- 1 pressure inlet
- 2 fitting
- 3 plug

Figure 1 — Vibration test setup

Table 7 — Lengths of tubes

Fitting size	Length, <i>L</i>	
	mm	(in)
04	180	(7.1)
06	220	(8.7)
08	250	(9.8)
10	280	(11)
12	310	(12.2)
16	355	(14)
20	400	(15.7)

The test assemblies shall be filled with hydraulic fluid and pressurized to nominal operating pressure.

After exposure to the vibration test, the equipment shall be inspected and shall show no evidence of structural failure of the tube or fitting. The presence of a detectable crack constitutes a vibration test failure. There shall be no leakage of hydraulic fluid.

3.5.13.2 Standard vibration test

Up to six assemblies will be tested in accordance with the RTCA/DO-160E, section 8 with a vibration level depending on the aircraft area concerned, category R and H curves.

Table 8 — Standard area/Curves requirements

Aircraft area	RTCA/DO-160E, Section 8 Curves	Number of assemblies
Wing and wheel well	E, E1 and P (Noted series S1)	2
Nacelle and pylon	D, D1 and P (Noted series S2)	2
Landing gear, engine, and gearbox	P and W (Noted series S3)	2

The test procedure used shall be “Robust vibration test procedure-fixed-wing aircraft”.

The size sample/aircraft area distribution shall be provided by purchaser procurement specification.

3.5.13.2.1 Test reduction for standard test procedure

A test reduction can be achieved by running tests according to the following series/aircraft areas.

Table 9 — Reduction — Standard area/Curves requirements

Aircraft area	RTCA/DO-160E, Section 8 Curves	Number of assemblies
Wing, wheel well, nacelle, and pylon	(E U D), (E1 U D1), and P (Noted series S4 = S1 & S2)	2
Wing, wheel well, nacelle, pylon, landing gear, engine, and gearbox	(E U D), (E1 U D1), P, and W (Noted series S5 = S1 & S2 & S3)	2

Where (E U D) and (E1 U D1) are defined in [Figures 2](#) and [3](#), size sample/aircraft area distribution shall be provided by purchaser procurement specification.

NOTE [Figures 2](#) and [3](#) are explanatory only, for accurate values, refer to RTCA DO 160E.

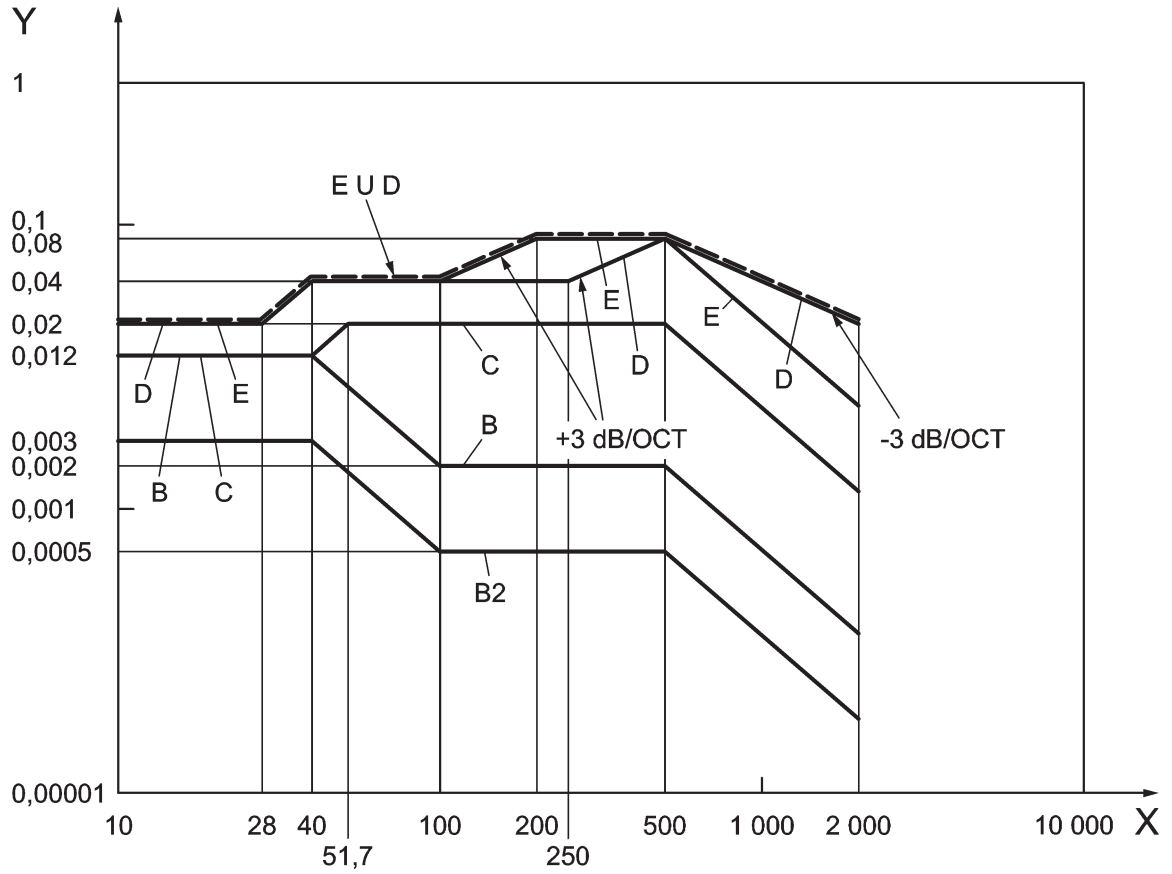

Key

X frequency (Hz)

Y acceleration power spectral density (g^2/Hz)

Figure 2 — Curve E U D

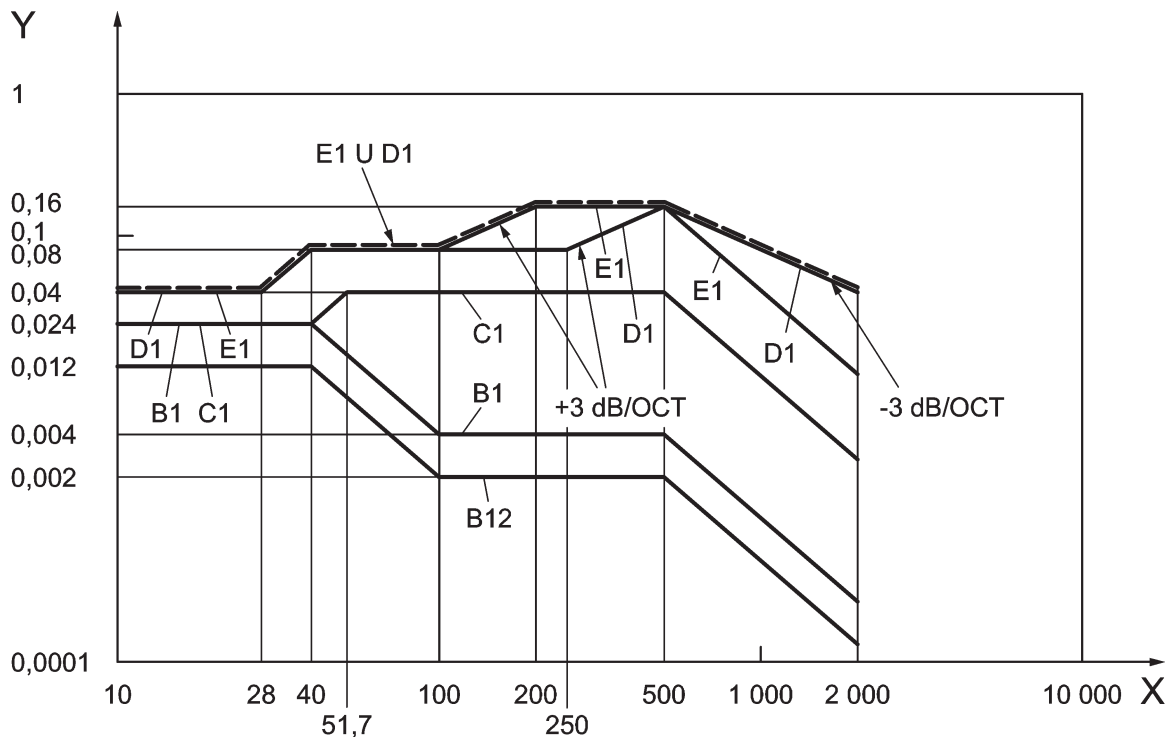

Key

- X frequency (Hz)
- Y acceleration power spectral density (g^2/Hz)

Figure 3 — Curve E1 U D1

3.5.13.3 Alternative vibration test

Test assemblies shall be vibration tested as specified in RTCA/DO-160E, section 8, categories R and H for fixed-wing aircraft, using the robust sinusoidal test procedure except as follows.

- a) Performance testing is not applicable.
- b) Two test assemblies of each size shall be tested using modified curve W, as specified in [Figure 4](#), and curve P, as defined in RTCA/DO-160E.
- c) If the test assemblies are axisymmetric, testing needs to be performed in only 1 axis perpendicular to the tube centreline.

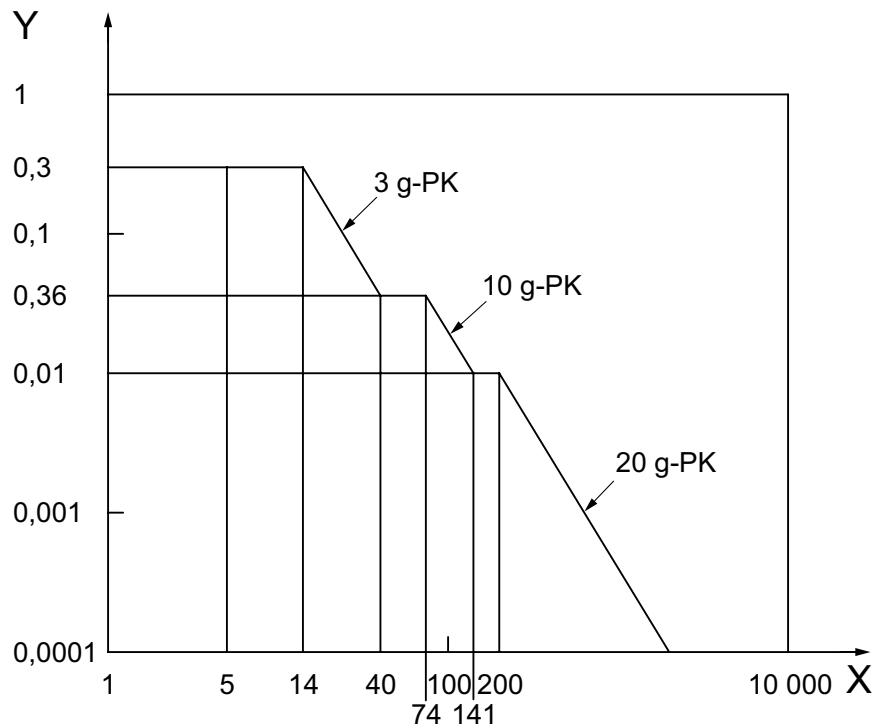

Key

- X frequency (Hz)
- Y double amplitude (peak-to-peak) (inches)

Figure 4 — Curve W — Type 1

3.5.13.4 Windmilling

If required, windmilling justifications shall meet requirements specified in purchaser procurement specification.

3.5.14 Fire test

The test method is specified in ISO 2685.

Three specimens shall be tested at the DOP without flow rate or at critical operational conditions.

The critical operational conditions shall be provided by purchaser procurement specification in terms of

- pressure (psi),
- flow rate (l/min), and
- duration: fire resistant (5 min) or fire proof (15 min).

The entire fitting connection plus a length of tubing shall be subjected to flame.

Specimens to be fire tested are given in [Table 11](#).

3.5.15 System pressure test

Two specimens shall be pressurized with hydraulic fluid to 345 kPa to 414 kPa (50 psi to 60 psi) for 24 hours, then to nominal pressure for additional 24 hours. Assemblies shall be checked at the beginning, during, and after the test by wiping suspect areas with a finger, using white gloves.

This test shall be performed after hydraulic impulse resistant (3.5.4), flexure fatigue resistance (3.5.6), and vibration test (3.5.13)

Specimens to be system pressure tested are given in Table 11.

3.5.16 Fuel ageing

Two specimens shall be fuel aged before impulse test.

Specimens shall be filled with test fluid and pressurized to nominal pressure and, while maintaining this pressure at room temperature, the specimens shall be immersed in the fluid specified in Table 10 for 8 h to 10 h, then allowed to air dry for 1 h. Then the specimens will be aged at -54 °C (-65,2 °F) in air for 8 h to 10 h.

This sequence of fluid immersion and low temperature exposure shall be repeated 20 times.

Fuel shall be used according to Annex A, Table A.2.

Fluids used shall be according to Table 10:

Table 10 — Fluids for fuel ageing

Sequence	1	2	3	4	5	6	7	8	9	10	11	12	13	14	15	16	17	18	19	20
Fluid used	F	F	F	W	F	F	F	W	F	F	F	W	F	F	F	W	F	F	F	W
F: fuel																				
W: water																				

Specimens to be fuel ageing tested are given in Table 11.

3.5.17 Hydraulic fluid ageing

Two specimens shall be hydraulic fluid aged before impulse test.

Specimens shall be filled with test fluid and pressurized to nominal pressure and, while maintaining this pressure at room temperature, the specimens shall be immersed in hydraulic test fluid as specified in Table A.1 for 8 min to 10 min, then allowed to air dry for 1 h. Then, the specimens will be aged at 135 °C (275 °F) in air for 8 h to 10 h.

This sequence of hydraulic fluid soaking and high temperature exposure shall be repeated 10 times.

NOTE During high temperature exposure, pressure inside specimens shall not be greater than nominal pressure.

Specimens to be hydraulic fluid ageing tested are given in Table 11.

3.5.18 Tube twisting

Two specimens shall be tested (only end fittings and separable fittings shall be tested).

A fitting, with threaded separable end, (item 1) shall be held vertically into a vise or any other equivalent mean as illustrated in Figure 5.

Drive the sleeve (2) into the cone. Tighten the nut by hand up to contact, holding the tube (4) with the other hand. Note the tube angular position by any suitable mean. Tighten the nut (3) with a torque wrench using maximum torque value specified in purchaser procurement specification, tube end free. Record the tube twisting value. Loosen the nut by one turn without disconnecting. Tighten again the nut by hand up to contact. Record the tube orientation. Tighten again to maximum specified torque and record the tube twisting value.

Second tube twisting angle shall not be higher than 2 degrees.

Test report will provide recorded values at first and second step.

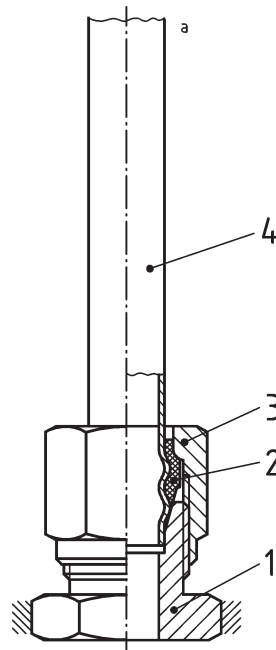

Key

- 1 fitting with threaded separable end
- 2 sleeve
- 3 nut
- 4 tube
- a Measure torque at the union end of the tube with a tell-tale dial.

Figure 5 — Tube twisting

Specimens to be tube twisting tested are given in [Table 11](#).

3.5.19 Fitting/tube rotation torque

Two specimens shall be tested (only end fittings and separable fittings shall be tested).

Separable connections shall be double tightened as follows:

- Tighten the nut to the tightening torque specified in purchaser procurement specification.
- Loosen by one turn the nut without disconnecting.
- Tighten the nut to the tightening torque specified in purchaser procurement specification.

Torque applied to the tube shall be applied at a maximal distance from the fitting of 254 mm (10 in) (See [Figure 6](#)).

First step:

- Apply 1,5 times the specified torque to the tube in a counter-clockwise direction. No tube rotation or nut loosening is allowed.

Second step:

- Apply a clockwise torque to the tube until the tube fails. This failure torque shall not be lower than 1,5 times the specified torque.

Tube rotation in the fitting or fitting rotation is considered as a failure.

Test report will provide ultimate recorded values.

Dimensions in millimetres

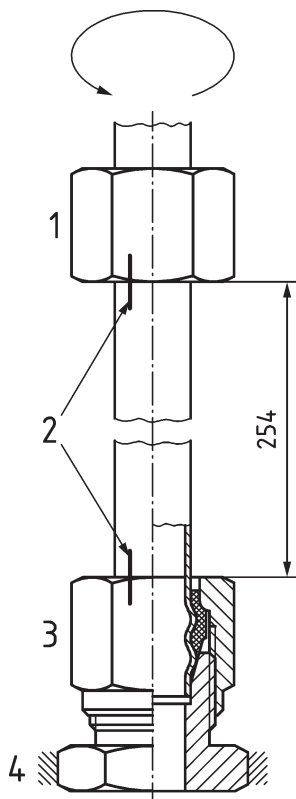

Key

- 1 torque application area
- 2 mark
- 3 nut
- 4 vise holding

Figure 6 — Rotation torque

Specimens to be fitting/tube rotation torque tested are given in [Table 11](#).

3.5.20 Stress corrosion

Two specimens shall be tested as per ISO 10583:1993, 5.6.

Test samples shall be installed in a test apparatus as shown in [Figure 7](#).

Test assemblies shall be representative of the adverse tolerances giving the maximum stress on the fitting.

Specimens to be stress corrosion tested are given in [Table 11](#).

Dimensions in millimetres

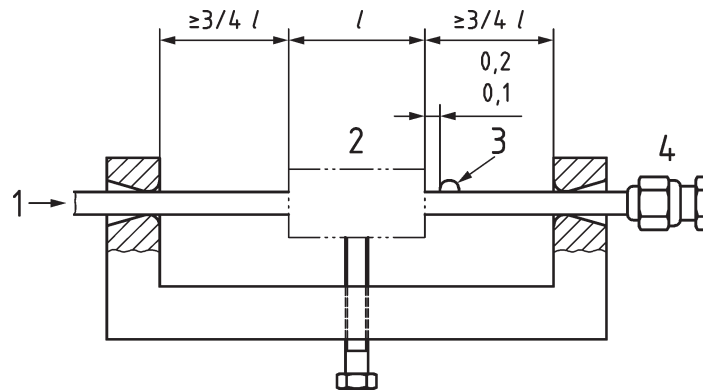

a) Straight fitting test setup

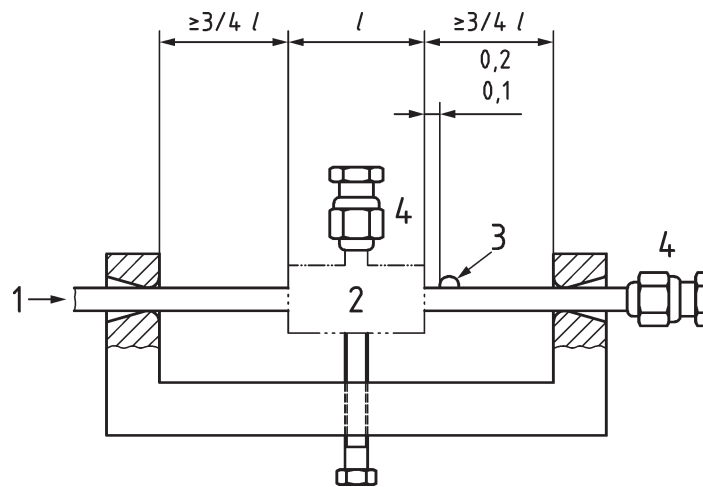

b) Tee fitting test setup

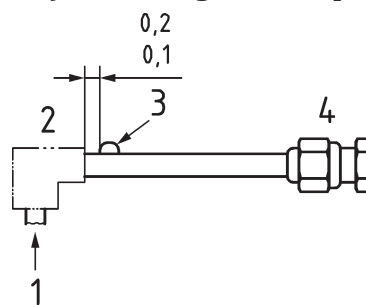

c) Elbow fitting test setup

Key

- 1 pressure inlet
- 2 fitting
- 3 strain gauge
- 4 plug

Figure 7 — Stress corrosion test setup

3.5.21 Lightning strike

NOTE This requirement pertains to commercial jet aircraft of composite construction.

The torqued fitting assemblies as described in [Figure 8](#) shall be tested as follows:

- a) Torque the fittings to the values shown in purchaser procurement specification.
- b) Gaseous pressure test in accordance with [3.5.3](#). There shall be no leakage.
- c) Lightning strike 12X, 6 at polarity A, 6 at polarity B, in accordance with EUROCAE ED-14E/RTCA DO-160E, Section 22 Current Waveform 1 with a peak of 7 500 A, instantaneously followed by a 32 A DC pulse for 0,25 s.
- d) Proof pressure test accordance with [\(3.5.2\)](#). There shall be no leakage.

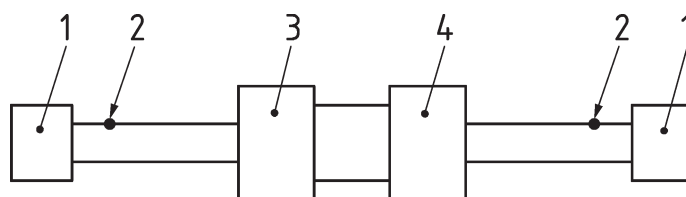

Key

- 1 end fitting
- 2 electrical contact
- 3 swaged fitting, wired-on nut
- 4 swaged fitting, union end

Figure 8 — Lightning strike test specimen, tube fitting assembly

Specimens to be lightning strike tested are given in [Table 11](#).

Table 11 — Testing and test samples for qualifications

Test	Test procedure	Specimen number																													
		1	2	3	4	5	6	7	8	9	10	11	12	13	14	15 to 20	21	22	23	24	25	26	27 to 32	33	34	35	36	37 to 40	41 to 43		
Inspection	3.5.1	1	1	1	1	1	1	1	1	1	1	1	1	1	1	1	1	1	1	1	1	1	1	1	1	1	1	1	1	1	
Proof pressure	3.5.2	2;4	2;4	2;4	2	2	2	2	2	2	2	2	2	2	2	2	2	2	2	2	2	2	2	2	2	2	2	2	2	2	
Gaseous pressure	3.5.3	5	5	5	5	5	5	5	5	4																				2	
Impulse	3.5.4				4	4	4	4	4	3	3																				
Ultimate pressure test	3.5.5				5	7	5	7	4	6	4	4	6	6																4	4
Flexure	3.5.6																														
Re-use	3.5.7		3	3																											
Tensile load	3.5.8																			2	2										
Thermal shock	3.5.9																														
Over-tightening	3.5.10	3	3																												
Conductivity	3.5.11																														
Salt spray	3.5.12																														
Vibration ^a	3.5.13																														
Fire	3.5.14																														
System pressure	3.5.15																														
Fuel ageing	3.5.16																														
Hydraulic fluid ageing	3.5.17																														
Tube twisting	3.5.18																														
Rotation torque	3.5.19																														
Stress corrosion	3.5.20																														
Lightning strike	3.5.21																														

Bolt figures are for tests run up to rupture or specimens subjected to additional tests.

^a Standard method requires up to 6 specimens and only 2 are required for alternate method.

NOTE The numbers in the main body define the order of the test sequences of specimens.

Instructions: Test shall be performed in the order defined by the numbers in the main body.

Annex A (normative)

Equivalent materials and processes

International Standards giving specifications for appropriate hydraulic fluids or fuels to be used in tube fitting assemblies in aircraft fluid systems are not currently available. For the time being, materials specified in national standards are given in [Table A.1](#) and [A.2](#). Eventually, references to national standards will be deleted and replaced by references to International Standards when they become available.

Table A.1 — Hydraulic fluids for testing

Specification	Fluid
US MILITARY	MIL-PRF-83282 RevD97
FRANCE	AIR-3520 - H515

Table A.2 — Fuels for fuel ageing

Specification	Fuel
US MILITARY	MIL-DTL-5624 Rev T98: JP-5
	MIL-DTL-83133 Rev E99: JP-8
US ATM	ASTM-D-1655-00: JET A
	ASTM-D-1655-00: JET A1
FRANCE	AIR-3404
	AIR-3405
UK	DEF STAN 91-86 (NATO F44)
	DEF STAN 91-91 (Jet A1, NATO F35)
RUSSIAN	GOST 10227-86: RT
	GOST 10227-86: TS-1
CHINESE	N°3 Jet Fuel

Table A.3 — Equivalent procedures

Procedure No.	ASD regional procedure	USA Aerospace industry procedure
1 (Manufacturer)	EN 9100	AS 7003/AS7112
2 (Product)	EN 9133	PRI PD-2101

Table A.4 — Torque tightening values for 35 000 kPa (5080 psi) systems

ITEM CODE No.	Min. Torque Nm	Nom. Torque Nm	Max. Torque Nm
04	10	12,5	15
06	20	22,5	25
08	45	50	55
10	60	66,5	73

NOTE Please use the nominal torque tightening value.

Table A.4 (continued)

ITEM CODE No.	Min. Torque Nm	Nom. Torque Nm	Max. Torque Nm
12	80	89	98
16	100	111	122
20	115	128	141
NOTE Please use the nominal torque tightening value.			

Bibliography

- [1] ISO 2859-1, *Sampling procedures for inspection by attributes — Part 1: Sampling schemes indexed by acceptance quality limit (AQL) for lot-by-lot inspection*
- [2] ISO 3161, *Aerospace — UNJ threads — General requirements and limit dimensions*
- [3] ISO 4287, *Geometrical Product Specifications (GPS) — Surface texture: Profile method — Terms, definitions and surface texture parameters*
- [4] ISO 6771, *Aerospace — Fluid systems and components — Pressure and temperature classifications*
- [5] ISO 8575, *Aerospace — Fluid systems — Hydraulic system tubing*

British Standards Institution (BSI)

BSI is the national body responsible for preparing British Standards and other standards-related publications, information and services.

BSI is incorporated by Royal Charter. British Standards and other standardization products are published by BSI Standards Limited.

About us

We bring together business, industry, government, consumers, innovators and others to shape their combined experience and expertise into standards-based solutions.

The knowledge embodied in our standards has been carefully assembled in a dependable format and refined through our open consultation process. Organizations of all sizes and across all sectors choose standards to help them achieve their goals.

Information on standards

We can provide you with the knowledge that your organization needs to succeed. Find out more about British Standards by visiting our website at bsigroup.com/standards or contacting our Customer Services team or Knowledge Centre.

Buying standards

You can buy and download PDF versions of BSI publications, including British and adopted European and international standards, through our website at bsigroup.com/shop, where hard copies can also be purchased.

If you need international and foreign standards from other Standards Development Organizations, hard copies can be ordered from our Customer Services team.

Subscriptions

Our range of subscription services are designed to make using standards easier for you. For further information on our subscription products go to bsigroup.com/subscriptions.

With **British Standards Online (BSOL)** you'll have instant access to over 55,000 British and adopted European and international standards from your desktop. It's available 24/7 and is refreshed daily so you'll always be up to date.

You can keep in touch with standards developments and receive substantial discounts on the purchase price of standards, both in single copy and subscription format, by becoming a **BSI Subscribing Member**.

PLUS is an updating service exclusive to BSI Subscribing Members. You will automatically receive the latest hard copy of your standards when they're revised or replaced.

To find out more about becoming a BSI Subscribing Member and the benefits of membership, please visit bsigroup.com/shop.

With a **Multi-User Network Licence (MUNL)** you are able to host standards publications on your intranet. Licences can cover as few or as many users as you wish. With updates supplied as soon as they're available, you can be sure your documentation is current. For further information, email bsmusales@bsigroup.com.

Revisions

Our British Standards and other publications are updated by amendment or revision.

We continually improve the quality of our products and services to benefit your business. If you find an inaccuracy or ambiguity within a British Standard or other BSI publication please inform the Knowledge Centre.

Copyright

All the data, software and documentation set out in all British Standards and other BSI publications are the property of and copyrighted by BSI, or some person or entity that owns copyright in the information used (such as the international standardization bodies) and has formally licensed such information to BSI for commercial publication and use. Except as permitted under the Copyright, Designs and Patents Act 1988 no extract may be reproduced, stored in a retrieval system or transmitted in any form or by any means – electronic, photocopying, recording or otherwise – without prior written permission from BSI. Details and advice can be obtained from the Copyright & Licensing Department.

Useful Contacts:

Customer Services

Tel: +44 845 086 9001

Email (orders): orders@bsigroup.com

Email (enquiries): cservices@bsigroup.com

Subscriptions

Tel: +44 845 086 9001

Email: subscriptions@bsigroup.com

Knowledge Centre

Tel: +44 20 8996 7004

Email: knowledgecentre@bsigroup.com

Copyright & Licensing

Tel: +44 20 8996 7070

Email: copyright@bsigroup.com

BSI Group Headquarters

389 Chiswick High Road London W4 4AL UK



...making excellence a habit.™