



BSI Standards Publication

Fine ceramics (advanced ceramics, advanced technical ceramics) — Test method for surface roughness of fine ceramic films by atomic force microscopy

National foreword

This British Standard is the UK implementation of ISO 19606:2017.

The UK participation in its preparation was entrusted to Technical Committee RPI/13, Advanced technical ceramics.

A list of organizations represented on this committee can be obtained on request to its secretary.

This publication does not purport to include all the necessary provisions of a contract. Users are responsible for its correct application.

© The British Standards Institution 2017.
Published by BSI Standards Limited 2017

ISBN 978 0 580 86440 7

ICS 81.060.30

Compliance with a British Standard cannot confer immunity from legal obligations.

This British Standard was published under the authority of the Standards Policy and Strategy Committee on 31 March 2017.

Amendments/corrigenda issued since publication

Date	Text affected
------	---------------

**Fine ceramics (advanced ceramics,
advanced technical ceramics) — Test
method for surface roughness of
fine ceramic films by atomic force
microscopy**

*Céramiques techniques — Méthode d'essai pour la rugosité de surface
des films céramique fins par microscopie à force atomique*





COPYRIGHT PROTECTED DOCUMENT

© ISO 2017, Published in Switzerland

All rights reserved. Unless otherwise specified, no part of this publication may be reproduced or utilized otherwise in any form or by any means, electronic or mechanical, including photocopying, or posting on the internet or an intranet, without prior written permission. Permission can be requested from either ISO at the address below or ISO's member body in the country of the requester.

ISO copyright office
Ch. de Blandonnet 8 • CP 401
CH-1214 Vernier, Geneva, Switzerland
Tel. +41 22 749 01 11
Fax +41 22 749 09 47
copyright@iso.org
www.iso.org

Contents

Page

Foreword	iv
Introduction	v
1 Scope	1
2 Normative references	1
3 Terms and definitions	1
4 Test environment	2
5 Roughness measurement specimens	2
6 Test apparatus	2
6.1 Cantilever.....	2
6.2 Scanner.....	2
6.3 Specimen stage.....	3
7 Test apparatus calibration	3
8 Probe-tip diameter evaluation standard plate	4
9 Calibration of X-Y and Z scan axes	4
10 Probe-tip error evaluation	5
10.1 Outline of probe-tip error evaluation.....	5
10.2 Measurements of preliminary <i>Ra</i> and <i>RSm</i>	6
10.3 Evaluation of probe-tip diameter.....	6
10.4 Evaluation of error in roughness measurements.....	8
11 Roughness measurements of specimen	13
12 Test report	14
Annex A (normative) Determination of <i>D</i> from <i>D'</i>	16
Annex B (informative) Method to determine criteria for probe-tip error	18
Bibliography	24

Foreword

ISO (the International Organization for Standardization) is a worldwide federation of national standards bodies (ISO member bodies). The work of preparing International Standards is normally carried out through ISO technical committees. Each member body interested in a subject for which a technical committee has been established has the right to be represented on that committee. International organizations, governmental and non-governmental, in liaison with ISO, also take part in the work. ISO collaborates closely with the International Electrotechnical Commission (IEC) on all matters of electrotechnical standardization.

The procedures used to develop this document and those intended for its further maintenance are described in the ISO/IEC Directives, Part 1. In particular the different approval criteria needed for the different types of ISO documents should be noted. This document was drafted in accordance with the editorial rules of the ISO/IEC Directives, Part 2 (see www.iso.org/directives).

Attention is drawn to the possibility that some of the elements of this document may be the subject of patent rights. ISO shall not be held responsible for identifying any or all such patent rights. Details of any patent rights identified during the development of the document will be in the Introduction and/or on the ISO list of patent declarations received (see www.iso.org/patents).

Any trade name used in this document is information given for the convenience of users and does not constitute an endorsement.

For an explanation on the meaning of ISO specific terms and expressions related to conformity assessment, as well as information about ISO's adherence to the World Trade Organization (WTO) principles in the Technical Barriers to Trade (TBT) see the following URL: www.iso.org/iso/foreword.html.

This document was prepared by Technical Committee ISO/TC 206, *Fine ceramics*.

Introduction

Surface roughness measurements of fine ceramic thin films in nanometer scale by atomic force microscopy have become one of the techniques widely applied to quality control and assurance in industries.

One of the problems most frequently occurring in roughness measurements by atomic force microscopy resulting from its scale dependency is the deviation of roughness due to the wear of the probe tip or the deviation in the curvature of commercially available probe tips. This problem makes it difficult to obtain a reliable and reproducible result of the roughness measurement. Therefore, it is highly desirable to standardize a method to evaluate probe tip diameter or curvature radius.

This document covers the evaluation of probe-tip diameter and provides a method to judge the adequateness of a probe tip for use in day-to-day roughness measurements of fine ceramic thin films with a certain arithmetical mean roughness in the range needing the use of atomic force microscopy in production lines or quality assurance processes.

It should be noted that because surface roughness is a scale-dependent metrology parameter, it is unavoidable that the probe-tip evaluation process contains some contradictory procedures, namely the adequateness of the probe tip for a roughness measurement depends on unmeasurable true roughness in a scale of interest.

In this document, the parameters based on roughness profiles are used. The roughness profile is obtained by using a low-pass filter according to ISO 16610-21. The process to obtain the sampling length, which is identical to cut-off wavelength, is given in ISO 4288. Some different sampling lengths to process a primary profile can be applied to obtain appropriate values of arithmetic mean deviation of a roughness profile, if necessary.

Fine ceramics (advanced ceramics, advanced technical ceramics) — Test method for surface roughness of fine ceramic films by atomic force microscopy

1 Scope

This document describes a method to evaluate the adequateness of a probe tip for fine-ceramic thin-film surface roughness measurements by atomic force microscopy, of surfaces with an arithmetical mean roughness, R_a , in the range of about 1 nm to 30 nm and a mean width of roughness profile elements, RS_m , in the range of about 0,04 μm to 2,5 μm .

2 Normative references

The following documents are referred to in the text in such a way that some or all of their content constitutes requirements of this document. For dated references, only the edition cited applies. For undated references, the latest edition of the referenced document (including any amendments) applies.

ISO 4287, *Geometrical Product Specifications (GPS) — Surface texture: Profile method — Terms, definitions and surface texture parameters*

ISO 4288, *Geometrical Product Specifications (GPS) — Surface texture: Profile method — Rules and procedures for the assessment of surface texture*

ISO 11039, *Surface chemical analysis — Scanning-probe microscopy — Measurement of drift rate*

ISO 11952, *Surface chemical analysis — Scanning-probe microscopy — Determination of geometric quantities using SPM: Calibration of measuring systems*

ISO 18115-2, *Surface chemical analysis — Vocabulary — Part 2: Terms used in scanning-probe microscopy*

ISO 25178-2, *Geometrical product specifications (GPS) — Surface texture: Areal — Part 2: Terms, definitions and surface texture parameters*

3 Terms and definitions

For the purposes of this document, the terms and definitions given in ISO 4287, ISO 4288, ISO 18115-2, ISO 11039, ISO 11952 and ISO 25178-2 and the following apply.

ISO and IEC maintain terminological databases for use in standardization at the following addresses:

- IEC Electropedia: available at <http://www.electropedia.org/>
- ISO Online browsing platform: available at <http://www.iso.org/obp>

3.1 evaluation length

$ln(X), ln(Y)$

length of surface profile in the X or Y direction

3.2 probe-tip diameter evaluation standard plate

plate on which needle-shaped spikes are formed

Note 1 to entry: The plate is used to evaluate the *probe-tip diameter* (3.3).

3.3 probe-tip diameter

D

diameter of a probe tip at a distance of 10 nm from the tip end

4 Test environment

Testing shall be carried out only where temperature change, sound noise and mechanical vibration of the floor or walls are small enough to perform the measurements. The following installation environment is recommended:

- a) temperature: 18 °C to 25 °C;
- b) humidity: 70 % or less;
- c) noise level: 60 dB or less;
- d) mechanical vibration of the floor or the wall: $1 \times 10^{-3} \text{ m/s}^2$ (<100 Hz) or less.

5 Roughness measurement specimens

Specimens for roughness measurements are ceramic thin films on a substrate. Any kinds of substrate material can be used, such as metal, glass, polymer, etc. The specimen shall be no larger than the specimen stage of the instrument being used.

6 Test apparatus

6.1 Cantilever

The cantilever shall be exclusively dedicated for a dynamic mode and commercially available. The resonant frequency should be higher than 100 kHz.

6.2 Scanner

The scanner shall be capable of scanning cantilever or specimen stage by shifting the *XYZ* position. The scanning area should be larger than $10 \mu\text{m} \times 10 \mu\text{m}$ in the *XY* plane.

[Figure 1](#) shows an example of a measurement system having a specimen stage scan mechanism. Position in the *Z* direction is controlled using a *Z*-position control circuit that keeps a constant separation between the probe and the specimen surface. For this purpose, a light beam from a laser diode illuminates the cantilever and the reflected beam position is monitored by a light detector. Surface profile is measured by scanning the specimen stage in the *XY* plane.

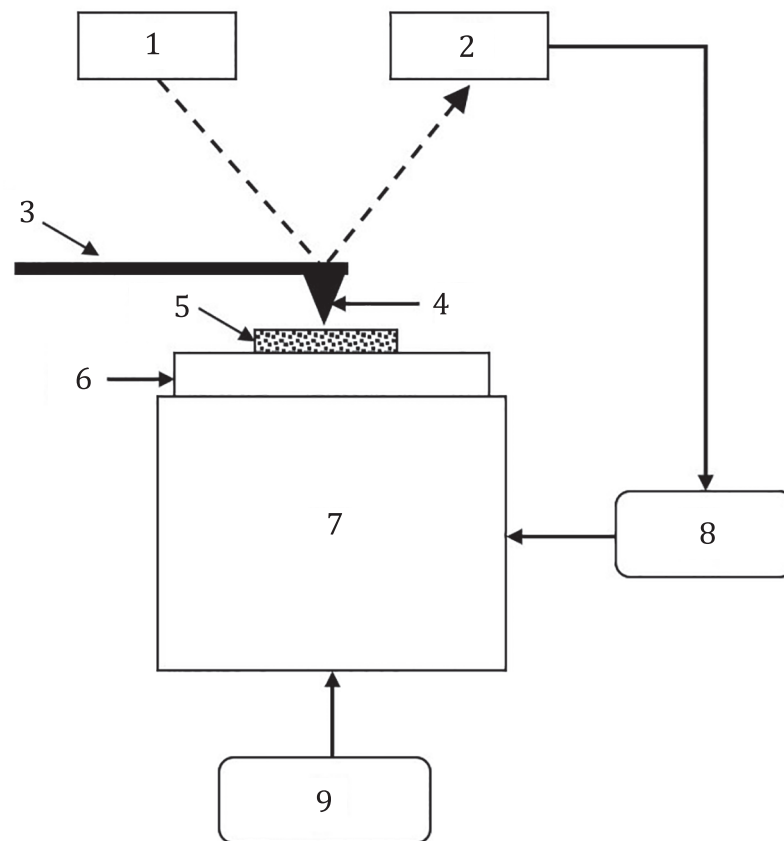

Key

- | | | | |
|---|----------------|---|----------------------------|
| 1 | laser diode | 6 | specimen stage |
| 2 | light detector | 7 | X, Y and Z scanner |
| 3 | cantilever | 8 | Z-position control circuit |
| 4 | probe tip | 9 | X-Y scan circuit |
| 5 | specimen | | |

Figure 1 — Schematic of AFM system

6.3 Specimen stage

The specimen stage shall be capable of supporting a specimen horizontally. The test area of the specimen should be in the centre of the specimen stage. Scanning should be performed near the centre of the X, Y and Z axes of the scanner used.

7 Test apparatus calibration

This document only describes a method to evaluate the adequateness of a probe tip for fine-ceramic thin-film surface roughness measurements by atomic force microscopy. If the apparatus needs to be calibrated, refer to standards describing calibration criteria and methods for a scanning probe microscope; see ISO 4288, ISO 11039 and ISO 11775.

8 Probe-tip diameter evaluation standard plate

A standard for probe-tip diameter evaluation is a plate on which a number of needle-shaped spikes, arranged in a square matrix, are formed. The needle-shaped spikes are typically as follows:

- tip curvature radius: 10 nm;
- tip aperture angle: 20° or 50°;
- tip height: 300 nm to 600 nm;
- distance between any two nearest neighbour tips: 2,12 µm;
- plate size: 5 mm × 5 mm.

9 Calibration of X-Y and Z scan axes

The calibration of the X-Y scanner and Z scanner should be carried out by measuring the X, Y and Z profile of a certified calibration standard. The standard should have a grating with a certain pitch and a step with a certain height.

The standard sample is a specimen with calibrated height and pitch, which are certified and traceable with uncertainty data attached. It is recommended that the grating pitch is less than 2 µm and that the step height is less than 20 nm.

The calibration standard should be stored in a clean and dry box and be handled with care.

The calibration shall be carried out in the following sequence using the dynamic mode.

- a) Mount the calibration standard in such a way that the grating is oriented to the X-Y axes of the scanner and that its plane lies nearly parallel to the X-Y plane of the scanner.
- b) Set the number of picture elements at 512 × 512 or 256 × 256.
- c) Scan an area of about 10 µm square of the calibration standard and store the surface profile data. An example is shown in [Figure 2 a](#)).
- d) From the surface profile data, draw a surface profile along the X direction at a selected Y position where the surface profile contains several steps on the calibration standard and level off the one-dimensional profile along the X direction. An example is shown in [Figure 2 b](#)).
- e) Measure profile peak height at the centre of top and bottom sections of the profile. Calculate mean height for at least five successive profile elements in the profile along the X direction.
- f) Measure a pitch along the X direction by measuring the distance between the mid-points of two successive rising or falling parts of the profile.
- g) From the surface profile data, draw a surface profile along the Y direction at a selected X position where the surface profile contains several steps and level off the one-dimensional profile along the Y direction.
- h) Measure profile peak heights at the centre of top and bottom sections of the profile. Calculate mean height for at least five successive profile elements in the profile along the Y direction.
- i) Measure a pitch along the Y direction by measuring the distance between the mid-points of two successive rising or falling parts of the profile.
- j) If an X- or Y-pitch measured is out of the range of uncertainty needed for roughness measurements, correct X or Y values by obtaining an X- or Y-axis calibration factor.
- k) If the mean height obtained is out of the range of uncertainty needed for roughness measurements, correct Z values by obtaining a Z-axis calibration factor.

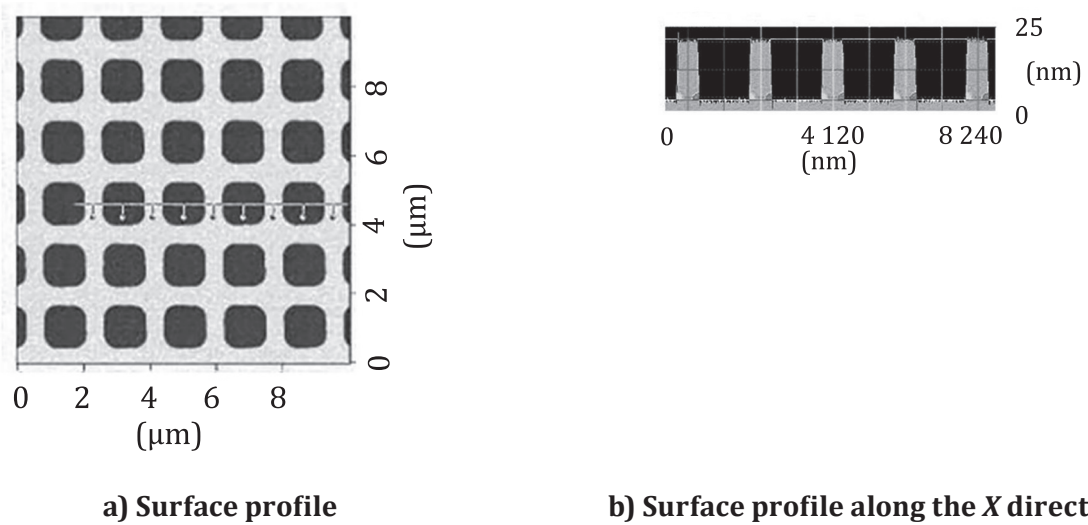

Figure 2 — Examples of surface profile data for the calibration of the X-Y scanner and Z scanner

10 Probe-tip error evaluation

10.1 Outline of probe-tip error evaluation

The error for roughness measurements using a probe tip with a certain probe-tip diameter shall be evaluated by using a probe-tip error evaluation template, providing the error from the relationship between the probe-tip diameter, preliminary Ra and preliminary RSm . If a probe tip is judged to be unsuitable for a roughness measurement with a certain error for a specimen to be measured, it should be rejected and replaced with a new one.

Probe-tip evaluation shall be carried out using the probe-tip evaluation sequence shown in [Figure 3](#).

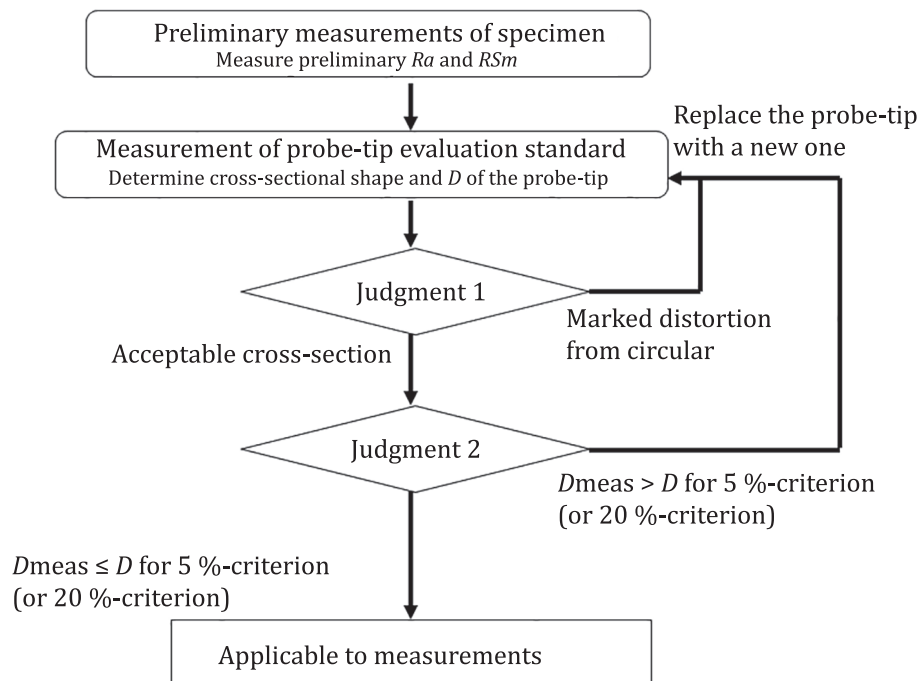

Figure 3 — Probe-tip evaluation sequence

10.2 Measurements of preliminary Ra and RSm

Preliminary roughness measurements shall be carried out to obtain preliminary Ra and RSm , the values to be used in the probe-tip judgement procedure.

- Place the specimen to be measured on the specimen stage without any surface treatment or without using any adhesive.
- Choose arbitrarily a measuring position on the specimen.
- Set the number of picture elements at 256 pixels or 512 pixels in the X direction and the scanning speed within 0,5 Hz to 1 Hz.
- Scan a 2 μm line in the X direction at a fixed Y position using the dynamic mode. Again scan a 10 μm line in the X direction at the same Y position. Apply an appropriate cut-off length.
- Select one of the two surface profiles along the X direction, such that the number of profile elements in the evaluation length $ln(X)$ is between 20 and 50.
- Calculate preliminary Ra and RSm values from the selected surface profile.

10.3 Evaluation of probe-tip diameter

The evaluation of probe-tip diameter should be carried out using the following sequence. A schematic drawing of probe-tip diameter determination is shown in [Figure 4](#).

- Measure a part of the probe-tip diameter evaluation standard plate by scanning a 2 $\mu\text{m} \times 2 \mu\text{m}$ to 3 $\mu\text{m} \times 3 \mu\text{m}$ squared area with the number of picture elements ranging from 128 pixels \times 128 pixels

to 32 pixels × 32 pixels to identify a needle-shaped spike on the standard plate to be used in a probe-tip diameter measurement.

- b) Confirm one of needle-shaped spikes on the surface is profiled.
- c) Adjust the scanning area so that the centre of the needle-shaped spike lies in the centre of the measured area.
- d) Measure again the area under the following conditions: the scan area of 1 × 1 to 1,28 μm × 1,28 μm squared, picture elements of 512 pixels × 512 pixels and a scan speed of 0,5 Hz. Apply an appropriate cut-off length (typically 300 nm to 700 nm).
- e) Draw the cross section of the needle-shaped spike profiled at 10 nm below its top in the Z direction. An example of such a cross section is shown in [Figure 5 b](#)). If the shape is markedly distorted from circular, the probe tip should be rejected and replaced with a new one. The tip-diameter evaluation should be repeated for the new probe tip (Judgment 1). It is recommended to draw a bird's-eye view of the profile as shown in [Figure 5 a](#)).
- f) If the ratio between the smallest dimension and largest dimension of the cross section drawn in e) is less than a factor of 0,8 then measure another tip. If not then calculate the probe-tip diameter as described in [Annex A](#). For the purposes of the calculation of D , assume that the diameter of the cross section drawn in e), d , is the average of the smallest and largest dimensions. Regard the calculated diameter as the probe-tip diameter, D . The determination of D is described in [Annex A](#).

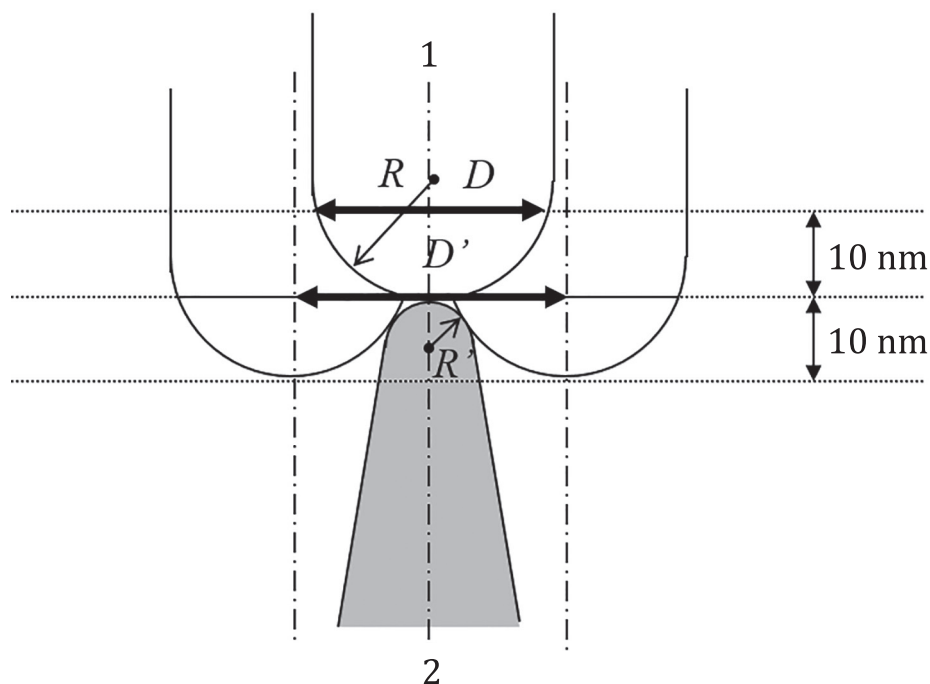

Key

- 1 probe tip
- 2 one of the needle-shaped spikes on the probe-tip evaluation standard plate
- R probe-tip curvature radius
- R' curvature radius of a needle-shaped spike
- D probe-tip diameter
- D' characterized probe-tip diameter, the distance between the probe centre at the depth of 10 nm beneath the top of the needle-shaped spike on the probe-tip evaluation standard plate

Figure 4 — Schematic drawing of fundamentals of probe-tip diameter determination

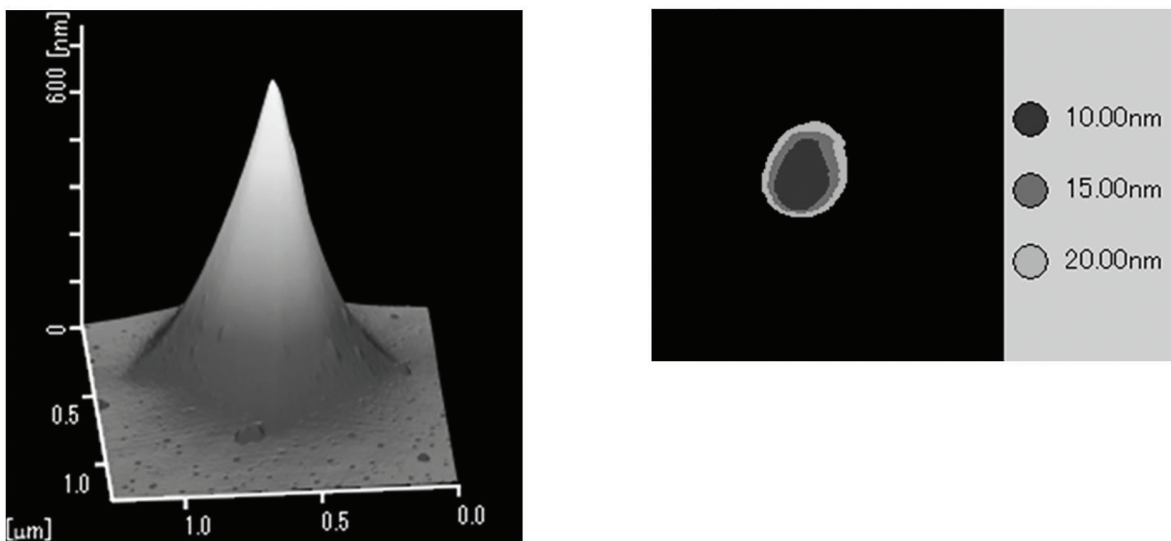

a) Bird's-eye view of measured surface profile

b) Cross section

Figure 5 — Example of measured data of one of the needle-shaped spikes on the probe-tip diameter evaluation standard plate, diameter, D' : 27,3 nm

10.4 Evaluation of error in roughness measurements

Judge if the D obtained in 10.3 is suitable or not for roughness measurement of a specimen to be measured by applying one of error evaluation templates given in Figures 6 to 9 (Judgment 2).

A 5 %-criterion and a 20 %-criterion are defined, which enable roughness measurements with an error less than 5 % and 20 %, respectively. Fundamental assumptions of the criteria are described in Annex B.

Figure 10 shows how to use the error evaluation templates given in Figures 6 to 9 for the probe-tip error evaluation. For a given rough value of RSm , if D is placed above the solid line in the D - RSm map, for example $D = D1$, the probe tip is not suitable for roughness measurements of a specimen to be examined because measurement error due to tip diameter exceeds 20 %. If D is placed below the solid line, for example $D = D2$, the probe tip enables roughness measurements with an error <20 %. If D is placed below the dotted line, for example $D = D3$, the probe tip enables roughness measurements with an error <5 %. Templates given in Figures 6 to 9 show 5 %-criterion and 20 %-criterion for specimens with $Ra = 1$ nm, 3 nm, 10 nm and 30 nm, respectively. Apply one of the criteria depending on the required accuracy of roughness measurements.

If the probe tip is not applicable for roughness measurement of a specimen with a certain evaluation error, replace the probe tip and evaluate the probe-tip error again by using the procedure described in 10.3.

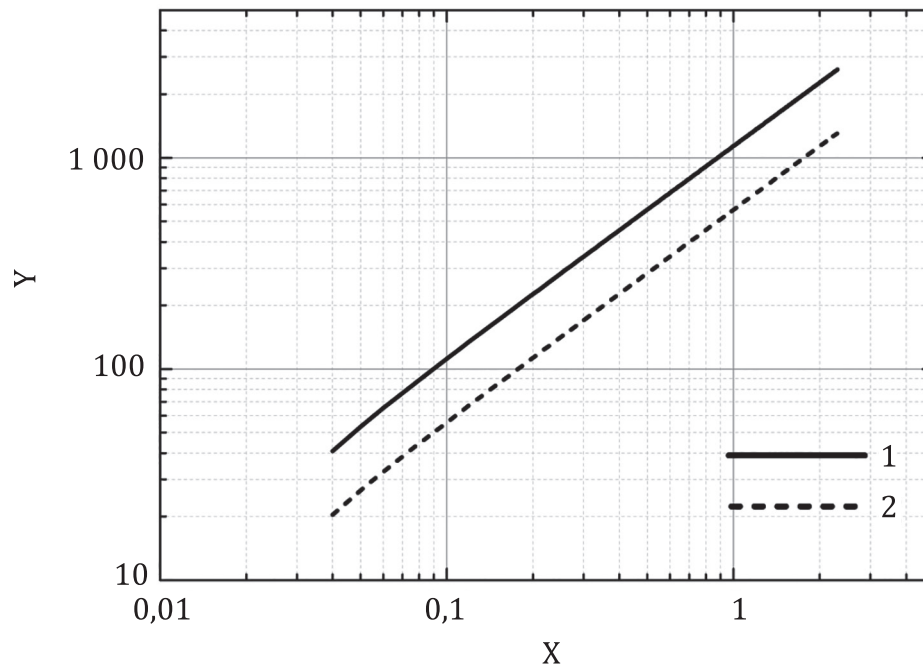

Key

- 1 solid line: 20 %-criterion
- 2 dotted line: 5 %-criterion

X R_{Sm} in μm
 Y probe tip diameter in nm

Figure 6 — D - R_{Sm} map for probe-tip error evaluation to measure roughness of a specimen with preliminary R_a of 1 nm

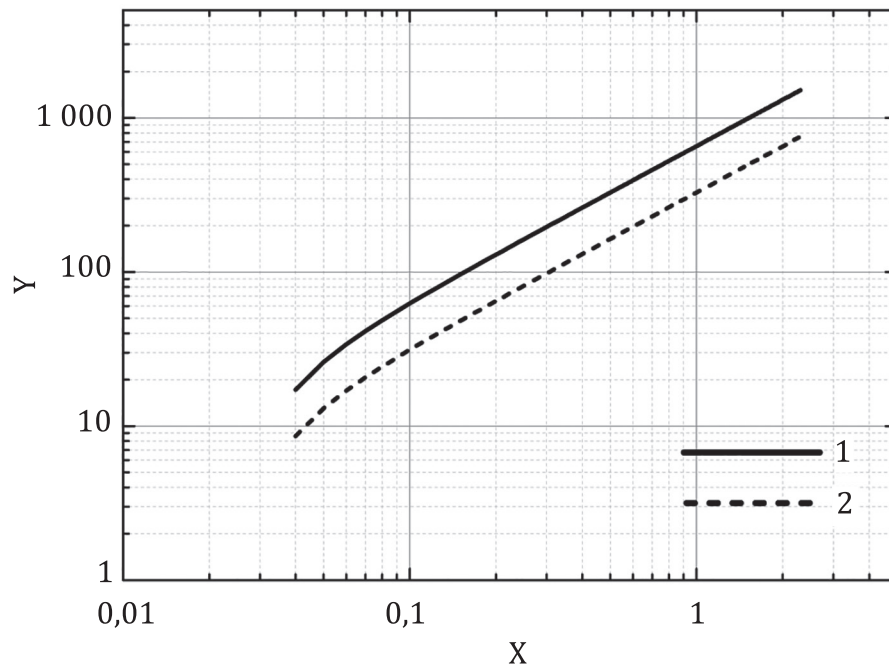

Key

- 1 solid line: 20 %-criterion
- 2 dotted line: 5 %-criterion

X R_{Sm} in μm
Y probe tip diameter in nm

Figure 7 — D - R_{Sm} map for probe-tip error evaluation to measure roughness of a specimen with preliminary R_a of 3 nm

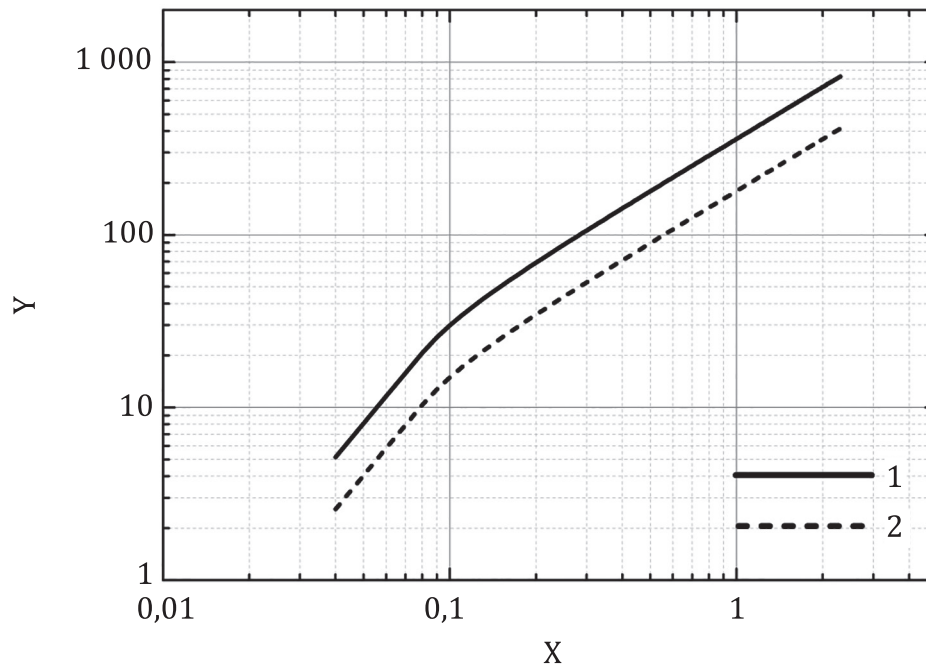

Key

- 1 solid line: 20 %-criterion
- 2 dotted line: 5 %-criterion

X R_{Sm} in μm
 Y probe tip diameter in nm

Figure 8 — D - R_{Sm} map for probe-tip error evaluation to measure roughness of a specimen with preliminary R_a of 10 nm

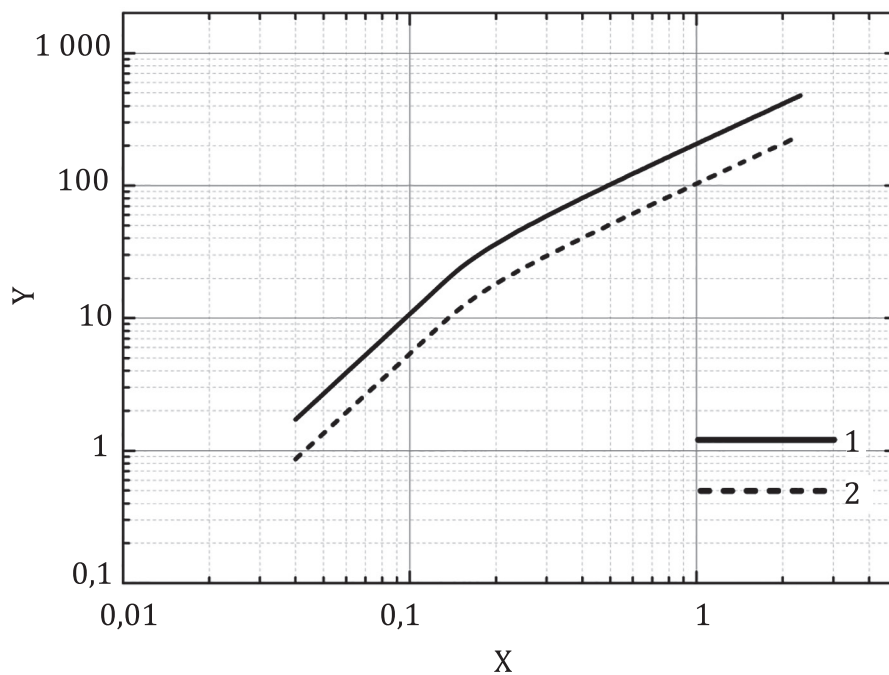

Key

- 1 solid line: 20 %-criterion
- 2 dotted line: 5 %-criterion

X RSm in μm
 Y probe tip diameter in nm

Figure 9 — D - RSm map for probe-tip error evaluation to measure roughness of a specimen with preliminary Ra of 30 nm

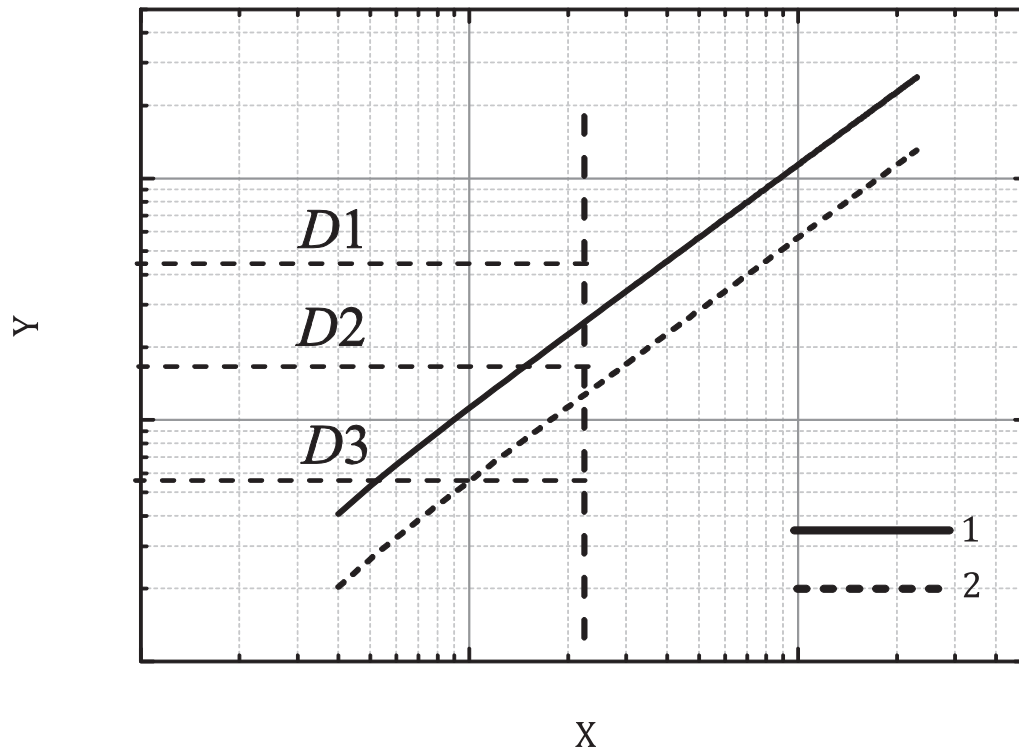

Key

- | | | | |
|---|----------------------------|---|--------------------|
| 1 | solid line: 20 %-criterion | X | RSm |
| 2 | dotted line: 5 %-criterion | Y | probe tip diameter |

Figure 10 — $D-RSm$ map describing how to apply the templates of [Figures 6 to 9](#) for probe-tip evaluation

11 Roughness measurements of specimen

Roughness measurements shall be carried out using an evaluated probe tip and under the measurement conditions given in [Clause 4](#). The roughness measurement sequence shall be as follows.

- a) Mount the specimen to be measured as described in [Clause 5](#).
- b) Choose a number of measuring points on the specimen. For example, four corners and the centre of a 10 mm square in the middle area of the specimen as shown in [Figure 11](#).
- c) Select the number of picture elements from 256 pixels to 512 pixels in the X direction and from 10 pixels to 512 pixels in the Y direction. Evaluation lengths $ln(X)$ and $ln(Y)$ are chosen so as to contain 20 periods to 50 periods of the profile elements. Apply an appropriate cut-off length to suppress a long-wave component. [Table 1](#) shows the recommended evaluation lengths for each preliminary RSm value of the specimen. Pixels in the Y direction could be 10 pixels if the average roughness of a line profile is measured.
- d) Scan the surface of the specimen at the given conditions.
- e) Repeat the evaluation of the probe-tip diameter, D , when, during a series of roughness measurements, a change in image is observed that could be due to wear of the probe tip. If the change in the probe-tip diameter is confirmed by the probe-tip diameter evaluation, the roughness measurement conditions should be reconsidered.
- f) Calculate Ra or Sa of the specimen using numerical data of the surface profile after compensating for any specimen tilt from the horizontal.

- g) Obtain R_z or S_z of the specimen using numerical data of the roughness profile after compensating for any specimen tilt from the horizontal by referring to ISO 25178-2 and ISO 25178-3 (R_z is maximum height of the profile and S_z is maximum height of the surface).

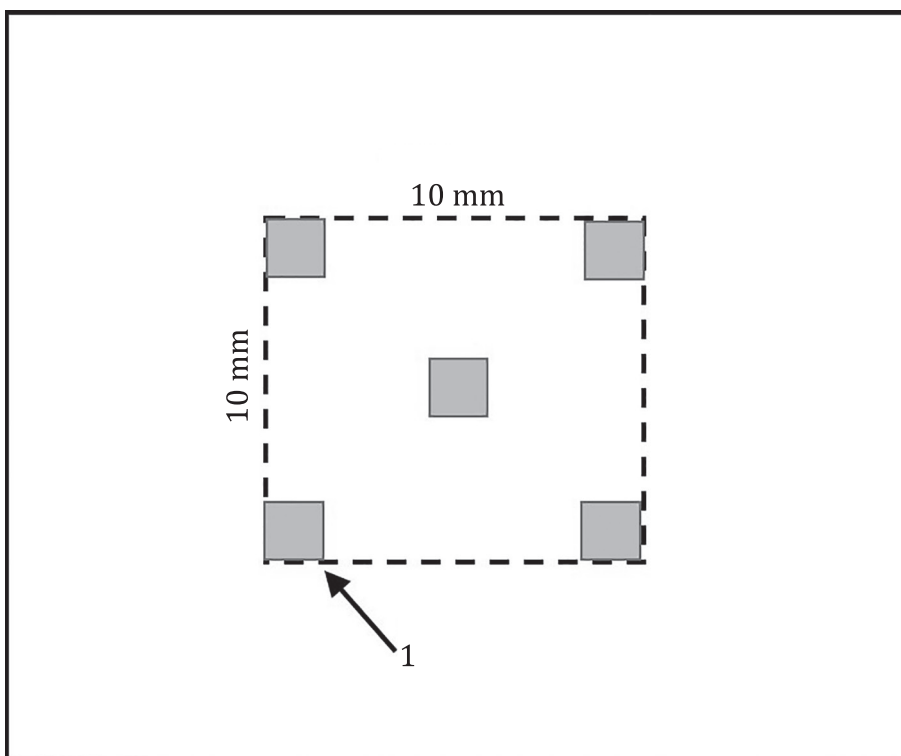

Key

- 1 measuring points

Figure 11 — Measuring positions on the specimen: four corners and the centre of a 10 mm square in the middle area

Table 1 — Recommended evaluation length for roughness measurements

Preliminary RSm μm	Recommended evaluation length l_n (μm)
$0,04 < RSm < 0,10$	2
$0,10 \leq RSm < 0,20$	5
$0,20 \leq RSm < 0,40$	10
$0,40 \leq RSm < 1,0$	20
$1,0 \leq RSm < 2,5$	50

12 Test report

The test report shall contain the following items as a minimum:

- a) type, material and shape of the test specimens;
- b) date of the test, name of person conducting the test, and name and address of the testing establishment;
- c) the International Standard used (including its year of publication);
- d) manufacturer, model number and specification of the measurement system;

- e) type and detailed shapes of probe-tip diameter evaluation standard;
- f) manufacturer and number of standard used to calibrate X , Y and Z axes of the instrument;
- g) temperature and humidity in the measurement room;
- h) test conditions used (material of the probe, model number of cantilever, resonant frequency, vibration frequency, Q value, scanning area, scanning speed, number of picture elements, and kind and shape of specimen holder if used);
- i) probe-tip evaluation data (bird's-eye profile data, cross-section data, probe-tip diameter evaluated);
- j) test result data (images of roughness measurements and values of Ra or Sa , Rz or Sz , etc.);
- k) any deviations from the procedure;
- l) any remarks about the testing circumstances;
- m) any unusual features observed.

Annex A (normative)

Determination of D from D'

A.1 Conditions needed for probe-tip diameter evaluation standard plate

The values of tip curvature radius and tip aperture angle should be obtainable from the supplier.

A.2 Fundamental assumptions

Probe-tip end is spherical with a curvature radius, R .

The diameter of the needle-shaped spikes on a probe-tip diameter evaluation standard plate R' ranges from 5 nm to 10 nm.

The aperture angle of the needle-shaped spikes on a probe-tip diameter evaluation standard plate ranges from 20° to 50°.

A.3 Procedures

A probe-tip diameter D is calculated as a function of R' and D' .

Using the given values of the curvature radius, R' , and θ , the value of D' , i.e. the diameter of the cross section of the spike drawn in 10.3 e), calculate the curvature radius of the probe tip. The formula used for this calculation depends on the values of the angular aperture of the needle-shaped spike and measured D' . There are two cases: $D' \geq D'_{\text{crit}}$ and $D' < D'_{\text{crit}}$, where D'_{crit} is the diameter measured for the radius of the probe tip when, for the conditions shown in Figure 4, contact between it and the needle-shaped spike occurs at the transition point between the curved tip of the spike and its conical base for a certain angular aperture. D'_{crit} is given by Formula (A.1):

$$D'_{\text{crit}} = 2R = 2 \frac{10}{1 - \sin(\theta / 2)} \cos(\theta / 2) \quad (\text{A.1})$$

For aperture curvature to be considered in the measurements, D'_{crit} is given for the sake of convenience in Table A.1.

Table A.1 — D'_{crit} for various aperture angles

Aperture angle (°)	20	30	40	50
D'_{crit} (nm)	47,6	52,2	47,2	62,8

For $D' < D'_{\text{crit}}$, use [Formula \(A.2\)](#):

$$D = 2R = 2 \left(\frac{D'^2}{40} + 10 - 2R' \right) \quad (\text{A.2})$$

For $D' \geq D'_{\text{crit}}$, use [Formula \(A.3\)](#):

$$D = 2R = \frac{\frac{D'}{2} - \frac{R'}{\cos(\theta/2)} + (R' - 10)\tan(\theta/2)}{[1 - \sin(\theta/2)]\tan(\theta/2) + \cos(\theta/2)} \quad (\text{A.3})$$

where θ is the aperture angle of the needle-shaped spike.

Annex B (informative)

Method to determine criteria for probe-tip error

B.1 Fundamental assumptions

The desirable D to measure surface roughness with a certain accuracy is calculated using a model shown in [Figure B.1](#) assuming as follows.

- a) Surface profile of the specimen $f(x)$ is given by

$$f(x) = \frac{\pi Ra}{2} \cos\left(\frac{2\pi}{RSm} x\right)$$

$$\text{because } Ra = \frac{Rz}{\pi} \tag{B.1}$$

This Ra value agrees well with real specimen surfaces compared with that of a triangular- or rectangular-shaped surface because the real surface can be approximated by the sum of cosine curves.

- b) The probe-tip has a spherical shape with radius R .
- c) The probe-tip shall reach the base of the valleys of the surface. Therefore, the maximum value of tip radius R_{\max} occurs when the spherical face of the probe tip fits the base of the valley of the cosine curve.

B.2 Maximum value of D

R_{\max} is obtained using [Formula \(B.2\)](#):

$$R_{\max} = \frac{RSm^2}{2\pi^3 Ra} \tag{B.2}$$

Then the maximum D value corresponding to R_{\max} can be determined using [Formulae \(B.2\)](#) and [\(B.3\)](#):

$$D_{\max} = 2(20 R_{\max} - 100)^{0,5} \quad (10 \text{ nm} \leq R) \tag{B.3}$$

$$D_{\max} = 2 R_{\max} \quad (R < 10 \text{ nm}) \tag{B.4}$$

B.3 Comparison between calculations and measurements

D_{\max} values calculated for specimens with $Ra = 5$ nm and 20 nm are shown in [Figures B.2](#) and [B.3](#), respectively. Open circles show D for probe tips used for a measurement. Measured Ra and its measurement error (ΔRa) for a specimen with $Ra = 5$ nm are plotted in [Figure B.4](#). If it is assumed that the measured Ra using the sharpest probe tip in this experiment is real roughness, then it is found that ΔRa is smaller than 5 % when D is smaller than $D_{\max}/2$. When D is between $D_{\max}/2$ and D_{\max} , ΔRa is smaller than 20 %. Measured Ra and ΔRa for a specimen with $Ra = 20$ nm as plotted in [Figure B.5](#) show that ΔRa is smaller than 3 % when D is about a half of D_{\max} .

B.4 Determination of criteria

It is expected from the above description that ΔRa is smaller than 5 % when D is smaller than $D_{\max}/2$ (5 % criterion) and ΔRa is smaller than 20 % when D is between $D_{\max}/2$ and D_{\max} (20 % criterion). Calculated D_{\max} values for specimens with different RSm are shown in [Figures 5 to 8](#).

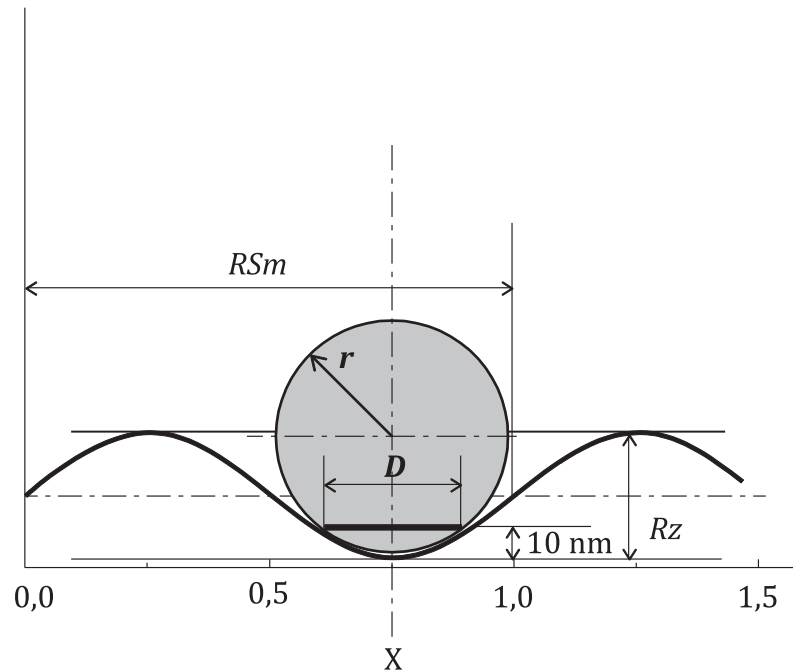

Key

X horizontal axis of roughness profile

Figure B.1 — Model for probe-tip error evaluation

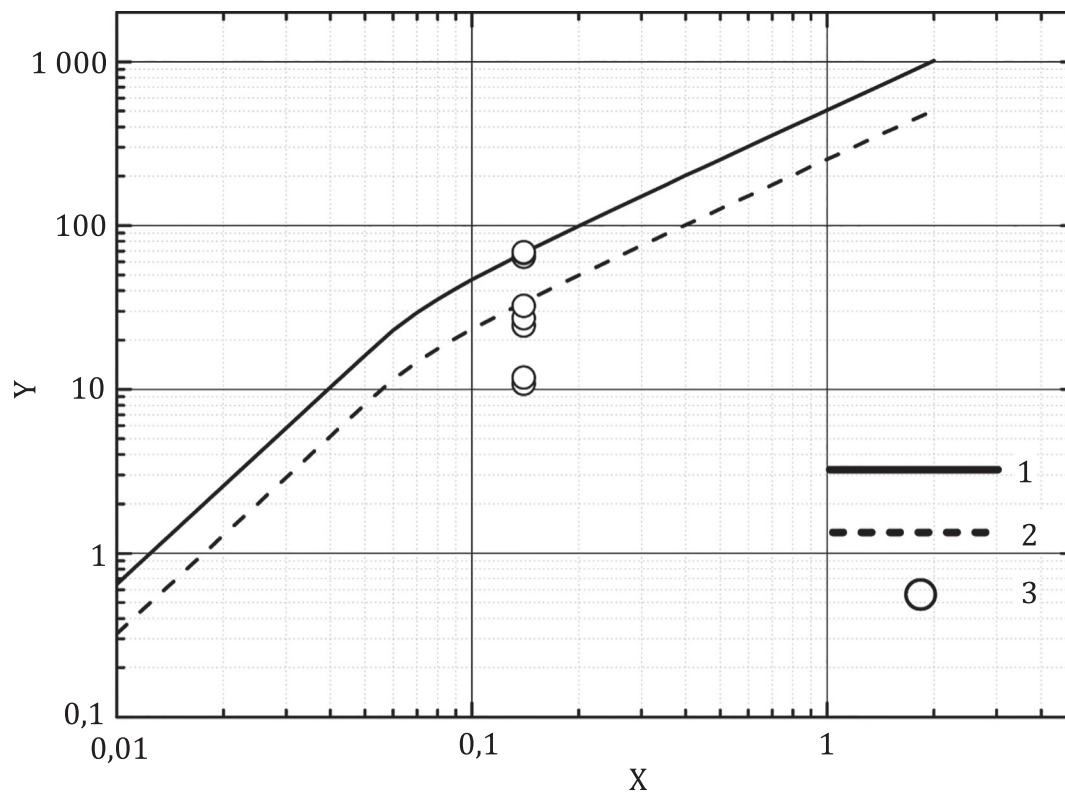

Key

- | | | | |
|---|----------------------------|---|--------------------------|
| 1 | solid line: 20 %-criterion | X | RSm in μm |
| 2 | dotted line: 5 %-criterion | Y | probe tip diameter in nm |
| 3 | measured points | | |

Figure B.2 — D_{max} , $D_{max}/2$ and measured values for a specimen with $Ra = 5$ nm

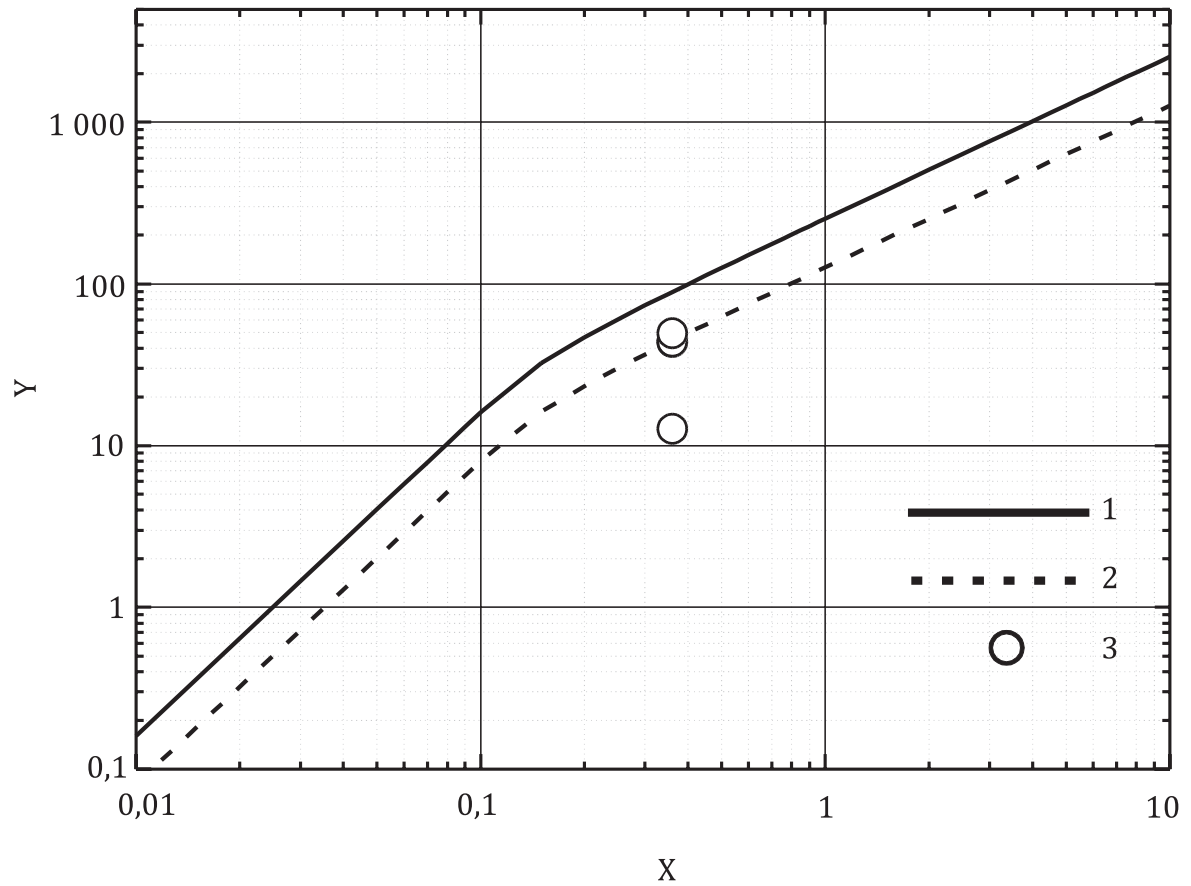

Key

- 1 solid line: 20 %-criterion
- 2 dotted line: 5 %-criterion
- 3 measured points

- X RSm in μm
- Y probe tip diameter in nm

Figure B.3 — D_{max} , $D_{max}/2$ and measured values for a specimen with $Ra = 20$ nm

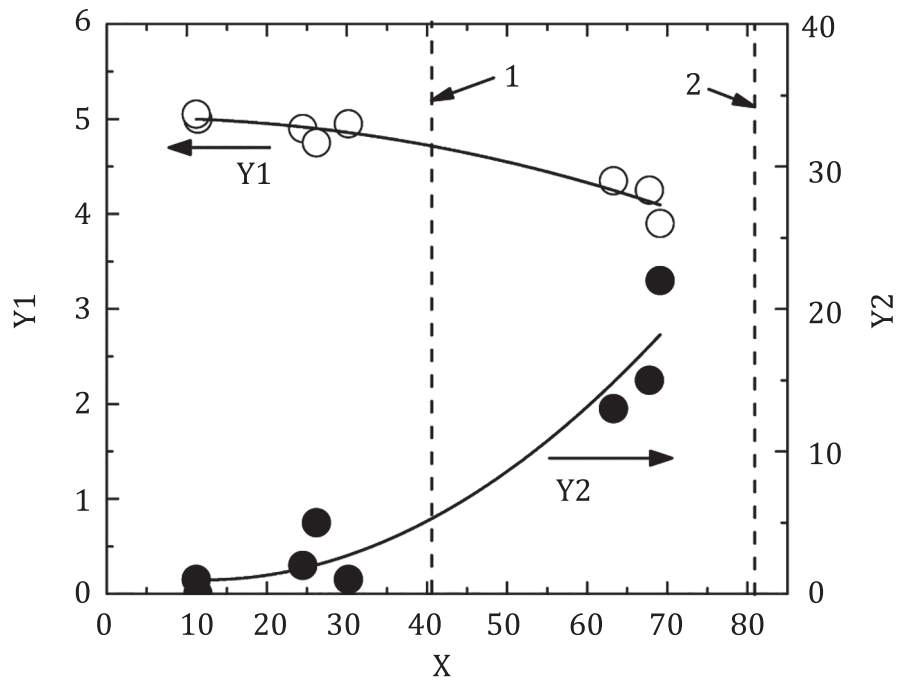

Key

- | | | | |
|---|-----------------------|----|--------------------------|
| 1 | one half of D_{max} | X | probe tip diameter in nm |
| 2 | D_{max} | Y1 | R_a |
| | | Y2 | ΔR_a |

Figure B.4 — Measured R_a and measurement error, ΔR_a , for specimen with $R_a = 5$ nm as a function of probe tip diameter, D

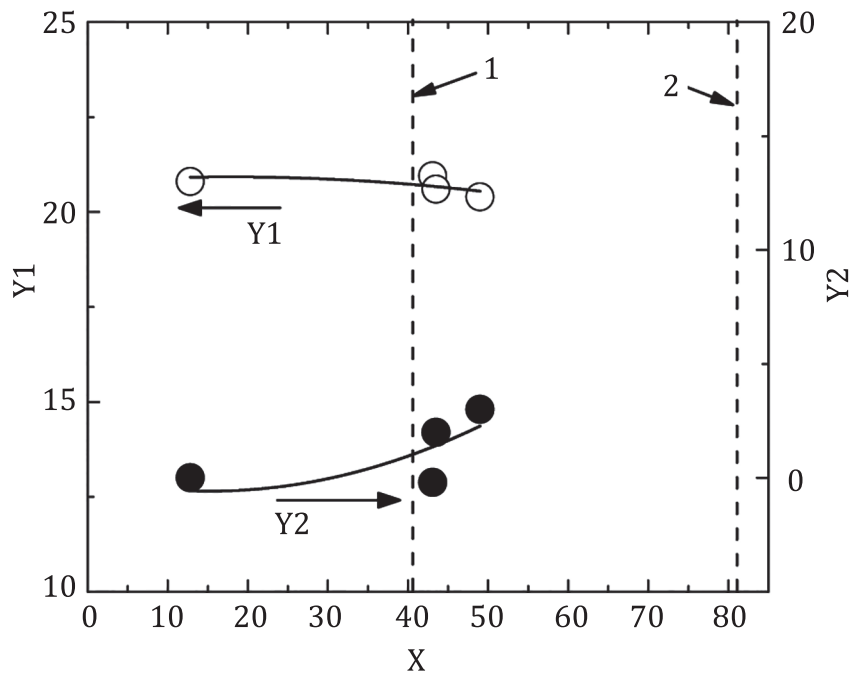

Key

- 1 one half of D_{\max}
- 2 D_{\max}

- X probe tip diameter in nm
- Y1 R_a
- Y2 ΔR_a

Figure B.5 — Measured R_a and measurement error, ΔR_a , for specimen with $R_a = 20$ nm as a function of probe tip diameter, D

Bibliography

- [1] ISO 11775, *Surface chemical analysis — Scanning-probe microscopy — Determination of cantilever normal spring constants*
- [2] ISO 16610-21, *Geometrical product specifications (GPS) — Filtration — Part 21: Linear profile filters: Gaussian filters*
- [3] ISO 25178-3, *Geometrical product specifications (GPS) — Surface texture: Areal — Part 3: Specification operators*

British Standards Institution (BSI)

BSI is the national body responsible for preparing British Standards and other standards-related publications, information and services.

BSI is incorporated by Royal Charter. British Standards and other standardization products are published by BSI Standards Limited.

About us

We bring together business, industry, government, consumers, innovators and others to shape their combined experience and expertise into standards-based solutions.

The knowledge embodied in our standards has been carefully assembled in a dependable format and refined through our open consultation process. Organizations of all sizes and across all sectors choose standards to help them achieve their goals.

Information on standards

We can provide you with the knowledge that your organization needs to succeed. Find out more about British Standards by visiting our website at bsigroup.com/standards or contacting our Customer Services team or Knowledge Centre.

Buying standards

You can buy and download PDF versions of BSI publications, including British and adopted European and international standards, through our website at bsigroup.com/shop, where hard copies can also be purchased.

If you need international and foreign standards from other Standards Development Organizations, hard copies can be ordered from our Customer Services team.

Copyright in BSI publications

All the content in BSI publications, including British Standards, is the property of and copyrighted by BSI or some person or entity that owns copyright in the information used (such as the international standardization bodies) and has formally licensed such information to BSI for commercial publication and use.

Save for the provisions below, you may not transfer, share or disseminate any portion of the standard to any other person. You may not adapt, distribute, commercially exploit, or publicly display the standard or any portion thereof in any manner whatsoever without BSI's prior written consent.

Storing and using standards

Standards purchased in soft copy format:

- A British Standard purchased in soft copy format is licensed to a sole named user for personal or internal company use only.
- The standard may be stored on more than 1 device provided that it is accessible by the sole named user only and that only 1 copy is accessed at any one time.
- A single paper copy may be printed for personal or internal company use only.

Standards purchased in hard copy format:

- A British Standard purchased in hard copy format is for personal or internal company use only.
- It may not be further reproduced – in any format – to create an additional copy. This includes scanning of the document.

If you need more than 1 copy of the document, or if you wish to share the document on an internal network, you can save money by choosing a subscription product (see 'Subscriptions').

Reproducing extracts

For permission to reproduce content from BSI publications contact the BSI Copyright & Licensing team.

Subscriptions

Our range of subscription services are designed to make using standards easier for you. For further information on our subscription products go to bsigroup.com/subscriptions.

With **British Standards Online (BSOL)** you'll have instant access to over 55,000 British and adopted European and international standards from your desktop. It's available 24/7 and is refreshed daily so you'll always be up to date.

You can keep in touch with standards developments and receive substantial discounts on the purchase price of standards, both in single copy and subscription format, by becoming a **BSI Subscribing Member**.

PLUS is an updating service exclusive to BSI Subscribing Members. You will automatically receive the latest hard copy of your standards when they're revised or replaced.

To find out more about becoming a BSI Subscribing Member and the benefits of membership, please visit bsigroup.com/shop.

With a **Multi-User Network Licence (MUNL)** you are able to host standards publications on your intranet. Licences can cover as few or as many users as you wish. With updates supplied as soon as they're available, you can be sure your documentation is current. For further information, email subscriptions@bsigroup.com.

Revisions

Our British Standards and other publications are updated by amendment or revision.

We continually improve the quality of our products and services to benefit your business. If you find an inaccuracy or ambiguity within a British Standard or other BSI publication please inform the Knowledge Centre.

Useful Contacts

Customer Services

Tel: +44 345 086 9001

Email (orders): orders@bsigroup.com

Email (enquiries): cservices@bsigroup.com

Subscriptions

Tel: +44 345 086 9001

Email: subscriptions@bsigroup.com

Knowledge Centre

Tel: +44 20 8996 7004

Email: knowledgecentre@bsigroup.com

Copyright & Licensing

Tel: +44 20 8996 7070

Email: copyright@bsigroup.com

BSI Group Headquarters

389 Chiswick High Road London W4 4AL UK