

BS ISO 18522:2016



BSI Standards Publication

Paper and board — Automated off-line testing of physical properties for CD (cross direction) profiles

National foreword

This British Standard is the UK implementation of ISO 18522:2016.

The UK participation in its preparation was entrusted to Technical Committee PAI/11, Methods of test for paper, board and pulps.

A list of organizations represented on this committee can be obtained on request to its secretary.

This publication does not purport to include all the necessary provisions of a contract. Users are responsible for its correct application.

© The British Standards Institution 2016.
Published by BSI Standards Limited 2016

ISBN 978 0 580 81212 5

ICS 85.060

Compliance with a British Standard cannot confer immunity from legal obligations.

This British Standard was published under the authority of the Standards Policy and Strategy Committee on 30 November 2016.

Amendments/Corrigenda issued since publication

Date	Text affected
------	---------------

INTERNATIONAL
STANDARD

BS ISO 18522:2016

ISO
18522

First edition
2016-11-15

**Paper and board — Automated off-line
testing of physical properties for CD
(cross direction) profiles**

*Papier et carton — Essais hors ligne — Mesure des propriétés
physiques pour profils ST (sens travers) sur bancs automatisés*



Reference number
ISO 18522:2016(E)

© ISO 2016



COPYRIGHT PROTECTED DOCUMENT

© ISO 2016, Published in Switzerland

All rights reserved. Unless otherwise specified, no part of this publication may be reproduced or utilized otherwise in any form or by any means, electronic or mechanical, including photocopying, or posting on the internet or an intranet, without prior written permission. Permission can be requested from either ISO at the address below or ISO's member body in the country of the requester.

ISO copyright office
Ch. de Blandonnet 8 • CP 401
CH-1214 Vernier, Geneva, Switzerland
Tel. +41 22 749 01 11
Fax +41 22 749 09 47
copyright@iso.org
www.iso.org

Contents

Page

Foreword	v
Introduction	vi
1 Scope	1
2 Normative references	1
3 Terms and definitions	2
4 Principle	3
5 Apparatus	3
5.1 Sample cutter.....	3
5.2 Automated off-line testers.....	3
6 Sampling	3
6.1 General.....	3
6.2 Cutting samples.....	4
7 Conditioning	4
8 Procedure	4
8.1 General.....	4
8.2 Determination of single sheet thickness, density and specific volume (ISO 534).....	5
8.3 Determination of grammage (ISO 536).....	5
8.4 Determination of tensile properties.....	5
8.4.1 Constant rate of elongation.....	5
8.4.2 Alternative method.....	6
8.5 Determination of tearing resistance.....	6
8.5.1 General.....	6
8.5.2 Tear module type 1.....	6
8.5.3 Tear module type 2.....	8
8.5.4 Other types of tear modules.....	9
8.6 Determination of optical properties.....	9
8.7 Determination of bending resistance.....	10
8.7.1 General.....	10
8.7.2 Example of a bending resistance module.....	11
8.7.3 Other types of bending resistance modules for automated off-line measurements.....	12
8.8 Paper — Determination of bursting strength (ISO 2758).....	12
8.9 Board — Determination of bursting strength (ISO 2759).....	13
8.10 Determination of smoothness — Bekk method (ISO 5627).....	13
8.11 Determination of air permeance — Bendtsen method (ISO 5636-3).....	13
8.12 Paper and board — Determination of air permeance (medium range) — Part 6: Oken method (ISO 5636-6).....	14
8.13 Measurement of specular gloss — Part 1: 75° gloss with a converging beam, TAPPI method (ISO 8254-1).....	14
8.14 Measurement of specular gloss — Part 2: 75° gloss with a parallel beam, DIN method (ISO 8254-2).....	14
8.15 Measurement of specular gloss — Part 3: 20° gloss with a converging beam, TAPPI method (ISO 8254-3).....	15
8.16 Determination of roughness/smoothness — Bendtsen method (ISO 8791-2).....	15
8.17 Determination of roughness/smoothness — Print-surf method (ISO 8791-4).....	15
8.18 Compressive strength — Short-span test (ISO 9895).....	16
9 Calculation and expression of results	16
10 Test report	16
Annex A (informative) Accelerated conditioning	17

Annex B (informative) Comparison between stand-alone instruments and automated off-line testing of CD profiles	19
Annex C (informative) Comparison between stand-alone and automated off-line testing with all samples preconditioned and conditioned (ISO 187)	25
Bibliography	27

Foreword

ISO (the International Organization for Standardization) is a worldwide federation of national standards bodies (ISO member bodies). The work of preparing International Standards is normally carried out through ISO technical committees. Each member body interested in a subject for which a technical committee has been established has the right to be represented on that committee. International organizations, governmental and non-governmental, in liaison with ISO, also take part in the work. ISO collaborates closely with the International Electrotechnical Commission (IEC) on all matters of electrotechnical standardization.

The procedures used to develop this document and those intended for its further maintenance are described in the ISO/IEC Directives, Part 1. In particular the different approval criteria needed for the different types of ISO documents should be noted. This document was drafted in accordance with the editorial rules of the ISO/IEC Directives, Part 2 (see www.iso.org/directives).

Attention is drawn to the possibility that some of the elements of this document may be the subject of patent rights. ISO shall not be held responsible for identifying any or all such patent rights. Details of any patent rights identified during the development of the document will be in the Introduction and/or on the ISO list of patent declarations received (see www.iso.org/patents).

Any trade name used in this document is information given for the convenience of users and does not constitute an endorsement.

For an explanation on the meaning of ISO specific terms and expressions related to conformity assessment, as well as information about ISO's adherence to the World Trade Organization (WTO) principles in the Technical Barriers to Trade (TBT) see the following URL: www.iso.org/iso/foreword.html.

The committee responsible for this document is ISO/TC 6, *Paper, board and pulps*.

Introduction

The automated off-line testing of cross direction (CD) profiles of paper and board was introduced in the 1980s. The apparatus available then was equipped with various modules for the determination of basic physical properties such as grammage, thickness, Bendtsen roughness, air permeance, etc. In the 90s, more advanced modules were developed for tensile, tear and bending testing. Modules for the measurement of the optical properties with the C/2°, D50/2° and D65/10° illuminants are also available.

The principal benefits of automated off-line testing are the speed with which the results are obtained and the small number of staff required to operate the testing apparatus.

Testing with stand-alone instruments implies much longer time before the results are available. Automated off-line testing improves the repeatability in testing as the operator dependency disappears.

In most of the countries producing paper and board, some type of automated off-line testing of CD profiles is carried out.

For the determination of physical properties, this document refers, where possible, to the relevant International Standards for the description and calibration of the equipment required. The results from automated off-line testing are widely accepted by the customers although the conditioning requirements stated in ISO 187 are not met.

Paper and board — Automated off-line testing of physical properties for CD (cross direction) profiles

1 Scope

This document specifies the procedures for determining the cross direction profiles of physical properties of paper and board using automated off-line testers. Where available for a given measurement, the relevant International Standard is referred to. It is applicable to most kinds of paper and board, but is not relevant for tissue and corrugated board.

In this document, it is left to the paper and board producer and the customer to agree upon which properties are relevant. The results are reported as mean values or as profiles across the machine. Some properties are reported in index form.

The result obtained using the relevant ISO standard based on stand-alone equipment is used in case of challenge or dispute, if not otherwise agreed.

NOTE 1 The results obtained using specimens conditioned according to ISO 187 and stand-alone test instruments will, for some paper properties, differ from those obtained with unconditioned specimens and automated off-line testers. An investigation was made to only a limited extent, where the automated off-line testing was compared to stand-alone instruments, including the impact of conditioning. A summary of this investigation is reported in [Annex B](#).

NOTE 2 It is also possible to evaluate properties in the machine direction (MD), but this is usually only used for trouble-shooting.

2 Normative references

The following documents are referred to in the text in such a way that some or all of their content constitutes requirements of this document. For dated references, only the edition cited applies. For undated references, the latest edition of the referenced document (including any amendments) applies.

ISO 186:2002, *Paper and board — Sampling to determine average quality*

ISO 187, *Paper, board and pulps — Standard atmosphere for conditioning and testing and procedure for monitoring the atmosphere and conditioning of samples*

ISO 534, *Paper and board — Determination of thickness, density and specific volume*

ISO 536, *Paper and board — Determination of grammage*

ISO 1924-2, *Paper and board — Determination of tensile properties — Part 2: Constant rate of elongation method (20 mm/min)*

ISO 1924-3, *Paper and board — Determination of tensile properties — Part 3: Constant rate of elongation method (100 mm/min)*

ISO 1974, *Paper — Determination of tearing resistance — Elmendorf method*

ISO 2469:2014, *Paper, board and pulps — Measurement of diffuse radiance factor (diffuse reflectance factor)*

ISO 2470-1, *Paper, board and pulps — Measurement of diffuse blue reflectance factor — Part 1: Indoor daylight conditions (ISO brightness)*

ISO 2470-2, *Paper, board and pulps — Measurement of diffuse blue reflectance factor — Part 2: Outdoor daylight conditions (D65 brightness)*

- ISO 2471, *Paper and board — Determination of opacity (paper backing) — Diffuse reflectance method*
- ISO 2493-1, *Paper and board — Determination of bending resistance — Part 1: Constant rate of deflection*
- ISO 2758, *Paper — Determination of bursting strength*
- ISO 2759, *Board — Determination of bursting strength*
- ISO 5627, *Paper and board — Determination of smoothness (Bekk method)*
- ISO 5631-1, *Paper and board — Determination of colour by diffuse reflectance — Part 1: Indoor daylight conditions (C/2°)*
- ISO 5631-2, *Paper and board — Determination of colour by diffuse reflectance — Part 2: Outdoor daylight conditions (D65/10°)*
- ISO 5631-3, *Paper and board — Determination of colour by diffuse reflectance — Part 3: Indoor illumination conditions (D50/2°)*
- ISO 5636-3, *Paper and board — Determination of air permeance (medium range) — Part 3: Bendtsen method*
- ISO 5636-6, *Paper and board — Determination of air permeance (medium range) — Part 6: Oken method*
- ISO 8254-1, *Paper and board — Measurement of specular gloss — Part 1: 75° gloss with a converging beam, TAPPI method*
- ISO 8254-2, *Paper and board — Measurement of specular gloss — Part 2: 75° gloss with a parallel beam, DIN method*
- ISO 8254-3, *Paper and board — Measurement of specular gloss — Part 3: 20° gloss with a converging beam, TAPPI method*
- ISO 8791-2, *Paper and board — Determination of roughness/smoothness (air leak methods) — Part 2: Bendtsen method*
- ISO 8791-4, *Paper and board — Determination of roughness/smoothness (air leak methods) — Part 4: Print-surf method*
- ISO 9416, *Paper — Determination of light scattering and absorption coefficients (using Kubelka-Munk theory)*
- ISO 9895, *Paper and board — Compressive strength — Short-span test*
- ISO 11475, *Paper and board — Determination of CIE whiteness, D65/10° (outdoor daylight)*
- ISO 11476, *Paper and board — Determination of CIE whiteness, C/2° (indoor illumination conditions)*

3 Terms and definitions

For the purposes of this document, the following terms and definitions apply.

ISO and IEC maintain terminological databases for use in standardization at the following addresses:

- IEC Electropedia: available at <http://www.electropedia.org/>
- ISO Online browsing platform: available at <http://www.iso.org/obp>

3.1 cross direction sample CD sample

cut from edge to edge of a mother reel or post winder reel in the cross direction (CD), having a width in the machine direction (MD) appropriate for the tests to be carried out

Note 1 to entry: A typical width along the machine direction is about 300 mm.

4 Principle

This document describes the procedure for the determination of CD profiles of physical properties of paper and board using the relevant automated off-line testers on the market which fulfil the requirements of this document. The results are reported as mean values or as profiles across the machine. Some properties are reported in index form.

5 Apparatus

5.1 Sample cutter

5.1.1 A motor driven cutter for cutting the CD samples, capable of accurately cutting samples perpendicular to the edges of the reel from edge to edge, and the width to an accuracy so that test methods which are sensitive to direction changes are not influenced. Control that the width (MD) does not vary so as to influence test methods which are sensitive to direction changes. Means may be provided for controlling the sample and feeding it to the test line, such as automated winding of the CD sample onto a removable cylinder which can be inserted in the automated off-line tester.

5.1.2 It is possible to use **manual sample cutters**. The sample can be trimmed to the accuracy required of motor driven sample cutters using a table top cutter.

5.2 Automated off-line testers

There are a number of automated off-line testers on the market for which testing in many cases is based on existing International Standards. They are typically composed of an unwinder followed by several units placed sequentially, with the destructive test measuring heads located at the end of the line. Some test lines are equipped with a moisture content module providing the possibility of correcting the values if needed.

Some of the test methods are not the same as those in the equivalent reference standards for stand-alone instruments. In these cases, correction factors and correction procedures can be a way to get results that correlate with those obtained using the reference standards.

The equipment shall be calibrated in accordance with the instructions in the relevant International Standards. Where this is not possible, for example, in the case of non-standard testers or alternative methods, advice may be provided on calibration by the manufacturer or any suitable party, allowing due regard to the measurement capability of the tester.

6 Sampling

6.1 General

The sampling of CD profiles is performed according to ISO 186. If sampling according to the procedure described in the main body of ISO 186 is impossible, impracticable or inappropriate, alternative sampling procedures as described in ISO 186:2002, Annex A can be used.

Sampling can be performed using hand or motor driven cutters. Before taking the CD sample, remove all damaged layers from the outside of the reel. CD samples are normally taken from every produced reel, or according to some other specific routine decided at each mill. The number of CD samples taken is determined by the number of tests to be performed and the amount of required material for later follow-up testing. Normally, one CD sample is used for testing directly in the automated off-line testers. When taking CD samples, ensure that the front side (FS) and drive side (DS), and top side and bottom side are identified, e.g. by marking the FS and top side.

Care shall be taken in handling CD samples as contact with bare hands can appreciably affect the chemical, physical, optical, surface and other characteristics of the paper or board. Use of cotton gloves

is recommended during the sampling procedure. CD samples shall be free from wrinkles, folds and dirt and protected from exposure to conditions which may change the relevant properties. Avoid contact with the surface that is to be tested and place the CD sample on a clean table if necessary.

The average of a single CD profile for a specific sheet property may not be the same as the average obtained by the sampling procedures described in ISO 186.

Differences in average values may be due to the machine position (FS, DS or mid position) in which the samples are taken, the variability in paper properties and the number of positions in which the CD sample is tested, and not only the difference between sampling of reels in ISO 186 and in this document.

NOTE Winding the reel too tightly might cause problems with other measurements (e.g. bending measurements) for high grammage grades such as liquid board and folding box board.

6.2 Cutting samples

Cut the CD sample (3.1) perpendicular to the machine direction from edge to edge of the reel and of the required width using a sample cutter (5.1). The sample shall be clean, wrinkle-free and free of atypical defects.

7 Conditioning

As with non-automated testing, for quick feedback for the production line, it is usually impracticable to condition samples according to ISO 187. Locate the automated off-line tester in a conditioned test room meeting the requirements of ISO 187 and allow sufficient time for the CD sample to partially condition before testing of properties sensitive to moisture content is carried out. The time required will depend on equipment available for rapid conditioning and the grammage of the sample. It is desirable for preconditioning to be carried out as the first step.

NOTE Usually, the testing is started within 3 min to 15 min from sampling in the machine hall.

A suitable method for accelerated conditioning is described in [Annex A](#).

The principle is that a CD sample is placed on a bench where air, meeting the temperature and relative humidity requirements of ISO 187, passes through the sample by means of vacuum fans. The specific time needed depends on the type of material and is more effective for lower grammages, <300 g/m². Mechanical properties like bending resistance and tear resistance are sensitive to the moisture content. In production, conditioning according to ISO 187 may not be practicable, instead, an accelerated conditioning can be used.

8 Procedure

8.1 General

A standard orientation and direction should be selected for feeding CD samples into the automated off-line tester. Ensure that the CD sample is fed into the tester with the chosen direction and orientation.

Choose the right configuration for your testing including the following:

- the machine direction width of the CD sample;
- properties to be tested;
- step length between tests;
- number of measurement points in the cross direction for each property;
- profile and/or mean value of properties.

The International Standards referred to in [8.2](#) to [8.18](#) are the currently most used and can be used in agreements between concerned parties.

NOTE Precision data, if available, are normally presented in the International Standard in question and with the calculations made according to ISO/TR 24498^[1] and TAPPI T 1200 sp-07.^[3]

8.2 Determination of single sheet thickness, density and specific volume (ISO 534)

ISO 534 shall be used for this test. Any deviations shall be reported. The number of measurements in the CD is decided by the producer with consideration to the machine width.

Express the result for single sheet thickness in micrometres to three significant figures, apparent sheet density in grams per cubic centimetre to three significant figures and apparent specific sheet volume in cubic centimetres per gram to three significant figures.

NOTE In some countries, particularly in North America, the 50 kPa pressure is still widely used, but does not conform to ISO 534 and different results will be obtained using this pressure.

8.3 Determination of grammage (ISO 536)

ISO 536 shall be used for this test with the following deviations; the area of the test piece shall be at least 100 cm² and the area determined to an accuracy of 0,5 %. Any other deviations, or if another method is used, this shall be reported. The number of measurements in the CD is decided by the producer with consideration to the machine width.

The grammage test area is normally trimmed by using a punch or a knife.

The balance shall be shielded from air currents. The mass of the trimmed specimen shall be determined to an accuracy of 0,2 % and the grammage shall be reported to three significant figures.

8.4 Determination of tensile properties

8.4.1 Constant rate of elongation

ISO 1924-2 or ISO 1924-3 shall be used for this test. Any deviations shall be reported.

Various modules which do not conform with ISO 1924-2 or ISO 1924-3 are used in automated off-line testers. The user shall establish the correlation between properties measured using a tensile module and those using a standard ISO test.

NOTE 1 In [Annex C](#), the results of a comparison between stand-alone and automated off-line testing for tensile strength, strain at break and tensile energy absorption (TEA) are presented.

An example of a module is shown in [Figure 1](#) (the figure presented is an example and differs from ISO 1924). The tensile module cuts a specimen with a width of 15 mm from the sample and clamps it at two points located at a distance of 100 mm from each other. The specimen is then pushed upwards until it breaks, and the module measures tensile strength, elongation at break and TEA.

Dimensions in millimetres

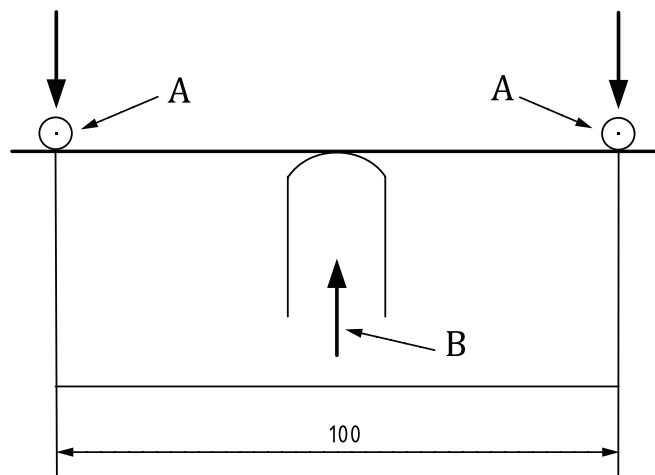

Key

- A clamps
- B force

Figure 1 — Example of a tensile module

NOTE 2 The results of the above test correlate quite well with ISO 1924-3, see [Annex C](#).

Tensile strength, tensile stretch and TEA of paper can be measured both in the machine directions (MD) and cross directions (CD) of a paper sample if separate units are used in the tester.

Report the tensile strength, strain at break and tensile energy absorption to three significant figures. If grammage is known, various indexes can be calculated.

8.4.2 Alternative method

Other constructions of modules may be available on the market and shall be accurately described by the manufacturer. These can use different types of procedures which do not give the same results compared to the relevant part of ISO 1924 and a correlation will then have to be performed on equipment in accordance with ISO 1924.

8.5 Determination of tearing resistance

8.5.1 General

This procedure of tearing testing is often related to ISO 1974 Elmendorf method, but is not comparable. Correction factors are one way of getting results in conformity with ISO 1974. Another way is to report the value obtained direct from the module.

The modules can use different types of procedures which do not give the same results compared to ISO 1974 and a correlation will then have to be performed on equipment in accordance with ISO 1974.

8.5.2 Tear module type 1

An example of a tear module for automated off-line measurements is shown in [Figure 2](#).

The tearing module (see [Figure 2](#)), measures the tearing resistance of a paper sample, in the machine directions (MD) and cross directions (CD). Two separate modules are needed if both directions are of interest.

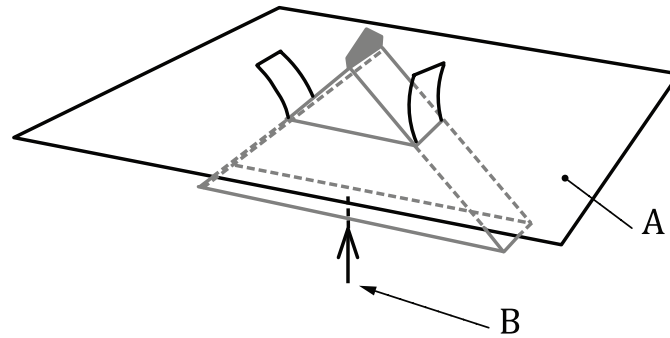

Key

- A test piece
- B tearing force

Figure 2 — Example 1 of a tear module for automated off-line measurements

The tearing test involves tearing by a force acting perpendicular to the surface of the paper.

The test piece is held securely by a pneumatic clamping foot, and tearing is done by a V-shaped tool that is pressed through the test piece. The tool is made of a material that has a very low coefficient of friction relative to the paper. Tearing of the test piece occurs along four lines simultaneously. The initial cut is made by a knife in the top of the tearing tool and the instrument has two separate units: one for the machine direction and one for the cross direction.

The tearing resistance, F_x tearing resistance, value obtained from the instrument x, can differ from that obtained using the Elmendorf tear tester. In these cases, a correction factor may be used.

If a correction factor is used, calculate $F_{\text{Elmendorf}}$ according to [Formula \(1\)](#):

$$F_{\text{Elmendorf}} = F_x \text{ tearing resistance} \times cf \quad (1)$$

where

- cf is the correction factor (depends on the design of the instrument);
- F_x tearing resistance is the tearing resistance value, in millinewton (mN), obtained from the instrument x.

Report the tearing resistance (the tearing resistance can be reported as F_x tearing resistance or $F_{\text{Elmendorf}}$) separately, if required, for the machine direction and cross-direction in millinewtons to three significant figures. If required, calculate and report the tear index separately for the machine direction and cross-direction in millinewton square metres per gram (mNm^2/g), to three significant figures.

[Figure 3](#) shows the basis for the calculations [see also [Formulae \(2\)](#) and [\(3\)](#)] used for an instrument with one type of geometry.

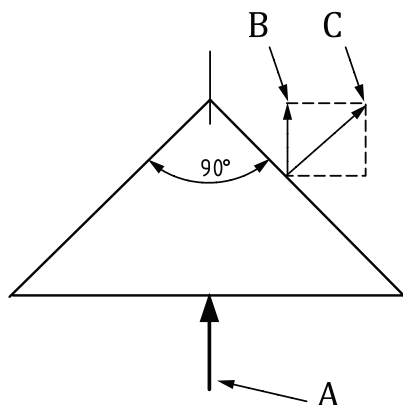

Key

- A $F_{\text{type 1 force transducer}}$
- B $\frac{F_{\text{type 1 force transducer}}}{4}$
- C $F_{\text{type 1 tearing force}}$

Figure 3 — Tear module, geometry type 1

The instrument, geometry as shown in [Figure 3](#), provides mean values of the tearing force, from the four tear lines and calculates the reported $F_{\text{type 1 tearing resistance}}$ (mN) value according to [Formulae \(2\)](#) and [\(3\)](#).

$$F_{\text{type 1 tearing force}} = \frac{F_{\text{type 1 force transducer}}}{4} \times \sqrt{2} \quad (2)$$

$$F_{\text{type 1 tearing resistance}} = \frac{F_{\text{type 1 tearing force}}}{2} \quad (3)$$

where

$F_{\text{type 1 force transducer}}$ is the mean value of the force, in millinewton (mN), recorded by the force transducer during the tearing process. Measured values are collected during a period of about one second, which corresponds approximately to a 25 mm movement of the tearing tool;

$F_{\text{type 1 tearing force}}$ is the tearing force, millinewton (mN), for each section perpendicular to the face of the tool.

NOTE In the Elmendorf method, the distance travelled by the moving clamp during tearing is equivalent to twice the length of tear. In order for the instrument to report values corresponding to those when using the Elmendorf method, [Formula \(1\)](#) is used.

8.5.3 Tear module type 2

[Figure 4](#) shows an instrument with another type of geometry. In this instrument, tearing is done by a V-shaped tool in an angle of 120°. The values corresponding to those when using the Elmendorf method are obtained through calculations using formulae relevant for this type of instrument.

The instrument geometry as shown in [Figure 4](#), provides mean values of the tearing force and calculates the reported $F_{\text{Elmendorf}}$ (mN) value according to [Formula \(4\)](#).

$$F_{\text{Elmendorf}} = F_{\text{type 2 transducer}} \times cf \quad (4)$$

where

- $F_{\text{type 2 transducer}}$ is the measured force, millinewton (mN), from the instrument;
 cf is the correction factor (depends on the design of the instrument).

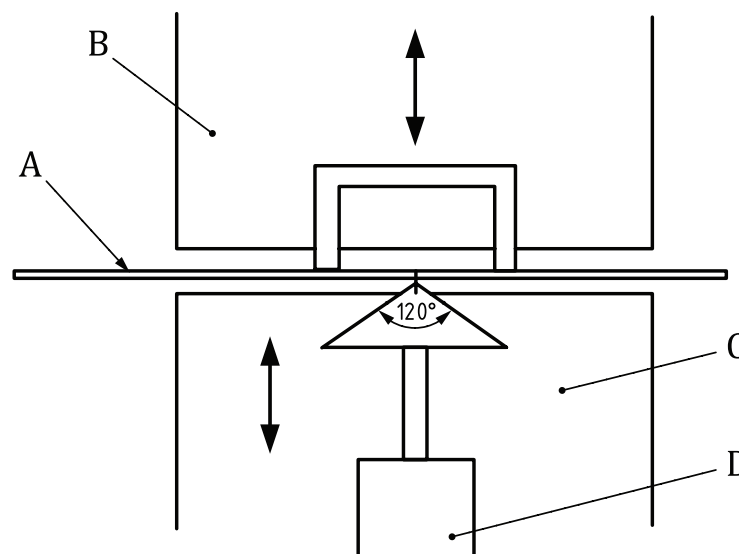

Key

- A test piece
- B clamp
- C tearing unit
- D force sensor

Figure 4 — Tear module, geometry type 2

8.5.4 Other types of tear modules

Other constructions of modules may be available on the market and should be accurately described by the manufacturer. These can use different types of procedures which do not give the same results compared to ISO 1974 and a correlation will then have to be performed with results obtained in conformance with ISO 1974.

8.6 Determination of optical properties

Depending on the type of product, different optical properties are of interest. The instrument shall fulfil the demands of ISO 2469 and shall be calibrated in compliance with the respective illuminant or illuminants required. There are three illuminants, of interest, C/2°, D50/2° and D65/10°.

Some of the optical devices may be equipped with a magazine for backings and/or reference standards.

If the optical device is used as a module in the automated off-line tester, the backing cannot be changed for every CD profile because it will cause a delay in testing. Mill guidelines on when to change the backing shall be used. The backing shall conform to ISO 2469 in the number of sheets used, shall have

the same nominal grammage as the material being measured and have a reflectance factor the same as that of the sample being measured.

If sufficient sheets are not available or if it is desired to measure a background-dependent radiance factor, select a suitable background and include a description of this background in the report. For measurements on non-fluorescent materials, establish two working standards of opal glass, ceramic or other suitable material with flat surfaces.

Instead of paper backing, a ceramic or other equivalent plates can be used. The shade of the plate used shall be similar to the material to be tested. The use of backings rather than an optically thick stack of test pieces should be reported in detail. Recipients of the results produced should be under no illusion that the results that they receive are directly comparable with measurements performed on an optically thick stack of test pieces. For two laboratories to faithfully reproduce each other's test results when evaluating a single sheet of sample above a backing, the same backing should be used at both laboratories.

The use of backings that represent an ideal for the product being tested tend to artificially normalize the results towards the target value depressing the observed variability.

The discrepancies between the results obtained with an optically thick stack of test pieces and a single sheet over a backing need not be large to be significant in a dispute. The difference between being within agreed tolerances or not is rarely a large step. In instances of dispute, results obtained by measurements made on an optically thick stack of test pieces will be given precedence over results obtained by evaluating a single test piece over a backing.

The impact of dust and dirt on the backing is important with respect to the accuracy in measurements. Cleaning/replacement of the ceramic plate once a day is often enough. If a paper backing is used, it is up to the mill to define and to decide how often replacement of the paper pad is required due to the impact of the produced material, width of the machine, amount of dirt and dust, etc.

NOTE There are many different optical devices on the market with different geometry, measuring area, illumination, calibration routines, etc. especially for online measurements. These instruments are not in conformity with the description in ISO 2469.

Determine the required optical properties using the relevant International Standard(s) from [Table 1](#).

Table 1 — Optical property

Optical property	International Standard	
Determination of optical properties C/2°	ISO 2470-1	ISO brightness
	ISO 2471	Opacity
	ISO 5631-1	Colour L*, a*, b*
	ISO 9416	Scattering and absorption coefficient
	ISO 11476	CIE whiteness
Determination of optical properties D50/2°	ISO 5631-3	Colour L*, a*, b*
Determination of optical properties D65/10°	ISO 2470-2	D65 brightness
	ISO 5631-2	Colour L*, a*, b*
	ISO 11475	CIE whiteness

8.7 Determination of bending resistance

8.7.1 General

ISO 2493-1 shall be used as a basis for this test. ISO 2493-1 is based on the two-point loading principle for determining the bending resistance of paper and board within the range 20 mN to 10 000 mN. It is not applicable to corrugated board, but can be applicable to the components of such board.

8.7.2 Example of a bending resistance module

An example of a bending resistance module including the cutting device is shown in [Figures 5](#) and [6](#).

The bending resistance module clamps and then cuts (see [Figure 5](#)) a total of four test pieces along three sides, in order to measure (see [Figure 6](#)) both surfaces (up and down) in MD and CD directions. The test piece should be cut so that the width of the test piece is 38 mm. Carry out the test with a bending length of 50 mm. For test material having a bending resistance which is too low to be measured with a bending length of 50 mm, an alternative module with shorter bending length, 10 mm, may be suitable. Tolerances are given in ISO 2493-1.

Test pieces for upward measurements shall be supported for downward movement after cutting. The test pieces should be horizontal when starting to apply the force of the load cell.

Test piece for downward measurement shall not be supported for downward movements after cutting.

Bend each test piece 15° from the horizontal starting position. For downward measurements, the load cell might need to travel a couple of degrees prior to touching the test piece. For upward measurements, the load cell might be preloaded by the test piece at the start of the test. This should be included in the report.

The bending resistance is the average of the upward and downward result in millinewton.

If the maximum force is obtained before the test piece has been bent through 15°, or a break, kink or crease is observed, the test results are not valid. If more than 10 % of the test pieces exhibit this behaviour, use a bending angle of 7,5° and report the alteration in bending angle.

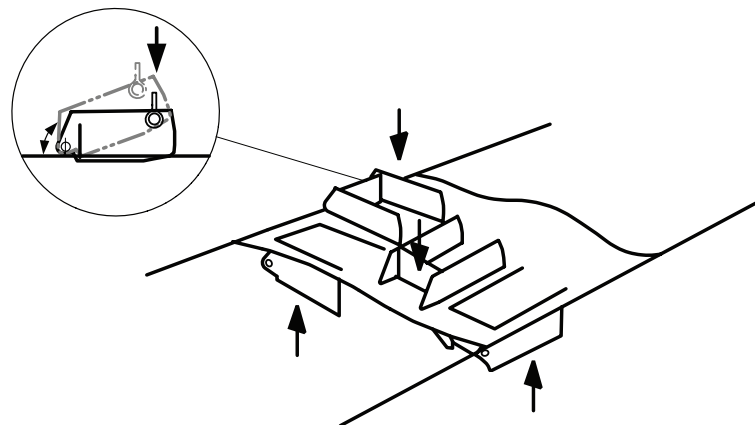
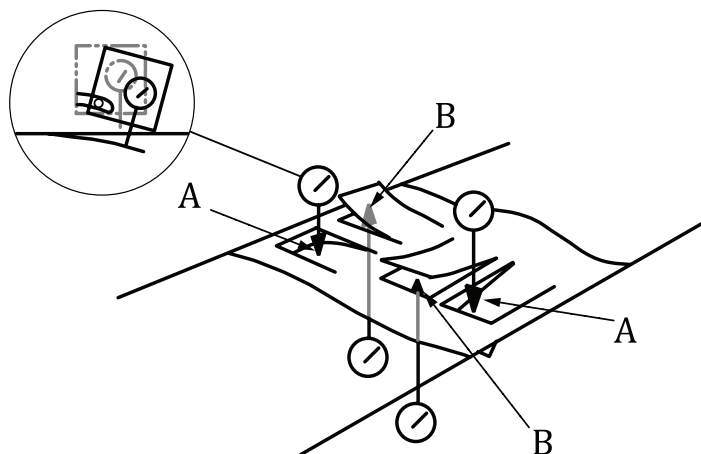

Figure 5 — Cutting device



Key

- A upward measurement
- B downward measurement

Figure 6 — Bending procedure

Testing is normally performed with equal numbers of valid results with opposing surfaces towards the direction of deflection.

Calculate and report the bending resistance for each required direction, machine direction and/or cross direction, in newton or millinewton to three significant figures.

If desired, the bending resistance index can be calculated in Newton metres per unit grams per square metre cubed ($\text{N m}^6/\text{g}^3$) for each required principal direction to three significant figures.

NOTE 1 Results obtained when using different bending lengths will not be comparable.

NOTE 2 The result obtained at $7,5^\circ$ cannot be converted to 15° by multiplying by two, since the relationship is not directly proportional to the bending angle.

8.7.3 Other types of bending resistance modules for automated off-line measurements

These can use different types of procedures which do not give the same results as ISO 2493-1 and correlation will then have to be performed on results obtained using ISO 2493-1.

8.8 Paper — Determination of bursting strength (ISO 2758)

ISO 2758 shall be used for this test. The number of measurements in the CD is decided by the producer with consideration to the machine width.

ISO 2758 is applicable to paper having bursting strengths within the range of 70 kPa to 1 400 kPa. All components of solid and corrugated fibreboard, irrespective of bursting strength, should be tested according to ISO 2759.

The measurement can be done from both sides of the paper with separate measuring units.

Bursting strength is expressed in kilopascals, to the nearest kilopascal.

NOTE Due to differences in the specification of the apparatus, tests made on the same material using the procedures of ISO 2759 and this document will not necessarily give the same results.

8.9 Board — Determination of bursting strength (ISO 2759)

ISO 2759 shall be used. The number of measurements in the CD is decided by the producer with consideration to the machine width.

ISO 2759 is applicable to board having bursting strengths within the range of 350 kPa to 5 500 kPa. For materials with bursting strengths less than 1 400 kPa, an alternative method, based on similar principles, is specified in ISO 2758.

The measurement can be done from both sides of the board with separate measuring units.

Bursting strength is expressed in kilopascals, to the nearest kilopascal.

NOTE Due to differences in the specification of the apparatus, tests made on the same material using the procedures of ISO 2758 and this document will not necessarily give the same results.

8.10 Determination of smoothness — Bekk method (ISO 5627)

ISO 5627 shall be used for this test. The number of measurements in the CD is decided by the producer with consideration to the machine width and possible extended measurement duration of this method.

This method is not recommended for materials with thickness >500 µm or very permeable papers and board, since the amount of air passing through the test piece can influence the result.

Bekk smoothness is dependent on the shape, total volume and distribution of the hollow spaces between the surface of the test piece and a theoretically ideal plane under the specified conditions of contact. The greater the Bekk smoothness number, the smoother the sample.

Test each side, calculate and report the air flow readings in seconds without decimals. Values below 100 Bekk seconds should be reported with one decimal.

8.11 Determination of air permeance — Bendtsen method (ISO 5636-3)

ISO 5636-3 shall be used. The number of measurements in the CD is decided by the producer with consideration to the machine width.

ISO 5636-3 is applicable to papers and boards with air permeances between 0,35 µm/(Pa·s) and 15 µm/(Pa·s). This corresponds to a range between 30 ml/min and 1 330 ml/min.

ISO 5636-3 is unsuitable for rough-surfaced materials which cannot be securely clamped to avoid leakage.

There is at least one type of module which conforms with ISO 5636-3, the Bendtsen electronic flow-measuring device.

NOTE 1 There is another type of module that measures air permeance of paper and board, where the values obtained can be recalculated using algorithms to give air permeance values in accordance with the Bendtsen, Gurley and Sheffield methods. This type shows good correlation to ISO 5636-3 and is based on SCAN P 26:78.^[2] This device has a test area of 50 cm² and a measuring range of 0 ml/min to 5 000 ml/min. The values can be recalculated to a pressure of 1,47 kPa and a test area of 10 cm². The reported value is in the range 0,3 ml/min to 8 800 ml/min.

Calculate the air permeance in micrometres per pascal second, normally for the top side, TS, to three significant figures.

NOTE 2 This property is called air permeance, and not air permeability, because it is reported as a sheet property and is not standardized with respect to thickness to give a material property per unit thickness.

8.12 Paper and board — Determination of air permeance (medium range) — Part 6: Oken method (ISO 5636-6)

ISO 5636-6 shall be used. The number of measurements in the CD is decided by the producer with consideration to the machine width.

ISO 5636-6 is unsuitable for rough-surfaced materials which cannot be securely clamped to avoid leakage.

There is at least one type of module in accordance with ISO 5636-6, the Oken electronic sensor device.

Calculate the air permeance in micrometre per pascal second ($\mu\text{m}/\text{P}\cdot\text{s}$), normally for the top side (TS) to two significant figures.

If the air resistance is required, this shall be reported as “air resistance” (Oken) in seconds. Report the air resistance to two significant figures.

NOTE This property is called air permeance, and not air permeability, because it is reported as a sheet property and is not standardized with respect to thickness to give a material property per unit thickness.

8.13 Measurement of specular gloss — Part 1: 75° gloss with a converging beam, TAPPI method (ISO 8254-1)

ISO 8254-1 shall be used for this test. The number of measurements in the CD is decided by the producer with consideration to the machine width.

ISO 8254-1 specifies a method for measuring the specular gloss of paper at an angle of 75° to the normal to the paper surface. Although it is mainly applicable to coated papers, it may also be used for glossy uncoated papers such as supercalendered papers.

According to ISO 8254-1, the specular gloss shall be determined for all four directions, i.e. in the machine direction and counter-machine direction and in both cross directions and the mean value shall be calculated. If the gloss of both sides of the paper is being determined, data shall be recorded for the two sides of the paper separately. It is impractical to carry out this procedure in the automated off-line tester.

Measurements shall be performed in the MD and/or in the CD as well as TS and/or BS. One measurement in each position is performed giving gloss for machine direction top side (MD/TS), machine direction bottom side (MD/BS) or cross direction top side (CD/TS) and cross direction bottom side (CD/BS).

Calculate the mean value, for each side if required, to three significant figures.

This method does not provide an assessment of image-reflecting quality and should not be used for cast-coated, lacquered, highly varnished or waxed papers or for high-gloss ink films. For these purposes, measurements should be made at other angles, for example as specified in ISO 8254-3.

8.14 Measurement of specular gloss — Part 2: 75° gloss with a parallel beam, DIN method (ISO 8254-2)

ISO 8254-2 shall be used for this test. The number of measurements in the CD is decided by the producer with consideration to the machine width.

ISO 8254-2 specifies a method for measuring the specular gloss of paper at an angle of 75° to the normal to the paper surface. Although it is mainly applicable to coated papers, it may also be used for glossy uncoated papers such as supercalendered papers.

According to ISO 8254-2, the specular gloss shall be determined for all four directions, i.e. in the machine direction and counter-machine direction and in both cross directions and mean value shall be calculated. If the gloss of both sides of the paper is being determined, data shall be recorded for the two sides of the paper separately. It is impractical to carry out this procedure in the automated off-line tester.

Measurements are performed in the machine direction (MD) or cross direction (CD). It is possible to measure both sides of the sample if different units are used. One measurement in each position is performed giving gloss MD/TS, MD/BS or CD/TS, CD/BS.

Calculate the mean value, for each side if required, to three significant figures.

This method does not provide an assessment of image-reflecting quality and should not be used for cast-coated, lacquered, highly varnished or waxed papers or for high-gloss ink films. For these purposes, measurements should be made at other angles, for example as specified in ISO 8254-3.

8.15 Measurement of specular gloss — Part 3: 20° gloss with a converging beam, TAPPI method (ISO 8254-3)

ISO 8254-3 shall be used for this test. The number of measurements in the CD is decided by the producer with consideration to the machine width.

ISO 8254-3 specifies a method for measuring the specular gloss of paper at an angle of 20° to the normal to the paper surface. It is applicable chiefly to highly glossy surfaces, such as cast-coated, lacquered, highly varnished or waxed papers and high-gloss ink films.

According to ISO 8254-3, the specular gloss shall be determined for all four directions, i.e. in the machine direction and counter-machine direction and in both cross directions and the mean value shall be calculated. If the gloss of both sides of the paper is being determined, data shall be recorded for the two sides of the paper separately. It is impractical to carry out this procedure in the automated off-line tester.

Measurements shall be performed in the MD and/or in the CD as well as TS and/or BS. One measurement in each position is performed giving gloss for machine direction top side (MD/TS), machine direction bottom side (MD/BS) or cross direction top side (CD/TS) and cross direction bottom side (CD/BS).

Calculate the mean value, for each side if required, to three significant figures.

8.16 Determination of roughness/smoothness — Bendtsen method (ISO 8791-2)

ISO 8791-2 shall be used for this test. The number of measurements in the CD is decided by the producer with consideration to the machine width.

This part is applicable to paper and board which have Bendtsen roughness values between about 50 ml/min and 5 000 ml/min when measured with electronic type testers.

The Bendtsen roughness can be determined using one or several measuring heads. Separate measuring heads shall be used if both sides of the sample are to be measured.

For each side tested, calculate and report the air flow readings in millilitre per minute to three significant figures.

8.17 Determination of roughness/smoothness — Print-surf method (ISO 8791-4)

ISO 8791-4 shall be used for this test. The number of measurements in the CD is decided by the producer with consideration to the machine width.

The print-surf roughness can be determined using one or several measuring heads. Separate measuring heads shall be used if both sides of the sample are to be measured.

There are two types of print-surf testers. In automated off-line testers the impedance type is dominant. The test piece is placed between a circular flat metal sensing surface and a resilient backing, most commonly a soft backing.

There are two clamping pressure possibilities either 980 kPa ± 30 kPa or 1 960 kPa ± 30 kPa. The most common clamping pressure is 980 kPa ± 30 kPa.

The print-surf roughness is expressed directly as the average value roughness, in micrometres, with two decimals for each clamping pressure. If required, the print-surf compressibility can be measured and reported in percent to three significant figures.

8.18 Compressive strength — Short-span test (ISO 9895)

ISO 9895 shall be used for this test. The number of measurements in the CD is decided by the producer with consideration to the machine width.

The automated off-line tester can use different types of procedures which do not give the same results compared to ISO 9895 and a correlation will then have to be performed on equipment in accordance with ISO 9895.

ISO 9895 has been developed in order to specify the conditions for determining the compressive strength of paper and board used for the manufacture of containers and boxes. The method is recommended for paper and board with a grammage from 100 g/m² to 400 g/m². The compressive strength is measured on a small area of 0,7 mm × 15 mm. In order to minimize the influence of local variations in the paper, at least 20 determinations are prescribed, but not realistic in the automated off-line testing.

In the automated off-line tester, automated cutting of the test pieces for correct test piece width can be done with a punch. Robot techniques can be used for moving the test piece into the measuring unit.

Report the compressive strength to three significant figures. If required, also report the compressive index, to three significant figures in kilonewton metres per kilogram.

9 Calculation and expression of results

In this document, all calculations and expression of results are based on International Standards used as reference or in special cases like tear, tensile, air permeance Bendtsen, bending resistance, referring to the manual from the supplier of automated off-line tester.

Sufficient statistical data should be provided to allow a thorough assessment of the test measurement uncertainty if the results have not been obtained in accordance with the relevant standards.

10 Test report

The test report shall include the following information:

- a) a reference to this document, i.e. ISO 18522;
- b) all the information necessary for complete identification of the sample of paper or board;
- c) the time from sampling off the reel to the start of testing or after accelerated conditioning;
- d) the atmosphere in the conditioned test room;
- e) a reference to the relevant test methods used and the part of the standard applicable, if appropriate;
- f) any unusual procedures used or features observed during the course of the test;
- g) any operations not specified in this document, or in the International Standards to which reference is made or regarded as optional, which might have affected the results and
- h) the manufacturer of the automated off-line tester including unit type and model number (if more than a single type is used) for each of the individual instruments/tests used.

Annex A (informative)

Accelerated conditioning

A.1 General

This annex describes a method for fast conditioning of CD samples to minimize the change in moisture content during the measurement process and produce moisture contents closer to those when samples are at equilibrium with its surrounding atmosphere. It is important to be able to compare and analyze the values within a CD profile.

A.2 Principle

Air of temperature and relative humidity meeting the requirements for the conditioning atmosphere, as specified in ISO 187, is drawn through the CD sample that is put on a screen by using a vacuum system. [Figure A.1](#) shows an example.

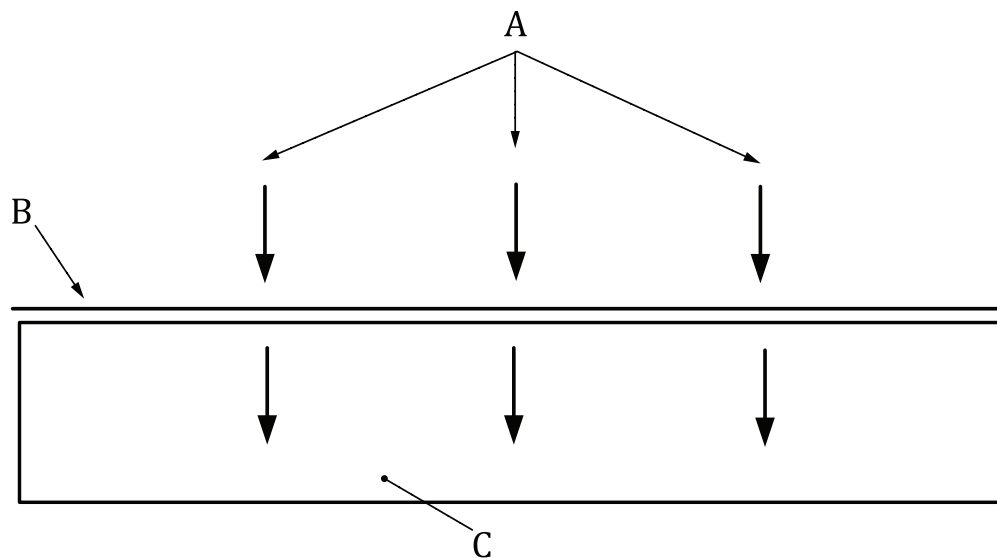

Key

- A conditioned air from the laboratory
- B CD sample
- C table with vacuum system

Figure A.1 — Example of a system for accelerated conditioning

A.3 Apparatus

A screen is mounted on a table with a vacuum pump inside. The sample has to be placed flat against the screen. The table and the screen have to fit the length and width of the CD sample. If the sample is smaller, the visible area(s) of the screen needs to be covered to ensure adequate airflow through the sample (e.g. by roller shutters). The intensity of the vacuum depends on the sample grade and should be regulated so as not to damage the sample by pressing it too hard against the screen.

A.4 Procedure

The lengths of time for which the sample needs to be placed on the equipment for conditioning to produce moisture contents close to those resulting from conditioning according to ISO 187 depends on the properties of the grade (e.g. grammage and porosity). The time for conditioning required to achieve moisture contents close to those resulting from following ISO 187 should be determined at the outset by the user. Depending on the sample and the apparatus this procedure can take between less than 1 min on, for example, cigarette paper and 10 min or more on, for example, high grammage liner board.

Annex B (informative)

Comparison between stand-alone instruments and automated off-line testing of CD profiles

An investigation in which the automated off-line testing was compared with tests using stand-alone instruments, including the impact of conditioning, was conducted in 2013.

The following grades were tested; news print, copy paper, two types of sack paper, coated kraft back (CKB), liquid board and packaging board.

The properties tested were grammage, thickness, tensile strength, stretch at break, tear, roughness (Bendtsen and print surf), optical properties, etc.

All testing was done by each participating mill, with samples from their own mill. No samples were sent or exchanged between the participants.

The following are the testing procedure used for the comparison between stand-alone instruments and automated off-line testing of CD profiles:

- a) 24 h of conditioning on five profiles at 50 % r.h. and 23 °C and testing with stand-alone instruments. Several sheets were cut from three positions: front side (FS), mid and drive side (DS) for testing. The width of the board and paper machines varied from around 3,5 m to about 10 m. The sampling and sheet size were specified for these conditions.
- b) 24 h conditioning on one profile at 50 % r.h. and 23 °C and testing with an automated off-line tester (L&W Autoline, Metso Paper Lab, Technidyne PROFILE/Plus^{TM1}), etc.).
- c) The mill's normal procedures for conditioning and testing on the remaining profiles with automated off-line equipment (L&W Autoline, Metso Paper Lab, Technidyne PROFILE/Plus^{TM1}), etc.). Temperature and r.h. in the machine room were checked and reported.

The results are limited, but in certain tests there would appear to be a fair indication on how well automated testing of CD profiles by both the mill procedure and 24 h conditioning correlate with testing carried out in accordance with the relevant International Standards using properly calibrated stand-alone equipment. Best practice would require regular correlation with properly calibrated stand-alone equipment used in accordance with the relevant International Standards.

Some examples of the results are presented in [Figures B.1](#) to [B.5](#).

Key for [Figures B.1](#) to [B.5](#) is presented in [Table B.1](#).

1) Examples of suitable products available commercially. This information is given for the convenience of users of this document and does not constitute an endorsement by ISO of these products.

Table B.1 — Key to [Figures B.1 to B.5](#)

Key	
■	stand-alone 50 % r.h., 23 °C, 24 h
■	mill procedure, automated tester
■	automated tester, 50 % r.h., 23 °C, 24 h
1	news
2	sack paper 1
3	sack paper 2
4	copy paper
5	coated kraft back (CKB)
6	liquid board
7	coated packaging board

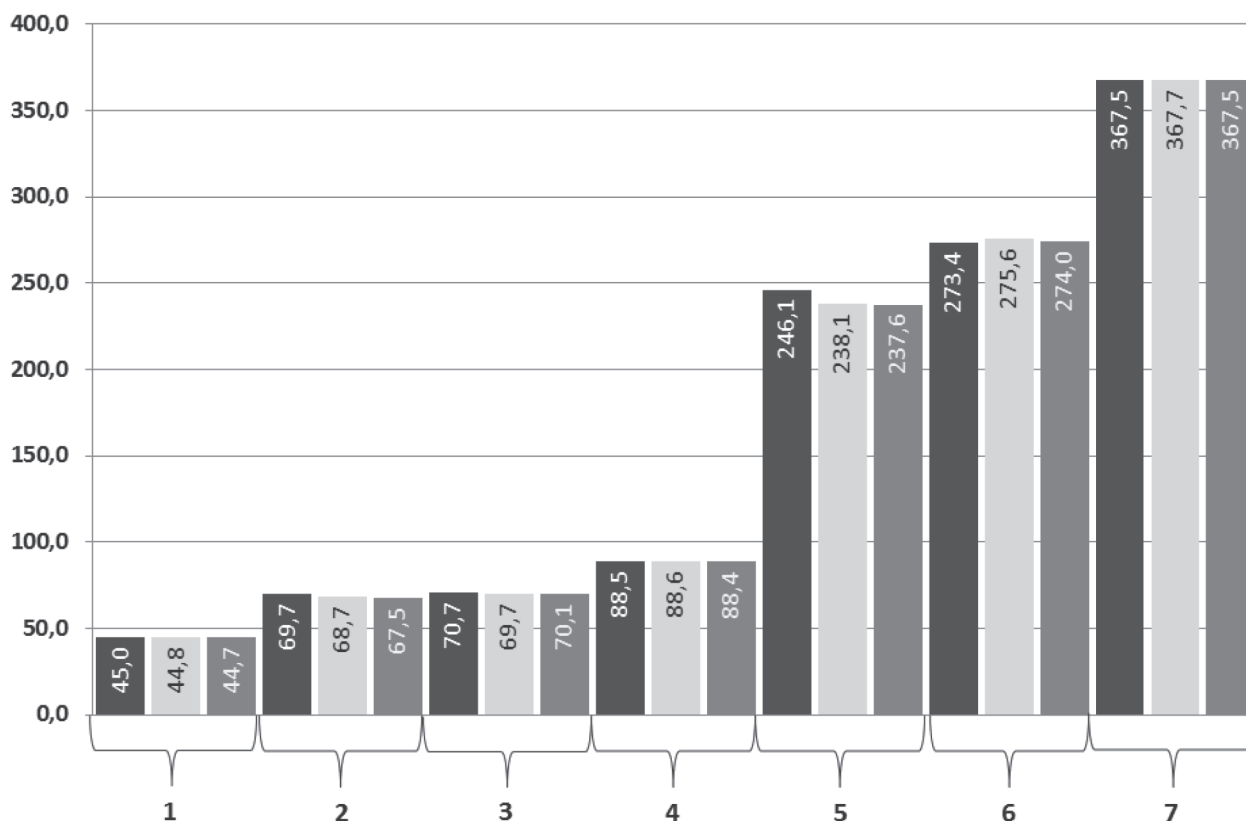

Figure B.1 — Grammage (g/m²) — Different paper and board grades

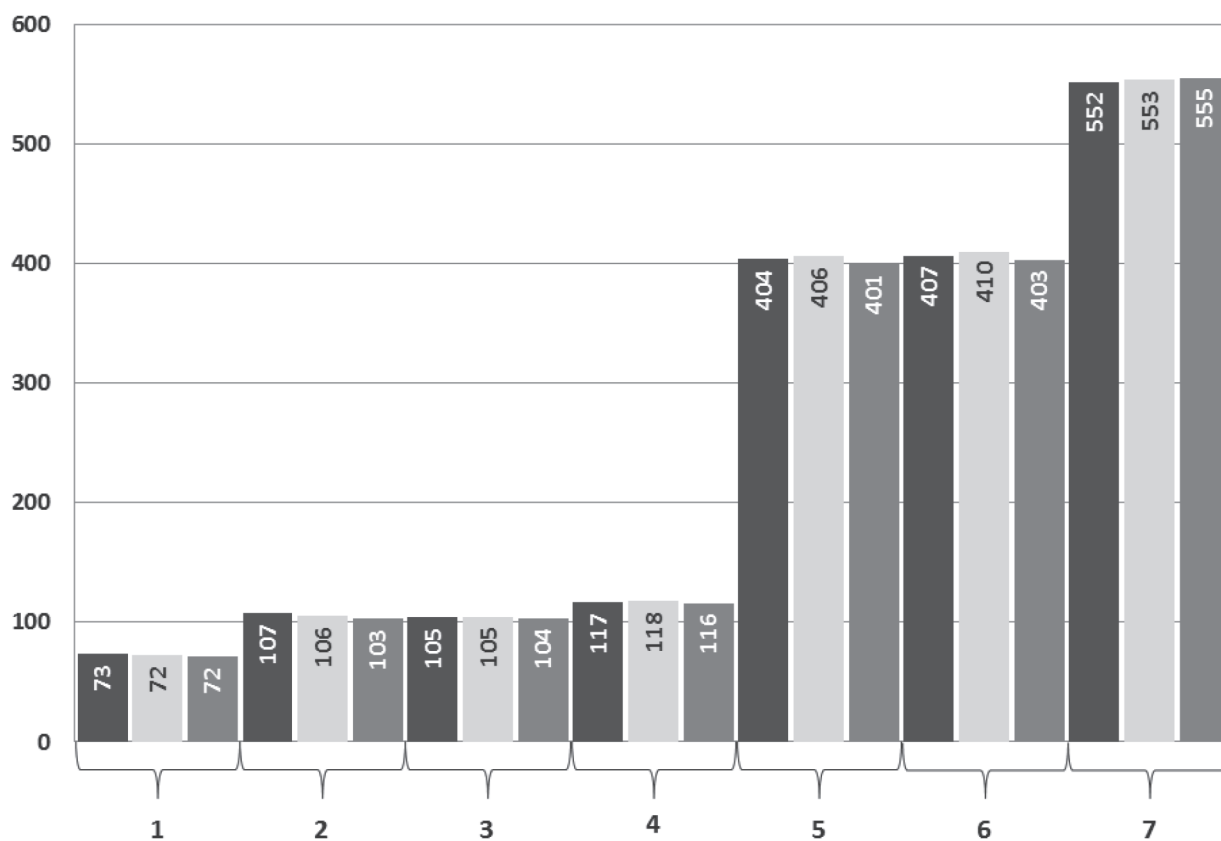

Figure B.2 — Thickness (μm) — Different paper and board grades

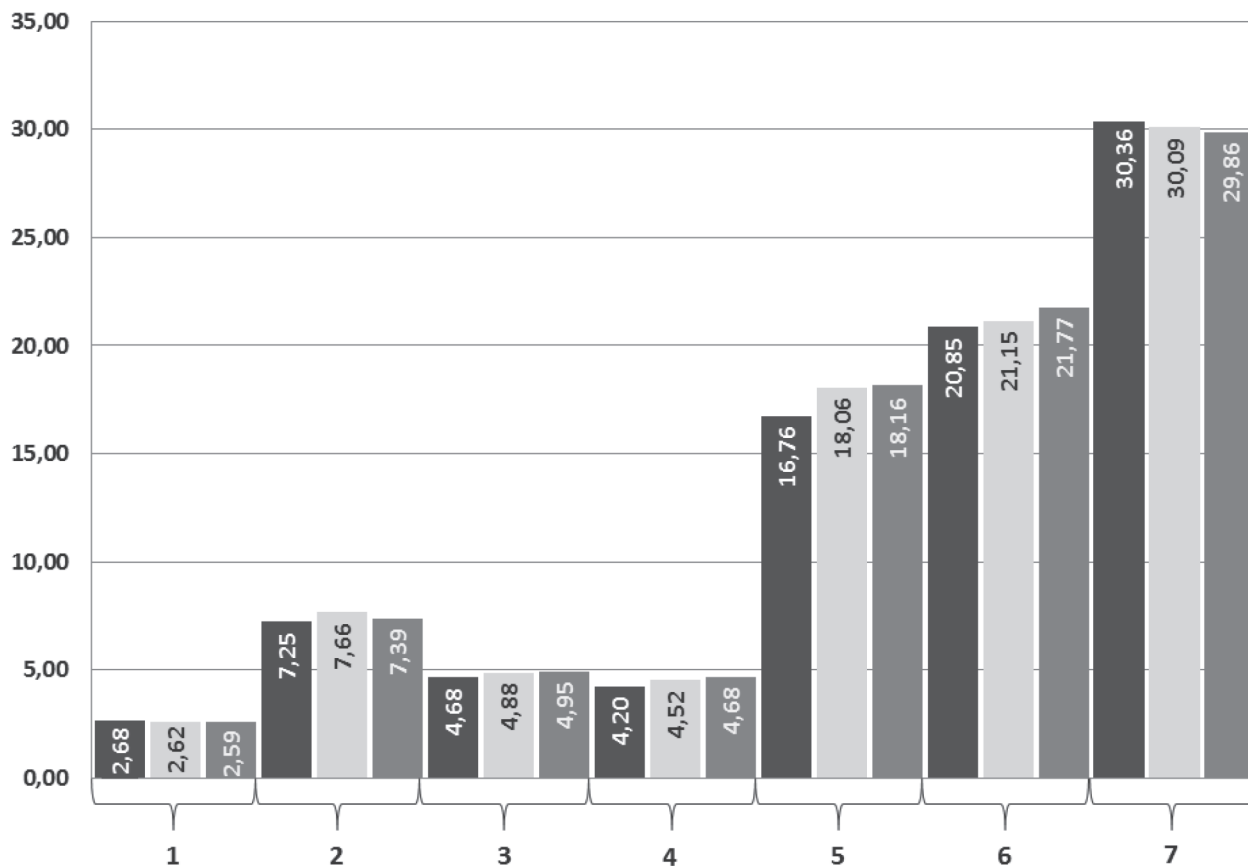

Figure B.3 — Tensile strength (kN/m) — Different paper and board grades (measurements according to ISO 1924-3)

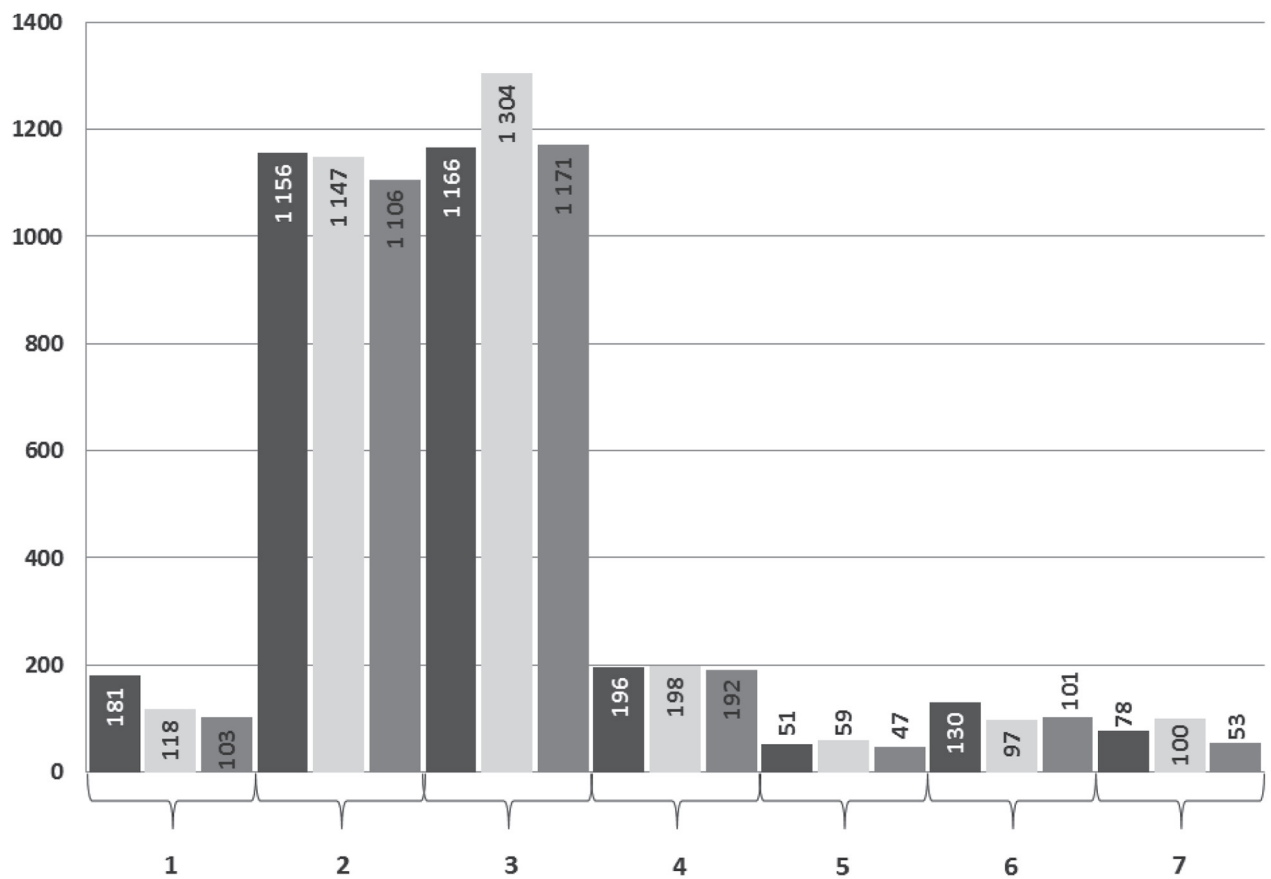
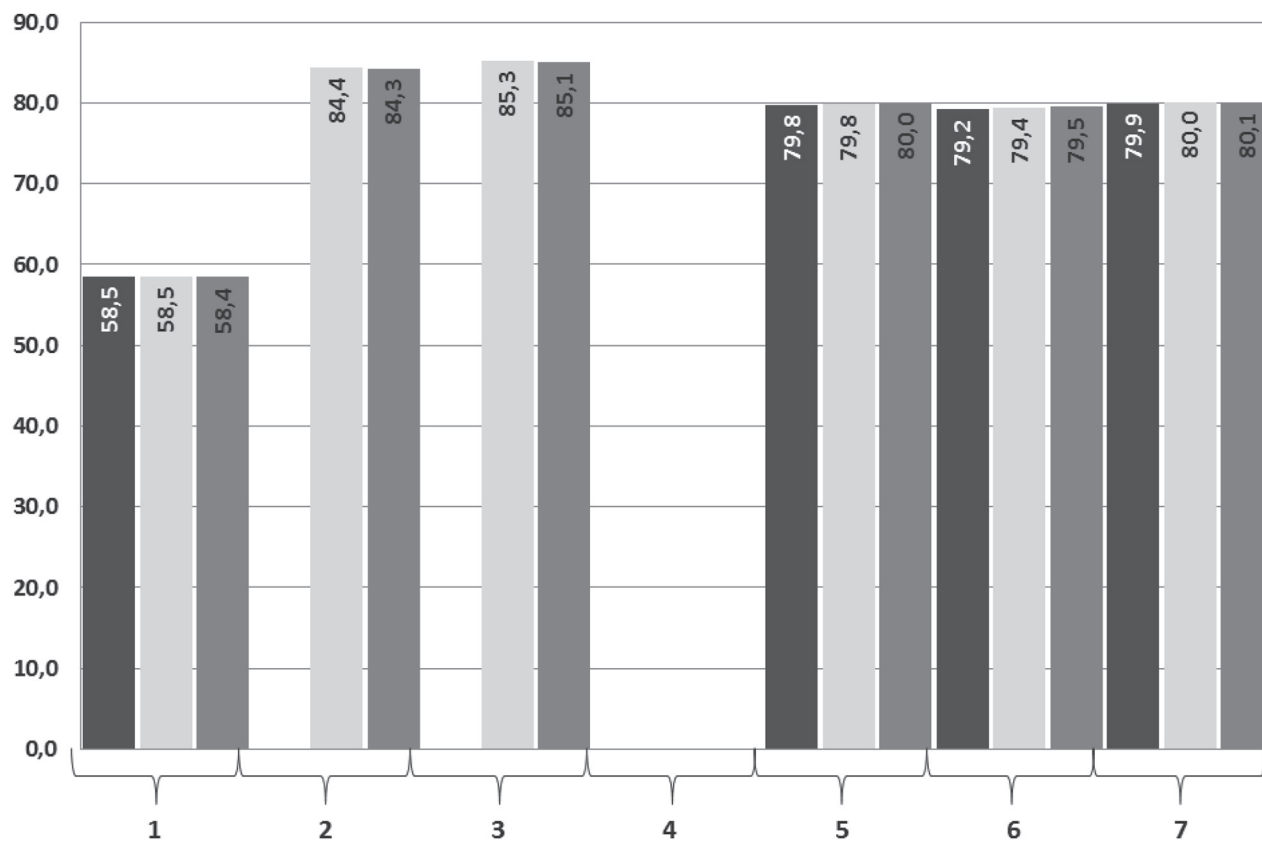

Figure B.4 — Bendtsen roughness (ml/min) — Different paper and board grades



NOTE There are no columns for copy paper (4) as ISO Brightness is not relevant for copy paper.

Figure B.5 — ISO Brightness (%) - Different paper and board grades

Annex C (informative)

Comparison between stand-alone and automated off-line testing with all samples preconditioned and conditioned (ISO 187)

A comparison between stand-alone and automated off-line testing for tensile strength, strain at break and TEA has been made by one laboratory.

All samples were preconditioned for 24 h and then conditioned at 23 °C and 50 % r.h. for 24 h.

Tests were made both for CD and MD. The 25 to 30 measurements were made per grade.

[Table C.1](#) shows the grades that were tested. The results are presented in [Figures C.1](#) to [C.3](#).

Table C.1 — Grades tested

Paper and board grades	Grammage g/m ²
High performance linerboard	270
High performance linerboard	440
Linerboard	127
Linerboard	170
Kraftboard	190
Kraftboard	250
Kraftboard	325
Liquid board	145
Liquid board	186
Sack	90
Fluting medium	170
Copy	80
Printing grade	120
Newsprint	38

Table C.2 — Key to [Figures C.1 to C.3](#)

●	machine direction (MD)	—	linear (MD)	Horizontal axis	Automated tester
▲	cross direction (CD)	⋯	linear (CD)	Vertical axis	Stand-alone

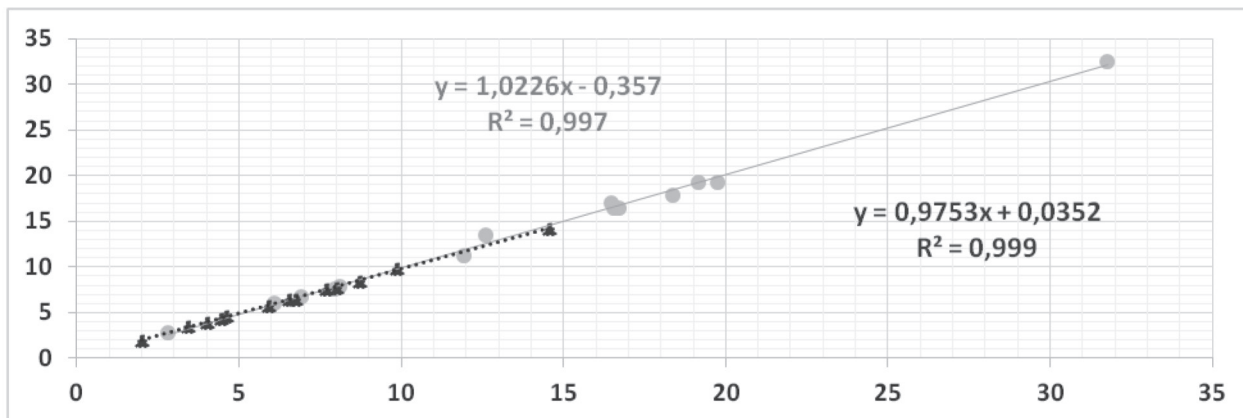

Figure C.1 — Tensile strength (kN/m)

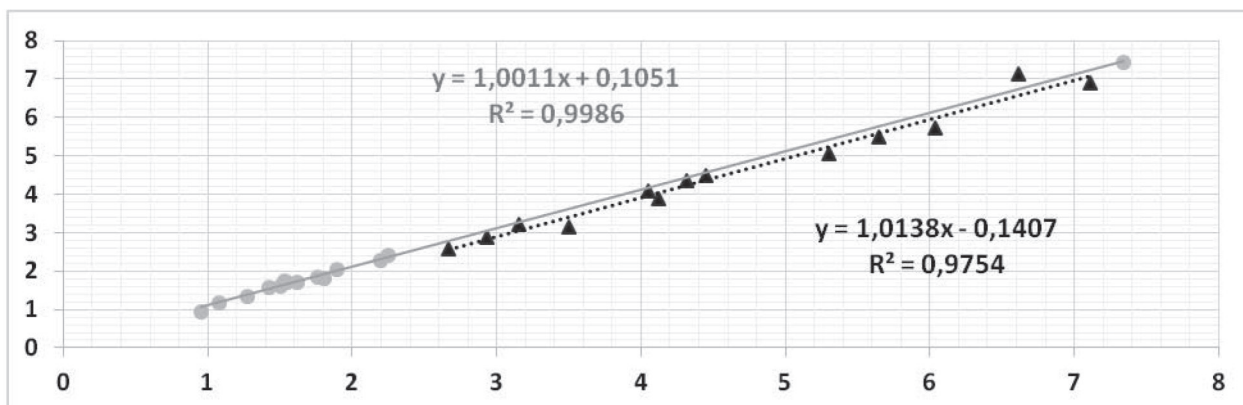

Figure C.2 — Strain at break (%)

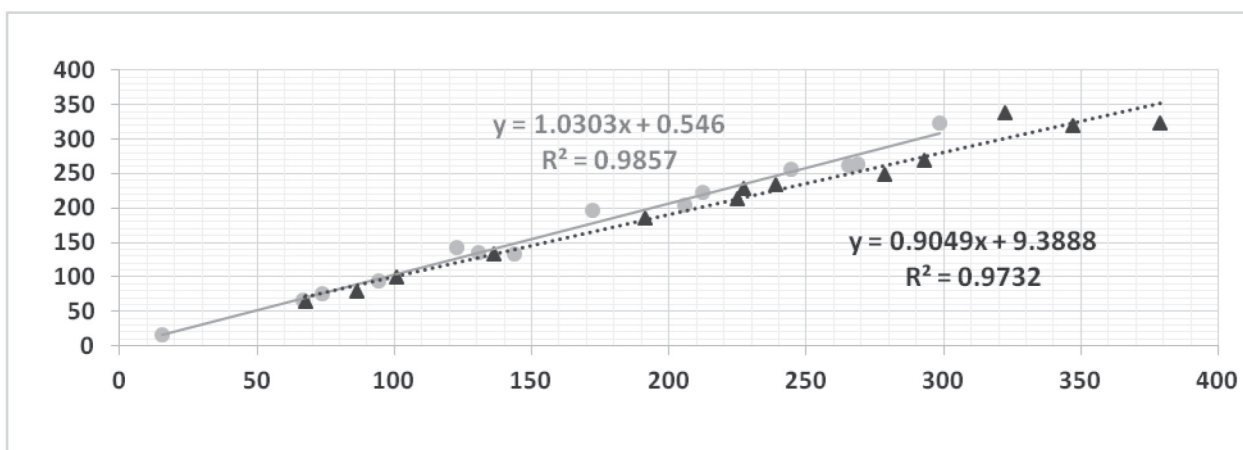

Figure C.3 — Tensile energy absorption (J/m²)

Bibliography

- [1] ISO/TR 24498, *Paper, board and pulps — Estimation of uncertainty for test methods*
- [2] SCAN-P 26:78, *Paper and board — Air Permeance — Method for dense papers*
- [3] TAPPI T 1200 sp-07, *Interlaboratory evaluation of test methods to determine TAPPI repeatability and reproducibility*

British Standards Institution (BSI)

BSI is the national body responsible for preparing British Standards and other standards-related publications, information and services.

BSI is incorporated by Royal Charter. British Standards and other standardization products are published by BSI Standards Limited.

About us

We bring together business, industry, government, consumers, innovators and others to shape their combined experience and expertise into standards-based solutions.

The knowledge embodied in our standards has been carefully assembled in a dependable format and refined through our open consultation process. Organizations of all sizes and across all sectors choose standards to help them achieve their goals.

Information on standards

We can provide you with the knowledge that your organization needs to succeed. Find out more about British Standards by visiting our website at bsigroup.com/standards or contacting our Customer Services team or Knowledge Centre.

Buying standards

You can buy and download PDF versions of BSI publications, including British and adopted European and international standards, through our website at bsigroup.com/shop, where hard copies can also be purchased.

If you need international and foreign standards from other Standards Development Organizations, hard copies can be ordered from our Customer Services team.

Copyright in BSI publications

All the content in BSI publications, including British Standards, is the property of and copyrighted by BSI or some person or entity that owns copyright in the information used (such as the international standardization bodies) and has formally licensed such information to BSI for commercial publication and use.

Save for the provisions below, you may not transfer, share or disseminate any portion of the standard to any other person. You may not adapt, distribute, commercially exploit, or publicly display the standard or any portion thereof in any manner whatsoever without BSI's prior written consent.

Storing and using standards

Standards purchased in soft copy format:

- A British Standard purchased in soft copy format is licensed to a sole named user for personal or internal company use only.
- The standard may be stored on more than 1 device provided that it is accessible by the sole named user only and that only 1 copy is accessed at any one time.
- A single paper copy may be printed for personal or internal company use only.

Standards purchased in hard copy format:

- A British Standard purchased in hard copy format is for personal or internal company use only.
- It may not be further reproduced – in any format – to create an additional copy. This includes scanning of the document.

If you need more than 1 copy of the document, or if you wish to share the document on an internal network, you can save money by choosing a subscription product (see 'Subscriptions').

Reproducing extracts

For permission to reproduce content from BSI publications contact the BSI Copyright & Licensing team.

Subscriptions

Our range of subscription services are designed to make using standards easier for you. For further information on our subscription products go to bsigroup.com/subscriptions.

With **British Standards Online (BSOL)** you'll have instant access to over 55,000 British and adopted European and international standards from your desktop. It's available 24/7 and is refreshed daily so you'll always be up to date.

You can keep in touch with standards developments and receive substantial discounts on the purchase price of standards, both in single copy and subscription format, by becoming a **BSI Subscribing Member**.

PLUS is an updating service exclusive to BSI Subscribing Members. You will automatically receive the latest hard copy of your standards when they're revised or replaced.

To find out more about becoming a BSI Subscribing Member and the benefits of membership, please visit bsigroup.com/shop.

With a **Multi-User Network Licence (MUNL)** you are able to host standards publications on your intranet. Licences can cover as few or as many users as you wish. With updates supplied as soon as they're available, you can be sure your documentation is current. For further information, email subscriptions@bsigroup.com.

Revisions

Our British Standards and other publications are updated by amendment or revision.

We continually improve the quality of our products and services to benefit your business. If you find an inaccuracy or ambiguity within a British Standard or other BSI publication please inform the Knowledge Centre.

Useful Contacts

Customer Services

Tel: +44 345 086 9001

Email (orders): orders@bsigroup.com

Email (enquiries): cservices@bsigroup.com

Subscriptions

Tel: +44 345 086 9001

Email: subscriptions@bsigroup.com

Knowledge Centre

Tel: +44 20 8996 7004

Email: knowledgecentre@bsigroup.com

Copyright & Licensing

Tel: +44 20 8996 7070

Email: copyright@bsigroup.com

BSI Group Headquarters

389 Chiswick High Road London W4 4AL UK