

BS ISO 18439:2013



BSI Standards Publication

# Space data and information transfer systems — Space Communication Cross Support — Service Management — Service Specification

NO COPYING WITHOUT BSI PERMISSION EXCEPT AS PERMITTED BY COPYRIGHT LAW

*raising standards worldwide™*



**National foreword**

This British Standard is the UK implementation of ISO 18439:2013.

The UK participation in its preparation was entrusted to Technical Committee ACE/68/-/7, Space systems and operations - Space data and information transfer systems.

A list of organizations represented on this committee can be obtained on request to its secretary.

This publication does not purport to include all the necessary provisions of a contract. Users are responsible for its correct application.

© The British Standards Institution 2013. Published by BSI Standards Limited 2013

ISBN 978 0 580 80295 9

ICS 49.140

**Compliance with a British Standard cannot confer immunity from legal obligations.**

This British Standard was published under the authority of the Standards Policy and Strategy Committee on 30 June 2013.

**Amendments issued since publication**

Date	Text affected
------	---------------

---

---

---

**Space data and information transfer  
systems — Space Communication Cross  
Support — Service Management —  
Service Specification**

*Systemes de transfert des informations et données spatiales — Support  
croisé pour les communications spatiales — Gestion des services —  
Spécification des services*





**COPYRIGHT PROTECTED DOCUMENT**

© ISO 2013

All rights reserved. Unless otherwise specified, no part of this publication may be reproduced or utilized otherwise in any form or by any means, electronic or mechanical, including photocopying, or posting on the internet or an intranet, without prior written permission. Permission can be requested from either ISO at the address below or ISO's member body in the country of the requester.

ISO copyright office  
Case postale 56 • CH-1211 Geneva 20  
Tel. + 41 22 749 01 11  
Fax + 41 22 749 09 47  
E-mail [copyright@iso.org](mailto:copyright@iso.org)  
Web [www.iso.org](http://www.iso.org)

Published in Switzerland

## Foreword

ISO (the International Organization for Standardization) is a worldwide federation of national standards bodies (ISO member bodies). The work of preparing International Standards is normally carried out through ISO technical committees. Each member body interested in a subject for which a technical committee has been established has the right to be represented on that committee. International organizations, governmental and non-governmental, in liaison with ISO, also take part in the work. ISO collaborates closely with the International Electrotechnical Commission (IEC) on all matters of electrotechnical standardization.

The procedures used to develop this document and those intended for its further maintenance are described in the ISO/IEC Directives, Part 1. In particular the different approval criteria needed for the different types of ISO documents should be noted. This document was drafted in accordance with the editorial rules of the ISO/IEC Directives, Part 2. [www.iso.org/directives](http://www.iso.org/directives)

Attention is drawn to the possibility that some of the elements of this document may be the subject of patent rights. ISO shall not be held responsible for identifying any or all such patent rights. Details of any patent rights identified during the development of the document will be in the Introduction and/or on the ISO list of patent declarations received. [www.iso.org/patents](http://www.iso.org/patents)

Any trade name used in this document is information given for the convenience of users and does not constitute an endorsement.

ISO 18439 was prepared by the Consultative Committee for Space Data Systems (CCSDS) (as CCSDS 910.11-B-1, August 2009) and was adopted (without modifications except those stated in Clause 2 of this International Standard) by Technical Committee ISO/TC 20, *Aircraft and space vehicles*, Subcommittee SC 13, *Space data and information transfer systems*.



# Space data and information transfer systems — Space Communication Cross Support — Service Management — Service Specification

## 1 Scope

It is common practice for management information to be exchanged between space mission management and a space link service provider for the purposes of negotiating, configuring, and executing the Tracking, Telemetry, and Command (TT&C) functions and cross support transfer services that are provided to the space mission. The various processes that generate, exchange, ingest, and act upon this management information are collectively referred to as *service management*.

This International Standard defines a set of *Space Communication Cross Support Service Management (SCCS-SM) services* by which space link service providers and space missions exchange information needed to arrange spacecraft contact periods and establish the operating parameters of the space link services and cross support transfer services during those contact periods.

The SCCS-SM services reflect the common practices of the space operations community and the contents of the SLE transfer specifications. Four SCCS Management Services are defined:

- a) Service Agreement service, which addresses the information that needs to be agreed before a cross support service can be established;
- b) Configuration Profile service, which addresses the establishment of sets of data concerning the space link and ground station configuration;
- c) Trajectory Prediction service, which addresses the transfer and updating of spacecraft trajectory data;
- d) Service Package service, which addresses the arrangement of spacecraft space link session times and execution of the transfer services.

This International Standard deals with only three of the SLE transfer services defined in the *Cross Support Reference Model*:

- a) Forward Communications Link Transmission Unit (FCLTU);
- b) Return All Frames (RAF);
- c) Return Channel Frames (RCF).

The management of other SLE transfer services, including Return Operations Control Field (ROCF), Forward Space Packet (FSP), supported by the Communications Operation Procedure-1, and a radiometric data transfer service, will be addressed in future versions of this International Standard.

This International Standard addresses the management of both online and offline return SLE transfer services. In this International Standard, online return services are part of a larger class of services referred to as Space Link Session Transfer Services (because they are concurrent with an active space link), and offline services are part of a larger class of services referred to as Retrieval Transfer Services (because they are the mechanism by which data are retrieved from intermediate storage).

This International Standard addresses the management of user-initiated transfer services only. Although some of the SLE transfer service specifications permit provider initiation, all implementations of SLE transfer services are user-initiated as of the time of the writing of this International Standard. Therefore, under this version of SCCS-SM, the initiator is always the user, and the responder is always the provider.

This International Standard provides a mechanism for defining and scheduling non-CCSDS transfer services that are bilaterally defined between the Complex and MDOS. RF and ModuLation Systems and Space Link Services Addressed in this Recommended Standard

This International Standard supports the exchange of information used in scheduling of services that employ radio frequency (RF) and modulation systems that are conformant with the CCSDS Recommended Standard 401.0, *Radio Frequency and Modulation Systems—Part 1: Earth Stations and Spacecraft*. Space link service providers that provide RF links that conform to CCSDS 401.0 can implement the full set of capabilities specified herein. However, the capabilities provided by this International Standard for space communication service scheduling information exchange are not strictly limited to those recommended in CCSDS 401: for example, this International Standard supports the use of additional forward subcarrier frequencies beyond those specified in CCSDS 401.

Space link service providers that provide RF links that *do not* conform to CCSDS 401.0 or the extended parameters and values supported by this International Standard may use bilaterally defined space link service information, or may simply implement a subset of the capabilities specified herein.

This version of the International Standard contains the following limitations, constraints, exclusions and qualifications:

- a) The concept of *staging* in the *Cross Support Reference Model*—distributing the provision of transfer services across two or more Complexes that progressively process and transform a data stream—is not addressed in this document.
- b) This International Standard does not address the mechanism for exchanging authentication and access control information associated with the creation of transfer service credentials.
- c) Ground systems and services that are not directly concerned with the transport of transfer frames and communications link transmission units compliant to CCSDS Recommended Standards are not described. Processing of data held within the data fields of source packet Protocol Data Units (PDUs) is outside the scope of this document.
- d) The initial establishment of a service relationship and the negotiation of a mission-length Service Agreement are not covered by this International Standard.
- e) This International Standard does not define the operations and messages required to perform execution-time monitoring and control of transfer services.
- f) The specification of systems to generate information required by SCCS-SM, such as mission planning (scheduling), flight dynamics (trajectory), mission monitoring and control, and ground station selection are outside the scope of this document. It is assumed that these systems will provide the data needed in the required format at the required times.
- g) SCCS-SM does not define the way in which Complex Management (CM) interfaces with the equipment that is used to provide the space link and transfer services, so the users in the MDOS do not need to be concerned about the internal workings of the Complex. In other words, Complex Management provides an interface to the user that hides the complexity of the provider's Complex.

The scope and field of application are furthermore detailed in subclause 1.4 of the enclosed CCSDS publication.



## 2 Requirements

Requirements are the technical recommendations made in the following publication (reproduced on the following pages), which is adopted as an International Standard:

CCSDS 910.11-B-1, August 2009, Space Communication Cross Support — Service Management — Service Specification.

For the purposes of international standardization, the modifications outlined below shall apply to the specific clauses and paragraphs of publication CCSDS 910.11-B-1.

*Pages i to v*

This part is information which is relevant to the CCSDS publication only.

*Page 1-19 and 1-20*

Add the following information to the reference indicated:

- [1] Document CCSDS 910.4-B-2, October 2005, is equivalent to ISO 15396:2007.
- [2] Document CCSDS 132.0-B-1, September 2003, is equivalent to ISO 22645:2005.
- [3] Document CCSDS 133.0-B-1, September 2003, is equivalent to ISO 22646:2005.
- [4] Document CCSDS 131.0-B-1, September 2003, is equivalent to ISO 22641:2012.
- [5] Document CCSDS 732.0-B-2, July 2006, is equivalent to ISO 22666:2007.
- [6] Document CCSDS 231.0-B-1, September 2003, is equivalent to ISO 22642:2005.
- [7] Document CCSDS 232.1-B-1, September 2003, is equivalent to ISO 22667:2005.
- [8] Document CCSDS 911.1-B-2, December 2004, is equivalent to ISO 22669:2007.
- [9] Document CCSDS 911.2-B-2, December 2004, is equivalent to ISO 22670:2006.
- [10] Document CCSDS 911.5-B-2, December 2004, is equivalent to ISO 26143:2007.
- [11] Document CCSDS 912.1-B-2, December 2004, is equivalent to ISO 22671:2011.
- [12] Document CCSDS 912.3-B-1, December 2004, is equivalent to ISO 22672:2011.
- [13] Document CCSDS 502.0-B-1, September 2004, is equivalent to ISO 22644:2006.

## 3 Revision of publication CCSDS 910.11-B-1

It has been agreed with the Consultative Committee for Space Data Systems that Subcommittee ISO/TC 20/SC 13 will be consulted in the event of any revision or amendment of publication CCSDS 910.11-B-1. To this end, NASA will act as a liaison body between CCSDS and ISO.

(Blank page)

## Recommendation for Space Data System Standards

**SPACE COMMUNICATION  
CROSS SUPPORT—  
SERVICE MANAGEMENT—  
SERVICE SPECIFICATION**

**RECOMMENDED STANDARD**

**CCSDS 910.11-B-1**

**BLUE BOOK**  
**August 2009**

## AUTHORITY

Issue:	Recommended Standard, Issue 1
Date:	August 2009
Location:	Washington, DC, USA

This document has been approved for publication by the Management Council of the Consultative Committee for Space Data Systems (CCSDS) and represents the consensus technical agreement of the participating CCSDS Member Agencies. The procedure for review and authorization of CCSDS documents is detailed in the *Procedures Manual for the Consultative Committee for Space Data Systems*, and the record of Agency participation in the authorization of this document can be obtained from the CCSDS Secretariat at the address below.

This document is published and maintained by:

CCSDS Secretariat  
Space Communications and Navigation Office, 7L70  
Space Operations Mission Directorate  
NASA Headquarters  
Washington, DC 20546-0001, USA

## STATEMENT OF INTENT

The Consultative Committee for Space Data Systems (CCSDS) is an organization officially established by the management of its members. The Committee meets periodically to address data systems problems that are common to all participants, and to formulate sound technical solutions to these problems. Inasmuch as participation in the CCSDS is completely voluntary, the results of Committee actions are termed **Recommended Standards** and are not considered binding on any Agency.

This **Recommended Standard** is issued by, and represents the consensus of, the CCSDS members. Endorsement of this **Recommendation** is entirely voluntary. Endorsement, however, indicates the following understandings:

- o Whenever a member establishes a CCSDS-related **standard**, this **standard** will be in accord with the relevant **Recommended Standard**. Establishing such a **standard** does not preclude other provisions which a member may develop.
- o Whenever a member establishes a CCSDS-related **standard**, that member will provide other CCSDS members with the following information:
  - The **standard** itself.
  - The anticipated date of initial operational capability.
  - The anticipated duration of operational service.
- o Specific service arrangements shall be made via memoranda of agreement. Neither this **Recommended Standard** nor any ensuing **standard** is a substitute for a memorandum of agreement.

No later than five years from its date of issuance, this **Recommended Standard** will be reviewed by the CCSDS to determine whether it should: (1) remain in effect without change; (2) be changed to reflect the impact of new technologies, new requirements, or new directions; or (3) be retired or canceled.

In those instances when a new version of a **Recommended Standard** is issued, existing CCSDS-related member standards and implementations are not negated or deemed to be non-CCSDS compatible. It is the responsibility of each member to determine when such standards or implementations are to be modified. Each member is, however, strongly encouraged to direct planning for its new standards and implementations towards the later version of the Recommended Standard.

## FOREWORD

Through the process of normal evolution, it is expected that expansion, deletion, or modification of this document may occur. This Recommended Standard is therefore subject to CCSDS document management and change control procedures, which are defined in the *Procedures Manual for the Consultative Committee for Space Data Systems*. Current versions of CCSDS documents are maintained at the CCSDS Web site:

<http://www.ccsds.org/>

Questions relating to the contents or status of this document should be addressed to the CCSDS Secretariat at the address indicated on page i.

At time of publication, the active Member and Observer Agencies of the CCSDS were:

### Member Agencies

- Agenzia Spaziale Italiana (ASI)/Italy.
- British National Space Centre (BNSC)/United Kingdom.
- Canadian Space Agency (CSA)/Canada.
- Centre National d'Etudes Spatiales (CNES)/France.
- China National Space Administration (CNSA)/People's Republic of China.
- Deutsches Zentrum für Luft- und Raumfahrt e.V. (DLR)/Germany.
- European Space Agency (ESA)/Europe.
- Russian Federal Space Agency (RFSA)/Russian Federation.
- Instituto Nacional de Pesquisas Espaciais (INPE)/Brazil.
- Japan Aerospace Exploration Agency (JAXA)/Japan.
- National Aeronautics and Space Administration (NASA)/USA.

### Observer Agencies

- Austrian Space Agency (ASA)/Austria.
- Belgian Federal Science Policy Office (BFSPPO)/Belgium.
- Central Research Institute of Machine Building (TsNIIMash)/Russian Federation.
- Centro Tecnico Aeroespacial (CTA)/Brazil.
- Chinese Academy of Sciences (CAS)/China.
- Chinese Academy of Space Technology (CAST)/China.
- Commonwealth Scientific and Industrial Research Organization (CSIRO)/Australia.
- CSIR Satellite Applications Centre (CSIR)/Republic of South Africa.
- Danish National Space Center (DNSC)/Denmark.
- European Organization for the Exploitation of Meteorological Satellites (EUMETSAT)/Europe.
- European Telecommunications Satellite Organization (EUTELSAT)/Europe.
- Geo-Informatics and Space Technology Development Agency (GISTDA)/Thailand.
- Hellenic National Space Committee (HNSC)/Greece.
- Indian Space Research Organization (ISRO)/India.
- Institute of Space Research (IKI)/Russian Federation.
- KFKI Research Institute for Particle & Nuclear Physics (KFKI)/Hungary.
- Korea Aerospace Research Institute (KARI)/Korea.
- Ministry of Communications (MOC)/Israel.
- National Institute of Information and Communications Technology (NICT)/Japan.
- National Oceanic and Atmospheric Administration (NOAA)/USA.
- National Space Organization (NSPO)/Chinese Taipei.
- Naval Center for Space Technology (NCST)/USA.
- Scientific and Technological Research Council of Turkey (TUBITAK)/Turkey.
- Space and Upper Atmosphere Research Commission (SUPARCO)/Pakistan.
- Swedish Space Corporation (SSC)/Sweden.
- United States Geological Survey (USGS)/USA.

**DOCUMENT CONTROL**

<b>Document</b>	<b>Title</b>	<b>Date</b>	<b>Status</b>
CCSDS 910.11-B-1	Space Communication Cross Support—Service Management— Service Specification, Recommended Standard, Issue 1	August 2009	Original issue
EC 1	Editorial Change 1	August 2010	Corrects editorial and typographical inconsistencies.
EC 2	Editorial Change 2	August 2011	Corrects editorial and typographical inconsistencies.



## CONTENTS

<u>Section</u>	<u>Page</u>
<b>1 INTRODUCTION</b> .....	<b>1-1</b>
1.1 PURPOSE OF THIS RECOMMENDED STANDARD.....	1-1
1.2 RELATION TO CROSS SUPPORT REFERENCE MODEL.....	1-1
1.3 SCOPE.....	1-2
1.4 APPLICABILITY.....	1-5
1.5 RATIONALE.....	1-5
1.6 DOCUMENT STRUCTURE.....	1-5
1.7 DEFINITIONS AND NOMENCLATURE.....	1-7
1.8 CONVENTIONS.....	1-12
1.9 REFERENCES.....	1-19
<b>2 OVERVIEW OF SCCS SERVICE MANAGEMENT</b> .....	<b>2-1</b>
2.1 FUNDAMENTAL CONCEPTS.....	2-1
2.2 OVERVIEW OF SCCS MANAGEMENT SERVICES.....	2-4
2.3 MAPPING TO W3C XML SCHEMA.....	2-16
2.4 SECURITY ASPECTS OF SCCS MANAGEMENT SERVICES.....	2-17
<b>3 SERVICE MANAGEMENT DOCUMENT EXCHANGE</b> .....	<b>3-1</b>
3.1 GENERAL.....	3-1
3.2 UNDERLYING COMMUNICATION SERVICE.....	3-2
3.3 SM DOCUMENT EXCHANGE PROTOCOL.....	3-4
3.4 SM OPERATION PROCEDURE PATTERNS.....	3-36
<b>4 SERVICE PACKAGE OPERATIONS</b> .....	<b>4-1</b>
4.1 GENERAL.....	4-1
4.2 LIFECYCLE AND OWNERSHIP OF A SERVICE PACKAGE.....	4-1
4.3 CREATE_SERVICE_PACKAGE (CSP) OPERATION.....	4-8
4.4 REPLACE_SERVICE_PACKAGE (RSP) OPERATION.....	4-57
4.5 DELETE_SERVICE_PACKAGE (DSP) OPERATION.....	4-65
4.6 SELECT_ALTERNATE_SCENARIO (SAS) OPERATION.....	4-72
4.7 APPLY_NEW_TRAJECTORY (ANT) OPERATION.....	4-79
4.8 SERVICE_PACKAGE_CANCELLED (SPC) OPERATION.....	4-88
4.9 SERVICE_PACKAGE_MODIFIED (SPM) OPERATION.....	4-94
4.10 QUERY_SERVICE_PACKAGE (QSP) OPERATION.....	4-102
4.11 CONFIRM_TENTATIVE_SERVICE_PACKAGE (CTSP) OPERATION.....	4-109
4.12 APPLY_NEW_SPACE_LINK_EVENTS_PROFILE (ANSLEP) OPERATION.....	4-122

**CONTENTS (continued)**

<u>Section</u>	<u>Page</u>
<b>5 CONFIGURATION PROFILE OPERATIONS .....</b>	<b>5-1</b>
5.1 GENERAL.....	5-1
5.2 LIFECYCLE AND OWNERSHIP OF A CONFIGURATION PROFILE .....	5-1
5.3 ADD_SPACE_COMMUNICATION_SERVICE_PROFILE (ASCSP) OPERATION.....	5-4
5.4 DELETE_SPACE_COMMUNICATION_SERVICE_PROFILE (DSCSP) OPERATION.....	5-36
5.5 QUERY_SPACE_COMMUNICATION_SERVICE_PROFILE (QSCSP) OPERATION.....	5-44
5.6 ADD_SPACE_LINK_EVENTS_PROFILE (ASLEP) OPERATION .....	5-50
5.7 DELETE_SPACE_LINK_EVENTS_PROFILE (DSLEP) OPERATION .....	5-74
5.8 QUERY_SPACE_LINK_EVENTS_PROFILE (QSLEP) OPERATION .....	5-80
5.9 ADD_SLS_TRANSFER_SERVICE_PROFILE (ASTSP) OPERATION .....	5-87
5.10 ADD_RETRIEVAL_TRANSFER_SERVICE_PROFILE (ARTSP) OPERATION.....	5-101
5.11 DELETE_TRANSFER_SERVICE_PROFILE (DTSP) OPERATION .....	5-112
5.12 QUERY_TRANSFER_SERVICE_PROFILE (QTSP) OPERATION .....	5-119
<b>6 TRAJECTORY PREDICTION OPERATIONS .....</b>	<b>6-1</b>
6.1 GENERAL.....	6-1
6.2 LIFECYCLE AND OWNERSHIP OF A TRAJECTORY PREDICTION.....	6-1
6.3 ADD_TRAJECTORY_PREDICTION (ATP) OPERATION.....	6-3
6.4 DELETE_TRAJECTORY_PREDICTION (DTP) OPERATION.....	6-16
6.5 QUERY_TRAJECTORY_PREDICTION (QTP) OPERATION .....	6-22
6.6 EXTEND_TRAJECTORY_PREDICTION (ETP) OPERATION.....	6-28
<b>7 SERVICE AGREEMENT OPERATIONS .....</b>	<b>7-1</b>
7.1 GENERAL.....	7-1
7.2 OWNERSHIP OF SERVICE AGREEMENTS.....	7-1
7.3 QUERY_SERVICE_AGREEMENT (QSA) OPERATION.....	7-1
<b>ANNEX A DATA TYPE DEFINITIONS (NORMATIVE).....</b>	<b>A-1</b>
<b>ANNEX B INCREMENTAL ADOPTION (NORMATIVE) .....</b>	<b>B-1</b>
<b>ANNEX C ACRONYMS AND ABBREVIATIONS (INFORMATIVE).....</b>	<b>C-1</b>
<b>ANNEX D SCCS SERVICE MANAGEMENT PARAMETERS TABLE (INFORMATIVE) .....</b>	<b>D-1</b>

**CONTENTS (continued)**

<u>Section</u>	<u>Page</u>
<b>ANNEX E OVERVIEW OF UNIFIED MODELING LANGUAGE (UML) DIAGRAMMING CONVENTIONS (INFORMATIVE)</b> .....	<b>E-1</b>
<b>ANNEX F TIME PARAMETERS OF SCCS SERVICE MANAGEMENT INFORMATION ENTITIES (INFORMATIVE)</b> .....	<b>F-1</b>
<b>ANNEX G INFORMATIVE REFERENCES (INFORMATIVE)</b> .....	<b>G-1</b>

Figure

1-1 Cross Support Reference Model Space Mission Data Exchange .....	1-2
2-1 SCCS Service Management Environment .....	2-2
2-2 SCCS-SM Recommended Standard Overview .....	2-6
3-1 Relationship among SCCS-SM Operation Procedures, Document Exchange Protocol, and Underlying Communication Service .....	3-2
3-2 Exchange of SM Documents via Message Set and Exception Response Ports .....	3-4
3-3 SM Document Exchange Protocol Sequence Diagram .....	3-7
3-4 SM Send Message Sequence Diagram .....	3-7
3-5 SM Document Exchange Protocol Activity Diagram .....	3-8
3-6 Receive and Validate SM Message Set Activity Group Diagram .....	3-9
3-7 Receive and Validate SM Exception Response Activity Group Diagram .....	3-10
3-8 SmMessageSet Class Diagram .....	3-14
3-9 <<Invocation>> Message Stereotype Class Diagram .....	3-17
3-10 <<Return>> Message Stereotype Class Diagram .....	3-19
3-11 <<SuccessfulReturn>> Message Stereotype Class Diagram .....	3-19
3-12 <<FailedReturn>> Message Stereotype Class Diagram .....	3-21
3-13 <<FailedReturnWithDenial>> Message Stereotype Class Diagram .....	3-23
3-14 <<AcknowledgedReturn>> Message Stereotype Class Diagram .....	3-26
3-15 <<Notification>> Message Stereotype Class Diagram .....	3-27
3-16 <<Confirmation>> Message Stereotype Class Diagram .....	3-29
3-17 SmExceptionResponse Class Diagram .....	3-30
3-18 Sequence Diagram for Two-Phase Operation Pattern .....	3-38
3-19 State Diagram for Two-Phase Operation Pattern—Invoker View .....	3-39
3-20 State Diagram for Two-Phase Operation Pattern—Performer View .....	3-39
3-21 Two-Phase Operation Procedure Pattern Activity Diagram .....	3-41
3-22 Sequence Diagram for Three-Phase Operation Pattern .....	3-47
3-23 State Diagram for Three-Phase Operation Pattern—Invoker View .....	3-48
3-24 State Diagram for Three-Phase Operation Pattern—Performer View .....	3-48
3-25 Three-Phase Operation Procedure Pattern Activity Diagram .....	3-50
3-26 Sequence Diagram for Notify Operation Procedure Pattern .....	3-56
3-27 State Diagram for Notify Operation Pattern—Notifier View .....	3-57
3-28 State Diagram for Notify Operation Pattern—Recipient View .....	3-57
3-29 Notify Operation Procedure Pattern Activity Diagram .....	3-59

**CONTENTS (continued)**

<u>Figure</u>	<u>Page</u>
4-1 Service Package created via CSP operation .....	4-2
4-2 Service Package created via CTSP operation .....	4-2
4-3 State Diagram for Established Service Package .....	4-3
4-4 State Diagram for Planned Service Package .....	4-4
4-5 <<SServicePackageRequest>> Stereotype Structure Class Diagram .....	4-17
4-6 CSP-I Message Structure Class Diagram .....	4-26
4-7 CSP-AR Message Structure Class Diagram .....	4-27
4-8 <<ServicePackageResult>> Stereotype Structure Presented in a Class Diagram, Part 1 of 2 .....	4-29
4-9 <<ServicePackageResult>> Stereotype Structure Presented in a Class Diagram, Part 2 of 2 (Space Link Events) .....	4-30
4-10 CSP-SR Message Structure Class Diagram .....	4-47
4-11 CSP-FR Message Structure Class Diagram .....	4-49
4-12 RSP-I Message Structure Presented in a Class Diagram .....	4-60
4-13 RSP-AR Message Structure Class Diagram .....	4-61
4-14 RSP-SR Message Structure Presented in a Class Diagram .....	4-62
4-15 RSP-FR Message Structure Class Diagram .....	4-63
4-16 DSP-I Message Structure Class Diagram .....	4-68
4-17 DSP-SR Message Structure Class Diagram .....	4-69
4-18 DSP-FR Message Structure Class Diagram .....	4-70
4-19 SAS-I Message Structure Presented in a Class Diagram .....	4-75
4-20 SAS-SR Message Structure Presented in a Class Diagram .....	4-76
4-21 SAS-FR Message Structure Presented as a Class Diagram .....	4-77
4-22 ANT-I Message Structure Class Diagram .....	4-82
4-23 ANT-AR Message Structure Class Diagram .....	4-84
4-24 ANT-SR Message Structure Presented in a Class Diagram .....	4-85
4-25 ANT-FR Message Structure Class Diagram .....	4-86
4-26 SPC-N Message Structure Class Diagram .....	4-91
4-27 SPC-C Message Structure Class Diagram .....	4-93
4-28 SPM-N Message Structure Presented in a Class Diagram .....	4-98
4-29 SPM-C Message Structure Class Diagram .....	4-101
4-30 QSP-I Message Structure Class Diagram .....	4-104
4-31 QSP-SR Message Structure Presented in a Class Diagram .....	4-105
4-32 QSP-FR Message Structure Class Diagram .....	4-107
4-33 CTSP-I Message Structure Class Diagram .....	4-112
4-34 CTSP-AR Message Structure Class Diagram .....	4-117
4-35 CTSP-SR Message Structure Class Diagram .....	4-118
4-36 CTSP-FR Message Structure Class Diagram .....	4-119
4-37 ANSLEP-I Message Structure Class Diagram .....	4-125

**CONTENTS (continued)**

<u>Figure</u>	<u>Page</u>
4-38 ANSLEP-AR Message Structure Class Diagram .....	4-127
4-39 ANSLEP-SR Message Structure Presented in a Class Diagram.....	4-128
4-40 ANSLEP-FR Message Structure Class Diagram .....	4-129
5-1 State Diagram for Generic Configuration Profile.....	5-2
5-2 <<SpaceCommunicationServiceProfile>> Stereotype Structure Class Diagram .....	5-7
5-3 ASCSP-I Message Structure Class Diagram .....	5-28
5-4 ASCSP-AR Message Structure Class Diagram.....	5-29
5-5 ASCSP-SR Message Structure Class Diagram.....	5-30
5-6 ASCSP-FR Message Structure Class Diagram.....	5-31
5-7 DSCSP-I Message Structure Class Diagram .....	5-39
5-8 DSCSP-SR Message Structure Class Diagram.....	5-40
5-9 DSCSP-FR Message Structure Class Diagram.....	5-41
5-10 QSCSP-I Message Structure Class Diagram .....	5-47
5-11 QSCSP-SR Message Structure Class Diagram.....	5-48
5-12 QSCSP-FR Message Structure Class Diagram.....	5-49
5-13 <<SmSpaceLinkEventsProfile>> Stereotype Structure Class Diagram.....	5-54
5-14 ASLEP-I Message Structure Class Diagram .....	5-66
5-15 ASLEP-AR Message Structure Class Diagram .....	5-68
5-16 ASLEP-SR Message Structure Class Diagram.....	5-69
5-17 ASLEP-FR Message Structure Class Diagram.....	5-70
5-18 DSLEP-I Message Structure Class Diagram .....	5-76
5-19 DSLEP-SR Message Structure Class Diagram.....	5-77
5-20 DSLEP-FR Message Structure Class Diagram.....	5-78
5-21 QSLEP-I Message Structure Class Diagram .....	5-83
5-22 QSLEP-SR Message Structure Class Diagram.....	5-84
5-23 QSLEP-FR Message Structure Class Diagram.....	5-85
5-24 <<SlsTsProfile>> Data Set Stereotype Structure Class Diagram.....	5-90
5-25 ASTSP-I Message Structure Class Diagram .....	5-96
5-26 ASTSP-AR Message Structure Class Diagram.....	5-97
5-27 ASTSP-SR Message Structure Class Diagram.....	5-98
5-28 ASTSP-FR Message Structure Class Diagram.....	5-99
5-29 <<RetrievalTsProfile>> Data Set Stereotype Structure Class Diagram ....	5-104
5-30 ARTSP-I Message Structure Class Diagram .....	5-107
5-31 ARTSP-AR Message Structure Class Diagram.....	5-108
5-32 ARTSP-SR Message Structure Class Diagram.....	5-109
5-33 ARTSP-FR Message Structure Class Diagram.....	5-110
5-34 DTSP-I Message Structure Class Diagram.....	5-115
5-35 DTSP-SR Message Structure Class Diagram .....	5-116

**CONTENTS (continued)**

<u>Figure</u>	<u>Page</u>
5-36 DTSP-FR Message Structure Class Diagram .....	5-117
5-37 QTSP-I Message Structure Class Diagram.....	5-122
5-38 QTSP-SR Message Structure Class Diagram .....	5-123
5-39 QTSP-FR Message Structure Class Diagram .....	5-124
6-1 State Diagram for Trajectory Prediction.....	6-2
6-2 ATP-I Message Structure Class Diagram .....	6-6
6-3 ATP-SR Message Structure Class Diagram.....	6-11
6-4 ATP-FR Message Structure Class Diagram.....	6-13
6-5 DTP-I Message Structure Class Diagram .....	6-18
6-6 DTP-SR Message Structure Class Diagram.....	6-19
6-7 DTP-FR Message Structure Class Diagram.....	6-20
6-8 QTP-I Message Structure Class Diagram .....	6-24
6-9 QTP-SR Message Structure Class Diagram.....	6-25
6-10 QTP-FR Message Structure Class Diagram.....	6-27
6-11 ETP-I Message Structure Presented in a Class Diagram.....	6-31
6-12 ETP-SR Message Structure Presented in a Class Diagram .....	6-33
6-13 ETP-FR Message Structure Class Diagram.....	6-34
7-1 QSA-I Message Structure Class Diagram .....	7-3
7-2 QSA-SR Message Structure Class Diagram, Part 1 of 2.....	7-4
7-3 QSA-SR Message Structure Class Diagram, Part 2 of 2 (Operations Constraints Specification).....	7-5
7-4 QSA-FR Message Structure Class Diagram.....	7-34
E-1 Class Diagram Example.....	E-2
E-2 Activity Diagram 1 .....	E-3
E-3 Activity Diagram 2 .....	E-4
E-4 Activity Diagram 3 .....	E-4
E-5 Sequence Diagram Example.....	E-6
E-6 State Machine Diagram Example 1 .....	E-7
E-7 State Machine diagram Example 2 .....	E-8
F-1 Example Top-Level Timing Relationships in a Service Package Result .....	F-13
F-2 Example Timing Relationships in a SpaceCommunication- ServiceResult Component of a Service Package Result.....	F-14

Table

3-1 Requirements for the Underlying Communication Service.....	3-3
3-2 Sender Requirements for the SM Document Exchange Protocol.....	3-11
3-3 Receiver Requirements for the SM Document Exchange Protocol.....	3-12
3-4 SmMessageSet Data Set.....	3-14

**CONTENTS (continued)**

<u>Table</u>	<u>Page</u>
3-5 Data Set Composition and Relationship Requirements for SmMessageSet Documents .....	3-15
3-6 <<Invocation>> Message Stereotype Data Set .....	3-18
3-7 Data Set Composition and Relationship Requirements for All Invocation Messages .....	3-18
3-8 <<SuccessfulReturn>> Message Stereotype Data Set .....	3-20
3-9 Data Set Composition and Relationship Requirements for All SuccessfulReturn Messages .....	3-20
3-10 <<FailedReturn>> Message Stereotype Data Set .....	3-21
3-11 <<Error>> Stereotype Data Set .....	3-22
3-12 Data Set Composition and Relationship Requirements for All FailedReturn Messages .....	3-23
3-13 <<Denial>> Data Set .....	3-24
3-14 Data Set Composition and Relationship Requirements for All FailedReturnWithDenial Messages .....	3-25
3-15 <<AcknowledgedReturn>> Message Stereotype Data Set .....	3-26
3-16 Data Set Composition and Relationship Requirements for All AcknowledgedReturn Messages .....	3-27
3-17 <<Notification>> Message Stereotype Data Set .....	3-28
3-18 Data Set Composition and Relationship Requirements for All Notification Messages .....	3-28
3-19 <<Confirmation>> Message Stereotype Data Set .....	3-29
3-20 Data Set Composition and Relationship Requirements for All Confirmation Messages .....	3-30
3-21 SmExceptionResponse Data Set .....	3-32
3-22 UnrecognizedMessageSetResponse Data Set .....	3-32
3-23 InvalidInvocationResponse Data Set .....	3-32
3-24 InvalidNotificationResponse Data Set .....	3-33
3-25 UnrecognizedMessageSetResponse diagnostic Parameter Definition .....	3-33
3-26 InvalidInvocationResponse diagnostic Parameter Definition .....	3-34
3-27 InvalidNotificationResponse diagnostic Parameter Definition .....	3-34
3-28 Data Set Composition and Relationship Requirements for All SmExceptionResponses .....	3-35
3-29 State Table for Two-Phase Operation—Invoker View .....	3-40
3-30 State Table for Two-Phase Operation—Performer View .....	3-40
3-31 Invoker Requirements for the Two-Phase Operation Procedures .....	3-42
3-32 Performer Requirements for the Two-Phase Operation Procedures .....	3-44
3-33 State Table for Three-Phase Operation—Invoker View .....	3-49
3-34 State Table for Three-Phase Operation—Performer View .....	3-49

**CONTENTS (continued)**

<u>Table</u>	<u>Page</u>
3-35 Invoker Requirements for the Three-Phase Operation Procedures .....	3-51
3-36 Performer Requirements for the Three-Phase Operation Procedures.....	3-53
3-37 State Table for Notify Operation—Notifier View.....	3-57
3-38 State Table for Notify Operation Pattern—Recipient View.....	3-58
3-39 Notifier Requirements for the Notify Operation Procedures.....	3-60
3-40 Recipient Requirements for the Notify Operation Procedures.....	3-61
4-1 Service Package Lifecycle State Table, Part 1 .....	4-5
4-2 UM Requirements for the CSP Operation.....	4-9
4-3 CM Requirements for the CSP Operation.....	4-9
4-4 SpaceLinkSessionServicePackageRequest Data Set.....	4-18
4-5 ServiceScenario Data Set (<<ServicePackageRequest>>).....	4-18
4-6 TrajectoryReference Data Set (<<ServicePackageRequest>>).....	4-18
4-7 SpaceCommunicationServiceRequest Data Set (<<ServicePackageRequest>>).....	4-19
4-8 AntennaConstraints Data Set (<<ServicePackageRequest>>).....	4-20
4-9 Antenna Data Set (<<ServicePackageRequest>>).....	4-21
4-10 SlsTsProfileRespecification Data Set (<<ServicePackageRequest>>).....	4-21
4-11 RespecifiedParameter Data Set (<<ServicePackageRequest>>).....	4-21
4-12 SpaceLinkEventsProfileReference Data Set (<<ServicePackageRequest>>).....	4-22
4-13 RetrievalServicePackageRequest Data Set (<<ServicePackageRequest>>).....	4-22
4-14 Data Set Composition and Relationship Requirements for All ServicePackageRequests .....	4-22
4-15 ServicePackageIdentification Data Set (CSP-I).....	4-27
4-16 Data Set Composition and Relationship Requirements for CSP-I .....	4-27
4-17 ServicePackageReference Data Set (CSP-AR) .....	4-28
4-18 Data Set Composition and Relationship Requirement for CSP-AR .....	4-28
4-19 SpaceLinkSessionServicePackageResult Data Set (<<ServicePackageResult>>).....	4-31
4-20 ServiceScenarioResult Data Set (<<ServicePackageResult>>).....	4-32
4-21 TrajectoryResult Data Set (<<ServicePackageResult>>).....	4-33
4-22 SpaceCommunicationServiceResult Data Set (<<ServicePackageResult>>).....	4-33
4-23 SlsTsInstanceResult Data Set (<<ServicePackageResult>>).....	4-34
4-24 BilateralSlsTsInstanceResult Data Set (<<ServicePackageResult>>).....	4-35
4-25 CarrierResult Data Set (<<ServicePackageResult>>).....	4-35



**CONTENTS (continued)**

<u>Table</u>	<u>Page</u>
4-26 TsMapResult Data Set (<<ServicePackageResult>>).....	4-35
4-27 FSpaceLinkEventsResult, RSpaceLinkEventsResult Data Set (<<ServicePackageResult>>).....	4-36
4-28 BilateralSpaceLinkEventsResult Data Set (<<ServicePackageResult>>).....	4-36
4-29 FSpaceLinkAvailableScheduledState Data Set (<<ServicePackageResult>>).....	4-37
4-30 RSpaceLinkAvailableScheduledState Data Set (<<ServicePackageResult>>).....	4-38
4-31 FSpaceLinkChangeScheduledEvent Data Set (<<ServicePackageResult>>).....	4-39
4-32 RSpaceLinkChangeScheduledEvent Data Set (<<ServicePackageResult>>).....	4-39
4-33 RSpaceLinkDataTransportScheduledState Data Set (<<ServicePackageResult>>).....	4-40
4-34 FSpaceLinkDataTransportScheduledState Data Set (<<ServicePackageResult>>).....	4-40
4-35 FSpaceLinkDataTransportChangeScheduledEvent Data Set (<<ServicePackageResult>>).....	4-41
4-36 RSpaceLinkDataTransportChangeScheduledEvent Data Set (<<ServicePackageResult>>).....	4-41
4-37 RetrievalTsInstanceResult Data Set (<<ServicePackageResult>>).....	4-42
4-38 BilateralRetrievalTsInstanceResult Data Set (<<ServicePackageResult>>).....	4-42
4-39 Data Set Composition and Relationship Requirements for All ServicePackageResults.....	4-43
4-40 Data Set Composition and Relationship Requirements for CSP-SR.....	4-48
4-41 CspError Data Set diagnostic Parameter Definition.....	4-49
4-42 CspDenial Data Set reason Parameter Definition.....	4-56
4-43 Data Set Composition and Relationship Requirements for CSP-FR.....	4-57
4-44 UM Requirements for the RSP Operation.....	4-58
4-45 CM Requirements for the RSP Operation.....	4-59
4-46 Data Set Composition and Relationship Requirements for RSP-I.....	4-60
4-47 Data Set Composition and Relationship Requirements for RSP-AR.....	4-61
4-48 Data Set Composition and Relationship Requirements for RSP-SR.....	4-62
4-49 Additional RspError Data Set diagnostic Parameter Definition.....	4-64
4-50 Data Set Composition and Relationship Requirements for RSP-FR.....	4-65
4-51 UM Requirements for the DSP Operation.....	4-66

**CONTENTS (continued)**

<u>Table</u>	<u>Page</u>
4-52 CM Requirements for the DSP Operation .....	4-67
4-53 Data Set Composition and Relationship Requirements for DSP-I .....	4-69
4-54 Data Set Composition and Relationship Requirements for DSP-SR .....	4-70
4-55 DspError Data Set diagnostic Parameter Definition .....	4-71
4-56 Data Set Composition and Relationship Requirements for DSP-FR .....	4-72
4-57 UM Requirements for the SAS Operation .....	4-73
4-58 CM Requirements for the SAS Operation .....	4-73
4-59 ServiceScenarioReference Data Set (SAS-I) .....	4-75
4-60 Data Set Composition and Relationship Requirements for SAS-I .....	4-75
4-61 ServiceScenarioReference Data Set (SAS-SR) .....	4-76
4-62 Data Set Composition and Relationship Requirements for SAS-SR .....	4-77
4-63 SasError Data Set diagnostic Parameter Definition .....	4-78
4-64 SasDenial Data Set reason Parameter Definition .....	4-79
4-65 Data Set Composition and Relationship Requirements for SAS-FR .....	4-79
4-66 UM Requirements for the ANT Operation .....	4-80
4-67 CM Requirements for the ANT Operation .....	4-81
4-68 TrajectoryPredictionInformation Data Set .....	4-83
4-69 Data Set Composition and Relationship Requirements for ANT-I .....	4-83
4-70 Data Set Composition and Relationship Requirements for ANT-AR .....	4-84
4-71 Data Set Composition and Relationship Requirements for ANT-SR .....	4-85
4-72 AntError Data Set diagnostic Parameter Definition .....	4-87
4-73 AntDenial Data Set reason Parameter Definition .....	4-88
4-74 Data Set Composition and Relationship Requirements for ANT-FR .....	4-88
4-75 UM Requirements for the SPC Operation .....	4-89
4-76 CM Requirements for the SPC Operation .....	4-90
4-77 CancellationInformation Data Set (SPC-N) .....	4-92
4-78 Data Set Composition and Relationship Requirements for SPC-N .....	4-93
4-79 Data Set Composition and Relationship Requirements for SPC-C .....	4-94
4-80 UM Requirements for SPM Operation .....	4-95
4-81 CM Requirements for the SPM Operation .....	4-96
4-82 ModificationStatement Data Set .....	4-99
4-83 ModifiedItem Data Set .....	4-100
4-84 Data Set Composition and Relationship Requirements for SPM-N .....	4-100
4-85 Data Set Composition and Relationship Requirements for SPM-C .....	4-101
4-86 UM Requirements for QSP Operation .....	4-103
4-87 CM Requirements for QSP Operation .....	4-103
4-88 Data Set Composition and Relationship Requirements for QSP-I .....	4-105
4-89 Data Set Composition and Relationship Requirements for QSP-SR .....	4-106
4-90 QspError Data Set diagnostic Parameter Definition .....	4-108

**CONTENTS (continued)**

<u>Table</u>	<u>Page</u>
4-91 Data Set Composition and Relationship Requirements for QSP-FR.....	4-108
4-92 UM Requirements for the CTSP Operation.....	4-110
4-93 CM Requirements for the CTSP Operation.....	4-111
4-94 ProposedServicePackage Data Set.....	4-113
4-95 ProposedServiceScenario Data Set.....	4-114
4-96 AppliedTrajectory Data Set.....	4-114
4-97 ProposedSpaceCommunicationService Data Set.....	4-115
4-98 ProposedSlsTsInstance Data Set.....	4-115
4-99 ProposedCarrier Data Set.....	4-115
4-100 ProposedTsMap Data Set.....	4-116
4-101 Data Set Composition and Relationship Requirements for CTSP-I.....	4-116
4-102 Data Set Composition and Relationship Requirement for CTSP-AR.....	4-118
4-103 Data Set Composition and Relationship Requirements for CTSP-SR.....	4-119
4-104 CtspError Data Set diagnostic Parameter Definition.....	4-120
4-105 CtspDenial Data Set reason Parameter Definition.....	4-121
4-106 Data Set Composition and Relationship Requirements for CTSP-FR.....	4-122
4-107 UM Requirements for the ANSLEP Operation.....	4-123
4-108 CM Requirements for the ANSLEP Operation.....	4-124
4-109 SpaceLinkEventsProfileInformation Data Set.....	4-126
4-110 Data Set Composition and Relationship Requirements for ANSLEP-I.....	4-126
4-111 Data Set Composition and Relationship Requirements for ANSLEP-AR.....	4-127
4-112 Data Set Composition and Relationship Requirements for ANSLEP-SR.....	4-128
4-113 AnslepError Data Set diagnostic Parameter Definition.....	4-130
4-114 AnslepDenial Data Set reason Parameter Definition.....	4-131
4-115 Data Set Composition and Relationship Requirements for ANSLEP-FR.....	4-131
5-1 State Table for Generic Configuration Profile.....	5-2
5-2 UM Requirements for the ASCSP Operation.....	5-5
5-3 CM Requirements for the ASCSP Operation.....	5-6
5-4 SpaceLinkCarrierProfile Data Set.....	5-8
5-5 F401SpaceLinkCarrierProfile Data Set.....	5-8
5-6 FrequencySweepLeg Data Set.....	5-11
5-7 F401Subcarrier Data Set.....	5-11
5-8 F401SymbolStream Data Set.....	5-12
5-9 FcltuTSM Data Set.....	5-12
5-10 R401SpaceLinkCarrierProfile Data Set.....	5-13
5-11 R401Subcarrier Data Set.....	5-14
5-12 ReturnCoherenceModel Data Set.....	5-15
5-13 ReturnOffsetModel Data Set.....	5-15
5-14 R401SymbolStream Data Set.....	5-16

**CONTENTS (continued)**

<u>Table</u>	<u>Page</u>
5-15 RafProd Data Set.....	5-17
5-16 FecfOnly Data Set.....	5-18
5-17 ReedSolomonCoding Data Set.....	5-18
5-18 TurboCoding Data Set.....	5-19
5-19 RafTSM Data Set.....	5-19
5-20 RcfTSM Data Set.....	5-19
5-21 BilateralCarrierProfile Data Set.....	5-20
5-22 BilateralTSM Data Set.....	5-20
5-23 ReturnLinkFrameDataSink Data Set.....	5-21
5-24 BilateralDataSink Data Set.....	5-22
5-25 Data Set Composition and Relationship Requirements for all SpaceCommunicationServiceProfiles.....	5-23
5-26 SpaceCommunicationServiceProfileIdentification Data Set.....	5-28
5-27 Data Set Composition and Relationship Requirements for ASCSP-I.....	5-29
5-28 SpaceCommunicationServiceProfileReference Data Set.....	5-30
5-29 Data Set Composition and Relationship Requirements for ASCSP-AR.....	5-30
5-30 Data Set Composition and Relationship Requirements for ASCSP-SR.....	5-31
5-31 AscspError Data Set diagnostic Parameter Definition.....	5-32
5-32 Data Set Composition and Relationship Requirements for the ASCSP-FR.....	5-35
5-33 UM Requirements for the DSCSP Operation.....	5-37
5-34 CM Requirements for the DSCSP Operation.....	5-38
5-35 Data Set Composition and Relationship Requirements for the DSCSP-I.....	5-39
5-36 Data Set Composition and Relationship Requirements for the DSCSP-SR.....	5-40
5-37 DscspError Data Set diagnostic Parameter Definition.....	5-42
5-38 Data Set Composition and Relationship Requirements for the DSCSP-FR.....	5-43
5-39 UM Requirements for the QSCSP Operation.....	5-45
5-40 CM Requirements for the QSCSP Operation.....	5-46
5-41 Data Set Composition and Relationship Requirements for the QSCSP-I.....	5-47
5-42 Data Set Composition and Relationship Requirements for the QSCSP-SR.....	5-48
5-43 QscspError Data Set diagnostic Parameter Definition.....	5-50
5-44 Data Set Composition and Relationship Requirements for the QSCSP-FR.....	5-50
5-45 UM Requirements for the ASLEP Operation.....	5-52
5-46 CM Requirements for the ASLEP Operation.....	5-52
5-47 TimeReferenceSpecification Data Set.....	5-55
5-48 RSpaceLinkEvents, FSpaceLinkEvents Data Set <<SmSpaceLinkEventsProfile>>.....	5-55
5-49 RSpaceLinkAvailableState Data Set <<SmSpaceLinkEventsProfile>>.....	5-56

**CONTENTS (continued)**

<u>Table</u>	<u>Page</u>
5-50 FSpaceLinkAvailableState Data Set <<SmSpaceLinkEventsProfile>> .....	5-57
5-51 RSpaceLinkChangeEvent Data Set <<SmSpaceLinkEventsProfile>> .....	5-58
5-52 FSpaceLinkChangeEvent Data Set <<SmSpaceLinkEventsProfile>> .....	5-59
5-53 RSpaceLinkDataTransportState Data Set <<SmSpaceLinkEventsProfile>> .....	5-59
5-54 FSpaceLinkDataTransportState Data Set <<SmSpaceLinkEventsProfile>> .....	5-61
5-55 FSpaceLinkDataTransportChangeEvent Data Set <<SmSpaceLinkEventsProfile>>).....	5-61
5-56 RSpaceLinkDataTransportChangeEvent Data Set <<SmSpaceLinkEventsProfile>> .....	5-62
5-57 Data Set Composition and Relationship Requirements for all SmSpaceLinkEventsProfile Data Sets.....	5-63
5-58 SpaceLinkEventsProfileIdentification Data Set .....	5-66
5-59 BilateralSpaceLinkEventsProfile Data Set .....	5-67
5-60 Data Set Composition and Relationship Requirements for ASLEP-I .....	5-67
5-61 SpaceLinkEventsProfileReference Data Set .....	5-68
5-62 Data Set Composition and Relationship Requirements for ASLEP-AR .....	5-69
5-63 Data Set Composition and Relationship Requirements for the ASLEP-SR .....	5-70
5-64 AslepError Data Set diagnostic Parameter Definition .....	5-71
5-65 Data Set Composition and Relationship Requirements for ASLEP-FR .....	5-74
5-66 UM Requirements for the DSLEP Operation .....	5-75
5-67 CM Requirements for the DSLEP Operation .....	5-75
5-68 Data Set Composition and Relationship Requirements for the DSLEP-I .....	5-77
5-69 Data Set Composition and Relationship Requirements for the DSLEP-SR .....	5-78
5-70 DslepError Data Set diagnostic Parameter Definition .....	5-79
5-71 Data Set Composition and Relationship Requirements for DSLEP-FR .....	5-80
5-72 UM Requirements for the QSLEP Operation .....	5-81
5-73 CM Requirements for the QSLEP Operation .....	5-82
5-74 Data Set Composition and Relationship Requirements for the QSLEP-I .....	5-83
5-75 Data Set Composition and Relationship Requirements for the QSLEP-SR .....	5-84
5-76 QslepError Data Set diagnostic Parameter Definition .....	5-86
5-77 Data Set Composition and Relationship Requirements for QSLEP-FR .....	5-86
5-78 UM Requirements for the ASTSP Operation .....	5-88
5-79 CM Requirements for the ASTSP Operation .....	5-89
5-80 FcltuTransferServiceProfile Data Set.....	5-91

**CONTENTS (continued)**

<u>Table</u>	<u>Page</u>
5-81 RafTransferServiceProfile Data Set.....	5-93
5-82 RcfTransferServiceProfile Data Set.....	5-94
5-83 BilateralTransferServiceProfile Data Set .....	5-95
5-84 Data Set Composition and Relationship Requirements for the <<SlsTsProfile>> Stereotype Data Set.....	5-95
5-85 TransferServiceProfileIdentification Data Set .....	5-96
5-86 Data Set Composition and Relationship Requirements for the ASTSP-I .....	5-97
5-87 TransferServiceProfileReference Data Set .....	5-98
5-88 Data Set Composition and Relationship Requirements for the ASTSP-AR .....	5-98
5-89 Data Set Composition and Relationship Requirements for the ASTSP-SR .....	5-99
5-90 AstspError Data Set diagnostic Parameter Definition .....	5-100
5-91 Data Set Composition and Relationship Requirements for the ASTSP-FR .....	5-101
5-92 UM Requirements for the ARTSP Operation .....	5-102
5-93 CM Requirements for the ARTSP Operation .....	5-103
5-94 OfflineRafTsProfile Data Set .....	5-105
5-95 OfflineRcfTsProfile Data Set .....	5-105
5-96 RetrievalBilateralTsProfile Data Set.....	5-106
5-97 Data Set Composition and Relationship Requirements for the <<RetrievalTsProfile>> Stereotype Data Set .....	5-106
5-98 Data Set Composition and Relationship Requirements for the ARTSP-I .....	5-107
5-99 Data Set Composition and Relationship Requirements for the ARTSP-AR .....	5-108
5-100 Data Set Composition and Relationship Requirements for the ARTSP-SR .....	5-109
5-101 ArtspError Data Set diagnostic Parameter Definition .....	5-111
5-102 Data Set Composition and Relationship Requirements for the ARTSP-FR .....	5-111
5-103 UM Requirements for the DTSP Operation.....	5-113
5-104 CM Requirements for the DTSP Operation.....	5-114
5-105 Data Set Composition and Relationship Requirements for the DTSP-I .....	5-115
5-106 Data Set Composition and Relationship Requirements for the DTSP-SR.....	5-116
5-107 DtspeError Data Set diagnostic Parameter Definition.....	5-118
5-108 Data Set Composition and Relationship Requirements for the DTSP-FR.....	5-119
5-109 UM Requirements for the QTSP Operation.....	5-120
5-110 CM Requirements for the QTSP Operation.....	5-121
5-111 Data Set Composition and Relationship Requirements for the QTSP-I .....	5-122
5-112 Data Set Composition and Relationship Requirements for the QTSP-SR.....	5-124
5-113 QtspError Data Set diagnostic Parameter Definition.....	5-125
5-114 Data Set Composition and Relationship Requirements for the QTSP-FR.....	5-125
6-1 State Table for Trajectory Prediction .....	6-2
6-2 UM Requirements for the ATP Operation .....	6-4
6-3 CM Requirements for the ATP Operation .....	6-4

**CONTENTS (continued)**

<u>Table</u>	<u>Page</u>
6-4 TrajectoryPredictionIdentification Data Set .....	6-7
6-5 TrajectoryPredictionSegment Data Set .....	6-8
6-6 OrbitParameterMessageText Data Set .....	6-8
6-7 OrbitParameterMessageXml Data Set .....	6-8
6-8 OrbitEphemerisMessageText Data Set .....	6-9
6-9 OrbitEphemerisMessageXml Data Set .....	6-9
6-10 OrbitBilateralMessage Data Set .....	6-9
6-11 Data Set Composition and Relationship Requirements for ATP-I .....	6-10
6-12 TrajectoryPredictionReference Data Set .....	6-11
6-13 TrajectoryPredictionStorage Data Set .....	6-12
6-14 Data Set Composition and Relationship Requirements for ATP-SR .....	6-12
6-15 AtpError Data Set diagnostic Parameter Definition .....	6-13
6-16 Data Set Composition and Relationship Requirements for ATP-FR .....	6-15
6-17 UM Requirements for the DTP Operation .....	6-17
6-18 CM Requirements for the DTP Operation .....	6-17
6-19 Data Set Composition and Relationship Requirements for DTP-I .....	6-18
6-20 Data Set Composition and Relationship Requirements for DTP-SR .....	6-19
6-21 DtpError Data Set diagnostic Parameter Definition .....	6-21
6-22 Data Set Composition and Relationship Requirements for DTP-FR .....	6-21
6-23 UM Requirements for the QTP Operation .....	6-23
6-24 CM Requirements for the QTP Operation .....	6-23
6-25 Data Set Composition and Relationship Requirements for QTP-I .....	6-24
6-26 ReferencingServicePackage Data Set .....	6-26
6-27 Data Set Composition and Relationship Requirements for QTP-SR .....	6-26
6-28 QtpError Data Set diagnostic Parameter Definition .....	6-27
6-29 Data Set Composition and Relationship Requirements for QTP-FR .....	6-28
6-30 UM Requirements for the ETP Operation .....	6-29
6-31 CM Requirements for the ETP Operation .....	6-30
6-32 SegmentContinuity Data Set .....	6-32
6-33 Data Set Composition and Relationship Requirements for ETP-I .....	6-32
6-34 TrajectoryGapStatus Data Set .....	6-33
6-35 Data Set Composition and Relationship Requirements for ETP-SR .....	6-34
6-36 Additional EtpError Data Set diagnostic Parameter Definition .....	6-35
6-37 Data Set Composition and Relationship Requirements for ETP-FR .....	6-36
7-1 UM Requirements for the QSA Operation .....	7-2
7-2 CM Requirements for the QSA Operation .....	7-3
7-3 ServiceAgreement Data Set .....	7-6
7-4 SupportingAntenna Data Set .....	7-10
7-5 ServicePackageOperationsConstraints Data Set .....	7-10

**CONTENTS (continued)**

<u>Table</u>	<u>Page</u>
7-6 CreateServicePackageOperationConstraints Data Set.....	7-12
7-7 ReplaceServicePackageOperationConstraints Data Set .....	7-12
7-8 DeleteServicePackageOperationConstraints Data Set.....	7-12
7-9 QueryServicePackageOperationConstraints Data Set .....	7-12
7-10 SelectAlternateScenarioOperationConstraints Data Set.....	7-12
7-11 ApplyNewTrajectoryOperationConstraints Data Set.....	7-13
7-12 ConfirmTentativeServicePackageOperationConstraints Data Set.....	7-13
7-13 ApplyNewSpaceLinkEventsProfileOperationConstraints Data Set.....	7-13
7-14 DefaultTrajectoryPrediction Data Set.....	7-13
7-15 TrajectoryPredictionOperationsConstraints Data Set .....	7-14
7-16 AddTrajectoryPredictionOperationConstraints Data Set.....	7-14
7-17 DeleteTrajectoryPredictionOperationConstraints Data Set .....	7-15
7-18 ExtendTrajectoryPredictionOperationConstraints Data Set .....	7-15
7-19 QueryTrajectoryPredictionOperationConstraints Data Set.....	7-15
7-20 ConfigurationProfileOperationsConstraints Data Set .....	7-16
7-21 AddSpaceCommunicationServiceProfileOperation- Constraints Data Set .....	7-16
7-22 DeleteSpaceCommunicationServiceProfileOperation- Constraints Data Set .....	7-17
7-23 QuerySpaceCommunicationServiceProfileOperation- Constraints Data Set .....	7-17
7-24 AddSpaceLinkEventsProfileOperationConstraints Data Set.....	7-17
7-25 DeleteSpaceLinkEventsProfileOperationConstraints Data Set.....	7-17
7-26 QuerySpaceLinkEventsProfileOperationConstraints Data Set.....	7-18
7-27 AddSlsTransferServiceProfileOperationConstraints Data Set.....	7-18
7-28 AddRetrievalTransferServiceProfileOperation- Constraints Data Set .....	7-18
7-29 QueryTransferServiceProfileOperationConstraints Data Set.....	7-18
7-30 DeleteTransferServiceProfileOperationConstraints Data Set.....	7-19
7-31 QueryServiceAgreementOperationConstraints Data Set .....	7-19
7-32 F401SpaceLinkCarrierAgreement Data Set .....	7-20
7-33 F401SubcarrierAgreement Data Set.....	7-21
7-34 F401SymbolStreamAgreement Data Set.....	7-21



**CONTENTS (continued)**

<u>Table</u>	<u>Page</u>
7-35 FTcModulationProdAgreement Data Set .....	7-21
7-36 FcltuProdAgreement Data Set.....	7-22
7-37 R401SpaceLinkCarrierAgreement Data Set .....	7-23
7-38 R401SubcarrierAgreement Data Set.....	7-24
7-39 R401SymbolStreamAgreement Data Set.....	7-24
7-40 RafProdAgreement Data Set .....	7-26
7-41 FecfOnlyAgreement Data Set.....	7-26
7-42 ReedSolomonCodingAgreement Data Set .....	7-27
7-43 TurboCodingAgreement Data Set.....	7-27
7-44 PacketTelemetryChannel Data Set.....	7-28
7-45 AosChannel Data Set.....	7-28
7-46 BilateralServiceAgreement Data Set.....	7-29
7-47 TransferServiceAgreement Data Set .....	7-29
7-48 SlsRafTsAgreement Data Set.....	7-30
7-49 SlsRcfTsAgreement Data Set.....	7-30
7-50 SlsFcltuTsAgreement Data Set .....	7-30
7-51 RtrvlRafTsAgreement Data Set .....	7-30
7-52 RtrvlRcfTsAgreement Data Set .....	7-30
7-53 Data Set Composition and Relationship Requirements for QSA-SR.....	7-31
7-54 QsaError Data Set diagnostic Parameter Definition.....	7-35
A-1 SCCS-SM Data Type Definitions.....	A-1
B-1 SCCS-SM Operations Compliance Levels.....	B-2
D-1 SM Document Exchange Parameters List .....	D-1
D-2 Service Package Parameters List.....	D-3
D-3 Configuration Profile Parameters List.....	D-6
D-4 Trajectory Prediction Parameters List .....	D-9
D-5 Service Agreement Parameters List.....	D-10
F-1 Time Parameters in SCCS-SM Information Entities.....	F-1

# 1 INTRODUCTION

## 1.1 PURPOSE OF THIS RECOMMENDED STANDARD

It is common practice for management information to be exchanged between space mission management and a space link service provider for the purposes of negotiating, configuring, and executing the Tracking, Telemetry, and Command (TT&C) functions and cross support transfer services that are provided to the space mission. The various processes that generate, exchange, ingest, and act upon this management information are collectively referred to as *service management*.

This Recommended Standard defines a set of *Space Communication Cross Support Service Management (SCCS-SM) services* by which space link service providers and space missions exchange information needed to arrange spacecraft contact periods and establish the operating parameters of the space link services and cross support transfer services during those contact periods.

## 1.2 RELATION TO CROSS SUPPORT REFERENCE MODEL

The *Cross Support Reference Model* (reference [1]) establishes a model for space mission data exchange as illustrated in figure 1-1. Space mission users and mission management are represented by the Mission Data Operations System (MDOS), which sends data to and receives data from the Space Element. The Space Link Extension (SLE) System transfers these data using SLE transfer services between the SLE System and the MDOS, and using space link services between the SLE System and the Space Element. In addition, the MDOS and the SLE System exchange management data for managing the space link services and SLE transfer services.

NOTE – The management data exchanged between the Space Element and the MDOS are illustrated for the sake of completeness. However, they are outside the scope of the Cross Support Reference Model and this SCCS-SM Service Specification. Also, although this management data exchange is illustrated as a direct link between Space Element and MDOS, it is actually accomplished via the space link and SLE transfer services.

The *Cross Support Reference Model* provides the framework for defining SLE transfer service specifications (references [8] to [12]) and an SLE-SM service specification. It defines the functional and management components of the MDOS and SLE System. It identifies the SLE transfer services which are used to extend space link services (references [2], [4], [5], and [6]) across the ground segment. It specifies the time spans of various management information entities used in SLE-SM.

This SCCS-SM Service Specification expands the scope of SLE-SM as identified in the Cross Support Reference Model to include management of space communication services and cross support transfer services in general, not just those directly related to the transfer of command and telemetry data (i.e., the scope of Space Link Extension).

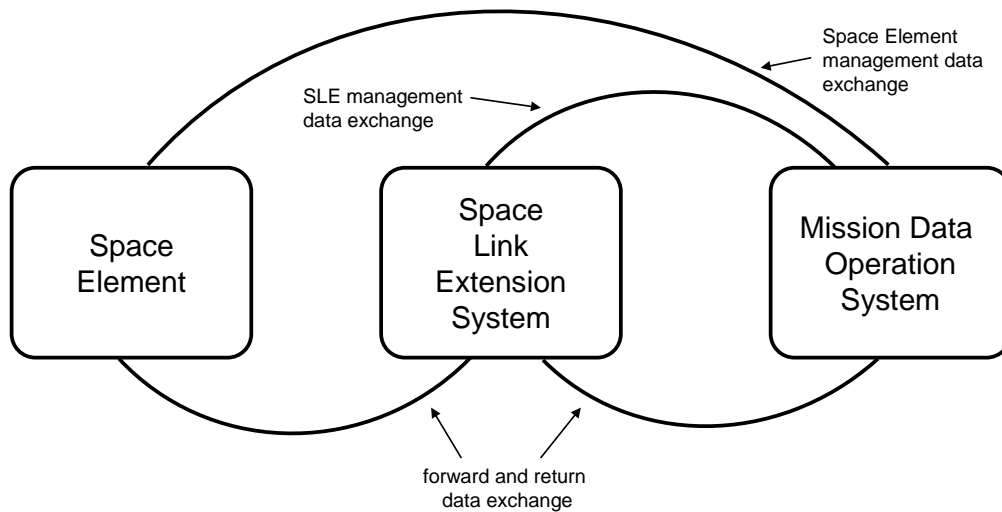

**Figure 1-1: Cross Support Reference Model Space Mission Data Exchange**

## 1.3 SCOPE

### 1.3.1 SCCS-SM SERVICES

The SCCS-SM services reflect the common practices of the space operations community and the contents of the SLE transfer specifications. Four SCCS Management Services are defined:

- a) Service Agreement service, which addresses the information that needs to be agreed before a cross support service can be established;
- b) Configuration Profile service, which addresses the establishment of sets of data concerning the space link and ground station configuration;
- c) Trajectory Prediction service, which addresses the transfer and updating of spacecraft trajectory data;
- d) Service Package service, which addresses the arrangement of spacecraft space link session times and execution of the transfer services.

### 1.3.2 SCCS-SM SERVICE PROCEDURES, OPERATIONS, AND MESSAGES

The SCCS-SM services are implemented by procedures, operations, and messages that effect the negotiation and commitment of resources for the provision of space link and transfer services. This establishes the mechanism by which a user requests services from a provider for individual spacecraft space link sessions (also known as contacts, passes, and tracks).

### 1.3.3 TRANSFER SERVICES ADDRESSED IN THIS RECOMMENDED STANDARD

This Recommended Standard deals with only three of the SLE transfer services defined in the *Cross Support Reference Model*:

- a) Forward Communications Link Transmission Unit (FCLTU, reference [11]);
- b) Return All Frames (RAF, reference [8]);
- c) Return Channel Frames (RCF, reference [9]).

The management of other SLE transfer services, including Return Operations Control Field (ROCF, reference [10]), Forward Space Packet (FSP, reference [12], supported by the Communications Operation Procedure-1, reference [7]) and a radiometric data transfer service, will be addressed in future versions of this Recommended Standard.

This Recommended Standard addresses the management of both online and offline return SLE transfer services. In this Recommended Standard, online return services are part of a larger class of services referred to as Space Link Session Transfer Services (because they are concurrent with an active space link), and offline services are part of a larger class of services referred to as Retrieval Transfer Services (because they are the mechanism by which data are retrieved from intermediate storage).

This Recommended Standard addresses the management of user-initiated transfer services only. Although some of the SLE transfer service specifications permit provider initiation, all implementations of SLE transfer services are user-initiated as of the time of the writing of this Recommended Standard. Therefore, under this version of SCCS-SM, the initiator is always the user, and the responder is always the provider.

This Recommended Standard provides a mechanism for defining and scheduling non-CCSDS transfer services that are bilaterally defined between the Complex and MDOS.

### 1.3.4 RF AND MODULATION SYSTEMS AND SPACE LINK SERVICES ADDRESSED IN THIS RECOMMENDED STANDARD

This Recommended Standard supports the exchange of information used in scheduling of services that employ radio frequency (RF) and modulation systems that are conformant with the CCSDS Recommended Standard 401.0, *Radio Frequency and Modulation Systems—Part 1: Earth Stations and Spacecraft* (reference [14]). Space link service providers that provide RF links that conform to CCSDS 401.0 can implement the full set of capabilities specified herein. However, the capabilities provided by this Recommended Standard for space communication service scheduling information exchange are not strictly limited to those recommended in CCSDS 401: for example, this Recommended Standard supports the use of additional forward subcarrier frequencies beyond those specified in CCSDS 401.

NOTE – The specific set of RF and modulation parameters and associated values that are fully supported by this Recommended Standard are specified in section 5.

Space link service providers that provide RF links that *do not* conform to CCSDS 401.0 or the extended parameters and values supported by this Recommended Standard may use bilaterally defined space link service information, or may simply implement a subset of the capabilities specified herein, as described in annex B.

### 1.3.5 LIMITATIONS, CONSTRAINTS, EXCLUSIONS AND QUALIFICATIONS

This version of the Recommended Standard contains the following limitations, constraints, exclusions and qualifications:

- a) The concept of *staging* in the *Cross Support Reference Model*—distributing the provision of transfer services across two or more Complexes that progressively process and transform a data stream—is not addressed in this document.
- b) This Recommended Standard does not address the mechanism for exchanging authentication and access control information associated with the creation of transfer service credentials.
- c) Ground systems and services that are not directly concerned with the transport of transfer frames (references [2] and [5]) and communications link transmission units (reference [6]) compliant to CCSDS Recommended Standards are not described. Processing of data held within the data fields of source packet Protocol Data Units (PDUs) (reference [3]) is outside the scope of this document.
- d) The initial establishment of a service relationship and the negotiation of a mission-length Service Agreement are not covered by this Recommended Standard.
- e) This Recommended Standard does not define the operations and messages required to perform execution-time monitoring and control of transfer services.
- f) The specification of systems to generate information required by SCCS-SM, such as mission planning (scheduling), flight dynamics (trajectory), mission monitoring and control, and ground station selection are outside the scope of this document. It is assumed that these systems will provide the data needed in the required format at the required times.
- g) SCCS-SM does not define the way in which Complex Management (CM) interfaces with the equipment that is used to provide the space link and transfer services, so the users in the MDOS do not need to be concerned about the internal workings of the Complex. In other words, Complex Management provides an interface to the user that hides the complexity of the provider's Complex.

## 1.4 APPLICABILITY

### 1.4.1 APPLICABILITY OF THIS RECOMMENDED STANDARD

This Recommended Standard serves as the basis for the development of compatible Agency standards for space communication service management systems. This Recommended Standard is applicable to space communication service management systems that are involved in cross support.

Although sharing ground systems between multiple space missions or between multiple spacecraft of the same space mission is not explicitly modeled, this Recommended Standard in no way precludes sharing ground systems.

### 1.4.2 LIMIT OF APPLICABILITY

This Recommended Standard is not a design for real space communication service management systems that may be implemented for the control and monitoring of existing or future missions.

## 1.5 RATIONALE

The primary goal of CCSDS is to increase the level of interoperability among Agencies. This Recommended Standard furthers that goal by establishing the means to manage the provision of space link and transfer services to be used in the area where most cross support activity occurs: between the tracking stations or ground data handling systems of various Agencies and the mission-specific components of a mission ground system. Reference [G1], *Cross Support Concept*, provides further discussion of the rationale for this Recommended Standard.

## 1.6 DOCUMENT STRUCTURE

### 1.6.1 ORGANIZATION

This document is organized as follows:

- a) Section 1 provides the purpose, scope, applicability, and rationale of this Recommended Standard and identifies the conventions and references used throughout the document. This section also describes how this document is organized. A brief description is provided for each section and annex so that the reader will have an idea of where information can be found in the document. It also identifies terminology that is used in this document but is defined elsewhere.
- b) Section 2 provides an overview of SCCS-SM, places it in its context, introduces some basic service management concepts, and identifies the SCCS-SM services specified in this Recommended Standard.

- c) Section 3 defines the SCCS-SM document exchange protocol.
- d) Section 4 defines the Service Package service.
- e) Section 5 defines the Configuration Profile service.
- f) Section 6 defines the Trajectory Prediction service.
- g) Section 7 defines the Service Agreement service.
- h) Annex A provides the definitions of the data types used in this Recommended Standard.
- i) Annex B identifies the minimum set of operations that are required for an implementation of SCCS-SM to be compliant with this Recommended Standard.
- j) Annex C contains a list of acronyms.
- k) Annex D lists the SCCS-SM parameters in alphabetical order, presented in tabular form.
- l) Annex E provides an overview of the Unified Modeling Language (UML) Version 2.0 diagramming notation, semantics, and conventions that are used in this Recommended Standard.
- m) Annex F lists the time parameters associated with the various information entities that are managed through SCCS-SM, and specifies the interrelationships between these terms.
- n) Annex G is a list of informative references.

## 1.6.2 HOW TO READ THIS DOCUMENT

It is important for readers of this document to have a basic understanding of:

- a) CCSDS Space Link Services (see references [2], [4], [5], and [6]);
- b) CCSDS-compliant radio frequency and modulation systems (reference [14]);
- c) CCSDS SLE services, as described in the *Cross Support Concept* document (reference [G1]) and the *Cross Support Reference Model* (reference [1]);
- d) SLE-SM concepts, as described in *Cross Support Concept* (reference [G1]). The SLE-SM concepts described in reference [G1] are essentially the same as, or a subset of, the concepts that are applicable to SCCS-SM. In the future, reference [G1] is expected to be updated to have SLE-SM replaced by SCCS-SM.

## 1.7 DEFINITIONS AND NOMENCLATURE

### 1.7.1 DEFINITIONS

#### 1.7.1.1 Definitions from the Cross Support Reference Model

This Recommended Standard makes use of the following terms that are defined in the *Cross Support Reference Model*, reference [1]:

- a) Invoker;
- b) Mission Data Operations System (MDOS);
- c) Operation;
- d) Performer;
- e) Service Agreement;
- f) Service Agreement Period;
- g) Service Management;
- h) Service Package Utilization Phase;
- i) (SLE) Complex;
- j) (SLE) Complex Management (CM);
- k) (SLE) Service Package;
- l) (SLE) Utilization Management (UM);
- m) (SLE) Transfer Service Instance;
- n) Space Link Session;
- o) Utilization Phase.

#### 1.7.1.2 Definitions from the RAF, RCF, and CLTU Service Specifications

This Recommended Standard makes use of the following terms that are defined in references [8], [9] and [11]:

- a) Active (State);
- b) Association;
- c) Communication Service;
- d) Delivery Mode (*delivery-mode*) (references [8] and [9] only);
- e) Invocation;



- f) Latency Limit (`latency-limit`) (references [8] and [9] only);
- g) Master Channel;
- h) Parameter;
- i) Performance;
- j) Port Identifier;
- k) Reporting Cycle (`reporting-cycle`);
- l) Return;
- m) Service Instance Provision Period;
- n) Spacecraft Identifier;
- o) Transfer Frame Version Number;
- p) Virtual Channel;
- q) Virtual Channel Identifier.

### 1.7.1.3 Definitions from TM Synchronization and Channel Coding

This Recommended Standard makes use of the following terms that are defined in reference [4]:

- a) Attached Sync Marker;
- b) Convolutional Code;
- c) Pseudo-Randomization;
- d) Reed-Solomon Check Symbols;
- e) Reed-Solomon Code;
- f) Turbo Code.

### 1.7.1.4 Definitions from TC Synchronization and Channel Coding

This Recommended Standard makes use of the following terms that are defined in reference [6]:

- a) Communications Link Control Word (CLCW);
- b) bit lock;
- c) RF availability.

### **1.7.1.5 Additional Definitions**

#### **1.7.1.5.1 Introduction**

For the purposes of this Recommended Standard, the following definitions also apply.

#### **1.7.1.5.2 Two-Phase Operation Procedure Pattern**

The pattern that is common to all SCCS-SM two-phase operation procedures; that is, operation procedures involving only an invocation and a single return (either a successful or failed return).

#### **1.7.1.5.3 Two-Phase Operation**

An SCCS-SM operation that conforms to the two-phase operation procedure pattern.

#### **1.7.1.5.4 Three-Phase Operation Procedure Pattern**

The pattern that is common to all SCCS-SM three-phase operation procedures; that is, operation procedures involving an invocation, an acknowledged return, and either a successful or failed return.

#### **1.7.1.5.5 Three-Phase Operation**

An SCCS-SM operation that conforms to the three-phase operation procedure pattern.

#### **1.7.1.5.6 Notify Operation Procedure Pattern**

The pattern that is common to all SCCS-SM notify operation procedures; that is, procedures involving performance of a locally invoked operation, the issuance of a notification, and subsequent confirmation of receipt of that notification.

#### **1.7.1.5.7 Notify Operation**

An SCCS-SM operation that conforms to the Notify operation procedure pattern.

#### **1.7.1.5.8 Sender and Receiver**

Entities that participate in the exchange of messages. The SCCS-SM document exchange protocol is described in terms of transmitting an SM Message Set from a Sender to a Receiver. On the occurrence of certain exception conditions, the Receiver sends SM Exception Responses (see 1.7.1.5.11) to the Sender.

#### **1.7.1.5.9 SM Document**

A standard-content communiqué exchanged between SM Sender and Receiver entities, containing either an SM Message Set (see 1.7.1.5.10) or an SM Exception Response (see 1.7.1.5.11).

#### **1.7.1.5.10 SM Message Set**

An ordered collection of one or more SM messages sent from a Sender to a Receiver in a single SM Document.

#### **1.7.1.5.11 SM Exception Response**

A standard-content communiqué that is returned from the Receiver to the Sender when the processing of a received document results in exception conditions.

#### **1.7.1.5.12 SM Message**

A standard-content component of an SM Message Set that is one of the four generic SM message types: invocation, operation return, notification, and confirmation.

#### **1.7.1.5.13 Syntactic Validation**

Determination that a received document is a properly formed SM document of a version that is supported by the Receiver.

#### **1.7.1.5.14 Authorization Validation**

The validation of an SM Message Set to ensure that the Sender of the message set is authorized to send messages in the context of the Service Agreement and that the Service Agreement is supported by the Receiver.

#### **1.7.1.5.15 Service Management Validation**

The validation of an SM message to ensure that the values of the parameters of the message are consistent among themselves, that the contents of the message are within the scope of the controlling Service Agreement, that all service management information that is prerequisite to the successful performance of the operation is in place, and that all resources required to successfully perform the operation are available (or expected to be available).

#### 1.7.1.5.16 Space Link Session Transfer Service

A transfer service that is active concurrent with a space link session, such that all data sent via a forward transfer service is transmitted across the forward space link with minimal delay, and data that is received via a return space link is transferred with minimal delay. The standard Space Link Session (SLS) Transfer Services include the forward SLE transfer services and the return SLE transfer services operating in timely online delivery mode. The MDOS and the Complex may also bilaterally define and implement non-CCSDS-standard SLS transfer services.

NOTE – The standard SLS Transfer Services will also include forward Cross Support Transfer Services (CSTSeS) and return CSTSeS operating in the timely delivery mode.

#### 1.7.1.5.17 Retrieval Transfer Service

A return transfer service that retrieves space link data from a data store. The data may be retrieved anytime from the beginning of the associated space link session until the end of the scheduled service period of the retrieval transfer service instance, which may be any specified time period up to the end of the Service Agreement period. The standard Retrieval Transfer Services include the forward SLE transfer services and the return SLE transfer services operating in complete online and offline delivery modes. The MDOS and the Complex may also bilaterally define and implement non-CCSDS-standard retrieval transfer services.

NOTE – The standard Retrieval Transfer Services will also include return Cross Support Transfer Services (CSTSeS) operating in the complete delivery mode.

#### 1.7.1.5.18 Rule-based Scheduling

A mode of scheduling in which the MDOS and the Complex are able to define a generic set of scheduling rules that CM uses to routinely schedule tentative space link session Service Packages on behalf of the mission. CM proposes each tentative Service Package to UM, which in turn accepts or declines it. Rule-based scheduling is a viable approach when a mission's requirements can be generically stated (e.g., two return link contacts per day, between 10 and 15 minutes each in duration) and the Complex is able to perform rule-based scheduling. When used appropriately, rule-based scheduling can result in higher efficiency in the utilization of a Complex's resources by allowing CM to fit the most contacts into a given schedule period. Rule-based scheduling, sometimes known as *generic scheduling* or *standing order* scheduling, is the primary scheduling mode for several TT&C networks.

#### 1.7.1.5.19 Scenario

A collection of space communication services that are scheduled to support an anticipated set of spacecraft activities during the execution of a Service Package. In some cases, it is possible to anticipate that one of several sets of spacecraft activities might occur during the

execution of a given Service Package, but specifically which of those sets will occur cannot be known at the time that the Service Package is scheduled. For example, for a planned spacecraft maneuver, it may be possible to anticipate ahead of time two outcomes (the maneuver executes as planned, or the maneuver is aborted, possibly at the last minute), each of which may have different space communication service requirements.

The Service Package is capable of specifying more than one scenario, each of which specifies the communications services required for each outcome. When a Service Package with more than one scenario is scheduled, the resources are reserved to support all of the scenarios in the Service Package, so that the scenario can be changed with minimal delay via the SELECT\_ALTERNATE\_SCENARIO operation.

NOTE – Support for multiple scenarios in a single Service Package is optional and depends on the ability of a Complex to reserve multiple sets of space communication resources and switch among them with small delay.

## 1.7.2 NOMENCLATURE

The following conventions apply throughout this Recommended Standard:

- a) the words ‘shall’ and ‘must’ indicate a binding and verifiable specification;
- b) the word ‘should’ indicates an optional, but desirable, specification;
- c) the word ‘may’ indicates an optional specification;
- d) the words ‘is,’ ‘are,’ and ‘will’ indicate statements of fact;
- e) when applied to tables contained within normative sections of this Recommended Standard, the phrase ‘is(are) defined in’ indicates normative requirements or message structure and content.

## 1.8 CONVENTIONS

### 1.8.1 THE UNIFIED MODELING LANGUAGE

The Unified Modeling Language (UML) diagrams used in this Recommended Standard (including class diagrams, sequence diagrams, activity diagrams, and state machine diagrams) follow the notation, semantics, and conventions imposed by the Version 2.0 UML specification of the Object Management Group (OMG). Annex E provides an overview of the UML 2.0 diagramming conventions that are used in this Recommended Standard.

## **1.8.2 SPECIFICATION OF SERVICE OPERATIONS**

### **1.8.2.1 General**

The typographical convention for a service operation is specified in 1.8.4.2, ‘Operation Names’. The specification of each operation is divided into subsections as follows:

### **1.8.2.2 Purpose Subsection**

The Purpose subsection provides a brief text description of the purpose of the operation.

### **1.8.2.3 Procedure Subsection**

The Procedure subsection specifies the sequencing and behavior of an operation. It defines the associated messages and describes the relationship of these messages to the operation. UML activity and sequence diagrams are used to describe procedural logic between the UM and CM. The typographical convention for a message is specified in 1.8.4.3, ‘Message Names’.

### **1.8.2.4 Requirements Subsection**

#### **1.8.2.4.1 General**

The Requirements subsection specifies the requirements for UM and/or CM in executing the operation. This subsection will reference messages, parameters, data sets, and composition requirements. The typographical conventions for these references are listed in 1.8.3.

#### **1.8.2.4.2 Identification of Service Management Validation and Operation Performance Requirements**

All UM and CM operations conform to operation procedure patterns, as defined in section 3. These operation procedure patterns contain abstractly defined activities for performing service management validation and performing the operation itself. The concrete definition of these activities is operation-specific and therefore deferred to the specification of the operation itself as defined in sections 4 to 7.

A UM or CM requirement that constitutes part or all of the service management validation activity for an operation includes the text ‘[service management validation]’ at the end of the requirement.

A UM or CM requirement that constitutes part or all of the performance of an operation includes the text ‘[perform operation]’ at the end of the requirement.

### 1.8.2.5 Message Subsection(s)

#### 1.8.2.5.1 General

Each message of an operation has subsections that define the message structure, the parameters of the message, and the rules and requirements for UM and/or CM in composing, validating, or processing them. The typographical convention for a message is specified in 1.8.4.3, ‘Message Names’.

#### 1.8.2.5.2 Class diagram

##### 1.8.2.5.2.1 General

A UML class diagram illustrates the structure of a message, its parts, and how those parts interrelate. Class diagram conventions that are used for SM messages include composition, generalization, multiplicity, and constraints. Enumeration notation is also used but only when it is involved in a composition constraint. Subsection E2 of annex E provides an overview of composition, generalization, multiplicity constraints, and enumeration in UML class diagrams.

##### 1.8.2.5.2.2 Data Set Classes

A message is decomposed into logical components called data sets, which contain associated parameters. The composition of one or more data sets is an instantiated message. Data sets are reusable and may be contained in more than one message class. Each data set is represented in the UML class diagram as a UML class, which is illustrated as a box with a line separating the name of the data set class from the list of parameters for that data set class. The typographical convention for the names of data set classes in class diagrams is specified in 1.8.4.4, ‘Data Set Names’. The typographical convention for the names of the parameters in data set classes in class diagrams is specified in 1.8.4.6, Parameter Names.

##### 1.8.2.5.2.3 Abstract Data Set Classes

An abstract data set is a data set that encapsulates common parameters that are inherited by multiple data sets. Abstract data sets adhere to the rules and conventions of an abstract class. The typographical convention for the names of abstract data sets in class diagrams is specified in 1.8.4.5, ‘Abstract Data Set Names’. The typographical convention for the names of the parameters in abstract data set classes in class diagrams is specified in 1.8.4.6, Parameter Names.

NOTE – Abstract data set classes appear only in the UML class diagrams. In the data set tables in the Parameter Subsection (see 1.8.2.6.1), the parameters of an abstract class are explicitly included in the tables of the data sets that inherit from that abstract class.

## 1.8.2.6 Parameters Subsection

### 1.8.2.6.1 Data Set Tables

Each data set is presented in a table that includes a table name and, for each parameter in the data set: the parameter name, definition/description, data type, units, and an applicable Service Agreement parameter (if any). The list of parameters in a data set table includes the parameters from the corresponding data set class in the UML class diagram, plus the parameters that the corresponding data set class inherits from any abstract classes. The typographical convention for the names of data set tables is specified in 1.8.4.4, ‘Data Set Names’. The typographical convention for parameter names in data set tables is specified in 1.8.4.6, ‘Parameter Names’.

### 1.8.2.6.2 Nullable Parameters

Some parameters may be optional or meaningful only in certain contexts. Such parameters are identified in the data type column of the data set table by the notation ‘<data type> OR NULL’, where <data type> is the data type that the parameter assumes when it is meaningful, and NULL indicates that the parameter is absent. For each nullable parameter, one or more data set composition and relationship requirements identify the conditions under which the parameter is NULL.

### 1.8.2.6.3 Applicable Service Agreement Parameter

Many SM message parameters are constrained to be within ranges or sets of values that are specified as part of the Service Agreement under the context of which the messages are exchanged. A data set parameter value will be constrained to be consistent with its Applicable Service Agreement Parameter (if present) in order for the message containing the parameter to pass service management validation.

An Applicable Service Agreement Parameter is normally identified simply by the parameter name as it appears in the appropriate Service Agreement data set. However, if the parameter name alone is ambiguous (e.g., the same parameter name is used in several data sets), the parameter name is distinguished by also identifying the associated data set.

The typographical conventions for an Applicable Service Agreement Parameter are specified in 1.8.4.6, ‘Parameter Names’.

## 1.8.2.7 Data Set Composition and Relationship Requirements Subsection

### 1.8.2.7.1 General

To complement the class diagram, data set composition and relationship requirements are indexed and listed in tables. These requirements will reference messages, parameters, abstract data sets and data sets. The typographical conventions for these references are listed in 1.8.4.



### 1.8.2.7.2 Identification of Syntactic Validation and Service Management Validation Requirements

All UM and CM operations conform to operation procedure patterns, as defined in 3.3.4.1. These operation procedure patterns contain abstractly defined activities for performing syntactic validation (i.e., ensuring conformance to message format) and service management validation (ensuring conformance to relationship requirements among parameter values within the message and parameters of other related data sets) on SM messages. The concrete definition of the syntax of a message and the service management requirements on the message content are operation-specific and therefore deferred to the specification of the operation-specific messages (see section 3).

A data set composition and relationship requirement that is to be validated as part of the syntactic validation activity for that message includes the text ‘[syntactic validation]’ at the end of the requirement.

A data set composition and relationship requirement that is to be validated as part of the service management validation activity for that message includes the text ‘[service management validation]’ at the end of the requirement.

## 1.8.3 STEREOTYPES

Common patterns in the specification are expressed as stereotypes. Stereotypes are defined using the UML stereotype conventions, which define the pattern, identify where context-specific data apply, and provide a name for the stereotype. UML stereotype conventions are also used to handle the application of a defined stereotype. When a stereotype is applied to a model element, which could be a sequence, activity, or data set in the specification, the element is referred to as an instance of the stereotype. Structurally, the element is extending that stereotype, i.e., using the pattern and adding traits and/or behavior to it. The typographical conventions for stereotypes and their usage are listed in 1.8.4.8, ‘Stereotype Names’.

## 1.8.4 TYPOGRAPHIC CONVENTIONS

### 1.8.4.1 New Terms and Key Concepts

*Italic* font in textual description is used to introduce to the reader a new term or phrase that represents a key concept of the specification. Subsequent usage of the term or phrase is in regular non-italicized font.

### 1.8.4.2 Operation Names

The typographical convention for an operation name is to use non-proportional font, Courier New, uppercase and with underscores between the words (e.g., CREATE\_SERVICE\_PACKAGE). The shorthand convention is to use the first character of each word in uppercase. For example, CSP is the shorthand representation of CREATE\_SERVICE\_PACKAGE.

### 1.8.4.3 Message Names

A message name will appear in non-proportional font, Courier New, camel-case, bold, with first letter capitalized (e.g., **CreateServicePackageInvocation**). The shorthand convention is to use the first character of each word in the operation name and add the first character of the message type with a hyphen between the operation and message type. For example, **CSP-I** is shorthand for **CreateServicePackageInvocation**.

Hyphens may appear in message names in order to facilitate readability. The hyphens are not part of the message names.

### 1.8.4.4 Data Set Names

Names of data set classes in UML class diagrams appear in proportional font, camel-case with first character capitalized, and in bold (e.g., **ReturnCarrierRequestType**).

Names of data set tables appear in non-proportional font, Courier New, camel-case with first character capitalized, and in bold (e.g., **ReturnCarrierRequestType**).

Hyphens may appear in data set class and table names in order to facilitate readability. The hyphens are not part of the data set names.

### 1.8.4.5 Abstract Data Set Names

Conventionally, abstract data set class names in UML class diagrams are similar to data set class names but distinguished by italics. Thus, abstract data set class names appear in proportional font, camel-case with first character capitalized, in bold, and in italics (e.g., ***CarrierRequestType***).

Hyphens may appear in abstract data set class names in order to facilitate readability. The hyphens are not part of the abstract data set class names.

### 1.8.4.6 Parameter Names

Names of parameters in data set classes and abstract data set classes in UML class diagrams appear in proportional font, and camel-case with the first character in lower-case (e.g., `pcmWaveform`).

Names of parameters in data set tables appear in non-proportional font, Courier New, and camel-case with the first character in lower-case (e.g., `pcmWaveform`).

Some parameters may specify a data type or data set to further distinguish the parameter. The convention for including a data type is to list the parameter name using the font and camel-case conventions mentioned above and append the name of the data type, separated by a colon (e.g., `reason: <<Denial>>`). The convention for including a data set is to prepend

the parameter name with the name of the data set separated by a colon (e.g., **F401SpaceLinkCarrierAgreement**: modulationIndexRange). The data type and data set follow their respective typographical conventions.

Hyphens may appear in parameter names in order to facilitate readability. The hyphens are not part of the parameter names.

#### 1.8.4.7 Enumeration Values

Some parameters are enumeration types. Enumeration values will appear in non-proportional font, Courier New, and enclosed in single quotes (e.g., 'NRZ-L').

#### 1.8.4.8 Stereotype Names

Typographical conventions are used to distinguish between a reference to a stereotype definition, a reference to an applied stereotype (as a characteristic of a dataset, for instance), and a reference to all instantiations that apply the stereotype.

- a) Reference to a stereotype definition will appear in non-proportional font, Courier New, camel-case with first character capitalized, and enclosed by a pair of guillemets (e.g., <<Invocation>>).
- b) The applied stereotype of an instantiation will appear in non-proportional font, Courier New, camel-case, and enclosed by a pair of guillemets (e.g., <<invocation>>).
- c) General reference to all instantiations of a stereotype will appear in non-proportional font, Courier New, and camel-case with first character capitalized (e.g., Invocation).

Hyphens may appear in stereotype names in order to facilitate readability. The hyphens are not part of the stereotype names.

### 1.8.5 OTHER CONVENTIONS

Color in diagrams is used for emphasis only and does not convey information about a specification. Examples of color usage in this document include highlighting UML notes in diagrams and emphasizing enumeration in a class diagram.

### 1.8.6 NOTES

Notes are not formally part of this Recommended Standard. They are isolated from the formal statements and are introduced by the word NOTE.

EXAMPLE

NOTE – This is an example of a note.

## 1.9 REFERENCES

The following documents contain provisions which, through reference in this text, constitute provisions of this Recommended Standard. At the time of publication, the editions indicated were valid. All documents are subject to revision, and users of this Recommended Standard are encouraged to investigate the possibility of applying the most recent editions of the documents indicated below. The CCSDS Secretariat maintains a register of currently valid CCSDS Recommended Standards.

- [1] *Cross Support Reference Model—Part 1: Space Link Extension Services*. Recommendation for Space Data System Standards, CCSDS 910.4-B-2. Blue Book. Issue 2. Washington, D.C.: CCSDS, October 2005.
- [2] *TM Space Data Link Protocol*. Recommendation for Space Data System Standards, CCSDS 132.0-B-1. Blue Book. Issue 1. Washington, D.C.: CCSDS, September 2003.
- [3] *Space Packet Protocol*. Recommendation for Space Data System Standards, CCSDS 133.0-B-1. Blue Book. Issue 1. Washington, D.C.: CCSDS, September 2003.
- [4] *TM Synchronization and Channel Coding*. Recommendation for Space Data System Standards, CCSDS 131.0-B-1. Blue Book. Issue 1. Washington, D.C.: CCSDS, September 2003.
- [5] *AOS Space Data Link Protocol*. Recommendation for Space Data System Standards, CCSDS 732.0-B-2. Blue Book. Issue 2. Washington, D.C.: CCSDS, July 2006.
- [6] *TC Synchronization and Channel Coding*. Recommendation for Space Data System Standards, CCSDS 231.0-B-1. Blue Book. Issue 1. Washington, D.C.: CCSDS, September 2003.
- [7] *Communications Operation Procedure-1*. Recommendation for Space Data System Standards, CCSDS 232.1-B-1. Blue Book. Issue 1. Washington, D.C.: CCSDS, September 2003.
- [8] *Space Link Extension—Return All Frames Service Specification*. Recommendation for Space Data System Standards, CCSDS 911.1-B-2. Blue Book. Issue 2. Washington, D.C.: CCSDS, December 2004.
- [9] *Space Link Extension—Return Channel Frames Service Specification*. Recommendation for Space Data System Standards, CCSDS 911.2-B-1. Blue Book. Issue 1. Washington, D.C.: CCSDS, December 2004.
- [10] *Space Link Extension—Return Operational Control Fields Service Specification*. Recommendation for Space Data System Standards, CCSDS 911.5-B-1. Blue Book. Issue 1. Washington, D.C.: CCSDS, December 2004.

- [11] *Space Link Extension—Forward CLTU Service Specification*. Recommendation for Space Data System Standards, CCSDS 912.1-B-2. Blue Book. Issue 2. Washington, D.C.: CCSDS, December 2004.
- [12] *Space Link Extension—Forward Space Packet Service Specification*. Recommendation for Space Data System Standards, CCSDS 912.3-B-1. Blue Book. Issue 1. Washington, D.C.: CCSDS, December 2004.
- [13] *Orbit Data Messages*. Recommendation for Space Data System Standards, CCSDS 502.0-B-1. Blue Book. Issue 1. Washington, D.C.: CCSDS, September 2004.
- [14] *Radio Frequency and Modulation Systems—Part 1: Earth Stations and Spacecraft*. Recommendation for Space Data System Standards, CCSDS 401.0-B-20. Blue Book. Issue 20. Washington, D.C.: CCSDS, April 2009.
- [15] *XML Specification for Navigation Data Messages*. Draft Recommendation for Space Data System Standards, CCSDS 505.0-R-1. Red Book. Issue 1. Washington, D.C.: CCSDS, November 2005.
- [16] “CCSDS-910.11-B-1\_XML\_schemas.”  
[http://public.ccsds.org/publications/archive/CCSDS-910.11-B-1\\_XML\\_schemas.zip](http://public.ccsds.org/publications/archive/CCSDS-910.11-B-1_XML_schemas.zip).
- [17] Takeshi Imamura, Blair Dillaway, and Ed Simon. *XML Encryption Syntax and Processing*. Edited by Donald Eastlake and Joseph Reagle. W3C Recommendation. N.p.: W3C, December 2002. <<http://www.w3.org/TR/xmlenc-core/>>
- [18] Mark Bartel, et al. *XML-Signature Syntax and Processing*. Edited by Donald Eastlake, Joseph Reagle, and David Solo. W3C Recommendation. N.p.: W3C, February 2002. <<http://www.w3.org/TR/xmldsig-core/>>
- [19] Phillip Hallam-Baker and Shivaram H. Mysore, eds. *XML Key Management Specification (XKMS 2.0)*. Version 2.0. W3C Recommendation. N.p.: W3C, June 2005. <<http://www.w3.org/TR/xkms2/>>

## 2 OVERVIEW OF SCCS SERVICE MANAGEMENT

### 2.1 FUNDAMENTAL CONCEPTS

#### 2.1.1 SCCS SERVICE MANAGEMENT ENVIRONMENT

The SCCS-SM environment is illustrated in figure 2-1, which is derived from the *Cross Support Reference Model* (reference [1]). The SCCS-SM model is essentially a generalization of the Space Link Extension (SLE) focus of reference [1] to encompass more space communication cross support services than SLE services.

In this generalized model, *SCCS services*, comprising both *SCCS transfer services* and *SCCS service management*, provide the interfaces between an *SCCS Complex* that provides SCCS transfer services and TT&C space link services, and a spaceflight mission that uses the services that the Complex provides. The spaceflight mission is composed of a single *Mission Spacecraft* and the *Mission Data Operations System* (MDOS), which represents all of the mission's ground-based functions.

A key concept of the SLE architecture (and its generalization for SCCS) is that the MDOS may have multiple transfer service users communicating with multiple instruments or computer applications onboard the mission spacecraft during the same space link session. The transfer services provide individual 'pipes' for these multiple connections. Each such pipe is realized as a *transfer service instance*.

The transfer service instances rely on shared Complex space link resources like antennas, receivers, frame synchronizers, and so on. To facilitate this sharing of space link resources among the various SLE transfer service users, the UM coordinates and manages space link and transfer services on behalf of the service users within the MDOS.

The interactions between *Utilization Management* (UM) and *Complex Management* (CM) are the domain of SCCS-SM. The SLE transfer service interactions between the users in the MDOS and the Complex are the subject of the SLE transfer CCSDS Recommended Standards. Communications across the space link are the subject of CCSDS Recommended Standards for RF, modulation, coding, and data links. The interactions between UM and transfer service users, the interactions between CM and the resources that actually provide the space link and transfer services, and the internal management of CM and UM are outside the scope of this Recommended Standard.

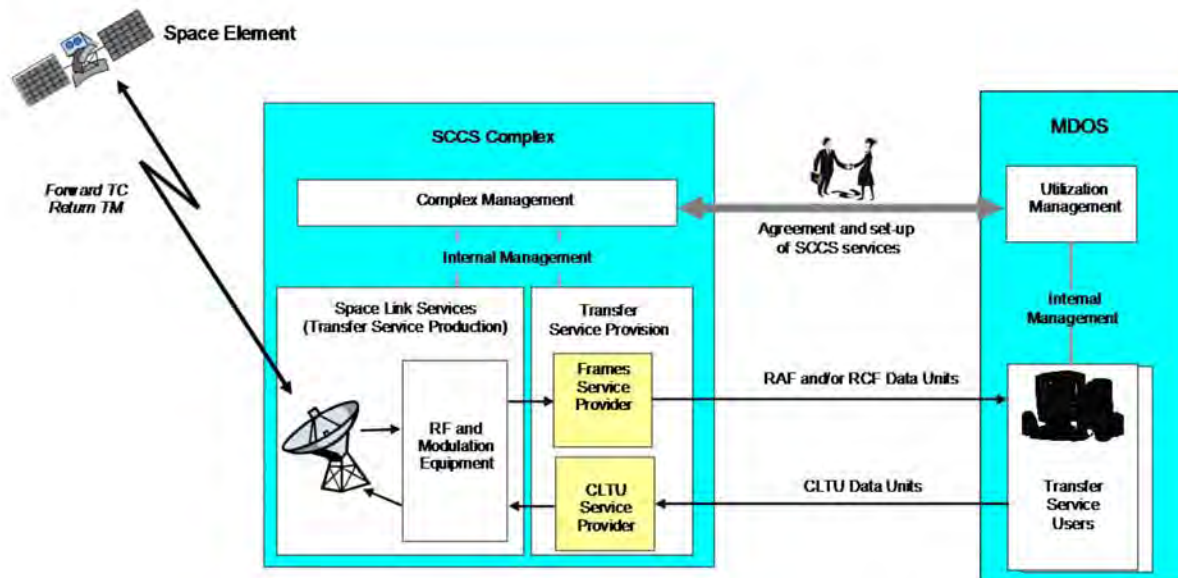

**Figure 2-1: SCCS Service Management Environment**

## 2.1.2 THE PURPOSE OF SCCS SERVICE MANAGEMENT

The purpose of SCCS-SM is to standardize and automate, as far as practicable, those interactions between users and providers of space link and transfer services that are required to set the values of the parameters of space link and SLE transfer services. In addition, SCCS-SM provides the means to configure the resources needed by the user and provider to execute those services. In essence, SCCS-SM provides a standard way for the user and provider:

- a) to set the values of the parameters involved in space link and transfer services;
- b) to specify the services needed to execute space link and transfer services;
- c) to configure ground stations for the establishment of space links;
- d) to configure ground stations for processing of forward and return space link data;
- e) to arrange timely provision of transfer services;
- f) to disseminate Trajectory Predictions.

CM presents the services performed within the Complex in a standard way to the user, as defined in detail in the later sections of this document.

The roles of UM and CM, and the SCCS-SM services that are set up between them, are outlined in the following subsections.

### 2.1.3 UTILIZATION MANAGEMENT

*Utilization Management* is the function within the MDOS that coordinates the requests by users for space link and transfer services from the Complex.

Utilization Management role:

- a) requests periods of provision of space link services and cross support transfer services (including space link extension transfer services);
- b) provides configuration information for RF, modulation, space link service, and cross support transfer service;
- c) provides Trajectory Predictions;
- d) interfaces with Mission User Entities within the MDOS to enable the execution of transfer services and to collect status information.

### 2.1.4 COMPLEX MANAGEMENT

The SCCS Complex is a collection of ground station resources under a single management authority. It may be a single ground station or a network of ground stations. The space mission uses the Complex's services so that the MDOS can communicate with and track the spacecraft.

The Complex acts as the transfer service producer and provider, which requires that it execute the space link services used to communicate data to and from the mission spacecraft.

*Complex Management* controls the extent to which Utilization Management can affect actual Complex resources. Because Complex Management acts as the intermediary for Utilization Management, only those aspects of the resources of a Complex that Complex Management chooses to expose are visible to Utilization Management for management operations.

Complex Management role:

- a) negotiates types of services, numbers of service instances, and the length of the Service Agreements with UM;
- b) responds to requests from the UM for individual space link sessions and access to recorded data;
- c) provides configuration information to the resources of the Complex to enable the production and provision of space communication services, and monitors their correct operation.



### 2.1.5 SCCS SERVICE MANAGEMENT INFORMATION

To facilitate the standardization and automation of the interactions between UM and CM that are involved in requesting space link and transfer services, SCCS-SM establishes a common set of managed information to be exchanged and operated upon by the SCCS-SM services. This common set of managed information is related to the space link and transfer services provided by a Complex.

SCCS-SM organizes the managed information into four conceptual types of information entities:

- a) *Service Packages*, each of which specifies the antenna, space link and transfer service configuration, and time span for a particular space link session, or the transfer service configuration and time span for one retrieval transfer instance;
- b) *Configuration Profiles*, which are used by CM and UM to define preset configurations of space link and transfer service production parameters, and sequences of events which may be used to schedule changes of configuration;
- c) *Trajectory Predictions*, each of which defines the course of the spacecraft over a period of time; and
- d) *Service Agreements*, which cover all aspects of SCCS-SM and define the bounds for the three other information entities.

## 2.2 OVERVIEW OF SCCS MANAGEMENT SERVICES

### 2.2.1 INTRODUCTION

SCCS-SM comprises a set of services for the standardized exchange of management information. Each of these management services contains sufficient information for authentication, credentials, and general security concerns. The management services are:

- a) *Service Package service* (see 2.2.3);
- b) *Configuration Profile service* (see 2.2.4);
- c) *Trajectory Prediction service* (see 2.2.5); and
- d) *Service Agreement service* (see 2.2.6).

In general, each management service involves procedures, operations, and messages to effect negotiation and commitment of resources for the provision of space link and SLE transfer services.

Each of the management services defines the operations that can be invoked by UM and the operations that can be invoked by CM, as well as the messages that are exchanged as part of each operation.

## 2.2.2 SCCS-SM RECOMMENDED STANDARD SUMMARY

The information, operations, and reference framework relationships associated with the SCCS-SM services are summarized in figure 2-2.

The names of operations that are performed upon invocation from an external entity use the imperative or present tense, while the names of notify operations (which emit a notification after a management function has been performed) use the past tense.

## 2.2.3 SERVICE PACKAGE SERVICE

### 2.2.3.1 General

The SCCS-SM Service Package service is used to request new contacts or modify or delete existing scheduled contacts.

There are seven Service Package operations that CM can perform when invoked by UM:

- a) `CREATE_SERVICE_PACKAGE` (CSP)—to request CM to create a Service Package;
- NOTE – Creation of a Service Package implies that resources to support all scenarios contained within that package have been committed by the Complex.
- b) `REPLACE_SERVICE_PACKAGE` (RSP)—to replace parameters or references in an existing Service Package at CM;
  - c) `DELETE_SERVICE_PACKAGE` (DSP)—to delete a Service Package that is either proposed or established at CM;
  - d) `QUERY_SERVICE_PACKAGE` (QSP)—to query the content of an existing Service Package;
  - e) `SELECT_ALTERNATE_SCENARIO` (SAS)—to select an alternate Service Scenario of an existing Service Package at CM to be the scenario to be used before or during the execution of the Service Package;
  - f) `APPLY_NEW_TRAJECTORY` (ANT)—to apply a new Trajectory Prediction to an existing Service Package at CM;
  - g) `APPLY_NEW_SPACE_LINK_EVENTS_PROFILE` (ANSLEP)—to apply a new Space Link Events Profile to an existing Service Package at CM.

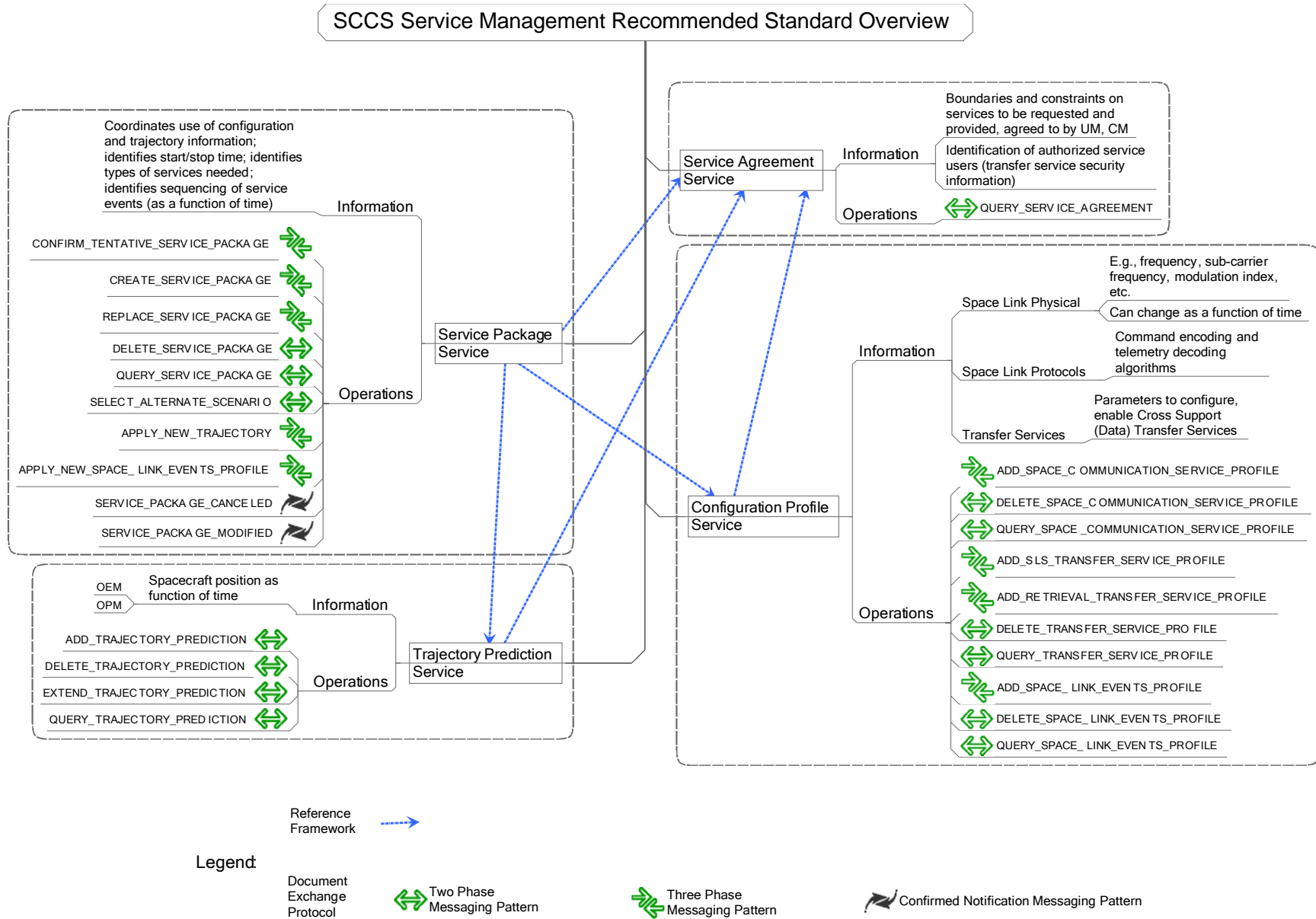

Figure 2-2: SCCS-SM Recommended Standard Overview

There are two Service Package operations that CM can perform autonomously and notify UM:

- `SERVICE_PACKAGE_CANCELLED` (SPC)—to cancel an existing Service Package that is no longer supportable by the Complex;
- `SERVICE_PACKAGE_MODIFIED` (SPM)—to modify an existing Service Package because of a change in conditions in the Complex that makes the Service Package supportable only if modifications are applied.

There is one Service Package operation that UM can perform when invoked by CM:

- `CONFIRM_TENTATIVE_SERVICE_PACKAGE` (CTSP)—to confirm acceptance of a Service Package proposed as a result of rule-based scheduling by CM. Proposing a Service Package implies either (1) that resources to support the scenario contained within that package have been committed by the Complex, or (2) that such resources were potentially available at the time of the CTSP invocation, but will not be committed until and unless the package is accepted by UM (as defined by the `schedulingMode` parameter in the Service Agreement).

The following subsections more fully describe the Service Package operations.

### 2.2.3.2 `CREATE_SERVICE_PACKAGE`

UM invokes a `CREATE_SERVICE_PACKAGE` operation to request either (a) a Space Link Session Service Package (a collection of space communication services associated with a space link session), or (b) a Retrieval Service package (a retrieval transfer service instance that is to be active for a specified period of time).

For a Space Link Session Service Package, a **CreateServicePackageInvocation (CSP-I)** message specifies the information that is contained in the Service Package that results from the invocation, with the following exceptions:

- a) For each space link carrier in each space communication service of each scenario, UM may defer selection of the antenna(s) to CM, or constrain or influence the selection. Antenna selection by CM is based on availability and visibility at the time of the requested contact of an antenna identified in the Service Agreement, and conformance with the space link characteristics of the referenced Space Communication Service Profile(s). UM may constrain the selection to a subset of the antennas identified in the Service Agreement, and—whether thus constrained or not—may indicate a subset of preferred antennas. CM will first attempt to schedule a preferred antenna if indicated; if this is not possible, it will attempt to schedule any acceptable antenna.
- b) For each space link carrier in each space communication service of each scenario, the specific start and stop times in the resultant Service Package are derived from preferred start time, minimum/preferred contact durations, and optional start lag/lead

times that are specified for the Space Communication Service Profiles that are referenced by the **CSP-I**. These parameters allow CM flexibility in fitting the request into the schedule.

- c) Transfer service instances may be active through changes across multiple scenarios. Each scenario in a **CSP-I** contains a reference to one or more Space Communication Service Profiles, each containing one or more Space Link Carrier Profiles, each of which in turn references one or more Transfer Service Profiles, for which corresponding transfer service instances may be enabled. The resulting service package contains, in effect, a pool of transfer service instances that may be used by multiple scenarios. Each transfer service instance may be referenced with a *service mapping* by carriers in more than one scenario. This allows UM to request transfer service instances that will persist if different scenarios are selected while the Service Package is in execution.
- d) A **CSP-I** may defer specification of transfer service instances. If an incomplete (that is, without transfer services specified) **CSP-I** is accepted by CM, UM will be expected to subsequently fill in the missing elements of the Service Package (i.e., the specific transfer services to be provided) by invoking a complete `REPLACE_SERVICE_PACKAGE` operation prior to the start time of the Service Package. This capability supports the mode of operation wherein UM needs to schedule the space link weeks or months in advance, and only needs to be concerned about the details of the transfer services for contacts once the space link carriers are scheduled.
- e) A **CSP-I** may defer specification of space link events. If an incomplete (that is, without space link events specified) **CSP-I** is accepted by CM, UM will be expected to subsequently fill in the missing elements of the Service Package (i.e., the specific space link event sequences to be executed) by invoking a complete `REPLACE_SERVICE_PACKAGE` operation prior to the start time of the Service Package. This capability supports the mode of operation wherein UM needs to schedule the space link weeks or months in advance, and only needs to be concerned about the details of the space link event sequences once the space link carriers are scheduled.

For a Retrieval Service Package, the **CreateServicePackageInvocation (CSP-I)** message specifies the information that defines the Retrieval Service Package that results from the invocation, except that the **CSP-I** does not contain the information that specifies how the provider interface port is to be accessed. That information is supplied to the Service Package by CM.

In response to a **CSP-I**, CM acknowledges the invocation. An acknowledgement is followed by a *successful return* or a *failed return* at or before the expected disposition time.

The Service Package is generated by CM as a result of the successful performance of a `CREATE_SERVICE_PACKAGE` operation.

For a Space Link Session Service Package, the **CreateServicePackageSuccessful-Return (CSP-SR)** contains the successfully scheduled Service Package, and indicates that the resources needed to support all of the scenarios in the Service Package are being held in reserve and will be applied at the specified time. It contains the start and stop times of the service package itself, each of the space communication services, each of the space link carriers within those space communication services, and each of the SLS transfer service instance provision periods (given the time window options defined in the **CSP-I**) and the provider-specific information required for the transfer service provision to take place (e.g., provider access information). The **CSP-SR** also contains the status of each referenced Trajectory Prediction at the time that the Service Package was scheduled: i.e., that the referenced Trajectory Prediction is available and covers the duration of the scheduled Service Package; that the referenced Trajectory Prediction is available but **does not** cover the duration of the scheduled Service Package; or that the referenced Trajectory Prediction was **not** available as of the time that the Service Package was scheduled. If event sequences were specified for the Service Package, the **CSP-SR** also contains details of events that affect availability or configuration of the space link.

For a Retrieval Service package, the **CSP-SR** confirms the configuration and duration of the successfully scheduled Retrieval Transfer Service instance.

A **CreateServicePackageFailedReturn (CSP-FR)** indicates that some aspect of the **CSP-I** could not be accommodated within the time window specified. Each failed return identifies the reason(s) for failure.

### 2.2.3.3 REPLACE\_SERVICE\_PACKAGE

UM invokes the **REPLACE\_SERVICE\_PACKAGE** operation to modify one or more parameters of an already created Service Package. Such a modification might be driven, for example, by an updated ‘acquisition of signal’ or ‘loss of signal’ calculation, or by the need to complete a partial Service Package with transfer services or space link events sequences deferred. The **RSP** operation allows the UM to update a Service Package without releasing any already allocated resources but simply to add, remove, or change certain parameters and invoke any necessary reprocessing by CM.

The **ReplaceServicePackageInvocation (RSP-I)** has almost exactly the same information as the **CSP-I**, the only difference being that whereas the **CSP-I** contains the identifier of the new Service Package to be created, the **RSP-I** contains a reference to the identifier of the existing Service Package that is to be replaced.

Invocation of the **RSP** operation triggers revalidation of the Service Package as CM determines if the new space link and transfer service configuration(s) can be supported using the resources already allocated to the Service Package or other resources as necessary. If the replacement is successful, the original Service Package is deleted and the replacement takes its place. If the replacement fails, CM retains the original Service Package and informs UM of the reason for rejecting the replacement.

#### 2.2.3.4 DELETE\_SERVICE\_PACKAGE

UM invokes the DELETE\_SERVICE\_PACKAGE operation to remove an existing Service Package from CM. Upon successful completion of this operation CM will no longer carry the Service Package in its operational schedule; i.e., the resources needed to provide the services will be released.

#### 2.2.3.5 QUERY\_SERVICE\_PACKAGE

UM invokes the QUERY\_SERVICE\_PACKAGE operation to obtain the contents of an existing Service Package. The return information will reflect any updates resulting from successful SELECT\_ALTERNATE\_SCENARIO, APPLY\_NEW\_TRAJECTORY, or APPLY\_NEW\_SPACE\_LINK\_EVENTS\_PROFILE operations, and any modifications which caused CM to issue SERVICE\_PACKAGE\_MODIFIED notifications. With the exception of any such updates, the contents of the returned Service Package are identical to that provided in the last successful return message for either a CSP or RSP operation (i.e., CSP-SR and RSP-SR), or in the invocation message for a successful CTSP operation.

#### 2.2.3.6 SELECT\_ALTERNATE\_SCENARIO

UM may invoke the SELECT\_ALTERNATE\_SCENARIO operation for service provision in accordance with an alternate scenario of an existing Service Package. Since, as a condition of accepting either a CSP-I or RSP-I, CM commits to providing sufficient resources to support all of the alternate scenarios in the Service Package, an alternate scenario can be invoked on a much shorter time scale and with a much higher probability of success than if UM were to invoke a CSP or RSP operation.

#### 2.2.3.7 APPLY\_NEW\_TRAJECTORY

UM invokes an APPLY\_NEW\_TRAJECTORY operation for an existing Service Package to indicate that computation of the data needed to acquire and maintain communication links between the space body and the Complex (such as antenna pointing angles, Doppler compensation offsets, signal level adjustments, and light-time compensation adjustments) are to be in reference to the alternate (new) Trajectory Prediction. CM reevaluates all of the scenarios of the existing Service Package that the ANT-I indicates are to be in reference to the new trajectory, and returns an updated Service Package with reference(s) to the new Trajectory Prediction. The updated Service Package also indicates the status of the newly referenced Trajectory Prediction with respect to the Service Package, as described for the CSP-SR in 2.2.3.2.

### 2.2.3.8 APPLY\_NEW\_SPACE\_LINK\_EVENTS\_PROFILE

UM invokes an `APPLY_NEW_SPACE_LINK_EVENTS_PROFILE` operation for an existing Service Package to indicate that a Space Link Events Profile, currently referenced by one or more Service Packages, is to be superseded by a different Space Link Events Profile which is already available at CM. CM reevaluates all of the scenarios of the referenced Service Package that reference the superseded Space Link Events Profile to ensure that it (CM) can continue to provide the agreed-upon support. If it can continue to provide the services, CM returns the updated Service Package information, indicating the new, updated events. If it cannot, CM returns the appropriate error information, but does not update the Service Package to utilize the updated Space Link Events Profile; i.e., the Service Package is retained as it was prior to the **ANSLEP-I**.

### 2.2.3.9 CONFIRM\_TENTATIVE\_SERVICE\_PACKAGE

CM invokes a `CONFIRM_TENTATIVE_SERVICE_PACKAGE` operation to offer a space link session at a time specified within the invocation, as determined by *rule-based scheduling* (see 1.7.1.5.18) performed by CM. All details of such rule-based scheduling are bilaterally agreed between UM and CM and are beyond the scope of the SCCS Service Management Recommended Standard.

A **ConfirmTentativeServicePackageInvocation (CTSP-I)** message contains a description of the tentative Service Package, which has the following restrictions:

- a) the Service Package will contain one and only one service scenario;
- b) retrieval transfer services are not available via rule-based scheduling;
- c) space link events profiles are not available via rule-based scheduling;
- d) specification of transfer services cannot be deferred in rule-based schedules.

UM confirms the service package by sending a **ConfirmTentativeServicePackageSuccessfulReturn (CTSP-SR)**. If UM does not want to use the tentative service package, it declines by sending a **ConfirmTentativeServicePackageFailedReturn (CTSP-FR)**.

### 2.2.3.10 SERVICE\_PACKAGE\_CANCELLED

CM invokes a `SERVICE_PACKAGE_CANCELLED` operation when it is unable to continue with a commitment to provide the agreed-upon services for an existing Service Package. This may be the result either of internal CM conditions or of a Service Package that still has items, such as transfer services or event sequences deferred beyond the mutually agreed minimum service definition lead time (prior to the start time of the Service Package).

This operation results in a notification to UM of the cancelled Service Package.



### 2.2.3.11 SERVICE\_PACKAGE\_MODIFIED

CM invokes a `SERVICE_PACKAGE_MODIFIED` operation when it can continue to support the Service Package only if modifications are applied. As a condition of performing this operation, CM ensures that it is within all of the constraints of the **CSP-I** of the Service Package and any subsequent **RSP-I**, or **SAS-I**, applied to the Service Package. In other words, CM continues to honor any start and stop window constraints, agreed-to minimum contact duration, etc.

This operation results in a notification to UM of the modified Service Package.

## 2.2.4 CONFIGURATION PROFILE SERVICE

A Configuration Profile holds predefined sets of detailed configuration that are referenced in Service Packages and subsequently used by CM to configure the Complex to provide the various space communication services.

The SCCS-SM Configuration Profile service is used to add, delete, and query the configuration profile information entities that are referenced by Service Packages. The Configuration Profile service handles four types of configuration profiles: *Space Communication Service Profiles* (each of which specifies the RF, modulation, and coding characteristics of one or more space link carriers), *Space Link Session (SLS) Transfer Service Profiles* (each of which specifies the configuration of an online SLE transfer service instance), *Retrieval Transfer Service Profiles* (each of which specifies the configuration of an offline SLE transfer Service instance) and *Space Link Events Profiles* (each of which specifies one or more time-referenced sequences of predefined space link carrier configuration parameter value changes).

There are ten Configuration Profile operations that CM can perform when invoked by UM:

- a) `ADD_SPACE_COMMUNICATION_SERVICE_PROFILE` (ASCSP)—to add a new Space Communication Service Profile at CM;
- b) `DELETE_SPACE_COMMUNICATION_SERVICE_PROFILE` (DSCSP)—to delete a Space Communication Service that is currently available at CM;
- c) `QUERY_SPACE_COMMUNICATION_SERVICE_PROFILE` (QSCSP)—to query the content of a Space Communication Service Profile that is currently available at CM;
- d) `ADD_SPACE_LINK_EVENTS_PROFILE` (ASLEP)—to add a new Space Link Events Sequence Profile at CM;
- e) `DELETE_SPACE_LINK_EVENTS_PROFILE` (DSLEP)—to delete a Space Link Events Sequence Profile that is currently available at CM;

- f) `QUERY_SPACE_LINK_EVENTS_PROFILE (QSLEP)`—to query a Space Link Events Sequence Profile that is currently available at CM;
- g) `ADD_SLS_TRANSFER_SERVICE_PROFILE (ASTSP)`—to add a new Space Link Session Transfer Service Profile at CM;
- h) `ADD_RETRIEVAL_TRANSFER_SERVICE_PROFILE (ARTSP)`—to add a new Retrieval Transfer Service Profile at CM;
- i) `DELETE_TRANSFER_SERVICE_PROFILE (DTSP)`—to delete a Retrieval or SLS Transfer Service Profile that is currently available at CM;
- j) `QUERY_TRANSFER_SERVICE_PROFILE (QTSP)`—to query the contents of a Retrieval or SLS Transfer Service Profile that is currently available at CM.

There are no Configuration Profile operations that are performed by UM.

UM invokes the `ADD_SPACE_COMMUNICATION_SERVICE_PROFILE`, `ADD_SLS_TRANSFER_SERVICE_PROFILE`, `ADD_RETRIEVAL_TRANSFER_SERVICE_PROFILE`, or `ADD_SPACE_LINK_EVENTS_PROFILE` operation to add a new profile to the set of Configuration Profiles on record at the Complex. Each new Profile is validated by CM against the previously negotiated Service Agreement to determine if the parameter values are within the scope of the agreement. If they are, CM accepts the new profile and informs UM. If the request is invalid, CM rejects the new profile and informs UM, citing the reason(s) for rejection.

UM invokes the `DELETE_SPACE_COMMUNICATION_SERVICE_PROFILE`, `DELETE_TRANSFER_SERVICE_PROFILE` (which applies to both SLS and Retrieval Transfer Service Profiles), or `DELETE_SPACE_LINK_EVENTS_PROFILE` operation to delete no-longer-needed profiles. Normally CM will comply with the invocation, delete the profile, and confirm the deletion to UM. However, if the Profile is being referenced by a scheduled Service Package or another available Configuration Profile when the delete operation is invoked, CM will not delete the Profile, and instead will inform UM that the deletion operation failed because the Profile is being referenced by a Service Package or Configuration Profile.

UM invokes the `QUERY_SPACE_COMMUNICATION_SERVICE_PROFILE`, `QUERY_TRANSFER_SERVICE_PROFILE` (which applies to both SLS and Retrieval Transfer Service Profiles), or `QUERY_SPACE_LINK_EVENTS_PROFILE` operation to query the content of a specified profile on record at CM. This invocation provides a mechanism for validating consistency between UM and CM databases.

The configuration parameters explicitly specified in the `ADD_SPACE_COMMUNICATION_SERVICE_PROFILE` and `QUERY_SPACE_COMMUNICATION_SERVICE_PROFILE` operations, and their allowed ranges of values, are conformant with the CCSDS standards for RF and modulation systems (reference [14]), channel coding (references [4] and [6]), telemetry framing (references [2] and [5]) and the RAF, RCF, and FCLTU SLE transfer

services (references [8], [9], and [11]). However, it is possible for space link service providers to use SCCS-SM even though their services are not conformant with some or all of these CCSDS Recommended Standards. The ASCSP operation supports the submission of Space Communication Service Profiles characterizing other space link carrier configurations, as long as UM and CM agree on the format and content of those bilaterally defined Space Communication Service Profiles by means that are outside the scope of this standard. Similarly, the QSCSP operation allows for UM to query the contents of such bilaterally agreed Space Communication Service Profiles. Similar capabilities are provided by the ASTSP, ARTSP, and QTSP operations for SLE and Retrieval Transfer Service Profiles, and by the ASLEP and QSLEP operations for Space Link Events Profiles.

## 2.2.5 TRAJECTORY PREDICTION SERVICE

### 2.2.5.1 General

The SCCS-SM Trajectory Prediction operations are used to manage the spacecraft trajectory data that are used by CM to compute the data needed to acquire and maintain communication links between the space body and the Complex, such as antenna pointing angles, Doppler compensation offsets, signal-level adjustments, and light-time compensation adjustments.

There are four Trajectory Prediction operations that CM can perform when invoked by UM:

- a) ADD\_TRAJECTORY\_PREDICTION (ATP)—to add a new Trajectory Prediction to the set of Trajectory Predictions that are available at CM;
- b) EXTEND\_TRAJECTORY\_PREDICTION (ETP) —to extend a Trajectory Prediction that is already available at CM by appending a trajectory prediction *segment* for a later time period;
- c) DELETE\_TRAJECTORY\_PREDICTION (DTP)—to delete a Trajectory Prediction that is available at CM (as long as the Trajectory Prediction is not referenced by any Service packages at the time that the DTP is invoked);
- d) QUERY\_TRAJECTORY\_PREDICTION (QTP)—to query the content of a Trajectory Prediction that is available at CM.

There are no Trajectory Prediction operations that are performed by UM.

The ATP, ETP, and QTP operations explicitly support the exchange of Trajectory Predictions that conform to CCSDS orbit data message Recommended Standards (references [13] and [15]). In addition, these operations support the exchange of bilaterally defined Trajectory Predictions, as long as UM and CM agree on the format and content of those bilaterally defined Trajectory Predictions that are by means outside the scope of this Recommended Standard.

NOTE 1 – Submission of trajectory data occurs on the order of months, days, or minutes in advance of the support period to which the trajectory data applies.

NOTE 2 – In addition to using Trajectory Predictions to compute the data needed to acquire and maintain communication links between the space body and the Complex, Trajectory Predictions may also be used during the Service Package scheduling process to confirm mutual visibility between the space body and the antenna of the Complex that will be used to support the Service Package. Agreement to use Trajectory Predictions for scheduling of Service Packages is recorded as part of the Service Agreement.

### 2.2.5.2 Storage Area at CM

There is a limited amount of storage space available at CM for Trajectory Predictions. The maximum allowed storage area is defined in the applicable Service Agreement. CM will reject new Trajectory Predictions once this storage space is exceeded.

There are three modes of Trajectory Prediction (TP) storage management supported by SCCS-SM: *invoked deletion only*, *auto TP deletion*, and *auto segment deletion*.

In the *invoked deletion only* mode of Trajectory Prediction storage management, all trajectory information associated with each Trajectory Prediction is retained by CM until UM explicitly deletes that Trajectory Prediction via the DTP operation. This mode puts complete control of and responsibility for the management of Trajectory Prediction storage on UM.

In the *auto TP deletion* mode, CM discards segments of a Trajectory Prediction as they expire, freeing the storage resources associated with each of those segments. Once all segments of the Trajectory Prediction have expired, the Trajectory Prediction itself is automatically deleted by CM. This mode relieves UM from responsibility for routine management of Trajectory Prediction storage management. However, if UM operates by extending Trajectory Predictions, UM will ensure that it extends each Trajectory Prediction before it expires and is automatically deleted.

In the *auto segment deletion* mode, CM discards segments of a Trajectory Prediction as they expire, freeing the storage resources associated with each of those segments. However, in contrast to the *auto TP deletion* mode, even if all segments of the Trajectory Prediction have expired, CM continues to retain the Trajectory Prediction until the Trajectory Prediction is explicitly deleted by UM via the DTP operation. An example use for this mode is the case of a simple mission that establishes a Trajectory Prediction once at the beginning of the Service Agreement period and extends it with additional Trajectory Prediction segments whenever it is useful, even though the previous Trajectory Prediction segments may have expired.

NOTE – Support for these Trajectory Prediction storage management modes is dependent upon the capabilities of the individual Complex, and only one mode is applicable to (and recorded by) any given Service Agreement.

### 2.2.5.3 Trajectory Prediction Validation

When UM requests the addition of a new Trajectory Prediction or the extension of an existing Trajectory Prediction, the validation performed by CM is limited, i.e., checking of storage space available at CM, consistency of start and stop times, conformance to indicated format, uniqueness of Trajectory Prediction identifier (for the ATP operation), and availability of the referenced Trajectory Prediction (for the ETP operation).

Further locally defined checks may be performed by CM as part of the validation of a Service Package that references the Trajectory Prediction.

Requests for deletion of Trajectory Predictions that are referenced by scheduled Service Packages will be rejected.

To allow UM to keep track of referenced Trajectory Predictions, the QUERY\_-TRAJECTORY\_PREDICTION operation returns the list of scheduled Service Packages that reference the queried Trajectory Prediction.

### 2.2.6 SERVICE AGREEMENT SERVICE

The negotiation and generation of the Service Agreement are beyond the scope of this Recommended Standard. For this reason, there is only one Service Agreement operation that CM can perform when invoked by UM:

QUERY\_SERVICE\_AGREEMENT (QSA)—to query the content of a Service Agreement that is currently available at CM. The QSA operation has been defined to support the return of Service Agreement data either in the format defined in this Recommended Standard or in a bilaterally agreed format.

No Service Agreement operations can be performed by UM.

## 2.3 MAPPING TO W3C XML SCHEMA

The SCCS-SM Recommended Standard may be mapped to multiple concrete representations. However, this Recommended Standard also includes the specification of a mapping to World Wide Web Consortium (W3C) Extensible Markup Language (XML) schema in order to provide at least one interoperable standard. The normative mapping of this Recommended Standard to XML W3C schemas is a virtual annex to this Recommended Standard and is contained in a stand-alone set of schema files (reference [16]).

NOTE – The XML schema has been elaborated on the basis of the mapping guidelines described in reference [G2].

## 2.4 SECURITY ASPECTS OF SCCS MANAGEMENT SERVICES

### 2.4.1 SECURITY BACKGROUND/INTRODUCTION

The SCCS-SM services defined in this Recommended Standard are abstract and in themselves address some of the security concerns. Security of real implementations of the SCCS-SM services also depends on the security features associated the concrete transfer syntax used to represent the abstract data sets defined herein, and/or the security capabilities of the underlying communication service.

At present, an SCCS-SM mapping to World Wide Web Consortium (W3C) XML schema (reference [16]) has been adopted as one transfer syntax for SCCS-SM interactions. For implementations that use this XML mapping, most of the security for the SCCS-SM services will be provided by implementation of XML security standards (references [17], [18], and [19]), which have been developed under the auspices of the W3C and the Organization for the Advancement of Structured Information Standards (OASIS).

NOTE – For the purposes of this description, these XML security standards are assumed to be implemented in middleware that is part of the underlying communication service.

### 2.4.2 STATEMENTS OF SECURITY CONCERNS

#### 2.4.2.1 Introduction

This subsection identifies SCCS-SM service support for capabilities that respond to security concerns in the areas of data privacy, data integrity, authentication, access control, availability of resources, and auditing. The support described herein is predicated on the use of the W3C XML schema mapping for SCCS-SM and the referenced W3C XML security standards.

SCCS-SM operation messages are recommended to be fully encrypted in accordance with the XML Encryption Syntax and Processing recommendation (reference [17]).

#### 2.4.2.2 Data Privacy (Also Known As Confidentiality)

Encryption of a message prevents anyone but the intended receiver from being able to read the message.

#### 2.4.2.3 Data Integrity

Encryption of a message prevents a third party from tampering with the content of a message in a way that would be undetected by the receiver.

#### 2.4.2.4 Authentication

Signature authentication of a message prevents a third party from masquerading as another (legitimate) correspondent. Signature authentication is provided by the referenced XML security standards.

#### 2.4.2.5 Access Control

Access control is inherent in all SCCS-SM services, regardless of the concrete transfer syntax used. The ability to add, update, or view service management information for a given spaceflight mission is restricted to a specified list of UM entity names that are specified in the Service Agreement for that mission. Every SM message set contains the UM entity name of the sender as the `smSource` of the message set, and the `smSource` is authenticated by the receiver of the message before it is accepted.

SCCS-SM also provides an optional capability to permit only one UM entity to replace or delete an individual Service Package, Space Communication Service Profile, SLS Transfer Service Profile, Retrieval Transfer Service Profile, Space Link Events Profile, or Trajectory Prediction, through enforcement of *ownership* of each such information entity.

#### 2.4.2.6 Availability of Resources

The SCCS-SM services are provided via communication networks that have some limit to the resources available to support those SCCS-SM services. If these resources can be diverted from their support of the SCCS-SM services (in what is commonly known as ‘denial of service’) then the performance of the SCCS-SM services may be curtailed or inhibited.

This SCCS-SM Recommended Standard does not define explicit capabilities to prevent denial of service. Resource availability is expected to be ensured by appropriate capabilities in the underlying communication service. The specific capabilities will be dependent upon the technologies used in the underlying communication service and the security environment in which the UM and CM operate.

#### 2.4.2.7 Auditing

This SCCS-SM Recommended Standard does not define explicit security auditing requirements or capabilities. Security auditing, if required, is expected to be negotiated and implemented bilaterally between the spaceflight mission and the service provider.

### 2.4.3 POTENTIAL THREATS AND ATTACK SCENARIOS

The SCCS-SM services do not carry communications that originate or terminate at the spacecraft, so compromise of the SCCS-SM services does not allow an attacker to directly attack the spacecraft. Rather, the threat is one of denial of service.

Without the appropriate security measures, attackers may masquerade as legitimate users to:

- a) delete in-place configuration profiles or Trajectory Predictions that the legitimate users expect to be in place when they attempt to create Service Packages that reference those entities;
- b) intercept, modify, and reissue a **CreateServicePackageInvocation** such that the resulting invocation is unschedulable or creates a Service Package that is unusable by the MDOS;
- c) replace or delete existing Service Packages;
- d) cause the creation of bogus Service Packages that tie up resources that are needed by spaceflight missions;
- e) cause switches to alternate scenarios that are not consistent with reality, causing loss of space link sessions (e.g., switching to a launch slip scenario when the launch actually occurs on time).

#### **2.4.4 CONSEQUENCES OF NOT APPLYING SECURITY**

The consequence of not applying security to the SCCS-SM services is possible denial of service. Denial of service can result in degraded mission performance, increased operations costs, and even loss of mission if service is denied during a critical mission phase.



### 3 SERVICE MANAGEMENT DOCUMENT EXCHANGE

#### 3.1 GENERAL

SCCS-SM operations are realized through the execution of procedures that involve the exchange of messages that are contained within *SM message sets*. All exchanges of SM messages conform to an exchange protocol that ensures that

- a) operations are invoked only by entities that are authorized within the scope of a given Service Agreement;
- b) message sets are validated as properly formatted SM message sets;
- c) message sets that are not properly formatted are handled in a context-appropriate manner; and
- d) messages contained within SM message sets are processed in the proper sequence.

Under certain circumstances (as described in sections below), receipt of invalid SM message sets results in *SM exception responses* being sent back to the sender of the message set. The exchange protocol specifies the form and content of the exception responses. Collectively, the SM message sets and SM exception responses are known as *SM documents*, and the SCCS-standard protocol by which SM documents are exchanged is called the *SM document exchange protocol*.

The SM document exchange protocol operates across a communication service connecting UM and CM. Because SCCS-SM is intended to operate using a variety of transport technologies (e.g., email, HyperText Transfer Protocol (HTTP)—reference [G3], Simple Object Access Protocol (SOAP)—reference [G4]), the details of the establishment and maintenance of the communication service are specific to transport technology used. However, all underlying communication services perform a minimum set of functions in order to support the proper operation of the SM document exchange protocol. In a bilateral agreement, a UM and a CM select a communication service that performs the required functions; this Recommended Standard does not cover such arrangements.

Figure 3-1 illustrates the relationship between the underlying communication service, SM document exchange protocol, SM message type, and SM operation procedures.

Subsection 3.2 describes the functions of the underlying communication service. Subsection 3.3 defines the SM document exchange protocol. Subsection 3.4 defines the SM operation procedure patterns. Each SM operation procedure uses one of three *operation procedure patterns*: *two-phase operation*, *three-phase operation*, or *notify operation*, which are specified in 3.4.1, 3.4.2, and 3.4.3, respectively. These operation procedure patterns employ combinations of the SM message types (invocation, return, notification, and confirmation) to exchange the information in support of the procedures.

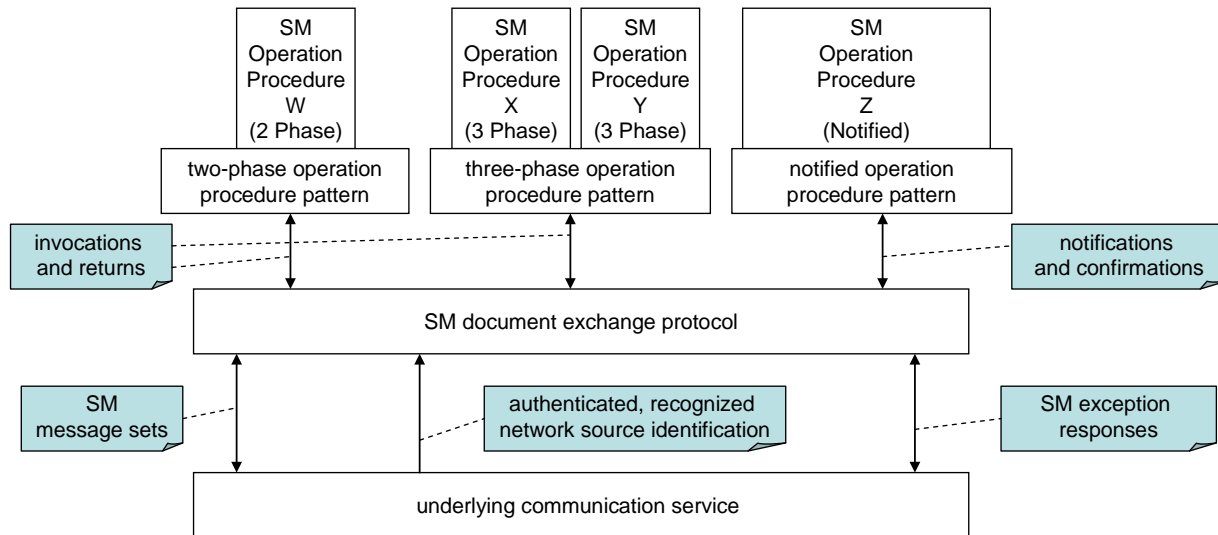

**Figure 3-1: Relationship among SCCS-SM Operation Procedures, Document Exchange Protocol, and Underlying Communication Service**

## 3.2 UNDERLYING COMMUNICATION SERVICE

### 3.2.1 GENERAL

The underlying communication service is used to exchange SM documents among SCCS-SM entities. The underlying communication service maintains the relationship among each SCCS-SM application entity and the identification of the ports through which it communicates with other SCCS-SM entities. The underlying communication service establishes and maintains the communication association between each pair of SM entities.

This Recommended Standard does not levy requirements for privacy and integrity of service management information. If such requirements exist for an implementation, supporting capabilities would also be expected to be provided by the underlying communication service, but such capabilities are outside the scope of this Recommended Standard.

The preservation of sequencing among messages transmitted at different times is **not** assumed to be a characteristic of the underlying communication service. As defined in 3.3, the SM document exchange protocol provides a capability to preserve required sequencing among multiple SM invocation messages sent concurrently by allowing those invocation messages to be sent within the same document. This same-document sequencing capability is sufficient to meet the requirements of the SM document exchange protocol and the operational procedures that use it, as specified herein. However, the SM document exchange protocol does not guarantee that messages in two different documents will be received in the order that those messages were originally generated. If a real operational environment in which SCCS-SM is applied has requirements that sequencing be preserved among messages across multiple documents transmitted at different times, then sequence preservation would

be expected to be provided by the underlying communication service, but any such sequence preservation requirements are outside the scope of this Recommended Standard.

### 3.2.2 REQUIREMENTS FOR THE UNDERLYING COMMUNICATION SERVICE

Table 3-1 lists the requirements that the Document Exchange Protocol places on the underlying communication service.

**Table 3-1: Requirements for the Underlying Communication Service**

UCS-0001	The underlying communication service shall be reliable – that is, the underlying communication service must ensure that every document sent from a communication entity is actually delivered to the destination communication entity.
UCS-0002	The underlying communication service shall authenticate the <i>Network Source</i> of each document carried by the service and validate that the Network Source is permitted to send documents to the <i>Network Destination</i> . NOTES 1 As used in this Recommended Standard, Network Source and Network Destination refer to the SM entities as they are known to the underlying communication service. 2 The format of the identification of the Network Source and Network Destination within the underlying communication technology is dependent upon that technology. 3 References [17], [18], and [19] specify the security mechanisms for authentication, data privacy, and data integrity that are recommended for use when the SCCS-SM documents are encoded as XML documents.
UCS-0003	Documents for which the Network Source cannot be authenticated and recognized shall be discarded by the communication service. NOTE – There is no requirement on the underlying communication service to notify the Network Source when a document is dropped because of failure to authenticate the Network Source or recognize it on behalf of the intended Network Destination. Only when the underlying communication service authenticates the Network Source and recognizes it as a legitimate Network Source for the intended Network Destination does it deliver the document to the Network Destination.
UPS-0004	The underlying communication service shall supply the authenticated identity of the Network Source of the document to the SM document exchange protocol. NOTE – As specified in 3.3 the SM document exchange protocol uses that authenticated identity for the purposes of (a) verifying the authority of the SM entity located at the Network Source to issue documents in the context of the Service Agreement that is identified in the message, and (b) allowing the document exchange protocol and the SCCS-SM applications that use it to know where to send responses, if necessary.
MPS-0005	The underlying communication service shall provide the ability for an SM entity to send documents to two logically separate ports on a peer SM entity. These logically separate ports, the <i>SM message set port</i> and the <i>SM exception response port</i> , are used by the document exchange protocol to separate SM operation message traffic from protocol exception reporting traffic.

Figure 3-2 illustrates the exchange of message sets and exception responses between the port pairs of the Sender and Receiver, where in this particular example UM is the Sender and CM is the Receiver.

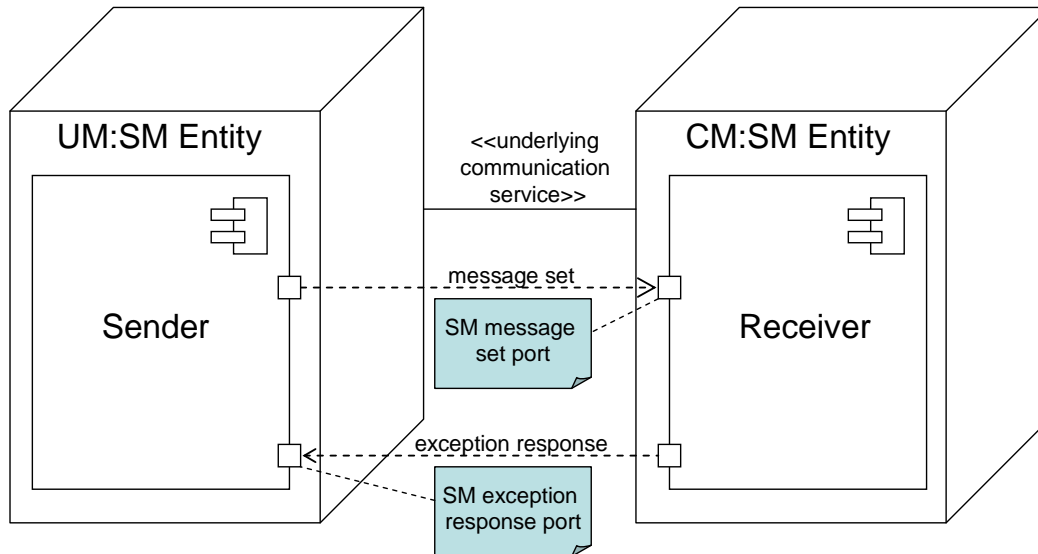

**Figure 3-2: Exchange of SM Documents via Message Set and Exception Response Ports**

NOTE – The realization of the separate logical ports is dependent on the technology used by the communication service. For example, it could be multiple SOAP endpoints, multiple Transmission Control Protocol (TCP) (reference [G5]) sockets, multiple uniform resource locators (URLs), or the use of different Subject lines in email messages.

### 3.3 SM DOCUMENT EXCHANGE PROTOCOL

#### 3.3.1 GENERAL

In order to ensure that related messages are transferred across the SM interface with their intended sequencing preserved regardless of the underlying communication service, the SM document exchange protocol is used to exchange SM documents between SM entities (i.e., UM and CM). There are two major categories of SM documents: the *message set* and the *exception response*.

The SM document exchange protocol is described in terms of transmitting an SM message set from a Sender to a Receiver, and (upon occurrence of certain exception conditions) the Receiver sending one or more exception responses back to the Sender.

The execution of the SM document exchange protocol begins with a Sender generating an **SmMessageSet** containing one or more SM messages, and sending the message set to the SM message set port of the intended Receiver. A message set contains operation invocation, return, notification, or confirmation messages. In the case of invocations, multiple invocations may be contained within a single message set (hence the *set*) in order to preserve the sequential ordering among related invocation messages that are intended to be processed by the receiver in a specific order (e.g., a new Space Communication Service Profile is

desired to be processed before any Service Packages can reference it), even though the underlying delivery mechanism does not guarantee sequence preservation. Message sets are exchanged between communicating SM entities via the SM message set ports of those entities.

Upon receipt of a document via the Receiver's SM message set port, the Receiver performs several validation steps: syntactic validation, authorization validation, enforcement of sequencing of invocation messages within the message set (for message sets containing invocation messages), and verification of support for the invoked operation.

NOTE 1 – As described in 3.2, the SM document exchange protocol relies on the underlying communication service to authenticate the identity of the Network Source of the message carried by the SM document exchange protocol, and to supply the identity of the Network Source of the message to the SM document exchange protocol.

NOTE 2 – Because the format of the identification of the Network Source used by the underlying communication service is technology dependent, the mapping between that identification and the `smSource` is also technology dependent.

NOTE 3 – The Receiver does not perform message sequence number checking for any type of message other than invocations.

An exception response is generated in response to a document that is received as a purported message set but which cannot be interpreted as a valid and authentic message set, or in response to an invocation or notification message contained in a message set that cannot be submitted to the target service management operation. Exception responses of the first kind are **UnrecognizedMessageSetResponses**; those of the second kind are **InvalidInvocationResponses** and **InvalidNotificationResponses**, respectively. Exception responses are exchanged between communicating SM entities via the SM exception response ports of those entities.

NOTE 4 – An operation return or confirmation can only be legitimately sent in response to an invocation or notification (respectively), so that if a Receiver receives a return or confirmation that it could not have possibly sent because it is for an operation that the Receiver does not support, it is an indication of a serious protocol breakdown. In such cases the association between the Receiver and the Sender is completely unreliable and should not be used even to transmit an **InvalidInvocationResponse** or **InvalidNotificationResponse**.

If the Sender sent a message set that was unrecognizable to the Receiver or that contained messages that were invalid to the Receiver, the Sender receives one or more exception responses (**UnrecognizedMessageSetResponse**, **InvalidInvocationResponse**, or **InvalidNotificationResponse**) from the Receiver via the Sender's exception response port.

NOTE 5 – 'Sender' herein always refers to the transmitter of the original message set, and *not* to the transmitter of the exception response(s) (which is the Receiver).

Upon receipt of a document at the Sender's exception response port, the Sender performs syntactic validation and (for an **InvalidInvocationResponse** or **InvalidNotificationResponse**) authorization validation.

Operation-level processes external to the document exchange protocol use the diagnostic information contained in the **UnrecognizedMessageSetResponse**, **InvalidInvocationResponse**, and **InvalidNotificationResponse** messages to modify the local state of the affected operations and possibly take other actions. The nature of these other actions is determined by the operation, the message, and/or the role of the Sender in the operation, and are defined in further detail in the procedure patterns in 3.4 and the operation specifications in sections 4 through 7.

### 3.3.2 SEQUENCE DIAGRAMS

The message set is the primary unit of exchange for the document exchange protocol. Figure 3-3 is the sequence diagram for the SM Document Exchange Protocol. At the document exchange protocol level, SM operation messages are unrelated. For example, the SM document exchange protocol does not associate operation returns with the invocations that trigger them. Such associations among messages exist within the operation procedures, the patterns for which are defined in 3.4 and the concrete instantiations of which are defined in sections 4 through 7. The SM Document Exchange Protocol sequence diagram is a parameterized, reusable diagram.

Whereas the message set is the unit of interest from the perspective of the document exchange protocol, it is the individual messages that are contained within a message set that are important to the SM operations themselves. Figure 3-4 is the sequence diagram for the transmission of a single SM message within a message set. As can be seen, the Send Message sequence diagram uses the SM Document Exchange Protocol sequence diagram of figure 3-3. The SM Send Message sequence diagram is in turn parameterized and reusable, and serves as a component of sequence diagrams for the procedure patterns defined in 3.4.

### 3.3.3 ACTIVITY DIAGRAM

Figure 3-5 is the activity group diagram for the SM Document Exchange Protocol. The Document Exchange Protocol activity group incorporates two lower-level activity groups, Receive and Validate SM Message Set (figure 3-6) and Receive and Validate SM Exception Response (figure 3-7). The SM Document Exchange Protocol activity group is a component of the activity diagrams for the procedure patterns defined in 3.4.

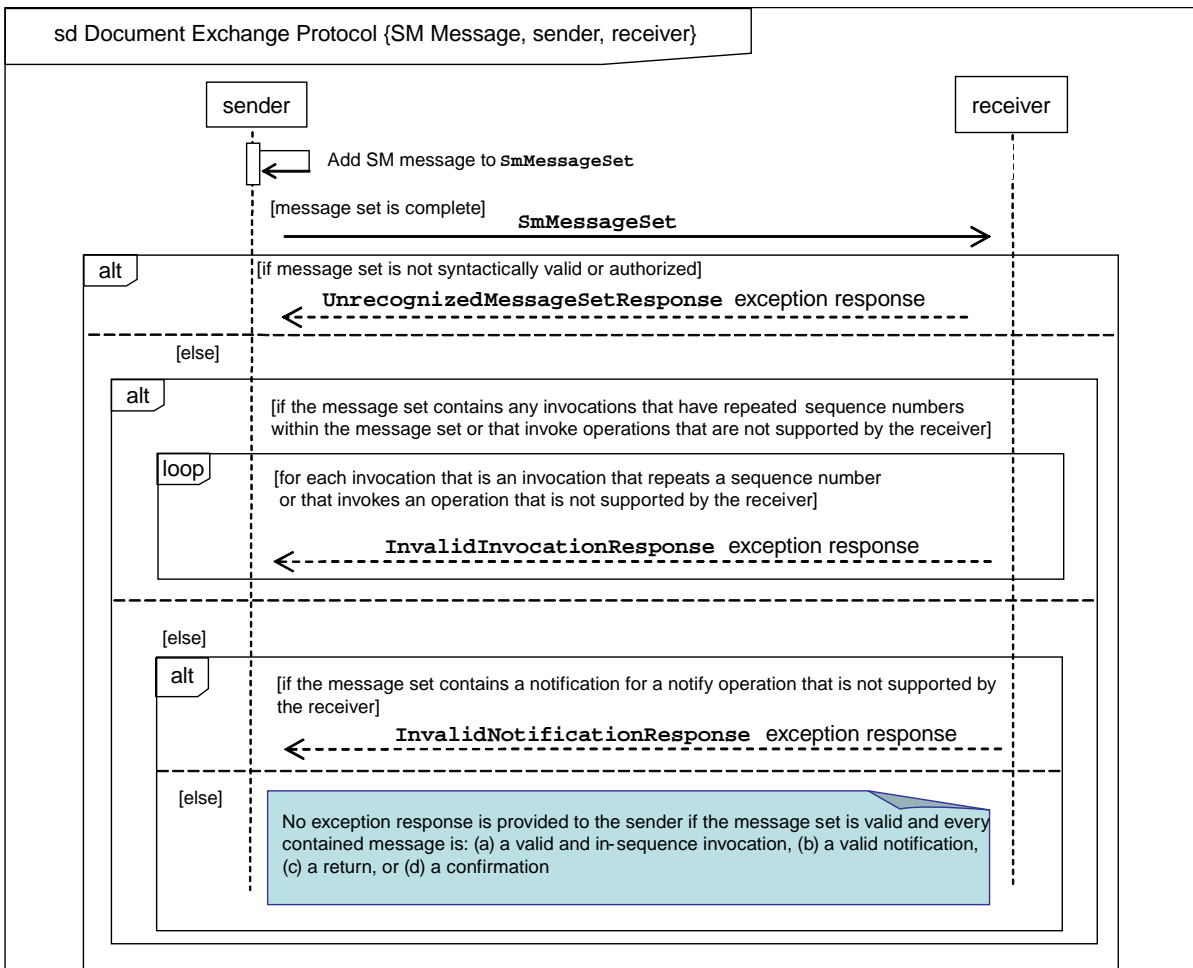

Figure 3-3: SM Document Exchange Protocol Sequence Diagram

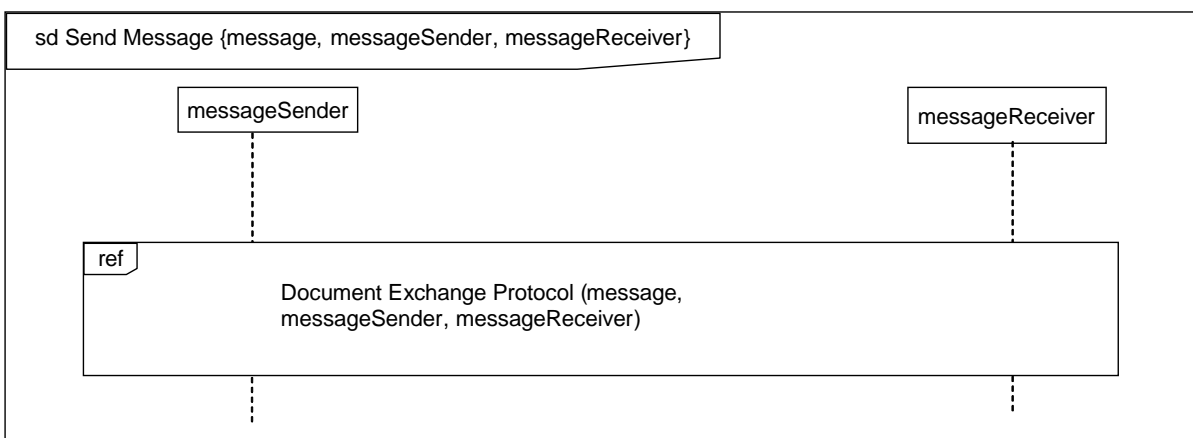

Figure 3-4: SM Send Message Sequence Diagram

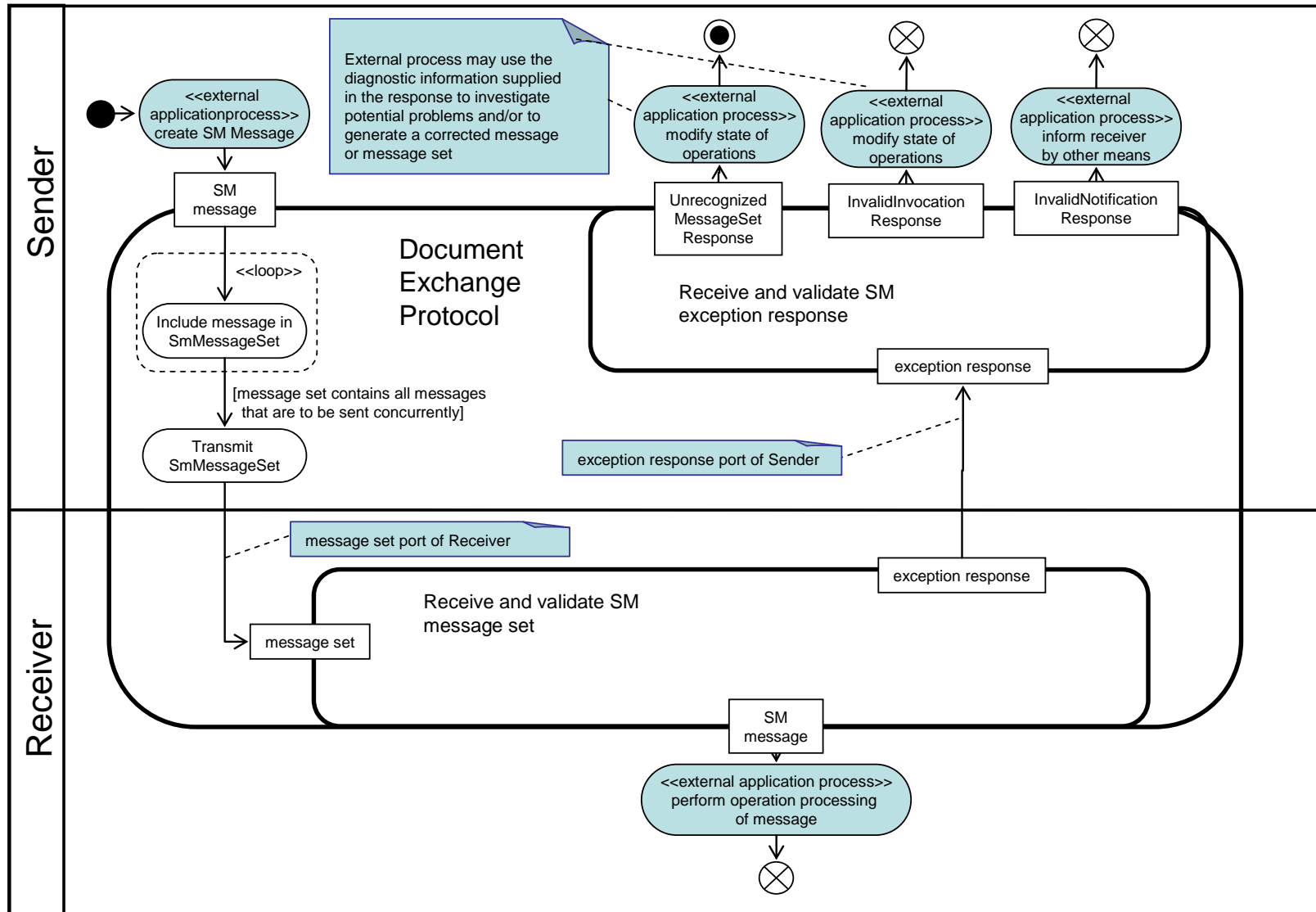

Figure 3-5: SM Document Exchange Protocol Activity Diagram



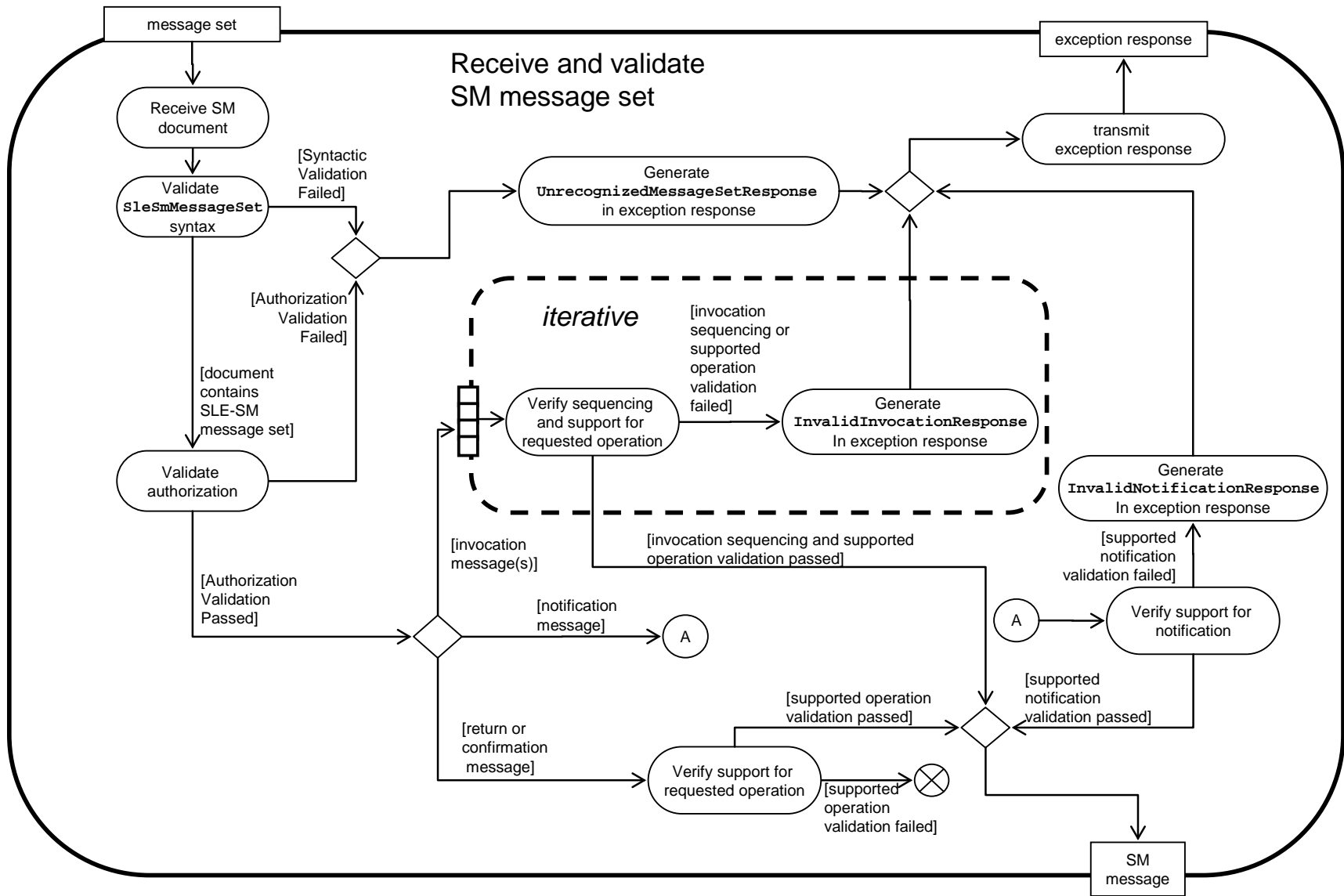

Figure 3-6: Receive and Validate SM Message Set Activity Group Diagram

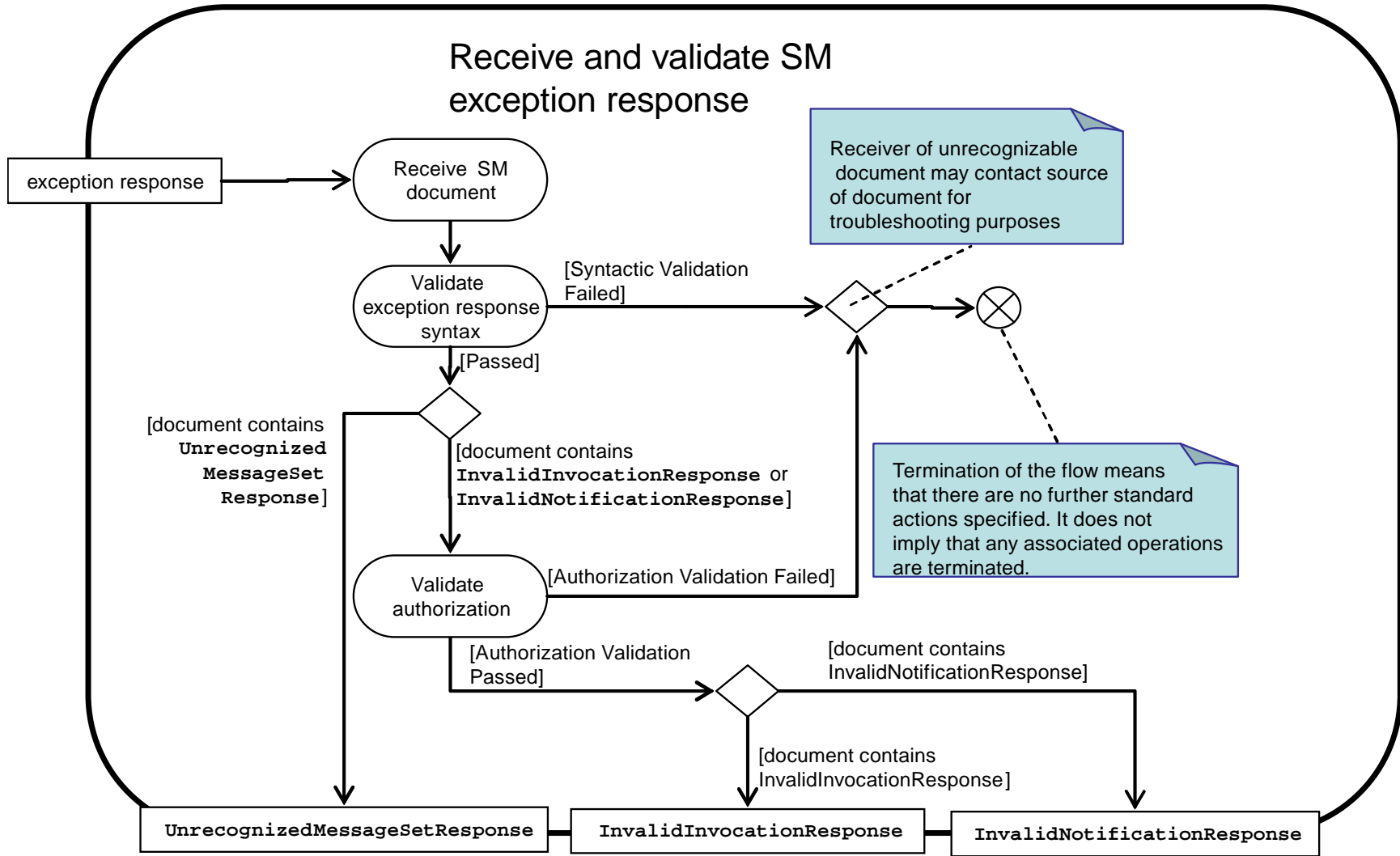

Figure 3-7: Receive and Validate SM Exception Response Activity Group Diagram

### 3.3.4 REQUIREMENTS

#### 3.3.4.1 Sender Requirements for the SM Document Exchange Protocol

The SM Document Exchange Protocol requirements on the Sender are defined in table 3-2.

**Table 3-2: Sender Requirements for the SM Document Exchange Protocol**

MPS-0001	The Sender shall format the SM message set in accordance with the Data Set Composition and Relationship Requirements for SM Message Sets (table 3-5) when creating an SM message set.
MPS-0002	The Sender shall use only SM entity names for which it is authorized in the <code>smSource</code> parameter (table 3-4) of the <code>SmMessageSet</code> .
MPS-0003	The Sender shall use only <code>smSource</code> values that are authorized in the context of the referenced Service Agreement (that is, that named by the <code>serviceAgreementRef</code> (table 3-4)).
MPS-0004	The Sender shall send messages only for those operations that are permitted under the referenced Service Agreement.
MPS-0005	The Sender shall increment the <code>messageSequenceNumber</code> values of invocation, return, notification, and confirmation messages such that each message shall have a unique message sequence number with respect to the same <code>smSource</code> and <code>serviceAgreementRef</code> .
MPS-0006	The Sender shall order the <code>messageSequenceNumber</code> values of invocation messages in the order in which the invocations are to be processed by the Receiver (that is, lower numbers are to be processed before higher numbers), with respect to the same <code>smSource</code> and <code>serviceAgreementRef</code> . NOTE – Receiver processing of invocations in <code>messageSequenceNumber</code> order is guaranteed only among invocations within the same message set.
MPS-0007	The Sender shall order the <code>messageSequenceNumber</code> values of return, notification, and confirmation messages in the order in which the invocations are sent, with respect to the same <code>smSource</code> and <code>serviceAgreementRef</code> .
MPS-0008	The Sender shall validate that any document received on the exception response port conforms to all syntactic validation requirements specified in table 3-28, Data Set Composition and Relationship Requirements for <code>SmExceptionResponses</code> . If the document fails to be syntactically validated as an <code>SmExceptionResponse</code> , the Sender shall discard the document. The Sender is not required to further interpret or act upon the syntactically invalid document. [syntactic validation]
MPS-0008	For each syntactically valid <code>InvalidInvocationResponse</code> or <code>InvalidNotificationResponse</code> received on the exception response port, the Sender shall validate that: <ul style="list-style-type: none"> <li>a) the <code>smSource</code> (table 3-4) is known to the Sender as an allowed source of SM documents;</li> <li>b) the <code>serviceAgreementRef</code> (table 3-4) references a Service Agreement that is supported by the Sender;</li> <li>c) the <code>smSource</code> is authorized in the context of the referenced Service Agreement; and</li> <li>d) the <code>smDestination</code> (table 3-4) is authorized in the context of the referenced Service Agreement.</li> </ul> If the exception response fails any of these validations, the Sender shall deem the <code>InvalidInvocationResponse/InvalidNotificationResponse</code> to be invalid. The Sender is not required to further interpret or act upon the invalid <code>InvalidInvocationResponse/InvalidNotificationResponse</code> . [Authorization validation]

### 3.3.4.2 Receiver Requirements for the SM Document Exchange Protocol

The SM Document Exchange Protocol requirements on the Receiver are defined in table 3-3.

**Table 3-3: Receiver Requirements for the SM Document Exchange Protocol**

MPR-0001	The Receiver shall validate that any document received on the message set port conforms to all <b>SmMessageSet</b> syntactic validation requirements specified in table 3-5, Data Set Composition and Relationship Requirements for <b>SmMessageSet</b> Documents). If the document fails any of the syntactic requirements, the Receiver shall deem the document to be invalid, discard the document, and send an <b>UnrecognizedMessageSetResponse</b> to the exception response port of the Sender. The Receiver is not required to further interpret or act upon the invalid document. [syntactic validation]
MPR-0002	If the <code>smSource</code> (table 3-4) is not known to the Receiver as an allowed source of SM message sets, the Receiver shall deem the message set to be invalid, discard the message set, and send an <b>UnrecognizedMessageSetResponse</b> to the exception response port of the Sender. The Receiver is not required to further interpret or act upon the invalid message set. [Authorization validation]
MPR-0003	If the <code>serviceAgreementRef</code> (table 3-4) references a Service Agreement that is not supported by the Receiver, the Receiver shall deem the message set to be invalid, discard the message set, and send an <b>UnrecognizedMessageSetResponse</b> to the exception response port of the Sender. The Receiver is not required to further interpret or act upon the invalid message set. [Authorization validation]
MPR-0004	If the <code>smSource</code> is not authorized in the context of the referenced Service Agreement, the Receiver shall deem the message set to be invalid, discard the message set, and send an <b>UnrecognizedMessageSetResponse</b> to the exception response port of the Sender. The Receiver is not required to further interpret or act upon the invalid message set. [Authorization validation]
MPR-0005	If the communication-service-provided Network Source identification associated with the Message Set is not authorized to send Message Sets using the <code>smSource</code> in the context of the referenced Service Agreement, the Receiver shall deem the message set to be invalid, discard the message set, and send an <b>UnrecognizedMessageSetResponse</b> to the exception response port of the Sender. The Receiver is not required to further interpret or act upon the invalid message set. [Authorization validation]
MPR-0006	If the <code>smDestination</code> (table 3-4) is not authorized in the context of the referenced Service Agreement, the Receiver shall deem the message set to be invalid, discard the message set, and send an <b>UnrecognizedMessageSetResponse</b> to the exception response port of the Sender. The Receiver is not required to further interpret or act upon the invalid message set. [Authorization validation]
MPR-0007	If the <code>messageSequenceNumbers</code> of two or more invocation messages in a message set are the same, the Receiver shall deem the same-numbered messages that appear after the first such instance to be invalid, and for each such invalid message shall send an <b>InvalidInvocationResponse</b> (3.3.5.4) to the exception response port of the Sender. The Receiver is not required to further interpret or act upon the invalid invocation message. [Sequence validation]

MPR-0008	If an invocation message is received for an operation that is not supported under the referenced Service Agreement, the Receiver shall send an <b>InvalidInvocationResponse</b> to the exception response port of the Sender. The Receiver is not required to further interpret or act upon the invalid message. [Supported operation validation]
MPR-0009	If a notification message is received that is not supported under the referenced Service Agreement, the Receiver shall send an <b>InvalidNotificationResponse</b> to the exception response port of the Sender. The Receiver is not required to further interpret or act upon the invalid message. [Supported operation validation]
MPR-0010	If a return or confirmation message is received for an operation/notification that is not supported under the referenced Service Agreement, the Receiver shall deem the message invalid. The Receiver is not required to further interpret or act upon the invalid message. [Supported operation validation]
MPR-0011	The Receiver shall process multiple invocation messages in a message set in <code>messageSequenceNumber</code> order. NOTE – The Receiver is not required to follow <code>messageSequenceNumber</code> ordering in the processing of invocations from different message sets.
MPR-0012	The Receiver shall increment the <code>messageSequenceNumber</code> values of <b>InvalidInvocationResponses</b> and <b>InvalidNotificationResponses</b> in the order that the messages are sent, with respect to the same <code>smSource</code> and <code>serviceAgreementRef</code> .
MPR-0013	The Receiver shall use only SM entity names for which it is authorized in the <code>smSource</code> parameter (table 3-4) of <b>InvalidInvocationResponses</b> and <b>InvalidNotificationResponses</b> .

NOTE – The SM Document Exchange Protocol supports the recognition of an `smSource` at two levels: first, whether the `smSource` is recognized as a valid source under *any* Service Agreement supported by the Complex (MPR-0002), and second, whether the `smSource` is recognized as a valid source under the specific Service Agreement (MPR-0004). Some real implementations may be designed so that MPR-0002 must be performed as a precursor to MPR-0004, while others may only perform MPR-0004. Either validation approach (MPR-0002 followed by MPR-0004, or MPR-0004 only) satisfies the requirements of the SM Document Exchange Protocol.

### 3.3.5 SM DOCUMENTS

#### 3.3.5.1 General

The abstract **SmDocument** data set is the basis for all documents that are exchanged between UM and CM via the SM document exchange protocol. There are two concrete data sets that inherit the parameters of the **SmDocument** data set, the **SmMessageSet** data set and the **SmExceptionResponse** data set. The **SmMessageSet** data set is specified in 3.3.5.2, and its messages are specified in 3.3.5.3. The **SmExceptionResponse** data set is specified in 3.3.5.4.

3.3.5.2 SmMessageSet

3.3.5.2.1 General

The class diagram for the **SmMessageSet** message structure is shown in figure 3-8.

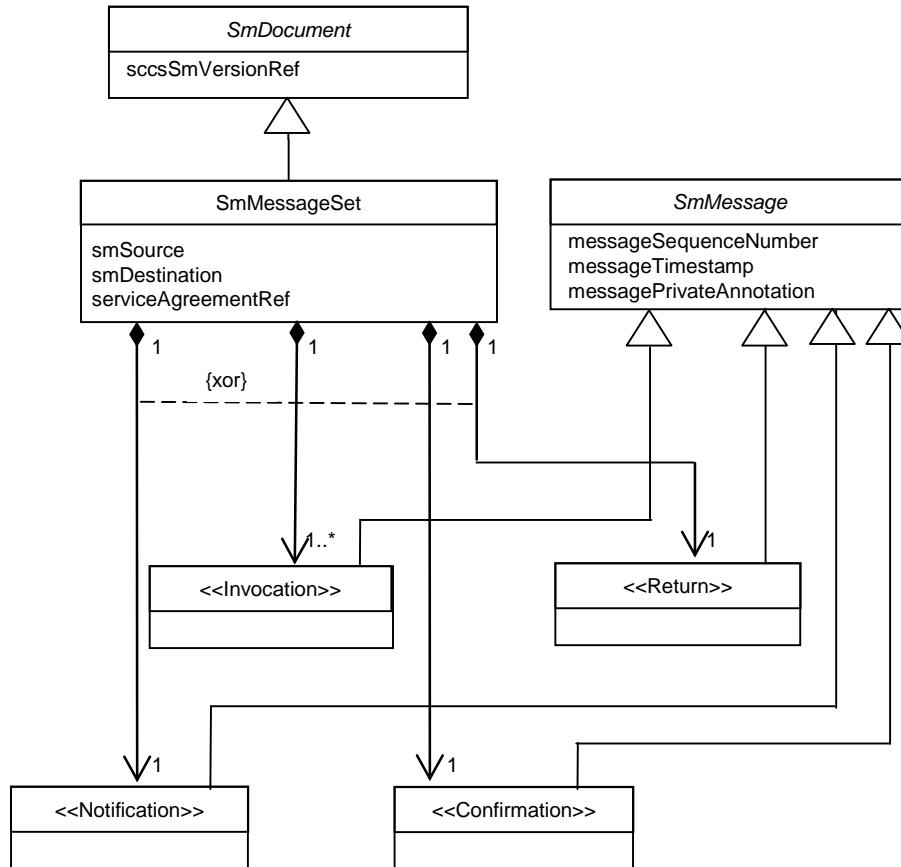

Figure 3-8: SmMessageSet Class Diagram

3.3.5.2.2 Parameters

The **SmMessageSet** data set is defined in table 3-4.

Table 3-4: SmMessageSet Data Set

Parameter Name	Parameter Definition/Description	Data Type	Units
serviceAgreementRef	The identification of the Service Agreement under which all operations referenced in the messages contained within the message set are to be carried out.	String256	n/a
smSource	The logical or functional name of the SM entity that is the source (generator) of the message set. All messages in the <b>SmMessageSet</b> must have the same smSource.	String256	n/a

Parameter Name	Parameter Definition/Description	Data Type	Units
smDestination	The logical or functional name of the SM entity that is the destination of the message set. All messages in the <b>SmMessageSet</b> must have the same smDestination.	String256	n/a
sccsSmVersionRef	The version of the SCCS-SM Service Recommended Standard to which the format and semantics of this SCCS-SM document conform.	String256	n/a

### 3.3.5.2.3 Data Set Composition and Relationship Requirements

Table 3-5 defines the data set composition and relationship requirements for the **SmMessageSet** messages.

**Table 3-5: Data Set Composition and Relationship Requirements for SmMessageSet Documents**

MSD-0001	An <b>SmMessageSet</b> document shall contain an unambiguous sccsSmVersionRef parameter. [syntactic validation]
MSD-0002	The sccsSmVersionRef parameter shall have the value of '1.0.0'. [syntactic validation]
MSD-0003	An <b>SmMessageSet</b> document shall contain the smSource, smDestination, and serviceAgreementRef parameters defined in table 3-4. [syntactic validation]
MSD-0004	An <b>SmMessageSet</b> document shall contain exclusively: <ul style="list-style-type: none"> <li>a) one or more Invocation messages;</li> <li>b) one Return message;</li> <li>c) one Notification message; or</li> <li>d) one Confirmation message.</li> </ul> [syntactic validation]
MSD-0005	Each Invocation message contained in an <b>SmMessageSet</b> document shall conform to the syntactic data set composition and relationship requirements for that message type, as specified in 3.3.5.3.2. [syntactic validation]
MSD-0006	The Return message contained in an <b>SmMessageSet</b> document shall conform to the syntactic data set composition and relationship requirements for that message type, as specified in 3.3.5.3.3. [syntactic validation]
MSD-0007	The Notification message contained in an <b>SmMessageSet</b> document shall conform to the syntactic data set composition and relationship requirements for that message type, as specified in 3.3.5.3.4. [syntactic validation]
MSD-0008	The Confirmation message contained in an <b>SmMessageSet</b> document shall conform to the syntactic data set composition and relationship requirements for that message type, as specified in 3.3.5.3.5. [syntactic validation]

### 3.3.5.3 SM Message Set Messages

#### 3.3.5.3.1 General

There are four generic SM message types: invocation, return, notification, and confirmation. Concrete versions of these generic message types are defined for the SM operations defined for the specific operations in sections 4 through 7, as appropriate. However, to the extent that each of these generic types can be categorized in terms of use, behavior, and parameters, the common characteristics are defined later in this section.

The invocation, return, notification, and confirmation message types are represented in figure 3-8 by their stereotypes (<<Invocation>>, <<Return>>, <<Notification>>, and <<Confirmation>>, respectively). Each of these stereotypes is characterized by parameters and data set composition and relationship requirements that are common to all real instances of that stereotype. These common parameters and composition rules are defined below in this section. In addition, the real instances of each of the stereotypical message types have additional parameters and composition rules that are specific to the use-case operations that the messages support. Those operation-specific parameters and composition rules are defined as part of the specific service operation definitions.

All SM messages share (inherit) the parameters of the abstract *SmMessage* data set, as illustrated in figure 3-8.

The specifications of the SM message stereotypes are provided in the subsections listed below:

- <<Invocation>>: subsection 3.3.5.3.2;
- <<SuccessfulReturn>>: subsection 3.3.5.3.3.2;
- <<FailedReturn>>: subsection 3.3.5.3.3.3;
- <<FailedReturnWithDenial>>: subsection 3.3.5.3.3.4;
- <<AcknowledgedReturn>>: subsection 3.3.5.3.3.5;
- <<Notification>>: subsection 3.3.5.3.4;
- <<Confirmation>>: subsection 3.3.5.3.5.

#### 3.3.5.3.2 <<Invocation>> Message Stereotype

##### 3.3.5.3.2.1 General

Invocation messages are used to invoke SM operations. All SM invocation messages conform to the SM <<Invocation>> message stereotype.



The class diagram for the <<Invocation>> message stereotype structure is shown in figure 3-9.

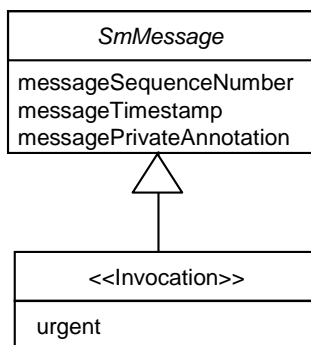

**Figure 3-9: <<Invocation>> Message Stereotype Class Diagram**

Besides having the parameters common to all SM messages, invocations all carry the `urgent` parameter. The `urgent` parameter is used to indicate the timeframe in which the invoked operation must be performed (see 3.1 and 3.4.2). The value of the `urgent` parameter is also used to trigger operation-specific actions for some service management operations. Operation-specific requirements that are associated with the value of `urgent` are specified in the sections of this Recommended Standard that define those operations.

### 3.3.5.3.2.2 Parameters

The constituent data set of the <<Invocation>> stereotype is defined in table 3-6.

**Table 3-6: <<Invocation>> Message Stereotype Data Set**

Parameter Name	Parameter Definition/Description	Data Type	Units
messagePrivateAnnotation	A text field that is available to carry non-standard, bilaterally agreed data between Sender and Receiver.	String or NULL	n/a
messageSequenceNumber	The sequence number of this message. It is used to ascertain the relative sequencing among messages.	Positive Integer	n/a
messageTimestamp	The time at which the message is created.	UTC*	n/a
urgent	Specifies the whether the invoked operation must be performed with urgency or not, which in turn defines the timeframe in which the invoked operation is to be performed: <ul style="list-style-type: none"> <li>– ‘true’—the operation shall be performed within the period specified by the urgent timeout parameter for that operation;</li> <li>– ‘false’—the operation shall be performed within the period specified by the routine timeout parameter for that operation.</li> </ul> NOTE – The value of this parameter may also have additional significance that is specific to the individual operation.	Boolean	n/a

\* Coordinated universal time.

### 3.3.5.3.2.3 Data Set Composition and Relationship Requirements

Table 3-7 defines the data set composition and relationship requirements common to all SM Invocation messages.

**Table 3-7: Data Set Composition and Relationship Requirements for All Invocation Messages**

GID-0001	An invocation message shall contain the <<Invocation>> Message Stereotype parameters specified in table 3-6. [syntactic validation]
GID-0002	If there is no private annotation information, the messagePrivateAnnotation parameter shall have null content.

### 3.3.5.3.3 <<Return>> Message Stereotypes

#### 3.3.5.3.3.1 General

Return messages are used to convey the results of SM operations. There are three types of SM return messages: successful, failed, and acknowledged. The specifications of stereotypes for the successful and acknowledged returns, as well as two specialized stereotypes for the failed return message, are provided in the subsections listed below:

- <<SuccessfulReturn>> message stereotype (see 3.3.5.3.3.2);
- <<FailedReturn>> message stereotype (see 3.3.5.3.3.3);
- <<FailedReturnWithDenial>> message stereotype (see 3.3.5.3.3.4);
- <<AcknowledgedReturn>> message stereotype (see 3.3.5.3.3.5).

All SM return messages inherit the parameters of the <<Return>> stereotype, which in turn inherits the parameters of the abstract **Message** data set. The <<Return>> stereotype is illustrated in figure 3-10.

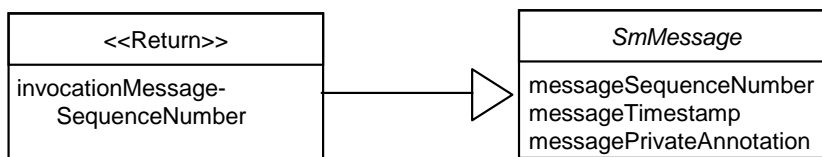

**Figure 3-10: <<Return>> Message Stereotype Class Diagram**

#### 3.3.5.3.3.2 <<SuccessfulReturn>> Message Stereotype

##### 3.3.5.3.3.2.1 General

SuccessfulReturn (SR) messages are used to inform the invoker that the operation has succeeded. Depending upon the operation, a Successful Return message may also convey additional information related to the performance of that operation.

The class diagram for the <<SuccessfulReturn>> message stereotype structure is shown in figure 3-11.

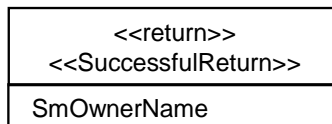

**Figure 3-11: <<SuccessfulReturn>> Message Stereotype Class Diagram**

### 3.3.5.3.3.2.2 Parameters

Table 3-8 defines the parameters that are common to all SM Successful Return messages.

**Table 3-8: <<SuccessfulReturn>> Message Stereotype Data Set**

Parameter Name	Parameter Definition/Description	Data Type	Units
invocationMessageSequenceNumber	The value of the messageSequenceNumber parameter of the invocation for which this is a return.	Positive Integer	n/a
messagePrivateAnnotation	See table 3-6.		
messageSequenceNumber	See table 3-6.		
messageTimestamp	See table 3-6.		
smOwnerName	The name of the SM entity on whose behalf the management information entity that is the subject of the operation has been created.	String256	n/a

### 3.3.5.3.3.2.3 Data Set Composition and Relationship Requirements

Table 3-9 defines the data set composition and relationship requirements common to all SM successful return messages.

**Table 3-9: Data Set Composition and Relationship Requirements for All SuccessfulReturn Messages**

GRD-0001	A successful return message shall contain the <<SuccessfulReturn>> Message Stereotype parameters specified in table 3-8. [syntactic validation]
GRD-0002	The invocationMessageSequenceNumber and serviceAgreementRef parameters shall match the messageSequenceNumber and serviceAgreementRef, respectively, of the invocation to which the return responds. [service management validation]
GRD-0003	If there is no private annotation information, the messagePrivateAnnotation parameter shall have null content.

### 3.3.5.3.3.3 <<FailedReturn>> Message Stereotype

#### 3.3.5.3.3.3.1 General

FailedReturn (FR) messages are used to inform the invoker that the operation has failed, and to provide an explanation as to why the operation failed.

SM operations can fail because the invocation contains one or more *errors* (e.g., attempting to perform an operation that is illegal in the given context). The <<FailedReturn>> stereotype is defined for operations that may fail only because of errors.

NOTE – The <<FailedReturnWithDenial>> stereotype (3.3.5.3.3.4) is defined for operations that may fail because of either errors or denial.

The class diagram for the <<FailedReturn>> message stereotype structure is shown in figure 3-12.

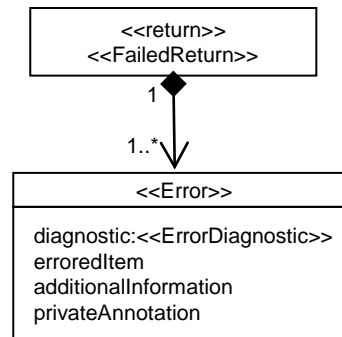

**Figure 3-12: <<FailedReturn>> Message Stereotype Class Diagram**

### 3.3.5.3.3.2 Parameters

Table 3-10 defines the <<FailedReturn>> message stereotype data set, which contains parameters that are common to all SM failed return messages for operations that may fail only because of errors in the invocation. Each message conforming to the <<FailedReturn>> stereotype also contains one or more <<Error>> data sets.

**Table 3-10: <<FailedReturn>> Message Stereotype Data Set**

Parameter Name	Parameter Definition/Description	Data Type	Units
invocationMessageSequenceNumber	See table 3-8.		
messagePrivateAnnotation	See table 3-6.		
messageSequenceNumber	See table 3-6.		
messageTimestamp	See table 3-6.		

Table 3-11 defines the stereotyped <<Error>> data set of parameters. This data set is stereotyped because the enumerated values of the diagnostic parameter are specific to each operation. For that reason, the diagnostic parameter is defined as an instance of the stereotype <<ErrorDiagnostic>>.

Table 3-11: &lt;&lt;Error&gt;&gt; Stereotype Data Set

Parameter Name	Parameter Definition/Description	Data Type	Units
additionalInformation	Additional information that is required for some values of diagnostic. The content is specific to the particular operation and the associated instance or the diagnostic value.	String or NULL	n/a
diagnostic: <<ErrorDiagnostic>>	<p>A description of the error.</p> <p>All instances of &lt;&lt;ErrorDiagnostic&gt;&gt; shall include the value 'operation timeout', to be returned when the operation cannot be completed before the disposition timer expires (see requirements 2PP-0103b in table 3-32 and 3PP-0104b in table 3-36).</p> <p>Instances of &lt;&lt;ErrorDiagnostic&gt;&gt; may include the value 'mutually incompatible parameter values', to be returned when the invocation contains two or more parameter values that are incompatible with each other. The cause of this diagnostic is specific to the particular operation.</p> <p>Instances of &lt;&lt;ErrorDiagnostic&gt;&gt; may include the value 'other', to be returned when an operation constraint that is local to the Service Agreement is violated. If the 'other' value is used, the additionalInformation parameter shall contain a locally defined explanation of the error. The contractualReference parameter of the Service Agreement shall contain the list of allowed values for the additionalInformation parameter that may be used with the 'other' value of diagnostic.</p> <p>Otherwise, values are specific to the particular operation.</p>	Enum	n/a
erroredItem	Distinguished name of the parameter or data set that fails validation because of an error in the invocation. The content is specific to the particular operation and the associated instance of the diagnostic value.	String	n/a
privateAnnotation	Implementation-dependent information that may provide additional details on the error.	String or NULL	n/a

### 3.3.5.3.3.3 Data Set Composition and Relationship Requirements

Table 3-12 defines the data set composition and relationship requirements common to all messages conforming to the <<FailedReturn>> stereotype.

**Table 3-12: Data Set Composition and Relationship Requirements for All FailedReturn Messages**

GRD-0020	A failed return message shall contain the <<FailedReturn>>Message Stereotype parameters specified in table 3-10. [syntactic validation]
GRD-0021	The failed return message shall contain one or more <b>Error</b> data sets. [syntactic validation]
GRD-0022	If there is no additional information, the <code>additionalInformation</code> parameter shall have null content.
GRD-0023	The <code>invocationMessageSequenceNumber</code> and <code>serviceAgreementRef</code> parameters shall match the <code>messageSequenceNumber</code> and <code>serviceAgreementRef</code> , respectively, of the invocation to which the return responds. [service management validation]
GRD-0024	If there is no private annotation information applicable to the overall message, the <code>messagePrivateAnnotation</code> parameter shall have null content.
GRD-0025	If there is no private annotation information applicable to the individual error being reported, the <code>privateAnnotation</code> parameter shall have null content.
GRD-0026	If the invocation is invalid due to mutually incompatible values among multiple parameters, the <b>FailedReturn</b> shall contain multiple <b>Error</b> data sets, one <b>Error</b> data set for each mutually incompatible parameter. Each such <b>Error</b> data set shall have the diagnostic value 'mutually incompatible parameter values'.

### 3.3.5.3.3.4 <<FailedReturnWithDenial>> Message Stereotype

#### 3.3.5.3.3.4.1 General

In addition to failing due to errors in operation invocations, some, but not all, SM operations can also fail when an otherwise-legal invocation is *denied* because it cannot be met (usually for scarcity of resource reasons). The <<FailedReturnWithDenial>> is defined for operations that may fail because of either errors or denial.

The class diagram for the <<FailedReturnWithDenial>> message stereotype structure is shown in figure 3-13.

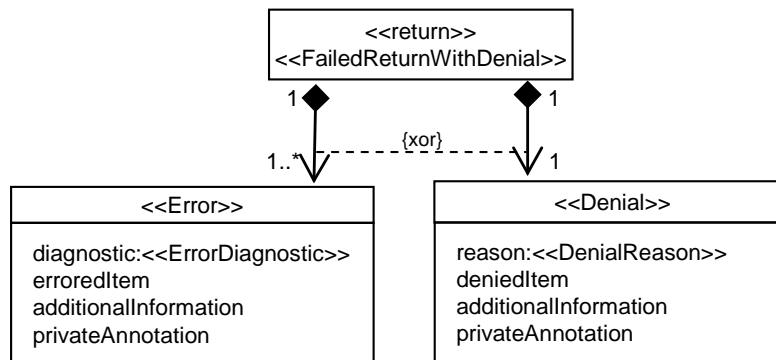
**Figure 3-13: << FailedReturnWithDenial >> Message Stereotype Class Diagram**

### 3.3.5.3.3.4.2 Parameters

The <<FailedReturnWithDenial>> message stereotype data set contains parameters that are common to all SM failed return messages for operations that may fail either because of errors in the invocation or because the operation is denied. The parameters of the <<FailedReturnWithDenial>> message stereotype data set are identical to the parameters of the <<FailedReturn>> message stereotype data set (table 3-10).

Each message conforming to the <<FailedReturnWithDenial>> stereotype also contains one <<Denial>> data set or one or more <<Error>> data sets. The contents of the <<Error>> data set are specified in table 3-11. Table 3-13 defines the <<Denial>> data set, which is present when the reason for failure is denial of the operation. This data set is stereotyped because the enumerated values of the `reason` parameter are specific to each operation. For that reason, the `reason` parameter is defined as an instance of the stereotype <<DenialReason>>.

**Table 3-13: <<Denial>> Data Set**

Parameter Name	Parameter Definition/Description	Data Type	Units
<code>additionalInformation</code>	Additional information that is required for some values of <code>reason</code> . The content is specific to the particular operation and the associated instance of the <code>reason</code> value.	String or NULL	n/a
<code>deniedItem</code>	Distinguished name of the parameter that causes the operation to be denied. The content is specific to the particular operation and the associated instance of the <code>reason</code> value.	String	n/a
<code>privateAnnotation</code>	Implementation-dependent information that may provide additional details on the denial.	String or NULL	n/a
<code>reason:</code> <<DenialReason>>	A description of the reason for the failure of the invocation.  Instances of <<DenialReason>> may include the value 'other', to be returned when the operation is denied for a reason that is local to the Service Agreement. If the 'other' value is used, the <code>additionalInformation</code> parameter shall contain a locally defined explanation of the denial. The <code>contractualReference</code> parameter of the Service Agreement shall contain the list of allowed values for the <code>additionalInformation</code> parameter that may be used with the 'other' value of <code>reason</code> .  Otherwise, values are specific to the particular operation.	Enum	n/a



### 3.3.5.3.3.4.3 Data Set Composition and Relationship Requirements

Table 3-14 defines the data set composition and relationship requirements common to all messages conforming to the <<FailedReturnWithDenial>> stereotype.

**Table 3-14: Data Set Composition and Relationship Requirements for All FailedReturnWithDenial Messages**

GRD-0030	A failed return message shall contain the <<FailedReturnWithDenial>> Message Stereotype parameters, which are identical to the <<FailedReturn>> Message Stereotype parameters specified in table 3-10. [syntactic validation]
GRD-0031	The failed return message shall contain either one <b>Denial</b> data set or one or more <b>Error</b> data sets. [syntactic validation]
GRD-0032	If there is no additional information, the <code>additionalInformation</code> parameter shall have null content.
GRD-0033	The <code>invocationMessageSequenceNumber</code> and <code>serviceAgreementRef</code> parameters shall match the <code>messageSequenceNumber</code> and <code>serviceAgreementRef</code> , respectively, of the invocation to which the return responds. [service management validation]
GRD-0034	If there is no private annotation information applicable to the overall message, the <code>messagePrivateAnnotation</code> parameter shall have null content.
GRD-0035	If there is no private annotation information applicable to the individual error or denial reason being reported, the <code>privateAnnotation</code> parameter shall have null content.
GRD-0036	If the invocation is invalid due to mutually incompatible values among multiple parameters, the <b>FailedReturn</b> shall contain multiple <b>Error</b> data sets, one <b>Error</b> data set for each mutually incompatible parameter. Each such <b>Error</b> data set shall have the diagnostic value 'mutually incompatible parameter values'.

### 3.3.5.3.3.5 <<AcknowledgedReturn>> Message Stereotype

#### 3.3.5.3.3.5.1 General

AcknowledgedReturn (AR) messages are used to provide intermediate status reports on operations, when the complete performance of those operations may take an extended period of time. An AcknowledgedReturn message informs the invoker that the operation has passed initial validation, and provides a time by which the performer expects the operation to have successfully completed or failed.

The class diagram for the <<AcknowledgedReturn>> message stereotype structure is shown in figure 3-14.

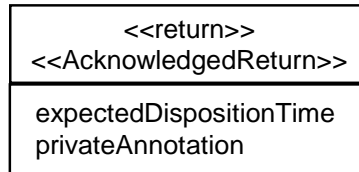

**Figure 3-14: <<AcknowledgedReturn>> Message Stereotype Class Diagram**

### 3.3.5.3.3.5.2 Parameters

Table 3-15 defines the parameters that are common to all SM AcknowledgedReturn messages.

**Table 3-15: <<AcknowledgedReturn>> Message Stereotype Data Set**

Parameter Name	Parameter Definition/Description	Data Type	Units
expectedDispositionTime	The latest time at which CM expects to provide a successful or failed disposition for the operation.	UTC	n/a
invocationMessageSequenceNumber	See table 3-8.		
messagePrivateAnnotation	See table 3-6.		
messageSequenceNumber	See table 3-6.		
messageTimestamp	See table 3-6.		
privateAnnotation	Implementation-dependent information that may further explain the reason for not dispositioning the operation until the expectedDispositionTime.	String or NULL	n/a

### 3.3.5.3.3.5.3 Data Set Composition and Relationship Requirements

Table 3-16 defines the data set composition and relationship requirements common to all SM AcknowledgedReturn messages.

**Table 3-16: Data Set Composition and Relationship Requirements for All AcknowledgedReturn Messages**

GRD-0040	An AcknowledgedReturn message shall contain the <<AcknowledgedReturn>> Message Stereotype parameters specified in table 3-15. [syntactic validation]
GRD-0041	The invocationMessageSequenceNumber and serviceAgreementRef parameters shall match the messageSequenceNumber and serviceAgreementRef, respectively, of the invocation to which the return responds. [service management validation]
GRD-0042	The expectedDispositionTime value shall be greater than the messageTimestamp value. [service management validation]
GRD-0043	If the AcknowledgedReturn message acknowledged an invocation message with an urgent parameter value of 'false', the expectedDispositionTime value shall be no later than the value of the messageTimestamp parameter of the invocation message plus the value of the routine timeout parameter for the specific SM service operation (see 3PP-0102a in table 3-36). [service management validation]
GRD-0044	If the AcknowledgedReturn message acknowledged an invocation message with an urgent parameter value of 'true', the expectedDispositionTime value shall be no later than the value of the messageTimestamp parameter of the invocation message plus the value of the urgent timeout parameter for the specific SM service operation (see 3PP-0102a in table 3-36). [service management validation]
GRD-0045	If there is no private annotation information applicable to the overall message, the messagePrivateAnnotation parameter shall have null content.
GRD-0046	If there is no implementation-dependent information that further explains why the operation will not be completed until expectedDispositionTime, the privateAnnotation parameter shall have null content.

### 3.3.5.3.4 <<Notification>> Message Stereotype

#### 3.3.5.3.4.1 General

Notification messages are used to inform the recipient that an operation has been performed by the sender of the notification without invocation from the outside. All SM Notification messages conform to the SM <<Notification>> message stereotype.

The class diagram for the <<Notification>> message stereotype structure is shown in figure 3-15.

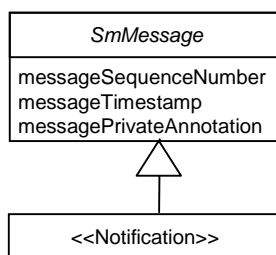

**Figure 3-15: <<Notification>> Message Stereotype Class Diagram**

### 3.3.5.3.4.2 Parameters

The constituent data set of the <<Notification>> stereotype is defined in table 3-17.

**Table 3-17: <<Notification>> Message Stereotype Data Set**

Parameter Name	Parameter Definition/Description	Data Type	Units
messagePrivateAnnotation	See table 3-6.		
messageSequenceNumber	See table 3-6.		
messageTimestamp	See table 3-6.		

### 3.3.5.3.4.3 Data Set Composition and Relationship Requirements

Table 3-18 defines the data set composition and relationship requirements common to all SM Notification messages.

**Table 3-18: Data Set Composition and Relationship Requirements for All Notification Messages**

GND-0001	A Notification message shall contain the <<Notification>> Message Stereotype parameters specified in table 3-16. [syntactic validation]
GND-0002	If there is no private annotation information applicable to the overall message, the messagePrivateAnnotation parameter shall have null content.

### 3.3.5.3.5 <<Confirmation>> Message Stereotype

#### 3.3.5.3.5.1 General

Confirmation messages are used to inform the notifying management entity that the intended recipient of a notification has received it. All SM Confirmation messages conform to the SM <<Confirmation>> message stereotype.

The class diagram for the <<Confirmation>> message stereotype is shown in figure 3-16.

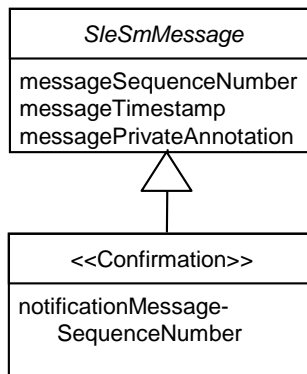

**Figure 3-16: <<Confirmation>> Message Stereotype Class Diagram**

### 3.3.5.3.5.2 Parameters

The constituent data set of the <<Confirmation>> stereotype is defined in table 3-19.

**Table 3-19: <<Confirmation>> Message Stereotype Data Set**

Parameter Name	Parameter Definition/Description	Data Type	Units
messagePrivateAnnotation	See table 3-6.		
messageSequenceNumber	See table 3-6.		
messageTimestamp	See table 3-6.		
notificationMessageSequenceNumber	The value of the messageSequenceNumber parameter of the notification for which this is a confirmation.	Positive Integer	n/a

### 3.3.5.3.5.3 Data Set Composition and Relationship Requirements

Table 3-20 defines the data set composition and relationship requirements common to all SM Confirmation messages.

**Table 3-20: Data Set Composition and Relationship Requirements for All Confirmation Messages**

GCD-0001	A Confirmation message shall contain the <<Confirmation>> Message Stereotype parameters specified in table 3-19. [syntactic validation]
GCD-0002	The notificationMessageSequenceNumber and serviceAgreementRef parameters shall match the messageSequenceNumber and serviceAgreementRef, respectively, of the notification to which the confirmation responds. [service management validation]
GCD-0003	If there is no private annotation information applicable to the overall message, the messagePrivateAnnotation parameter shall have null content.

**3.3.5.4 SmExceptionResponse**

**3.3.5.4.1 General**

**SmExceptionResponse** documents are returned by a Receiver in response to an **SmMessageSet** that cannot be submitted to an identifiable SM operation. An **SmExceptionResponse** may contain one of three kinds of response: an **UnrecognizedMessageSetResponse**, an **InvalidInvocationResponse**, or an **InvalidNotificationResponse**.

The class diagram for the **SmExceptionResponse** message structure is shown in figure 3-17.

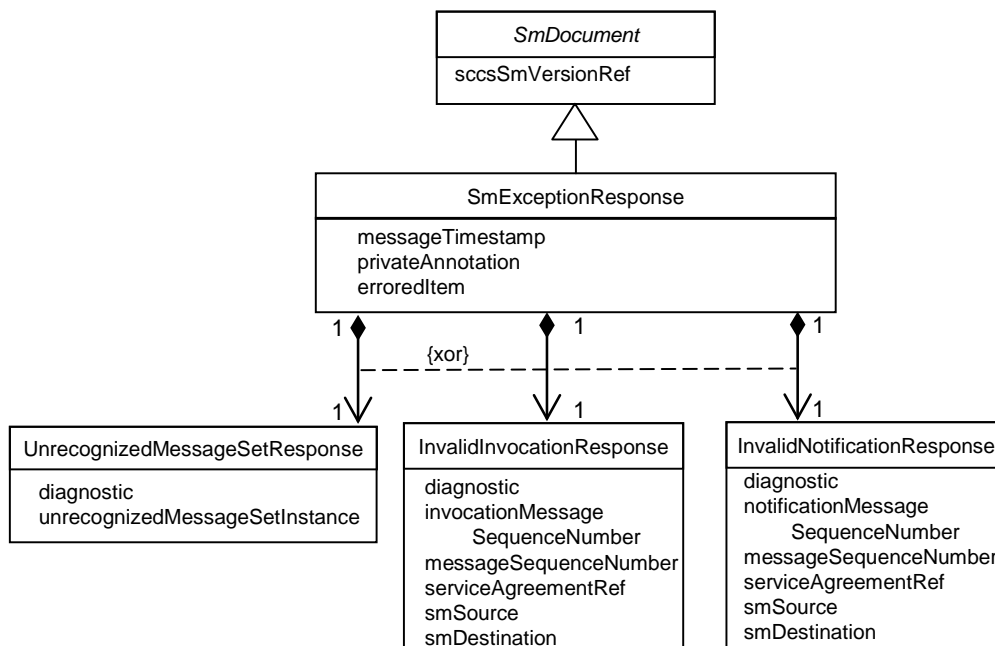

**Figure 3-17: SmExceptionResponse Class Diagram**

An **SmExceptionResponse** containing an **UnrecognizedMessageSetResponse** is sent by the receiver in response to receipt of a document that are not recognized as a valid **SmMessageSet** by the Receiver because:

- the document does not conform to the format of an SM message set;
- the `smSource` parameter contains an SM entity name that is unknown to the receiver;
- the `serviceAgreementRef` parameter contains a Service Agreement identifier that is unknown to the receiver;
- the SM entity named by the `smSource` parameter is not authorized under the Service Agreement referenced by the `serviceAgreementRef` parameter; or
- the SM entity named by the `smDestination` parameter is not authorized under the Service Agreement referenced by the `serviceAgreementRef` parameter.

In all cases the complete document (unrecognized message set) is returned to the Sender as part of the **UnrecognizedMessageSetResponse**.

An **SmExceptionResponse** containing an **InvalidInvocationResponses** is sent by the Receiver for each invocation message that cannot be processed either because it violates sequencing requirements or because it invokes an operation that is not supported by the Receiver.

An **SmExceptionResponse** containing an **InvalidNotificationResponse** is sent by the Receiver for a notification message that cannot be processed because it is a notification of a type that is not supported by the Receiver.

The **SmExceptionResponse** has a `diagnostic` parameter with values specific to the type of exception response contained within. For this reason, three tables are provided for the definition of the values of the `diagnostic` parameter, one for each of the exception response types.

### 3.3.5.4.2 Parameters

The constituent data set of the **SmExceptionResponse** messages are defined in tables 3-21 to 3-37.

**Table 3-21: SmExceptionResponse Data Set**

Parameter Name	Parameter Definition/Description	Data Type	Units
messageTimestamp	See table 3-6.		
privateAnnotation	Additional implementation-dependent information that may be provided by the intended performer of the invalid operation to further identify the nature of the exception.	String or NULL	n/a
sccsSmVersionRef	See table 3-4.		
erroredItem	Distinguished name of the parameter that: (a) causes the document to be unrecognized as a valid <b>SmMessageSet</b> (in the <b>UnrecognizedMessageSetResponse</b> ), or (b) causes the invocation or notification message to be invalid (in an <b>InvalidInvocationResponse</b> or <b>InvalidNotificationResponse</b> , respectively).	String	n/a

**Table 3-22: UnrecognizedMessageSetResponse Data Set**

Parameter Name	Parameter Definition/Description	Data Type	Units
diagnostic	The reason for the inability of the receiver to recognize the message set or the invalidity of the invocation or notification. The enumerated values are specified in table 3-25.	Enum	n/a
unrecognizedMessageSetInstance	The document that was received that could not be recognized as a valid <b>SmMessageSet</b> .	Opaque	n/a

**Table 3-23: InvalidInvocationResponse Data Set**

Parameter Name	Parameter Definition/Description	Data Type	Units
diagnostic	The reason for the invalidity of the message. The enumerated values are specified in table 3-26.	Enum	n/a
invocationMessageSequenceNumber	The sequence number of the invalid invocation message.	Positive Integer	n/a
messageSequenceNumber	See table 3-6.		
serviceAgreementRef	The identification of the Service Agreement under which the invalid message being reported upon was received.	String256	n/a
smSource	The logical or functional name of the management entity that is the source (generator) of the <b>InvalidInvocationResponse</b> .	String256	n/a
smDestination	The logical or functional name of the management entity that is the destination of the <b>InvalidInvocationResponse</b> .	String256	n/a



**Table 3-24: InvalidNotificationResponse Data Set**

Parameter Name	Parameter Definition/Description	Data Type	Units
diagnostic	The reason for the invalidity of the message: – ‘notification not supported by this Service Agreement’.	Enum	n/a
notificationMessageSequence-Number	The sequence number of the invalid notification message.	Positive Integer	n/a
messageSequenceNumber	See table 3-6.		
serviceAgreementRef	The identification of the Service Agreement under which the invalid message being reported upon was received.	String256	n/a
smSource	The logical or functional name of the management entity that is the source (generator) of the <b>InvalidNotificationResponse</b> .	String256	n/a
smDestination	The logical or functional name of the management entity that is the destination of the <b>InvalidNotificationResponse</b> .	String256	n/a

**Table 3-25: UnrecognizedMessageSetResponse diagnostic Parameter Definition**

diagnostic value	Definition/Description	Rqmt	erroredItem value
‘Network Source not authorized for smSource’	The communication-service-provided Network Source identification associated with the Message Set is not authorized to send Message Sets using the smSource in the context of the referenced Service Agreement.	MPR-0005	smSource
‘does not conform to syntax of SM message set’	The content of the message set does not conform to the syntax of an SM message set.	MSD-0001, MSD-0003 – MSD-0008	n/a
‘smSource not authorized for Service Agreement’	The smSource is not authorized in the context of the referenced Service Agreement.	MPR-0004	smSource
‘smDestination not authorized for Service Agreement’	The smDestination is not authorized in the context of the referenced Service Agreement.	MPR-0006	smDestina- tion
‘unknown service-AgreementRef’	The serviceAgreementRef does not reference an authorized Service Agreement.	MPR-0003	service- AgreementRef
‘unknown smSource’	The smSource is not recognized by the Receiver as an authorized source of SM message sets.	MPR-0002	smSource
‘version not supported’	The version named in sccsVersionRef is not supported.	MSD-0002	sccsSmVer- sionRef

**Table 3-26: InvalidInvocationResponse diagnostic Parameter Definition**

<b>diagnostic value</b>	<b>Definition/Description</b>	<b>Rqmt</b>	<b>Parameter or Data Set Identified by erroredItem</b>
'invoked operation not supported by this Service Agreement'	The invocation message is for an operation that is not supported under the referenced Service Agreement.	MPR-0008	The SM Message data set containing the invocation of the unsupported operation.
'repeated Message-SequenceNumber'	The messageSequenceNumber of an invocation message repeats within the message set.	MPR-0007	message-Sequence-Number

**Table 3-27: InvalidNotificationResponse diagnostic Parameter Definition**

<b>diagnostic value</b>	<b>Definition/Description</b>	<b>Rqmt</b>	<b>Parameter or Data Set Identified by erroredItem</b>
'notification not supported by this Service Agreement'	The notified operation is not supported under the referenced Service Agreement.	MPR-0009	The SM Message data set containing the notification of the unsupported notified operation.

### 3.3.5.4.3 Data Set Composition and Relationship Requirements

Table 3-28 defines the data set composition and relationship requirements common to all **SmExceptionResponses**.

**Table 3-28: Data Set Composition and Relationship Requirements for All SmExceptionResponses**

ERD-0001	An <b>SmExceptionResponse</b> shall contain the <b>SmExceptionResponse</b> parameters specified in table 3-21. [syntactic validation]
ERD-0002	The <b>scCsSmVersionRef</b> parameter shall have the value of '1.0.0'. [syntactic validation]
ERD-0003	An <b>SmExceptionResponse</b> shall contain one and only one of the following: a) <b>UnrecognizedMessageSetResponse</b> data set; b) <b>InvalidInvocationResponse</b> data set; or c) <b>InvalidNotificationResponse</b> data set. [syntactic validation]
ERD-0004	An <b>UnrecognizedMessageSetResponse</b> data set shall contain the <b>UnrecognizedMessageSetResponse</b> parameters specified in table 3-22. [syntactic validation]
ERD-0005	An <b>InvalidInvocationResponse</b> data set shall contain the <b>InvalidInvocationResponse</b> parameters specified in table 3-23. [syntactic validation]
ERD-0006	An <b>InvalidNotificationResponse</b> data set shall contain the <b>InvalidNotificationResponse</b> parameters specified in table 3-23. [syntactic validation]
ERD-0007	In the <b>InvalidInvocationResponse</b> data set, the <b>invocationMessageSequenceNumber</b> and <b>serviceAgreementRef</b> parameters shall match the <b>messageSequenceNumber</b> and <b>serviceAgreementRef</b> , respectively, of the invocation to which the <b>SmExceptionResponse</b> responds.
ERD-0008	In the <b>InvalidNotificationResponse</b> data set, the <b>notificationMessageSequenceNumber</b> and <b>serviceAgreementRef</b> parameters shall match the <b>messageSequenceNumber</b> and <b>serviceAgreementRef</b> , respectively, of the notification to which the <b>SmExceptionResponse</b> responds.
ERD-0009	If there is no private annotation information, the <b>privateAnnotation</b> parameter shall have null content.

## 3.4 SM OPERATION PROCEDURE PATTERNS

### 3.4.1 TWO-PHASE OPERATION PROCEDURE PATTERN

#### 3.4.1.1 General

The two-phase operation procedure pattern is used by SM operations that can be validated and performed in relatively short time.

The two-phase operation procedure pattern specifies the messages exchanged between Invoker and Performer associated with a two-phase operation, the activities of the Invoker and Performer in response to those messages, the time constraints under which those activities are to be carried out, and the behavior of the Invoker and Performer if the time constraints are violated.

The two-phase operation procedure begins with an Invoker generating an operation invocation message, placing it in an SM message set, transmitting the message set to the Performer's message set port using the SM document exchange protocol defined in 3.3, and starting the *disposition timer* for the operation.

Upon receipt of the **SmMessageSet** containing the invocation, the Performer performs syntactic, authorization, sequence, and supported-operation validation as specified in the Receiver Requirements for the SM Document Exchange Protocol in table 3-3. If the **SmMessageSet** fails any of these validations, the Performer generates and transmits an exception response containing an **UnrecognizedMessageSetResponse** or **InvalidInvocationResponse** (as appropriate to the exception) to the Invoker's exception response port, as specified in 3.3.

If the *Invocation* message passes syntactic, authorization, sequence, and supported-operation validation, the Performer starts a local disposition timer and performs *service management validation* on the invocation. The details of service management validation are specific to each operation, and are specified in the associated Invoker and Performer requirements for each operation.

If the *Invocation* is valid at the service management level and the operation can be performed before the disposition timeout is reached, the Performer performs the invoked operation and returns a **SuccessfulReturn** message to the Invoker's message set port. If the *Invocation* is **not** valid at the service management level, or if the Performer cannot complete service management validation before its disposition timer expires, the Performer terminates the operation procedure and returns a **FailedReturn** or **FailedReturn-WithDenial** message to the Invoker's message set port such that the Invoker receives the result before the disposition timer expires.

Upon receipt of the **SmMessageSet** containing the **SuccessfulReturn** message, the Invoker performs syntactic and authorization validation as specified in the Receiver Requirements for the SM Document Exchange Protocol in table 3-3. If the

**SmMessageSet** passes syntactic and authorization validation, the Invoker performs service management validation on the **SuccessfulReturn**. The details of service management validation are specific to each operation, and are specified in the associated Invoker and Performer requirements for each operation. If the **SuccessfulReturn** passes service management validation, the Invoker successfully completes the operation. If the **SuccessfulReturn** message fails service management validation, the message is deemed invalid and the Invoker is not required to interpret or act upon the message any further.

Upon receipt of an **SmMessageSet** containing a **FailedReturn** or **FailedReturn-WithDenial** message, the Invoker performs syntactic and authorization validation as specified in the Receiver Requirements for the SM Document Exchange Protocol in table 3-3. If the **SmMessageSet** passes syntactic and authorization validation, the Invoker performs service management validation on the **FailedReturn** or **FailedReturn-WithDenial** message. If the **FailedReturn** or **FailedReturn-WithDenial** passes service management validation, the Invoker terminates the operation. If the **FailedReturn** or **FailedReturn-WithDenial** message fails service management validation, the message is deemed invalid and the Invoker is not required to interpret or act upon the message any further.

If the Invoker receives an **SmMessageSet** (nominally containing a **SuccessfulReturn**, a **FailedReturn**, or **FailedReturn-WithDenial** message) that fails syntactic or authorization validation, the Invoker generates and transmits an exception response containing an **UnrecognizedMessageSetResponse** to the Performer's exception response port, as specified in 3.3.

If the Invoker does not receive a validated result (successful or failed) before its disposition timer for that operation expires, the Invoker determines the disposition of the operation by bilaterally defined means (e.g., contact the Performer by voice) and complete the operation procedure.

NOTE – The failure by the Invoker to validate an operation return or correlate an **UnrecognizedMessageSetResponse** or **InvalidInvocation-Response** from the Performer will eventually result in the expiration of the associated disposition timer, which in turn will result in the Invoker determining the status of the operation by other means.

### 3.4.1.2 Sequence Diagram

Figure 3-18 is the sequence diagram for the two-phase operation procedure pattern. It is composed of multiple instances of the Send Message sequence specified in figure 3-4.

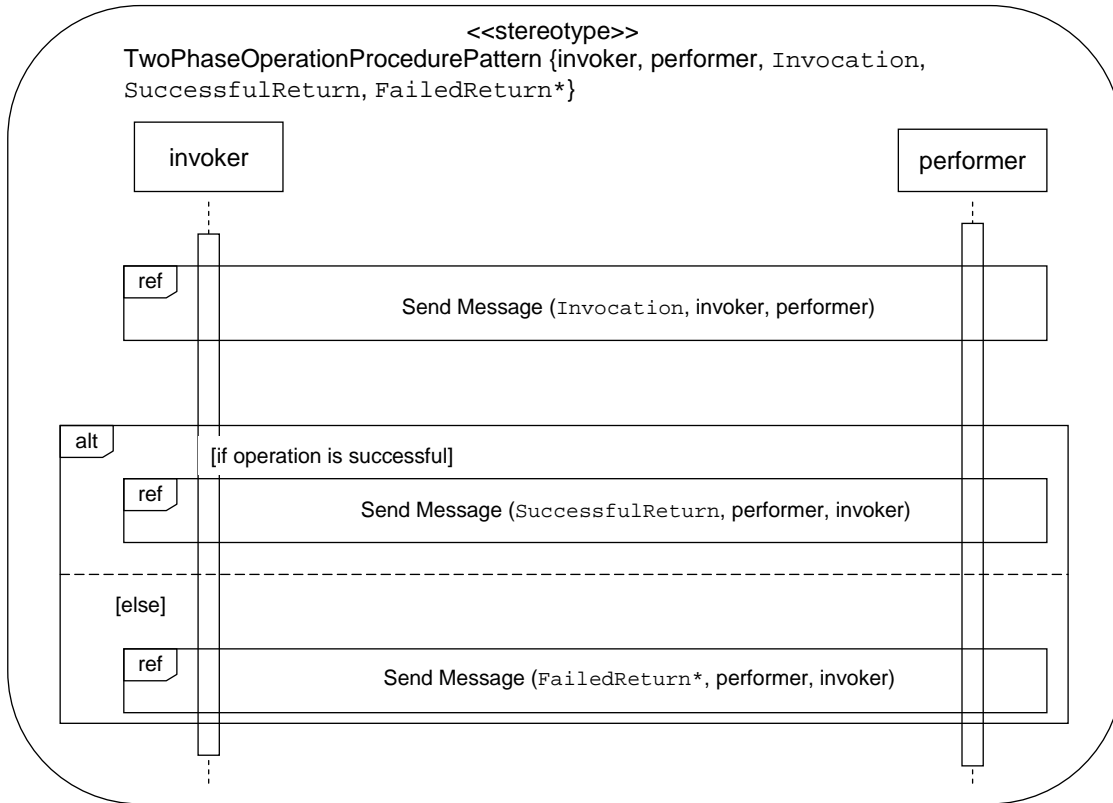

FailedReturn\* designates either a **FailedReturn** or **FailedReturnWithDenial**, as appropriate to the specific operation.

**Figure 3-18: Sequence Diagram for Two-Phase Operation Pattern**

### 3.4.1.3 State Machines

Figures 3-19 and 3-20 are the state diagrams for the two-phase operation procedure pattern from the points of view of the operation Invoker and Performer respectively. Tables 3-29 and 3-30 are the corresponding state tables. In the figures and tables: *op\_I* represents the invocation of the operation; *op\_SR* represents the successful return for the operation, and *op\_FR* represents the failed return for the operation.

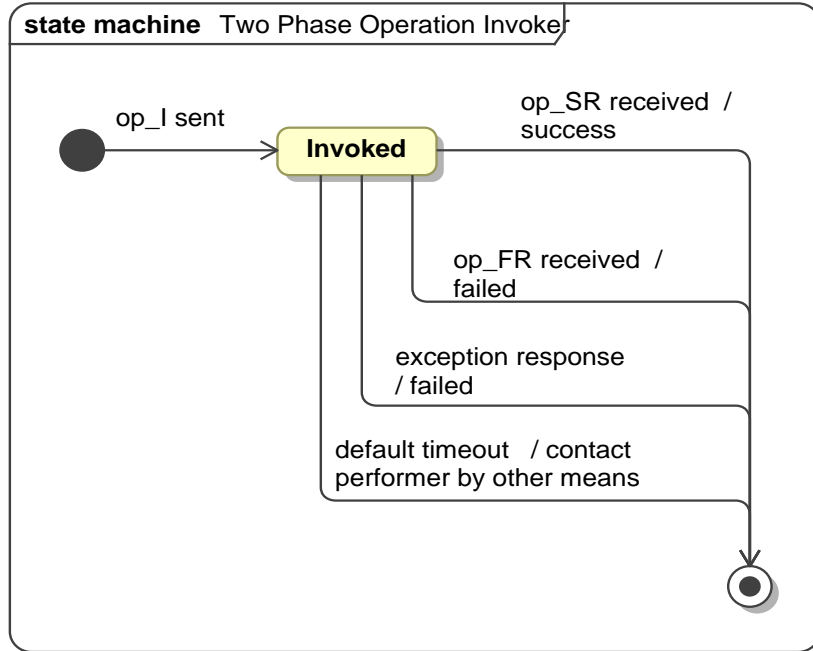

Figure 3-19: State Diagram for Two-Phase Operation Pattern—Invoker View

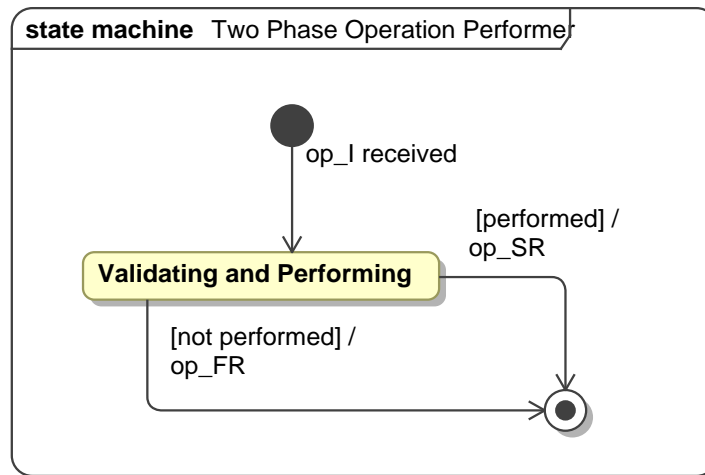

Figure 3-20: State Diagram for Two-Phase Operation Pattern—Performer View

**Table 3-29: State Table for Two-Phase Operation—Invoker View**

State	Initial	Invoked
<b>Event</b>		
<i>op-I sent</i>	-> Invoked	-
<i>op-SR received</i>	-	-> Final
<i>op-FR received</i>	-	FAIL -> Final
<i>Exception response</i>	-	FAIL -> Final
<i>Timeout</i>	-	Contact performer -> Final

**Table 3-30: State Table for Two-Phase Operation—Performer View**

State	Initial	Validating and Performing
<b>Event</b>		
<i>op-I received</i>	-> Validating and Performing	-
Operation performed	-	<i>op-SR</i> -> Final
Operation not performed	-	<i>op-FR</i> -> Final

Only SM messages which have already passed validation at the level of the Document Exchange Protocol (syntactical, authentication, invocation sequence (if applicable), and supported-operation) enter into the state machine for the Two-Phase Operation Procedure Pattern. In addition, responses must be correlated with preceding messages (by sequence number) in order to be associated to any operation and enter into the state machine; if not correlated, they are discarded.

**3.4.1.4 Activity Diagram**

Figure 3-21 is the activity diagram for the two-phase operation procedure pattern.



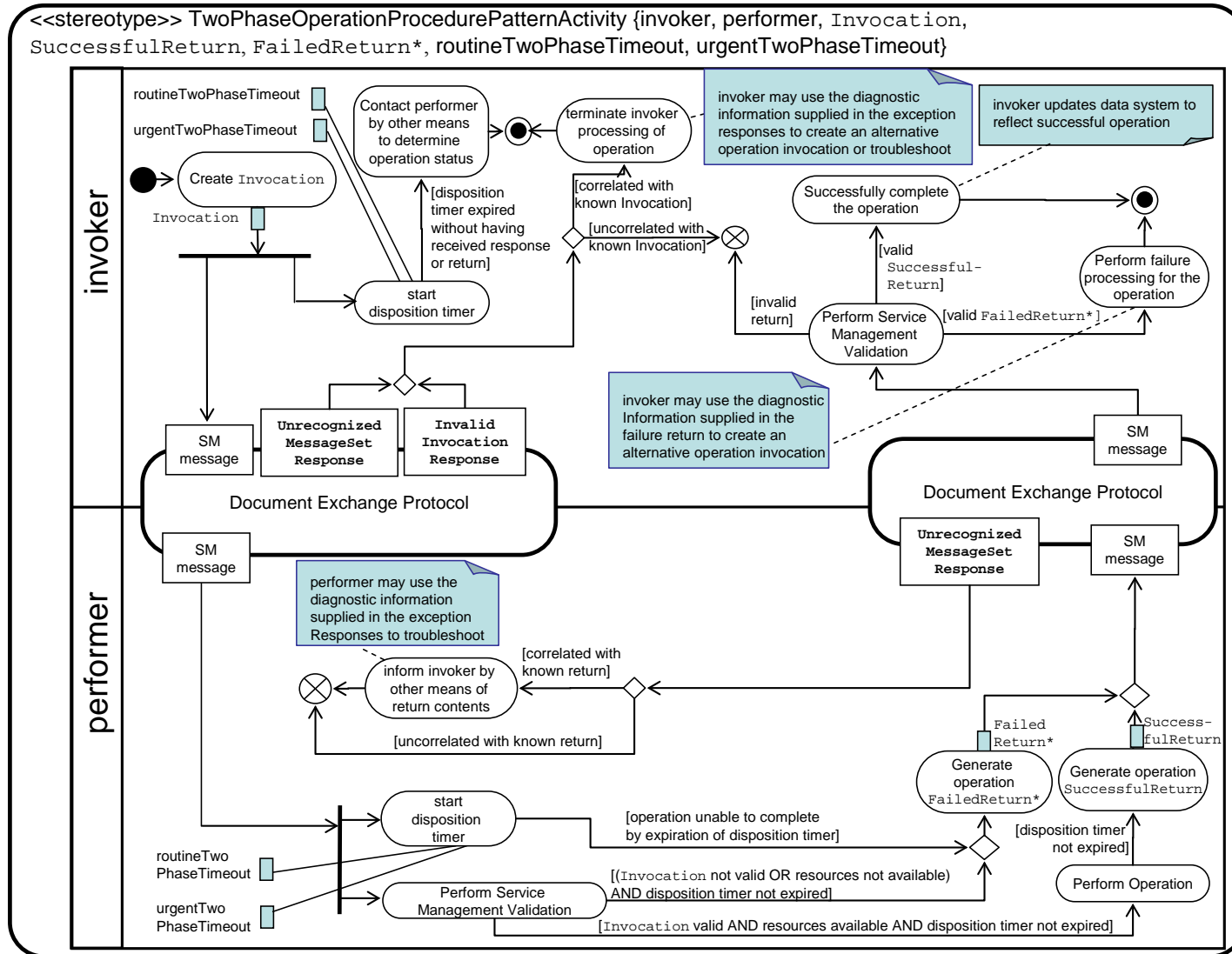

FailedReturn\* designates either a **FailedReturn** or **FailedReturnWithDenial**, as appropriate to the specific operation.

**Figure 3-21: Two-Phase Operation Procedure Pattern Activity Diagram**

### 3.4.1.5 Requirements

#### 3.4.1.5.1 Invoker Requirements for Two-Phase Operation Procedures

The common Invoker requirements for all two-phase operations are defined in table 3-31. In the table, the term `FailedReturn*` is used to designate a message that conforms to either the `<<FailedReturn>>` or `<<FailedReturnWithDenial>>` message stereotype, depending on the specific Service Management operation.

**Table 3-31: Invoker Requirements for the Two-Phase Operation Procedures**

2PI-0001	The Invoker shall format the operation <code>Invocation</code> and transmit it to the Performer's message set port in conformance with the Sender Requirements for the SM Document Exchange Protocol as defined in 3.3.4.1.
2PI-0002	The Invoker shall set the value of the disposition timer using the value of the appropriate two-phase timer parameter for that operation in the referenced Service Agreement: <ul style="list-style-type: none"> <li>a) If the invocation is urgent, the <code>urgent</code> parameter shall be set to 'true' and the disposition timer shall be set to the <code>messageTimestamp</code> of the <code>Invocation</code> plus the value of the urgent timeout parameter for that operation.</li> <li>b) If the invocation is routine, the <code>urgent</code> parameter shall be set to 'false' and the disposition timer shall be set to the <code>messageTimestamp</code> of the <code>Invocation</code> plus the value of the routine timeout parameter for that operation.</li> </ul>
2PI-0003	The Invoker shall validate returns received from the Performer on the message set port in accordance with the Receiver Requirements for the SM Document Exchange Protocol as defined in 3.3.4.2.
2PI-0004	The Invoker shall validate exception responses received from the Performer on the exception response port in accordance with the Sender Requirements for the SM Document Exchange Protocol as defined in 3.3.4.1.
2PI-0005	For each syntactically valid <code>UnrecognizedMessageSetResponse</code> received on the exception response port, the Invoker shall attempt to correlate the content of the <code>UnrecognizedMessageSetResponse</code> with one or more <code>Invocations</code> awaiting disposition. If correlation is successful, the Invoker shall terminate any operation for which an <code>Invocation</code> is contained in a message set for which a validated <code>UnrecognizedMessageSetResponse</code> is received. The Invoker is not required to further interpret or act upon any <code>UnrecognizedMessageSetResponse</code> that cannot be correlated. NOTE – The Invoker may perform local functions specific to an unknown or invalid <code>Invocation</code> as part of completing the operation procedure (e.g., update local databases to reflect failure of the operation, contact the Performer to troubleshoot the failure).
2PI-0006	For each syntactically valid <code>InvalidInvocationResponse</code> received on the exception response port, the Invoker shall attempt to correlate the content of the <code>InvalidInvocationResponse</code> with an <code>Invocation</code> awaiting disposition. If correlation is successful, the Invoker shall terminate the operation for which the <code>Invocation</code> is rejected in the <code>InvalidInvocationResponse</code> . The Invoker is not required to further interpret or act upon any <code>InvalidInvocationResponse</code> that cannot be correlated. NOTE – The Invoker may perform local functions specific to an unknown or invalid <code>Invocation</code> as part of completing the operation procedure (e.g., update local databases to reflect failure of the operation, contact the Performer to troubleshoot the failure).

2PI-0007	The Invoker shall validate that the <code>invocationMessageSequenceNumber</code> and <code>serviceAgreementRef</code> parameters of a return match the <code>messageSequenceNumber</code> and <code>serviceAgreementRef</code> , respectively, of an <code>Invocation</code> for which the Invoker is awaiting a return, in order to associate a return with an <code>Invocation</code> . NOTE – This is a necessary but not sufficient condition for acceptance of a return for an <code>Invocation</code> . There are additional operation-level matching criteria that must also be met, as specified in the requirements for the specific operations.
2PI-0008	If a <code>SuccessfulReturn</code> or <code>FailedReturn*</code> fails any service management validation requirement specified for its return type, the return shall be deemed to be service management-invalid. The Invoker is not required to further interpret or act upon the service management-invalid return.
2PI-0009	If a <code>SuccessfulReturn</code> passes all service management validation requirement specified for its return type, the Invoker shall successfully complete the operation. NOTE – The Invoker may perform local functions specific to a successful operation as part of completing the operation (e.g., updating local databases to reflect success of the operation).
2PI-0010	If a <code>FailedReturn*</code> passes all service management validation requirement specified for its return type, the Invoker shall terminate the operation. NOTE – The Invoker may perform local functions specific to a failed operation as part of terminating the operation (e.g., updating local databases to reflect failure of the operation, contact the Performer to troubleshoot the failure).
2PI-0011	If a validated <code>SuccessfulReturn</code> or <code>FailedReturn*</code> is not received for and associated with the operation by the time the associated disposition timer expires, the Invoker shall contact the Performer to determine the disposition of the operation.

#### 3.4.1.5.2 Performer Requirements for Two-Phase Operation Procedures

The common Performer requirements for all two-phase operations are defined in table 3-32. In the table, the term `FailedReturn*` is used to designate a message that conforms to either the `<<FailedReturn>>` or `<<FailedReturnWithDenial>>` message stereotype, depending on the specific Service Management operation.

**Table 3-32: Performer Requirements for the Two-Phase Operation Procedures**

2PP-0101	The Performer shall receive the operation <code>Invocation</code> and perform syntactic, authorization, sequencing, and supported-operation validation in conformance with the Receiver Requirements for the SM Document Exchange Protocol as defined in 3.3.4.2.
2PP-0102	<p>If the <code>Invocation</code> passes syntactic, authorization, sequencing, and supported-operation validation as specified in 2PP-0101, the Performer shall:</p> <ul style="list-style-type: none"> <li>a) initialize a disposition timer based on the value of the <code>messageTimestamp</code> of the operation invocation plus the value of the appropriate two-phase timeout parameter of the referenced Service Agreement (see note below), where: <ul style="list-style-type: none"> <li>1) if the <code>urgent</code> parameter of the <code>Invocation</code> is set to 'true', the value of the urgent timeout parameter for that operation shall be used;</li> <li>2) if the <code>urgent</code> parameter of the <code>Invocation</code> is set to 'false', the value of the routine timeout parameter for that operation shall be used; and</li> </ul> </li> <li>b) perform operation-specific service management validation on the <code>Invocation</code>: <ul style="list-style-type: none"> <li>1) if the <code>Invocation</code> passes service management validation, the Performer shall attempt to perform the operation prior to the expiration of the local disposition timer;</li> <li>2) if the <code>Invocation</code> fails service management validation, the Performer shall cease interpreting and acting upon the <code>Invocation</code>, generate a <code>FailedReturn*</code>, and transmit the <code>FailedReturn*</code> to the Invoker's message set port in accordance with the Sender Requirements for the SM Document Exchange Protocol such that the Invoker receives the return before the disposition timer expires.</li> </ul> </li> </ul> <p>NOTES</p> <ul style="list-style-type: none"> <li>1 In order for the Performer to ensure that any return to an <code>Invocation</code> arrives at the Invoker before the Invoker's disposition timer expires, it is assumed that the Performer adjusts (i.e., shortens) its local disposition timer value by some amount of time to compensate for the transit of the return across the communications network that connects them. The method by which the Performer determines this adjustment factor is outside the scope of this Recommended Standard.</li> <li>2 It is assumed that the time standards upon which the Invoker and Performer set their disposition timers are synchronized to within one (1) second of each other. If this assumption cannot be made for a particular pair of Invoker and Performer, then additional methods may be required to compensate for the ambiguity (such as further decreasing the Performer's disposition timer value to account for the ambiguity). Any such adjustment for time standard ambiguity is outside the scope of this Recommended Standard.</li> </ul>
2PP-0103	<ul style="list-style-type: none"> <li>a) If the Performer successfully completes the operation prior to the expiration of the disposition timer, the Performer shall transmit a <code>SuccessfulReturn</code> to the message set port of the Invoker in accordance with the Sender Requirements for the SM Document Exchange Protocol. NOTE – The Performer may perform local functions specific to a successful operation as part of completing the operation procedure.</li> <li>b) If the invoked operation cannot be successfully completed or failed for other reasons by the expiration of the disposition timer, the Performer shall terminate the operation and return a <code>FailedReturn*</code> with diagnostic value 'operation timeout'. NOTE – The Performer may perform local functions specific to a failed operation as part of completing the operation procedure.</li> </ul>
2PP-0104	The Performer shall validate exception responses received from the Invoker on the exception response port in accordance with the Sender Requirements for the SM Document Exchange Protocol as defined in 3.3.4.1.
2PP-0105	<p>For each syntactically valid <code>UnrecognizedMessageSetResponse</code> received on the exception response port, the Performer shall attempt to correlate the content of the <code>UnrecognizedMessageSetResponse</code> with a return that was sent. If correlation is successful, the Performer shall notify the Invoker by other means of the contents of any return that was contained in a message set for which a valid <code>UnrecognizedMessageSetResponse</code> is received. The Invoker is not required to further interpret or act upon any <code>UnrecognizedMessageSetResponse</code> that cannot be correlated.</p> <p>NOTE – The Performer may also perform local functions to determine why the return was not validated by the Invoker.</p>

## 3.4.2 THREE-PHASE OPERATION PROCEDURE PATTERN

### 3.4.2.1 General

The three-phase operation procedure pattern is used by SM operations that may require an extended period of time before they can be validated and/or performed.

The three-phase operation procedure pattern specifies the messages exchanged between Invoker and Performer associated with a three-phase operation, the activities of the Invoker and Performer in response to those messages, the time constraints under which those activities are to be carried out, and the behavior of the Invoker and Performer if the time constraints are violated.

The three-phase operation procedure begins with the Invoker generating an operation Invocation message, placing it in an **SmMessageSet**, transmitting the **SmMessageSet** to the Performer's message set port using the SM document exchange protocol defined in 3.3, and starting the disposition timer for the operation.

Upon receipt of the **SmMessageSet** containing the Invocation, the Performer performs syntactic, authorization, sequencing, and supported-operation validation as specified in the Receiver Requirements for the SM Document Exchange Protocol in table 3-3. If the **SmMessageSet** fails any of these validations, the Performer generates and transmits an exception response containing an **UnrecognizedMessageSetResponse** or **InvalidInvocationResponse** (as appropriate to the exception) to the Invoker exception response port, as specified in 3.3.

If the Invocation message passes syntactic, authorization, sequencing, and supported-operation validation, the Performer estimates how long it will take to perform the operation, returns to the Invoker's message set port an **AcknowledgedReturn** message containing in the **expectedDispositionTime** parameter (see table 3-15) the maximum estimated time until a final disposition can be provided, and starts a local disposition timer based on that value. The **AcknowledgedReturn** message may also contain locally defined further information explaining the conditions that determined the **expectedDispositionTime** value in the **privateAnnotation** parameter (e.g., 'next weekly schedule run'). The Performer then performs service management validation on the Invocation. The details of service management level validation are specific to each operation.

If the Invocation is valid at the service management level and the operation can be performed before the disposition timeout is reached, the Performer performs the invoked operation and returns a **SuccessfulReturn** message to the Invoker's message set port. If the Invocation is **not** valid at the service management level, or if the Performer cannot complete service management validation before the disposition timer expires, the Performer terminates the operation procedure and returns a **FailedReturn** or **FailedReturnWithDenial** message to the Invoker's message set port such that the Invoker receives the result before the disposition timer expires.

Upon receipt of the **SmMessageSet** containing the **AcknowledgedReturn** message, the Invoker performs syntactic and authorization validation as specified in the Receiver Requirements for the SM Document Exchange Protocol in table 3-3. If the **SmMessageSet** passes syntactic and authorization validation, the Invoker performs service management validation on the **AcknowledgedReturn**. If the **AcknowledgedReturn** passes service management validation, and if the **expectedDispositionTime** parameter value results in an expected disposition time that is sooner than that the disposition timer value based on the urgent/routine three-phase timer value, the Invoker resets the disposition timer to the value of **expectedDispositionTime**. If the **AcknowledgedReturn** message fails service management validation, the message is deemed invalid and the Invoker is not required to interpret or act upon the message any further.

Upon receipt of the **SmMessageSet** containing the **SuccessfulReturn** message, the Invoker performs syntactic and authorization validation as specified in the Receiver Requirements for the SM Document Exchange Protocol in table 3-3. If the **SmMessageSet** passes syntactic and authorization validation, the Invoker performs service management validation on the **SuccessfulReturn**. The details of service management validation are specific to each operation, and are specified in the associated Invoker and Performer requirements for each operation. If the **SuccessfulReturn** passes service management validation, the Invoker successfully completes the operation. If the **SuccessfulReturn** message fails service management validation, the message is deemed invalid and the Invoker is not required to interpret or act upon the message any further.

Upon receipt of the **SmMessageSet** containing the **FailedReturn** or **FailedReturnWithDenial** message, the Invoker performs syntactic and authorization validation as specified in the Receiver Requirements for the SM Document Exchange Protocol in table 3-3. If the **SmMessageSet** passes syntactic and authorization validation, the Invoker performs service management validation on the **FailedReturn** or **FailedReturnWithDenial**. The details of service management validation are specific to each operation, and are specified in the associated Invoker and Performer requirements for each operation. If the **FailedReturn** or **FailedReturnWithDenial** passes service management validation, the Invoker terminates the operation. If the **SmMessageSet** fails syntactic or authorization validation, the Invoker generates and transmits an exception response containing an **UnrecognizedMessageSetResponse** to the Performer's exception response port, as specified in 3.3. If the **FailedReturn** or **FailedReturnWithDenial** message fails service management validation, the message is deemed invalid and the Invoker is not required to interpret or act upon the message any further.

If the Invoker receives an **SmMessageSet** (nominally containing an **AcknowledgedReturn**, a **SuccessfulReturn**, a **FailedReturn**, or **FailedReturnWithDenial**) that fails syntactic or authorization validation, the Invoker generates and transmits an exception response containing an **UnrecognizedMessageSetResponse** to the Performer's exception response port, as specified in 3.3.

If the Invoker does not receive a validated result (successful or failed) before the disposition timer for that operation expires, the Invoker determines the disposition of the operation by bilaterally defined means (e.g., contact the Performer by voice) and complete the operation procedure.

NOTE – The failure by the Invoker to validate an operation return or correlate an **UnrecognizedMessageSetResponse** or **InvalidInvocation-Response** from the Performer will eventually result in the expiration of the associated disposition timer, which results in the Invoker determining the status of the operation by other means.

If the Invoker receives an AcknowledgedReturn after it receives a SuccessfulReturn or FailedReturn for the same operation, or after the expiration of the disposition timer for that operation, the Invoker ignores the AcknowledgedReturn.

### 3.4.2.2 Sequence Diagram

Figure 3-22 is the sequence diagram for the three-phase operation procedure pattern. It is composed of multiple instances of the Send Message sequence specified in figure 3-4.

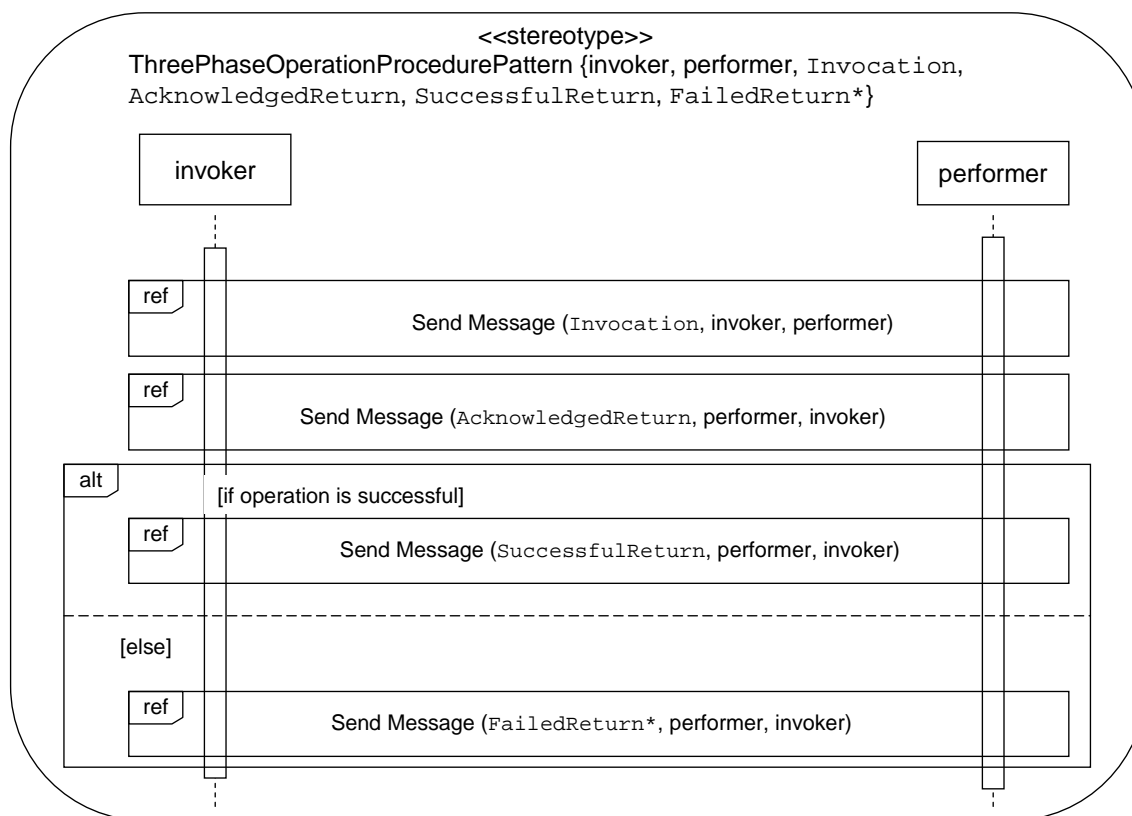

FailedReturn\* designates either a FailedReturn or FailedReturnWithDenial, as appropriate to the specific operation.

**Figure 3-22: Sequence Diagram for Three-Phase Operation Pattern**

3.4.2.3 State Machines

Figures 3-23 and 3-24 are the state diagrams for the three-phase operation procedure pattern from the points of view of the operation Invoker and Performer respectively. Tables 3-33 and 3-34 are the corresponding state tables. In the figures and tables: *op\_I* represents the invocation of the operation; *op\_AR* represents the acknowledged return for the operation; *op\_SR* represents the successful return for the operation, and *op\_FR* represents the failed return for the operation.

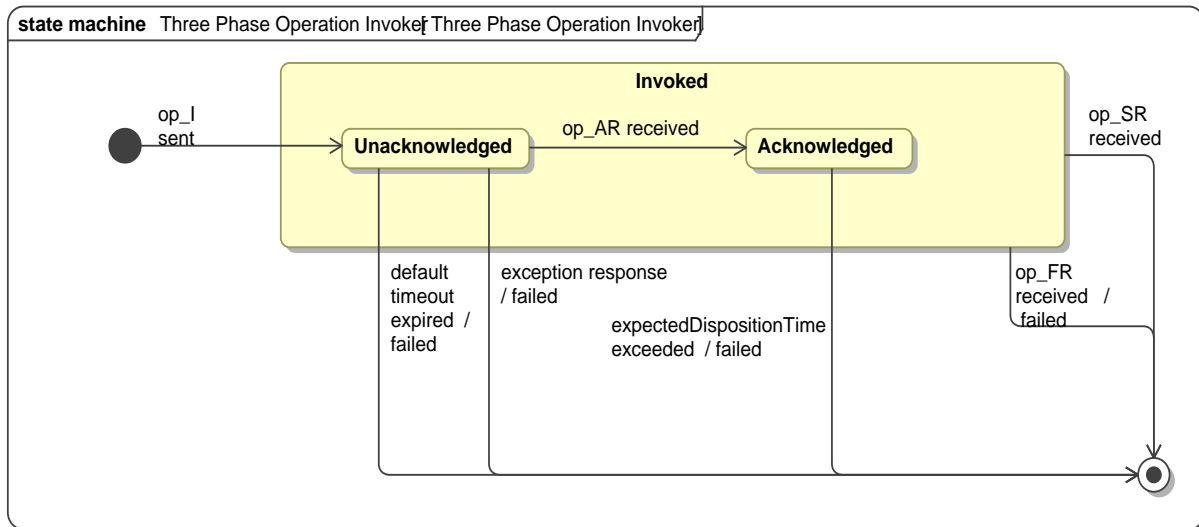

Figure 3-23: State Diagram for Three-Phase Operation Pattern—Invoker View

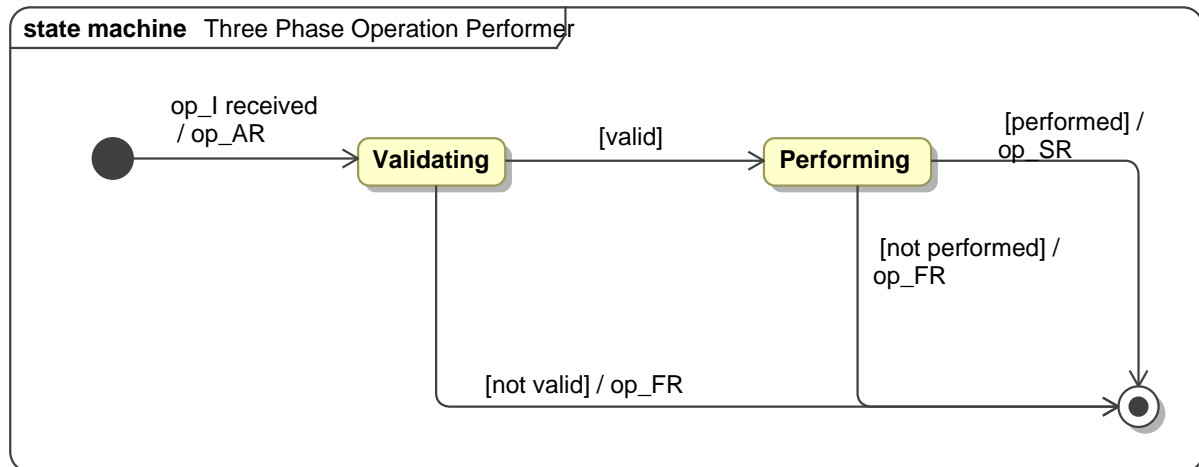

Figure 3-24: State Diagram for Three-Phase Operation Pattern—Performer View



**Table 3-33: State Table for Three-Phase Operation—Invoker View**

Event	State		
	Initial	Invoked	Acknowledged
<i>op-I</i> sent	-> Invoked	-	-
<i>op-AR</i> received	-	-> Acknowledged	-
<i>op-SR</i> received	-	-	-> Final
<i>op-FR</i> received	-	-	FAIL -> Final
Exception response	-	FAIL -> Final	
Three-phase Timeout	-	Contact performer -> Final	-
Expected Disposition Timeout	-	-	Contact performer -> Final

**Table 3-34: State Table for Three-Phase Operation—Performer View**

Event	State		
	Initial	Validating	Performing
<i>op-I</i> received	<i>op-AR</i> -> Validating		-
Validation complete: valid		-> Performing	
Validation complete: not valid		<i>op-FR</i> -> Final	
Operation performed	-		<i>op-SR</i> -> Final
Operation not performed	-		<i>op-FR</i> -> Final

Only SM messages which have already passed validation at the level of the Document Exchange Protocol (syntactical, authentication, invocation sequence (if applicable), and supported-operation) enter into the state machine for the Three-Phase Operation Procedure Pattern. In addition, responses must be correlated with preceding messages (by sequence number) in order to be associated to any operation and enter into the state machine; if not correlated, they are discarded.

#### 3.4.2.4 Activity Diagram

Figure 3-25 is the activity diagram for the three-phase operation procedure pattern.

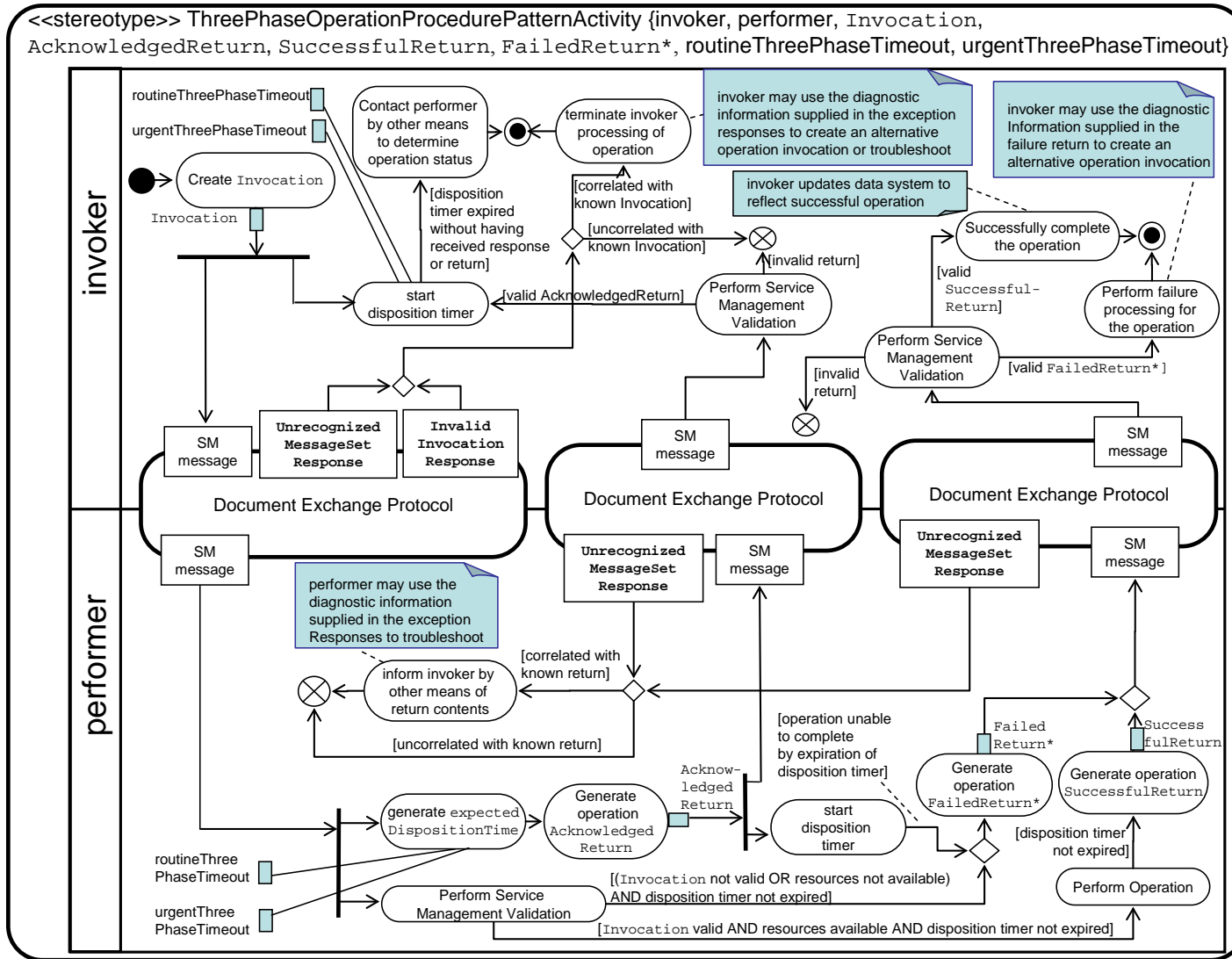

FailedReturn\* designates either a FailedReturn or FailedReturnWithDenial, as appropriate to the specific operation.

Figure 3-25: Three-Phase Operation Procedure Pattern Activity Diagram

### 3.4.2.5 Requirements

#### 3.4.2.5.1 Invoker Requirements for Three-Phase Operation Procedures

The common Invoker requirements for all three-phase operations are defined in table 3-35. In the table, the term `FailedReturn*` is used to designate a message that conforms to either the `<<FailedReturn>>` or `<<FailedReturnWithDenial>>` message stereotype, depending on the specific Service Management operation.

**Table 3-35: Invoker Requirements for the Three-Phase Operation Procedures**

3PI-0001	The Invoker shall format the operation <code>Invocation</code> and transmit it to the Performer's message set port in conformance with the Sender Requirements for the SM Document Exchange Protocol as defined in 3.3.4.1.
3PI-0002	The Invoker shall set the value of the disposition timer using the value of the appropriate three-phase timer parameter for that operation in the referenced Service Agreement: <ul style="list-style-type: none"> <li>a) If the invocation is urgent, the <code>urgent</code> parameter shall be set to 'true' and the disposition timer shall be set to the <code>messageTimestamp</code> of the <code>Invocation</code> plus the value of the urgent timeout parameter for that operation.</li> <li>b) If the invocation is routine, the <code>urgent</code> parameter shall be set to 'false' and the disposition timer shall be set to the <code>messageTimestamp</code> of the <code>Invocation</code> plus the value of the routine timeout parameter for that operation.</li> </ul>
3PI-0003	The Invoker shall validate returns received from the Performer on the message set port in accordance with the Receiver Requirements for the SM Document Exchange Protocol as defined in 3.3.4.2.
3PI-0004	The Invoker shall validate exception responses received from the Performer on the exception response port in accordance with the Sender Requirements for the SM Document Exchange Protocol as defined in 3.3.4.1.
3PI-0005	For each syntactically valid <code>UnrecognizedMessageSetResponse</code> received on the exception response port, the Invoker shall attempt to correlate the content of the <code>UnrecognizedMessageSetResponse</code> with one or more <code>Invocations</code> awaiting disposition. If correlation is successful, the Invoker shall terminate any operation for which an <code>Invocation</code> is contained in a message set for which a validated <code>UnrecognizedMessageSetResponse</code> is received. The Invoker is not required to further interpret or act upon any <code>UnrecognizedMessageSetResponse</code> that cannot be correlated. NOTE – The Invoker may perform local functions specific to an unknown or invalid <code>Invocation</code> as part of completing the operation procedure (e.g., update local databases to reflect failure of the operation, contact the Performer to troubleshoot the failure).
3PI-0006	For each syntactically valid <code>InvalidInvocationResponse</code> received on the exception response port, the Invoker shall attempt to correlate the content of the <code>InvalidInvocationResponse</code> with an <code>Invocation</code> awaiting disposition. If correlation is successful, the Invoker shall terminate the operation for which the <code>Invocation</code> is rejected in the <code>InvalidInvocationResponse</code> . The Invoker is not required to further interpret or act upon any <code>InvalidInvocationResponse</code> that cannot be correlated. NOTE – The Invoker may perform local functions specific to an unknown or invalid <code>Invocation</code> as part of completing the operation procedure (e.g., update local databases to reflect failure of the operation, contact the Performer to troubleshoot the failure).
3PI-0007	If the <code>expectedDispositionTime</code> parameter of the <code>AcknowledgedReturn</code> message is less than the disposition time that the Invoker set based on the value of the appropriate (routine or urgent) three-phase timeout value, the Invoker shall reset the value of the return disposition timer to the value of the <code>expectedDispositionTime</code> parameter of the <code>AcknowledgedReturn</code> message.
3PI-0008	The Invoker shall ignore any <code>AcknowledgedReturn</code> that is received either (a) after receipt of a <code>SuccessfulReturn</code> or <code>FailedReturn*</code> for the same operation, or (b) after the associated disposition timer expires.

3PI-0009	The Invoker shall confirm that the <code>invocationMessageSequenceNumber</code> and <code>ServiceAgreementRef</code> parameters of a return match the <code>messageSequenceNumber</code> and <code>ServiceAgreementRef</code> , respectively, of an <code>Invocation</code> for which the Invoker is awaiting a return, in order to associate a return with an <code>Invocation</code> . NOTE – This is a necessary but not sufficient condition for acceptance of a return for an <code>Invocation</code> . There are additional operation-level matching criteria that must also be met, as specified in the requirements for the specific operations.
3PI-0010	If an <code>AcknowledgedReturn</code> , a <code>SuccessfulReturn</code> or a <code>FailedReturn*</code> fails any service management validation requirement specified for its return type, the return shall be deemed to be service management-invalid. The Invoker is not required to further interpret or act upon the service management-invalid return.
3PI-0011	If the <code>SuccessfulReturn</code> passes service management validation, the Invoker shall successfully complete the operation. NOTE – The Invoker may perform local functions specific to a successful operation as part of completing the operation procedure (e.g., updating local databases to reflect success of the operation).
3PI-0012	If the <code>FailedReturn*</code> passes service management validation, the Invoker shall terminate the operation. NOTE – The Invoker may perform local functions specific to a failed operation as part of failure processing (e.g., update local databases to reflect failure of the operation, contact the Performer to troubleshoot the failure).
3PI-0013	If a <code>SuccessfulReturn</code> or <code>FailedReturn*</code> is not received for the operation by the time the associated disposition timer expires, the Invoker shall contact the Performer to determine the disposition of the operation.

#### 3.4.2.5.2 Performer Requirements for Three-Phase Operation Procedures

The common Performer requirements for all three-phase operations are defined in table 3-36. In the table, the term `FailedReturn*` is used to designate a message that conforms to either the `<<FailedReturn>>` or `<<FailedReturnWithDenial>>` message stereotype, depending on the specific Service Management operation.

**Table 3-36: Performer Requirements for the Three-Phase Operation Procedures**

3PP-0101	The Performer shall receive operation <code>Invocation</code> and perform syntactic, authorization, sequencing, and supported-operation validation in conformance with the Receiver Requirements for the SM Document Exchange Protocol as defined in 3.3.4.2.
3PP-0102	<p>If the <code>Invocation</code> passes syntactic, authorization, sequencing, and supported-operation validation as specified in 3PP-0101, the Performer shall generate and send an <code>AcknowledgedReturn</code> message to the Invoker's message port in accordance with the Sender Requirements for the SM Document Exchange Protocol as defined in 3.3.4.2.</p> <ol style="list-style-type: none"> <li>a) If the <code>urgent</code> parameter of the invocation is 'true', the Performer shall set the <code>expectedDispositionTime</code> parameter of the <code>AcknowledgedReturn</code> message to no later than the <code>messageTimestamp</code> of the <code>Invocation</code> plus the value of the <code>urgent</code> timeout parameter of the referenced Service Agreement. Otherwise, the Performer shall set the <code>expectedDispositionTime</code> parameter to no later than the <code>messageTimestamp</code> of the <code>Invocation</code> plus the value of the routine timeout parameter of the referenced Service Agreement.</li> <li>b) The Performer shall transmit the <code>AcknowledgedReturn</code> to the Invoker such that the return is received by the Invoker at or before the <code>messageTimestamp</code> of the operation <code>Invocation</code> plus the value of the routine timeout or <code>urgent</code> timeout parameter of the referenced Service Agreement, as appropriate (see 3PI-0002).</li> <li>c) The Performer shall transmit the <code>AcknowledgedReturn</code> prior to transmitting the <code>SuccessfulReturn</code> or <code>FailedReturn*</code> message (see 3PP-0103).</li> <li>d) The Performer shall start a local disposition timer for the operation and set it to timeout with sufficient lead time before the <code>expectedDispositionTime</code> to allow the final return for the operation to be received by the Invoker prior to the <code>expectedDispositionTime</code>.</li> </ol> <p>NOTES</p> <ol style="list-style-type: none"> <li>1 In order for the Performer to ensure that any return to an <code>Invocation</code> arrives at the Invoker before the specified <code>expectedDispositionTime</code>, it is assumed that the Performer adjusts (i.e., shortens) its local disposition timer value by some amount of time to compensate for the transit of the return across the communications network that connects them. The method by which the Performer determines this adjustment factor is outside the scope of this Recommended Standard.</li> <li>2 It is assumed that the time standards upon which the Invoker and Performer set their disposition timers are synchronized to within one (1) second of each other. If this assumption cannot be made for a particular pair of Invoker and Performer, then additional methods may be required to compensate for the ambiguity (such as further decreasing the Performer's disposition timer value to account for the ambiguity). Any such adjustment for time standard ambiguity is outside the scope of this Recommended Standard.</li> </ol>
3PP-0103	<p>The Performer shall perform operation-specific service management validation on the <code>Invocation</code>.</p> <ol style="list-style-type: none"> <li>a) If the <code>Invocation</code> passes service management validation, the Performer shall perform the operation and generate and transmit a <code>SuccessfulReturn</code> to the Invoker's message set port in accordance with the Sender Requirements for the SM Document Exchange Protocol as defined in 3.3.4.1. The parameters of the <code>SuccessfulReturn</code> are operation-specific. NOTE – The Performer may perform local functions specific to a successful operation as part of completing the operation procedure.</li> <li>b) If the invocation fails service management validation, the Performer shall cease interpreting and acting upon the <code>Invocation</code>, generate a <code>FailedReturn*</code>, and transmit the <code>FailedReturn*</code> to the Invoker's message set port in accordance with the Sender Requirements for the SM Document Exchange Protocol. NOTE – The Performer may perform local functions specific to a failed operation as part of completing the operation procedure.</li> </ol>

3PP-0104	<p>a) The Performer shall transmit the <code>SuccessfulReturn</code> or <code>FailedReturn</code> to the Invoker message set port before the expiration of the associated disposition timer.</p> <p>b) If the invoked operation cannot be successfully completed or failed for other reasons by the expiration of that timer, the Performer shall terminate the operation and return a <code>FailedReturn*</code> with diagnostic value <code>'operation timeout'</code>.</p>
3PP-0105	The Performer shall validate exception responses received from the Invoker on the exception response port in accordance with the Sender Requirements for the SM Document Exchange Protocol as defined in 3.3.4.1.
3PP-0106	<p>For each syntactically valid <b>UnrecognizedMessageSetResponse</b> received on the exception response port, the Performer shall attempt to correlate the content of the <b>UnrecognizedMessageSetResponse</b> with a return that was sent. If correlation is successful, the Performer shall notify the Invoker by other means of the contents of any return that was contained in a message set for which a valid <b>UnrecognizedMessageSetResponse</b> is received. The Invoker is not required to further interpret or act upon any <b>UnrecognizedMessageSetResponse</b> that cannot be correlated.</p> <p>NOTE – The Performer may also perform local functions to determine why the return was not validated by the Invoker.</p>

### 3.4.3 NOTIFY OPERATION PROCEDURE PATTERN

#### 3.4.3.1 General

The notify operation procedure pattern is used for an operation that one service management entity uses to notify another management entity that it has autonomously performed a management activity that affects services of interest to that other entity. An operation that is used to transfer the notification is called a *notify operation*. The entity that performs the autonomous activity and generates the notification is called the *Notifier*. The entity that receives the notification is called the *Recipient*. Because the notification is issued after the management activity has been performed, the Recipient cannot reject the performance of the management activity. However, the Recipient confirms to the Notifier that the notification has been received.

The notify operation procedure pattern specifies the messages exchanged between Notifier and Recipient associated with a notify operation, the activities of the Invoker and Performer in response to those messages, the time constraints under which those activities are to be carried out, and the behavior of the Notifier and Recipient if the time constraints are violated.

The notify operation procedure pattern begins with the Notifier performing a notify operation, generating the resultant `Notification` message, placing it in an **SmMessageSet**, transmitting the **SmMessageSet** to the Recipient's message set port using the SM document exchange protocol defined in 3.3, and starting the *confirmation timer* for the notification. The confirmation timer is set to the `confirmationTimeout` value specified for all confirmations in the Service Agreement.

Upon receipt of the **SmMessageSet** containing the `Notification`, the Recipient performs syntactic, authorization, and supported-operation validation as specified in the Receiver Requirements for the SM Document Exchange Protocol in table 3-3. If the **SmMessageSet** fails any of these validations, the Recipient generates and transmits an exception response containing an **UnrecognizedMessageSetResponse** or

**InvalidNotificationResponse** (as appropriate to the exception) to the Notifier's exception response port, as specified in 3.3.

If the `Notification` message passes syntactic, authorization, and supported-operation validation, the Recipient performs service management validation on the `Notification`. The details of service management validation are specific to each notify operation, and are specified in the associated Notifier and Recipient requirements for each notify operation. If the `Notification` is valid at the service management level, the Recipient returns a `Confirmation` message to the Notifier's message set port.

Upon receipt of the `SmMessageSet` containing the `Confirmation`, the Notifier performs syntactic and authorization validation as specified in the Receiver Requirements for the SM Document Exchange Protocol in table 3-3. If the `Confirmation` is valid at the service management level, the Notifier successfully completes the notify operation procedure. If the `SmMessageSet` fails syntactic or authorization validation, the Notifier generates and transmits an **UnrecognizedMessageSetResponse** to the Recipient's exception response port as specified in 3.3. If the `Confirmation` message fails service management validation, the message is deemed invalid and the Notifier is not required to interpret or act upon the message any further.

NOTE – The failure of syntactic or authentication validation of an **UnrecognizedMessageSetResponse**, an **InvalidNotificationResponse**, or a `Confirmation` from the Recipient will eventually result in the expiration of the associated disposition timer, which results in the Notifier's informing the Recipient of the event by other means.

If the Notifier does not receive a validated `Confirmation` before the confirmation timer for that notification expires, the Notifier informs the Recipient of the information contained in the `Notification` and completes the procedure.

### 3.4.3.2 Sequence Diagram

Figure 3-26 is the sequence diagram for the notify operation procedure pattern. It is composed of multiple instances of the Send Message sequence specified in figure 3-4.

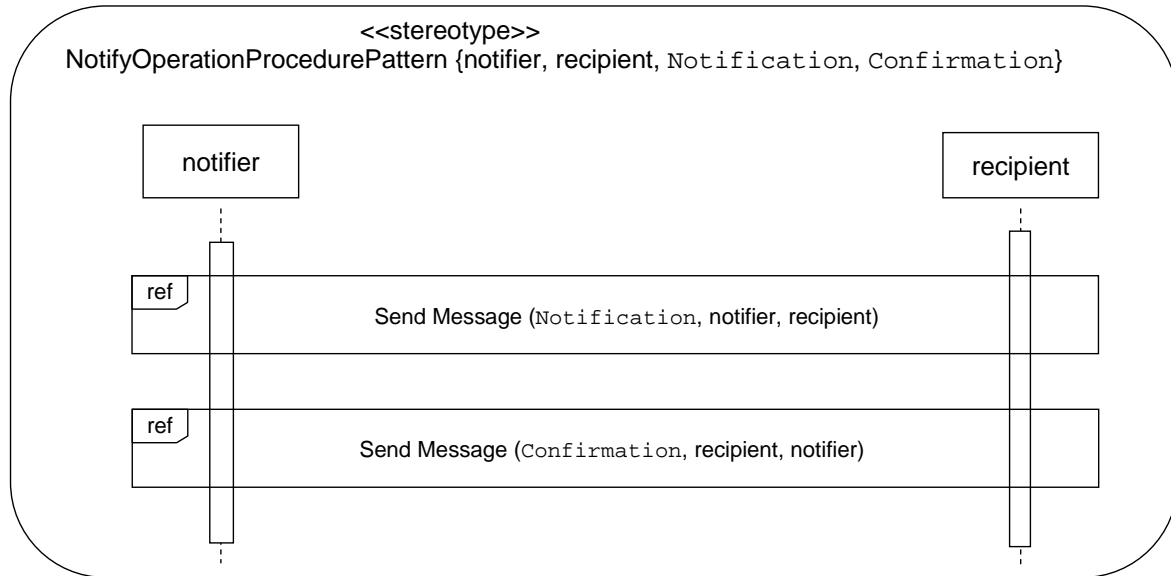

**Figure 3-26: Sequence Diagram for Notify Operation Procedure Pattern**

### 3.4.3.3 State Machines

Figures 3-27 and 3-28 are the state diagrams for the notify operation procedure pattern from the points of view of the operation Notifier and Receiver, respectively. Tables 3-37 and 3-38 are the corresponding state tables. In the figures and tables: *op\_N* represents the notification of the operation, and *op\_C* represents the confirmation of receipt of the notification.

Only SM messages which have already passed validation at the level of the Document Exchange Protocol (syntactical, authentication, and supported-operation) enter into the state machine for the Notify Operation Procedure Pattern. In addition, responses must be correlated with preceding messages (by sequence number) in order to be associated to any operation and enter into the state machine; if not correlated, they are discarded.



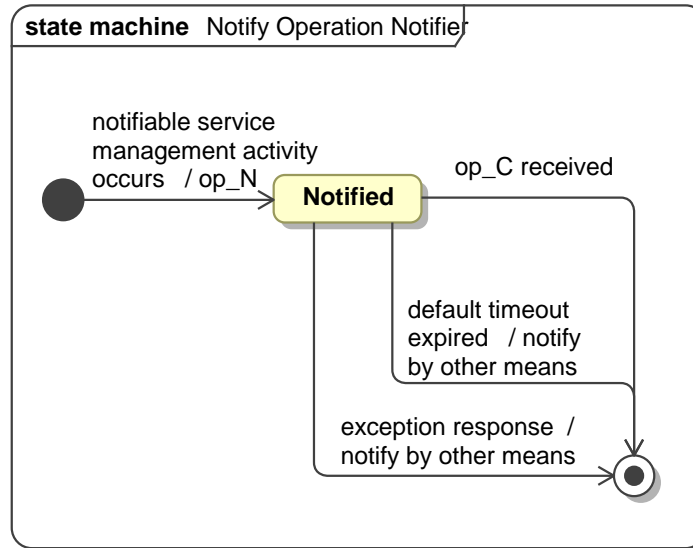

Figure 3-27: State Diagram for Notify Operation Pattern—Notifier View

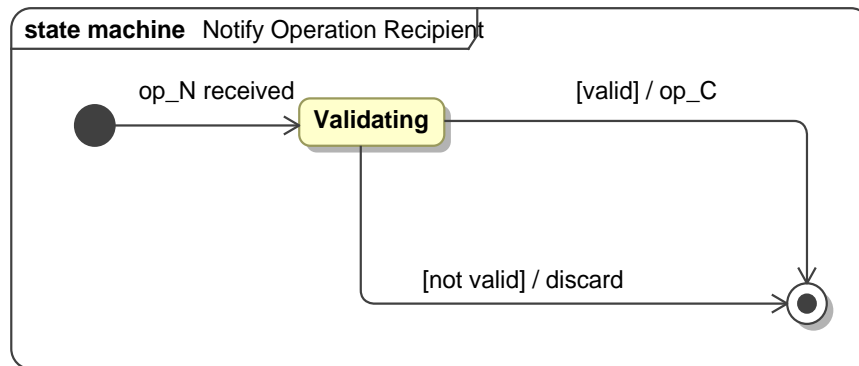

Figure 3-28: State Diagram for Notify Operation Pattern—Recipient View

Table 3-37: State Table for Notify Operation—Notifier View

State	Initial	Notified
<b>Event</b>		
notifiable service management event occurs	<i>op-N</i> -> Notified	-
<i>op-C</i>	-	-> Final
Exception response	-	Contact Recipient -> Final
Notify Op Timeout	-	Contact Recipient -> Final

**Table 3-38: State Table for Notify Operation Pattern—Recipient View**

Event	State	
	Initial	Validating
<i>op-N</i> received	-> Validating	-
Validation complete: valid	-	<i>op-C</i> -> Final
Validation complete: not valid	-	discard -> Final

#### 3.4.3.4 Activity Diagram

Figure 3-29 is the activity diagram for the notify operation procedure pattern.

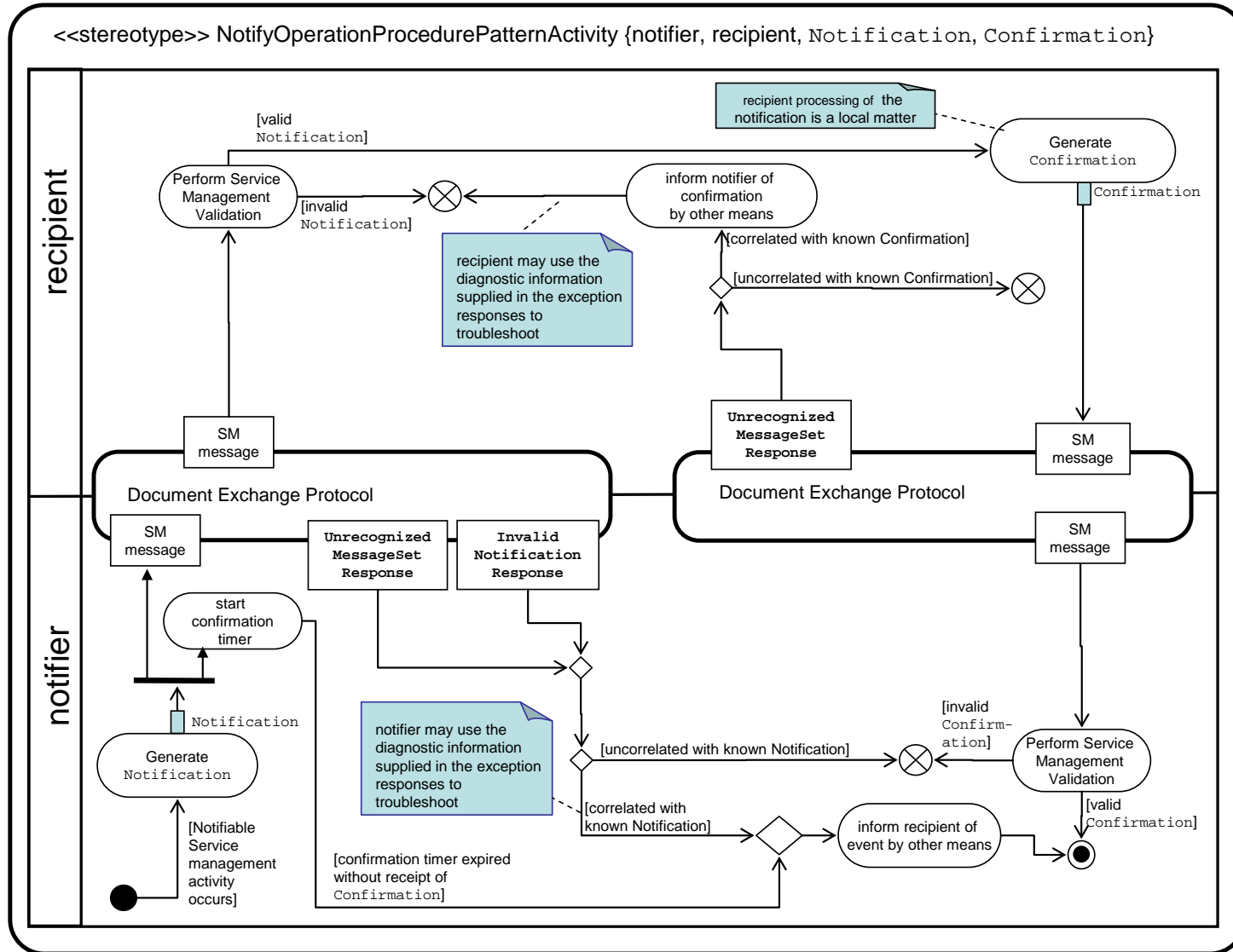

Figure 3-29: Notify Operation Procedure Pattern Activity Diagram

### 3.4.3.5 Requirements

#### 3.4.3.5.1 Notifier Requirements for Notify Operation Procedures

The common Notifier requirements for all notify operations are defined in table 3-39.

**Table 3-39: Notifier Requirements for the Notify Operation Procedures**

CNN-0001	The Notifier shall format the <code>Notification</code> and transmit it to the Recipient's message set port in conformance with the Sender Requirements for the SM Document Exchange Protocol (3.3.4.1).
CNN-0002	The Notifier shall set the confirmation timer to the value of the <code>messageTimestamp</code> of the <code>Notification</code> message plus the <code>confirmationTimeout</code> for the referenced Service Agreement.
CNN-0003	The Notifier shall validate a <code>Confirmation</code> received from the Recipient in accordance with the Receiver Requirements for the SM Document Exchange Protocol.
CNN-0004	The Notifier shall validate exception responses received from the Recipient on the exception response port in accordance with the Sender Requirements for the SM Document Exchange Protocol.
CNN-0005	If a received <code>Confirmation</code> fails any service management validation requirement specified for its notify operation type, the <code>Confirmation</code> shall be deemed to be service management-invalid. The Notifier is not required to further interpret or act upon the service management-invalid <code>Confirmation</code> .
CNN-0006	For each syntactically valid <code>UnrecognizedMessageSetResponse</code> received on the exception response port, the Notifier shall attempt to correlate the content of the <code>UnrecognizedMessageSetResponse</code> with a <code>Notification</code> awaiting confirmation. If correlation is successful, the Notifier shall inform the Recipient, by bilaterally agreed means, of the operation that emitted the <code>Notification</code> . The Notifier is not required to further interpret or act upon any <code>UnrecognizedMessageSetResponse</code> that cannot be correlated. NOTES: 1 The means by which the Notifier informs the Recipient (e.g., attempt to retransmit the <code>Notification</code> vs. contact by voice) is a local matter and may depend on the operation with which the <code>Notification</code> is associated. 2 The Notifier may also perform other local functions as a result of the failure of the <code>Notification</code> .
CNN-0007	For each syntactically valid <code>InvalidNotificationResponse</code> received on the exception response port, the Invoker shall attempt to correlate the content of the <code>InvalidNotificationResponse</code> with a <code>Notification</code> awaiting confirmation. If correlation is successful, the Notifier shall inform the Recipient, by bilaterally agreed means, of the operation that emitted the <code>Notification</code> . The Notifier is not required to further interpret or act upon any <code>InvalidNotificationResponse</code> that cannot be correlated. NOTES: 1 The means by which the Notifier informs the Recipient (e.g., attempt to retransmit the <code>Notification</code> vs. contact by voice) is a local matter and may depend on the operation with which the <code>Notification</code> is associated. 2 The Notifier may also perform other local functions as a result of the failure of the <code>Notification</code> .
CNN-0008	The Notifier shall confirm that the <code>invocationMessageSequenceNumber</code> and <code>ServiceAgreementRef</code> parameters of a <code>Confirmation</code> match the <code>messageSequenceNumber</code> and <code>ServiceAgreementRef</code> , respectively, of a <code>Notification</code> for which the Notifier is awaiting a <code>Confirmation</code> , in order to associate a <code>Confirmation</code> with a <code>Notification</code> . NOTE – This is a necessary but not sufficient condition for acceptance of a <code>Confirmation</code> for a notification. There are additional operation-level matching criteria that must also be met, as specified under the requirements for the specific operations.

CNN-0009	If the Confirmation is valid at the service management level, the Notifier shall successfully complete the notify operation procedure. NOTE – The Notifier may perform local functions specific to a Confirmation as part of successfully completing the procedure (e.g., updating local databases to reflect success of the Notification).
CNN-0010	If a validated Confirmation is not received for a Notification by the time the associated confirmation timer expires, the Notifier shall inform the Recipient, by bilaterally agreed means, of the operation that emitted the Notification. NOTES 1 The means by which the Notifier informs the Recipient (e.g., attempt to retransmit the Notification vs. contact by voice) is a local matter and may depend on the operation with which the Notification is associated. 2 The Notifier may also perform other local functions as a result of the failure of the Notification (e.g., manually update local databases to reflect that the Recipient has been notified).

### 3.4.3.5.2 Recipient Requirements for Notify Operation Procedures

The common Recipient requirements for all notify operations are defined in table 3-40.

**Table 3-40: Recipient Requirements for the Notify Operation Procedures**

CNR-0101	The Recipient shall receive the Notification message and perform syntactic, authorization, and supported-operation validation in conformance with the Receiver Requirements for the SM Document Exchange Protocol (3.3.4.2).
CNR-0102	a) If the Notification message passes syntactic, authorization, and supported-operation validation as specified in CNR-0101, the Recipient shall generate and send a Confirmation message to the Recipient's message set port in accordance with the Sender Requirements for the SM Document Exchange Protocol. NOTE – The Recipient may perform local functions specific to a Notification as part of processing the Notification (e.g., updating local databases to reflect the Notification). b) If the Notification fails validation, the Recipient shall cease interpreting and acting upon the Notification and not send a Confirmation.
CNR-0103	The Recipient should transmit the Confirmation message such that the Recipient receives the Confirmation no later than the messageTimestamp of the Notification plus the value of the confirmationTimeout of the referenced Service Agreement.
CNR-0104	The Recipient shall validate exception responses received from the Notifier on the exception response port in accordance with the Sender Requirements for the SM Document Exchange Protocol.
CNR-0105	If a received Notification fails any service management validation requirement specified for its notify operation type, the Notification shall be deemed to be service management-invalid. The Recipient is not required to further interpret or act upon the service management-invalid Notification.
CNR-0106	For each syntactically valid <b>UnrecognizedMessageSetResponse</b> received on the exception response port, the Recipient shall attempt to correlate the content of the <b>UnrecognizedMessageSetResponse</b> with a Confirmation that was sent. If correlation is successful, the Recipient shall notify the Notifier by other means of the contents of any Confirmation that was contained in a message set for which a valid <b>UnrecognizedMessageSetResponse</b> is received. The Recipient is not required to further interpret or act upon any <b>UnrecognizedMessageSetResponse</b> that cannot be correlated. NOTE – The Recipient may also perform local functions to determine why the Confirmation was not validated by the Notifier).

## 4 SERVICE PACKAGE OPERATIONS

### 4.1 GENERAL

There are seven Service Package operations that CM can perform when invoked by UM:

- CREATE\_SERVICE\_PACKAGE (CSP)—to request creation of a Service Package at CM;
- REPLACE\_SERVICE\_PACKAGE (RSP)—to replace parameters or references in a scheduled Service Package at CM (this induces reprocessing by CM);
- DELETE\_SERVICE\_PACKAGE (DSP)—to delete a Service Package at CM;
- SELECT\_ALTERNATE\_SCENARIO (SAS)—to select an alternate scenario of a scheduled Service Package at CM;
- QUERY\_SERVICE\_PACKAGE (QSP)—to query the content of a scheduled Service Package at CM;
- APPLY\_NEW\_TRAJECTORY (ANT)—to apply a new trajectory prediction to a scheduled Service Package at CM;
- APPLY\_NEW\_SPACE\_LINK\_EVENTS\_PROFILE (ANSLEP)—to apply a new Space Link Events Profile to a scheduled Service Package at CM.

There are two Service Package operations that CM can perform autonomously and notify UM:

- SERVICE\_PACKAGE\_CANCELLED (SPC)—to notify the UM of a cancelled (by CM) Service Package;
- SERVICE\_PACKAGE\_MODIFIED (SPM)—to notify the UM of a modification (by CM) to a Service Package.

There is one Service Package operation that UM can perform when invoked by CM:

- CONFIRM\_TENTATIVE\_SERVICE\_PACKAGE (CTSP)—to request that UM confirm acceptance of a Service Package that has been proposed by CM based on rules previously specified by UM.

### 4.2 LIFECYCLE AND OWNERSHIP OF A SERVICE PACKAGE

#### 4.2.1 LIFECYCLE

The lifecycle of a service package, as created and held by CM, is modeled as a state machine and is shown in figure 4-1 through figure 4-3, and in table 4-1.

Any service management messages which fail validation at the level of the Document Exchange Protocol are never associated to a Service Package, cannot affect the state of a Service Package, and do not appear in the state machine.

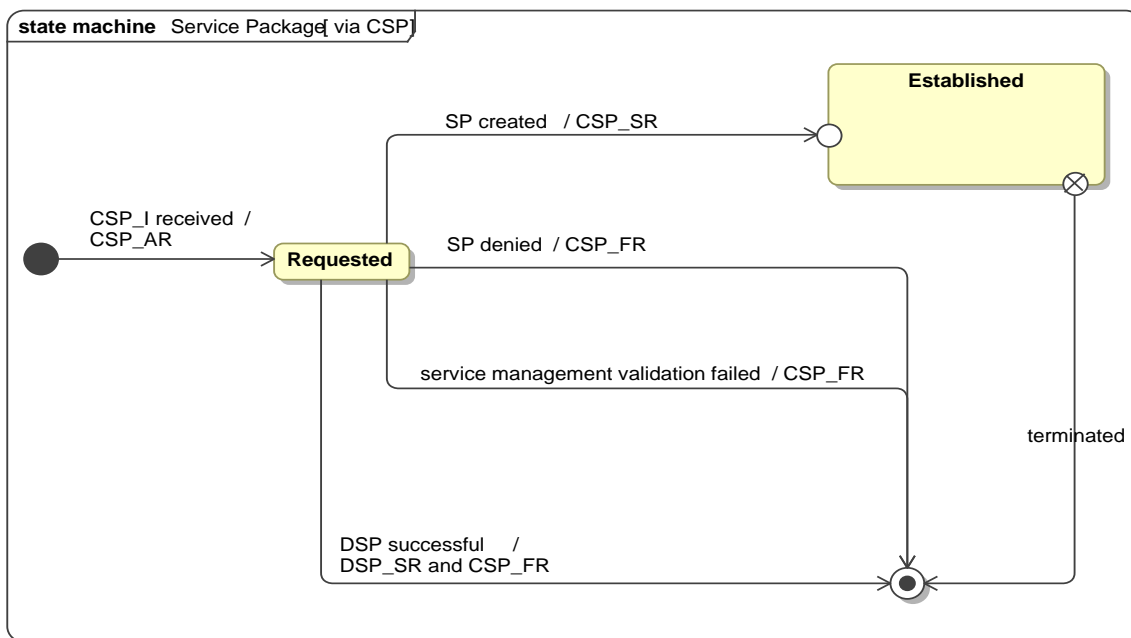

Figure 4-1: Service Package created via CSP operation

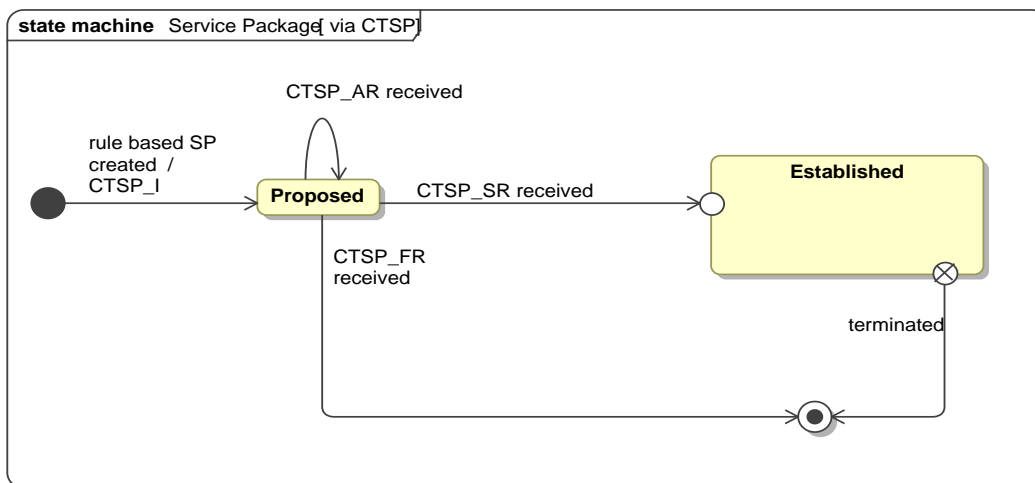

Figure 4-2: Service Package created via CTSP operation

When a service package reaches the final state, all references from the service package to other persistent information entities (the different configuration profiles defined in section 5, and trajectory predictions defined in section 6) shall be removed. A service package is not required to be maintained by CM once it reaches the final state. However, the

servicePackageId must be recorded in some form because it is required to be unique throughout the Service Agreement period.

Once a service package has been created, the remaining lifecycle, shown in figures 4-3 and 4-4, is independent of the operation that caused it to be created. The Executing state is the state of the Service Package when it is in the Utilization Phase, as defined in reference [1]).

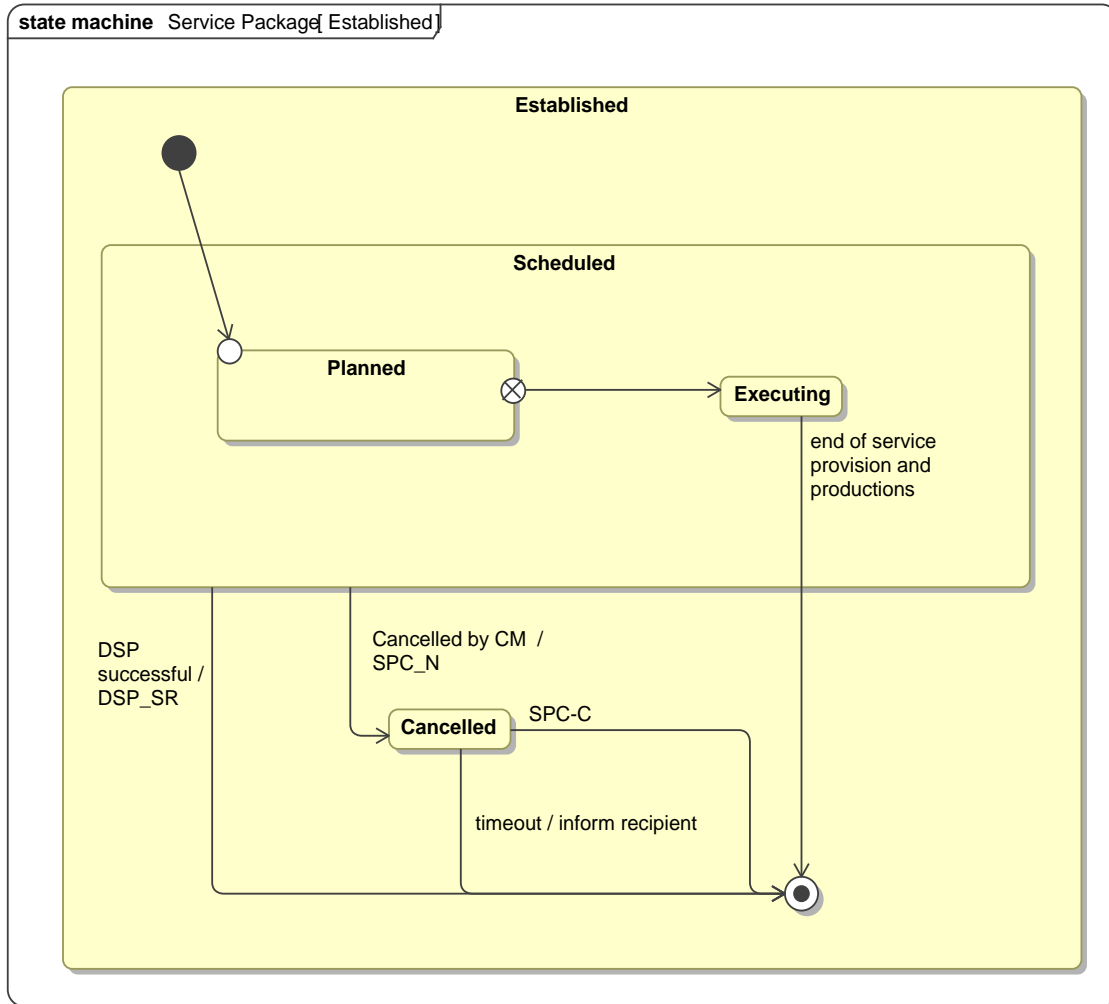
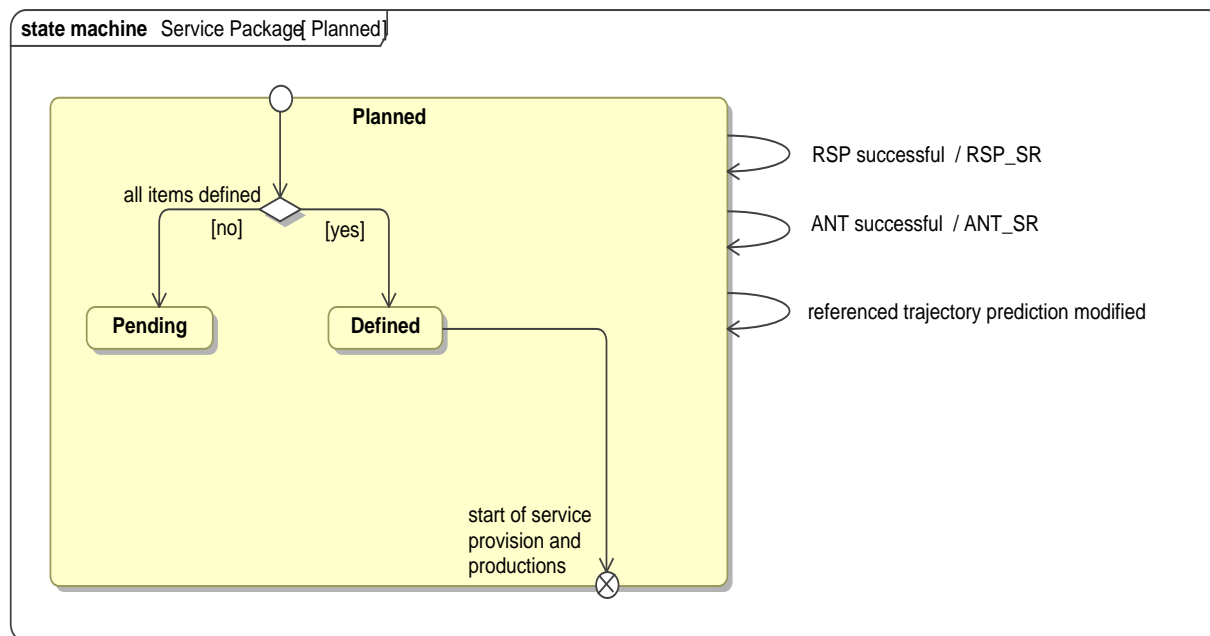

Figure 4-3: State Diagram for Established Service Package





**Figure 4-4: State Diagram for Planned Service Package**

The lifecycle shall apply to all Service Packages, whether for space link sessions or retrieval transfer services.

**Table 4-1: Service Package Lifecycle State Table, Part 1**

States Events	Initial	Proposed	Requested	Established			Cancelled
				Scheduled		Executing	
				Planned			
				Pending	Defined		
<b>Rule-based SP created</b>	CTSP-I -> Proposed	*	*	*		*	
<b>CTSP-AR received</b>	*	(no change)	*	*		*	
<b>CTSP-SR received</b>	*	-> Planned	*	*		*	
<b>CTSP-FR received</b>	*	-> Final	*	*		*	
<b>CSP-I received</b>	CSP-AR -> Requested	*	*	*		*	
<b>SP created</b>	*	*	[all items defined] CSP-SR -> Defined	*		*	
			else CSP-SR -> Pending				
<b>SP denied</b>			CSP-FR -> Final				
<b>Service mgmt validation failed</b>	*	*	CSP-FR -> Final	*		*	
<b>RSP successful</b>	*	*	*	[all items defined] RSP-SR -> Defined	*	*	
				else RSP-SR -> Pending			
<b>ANT successful</b>	*	*	*	[all items defined] ANT-SR -> Defined	ANT-SR -> Executing	*	
				else ANT-SR -> Pending			

**Table 4-1A: Service Package Lifecycle State Table, Part 2**

States \ Events	Initial	Proposed	Requested	Established				
				Scheduled			Executing	Cancelled
				Planned				
				Pending	Defined			
<b>Referenced trajectory prediction modified</b>	*	*	*	[all items defined] -> Defined else -> Pending		-> Executing	*	
<b>DSP successful</b>	*	*	CSP-FR, DSP-SR-> Final	DSP-SR -> Final			*	
<b>Cancelled by CM</b>	*	*	*	SPC-N -> Cancelled			*	
<b>SPC-C</b>	*	*	*	*			-> Final	
<b>Timeout after SPC-N</b>	*	*	*	*			Inform recipient -> Final	
<b>Svc provision &amp; production start</b>	*	*	*	SPC-N -> Cancelled	-> Executing	*	*	
<b>Svc provision &amp; production stop</b>	*	*	*	*	*	-> Final	*	

Notes on the Service Package Lifecycle table:

- 1 For brevity, responses (e.g., CSP-AR, CSP-SR, and CSP-FR) are abbreviated to the suffix, where the operation is unambiguously identified by the invocation.
- 2 \* cannot happen; indicates protocol failure; reject.
- 3 Each transition to Planned goes to Defined if all items are defined, otherwise to Pending.
- 4 ‘all items defined’ is defined as:
  - a) `transferServicesDeferred` = false;
  - b) `sequenceOfEventsDeferred` is either NULL or has a value of false; and
  - c) the referenced Trajectory Prediction(s) is(are) available and is(are) suitable to support the Service Package.
- 5 The RSP, DSP, and ANT three-phase operations do not affect the SP lifecycle until (and unless) they are successfully performed. Service Management validation of RSP, DSP, and ANT invocations takes place independently of, and in parallel to, the state machine.
- 6 The event ‘cancelled by CM’ may be caused by (but is not limited to) any of the following:
  - if the Service Package has deferred parameters that are not supplied in a timely manner before the scheduled start time of the Service Package;
  - if any of the Complex resources needed to support the service package become unavailable;
  - if environmental conditions preclude production and provision of the services;
  - if the referenced Trajectory Prediction(s) is(are) not available in a timely manner before the scheduled start time of the Service Package.

#### 4.2.2 OWNERSHIP OF SERVICE PACKAGES

If the Service Package is originally created via an invocation of the `CREATE_SERVICE_PACKAGE` operation, the Service Package shall be owned by the UM entity associated with the `smSource` used in the `SmMessageSet` that contains the `CreateServicePackageInvocation` message.

If the Service Package is originally created by CM via a rule-based process and proposed to UM via an invocation of the `CONFIRM_TENTATIVE_SERVICE_PACKAGE` operation, the Service Package shall be owned by the UM entity associated with the `proposedServicePackageOwnerName` specified in the Service Agreement.

### 4.3 CREATE\_SERVICE\_PACKAGE (CSP) OPERATION

#### 4.3.1 PURPOSE

The CREATE\_SERVICE\_PACKAGE (CSP) operation allows UM to request that CM add a Service Package to its operational schedule.

#### 4.3.2 PROCEDURE

**4.3.2.1** The CSP operation is defined to be a three-phase operation in accordance with the operation procedure pattern specified in 3.4.2.

**4.3.2.2** The CSP operation is defined in terms of the following messages:

- CreateServicePackageInvocation (CSP-I);
- CreateServicePackageAcknowledgedReturn (CSP-AR);
- CreateServicePackageSuccessfulReturn (CSP-SR);
- CreateServicePackageFailedReturn (CSP-FR).

**4.3.2.3** The message sequence diagram for the CREATE\_SERVICE\_PACKAGE operation is defined by applying the following argument list to the stereotyped sequence diagram for the three-phase operation procedure pattern specified in 3.4.2.2:

```
threePhaseOperationProcedurePatternSequence {UM, CM, CSP-I,
                                             CSP-AR, CSP-SR, CSP-FR}
```

**4.3.2.4** The activity diagram for the CREATE\_SERVICE\_PACKAGE operation is defined by applying the following argument list to the stereotyped activity diagram for the three-phase operation procedure pattern specified in 3.4.2.4:

```
threePhaseOperationProcedurePatternActivity {UM, CM, CSP-I,
                                              CSP-AR, CSP-SR, CSP-FR,
                                              cspRoutineTimeout,
                                              cspUrgentTimeout}
```

### 4.3.3 REQUIREMENTS

#### 4.3.3.1 UM Requirements for the **CREATE\_SERVICE\_PACKAGE** Operation

The UM requirements for the **CSP** operation are defined in table 4-2.

**Table 4-2: UM Requirements for the CSP Operation**

CSPU-1	UM shall conform to all Invoker Requirements for Three-Phase Operation Procedures as specified in 3.4.2.5.1.
CSPU-2	UM shall conform to all <b>CSP-I</b> Data Set Composition and Relationship Requirements when creating and transmitting a <b>CSP-I</b> as specified in tables 4-15 and 4-16.
CSPU-3	UM should submit <b>CSP-I</b> messages that are valid with respect to all service management validation requirements for CM as defined in table 4-3.
CSPU-4	UM shall validate that a received <b>CSP-AR</b> , <b>CSP-SR</b> , or <b>CSP-FR</b> conforms to all <b>CSP-AR</b> , <b>CSP-SR</b> , or <b>CSP-FR</b> syntactic validation requirements specified in table 4-18 ( <b>CSP-AR</b> ), tables 4-39 and 4-40 ( <b>CSP-SR</b> ), or table 4-41 ( <b>CSP-FR</b> ), respectively. If the return fails any of the syntactic validation requirements, UM shall process the message set containing the syntactically invalid return in accordance with the Invoker Requirements for Three-Phase Operation Procedures.
CSPU-5	UM shall validate that a received <b>CSP-AR</b> , <b>CSP-SR</b> , or <b>CSP-FR</b> conforms to all <b>CSP-AR</b> , <b>CSP-SR</b> , or <b>CSP-FR</b> service management validation requirements specified in table 4-18 ( <b>CSP-AR</b> ), tables 4-39 and 4-40 ( <b>CSP-SR</b> ), or table 4-41 ( <b>CSP-FR</b> ), respectively. If the return fails any of the service management validation requirements, UM shall process the service management-invalid return in accordance with the Invoker Requirements for Three-Phase Operation Procedures.

#### 4.3.3.2 CM Requirements for the **CSP** Operation

The CM requirements for the **CSP** operation are defined in table 4-3.

**Table 4-3: CM Requirements for the CSP Operation**

CSPC-1	CM shall conform to all Performer Requirements for Three-Phase Operation Procedures as specified in 3.4.2.5.2.
CSPC-2	CM shall validate that a received <b>CSP-I</b> conforms to all <b>CSP-I</b> syntactic validation requirements specified in tables 4-17 and 4-19. If the <b>CSP-I</b> fails any of the syntactic requirements, CM shall process the message set containing the syntactically invalid invocation in accordance with the Performer Requirements for Three-Phase Operation Procedures.
CSPC-3	CM shall validate that the <b>CSP-I</b> conforms to all <b>CSP-I</b> service management validation requirements specified in this table and in tables 4-15 and 4-16. If the <b>CSP-I</b> fails any of the service management requirements, CM shall cease processing the <b>CSP-I</b> and respond to UM with a <b>CSP-FR</b> message. The content of the <b>CSP-FR</b> depends on the nature of the validation failure, and is specified in table 4-43.
CSPC-4	CM shall validate that each <b>CSP-I</b> parameter that is constrained by a Service Agreement parameter is consistent with the applicable Service Agreement parameter. [service management validation]

CSPC-5	CM shall validate that all <b>CSP-I</b> parameter values that are related to each other (as defined in the Data Set Composition and Relationship Requirements) contain mutually compatible values. [service management validation]
CSPC-6	If the Complex has locally defined <b>CSP-I</b> relationship requirements in addition to those specified in this Recommended Standard, CM shall validate that the <b>CSP-I</b> conforms to all such local requirements. [service management validation]
CSPC-7	If the Complex has locally defined <b>CSP-I</b> requirements in addition to those specified in this Recommended Standard that could cause a <b>CSP-I</b> to be denied, CM shall validate that the <b>CSP-I</b> conforms to all such local requirements. [service management validation]
CSPC-8	CM shall validate that the Service Package that would result from the <b>CSP-I</b> messages would not exceed the limits controlled by the following Service Agreement parameters: <ul style="list-style-type: none"> <li>a) <code>maxSlsServicePackages</code> (for an SLS Service Package);</li> <li>b) <code>maxSlsServicePackagesPerTimePeriod</code> (for an SLS Service Package);</li> <li>c) <code>maxRtrvlServicePackages</code> (for a Retrieval Service Package);</li> <li>d) <code>maxRtrvlServicePackagesPerTimePeriod</code> (for a Retrieval Service Package); and</li> <li>e) <code>maxInstancesOfTsType</code>.</li> </ul> [service management validation]
CSPC-9	If a <b>CSP-I</b> has an <code>urgent</code> parameter value of 'true', any related invocation in the same message set shall be treated as though its <code>urgent</code> parameter has the value 'true'. A 'related invocation' is one that adds a Space Communication Service Profile, Transfer Service Profile, Retrieval Transfer Service Profile, Space Link Events Profile, or Trajectory Prediction that is referenced by the <b>CSP-I</b> .
CSPC-10	If a <b>SpaceCommunicationServiceRequest</b> has the <code>transferServicesDeferred</code> parameter value = 'true', CM shall (a) ignore all transfer service mappings for purposes of validating the <b>SpaceCommunicationServiceRequest</b> and (b) not schedule and/or configure any of the transfer service instances associated with the referenced Space Communication Service Profile for the scenario with which the <b>SpaceCommunicationServiceRequest</b> is associated.
CSPC-11	For each <b>SpaceCommunicationServiceProfileRespecification</b> data set within a <b>SpaceCommunicationServiceRequest</b> data set, CM shall use the respecified parameter values in place of their original values in the referenced Space Communication Service Profile for the purposes of validating the <b>SpaceCommunicationServiceRequest</b> . The resultant respecified data set shall be used in the subsequent scheduling and configuring of the production and provision of the services associated with the referenced Space Communication Service Profile for the scenario with which the <b>SpaceCommunicationServiceRequest</b> is associated.
CSPC-12	If a <b>SpaceCommunicationServiceProfileRespecification</b> data set contains a <b>RespecifiedParameter</b> data set with the <code>parameterDistinguishedName</code> parameter naming the <code>instanceEnabled</code> parameter of a default transfer service mapping and <code>parameterValue</code> = 'false', CM shall ignore that transfer service mapping for purposes of validating the <b>SpaceCommunicationServiceRequest</b> . The resultant respecified data set shall be used in the subsequent scheduling and configuring of the transfer service instances for that space link service for that scenario.
CSPC-13	If a <b>SpaceCommunicationServiceProfileRespecification</b> data set contains a <b>RespecifiedParameter</b> data set with the <code>parameterDistinguishedName</code> parameter naming the <code>instanceEnabled</code> parameter of a default data sink mapping and the <code>parameterValue</code> = 'false', CM shall ignore the data sink mapping for purposes of validating the <b>SpaceCommunicationServiceRequest</b> . The resultant respecified data set shall be used in the subsequent scheduling and configuring of that data sink instance for that space link service for that scenario.
CSPC-14	For each <b>SlsTsProfileRespecification</b> data set, CM shall use the respecified parameter values in place of their original values in the referenced Transfer Service Profile for the purposes of validating all <b>SpaceCommunicationServiceRequest</b> transfer service mappings that reference

	that Transfer Service Profile. The resultant respecified data set shall be used in the subsequent scheduling and configuring of the transfer service instance that is based on that Transfer Service Profile.
CSPC-15	For each <b>RetrievalTsProfileRespecification</b> data set, CM shall use the respecified parameter values in place of their original values in the referenced Retrieval Transfer Service Profile for the purposes of validating the <b>RetrievalTsInstanceRequest</b> that references that Retrieval Transfer Service Profile. The resultant respecified data set shall be used in the subsequent scheduling and configuring of the retrieval transfer service instance that is based on that Retrieval Transfer Service Profile.
CSPC-16	<p>a) For each <b>SpaceCommunicationServiceRequest</b> data set, CM shall validate that:</p> <ol style="list-style-type: none"> <li>1) at least one conformant resource configuration as defined in b), below, can be made available for the complete requested space communication service period as defined in c), below; or</li> <li>2) if handovers are permitted, that a set of conformant resource configurations can be made available that: <ol style="list-style-type: none"> <li>i) collectively span the requested space communication service period; and</li> <li>ii) mutually overlap each other by at least the minimum handover overlap specified in the <b>handoverOverlap</b> parameter of the Service Agreement.</li> </ol> </li> </ol> <p>b) A ‘conformant resource configuration’ is defined as a configuration of resources that will be available for the required time span in which:</p> <ol style="list-style-type: none"> <li>1) the antenna satisfies all selection constraints imposed on it in the <b>SpaceCommunicationServiceRequest</b> data set; i.e.: <ol style="list-style-type: none"> <li>i) if the <b>SpaceCommunicationServiceRequest</b> data set contains <b>Antenna</b> data sets that designate both ‘acceptable’ and ‘preferred’ antennas, the antenna must be one of the acceptable or preferred antennas;</li> <li>ii) if the <b>SpaceCommunicationServiceRequest</b> data set does not contain any <b>Antenna</b> data sets that designate ‘acceptable’ antennas, the antenna must be one of the supporting antennas specified in the Service Agreement;</li> <li>iii) if the <b>SpaceCommunicationServiceRequest</b> data set contains any <b>Antenna</b> data sets that designate ‘unacceptable’ antennas, the antenna must not be one of the unacceptable antennas;</li> </ol> </li> <li>2) the antenna has the aperture and associated resources to provide the required link margins (i.e., sufficient signal strength to support the symbol rate(s) indicated by the <b>spaceCommunicationServiceProfileRef</b>);</li> <li>3) the service production and transfer service provision resources required to provide the enabled transfer services specified in the referenced Space Communication Service Profiles are available for use with that antenna;</li> <li>4) the antenna has either a continuous or intermittent view of the spacecraft during the duration of the conformant resource configuration;</li> <li>5) the antenna is available for use (i.e., not otherwise committed) for the duration of the conformant resource configuration;</li> <li>6) the production resources required by each carrier requested in the <b>SpaceCommunication-ServiceRequest</b> are available such that the total requested duration of that carrier can be supported by the set of conformation resource configurations, where the ‘total requested duration of a carrier’ is the time span from the beginning of the requested space communication service period plus the <b>carrierStartTimeOffset</b> to the end of the requested space communication service period minus <b>carrierStopTimeOffset</b> for that carrier (where <b>carrierStartTimeOffset</b> and <b>carrierStopTimeOffset</b> are specified in the corresponding Space Link Carrier Profile component of the referenced Space Communication Service Profile);</li> <li>7) the resources needed to support each enabled SLS transfer service instance are available for use from the beginning of the conformant resource configuration plus the <b>startTimeOffset</b> to the end of the conformant resource configuration plus <b>stopTimeOffset</b> for that transfer service (where <b>startTimeOffset</b> and</li> </ol>



	<p>stopTimeOffset are specified in the corresponding transfer service mapping component of the referenced Space Communication Service Profile);</p> <p>c) the ‘requested space communication service period’ is a time period that starts at some time between (spaceCommServiceStartTime – spaceCommServiceStartTimeLead) and (spaceCommServiceStartTime + spaceCommServiceStartTimeLag), and has a duration of at least the minimumServiceDuration, as specified in the <b>SpaceCommunicationServiceRequest</b> data set.</p> <p>NOTE – An intermittent view may occur if the spacecraft is occulted by a celestial body. [service management validation]</p>
CSPC-17	<p>For each <b>SpaceCommunicationServiceRequest</b> data set that contains a <b>SpaceLinkEventsProfileReference</b> data set, CM shall validate that each carrier profile referenced by the Space Link Events Profile corresponds to one of the carriers of the referenced Space Communication Service Profile. [service management validation]</p>
CSPC-18	<p>For each <b>RetrievalTsInstanceRequest</b> data set, CM shall validate that the accessStartTime is greater than the serviceAgreementStartTime and the accessStopTime is less than the serviceAgreementStopTime. [service management validation]</p>
CSPC-19	<p>CM shall validate that resources are projected to be available to support all scenarios and retrieval transfer service instances of the <b>CSP-I</b>. [service management validation]</p>
CSPC-20	<p>If CM is unable to validate and perform the CSP operation prior to expiration of minServiceDefinitionLeadTime, CM may terminate the operation and issue a <b>CSP-FR</b>. [service management validation]</p>
CSPC-21	<p>If the <b>DSP</b> operation is invoked on the Service Package before the performance of the <b>CSP</b> operation has completed, CM shall terminate the <b>CSP</b> operation and issue a <b>CSP-FR</b>. [service management validation]</p>
CSPC-22	<p>For each Space Communication Service Request in a valid <b>CSP-I</b> for which a single conformant resource configuration exists, as validated in accordance with CSPC-16 (b), CM shall schedule the resources and create a single Space Communication Service Result in accordance with the referenced profiles, such that:</p> <ol style="list-style-type: none"> <li>the set of resources constitutes a conformant resource configuration as defined in CSPC-16 (b);</li> <li>if one or more preferred antennas are specified in the Space Communication Service Request and at least one conformant resource configuration exists that uses one of the preferred antennas, one of the conformant resource configurations that uses a preferred antenna is scheduled;</li> <li>the scheduledSpaceCommServiceStartTime of the Space Communication Service Result is later than or equal to (spaceCommServiceStartTime – spaceCommServiceStartTimeLead) of the Space Communication Service Request and earlier than or equal to (spaceCommServiceStartTime + spaceCommServiceStartTimeLag);</li> <li>the scheduledSpaceCommServiceStopTime of the Space Communication Service Result is later than or equal to (scheduledSpaceCommServiceStartTime + minimumServiceDuration) and earlier than or equal to (scheduledSpaceCommServiceStartTime + preferredServiceDuration) of the Space Communication Service Request;</li> <li>the scheduledCarrierStartTime for each carrier included in the Space Communication Service Result shall be equal to the scheduledSpaceCommServiceStartTime of the Space Communication Service Result with which it is associated plus the carrierStartTimeOffset specified for that carrier in the referenced Space Link Carrier Profile;</li> <li>the scheduledCarrierStopTime for each carrier included in the Space Communication Service Result shall be equal to the scheduledSpaceCommServiceStopTime for the Space Communication Service Result with which it is associated plus the</li> </ol>

	<p>carrierStopTimeOffset specified for that carrier in the referenced Space Link Carrier Profile;</p> <p>g) The difference between the values of the scheduledServicePackageStartTime and the scheduledServicePackageStopTime shall be less than maxServicePackageTemporalSpan;</p> <p>h) For each <b>ServiceScenarioResult</b> data set, the difference between the values of the earliest scheduledSpaceCommServiceStartTime and the scheduledSpaceCommServiceStopTime, for all <b>SpaceCommunicationServiceResult</b> data sets contained by that <b>ServiceScenarioResult</b> data set, shall be less than maxServiceScenarioTemporalSpan.</p> <p>[perform operation]</p>
<p>CSPC-23</p>	<p>For each Space Communication Service Request in a valid <b>CSP-I</b> for which a single conformant resource configuration exists, as validated in accordance with CSPC-16 b), CM should schedule the resources and create the Space Communication Service Result such that:</p> <p>a) the scheduledSpaceCommServiceStartTime is as close to the requested spaceCommServiceStartTime as possible;</p> <p>b) the difference between the scheduledSpaceCommServiceStartTime and the scheduledSpaceCommServiceStopTime of the scheduled Space Communication Service Session is as close to preferredServiceDuration as possible.</p> <p>[perform operation]</p>
<p>CSPC-24</p>	<p>For each Space Communication Service Request in a valid <b>CSP-I</b> for which handovers are permitted, CM may schedule the resources to create multiple Space Communication Service Results in accordance with the referenced profiles, such that:</p> <p>a) the set of scheduled resources associated with any one antenna constitutes a conformant resource configuration as defined in CSPC-16 b) and is scheduled as a separate Space Communication Service Result;</p> <p>b) if one or more preferred antennas are specified in the Space Communication Service Request and at least one conformant resource configuration exists that uses one of the preferred antennas, use of the conformant resource configurations that use preferred antennas is maximized;</p> <p>c) the scheduledSpaceCommServiceStartTime of the first scheduled Space Communication Service Result is greater than or equal to (spaceCommServiceStartTime – spaceCommServiceStartTimeLead) and less than or equal to (spaceCommServiceStartTime + spaceCommServiceStartTimeLag) of the Space Communication Service Request;</p> <p>d) the scheduledSpaceCommServiceStartTime of each intermediate scheduled Space Communication Service Result and of the last scheduled Space Communication Service Result overlaps the scheduledSpaceCommServiceStopTime of the scheduled Space Communication Service Result that immediately precedes it by at least the handoverOverlap specified in the Service Agreement;</p> <p>e) the scheduledSpaceCommServiceStopTime of the last scheduled Space Communication Service Result is greater than or equal to (scheduledSpaceCommServiceStartTime + minimumServiceDuration) and less than or equal to (scheduledSpaceCommServiceStartTime + preferredServiceDuration) of the Space Communication Service Request;</p> <p>f) each Space Communication Service Result schedules each carrier specified by the Space Communication Service Request to the extent that the time span of the Space Communication Service Result coincides with the total scheduled duration of the carrier, where:</p> <ol style="list-style-type: none"> <li>1) the time span of the Space Communication Service Result is bounded by the scheduledSpaceCommServiceStartTime and scheduledSpaceCommServiceStopTime of the Space Communication Service Result; and</li> <li>2) the total scheduled duration of the carrier begins at the scheduledSpaceCommServiceStartTime of the first Space Communication Service Result plus the carrierStartTimeOffset specified for that carrier in the referenced Space Link Carrier</li> </ol>

	<p>Profile, and ends at the <code>scheduledSpaceCommServiceStopTime</code> of the last Space Communication Service Result plus the <code>carrierStopTimeOffset</code> specified for that carrier in the referenced Space Link Carrier Profile;</p> <p>g) the difference between the values of the <code>scheduledServicePackageStartTime</code> and the <code>scheduledServicePackageStopTime</code> shall be less than <code>maxServicePackageTemporalSpan</code>;</p> <p>h) for each <b>ServiceScenarioResult</b> data set, the difference between the values of the earliest <code>scheduledSpaceCommServiceStartTime</code> and the <code>scheduledSpaceCommServiceStopTime</code>, for all <b>SpaceCommunicationServiceResult</b> data sets contained by that <b>ServiceScenarioResult</b> data set, shall be less than <code>maxServiceScenarioTemporalSpan</code>;</p> <p>i) if a <b>SpaceLinkEventsProfile</b> is referenced for any return carrier(s) having a <b>ReturnCoherenceModel</b> or <b>ReturnOffsetModel</b> data set, the <code>communicationMode</code> parameter of the referenced <b>SpaceLinkEventsProfile</b> shall be consistent with the handover times;</p> <p>j) if a <b>SpaceLinkEventsProfile</b> is referenced, the <b>[F R]SpaceLinkAvailableScheduledState</b> data sets shall contain only those <b>[F R]SpaceLinkAvailableState</b> data sets that coincide with the <code>scheduledCarrierStartTime</code> and <code>scheduledCarrierStopTime</code> for each handover, where coincidence is defined to include those <b>[F R]SpaceLinkAvailableState</b> data sets that are partially within the handover service instance that may begin earlier than the <code>scheduledCarrierStartTime</code> or extend later than the <code>scheduledCarrierStartTime</code> of the handover service instance.</p> <p>NOTE – Handover situations have the potential for inducing communication mode changes from 2-way to 3-way, etc., affecting return carriers that are generated in reference to a forward carrier.</p> <p>[perform operation]</p>
CSPC-25	<p>For each Space Communication Service Request in a valid <b>CSP-I</b> for which handovers are permitted, if a single conformant resource configuration does not exist but a set of conformant resource configurations does exist, as validated in accordance with CSPC-16 b), CM should schedule the resources to create multiple Space Communication Service Results such that:</p> <p>a) the <code>scheduledSpaceCommServiceStartTime</code> of the first scheduled Space Communication Service Result is as close to the requested <code>spaceCommServiceStartTime</code> of the Space Communication Service Request as possible;</p> <p>b) the difference between the <code>scheduledSpaceCommServiceStartTime</code> of the first scheduled Space Communication Service Result and the <code>scheduledSpaceCommServiceStopTime</code> of the last scheduled Space Communication Service Result is as close to <code>preferredServiceDuration</code> of the Space Communication Service Request as possible.</p> <p>[perform operation]</p>
CSPC-26	<p>If the <b>CSP-I</b> is valid and is for a Space Link Session Service Package, CM:</p> <p>a) shall reserve the resources to provide each enabled SLS transfer service instance in accordance with the referenced profile, such that:</p> <ol style="list-style-type: none"> <li>1) the <code>scheduledServiceInstanceStartTime</code> is equal to <code>scheduledCarrierStartTime</code> of the earliest-starting Space Link Carrier that contains that service instance, plus the <code>startTimeOffset</code> for that transfer service instance;</li> <li>2) the <code>scheduledServiceInstanceStopTime</code> is equal to <code>scheduledCarrierStopTime</code> of the latest-ending Space Link Carrier that contains that service instance, plus the <code>stopTimeOffset</code> for that transfer service instance;</li> </ol> <p>b) shall assign a <code>providerId</code> and <code>providerPortId</code> to each SLS transfer service instance;</p> <p>c) shall assign a unique (within the scope of the Service Package) Transfer Service Instance Number to each SLS transfer service instance;</p> <p>d) shall compute the <code>stateScheduledStartTime</code> for each <b>[R F]SpaceLinkAvailableScheduledState</b> and <b>[R F]SpaceLinkDataTransportScheduledState</b> data set referenced to a Space Link Events Profile with a <code>timeReference</code> value of 'relative' in the <b>CSP-I</b>. The <code>stateScheduledStartTime</code> shall be calculated by adding the <code>stateStartTime</code> of the corresponding <b>[R F]SpaceLinkAvailableState</b> or</p>

	<p>[R F]SpaceLinkDataTransportState (respectively) of the referenced Space Link Events Profile to the scheduledCarrierStartTime of the space link carrier with which the [R F]SpaceLinkEventsResult data set is associated;</p> <p>e) shall compute the stateScheduledEndTime for each [R F]SpaceLinkAvailable-ScheduledState and [R F]SpaceLinkDataTransportScheduledState data set referenced to a Space Link Events Profile with a timeReference value of 'relative' in the CSP-I. The stateScheduledEndTime shall be calculated by adding the stateEndTime of the corresponding [R F]SpaceLinkAvailableState or [R F]SpaceLinkData-TransportState (respectively) of the referenced Space Link Events Profile to the scheduledCarrierStartTime of the space link carrier with which the [R F]SpaceLinkEventsResult data set is associated;</p> <p>f) shall compute the eventScheduledTime for each [R F]SpaceLinkChange-ScheduledEvent and [R F]SpaceLinkDataTransportChangeScheduledEvent data set in the [R F]SpaceLinkEventsResult data set referenced to a Space Link Events Profile with a timeReference value of 'relative' in the CSP-I. The event-ScheduledTime shall be calculated by adding the eventTime of the corresponding [R F]SpaceLinkChangeEvent or [R F]SpaceLinkDataTransportChangeEvent (respectively) of the referenced Space Link Events Profile to the scheduledCarrierStart-Time of the space link carrier with which the [R F]SpaceLinkEventsResult data set is associated;</p> <p>g) shall issue a CSP-SR message specifying the parameters of the scheduled Service Package, and the scheduled times for the space link available, space link data transport, and associated events associated with the Space Link Session Service Package (if any).</p> <p>[perform operation]</p>
<p>CSPC-27</p>	<p>If the CSP-I is valid and is for a Retrieval Service Package, CM:</p> <p>a) shall reserve the resources to provide the retrieval transfer service instance in accordance with the referenced profile, such that:</p> <ol style="list-style-type: none"> <li>1) the scheduledAccessStartTime is equal to accessStartTime of the corresponding RetrievalTsInstanceRequest;</li> <li>2) the scheduledAccessStopTime is equal to accessStopTime of the corresponding RetrievalTsInstanceRequest; and</li> <li>3) the providerId and providerPortId are assigned;</li> </ol> <p>b) shall assign a unique (within the scope of the Service Package) Transfer Service Instance Number to the retrieval transfer service instance;</p> <p>c) shall issue a CSP-SR message specifying the scheduled access start and stop times associated with the transfer service instance.</p> <p>[perform operation]</p>
<p>CSPC-28</p>	<p>If the CSP-I is valid and is for a Space Link Session Service Package, CM shall:</p> <p>a) count the Service Package as applying against the following parameters of the Service Agreement:</p> <ol style="list-style-type: none"> <li>1) maxSlsServicePackages; and</li> <li>2) maxSlsServicePackagesPerTimePeriod;</li> </ol> <p>b) count the SLS Transfer Service instances of each transfer service type as applying against the maxInstancesOfTsType parameters for each transfer service type in the Service Agreement, applicable for the scheduled transfer service provision period of each instance.</p> <p>[perform operation]</p>

CSPC-29	<p>If the <b>CSP-I</b> is valid and is for a Retrieval Service Package, CM shall:</p> <ul style="list-style-type: none"> <li>a) count the Service Package as applying against the following parameters of the Service Agreement: <ul style="list-style-type: none"> <li>1) <code>maxRtrvlServicePackages</code>; and</li> <li>2) <code>maxRtrvlServicePackagesPerTimePeriod</code>;</li> </ul> </li> <li>b) count the SLS Transfer Service instances of each transfer service type as applying against the <code>maxInstancesOfTsType</code> parameters for each transfer service type in the Service Agreement, applicable for the scheduled transfer service provision period of each instance.</li> </ul> <p>[perform operation]</p>
CSPC-30	<p>CM shall conform to all <b>CSP-SR</b>, <b>CSP-FR</b>, and <b>CSP-AR</b> Data Set Composition and Relationship Requirements when creating and returning a <b>CSP-AR</b> (see table 4-18), <b>CSP-SR</b> (see table 4-41), and <b>CSP-FR</b> (see tables 4-39 and 4-40).</p>

#### 4.3.4 <<ServicePackageRequest>> STEREOTYPE

##### 4.3.4.1 General

The <<ServicePackageRequest>> stereotype specifies a collection of parameters, data sets, and data set relationships that are common among invocation messages that create or update Service Packages. The stereotype is applied in **CreateServicePackageInvocation** messages and **ReplaceServicePackageInvocation** messages, which are specified in subsequent subsections. An instantiation of the <<ServicePackageRequest>> stereotype is referred to as a `ServicePackageRequest`. Figure 4-5 shows the message structure of the <<ServicePackageRequest>> stereotype as a class diagram.

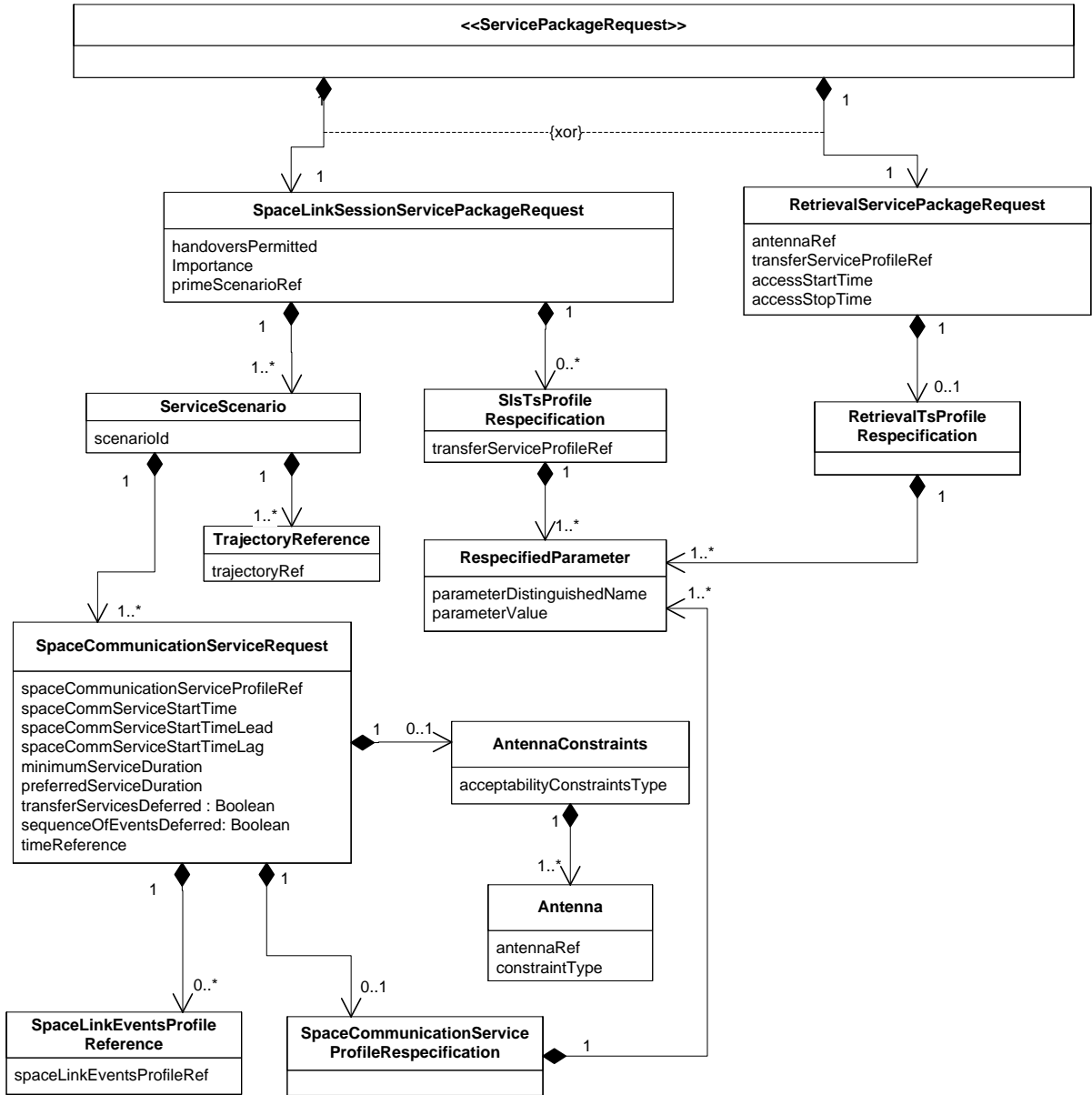

Figure 4-5: <<ServicePackageRequest>> Stereotype Structure Class Diagram

#### 4.3.4.2 Parameters

Tables 4-4 through 4-13 define the constituent data sets of the <<SpaceLinkSession-ServicePackageRequest>> stereotype, except for the **SpaceCommunication-ServiceProfileRespecification** and **RetrievalTsProfileRespecification** data sets, which have no parameters of their own and serves merely as containers for collections of **RespecifiedParameter** data sets.

**Table 4-4: SpaceLinkSessionServicePackageRequest Data Set**

Parameter Name	Parameter Definition/Description	Data Type	Data Units	Applicable Service Agreement Parameter
handoversPermitted	Indicates whether the Service Package may be satisfied by serial utilization of antennas: <ul style="list-style-type: none"> <li>– ‘true’—The Service Package may be satisfied by using two or more antennas per Space Communication Service Request;</li> <li>– ‘false’—The Service Package must use a single antenna per Space Communication Service Request.</li> </ul>	Boolean	n/a	handoversPermitted-Agreement
importance	Indicates the relative importance of this Service Package. The allowed content of this parameter (e.g., the number of importance levels and the syntax) is bilaterally agreed and documented in a document that is identified in the contractualReference parameter of the Service Agreement.  NOTE – The use of this parameter depends on the capabilities of the specific CM to support some form of relative importance, and may not be applicable to a CM.	String256	n/a	contractual-Reference
primeScenarioRef	Contains the value of a scenarioId of the scenario to be used in service initiation. NOTE – Continues as the scenario during service execution unless otherwise changed by UM via a SELECT_-ALTERNATE_SCENARIO operation.	String256	n/a	n/a

**Table 4-5: ServiceScenario Data Set (<<ServicePackageRequest>>)**

Parameter Name	Parameter Description/Definition	Data Type	Data Units	Applicable Service Agreement Parameter
scenarioId	Unique identifier, relative to the Service Package, for the scenario.	String256	n/a	n/a

**Table 4-6: TrajectoryReference Data Set (<<ServicePackageRequest>>)**

Parameter Name	Parameter Description/Definition	Data Type	Data Units	Applicable Service Agreement Parameter
trajectoryRef	Contains the value of the trajectoryId parameter of the Trajectory Prediction to be utilized in supporting the scenario.	String256	n/a	n/a

**Table 4-7: SpaceCommunicationServiceRequest Data Set  
(<<ServicePackageRequest>>)**

Parameter Name	Parameter Definition/Description	Data Type	Data Units	Applicable Service Agreement Parameter
spaceCommServiceStart-Time	Requested time to begin the space communication service for the given scenario. The start of the space communication service corresponds to the start of the first (earliest-starting) space link carrier being requested via the referenced Space Communication Service Profile for the given scenario.	UTC	n/a	maxServicePackage-TemporalSpan, maxServiceScenario-TemporalSpan, minService-DefinitionLeadTime
spaceCommServiceStart-TimeLag	Offset, relative to spaceCommServiceStart-Time, that indicates the latest time that the space communication service may begin.	Unsigned Integer	seconds	maxServicePackage-TemporalSpan, maxServiceScenario-TemporalSpan
spaceCommServiceStart-TimeLead	Offset, relative to spaceCommServiceStart-Time, that indicates earliest time that the space communication service may begin.	Unsigned Integer	seconds	maxServicePackage-TemporalSpan, maxServiceScenario-TemporalSpan
spaceCommunication-ServiceProfileRef	Contains the value of the spaceCommunicationServiceProfileId parameter of the Space Communication Service Profile to be utilized when providing services for the <b>SpaceCommunicationServiceRequest</b> .	String256	n/a	n/a
minimumServiceDuration	The minimum required duration of space communication service. If multiple carriers are being requested via the referenced Space Communication Service Profile, the value of minimumServiceDuration corresponds to the shortest duration that is viable for the carrier that requires the longest duration in the service. NOTES: 1 If multiple carriers are being requested via the referenced Space Communication Service Profile, a carrier may have duration shorter than minimumServiceDuration if its carrierStartTimeOffset and/or carrierStopTimeOffset are non-zero in the Space Communication Service Profile. 2 If there are to be multiple acquisitions and loss of signal (e.g., because of occulting planetary body) for a given carrier, this parameter indicates the minimum duration for the entire contact, including the intervening loss(es) of signal.	Positive Integer	seconds	maxServicePackage-TemporalSpan, maxServiceScenario-TemporalSpan
preferredServiceDuration	The preferred duration of the space communication service. If multiple carriers are being requested via the referenced Space Communication Service Profile, the value of preferredServiceDuration corresponds to the desired duration of the carrier that requires the longest duration in the service. NOTES: 1 This can also be thought of as a maximum acquisition contact duration desired by UM. 2 If there are multiple acquisitions and loss of signal (e.g., because of occulting planetary body) for a given carrier, this parameter indicates the preferred duration for the entire contact, including the intervening loss(es) of signal.	Positive Integer	seconds	maxServicePackage-TemporalSpan, maxServiceScenario-TemporalSpan



Parameter Name	Parameter Definition/Description	Data Type	Data Units	Applicable Service Agreement Parameter
sequenceOfEventsDeferred	<p>If Space Link Events Profiles are supported, indicates if the sequences of events are deferred from the initial version of the Service Package and are to be supplied at a later time:</p> <ul style="list-style-type: none"> <li>– ‘true’—the sequences of events are deferred (i.e., not included);</li> <li>– ‘false’—the sequence of events are not deferred (i.e., they are included).</li> </ul> <p>If Space Link Events Profiles are not supported, this parameter shall be NULL.</p>	Boolean or NULL	n/a	spaceLinkEvents-ProfilesSupported
timeReference	<p>If Space Link Events Profiles are used in this Space Communication Service Request, indicates whether the Events in the referenced Space Link Events Profiles are expressed in relative terms or absolute terms. Allowed values are:</p> <ul style="list-style-type: none"> <li>– ‘absolute’—All events are expressed in absolute time;</li> <li>– ‘relative’—All events are expressed in relative time.</li> </ul>	Enum	n/a	n/a
transferServicesDeferred	<p>Indicates if the transfer services are deferred from the initial version of the Service Package and are to be supplied at a later time:</p> <ul style="list-style-type: none"> <li>– ‘true’—the transfer services are deferred (i.e., not included);</li> <li>– ‘false’—the transfer services are not deferred (i.e., they are included).</li> </ul>	Boolean	n/a	

**Table 4-8: AntennaConstraints Data Set (<<ServicePackageRequest>>)**

Parameter Name	Parameter Definition/Description	Data Type	Data Units	Applicable Service Agreement Parameter
acceptabilityConstraintsType	<p>Specifies whether acceptability-related antenna constraints are specified. The values are:</p> <ul style="list-style-type: none"> <li>– ‘acceptable’—the list of antennas that may be used to support the Service Package is constrained to those that are designated as either preferred or acceptable in the list of constrained antennas;</li> <li>– ‘unacceptable’—the list of antennas that may be used to support the Service Package cannot include those that are designated as unacceptable in the list of constrained antennas;</li> <li>– ‘none’—no antenna acceptability constraints exist for the Service Package, only antenna preferences.</li> </ul>	Enum	n/a	n/a

**Table 4-9: Antenna Data Set (<<ServicePackageRequest>>)**

Parameter Name	Parameter Definition/Description	Data Type	Data Units	Applicable Service Agreement Parameter
antennaRef	Contains the value of an antenna identifier.	String256	n/a	AntennaId of one of the SupportingAntenna data sets
constraintType	Specifies the type of constraint that is associated with the named antenna. The values are: <ul style="list-style-type: none"> <li>– ‘preferred’—the named antenna is preferred for the Service Package;</li> <li>– ‘acceptable’—the named antenna is acceptable for the Service Package;</li> <li>– ‘unacceptable’—the named antenna is unacceptable for the Service Package.</li> </ul>	Enum	n/a	n/a

**Table 4-10: SLSProfilesRespecification Data Set (<<ServicePackageRequest>>)**

Parameter Name	Parameter Definition/Description	Data Type	Data Units	Applicable Service Agreement Parameter
transferServiceProfileRef	Contains the value of the transferServiceProfileId parameter of the SLS Transfer Service Profile that defines the configuration of the SLS Transfer Service to be enabled.	String256	n/a	n/a

**Table 4-11: RespecifiedParameter Data Set (<<ServicePackageRequest>>)**

Parameter Name	Parameter Definition/Description	Data Type	Data Units	Applicable Service Agreement Parameter
parameterDistinguishedName	Contains the distinguished name of the parameter within the referenced configuration profile for which the value is respecified for this Service Package.	String	n/a	n/a
parameterValue	Contains the respecified value of the named parameter within the referenced configuration profile.	String	n/a	n/a

**Table 4-12: SpaceLinkEventsProfileReference Data Set  
(<<ServicePackageRequest>>)**

Parameter Name	Parameter Definition/Description	Data Type	Data Units	Applicable Service Agreement Parameter
spaceLinkEventsProfileRef	Contains the value of a spaceLinkEventsProfileId (see table 5-58) of a Space Link Events Profile to be utilized in accommodating changes to the space link as a function of time, during the contact.	String256	n/a	n/a

**Table 4-13: RetrievalServicePackageRequest Data Set  
(<<ServicePackageRequest>>)**

Parameter Name	Parameter Definition/Description	Data Type	Data Units	Applicable Service Agreement Parameter
accessStartTime	Requested time to begin access to the DataStore for retrieval of data for delivery via the Retrieval Transfer Service instance.	UTC	n/a	
accessStopTime	Requested time to end access to the DataStore for retrieval of data.	UTC	n/a	
antennaRef	Contains the value of the antenna identifier associated with the DataStore from which this service instance is to retrieve data.	String256	n/a	AntennaId of one of the SupportingAntenna data sets
transferServiceProfileRef	Contains the value of the transferServiceProfileId parameter of the Retrieval Transfer Service Profile that defines the configuration of the Retrieval Transfer Service to be instantiated.	String256	n/a	n/a

#### 4.3.4.3 Data Set Composition and Relationship Requirements

Table 4-14 defines the data set composition and relationship requirements for the **ServicePackageRequest**.

**Table 4-14: Data Set Composition and Relationship Requirements for All Service-PackageRequests**

CSPD-1	A <b>ServicePackageRequest</b> shall contain one and only one of the following: a) a <b>SpaceLinkSessionServicePackageRequest</b> data set; or b) a <b>RetrievalServicePackageRequest</b> data set. [syntactic validation]
CSPD-2	A <b>SpaceLinkSessionServicePackageRequest</b> data set shall contain: a) one or more <b>ServiceScenario</b> data sets; and b) zero or more <b>SlTsProfileRespecification</b> data sets. [syntactic validation]

CSPD-3	The <code>primeScenarioRef</code> parameter shall contain the value of the <code>scenarioId</code> parameter of one of the <b>ServiceScenario</b> data sets. [service management validation]
CSPD-4	<p>a) The total number of <b>ServiceScenario</b> data sets shall not exceed <code>maxServiceScenariosPerServicePackage</code> of the Service Agreement;</p> <p>b) The minimally compliant time span of the Service Package shall not exceed <code>maxServicePackageTemporalSpan</code>, where the minimally compliant time span of the Service Package is the greater of:</p> <ol style="list-style-type: none"> <li>1) the largest <code>minimumServiceDuration</code> value for all <b>SpaceCommunication-ServiceRequest</b> data sets within all <b>ServiceScenario</b> data sets within the Service Package; and</li> <li>2) the difference between the latest allowable start time for all <b>SpaceCommunication-ServiceRequest</b> data sets within all <b>ServiceScenario</b> data sets within the Service Package and the earliest allowable stop time for all <b>SpaceCommunication-ServiceRequest</b> data sets within all <b>ServiceScenario</b> data sets within the Service Package, where <ol style="list-style-type: none"> <li>i) the latest allowable start time for a <b>SpaceCommunicationServiceRequest</b> data set is equal to the <code>spaceCommServiceStartTime</code> plus <code>spaceCommServiceStartTimeLag</code>; and</li> <li>ii) the earliest allowable stop time for a <b>SpaceCommunicationServiceRequest</b> data set is equal to the <code>spaceCommServiceStartTime</code> plus <code>spaceCommServiceStartTimeLead</code> plus <code>minimumServiceDuration</code>.</li> </ol> </li> </ol> <p>[service management validation]</p>
CSPD-5	The total number of transfer service instances enabled in the <code>ServicePackageInvocation</code> shall not exceed the <code>maxTransferServicesPerServicePackage</code> . [service management validation]
CSPD-6	Each <b>ServiceScenario</b> data set shall contain: <ol style="list-style-type: none"> <li>a) one or more <b>SpaceCommunicationServiceRequest</b> data sets;</li> <li>b) one or more <b>TrajectoryReference</b> data sets.</li> </ol> [syntactic validation]
CSPD-7	<p>For each <b>ServiceScenario</b> data set,</p> <ol style="list-style-type: none"> <li>a) the number of forward link carriers represented by the contained <b>SpaceCommunicationServiceRequest</b> data sets shall not exceed <code>maxForwardSpaceLinkCarriersPerScenario</code> of the Service Agreement;</li> <li>b) the number of return link carriers represented by the <b>SpaceCommunicationServiceRequest</b> data sets shall not exceed <code>maxReturnSpaceLinkCarriersPerScenario</code> of the Service Agreement;</li> <li>c) the minimally compliant time span of the Service Scenario shall not exceed <code>maxServiceScenarioTemporalSpan</code>, where the minimally compliant time span of the Service Scenario is the greater of: <ol style="list-style-type: none"> <li>1) the largest <code>minimumServiceDuration</code> value for all <b>SpaceCommunication-ServiceRequest</b> data sets within the <b>ServiceScenario</b> data set; and</li> <li>2) the difference between the latest allowable start time for all <b>SpaceCommunication-ServiceRequest</b> data sets within the <b>ServiceScenario</b> data set and the earliest allowable stop time for all <b>SpaceCommunicationServiceRequest</b> data sets within the <b>ServiceScenario</b> data set, where latest allowable start time and earliest allowable stop time are defined in CSPD-4;</li> </ol> </li> <li>d) a particular Space Link Session Transfer Service Profile may be referenced at most once. A Transfer Service Profile is considered to be referenced by a Service Scenario when a Space Communication Service Request that is part of that Service Scenario references a Space Communication Service Profile that contains a Carrier Profile that contains a transfer service mapping (TsM) to that Transfer Service Profile.</li> </ol> <p>[service management validation]</p>

CSPD-8	<p>Each <b>SpaceCommunicationServiceRequest</b> data set shall contain</p> <ul style="list-style-type: none"> <li>a) zero or one <b>AntennaConstraints</b> data set;</li> <li>b) zero or one <b>SpaceCommunicationServiceProfileRespecification</b> data set;</li> <li>c) zero or more <b>SpaceLinkEventSequenceReference</b> data sets.</li> </ul> <p>[syntactic validation]</p>
CSPD-9	<ul style="list-style-type: none"> <li>a) A <b>SpaceCommunicationServiceRequest</b> data set shall not contain any <b>SpaceLinkEventsProfileReference</b> data sets if the <code>sequenceOfEventsDeferred</code> parameter is either NULL or has a value of 'true', or if the <code>timeReference</code> parameter is NULL.</li> <li>b) If the <code>sequenceOfEventsDeferred</code> parameter is NULL the <code>timeReference</code> parameter shall be NULL.</li> </ul> <p>[service management validation]</p>
CSPD-10	<p>For each <b>SpaceCommunicationServiceRequest</b> data set, the <code>spaceCommunicationServiceProfileRef</code> shall have the value of a <code>SpaceCommunicationServiceProfileId</code> of an available Space Communication Service Profile within the context of the Service Agreement.</p> <p>[service management validation]</p>
CSPD-11	<p>The <b>AntennaConstraints</b> data set shall contain one or more <b>Antenna</b> data sets.</p> <p>[syntactic validation]</p>
CSPD-12	<p>Within the same <b>AntennaConstraints</b> data set, the value of the <code>antennaRef</code> parameter of any <b>Antenna</b> data set shall not equal the value of the <code>antennaRef</code> parameter of any other <b>Antenna</b> data set.</p> <p>[service management validation]</p>
CSPD-13	<p>If the <code>acceptabilityConstraintsType</code> parameter of the <b>AntennaConstraints</b> data set has the value 'acceptable', the <code>constraintType</code> parameter of every <b>Antenna</b> data set must have a value of either 'preferred' or 'acceptable'.</p> <p>[syntactic validation]</p>
CSPD-14	<p>If the <code>acceptabilityConstraintsType</code> parameter of the <b>AntennaConstraints</b> data set has the value 'unacceptable', the <code>constraintType</code> parameter of every <b>Antenna</b> data set must have a value of either 'preferred' or 'unacceptable'.</p> <p>[syntactic validation]</p>
CSPD-15	<p>If the <code>acceptabilityConstraintsType</code> parameter of the <b>AntennaConstraints</b> data set has the value 'none', the <code>constraintType</code> parameter of every <b>Antenna</b> data set must have the value 'preferred'.</p> <p>[syntactic validation]</p>
CSPD-16	<p>In each <b>SpaceLinkEventsProfileReference</b> data set:</p> <ul style="list-style-type: none"> <li>a) the <code>spaceLinkEventsProfileRef</code> parameter shall have the value of the <code>spaceLinkEventsProfileId</code> of a previously accepted Space Link Events Profile within the context of the Service Agreement;</li> <li>b) the <code>carrierProfileRef</code> parameter of the referenced Space Link Events Profile must have a value equal to the <code>carrierProfileId</code> parameter value of a <b>SpaceLinkCarrierProfile</b> data set contained in the Space Communication Service Profile referenced by the <code>spaceCommunicationServiceProfileRef</code> parameter of the containing <b>SpaceCommunicationServiceRequest</b> data set; and</li> <li>c) the <code>carrierProfileRef</code> parameter of the referenced Space Link Events Profile must not have a value equal to the <code>carrierProfileRef</code> parameter value of the Space Link Events Profile referenced by any other <b>SpaceLinkEventsProfileReference</b> data set contained by the same <b>SpaceCommunicationServiceRequest</b> data set.</li> </ul> <p>[service management validation]</p>

CSPD-17	<p>For each <b>SlsTsProfileRespecification</b> data set:</p> <ol style="list-style-type: none"> <li>a) the <code>transferServiceProfileRef</code> shall have the value of the <code>transferServiceProfileRef</code> of a concrete instance of <b>TsMap</b> in a Space Communication Service Profile that is referenced by the <code>SpaceCommunicationServiceProfileRef</code> of at least one <b>SpaceCommunicationServiceRequest</b> data set in the <code>ServicePackageRequest</code>;</li> <li>b) for each contained <b>RespecifiedParameter</b> data set: <ol style="list-style-type: none"> <li>1) the <code>parameterDistinguishedName</code> parameter shall name a parameter in the SLS Transfer Service Profile referenced in the containing <b>SlsTsProfileRespecification</b> data set;</li> <li>2) the value of the <code>parameterValue</code> parameter shall be a valid value for the parameter named by the <code>parameterDistinguishedName</code> parameter; and</li> <li>3) the <code>parameterDistinguishedName</code> parameter shall name a parameter that is identified as being respecifiable in the <code>contractualReference</code> parameter of the Service Agreement.</li> </ol> </li> </ol> <p>[service management validation]</p>
CSPD-18	<p>For each <b>RespecifiedParameter</b> data set in a <b>SpaceCommunicationServiceProfileRespecification</b> data set:</p> <ol style="list-style-type: none"> <li>a) the <code>parameterDistinguishedName</code> parameter shall name a parameter in the Space Communication Service Profile referenced by the containing <b>SpaceCommunicationServiceRequest</b> data set; and</li> <li>b) the value of the <code>parameterValue</code> parameter shall be a valid value for the parameter identified by the <code>parameterDistinguishedName</code> parameter;</li> <li>c) the <code>parameterDistinguishedName</code> parameter shall name a parameter that is identified as being respecifiable in the <code>contractualReference</code> parameter of the Service Agreement.</li> </ol> <p>[service management validation]</p>
CSPD-19	<p>Each <b>RetrievalServicePackageRequest</b> data set shall contain zero or one <b>RetrievalTsProfileRespecification</b> data set.</p> <p>[syntactic validation]</p>
CSPD-20	<p>For each <b>RetrievalServicePackageRequest</b> data set, the <code>transferServiceProfileRef</code> shall have the value of the <code>transferServiceProfileId</code> of an available Retrieval Transfer Service Profile in the context of the Service Agreement.</p> <p>[service management validation]</p>
CSPD-21	<p>For each <b>RespecifiedParameter</b> data set in a <b>RetrievalTsProfileRespecification</b> data set:</p> <ol style="list-style-type: none"> <li>a) the <code>parameterDistinguishedName</code> parameter shall name a parameter in the Space Communication Service Profile referenced by the containing <b>RetrievalTsInstanceRequest</b> data set; and</li> <li>b) the value of the <code>parameterValue</code> parameter shall be a valid value for the parameter identified by the <code>parameterDistinguishedName</code> parameter;</li> <li>c) the <code>parameterDistinguishedName</code> parameter shall name a parameter that is identified as being respecifiable in the <code>contractualReference</code> parameter of the Service Agreement.</li> </ol> <p>[service management validation]</p>

CSPD-22	<p>a) A <b>SpaceLinkSessionServicePackageRequest</b> data set may contain one or more <b>SlsTsProfileRespecification</b> data sets only if the <code>respecificationSupported</code> parameter of the Service Agreement has a value of 'true'.</p> <p>b) A <b>SpaceCommunicationServiceRequest</b> data set may contain one or more <b>SpaceCommunicationServiceProfileRespecification</b> data sets only if the <code>respecificationSupported</code> parameter of the Service Agreement has a value of 'true'.</p> <p>c) A <b>RetrievalServicePackageRequest</b> data set may contain one or more <b>RetrievalTsProfileRespecification</b> data sets only if the <code>respecificationSupported</code> parameter of the Service Agreement has a value of 'true'.</p> <p>[service management validation]</p>
CSPD-23	<p>For each <b>SpaceCommunicationServiceRequest</b> data set that contains one or more <b>SpaceLinkEventsProfileReference</b> data sets, the values of the <code>timeReference</code> parameters of all of the referenced Space Link Events Profiles must be equal to the value of the <code>timeReference</code> parameter of the <b>SpaceCommunicationServiceRequest</b> data set.</p> <p>[service management validation]</p>

### 4.3.5 CreateServicePackageInvocation (CSP-I) MESSAGE (UM → CM)

#### 4.3.5.1 General

The **CreateServicePackageInvocation** message conforms to the data set composition and relationship requirements for, and inherits the parameters of, the <<Invocation>> stereotype as specified in 3.3.5.3.2, the <<ServicePackageRequest>> stereotype as specified in 4.3.4. Figure 4-6 shows the structure of the **CreateServicePackageInvocation (CSP-I)** message as a class diagram.

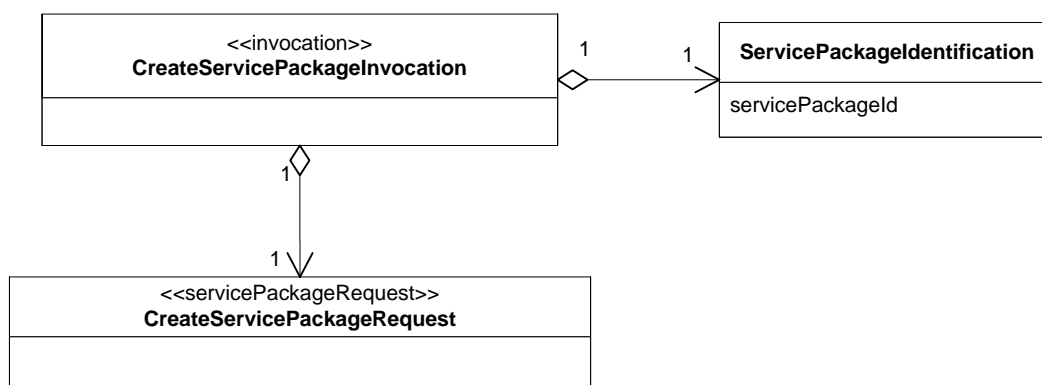

Figure 4-6: CSP-I Message Structure Class Diagram

#### 4.3.5.2 Parameters

Table 4-15 defines the parameters of the **ServicePackageIdentification** data set of the **CSP-I** message.

**Table 4-15: ServicePackageIdentification Data Set (CSP-I)**

Parameter Name	Parameter Definition/Description	Data Type	Data Units	Applicable Service Agreement Parameter
servicePackageId	Unique identifier, relative to the Service Agreement for the Service Package.	String256	n/a	n/a

**4.3.5.3 Data Set Composition and Relationship Requirements**

Table 4-16 defines the data set composition and relationship requirements for the **CSP-I** message that are in addition to those of the <<Invocation>>, and the <<ServicePackageRequest>> stereotypes.

**Table 4-16: Data Set Composition and Relationship Requirements for CSP-I**

CSPD-24	The <b>CSP-I</b> shall contain: a) one <b>ServicePackageIdentification</b> data set; and b) one <b>CreateServicePackageRequest</b> data set. [syntactic validation]
CSPD-25	For the <b>ServicePackageIdentification</b> data set, the <code>servicePackageId</code> shall be unique with respect to all other <code>servicePackageId</code> parameters relative to the Service Agreement. [service management validation]

**4.3.6 CreateServicePackageAcknowledgedReturn (CSP-AR) MESSAGE (CM→UM)**

**4.3.6.1 General**

The **CreateServicePackageAcknowledgedReturn** message conforms to the data set composition and relationship requirements for, and inherits the parameters of, the <<AcknowledgedReturn>> stereotype as specified in 3.3.5.3.3.5. Figure 4-7 shows the message structure of the **CSP-AR** as a class diagram.

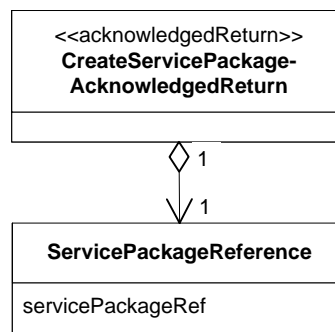

**Figure 4-7: CSP-AR Message Structure Class Diagram**



### 4.3.6.2 Parameters

Table 4-17 defines the parameter of the constituent data set for the **CSP-AR** message.

**Table 4-17: ServicePackageReference Data Set (CSP-AR)**

Parameter Name	Parameter Definition/Description	Data Type	Data Units	Applicable Service Parameter
servicePackageRef	Contains the value of the servicePackageId parameter of the corresponding <b>CSP-I</b> message.	String256	n/a	n/a

### 4.3.6.3 Data Set Composition and Relationship Requirements

Table 4-18 defines the data set composition and relationship requirements for the **CSP-AR** message that are in addition to those of the <<AcknowledgedReturn>> stereotype.

**Table 4-18: Data Set Composition and Relationship Requirement for CSP-AR**

CSPD-26	The <b>CreateServicePackageAcknowledgedReturn</b> message shall contain one <b>ServicePackageReference</b> data set. [syntactic validation]
CSPD-27	The servicePackageRef shall have the same value as the servicePackageId of the corresponding <b>CSP-I</b> . [service management validation]

## 4.3.7 <<ServicePackageResult>> STEREO TYPE

### 4.3.7.1 General

The <<ServicePackageResult>> stereotype specifies the collection of parameters, data sets, and data set relationships that represent a valid Service Package. By itself, this particular stereotype does not constitute a message per the Document Exchange protocol. The stereotype can be combined with multiple message types (e.g., **SuccessfulReturn**, **Notification**, etc.). This stereotype is applied to the following messages (which are defined in subsequent subsections):

- **CreateServicePackageSuccessfulReturn;**
- **ReplaceServicePackageSuccessfulReturn;**
- **ApplyNewTrajectorySuccessfulReturn;**
- **QueryServicePackageSuccessfulReturn;** and
- **ServicePackageModifiedNotification.**

An instantiation of the <<ServicePackageResult>> stereotype is referred to as a ServicePackageResult. Figures 4-8 and 4-9 show the structure of the <<ServicePackageResult>> stereotype as class diagrams.

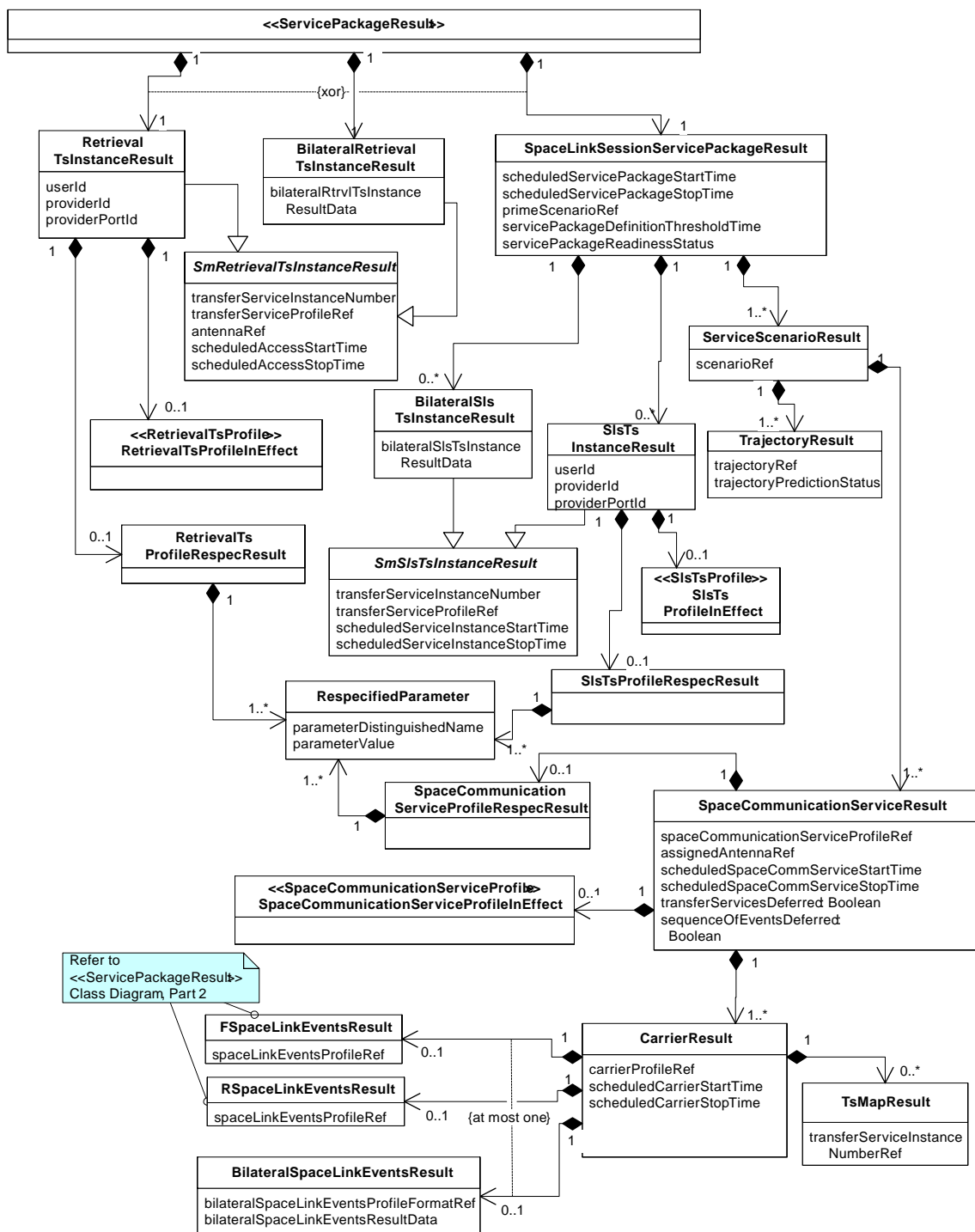

Figure 4-8: <<ServicePackageResult>> Stereotype Structure Presented in a Class Diagram, Part 1 of 2

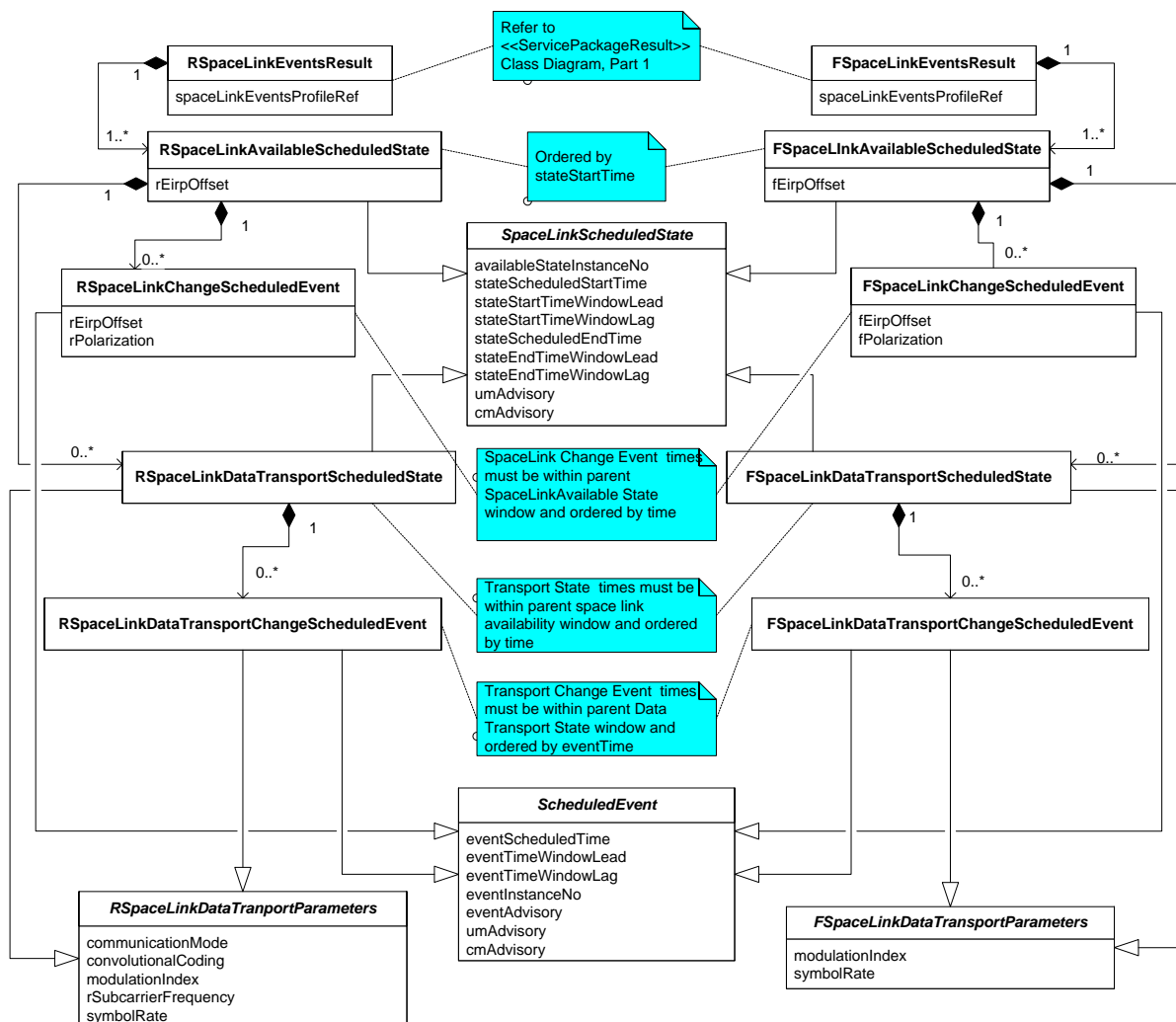

Figure 4-9: <<ServicePackageResult>> Stereotype Structure Presented in a Class Diagram, Part 2 of 2 (Space Link Events)

#### 4.3.7.2 Parameters

Tables 4-19 through 4-38 define the constituent data sets for the <<ServicePackageResult>> stereotype, except for:

- the **RespecifiedParameter** data set, which is defined in table 4-11;
- the **SpaceCommunicationServiceProfileInEffect**, **SlsTsProfileInEffect** and **RetrievalTsProfileInEffect** data sets, which follow the stereotypes <<SpaceCommunicationServiceProfile>> (defined in 5.3.4), <<SlsTsProfile>> (defined in 5.9.4), and <<RetrievalTsProfile>> (defined in 5.10.4), respectively; and

- the **RetrievalTsProfileRespecResult**, **SlsTsProfileRespecResult**, and **SpaceCommunicationServiceProfileRespecResult** data sets, which have no parameters of their own and serve merely as containers for collections of **RespecifiedParameter** data sets (defined in table 4-11).

The **SpaceCommunicationServiceProfileInEffect** data set shall conform to the data set composition and relationship requirements specified for the <<SpaceCommunicationServiceProfile>> stereotype defined in table 5-25.

The **SlsTsProfileInEffect** data set shall conform to the data set composition and relationship requirements specified for the <<SlsTsProfile>> stereotype defined in table 5-84.

The **RetrievalTsProfileInEffect** data set shall conform to the data set composition and relationship requirements specified for the <<RetrievalTsProfile>> stereotype defined in table 5-97.

**Table 4-19: SpaceLinkSessionServicePackageResult Data Set  
(<<ServicePackageResult>>)**

Parameter Name	Parameter Description/Definition	Data Type	Data Units	Applicable Service Agreement Parameter
scheduledServicePackageStartTime	Time at which the Service Package is scheduled to start. The scheduled start of the Service Package corresponds to the earlier of: <ul style="list-style-type: none"> <li>a) the value of the scheduledSpaceCommServiceStartTime of the first (earliest-starting) <b>SpaceCommunicationServiceResult</b> data set for all scenarios in the Service Package; and</li> <li>b) the value of the scheduledServiceInstanceStartTime of the first (earliest-starting) transfer service instance in all <b>SlsTsInstanceResult</b> and <b>BilateralSlsTsInstanceResult</b> data sets in the Service Package.</li> </ul>	UTC	n/a	n/a

Parameter Name	Parameter Description/Definition	Data Type	Data Units	Applicable Service Agreement Parameter
scheduledService- PackageStopTime	Time at which the Service Package is scheduled to stop. The scheduled stop of the Service Package corresponds to the later of: a) the scheduledSpaceCommService- StopTime for the last (latest-ending) <b>SpaceCommunicationServiceResult</b> data set for all scenarios in the Service Package; and b) the value of the scheduledService- InstanceStartTime of the last (latest-ending) transfer service instance in all <b>SlsTsInstanceResult</b> and <b>BilateralSlsTsInstanceResult</b> data sets in the Service Package.	UTC	n/a	n/a
servicePackage- DefinitionThreshold Time	The latest time at which all elements required for the execution of the SLS Service Package can be defined or redefined.	UTC	n/a	n/a
servicePackage- ReadinessStatus	Summary status of the readiness of the Service Package for execution. The values are: – ‘ready’: All required Service Package items are currently defined; – ‘not ready’: One or more required Service Package items must still be defined.	Enum	n/a	n/a
primeScenarioRef	See table 4-4.			

**Table 4-20: serviceScenarioResult Data Set (<<ServicePackageResult>>)**

Parameter Name	Parameter Description/Definition	Data Type	Data Units	Applicable Service Agreement Parameter
scenarioRef	Contains the value of the scenarioId parameter of the service scenario represented by the <b>SpaceCommunicationServiceResult</b> data set(s) contained by the <b>serviceScenarioResult</b> data set.	String256	n/a	n/a

**Table 4-21: TrajectoryResult Data Set (<<ServicePackageResult>>)**

Parameter Name	Parameter Description/Definition	Data Type	Data Units	Applicable Service Agreement Parameter
trajectoryRef	See table 4-6.			
trajectoryPredictionStatus	Status of the referenced Trajectory Prediction as it applies to this Service Package: <ul style="list-style-type: none"> <li>– ‘trajectory prediction available to support the Service Package’: the referenced Trajectory Prediction is suitable for generation of spacecraft acquisition products in support of the Service Package;</li> <li>– ‘trajectory prediction available but does not support the Service Package’: the referenced Trajectory Prediction is available at CM but does not cover the time span required by the Service Package. The referenced Trajectory Prediction must be either extended or replaced (via ANT) before the Service Package can transition from the Pending to the Defined state;</li> <li>– ‘trajectory prediction not currently available’: the referenced Trajectory Prediction is not yet available at CM. The referenced Trajectory Prediction must be added before the Service Package can transition from the Pending to the Defined state.</li> </ul>	Enum	n/a	n/a

**Table 4-22: SpaceCommunicationServiceResult Data Sets (<<ServicePackageResult>>)**

Parameter Name	Parameter Definition/Description	Data Type	Data Units	Applicable Service Agreement Parameter
assignedAntennaRef	Contains the value of an AntennaId of one of the <b>SupportingAntenna</b> data sets (as defined by the Service Agreement) assigned by CM for providing service.	String256	n/a	AntennaId of one of the <b>SupportingAntenna</b> data sets
spaceCommunicationServiceProfileRef	See table 4-7.			
scheduledSpaceCommServiceStartTime	Time at which the space communication service is scheduled to start.	UTC	n/a	n/a
scheduledSpaceCommServiceStopTime	The time at which the space communication service is scheduled to stop.	UTC	n/a	n/a
sequenceOfEventsDeferred	See table 4-7.			
transferServicesDeferred	See table 4-7.			

**Table 4-23: sIsTsInstanceResult Data Set  
(<<ServicePackageResult>>)**

Parameter Name	Parameter Definition/Description	Data Type	Data Units	Applicable Service Agreement Parameter
providerId	Complex identification for the transfer service user to utilize in establishing the transfer service (references [8], [9], and [11]).	String [3..16]	n/a	authorized-Service-Instance-ProviderIds
providerPortId	Complex port identification for the transfer service user to utilize in establishing the transfer service (references [8], [9], and [11]).	String128	n/a	n/a
scheduledService-InstanceStartTime	Time that the Complex makes the transfer service port for the transfer service instance available for a transfer service bind operation from the transfer service user (references [8], [9], and [11]).	UTC	n/a	n/a
scheduledService-InstanceStopTime	Time that the Complex will disable the transfer service port for the transfer service instance (references [8], [9], and [11]).	UTC	n/a	n/a
transferServiceInstanceNumber	Unique transfer service instance identifier, relative to the Service Package.	Unsigned Integer	n/a	n/a
transferServiceProfileRef	See table 4-10.			
userId	Unique identifier, relative to the Service Agreement, of the user of the transfer service instance.	String [3..16]	n/a	authorized-Service-Instance-UserIds

**Table 4-24: BilateralSlsTsInstanceResult Data Set**  
(**<<ServicePackageResult>>**)

Parameter Name	Parameter Definition/Description	Data Type	Data Units	Applicable Service Agreement Parameter
bilateralSlsTsInstanceResultData	Contains the SLS Transfer Service Instance Result data in the format defined by the parameter <code>bilateral-TransferService-ProfileFormatId</code> of the bilateral Space Link Session Transfer Service Profile referenced by the value of the <code>transferService-ProfileRef</code> parameter.	BilateralData	n/a	n/a
scheduledServiceInstanceStartTime	See table 4-23.			
scheduledServiceInstanceStopTime	See table 4-23.			
transferServiceInstanceNumber	See table 4-23.			
transferServiceProfileRef	See table 4-23.			

**Table 4-25: CarrierResult Data Set** (**<<ServicePackageResult>>**)

Parameter Name	Parameter Definition/Description	Data Type	Data Units	Applicable Service Agreement Parameter
carrierProfileRef	Contains the value of the <code>carrierProfileId</code> parameter of the <code>SpaceLinkCarrierProfile</code> data set of the referenced Space Communication Service Profile used to configure the service production and transfer services associated with this carrier.	String256	n/a	n/a
scheduledCarrierStartTime	The time at which the carrier is scheduled to start.	UTC	n/a	n/a
scheduledCarrierStopTime	The time at which the carrier is scheduled to stop.	UTC	n/a	n/a

**Table 4-26: TsMapResult Data Set** (**<<ServicePackageResult>>**)

Parameter Name	Parameter Definition/Description	Data Type	Data Units	Applicable Service Agreement Parameter
transferService-InstanceNumberRef	The value of a <code>transferServiceInstanceNumber</code> parameter of one of the <code>SlsTsInstanceResult</code> or <code>BilateralSlsTsInstanceResult</code> data sets for this Service Package.	Unsigned Integer	n/a	n/a



**Table 4-27: FspaceLinkEventsResult,  
RspaceLinkEventsResult Data Set  
(<<ServicePackageResult>>)**

Parameter Name	Parameter Definition/Description	Data Type	Data Units	Applicable Service Agreement Parameter
spaceLinkEventsProfileRef	See table 4-12.			

**Table 4-28: BilateralSpaceLinkEventsResult Data Set  
(<<ServicePackageResult>>)**

Parameter Name	Parameter Definition/Description	Data Type	Data Units	Applicable Service Agreement Parameter
bilateralSpaceLinkEvents-ProfileFormatRef	<p>Contains the value of the Space Link Events Profile format other than the CCSDS standard format.</p> <p>NOTE – a Bilateral Space Link Events Profile Format identifier serves as the reference to two data formats:</p> <ul style="list-style-type: none"> <li>– the format of the bilaterally defined profile used to schedule the sequence of events; and</li> <li>– the format of the bilaterally defined data structure used to document the resultant scheduled sequence of events.</li> </ul> <p>Depending on the bilaterally defined format, these two may be a single format or two separate formats.</p>	String256	n/a	
bilateralSpaceLinkEvents-ResultData	Contains the Events data in the format defined by the parameter bilateral-EventsProfileFormatId.	Bilateral Data	n/a	

**Table 4-29: FSpaceLinkAvailableScheduledState Data Set  
(<<ServicePackageResult>>)**

Parameter Name	Parameter Definition/Description	Data Type	Data Units	Applicable Service Agreement Parameter
availableState-InstanceNo	See table 5-49.			
stateScheduledStartTime	The time at which the space link availability interval is to occur, as measured at the antenna receiving/transmitting the signal, stated in absolute terms.	UTC	n/a	n/a
stateStartTimeWindowLead	See table 5-49.			
stateStartTimeWindowLag	See table 5-49.			
stateScheduledEndTime	The time at which the space link availability interval is to end, as measured at the antenna receiving/transmitting the signal, stated in absolute terms.	UTC	n/a	n/a
stateEndTimeWindowLead	See table 5-49.			
stateEndTimeWindowLag	See table 5-49.			
fEirpOffset	See table 5-51.			
cmAdvisory	Additional information related to a space link or data transport state or change events that CM may convey to UM. If no such information is available associated with the event being reported, the value shall be NULL. NOTE – This information and any resulting actions on the part of UM are not defined in this recommendation and are specific to the implementations involved.	String or NULL	n/a	n/a
umAdvisory	See table 5-49.			

**Table 4-30: RSpaceLinkAvailableScheduledState Data Set  
(<<ServicePackageResult>>)**

Parameter Name	Parameter Definition/Description	Data Type	Data Units	Applicable Service Agreement Parameter
availableState-InstanceNo	See table 5-49.			
stateScheduledStartTime	See table 4-29.			
stateStartTimeWindow-Lead	See table 5-49.			
stateStartTimeWindow-Lag	See table 5-49.			
stateScheduledEndTime	See table 4-29.			
stateEndTimeWindowLead	See table 5-49.			
stateEndTimeWindowLag	See table 5-49.			
rEirpOffset	See table 5-49.			
cmAdvisory	See table 4-29.			
umAdvisory	See table 5-49.			

**Table 4-31: FSpaceLinkChangeScheduledEvent Data Set**  
(<<ServicePackageResult>>)

Parameter Name	Parameter Definition/Description	Data Type	Data Units	Applicable Service Agreement Parameter
fEirpOffset	See table 5-51.			
eventScheduledTime	The time at which the space link event is to occur, as measured at the antenna receiving/transmitting the signal, stated in absolute terms.	UTC	n/a	n/a
eventTimeWindowLead	See table 5-51.			
eventTimeWindowLag	See table 5-51.			
eventInstanceNo	See table 5-51.			
fPolarization	See table 5-5.			
eventAdvisory	Optional event information that might affect the carrier or data transport states. The content and format are negotiated as part of a bilateral agreement. If the supplementary-EventsReturned parameter of the Service Agreement has a value of 'false', the parameter shall be NULL. If no such information is available associated with the event being reported, the parameter shall be NULL.	String or NULL	n/a	supplementary-EventsReturned
cmAdvisory	See table 4-29.			
umAdvisory	See table 5-49.			

**Table 4-32: RSpaceLinkChangeScheduledEvent Data Set**  
(<<ServicePackageResult>>)

Parameter Name	Parameter Definition/Description	Data Type	Data Units	Applicable Service Agreement Parameter
rEirpOffset	See table 5-49.			
eventScheduledTime	See table 4-31.			
eventTimeWindowLead	See table 5-51.			
eventTimeWindowLag	See table 5-51.			
eventInstanceNo	See table 5-51.			
rPolarization	See table 5-10.			
eventAdvisory	See table 4-31.			
cmAdvisory	See table 4-29.			
umAdvisory	See table 5-49.			

**Table 4-33: RSpaceLinkDataTransportScheduledState Data Set**  
 (<<ServicePackageResult>>)

Parameter Name	Parameter Definition/Description	Data Type	Data Units	Applicable Service Agreement Parameter
availableStateInstanceNo	See table 5-49.			
stateScheduledStartTime	See table 4-29.			
stateStartTimeWindowLead	See table 5-49.			
stateStartTimeWindowLag	See table 5-49.			
stateScheduledEndTime	See table 4-29.			
stateEndTimeWindowLead	See table 5-49.			
stateEndTimeWindowLag	See table 5-49.			
communicationMode	See table 5-53.			
convolutionalCoding	See table 5-14.			
modulationIndex	See table 5-5.			
rSubcarrierFrequency	See table 5-11.			
symbolRate	See table 5-8.			
cmAdvisory	See table 4-29.			
umAdvisory	See table 5-49.			

**Table 4-34: FSpaceLinkDataTransportScheduledState Data Set**  
 (<<ServicePackageResult>>)

Parameter Name	Parameter Definition/Description	Data Type	Data Units	Applicable Service Agreement Parameter
availableStateInstanceNo	See table 5-49.			
stateScheduledStartTime	See table 4-29.			
stateStartTimeWindowLead	See table 5-49.			
stateStartTimeWindowLag	See table 5-49.			
stateScheduledEndTime	See table 4-29.			
stateEndTimeWindowLead	See table 5-49.			
stateEndTimeWindowLag	See table 5-49.			
modulationIndex	See table 5-5.			
symbolRate	See table 5-8.			
cmAdvisory	See table 4-29.			
umAdvisory	See table 5-49.			

**Table 4-35: FSpaceLinkDataTransportChangeScheduledEvent Data Set (<<ServicePackageResult>>)**

Parameter Name	Parameter Definition/Description	Data Type	Data Units	Applicable Service Agreement Parameter
eventScheduledTime	See table 4-31.			
eventTimeWindowLead	See table 5-51.			
eventTimeWindowLag	See table 5-51.			
eventInstanceNo	See table 5-51.			
modulationIndex	See table 5-5.			F401SpaceLink-CarrierAgreement: modulationIndex-Range
symbolRate	See table 5-8.			
eventAdvisory	See table 4-31.			
cmAdvisory	See table 4-29.			
umAdvisory	See table 5-49.			

**Table 4-36: RSpaceLinkDataTransportChangeScheduledEvent Data Set (<<ServicePackageResult>>)**

Parameter Name	Parameter Definition/Description	Data Type	Data Units	Applicable Service Agreement Parameter
eventScheduledTime	See table 4-31.			
eventTimeWindowLead	See table 5-51.			
eventTimeWindowLag	See table 5-51.			
eventInstanceNo	See table 5-51.			
communicationMode	See table 5-53.			
convolutionalCoding	See table 5-14.			
modulationIndex	See table 5-5.			
rSubcarrierFrequency	See table 5-11.			
rPolarization	See table 5-10.			
symbolRate	See table 5-8.			
eventAdvisory	See table 4-31.			
cmAdvisory	See table 4-29.			
umAdvisory	See table 5-49.			

**Table 4-37: RetrievalTsInstanceResult Data Set  
(<<ServicePackageResult>>)**

Parameter Name	Parameter Definition/Description	Data Type	Data Units	Applicable Service Agreement Parameter
antennaRef	See table 4-9.			
providerId	See table 4-23.			
providerPortId	See table 4-23.			
scheduledAccessStartTime	Scheduled time to begin access to the DataStore for retrieval of data for delivery via the Retrieval Transfer Service instance.	UTC	n/a	n/a
scheduledAccessStopTime	Scheduled time to end access to the DataStore for retrieval of data.	UTC	n/a	n/a
transferServiceInstanceNumber	See table 4-23.			
transferServiceProfileRef	See table 4-10.			
userId	See table 4-23.			

**Table 4-38: BilateralRetrievalTsInstanceResult Data Set  
(<<ServicePackageResult>>)**

Parameter Name	Parameter Definition/Description	Data Type	Data Units	Applicable Service Agreement Parameter
antennaRef	See table 4-9.			
bilateralRtrvlTsInstanceResultData	Contains the Retrieval Transfer Service Instance Result data in the format defined by the parameter bilateralTransferServiceProfileFormatId of the bilateral Retrieval Transfer Service Profile referenced by the value of the transferServiceProfileRef parameter.	Bilateral Data	n/a	n/a
scheduledAccessStartTime	See table 4-37.			
scheduledAccessStopTime	See table 4-37.			
transferServiceInstanceNumber	See table 4-37.			
transferServiceProfileRef	See table 4-37.			

**4.3.7.3 Data Set Composition and Relationship Requirements**

The data set composition and relationship requirements for the <<ServicePackageResult>> stereotype use the notation ‘[R|F]’ in requirements that are applicable to return and forward data sets where their names vary only by their leading character (e.g., a requirement written in terms of [R|F]SpaceLinkEventSequenceResult applies equally to the RspaceLinkEventSequenceResult data set and the FspaceLinkEventSequenceResult data set).

Table 4-39 defines the data set composition and relationship requirements for the ServicePackageResult.

**Table 4-39: Data Set Composition and Relationship Requirements for All ServicePackageResults**

CSPD-28	<p>A ServicePackageResult shall contain one and only one of the following:</p> <ul style="list-style-type: none"> <li>a) a SpaceLinkSessionServicePackageResult data set;</li> <li>b) a RetrievalTsInstanceResult data set; or</li> <li>c) a BilateralRetrievalTsInstanceResult data set.</li> </ul> <p>[syntactic validation]</p>
CSPD-29	<p>For a Service Package created via CreateServicePackage or replaced via ReplaceServicePackage:</p> <ul style="list-style-type: none"> <li>a) A ServicePackageResult shall contain a SpaceLinkSessionServicePackageResult data set if the corresponding ServicePackageRequest contained a SpaceLinkSessionServicePackageRequest data set.</li> <li>b) A ServicePackageResult shall contain a RetrievalTsInstanceResult data set if the corresponding ServicePackageRequest contained a RetrievalServicePackageRequest data set for which the transferServiceProfileRef references a CCSDS-standard Retrieval Transfer Service Profile.</li> <li>c) A ServicePackageResult shall contain a BilateralRetrievalTsInstanceResult data set if the corresponding ServicePackageRequest contained a RetrievalServicePackageRequest data set for which the transferServiceProfileRef references a bilateral Retrieval Transfer Service Profile.</li> </ul> <p>[service management validation]</p>
CSPD-30	<p>A SpaceLinkSessionServicePackageResult data set shall contain:</p> <ul style="list-style-type: none"> <li>a) one or more ServiceScenarioResult data sets;</li> <li>b) zero or more SlsTsInstanceResult data sets; and</li> <li>c) zero or more BilateralSlsTsInstanceResult data sets.</li> </ul> <p>[syntactic validation]</p>
CSPD-31	<p>For a Service Package created via CreateServicePackage or replaced via ReplaceServicePackage, the SpaceLinkSessionServicePackageResult data set shall contain the same number of ServiceScenarioResult data sets as the number of ServiceScenario data sets contained in the corresponding SpaceLinkSessionServicePackageRequest data set.</p> <p>[service management validation]</p>



CSPD-32	For a Service Package created via <code>CreateServicePackage</code> or replaced via <code>ReplaceServicePackage</code> , the <code>primeScenarioRef</code> parameter shall have the same value as the <code>primeScenarioRef</code> of the <code>SpaceLinkSessionServicePackageRequest</code> data set. [service management validation]
CSPD-33	Each <code>SlsTsInstanceResult</code> data set shall contain either: a) no <code>SlsTsProfileRespecResult</code> and no <code>SlsTsProfileInEffect</code> data sets; b) one <code>SlsTsProfileRespecResult</code> data set and one <code>SlsTsProfileInEffect</code> data set. [syntactic validation]
CSPD-34	For a Service Package created via <code>CreateServicePackage</code> or replaced via <code>ReplaceServicePackage</code> , for each <code>SlsTsProfileRespecification</code> data set in the corresponding <code>SpaceLinkSessionServicePackageRequest</code> data set that references a CCSDS-standard Space Link Session Transfer Service Profile, the <code>SlsTsInstanceResult</code> data set with the same value for the <code>transferServiceProfileRef</code> parameter shall contain one <code>SlsTsProfileRespecResult</code> data set and one <code>SlsTsProfileInEffect</code> data set. [service management validation] NOTE – <code>SlsTsProfileRespecification</code> data sets that reference bilateral (i.e., non-CCSDS-standard) Space Link Session Transfer Service Profiles are reflected in the content of the <code>bilateralSlsTsInstanceResultData</code> parameter of the corresponding <code>BilateralSlsTsInstanceResult</code> data set. How these changes are reflected are determined bilaterally and are outside the scope of this specification.
CSPD-35	Each <code>SlsTsProfileRespecResult</code> data set shall contain one or more <code>RespecifiedParameter</code> data sets. [syntactic validation]
CSPD-36	For a Service Package created via <code>CreateServicePackage</code> or replaced via <code>ReplaceServicePackage</code> , for each <code>SlsTsProfileRespecification</code> data set in the corresponding <code>SpaceLinkSessionServicePackageRequest</code> data set that references a non-bilateral Space Link Session Transfer Service Profile, the <code>SlsTsProfileRespecResult</code> data set contained by the <code>SlsTsInstanceResult</code> data set with the same value for the <code>transferServiceProfileRef</code> parameter shall contain the same number and contents of <code>RespecifiedParameter</code> data sets as the invoked <code>SlsTsProfileRespecification</code> data set. [service management validation]
CSPD-37	Each <code>SlsTsProfileInEffect</code> data set shall contain the contents of the referenced ( <code>transferServiceProfileRef</code> ) SLS Transfer Service Profile, as modified by the <code>RespecifiedParameter</code> data set(s) of the associated <code>SlsTsProfileRespecResult</code> data set. [service management validation]
CSPD-38	Each <code>ServiceScenarioResult</code> data set shall contain: a) one or more <code>TrajectoryResult</code> data sets; and b) one or more <code>SpaceCommunicationServiceResult</code> data sets. [syntactic validation]
CSPD-39	Each <code>SpaceCommunicationServiceResult</code> data set shall contain: a) zero or one <code>SpaceCommunicationServiceProfileRespecResult</code> data set; b) zero or one <code>SpaceCommunicationServiceProfileInEffect</code> data sets; c) one or more <code>CarrierResult</code> data sets. [syntactic validation]
CSPD-40	For a Service Package created via <code>CreateServicePackage</code> or replaced via <code>ReplaceServicePackage</code> , for each <code>SpaceCommunicationServiceProfileRespecification</code> data set in a <code>SpaceCommunicationServiceRequest</code> data set of the corresponding <code>SpaceLinkSessionServicePackageRequest</code> data set, the corresponding <code>SpaceCommunicationServiceResult</code> data set shall contain one <code>SpaceCommunicationServiceProfileRespecResult</code> and one <code>SpaceCommunicationServiceProfileInEffect</code> data set. [service management validation]

CSPD-41	Each <b>SpaceCommunicationServiceProfileRespecResult</b> data set shall contain one or more <b>RespecifiedParameter</b> data sets. [syntactic validation]
CSPD-42	For a Service Package created via <b>CreateServicePackage</b> or replaced via <b>ReplaceServicePackage</b> , each <b>SpaceCommunicationServiceProfileRespecResult</b> data set shall contain the same number and contents of <b>RespecifiedParameter</b> data sets as its corresponding <b>SpaceCommunicationServiceRespecification</b> data set of the corresponding <b>SpaceLinkSessionServicePackageRequest</b> data set. [service management validation]
CSPD-43	Each <b>SpaceCommunicationServiceProfileInEffect</b> data set shall contain the contents of the referenced ( <b>spaceCommunicationServiceProfileRef</b> ) Space Communication Service Profile, as modified by the <b>RespecifiedParameter</b> data set(s) of the associated <b>SpaceCommunicationServiceProfileRespecResult</b> data set. [service management validation]
CSPD-44	Each <b>CarrierResult</b> data set shall contain: a) zero or more <b>TsMapResult</b> data sets; b) zero or at most one of 1) <b>FspaceLinkEventSequenceResult</b> data set; 2) <b>RspaceLinkEventSequenceResult</b> data set. [syntactic validation]
CSPD-45	a) For a Service Package created via <b>CreateServicePackage</b> or replaced via <b>ReplaceServicePackage</b> , each <b>ServiceScenarioResult</b> data set shall contain at least one <b>SpaceCommunicationServiceResult</b> data set for each <b>SpaceCommunicationServiceRequest</b> data set in the corresponding <b>ServiceScenario</b> data set of the associated <b>SpaceLinkSessionServicePackageRequest</b> data set. b) If handovers are not permitted, the <b>ServiceScenarioResult</b> data set shall contain one and only one <b>SpaceCommunicationServiceResult</b> data set with the same value for the <b>spaceCommunicationServiceProfileRef</b> parameter. c) If handovers are permitted: 1) The <b>ServiceScenarioResult</b> data set shall contain one or more <b>SpaceCommunicationServiceResult</b> data set with the same value for the <b>spaceCommunicationServiceProfileRef</b> parameter; and 2) If a <b>ServiceScenarioResult</b> data set contains more than one <b>SpaceCommunicationServiceResult</b> data set with the same <b>spaceCommunicationServiceProfileRef</b> , the <b>scheduledCarrierStartTime</b> and <b>scheduledCarrierStopTime</b> values of the multiple <b>CarrierResult</b> data sets for each space link carrier (that is, the multiple <b>CarrierResult</b> data sets that have the same <b>carrierProfileRef</b> value) must mutually overlap each other by at least the minimum overlap specified in the <b>handoverOverlap</b> parameter of the Service Agreement. [service management validation]
CSPD-46	Each <b>CarrierResult</b> data set that corresponds to a carrier in a Space Communication Service Profile that is referenced by a <b>SpaceCommunicationServiceRequest</b> data set that <u>does not</u> have transfer services deferred shall contain a <b>TsMapResult</b> data set for each <b>FcltuTSM, RaftSM, RcftSM, and BilateralTSM</b> data set contained by the referenced Space Communication Service Profile that has not been respecified to be disabled. [service management validation]
CSPD-47	For a Service Package created via <b>CreateServicePackage</b> or replaced via <b>ReplaceServicePackage</b> , each <b>CarrierResult</b> data set that is contained by a <b>SpaceCommunicationServiceResult</b> data set that corresponds to a <b>SpaceCommunicationServiceRequest</b> data set with <b>transferServicesDeferred = 'true'</b> shall not contain any <b>TsMapResult</b> data sets. [service management validation]

CSPD-48	<p>A <b>CarrierResult</b> data set shall contain</p> <ul style="list-style-type: none"> <li>a) an <b>FspaceLinkEventsResult</b> data set if and only if: <ul style="list-style-type: none"> <li>1) the <b>carrierProfileRef</b> parameter of the <b>CarrierResult</b> references a forward Space Link Carrier Profile in the Space Communication Service Profile; and</li> <li>2) the corresponding <b>SpaceCommunicationServiceRequest</b> of the <b>SpaceLinkSessionServicePackageRequest</b> data set contains a <b>SpaceLinkEventsProfileReference</b> data set with the same <b>carrierProfileRef</b> value and a <b>spaceLinkEventsProfileRef</b> for a Forward Space Link Events Profile;</li> </ul> </li> <li>b) an <b>RspaceLinkEventsResult</b> data set if and only if: <ul style="list-style-type: none"> <li>1) the <b>carrierProfileRef</b> parameter of the <b>CarrierResult</b> references a return Space Link Carrier Profile in the Space Communication Service Profile; and</li> <li>2) the corresponding <b>SpaceCommunicationServiceRequest</b> of the <b>SpaceLinkSessionServicePackageRequest</b> data set contains a <b>SpaceLinkEventsProfileReference</b> data set with the same <b>carrierProfileRef</b> value and a <b>spaceLinkEventsProfileRef</b> for a Return Space Link Events Profile;</li> </ul> </li> <li>c) a <b>BilateralSpaceLinkEventsResult</b> data set if and only if the corresponding <b>SpaceCommunicationServiceRequest</b> of the <b>SpaceLinkSessionServicePackageRequest</b> data set contains a <b>SpaceLinkEventsProfileReference</b> data set with the <b>spaceLinkEventsProfileRef</b> indicating a bilateral Space Link Events Profile.</li> </ul> <p>[service management validation]</p> <p>NOTE 1 – Space Link Events are used only with Service Packages created via <b>CreateServicePackage</b> or replaced via <b>ReplaceServicePackage</b>.</p> <p>NOTE 2 – Use of bilaterally defined event sequences also implies a bilaterally defined mechanism for identifying events with respect to particular space link carriers.</p>
CSPD-49	<p>For a Service Package created via <b>CreateServicePackage</b> or replaced via <b>ReplaceServicePackage</b>, for each <b>ServiceScenarioResult</b> data set, the <b>trajectoryRef</b> parameter shall have the same value as that of the <b>SpaceLinkSessionServicePackageRequest</b> data set.</p> <p>[service management validation]</p>
CSPD-50	<p>The <b>[R F]SpaceLinkEventsResults</b> data set shall contain the same number, ordering, and contents of the <b>[R F]SpaceLinkAvailableStates</b> as that contained in the referenced Space Link Events Profile.</p> <p>[service management validation]</p>
CSPD-51	<p>All <b>eventScheduledTime</b> values associated with space link availability states and space link data transport states shall be within the interval of time bound by the corresponding parent space link availability or data transport state.</p> <p>[service management validation]</p>
CSPD-52	<p>For each <b>RetrievalTsProfileRespecification</b> data set in the corresponding <b>RetrievalServicePackageRequest</b> that references a CCSDS-standard Retrieval Transfer Service Profile, the <b>RetrievalTsInstanceResult</b> data set shall contain one <b>RetrievalTsProfileRespecResult</b> data set and one <b>RetrievalTsProfileInEffect</b> data set.</p> <p>[service management validation]</p> <p>NOTE – <b>RetrievalTsProfileRespecification</b> data sets that reference <u>bilateral</u> (i.e., non-CCSDS-standard) Retrieval Transfer Service Profiles are reflected in the content of the <b>bilateralRtrvltTsInstanceResultData</b> parameter of the corresponding <b>BilateralRetrievalTsInstanceResult</b> data set. How these changes are reflected are determined bilaterally and are outside the scope of this Recommended Standard.</p>

CSPD-53	A <b>RetrievalTsProfileRespecResult</b> data set shall contain one or more <b>RespecifiedParameter</b> data sets. [syntactic validation]
CSPD-54	A <b>RetrievalTsProfileRespecResult</b> data set shall contain the same number and contents of <b>RespecifiedParameter</b> data sets as its corresponding <b>RetrievalTsProfileRespecification</b> data set of the corresponding <b>RetrievalServicePackageRequest</b> . [service management validation]
CSPD-55	A <b>RetrievalTsProfileInEffect</b> data set shall contain the contents of the referenced (transferServiceProfileRef) Retrieval Transfer Service Profile, as modified by the <b>RespecifiedParameter</b> data set(s) of the associated <b>RetrievalTsProfileRespecResult</b> data set. [service management validation]

**4.3.8 CreateServicePackageSuccessfulReturn (CSP-SR) MESSAGE (CM → UM)**

**4.3.8.1 General**

The **CreateServicePackageSuccessfulReturn** message conforms to the data set composition and relationship requirements for, and inherits the parameters of, the <<SuccessfulReturn>> stereotype, as specified in 3.3.5.3.3.2, and the <<ServicePackageResult>> stereotype, as specified in 4.3.7.

The class diagram for the **CreateServicePackageSuccessfulReturn** message structure is shown in figure 4-10.

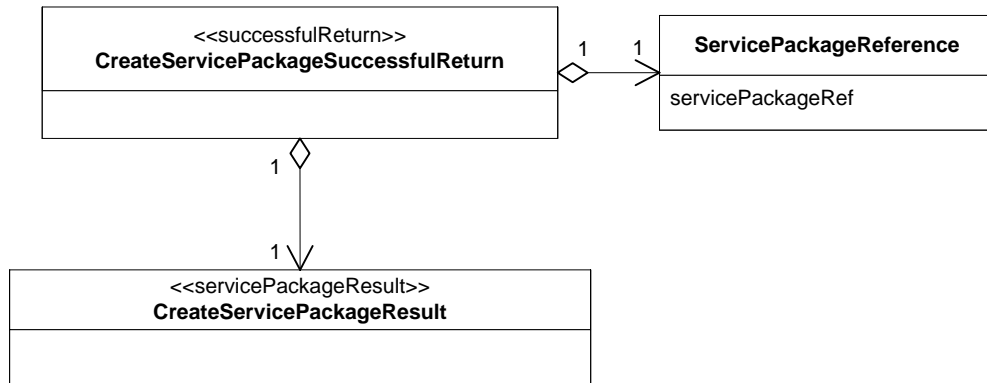

**Figure 4-10: CSP-SR Message Structure Class Diagram**

### 4.3.8.2 Parameters

The contents of the **ServicePackageReference** data set are defined in table 4-17.

The **CreateServicePackageResult** data set conforms to the data set composition and relationship requirements for, and inherits the parameters of, the <<ServicePackage-Result>> stereotype, as specified in 4.3.7.

### 4.3.8.3 Data Set Composition and Relationship Requirements

Table 4-40 defines the data set composition and relationship requirements for the **CSP-SR** message that are in addition to those of the <<SuccessfulReturn>> and <<ServicePackageResult>> stereotypes.

**Table 4-40: Data Set Composition and Relationship Requirements for CSP-SR**

CSPD-56	The <b>CreateServicePackageSuccessfulReturn</b> message shall contain: a) one <b>ServicePackageReference</b> data set; and b) one <b>CreateServicePackageResult</b> data set. [syntactic validation]
CSPD-57	For the <b>ServicePackageReference</b> data set, the <code>servicePackageRef</code> shall have the same value as the <code>servicePackageId</code> parameter of the <b>CSP-I</b> . [service management validation]

## 4.3.9 CreateServicePackageFailedReturn (CSP-FR) MESSAGE (CM → UM)

### 4.3.9.1 General

The **CreateServicePackageFailedReturn** message conforms to the data set composition and relationship requirements for, and inherits the parameters of, the <<FailedReturnWithDenial>> stereotype, as specified in 3.3.5.3.3.4.

The class diagram for the **CreateServicePackageFailedReturn** message structure is shown in figure 4-11.

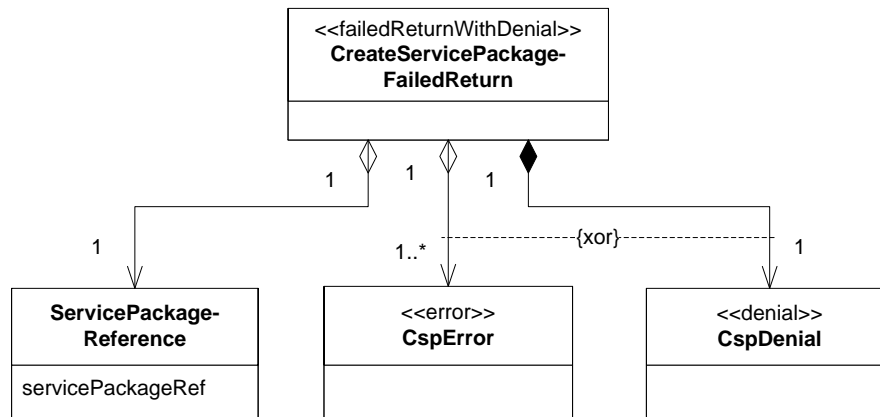

Figure 4-11: CSP-FR Message Structure Class Diagram

### 4.3.9.2 Parameters

The contents of the **ServicePackageReference** data set are defined in table 4-17.

The **CspError** dataset of the **CreateServicePackageFailedReturn** message conforms to the data set composition and relationship requirements for, and inherits the parameters of, the <<Error>> data set stereotype, which contains a diagnostic parameter of the <<ErrorDiagnostic>> stereotype. Table 4-41 defines the additional values of the diagnostic parameter for the **CspError** data set, identifies the CM and data set composition service management requirements that result in that diagnostic value being returned, and identifies the contents of the erroredItem and additionalInformation parameters that accompany each diagnostic value.

Table 4-41: CspError Data Set diagnostic Parameter Definition

diagnostic value	Definition/Description	Rqmt	Parameter or Data Set Identified by erroredItem	Content of additional Information
'creation terminated by DSP operation'	The creation of the Service Package was deleted by the invocation of the DSP operation.	CSPC-21	servicePackageId.	n/a
'duplicate space link events profiles for the same carrier profile'	The <b>CSP-I</b> contains two or more <b>SpaceLinkEvents-ProfileReference</b> data sets that reference the same carrier profile.	CSPD-16c	One of the spaceLink-EventsProfileRef parameters that reference Space Link Events Profiles that reference the same carrier profile.	n/a

diagnostic value	Definition/Description	Rqmt	Parameter or Data Set Identified by erroredItem	Content of additional Information
'event sequence incompatible with Space Communication Service Profile'	The referenced Space Link Events Profile references a carrier profile that is not part of the Space Communication Service Profile that is referenced by the SpaceCommunicationServiceRequest to which the Event Sequence is to be applied.	CSPD-16b	spaceLinkEvents-ProfileRef parameter of the <b>SpaceLink-EventsProfile-Reference</b> data set that references the incompatible carrier profile.	space-Communication-Service-Profile-Ref of the <b>Space-Communication-Service-Request</b> data set that contains the invalid <b>Space-Link-Events-Profile-Reference</b> data set
'exceeds maxForwardSpaceLinkCarriersPerScenario'	The Service Package Request contains a Service Scenario that contains <b>SpaceCommunication-ServiceRequest</b> data sets that reference Space Communication Service Profiles that collectively contain more forward space link carrier profiles than allowed by the referenced Service Agreement.	CSPD-7a	The <b>SpaceLink-CarrierProfile</b> of a referenced <b>Space Communication Service Profile</b> that specifies the <b>first forward carrier profile that causes maxForwardSpace-LinkCarriersPer-Scenario</b> to be exceeded for the scenario.	n/a
'exceeds maxReturnSpace-LinkCarriersPerScenario'	The Service Package Request contains a Service Scenario that contains <b>SpaceCommunication-ServiceRequest</b> data sets that reference Space Communication Service Profiles that collectively contain more return space link carrier profiles than allowed by the referenced Service Agreement.	CSPD-7b	The <b>SpaceLink-CarrierProfile</b> of a referenced <b>Space Communication Service Profile</b> that specifies the <b>first forward carrier profile that causes maxReturnSpace-LinkCarriersPer-Scenario</b> to be exceeded for the scenario.	n/a

diagnostic value	Definition/Description	Rqmt	Parameter or Data Set Identified by erroredItem	Content of additional Information
'exceeds maxRtrvlService Packages'	The Service Package Request would cause the number of Service Packages to exceed maxRtrvlServicePackages for the referenced Service Agreement.	CSPC-8c	servicePackageId.	n/a
'exceeds maxRtrvlService PackagesPerTime Period'	The Service Package Request would cause the number of Service Packages to exceed maxRtrvlServicePackagesPerTimePeriod for the referenced Service Agreement.	CSPC-8d	servicePackageId.	n/a
'exceeds maxService-PackageTemporal Span'	The Service Package Request contains one or more scenarios that, in aggregate, exceed the maxServicePackageTemporalSpan for the referenced Service Agreement.	CSPD-4b	The <b>SpaceCommunicationServiceRequest</b> data set that has the latest allowable start time for the Service Package, as defined in CSPD-4.	Distinguished Name of the <b>SpaceCommunicationServiceRequest</b> data set that has the earliest allowable stop time for the Service Package, as defined in CSPD-4
'exceeds maxService-ScenariosPerServicePackage'	The Service Package Request contains more scenarios than is allowed for the referenced Service Agreement.	CSPD-4a	The scenarioId of the first scenario in excess of maxServiceScenariosPerServicePackage.	n/a



diagnostic value	Definition/Description	Rqmt	Parameter or Data Set Identified by erroredItem	Content of additional Information
'exceeds maxService-Scenario-TemporalSpan'	The Service Package Request contains one or more scenarios that exceed the maxServiceScenarioTemporalSpan for the referenced Service Agreement.	CSPD-7c	The <b>SpaceCommunicationServiceRequest</b> data set that has the latest allowable start time for the Service Scenario that exceeds the maximum allowed temporal span, as defined in CSPD-7.	Distinguished Name of the <b>SpaceCommunicationServiceRequest</b> data set that has the earliest allowable stop time for the Service Scenario that exceeds the maximum allowed temporal span, as defined in CSPD-7
'exceeds maxSlsService-Packages'	The Service Package Request would cause the number of Service Packages to exceed maxSlsService-Packages for the referenced Service Agreement.	CSPC-8a	servicePackageId.	n/a
'exceeds maxSlsService-PackagesPerTimePeriod'	The Service Package Request would cause the number of Service Packages to exceed maxSlsService-PackagesPerTimePeriod for the referenced Service Agreement.	CSPC-8b	servicePackageId.	n/a
'exceeds maxTransfer-ServicesPer-ServicePackage'	The Service Package Request contains more transfer services than allowed by the referenced Service Agreement.	CSPD-5	The first <b>TsMap</b> data set in a referenced Space Communication Service Profile that exceeds maxTransfer-ServicesPer-ServicePackage.	n/a

diagnostic value	Definition/Description	Rqmt	Parameter or Data Set Identified by erroredItem	Content of additional Information
'exceeds maxInstancesOf-TsType'	The Service Package Request contains transfer service instances of a particular type that would exceed the total number of transfer services of that type that are allowed to be active at any given time by the referenced Service Agreement.	CSPC-8e	For an SLS Service Package, the first <b>TsMap</b> data set in a referenced Space Communication Service Profile that exceeds maxInstancesOfTsType for that transfer service type.  For a retrieval Service Package, the <b>Retrieval-ServicePackage-Request</b> data set.	n/a
'incompatible space link events time references'	A referenced Space Link Events Profile has a different timeReference value from that of the Space Communication Service Request that is referencing it.	CSPD-23	The <b>SpaceCommunicationService-Request</b> data set that references the incompatible Space Link Events Profile.	The name of the incompatible Space Link Events Profile.
'invalid respecified parameter name'	The parameter-DistinguishedName value for a respecified parameter is not the name of a parameter of the configuration profile that is to be respecified.	CSPD-17b(1), CSPD-21a	The parameter-DistinguishedName parameter that contains an invalid parameter name for the configuration profile that is to be respecified.	The identifier of the configuration profile that is to be respecified
'invalid respecified parameter value'	The parameterValue value for a respecified parameter is not a valid value for the parameter of the configuration profile that is to be respecified.	CSPD-17b(2), CSPD-21b	The parameterValue parameter that contains an invalid value for the configuration profile parameter that is to be respecified.	The identifier of the configuration profile that is to be respecified
'mutually incompatible parameter values'	The Service Package Request contains two or more parameters that are incompatible with each other.	CSPC-5, CSPD-9, CSPD-13, CSPD-14, CSPD-15	One of the mutually incompatible parameters (see GRD-0036, table 3-14).	n/a
'no matching scenarioId for primeScenarioRef'	The Service Package Request does not identify any of the specified scenarios as the prime (default) scenario for execution.	CSPD-3	primeScenarioRef.	n/a

diagnostic value	Definition/Description	Rqmt	Parameter or Data Set Identified by erroredItem	Content of additional Information
'no matching spaceLinkEvents ProfileId for spaceLinkEvents ProfileRef'	The Service Package Request contains a spaceLinkEvents-ProfileRef parameter that references a Space Link Events Profile that does not exist at CM. NOTE – If multiple unknown spaceLinkEvents-ProfileRef values appear in the CSP-I, there will be one diagnostic value for each occurrence.	CSPD-16a	The spaceLink-EventsProfileRef parameter with no matching Space Link Events Profile at CM.	n/a
'no matching spaceCommunicationServiceProfileId for spaceCommunicationServiceProfileRef'	The Service Package Request contains a spaceCommunicationServiceProfileRef parameter that references a Space Communication Service Profile that does not exist at CM. NOTE – If multiple unknown spaceCommunicationServiceProfileRef values appear in the CSP-I, there will be one diagnostic value for each occurrence.	CSPD-10	The spaceCommunicationServiceProfileRef parameter with no matching Space Communication Service Profile at CM.	n/a
'no matching TransferService ProfileId for transferService ProfileRef'	The Service Package Request contains a transferService-ProfileRef parameter that references a Transfer Service Profile that does not exist at CM. NOTE – If multiple unknown transferService-ProfileRef values appear in the CSP-I, there will be one diagnostic value for each occurrence.	CSPD-17a, CSPD-20	transferService-ProfileRef parameter with no matching Transfer Service Profile at CM.	n/a
'operation timeout'	See table 3-11.	3PP-0104b		n/a

diagnostic value	Definition/Description	Rqmt	Parameter or Data Set Identified by erroredItem	Content of additional Information
'parameter not respecifiable'	A parameter was attempted to be respecified even though that parameter name is not included in the set of respecifiable parameters listed in the contractualReference of the Service Agreement.	CSPD-17b(3), CSPD-18c, CSPD-21c	The <b>Respecified-Parameter</b> data set for which the value of the parameter-DistinguishedName parameter is not listed in the Service Agreement.	Value of the parameter-DistinguishedName parameter
'parameter value not supported by referenced Service Agreement'	The Service Package Request contains a parameter that is not in accord with its constraining parameter in the referenced Service Agreement.	CSPC-4	The parameter that does not conform to its constraining parameter in the referenced Service Agreement constraints.	n/a
'respecification not supported'	A parameter respecification data set was included in the Service Package Request even though respecification is not supported under the Service Agreement.	CSPD-22a  CSPD-22b  CSPD-22c	<b>SLSTsProfile-Respecification</b> data set.  <b>SpaceCommunicationService-ProfileRespecification</b> data set.  <b>RetrievalTsProfileRespecification</b> data set.	n/a
'retrieval transfer service instance lifetime outside service agreement period'	The value of the accessStartTime parameter for a Retrieval Transfer Instance is before the serviceAgreement-StartTime, or the value of the accessStopTime is after the service-AgreementStopTime.	CSPC-18	The accessStartTime or the accessStopTime parameter that violates the Service Agreement time span.	n/a
'servicePackage-Id already in use'	A Service Package with this identifier is already registered at CM for the referenced Service Agreement.	CSPD-25	servicePackageId.	n/a
'Transfer Service Profile referenced by multiple carriers in the same scenario'	A SLS Transfer Service Profile is referenced by more than one carrier in a service scenario.	CSPD-7d	One of the <b>SpaceCommunication-ServiceRequest</b> data set that references the same Transfer Service Profile.	The identifier of the Transfer Service Profile that is referenced multiple times.
'other'	The operation has failed due to an error that is local to the Service Agreement.	CSPC-6	The invalid parameter or data set that causes the violation.	Text-string description of the local error

The **CspDenial** dataset of the **CreateServicePackageFailedReturn** message conforms to the data set composition and relationship requirements for, and inherits the parameters of, the <<Denial>> data set stereotype, which contains a reason parameter of the <<DenialReason>> stereotype. Table 4-42 defines the additional values of the reason parameter for the **CspDenial** data set, identifies the CM and data set composition service management requirements that result in that reason value being returned, and identifies the contents of the deniedItem and additionalInformation parameters that accompany each reason value.

**Table 4-42: CspDenial Data Set reason Parameter Definition**

reason value	Definition/Description	Rqmt	Parameter or Data Set Identified by deniedItem	Content of additional Information
'insufficient lead time for request'	CM is unable to perform the CSP operation (or set of related operations for a <b>CSP-I</b> tagged with urgent parameter = 'true') before the execution of the Service Package is to occur.	CSPC-20	servicePackageId	n/a
'resource(s) not available'	Indicates that CM is unable to reserve/allocate some or all of the resources required to fulfill one or more of the scenarios in the <b>CSP-I</b> .	CSPC-16, CSPC-17, CSPC-19	The data set or parameter that corresponds to the unavailable resource	n/a
'unable to view spacecraft from antenna'	CM is unable to view the spacecraft for of the duration of the acquisition time requested in one or more scenarios via the referenced trajectory.	CSPC-16b(4)	servicePackageId, or scenarioId, or <b>SpaceCommunicationServiceRequest</b>	n/a
'acceptable antennas inappropriate for requested service(s)'	None of the acceptable or preferred antennas is suitable for the forward and/or return service(s) requested.	CSPC-16b(1a), CSPC-16b(1b)	antennaRef	n/a
'other'	The operation is denied for a reason that is local to the Service Agreement.	CSPC-7	The invalid parameter or data set that causes the violation	Text-string description of the local denial reason

#### 4.3.9.3 Data Set Composition and Relationship Requirements for **CSP-FR**

Table 4-43 defines the data set composition and relationship requirements common for **CSP-FR** messages that are in addition to those of the <<FailedReturnWithDenial>> stereotype.

**Table 4-43: Data Set Composition and Relationship Requirements for CSP-FR**

CSPD-58	The <b>CreateServicePackageFailedReturn</b> message a) shall contain one <b>ServicePackageReference</b> data set; b) shall contain either one <b>CspDenial</b> data set or one or more <b>CspError</b> data sets. [syntactic validation]
CSPD-59	The <b>servicePackageRef</b> parameter shall contain the same value as the <b>servicePackageId</b> parameter in the corresponding <b>CSP-I</b> . [service management validation]
CSPD-60	If the <b>CSP-I</b> fails because multiple <b>SpaceLinkEventSequenceReference</b> data sets reference Event Sequence Profiles that reference the same carrier profile (diagnostic value 'duplicate event sequences for the same carrier profile'), the <b>CSP-FR</b> shall contain one <b>CspError</b> data set for each such <b>SpaceLinkEventSequenceReference</b> data set.
CSPD-61	If the <b>CSP-I</b> fails because multiple transfer service mapping data sets reference the same SLS transfer service profile (diagnostic value 'Transfer Service Profile referenced by multiple carriers in the same scenario'), the <b>CSP-FR</b> shall contain one <b>CspError</b> data set for each <b>SpaceCommunicationServiceRequest</b> data set that references the same Transfer Service Profile.

#### 4.4 REPLACE\_SERVICE\_PACKAGE (RSP) OPERATION

##### 4.4.1 PURPOSE

The REPLACE\_SERVICE\_PACKAGE (RSP) operation allows UM to request one or more changes to an existing Service Package at a CM.

##### 4.4.2 PROCEDURE

**4.4.2.1** The RSP operation is defined to be a three-phase operation in accordance with the operation procedure pattern specified in 3.4.2.

**4.4.2.2** The RSP operation is defined in terms of the following messages:

- **ReplaceServicePackageInvocation (RSP-I);**
- **ReplaceServicePackageAcknowledgedReturn (RSP-AR);**
- **ReplaceServicePackageSuccessfulReturn (RSP-SR);**
- **ReplaceServicePackageFailedReturn (RSP-FR).**

**4.4.2.3** The message sequence diagram for the REPLACE\_SERVICE\_PACKAGE operation is defined by applying the following argument list to the stereotyped sequence diagram for the three-phase operation procedure pattern specified in 3.4.2.2:

threePhaseOperationProcedurePatternSequence {UM, CM, **RSP-I**,  
**RSP-AR**, **RSP-SR**, **RSP-FR**}

**4.4.2.4** The activity diagram for the `REPLACE_SERVICE_PACKAGE` operation is defined by applying the following argument list to the stereotyped activity diagram for the three-phase operation procedure pattern specified in 3.4.2.4:

```
threePhaseOperationProcedurePatternActivity {UM, CM, RSP-I,
                                             RSP-AR, RSP-SR, RSP-FR,
                                             rspRoutineTimeout,
                                             rspUrgentTimeout }
```

### 4.4.3 REQUIREMENTS

#### 4.4.3.1 UM Requirements for the `REPLACE_SERVICE_PACKAGE` Operation

The UM requirements for the **RSP** operation are defined in table 4-44.

**Table 4-44: UM Requirements for the RSP Operation**

RSPU-1	UM shall conform to all Invoker Requirements for Three-Phase Operation Procedures as specified in 3.4.2.5.1.
RSPU-2	UM shall conform to all <b>RSP-I</b> Data Set Composition and Relationship Requirements when creating and transmitting a <b>RSP-I</b> as specified in table 4-46.
RSPU-3	UM should submit <b>RSP-I</b> messages that are valid with respect to all service management validation requirements for CM as defined in table 4-3.
RSPU-4	UM shall validate that a received <b>RSP-AR</b> , <b>RSP-SR</b> , or <b>RSP-FR</b> conforms to all <b>RSP-AR</b> , <b>RSP-SR</b> , or <b>RSP-FR</b> syntactic validation requirements specified in table 4-47, table 4-48, or table 4-50, respectively. If the return fails any of the syntactic validation requirements, UM shall process the message set containing the syntactically invalid return in accordance with the Invoker Requirements for Three-Phase Operation Procedures.
RSPU-5	UM shall validate that a received <b>RSP-AR</b> , <b>RSP-SR</b> , or <b>RSP-FR</b> conforms to all <b>RSP-AR</b> , <b>RSP-SR</b> , or <b>RSP-FR</b> service management validation requirements specified in table 4-47, table 4-48, or table 4-50, respectively. If the return fails any of the service management validation requirements, UM shall process the service management-invalid return in accordance with the Invoker Requirements for Three-Phase Operation Procedures.

#### 4.4.3.2 CM Requirements for the `REPLACE_SERVICE_PACKAGE` Operation

The CM requirements for the **RSP** operation are defined in table 4-45.

**Table 4-45: CM Requirements for the RSP Operation**

RSPC-1	CM shall conform to CM requirements for the CSP operation specified in CSPC-1 and CSPC-5 through CSPC-29, with the substitution of <b>RSP-I</b> , <b>RSP-SR</b> , <b>RSP-FR</b> , and <b>RSP-AR</b> for <b>CSP-I</b> , <b>CSP-SR</b> , <b>CSP-FR</b> , and <b>CSP-AR</b> , respectively.
RSPC-2	CM shall validate that a received <b>RSP-I</b> conforms to all <b>RSP-I</b> syntactic validation requirements specified in table 4-46, Data Set Composition and Relationship Requirements for the <b>RSP-I</b> . If the <b>RSP-I</b> fails any of the syntactic requirements, CM shall process the message set containing the syntactically invalid invocation in accordance with the Performer Requirements for Three-Phase Operation Procedures.
RSPC-3	CM shall validate that a received <b>RSP-I</b> conforms to all <b>RSP-I</b> service management validation requirements specified in this table and table 4-46, Data Set Composition and Relationship Requirements for the <b>RSP-I</b> . If the <b>RSP-I</b> fails any of the service management requirements, CM shall process the message set containing the service management-invalid invocation in accordance with the Performer Requirements for Three-Phase Operation Procedures.
RSPC-4	CM shall validate that the Service Package referenced by the <code>servicePackageRef</code> parameter of the <b>RSP-I</b> : <ul style="list-style-type: none"> <li>a) has been established;</li> <li>b) has not been deleted;</li> <li>c) has not been cancelled; and</li> <li>d) is not yet executing.</li> </ul> [service management validation]
RSPC-5	CM shall validate that the <code>scheduledServicePackageStopTime</code> (for an SLS Service Package) or <code>scheduledAccessStopTime</code> (for a Retrieval Service Package) for the referenced Service Package has not already passed. [service management validation]
RSPC-6	If the <b>RSP</b> fails, CM shall retain the current Service Package.
RSPC-7	If <code>enforceOwnership</code> is 'true' in the Service Agreement, CM shall validate that the <code>smSource</code> associated with the <b>RSP-I</b> is the name of the owner of the Service Package associated with the <code>servicePackageId</code> referenced by the <code>servicePackageRef</code> in the <b>RSP-I</b> . [service management validation]
RSPC-8	CM shall conform to all <b>RSP-AR</b> , <b>RSP-SR</b> , and <b>RSP-FR</b> Data Set Composition and Relationship Requirements when creating and returning a <b>RSP-AR</b> (see table 4-47), <b>RSP-SR</b> (see table 4-48), and <b>RSP-FR</b> (see table 4-50).

#### 4.4.4 ReplaceServicePackageInvocation (RSP-I) MESSAGE (UM → CM)

##### 4.4.4.1 General

The **ReplaceServicePackageInvocation (RSP-I)** message conforms to the data set composition and relationship requirements for, and inherits the parameters of, the <<Invocation>> stereotype as specified in 3.3.5.3.2, and the <<ServicePackageRequest>> stereotype as specified in 4.3.4. Figure 4-12 shows the structure of the **RSP-I** message as a class diagram. The **RSP-I** is nearly identical to the **CSP-I** message with the single exception of the **ServicePackageIdentification** data set being replaced by a **ServicePackageReference** data set.



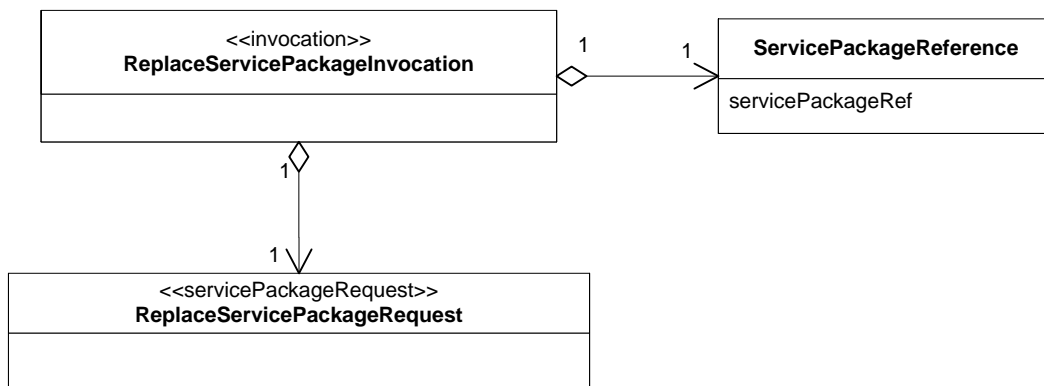

Figure 4-12: RSP-I Message Structure Presented in a Class Diagram

#### 4.4.4.2 Parameters

The contents of the **ServicePackageReference** data set are defined in table 4-17.

#### 4.4.4.3 Data Set Composition and Relationship Requirements

Table 4-46 defines the data set composition and relationship requirements for the **RSP-I** message that are in addition to those of the **<<Invocation>>** and **<<ServicePackageRequest>>** stereotypes.

Table 4-46: Data Set Composition and Relationship Requirements for RSP-I

RSPD-1	<p>An <b>RSP-I</b> shall contain</p> <ul style="list-style-type: none"> <li>a) one <b>ServicePackageReference</b> data set; and</li> <li>b) one <b>ReplaceServicePackageRequest</b> data set.</li> </ul> <p>[syntactic validation]</p>
--------	--

### 4.4.5 ReplaceServicePackageAcknowledgedReturn (RSP-AR) MESSAGE (CM → UM)

#### 4.4.5.1 General

The **ReplaceServicePackageAcknowledgedReturn (RSP-AR)** message conforms to the data set composition and relationship requirements for, and inherits the parameters of, the **<<AcknowledgedReturn>>** stereotype as specified in 3.3.5.3.3.5. Figure 4-13 shows the message structure of the **RSP-AR** as a class diagram.

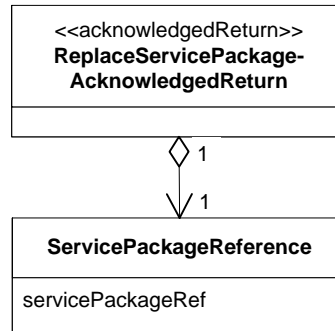

Figure 4-13: RSP-AR Message Structure Class Diagram

#### 4.4.5.2 Parameters

The contents of the **ServicePackageReference** data set are defined in table 4-17.

#### 4.4.5.3 Data Set Composition and Relationship Requirements

Table 4-47 defines the data set composition and relationship requirements for the **RSP-AR** message that are in addition to those of the <<AcknowledgedReturn>> stereotype.

Table 4-47: Data Set Composition and Relationship Requirements for RSP-AR

RSPD-2	The <b>ReplaceServicePackageAcknowledgedReturn</b> message shall contain one <b>ServicePackageReference</b> data set. [syntactic validation]
RSPD-3	The <code>servicePackageRef</code> shall have the same value as the <code>servicePackageRef</code> of the corresponding <b>RSP-I</b> . [service management validation]

#### 4.4.6 ReplaceServicePackageSuccessfulReturn (RSP-SR) MESSAGE (CM → UM)

##### 4.4.6.1 General

The **ReplaceServicePackageSuccessfulReturn (RSP-SR)** message conforms to the data set composition and relationship requirements for, and inherits the parameters of, the <<SuccessfulReturn>> stereotype, as specified in 3.3.5.3.3.2 and the <<ServicePackageResult>> stereotype, as specified in 4.3.7. Figure 4-14 shows the message structure of the **RSP-SR** as a class diagram.

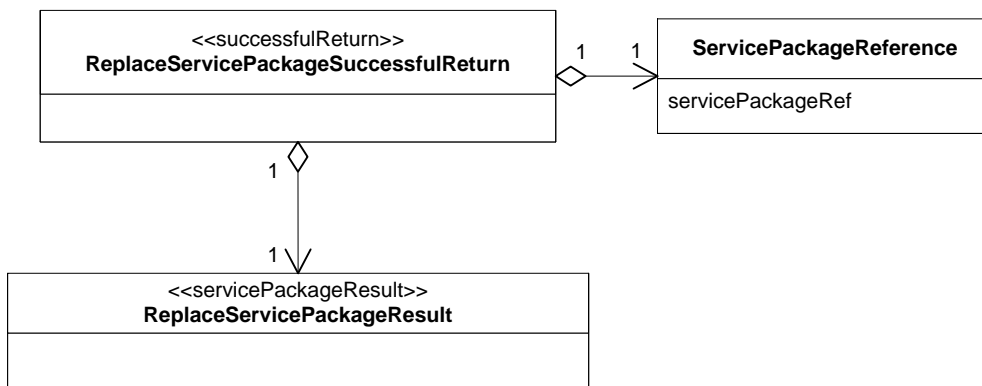

Figure 4-14: RSP-SR Message Structure Presented in a Class Diagram

#### 4.4.6.2 Parameters

The contents of the **ServicePackageReference** data set are defined in table 4-17.

#### 4.4.6.3 Data Set Composition and Relationship Requirements for RSP-SR

Table 4-48 defines the data set composition and relationship requirements for the **RSP-SR** message that are in addition to those of the <<SuccessfulReturn>> and <<ServicePackageResult>> stereotypes.

Table 4-48: Data Set Composition and Relationship Requirements for RSP-SR

RSPD-4	The <b>ReplaceServicePackageSuccessfulReturn</b> message shall contain a) one <b>ServicePackageReference</b> data set; and b) one <b>ReplaceServicePackageResult</b> data set. [syntactic validation]
RSPD-5	For the <b>ServicePackageReference</b> data set, the <code>servicePackageRef</code> shall have the same value as the <code>servicePackageRef</code> parameter of the corresponding <b>RSP-I</b> . [service management validation]

### 4.4.7 ReplaceServicePackageFailedReturn (RSP-FR) MESSAGE (CM → UM)

#### 4.4.7.1 General

The **ReplaceServicePackageFailedReturn** message conforms to the data set composition and relationship requirements for, and inherits the parameters of, the <<FailedReturnWithDenial>> stereotype, as specified in 3.3.5.3.3.4.

The class diagram for the **ReplaceServicePackageFailedReturn** message structure is shown in figure 4-15.

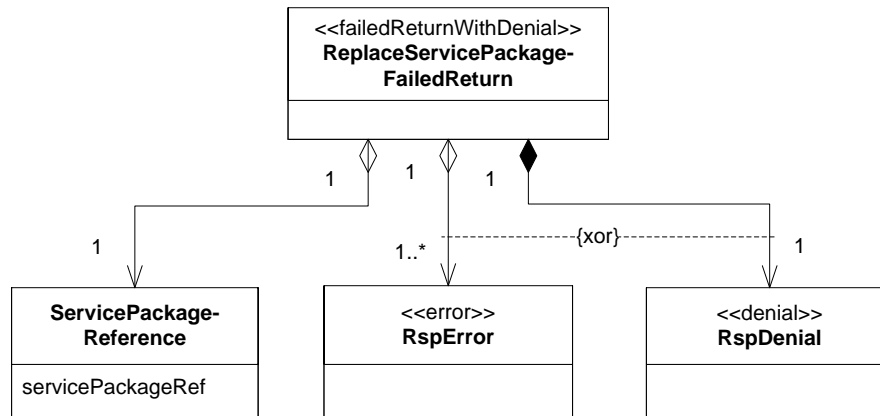

Figure 4-15: RSP-FR Message Structure Class Diagram

#### 4.4.7.2 Parameters

The contents of the **ServicePackageReference** data set are defined in table 4-17.

The **RspError** dataset of the **ReplaceServicePackageFailedReturn** message conforms to the data set composition and relationship requirements for, and inherits the parameters of, the <<Error>> data set stereotype, which contains a diagnostic parameter of the <<ErrorDiagnostic>> stereotype. The **RspError** data set diagnostic parameter includes the same values as **CspError** data set diagnostic parameter values defined in table 4-41, with the exclusion of the ‘servicePackageId already in use’ value.

In addition to the diagnostic values that are shared with the **CspError** data set, the **RspError** data set has additional diagnostic values. Table 4-49 defines the additional values of the diagnostic parameter for the **RspError** data set, identifies the CM and data set composition service management requirements that result in that diagnostic value being returned, and identifies the contents of the **erroredItem** that accompanies each diagnostic value.

**Table 4-49: Additional RspError Data Set diagnostic Parameter Definition**

diagnostic value	Definition/Description	Rqmt	Parameter or Data Set Identified by erroredItem	Content of additional Information
'referenced Service Package cancelled'	The Service Package with this identifier has been cancelled.	RSPC-4(c)	servicePackageRef	n/a
'referenced Service Package currently executing'	The Service Package with this identifier is currently executing.	RSPC-4(d)	servicePackageRef	n/a
'referenced Service Package deleted'	The Service Package with this identifier has been deleted.	RSPC-4(b)	servicePackageRef	n/a
'referenced Service Package already executed'	The referenced Service Package has already been executed by CM.	RSPC-5	servicePackageRef	n/a
'referenced Service Package unknown'	No Service Package with this identifier has ever been established at CM for the referenced Service Agreement.	RSPC-4(a)	servicePackageRef	n/a
'smSource not the owner of the Service Package'	The value of the smSource for the <b>SmMessageSet</b> containing the <b>RSP-I</b> is not the owner of the target Service Package.	RSPC-7	smSource	n/a

The **RspDenial** dataset of the **ReplaceServicePackageFailedReturn** message conforms to the data set composition and relationship requirements for, and inherits the parameters of, the <<Denial>> data set stereotype, which contains a reason parameter of the <<DenialReason>> stereotype. The **RspDenial** data set reason parameter includes the same values as **CspDenial** data set reason parameter values defined in table 4-42.

#### 4.4.7.3 Data Set Composition and Relationship Requirements

Table 4-50 defines the data set composition and relationship requirements for **RSP-FR** messages that are in addition to those of the <<FailedReturnWithDenial>> stereotype.

**Table 4-50: Data Set Composition and Relationship Requirements for RSP-FR**

RSPD-6	The <b>ReplaceServicePackageFailedReturn</b> message a) shall contain one <b>ServicePackageReference</b> data set; b) shall contain either one <b>RspDenial</b> data set or one or more <b>RspError</b> data sets. [syntactic validation]
RSPD-7	The <b>servicePackageRef</b> parameter shall contain the same value as the <b>servicePackageRef</b> parameter in the corresponding <b>RSP-I</b> . [service management validation]
RSPD-8	If the <b>RSP-I</b> fails because multiple <b>SpaceLinkEventSequenceReference</b> data sets reference Event Sequence Profiles that reference the same carrier profile (diagnostic value 'duplicate event sequences for the same carrier profile'), the <b>RSP-FR</b> shall contain one <b>RspError</b> data set for each such <b>SpaceLinkEventSequenceReference</b> data set.
RSPD-9	<b>CSP-FR</b> requirement CSPD-59 shall apply to the <b>RSP-FR</b> , with the substitution of <b>RSP-I</b> , <b>RSP-FR</b> , and <b>RspError</b> for <b>CSP-I</b> , <b>CSP-FR</b> , and <b>CspError</b> , respectively.

## 4.5 DELETE\_SERVICE\_PACKAGE (DSP) OPERATION

### 4.5.1 PURPOSE

The **DELETE\_SERVICE\_PACKAGE** (DSP) operation allows UM to delete a Service Package at a CM.

### 4.5.2 PROCEDURE

**4.5.2.1** The DSP operation is defined to be a two-phase operation in accordance with the operation procedure pattern specified in 3.4.1.

**4.5.2.2** The DSP operation is defined in terms of the following messages:

- **DeleteServicePackageInvocation** (DSP-I);
- **DeleteServicePackageSuccessfulReturn** (DSP-SR);
- **DeleteServicePackageFailedReturn** (DSP-FR).

**4.5.2.3** The message sequence diagram for the **DELETE\_SERVICE\_PACKAGE** operation is defined by applying the following argument list to the stereotyped sequence diagram for the two-phase operation procedure pattern specified in 3.4.1.2:

twoPhaseOperationProcedurePatternSequence {UM, CM, **DSP-I**, **DSP-SR**, **DSP-FR**}

**4.5.2.4** The activity diagram for the **DELETE\_SERVICE\_PACKAGE** operation is defined by applying the following argument list to the stereotyped activity diagram for the two-phase operation procedure pattern specified in 3.4.1.4:

```
twoPhaseOperationProcedurePatternActivity {UM, CM, DSP-I, DSP-SR,
DSP-FR,
dspRoutineTimeout,
dspUrgentTimeout}
```

### 4.5.3 REQUIREMENTS

#### 4.5.3.1 UM Requirements for the **DELETE\_SERVICE\_PACKAGE** Operation

The UM requirements for the **DSP** operation are defined in table 4-51.

**Table 4-51: UM Requirements for the **DSP** Operation**

DSPU-1	UM shall conform to all Invoker Requirements for Two-Phase Operation Procedures as specified in 3.4.1.5.1.
DSPU-2	UM shall conform to all <b>DSP-I</b> Data Set Composition and Relationship Requirements when creating and transmitting an <b>DSP-I</b> as specified in table 4-53.
DSPU-3	UM should transmit the <b>DSP-I</b> before expiration of the <code>minServiceDefinitionLeadTime</code> parameter of the Service Agreement.
DSPU-4	UM shall validate that a received <b>DSP-SR</b> or <b>DSP-FR</b> conforms to all <b>DSP-SR</b> or <b>DSP-FR</b> syntactic validation requirements specified in table 4-54 or table 4-56, respectively. If the return fails any of the syntactic validation requirements, UM shall process the message set containing the syntactically invalid return in accordance with the Invoker Requirements for Two-Phase Operation Procedures.
DSPU-5	UM shall validate that a received <b>DSP-SR</b> or <b>DSP-FR</b> conforms to all <b>DSP-SR</b> or <b>DSP-FR</b> service management validation requirements specified in table 4-54 or table 4-56, respectively. If the return fails any of the service management validation requirements, UM shall process the service management-invalid return in accordance with the Invoker Requirements for Two-Phase Operation Procedures.

#### 4.5.3.2 CM Requirements for the **DELETE\_SERVICE\_PACKAGE** Operation

The CM requirements for the **DSP** operation are defined in table 4-52.

**Table 4-52: CM Requirements for the DSP Operation**

DSPC-1	CM shall conform to all Performer Requirements for Two-Phase Operation Procedures as specified in 3.4.1.5.2.
DSPC-2	CM shall validate that a received <b>DSP-I</b> conforms to all <b>DSP-I</b> syntactic validation requirements specified in this table and table 4-53, Data Set Composition and Relationship Requirements for the <b>DSP-I</b> . If the <b>DSP-I</b> fails any of the syntactic requirements, CM shall process the message set containing the syntactically invalid invocation in accordance with the Performer Requirements for Two-Phase Operation Procedures.
DSPC-3	CM shall validate that the <b>DSP-I</b> conforms to all <b>DSP-I</b> service management validation requirements specified in table 4-53, Data Set Composition and Relationship Requirements. If the <b>DSP-I</b> fails any of the service management requirements, CM shall cease processing the <b>DSP-I</b> and respond to UM with a <b>DSP-FR</b> message. NOTE – The content of the <b>DSP-FR</b> depends on the nature of the validation failure, and is specified in table 4-49.
DSPC-4	CM shall validate that the <b>scheduledServicePackageStopTime</b> (for an SLS Service Package) or <b>scheduledAccessStopTime</b> (for a Retrieval Service Package) for the referenced Service Package has not already passed. [service management validation]
DSPC-5	If the Complex has locally defined <b>DSP-I</b> relationship requirements in addition to those specified in this Recommended Standard, CM shall validate that the <b>DSP-I</b> conforms to all such local requirements. [service management validation]
DSPC-6	If <b>enforceOwnership</b> is 'true' in the Service Agreement, CM shall validate that the <b>smSource</b> associated with the <b>DSP-I</b> is the name of the owner of the Service Package associated with the <b>servicePackageId</b> referenced by the <b>servicePackageRef</b> in the <b>DSP-I</b> . [service management validation]
DSPC-7	If the Complex has locally defined <b>DSP-I</b> requirements in addition to those specified in this Recommended Standard that could cause a <b>DSP-I</b> to be denied, CM shall validate that the <b>DSP-I</b> conforms to all such local requirements. [service management validation]
DSPC-8	CM shall validate that the Service Package referenced by the <b>servicePackageRef</b> parameter of the <b>DSP-I</b> : a) has been acknowledged; b) has not been deleted; and c) has not been cancelled. [service management validation]



DSPC-9	<p>If the <b>DSP-I</b> is valid, CM shall</p> <ol style="list-style-type: none"> <li>a) if the referenced Service Package has already been scheduled: <ol style="list-style-type: none"> <li>1) remove the Service Package from its operational schedule;</li> <li>2) remove the Service Package as counting against the following parameters of the Service Agreement: <ol style="list-style-type: none"> <li>i) <code>maxSlsServicePackages</code> (for SLS Service Packages);</li> <li>ii) <code>maxSlsServicePackagesPerTimePeriod</code> (for SLS Service Packages);</li> <li>iii) <code>maxRtrvlServicePackages</code> (for Retrieval Service Packages); and</li> <li>iv) <code>maxRtrvlServicePackagesPerTimePeriod</code> (for Retrieval Service Packages);</li> </ol> </li> <li>3) remove each of the transfer service instances of the Service Package as counting against the <code>maxInstancesOfTsType</code> parameter for that transfer service's type, as specified in of the Service Agreement;</li> </ol> </li> <li>b) return a <b>DSP-SR</b> message.</li> </ol> <p>NOTE – If the performance of the <b>CSP</b> operation to create (or a <b>RSP</b> operation to replace) the referenced Service Package has been acknowledged but the Service Package has not yet been scheduled, CM will also fail the CSP/RSP operation and return a <b>CSP-SR</b> (see CSPC-22, table 4-3). [perform operation]</p>
DSPC-10	<p>CM shall set the value of the <code>servicePackageRef</code> parameter of the <b>DSP-SR</b> or <b>DSP-FR</b> to the value of the <code>servicePackageId</code> parameter of the corresponding <b>DSP-I</b>.</p>
DSPC-11	<p>CM shall conform to all <b>DSP-SR</b> and <b>DSP-FR</b> Data Set Composition and Relationship Requirements when creating and transmitting a <b>DSP-SR</b> or <b>DSP-FR</b> as specified in table 4-54 and table 4-56, respectively.</p>

#### 4.5.4 DeleteServicePackageInvocation (DSP-I) MESSAGE (UM → CM)

##### 4.5.4.1 General

The **DeleteServicePackageInvocation** message conforms to the data set composition and relationship requirements for, and inherits the parameters of, the `<<Invocation>>` stereotype as specified in 3.3.5.3.2. Figure 4-16 shows the message structure of the **DSP-I** as class diagrams.

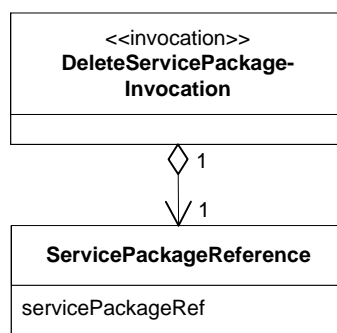

Figure 4-16: DSP-I Message Structure Class Diagram

**4.5.4.2 Parameters**

The contents of the **ServicePackageReference** data set are defined in table 4-17.

**4.5.4.3 Data Set Composition and Relationship Requirements**

Table 4-53 defines the data set composition and relationship requirements for the **DSP-I** message.

**Table 4-53: Data Set Composition and Relationship Requirements for DSP-I**

DSPD-1	The <b>DeleteServicePackageInvocation</b> message shall contain one <b>ServicePackageReference</b> data set. [syntactic validation]
--------	--

**4.5.5 DeleteServicePackageSuccessfulReturn (DSP-SR) MESSAGE (CM → UM)**

**4.5.5.1 General**

The **DeleteServicePackageSuccessfulReturn** message conforms to the data set composition and relationship requirements for, and inherits the parameters of, the <<SuccessfulReturn>> stereotype as specified in 3.3.5.3.3.2. Figure 4-17 shows the **DSP-SR** message as a class diagram.

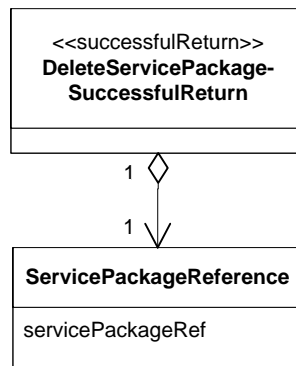

**Figure 4-17: DSP-SR Message Structure Class Diagram**

**4.5.5.2 Parameters**

The contents of the **ServicePackageReference** data set are defined in table 4-17.

### 4.5.5.3 Data Set Composition and Relationship Requirements

Table 4-54 defines the data set composition and relationship requirements for the **DSP-SR** message.

**Table 4-54: Data Set Composition and Relationship Requirements for DSP-SR**

DSPD-2	The <b>DeleteServicePackageSuccessfulReturn</b> message shall contain one <b>ServicePackageReference</b> data set. [syntactic validation]
DSPD-3	For the <b>ServicePackageReference</b> data set the <code>servicePackageRef</code> shall have the same value as the <code>servicePackageRef</code> of the <b>DSP-I</b> message. [service management validation]

## 4.5.6 DeleteServicePackageFailedReturn (DSP-FR) MESSAGE (CM→UM)

### 4.5.6.1 General

The **DeleteServicePackageFailedReturn** message conforms to the data set composition and relationship requirements for, and inherits the parameters of, the <<FailedReturn>> stereotype, as specified in table 3-10.

The class diagram for the <<DeleteServicePackageFailedReturn>> message structure is shown in figure 4-18.

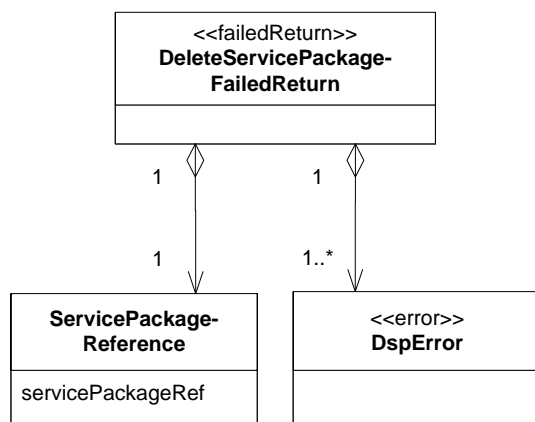

**Figure 4-18: DSP-FR Message Structure Class Diagram**

#### 4.5.6.2 Parameters

The contents of the **ServicePackageReference** data set are defined in table 4-17.

The **DspError** data set of the **DeleteServicePackageFailedReturn** message conforms to the data set composition and relationship requirements for, and inherits the parameters of, the <<Error>> data set stereotype, which contains a diagnostic parameter of the <<ErrorDiagnostic>> stereotype. Table 4-55 defines the values of the diagnostic parameter for the **DspError** data set, identifies the CM and data set composition service management requirements that result in that diagnostic value being returned, and identifies the contents of the **erroredItem** and **additional-Information** parameters that accompany each diagnostic value.

**Table 4-55: DspError Data Set diagnostic Parameter Definition**

diagnostic value	Definition/Description	Rqmt	Parameter or Data Set Identified by erroredItem	Content of additional Information
'operation timeout'	See table 3-11.	2PP-0103b		
'referenced service Package unknown'	No Service Package with this identifier has ever been acknowledged at CM for the referenced Service Agreement.	DSPC-8(a)	service-PackageRef	n/a
'referenced Service Package deleted'	The Service Package with this identifier has been deleted.	DSPC-8(b)	service-PackageRef	n/a
'referenced Service Package cancelled'	The Service Package with this identifier has been cancelled.	DSPC-8(c)	service-PackageRef	n/a
'referenced Service Package already executed'	The referenced Service Package has already been executed by CM.	DSPC-4	service-PackageRef	n/a
'smSource not the owner of the Service Package'	The value of the <b>smSource</b> for the <b>SmMessageSet</b> containing the <b>DSP-I</b> is not the owner of the target Service Package.	DSPC-6	smSource	n/a
'other'	The operation has failed due to an error that is local to the Service Agreement.	DSPC-5	The invalid parameter or data set that causes the violation	Text-string description of the local error

#### 4.5.6.3 Data Set Composition and Relationship Requirements

Table 4-56 defines the data set composition and relationship requirements common for **DSP-FR** messages that are in addition to those of the <<FailedReturn>> stereotype.

**Table 4-56: Data Set Composition and Relationship Requirements for DSP-FR**

DSPD-4	The <b>DeleteServicePackageFailedReturn</b> message a) shall contain one <b>ServicePackageReference</b> data set; b) shall contain one or more <b>DspError</b> data sets. [syntactic validation]
DSPD-5	For the <b>ServicePackageReference</b> data set the <code>servicePackageRef</code> shall have the same value as the <code>servicePackageRef</code> in the <b>DSP-I</b> message. [service management validation]

## 4.6 SELECT\_ALTERNATE\_SCENARIO (SAS) OPERATION

### 4.6.1 PURPOSE

The `SELECT_ALTERNATE_SCENARIO` (SAS) operation allows UM to request CM to configure the prime scenario of a specified Service Package to one of the alternate scenario defined by the Service Package.

### 4.6.2 PROCEDURE

**4.6.2.1** The SAS operation is defined to be a two-phase operation in accordance with the operation procedure pattern specified in 3.4.1.

**4.6.2.2** The SAS operation is defined in terms of the following messages:

- **SelectAlternateScenarioInvocation (SAS-I);**
- **SelectAlternateScenarioSuccessfulReturn (SAS-SR);**
- **SelectAlternateScenarioFailedReturn (SAS-FR).**

**4.6.2.3** The message sequence diagram for the `SELECT_ALTERNATE_SCENARIO` operation is defined by applying the following argument list to the stereotyped sequence diagram for the two-phase operation procedure pattern specified in 3.4.1.2:

```
twoPhaseOperationProcedurePatternSequence {UM, CM, SAS-I, SAS-SR,  
                                             SAS-FR}
```

**4.6.2.4** The activity diagram for the `SELECT_ALTERNATE_SCENARIO` operation is defined by applying the following argument list to the stereotyped activity diagram for the two-phase operation procedure pattern specified in 3.4.1.4:

```
twoPhaseOperationProcedurePatternActivity {UM, CM, SAS-I,  
                                           SAS-SR, SAS-FR,  
                                           sasRoutineTimeout,  
                                           sasUrgentTimeout}
```

### 4.6.3 REQUIREMENTS

#### 4.6.3.1 UM Requirements for the **SELECT\_ALTERNATE\_SCENARIO** Operation

The UM requirements for the **SAS** operation are defined in table 4-57.

**Table 4-57: UM Requirements for the SAS Operation**

SASU-1	UM shall conform to all Invoker Requirements for Two-Phase Operation Procedures as specified in 3.4.1.5.1.
SASU-2	UM shall conform to all <b>SAS-I</b> Data Set Composition and Relationship Requirements when creating and transmitting an <b>SAS-I</b> as specified in table 4-60.
SASU-3	UM should transmit the <b>SAS-I</b> before expiration of <code>minServiceDefinitionLeadTime</code> , but may transmit the <b>SAS-I</b> for a Service Package in execution.
SASU-4	UM shall validate that a received <b>SAS-SR</b> or <b>SAS-FR</b> conforms to all <b>SAS-SR</b> or <b>SAS-FR</b> syntactic validation requirements specified in table 4-62 or table 4-65, respectively. If the return fails any of the syntactic validation requirements, UM shall process the message set containing the syntactically invalid return in accordance with the Invoker Requirements for Two-Phase Operation Procedures.
SASU-5	UM shall validate that a received <b>SAS-SR</b> or <b>SAS-FR</b> conforms to all <b>SAS-SR</b> or <b>SAS-FR</b> service management validation requirements specified in table 4-62 or table 4-65, respectively. If the return fails any of the service management validation requirements, UM shall process the service management-invalid return in accordance with the Invoker Requirements for Two-Phase Operation Procedures.

#### 4.6.3.2 CM Requirements for the **SELECT\_ALTERNATE\_SCENARIO** Operation

The CM requirements for the **SAS** operation are defined in table 4-58.

**Table 4-58: CM Requirements for the SAS Operation**

SASC-1	CM shall conform to all Performer Requirements for Two-Phase Operation Procedures as specified in 3.4.1.5.2.
SASC-2	CM shall validate that a received <b>SAS-I</b> conforms to all <b>SAS-I</b> syntactic validation requirements specified in table 4-60, Data Set Composition and Relationship Requirements for the <b>SAS-I</b> . If the <b>SAS-I</b> fails any of the syntactic requirements, CM shall process the message set containing the syntactically invalid invocation in accordance with the Performer Requirements for Two-Phase Operation Procedures.
SASC-3	CM shall validate that the <b>SAS-I</b> conforms to all <b>SAS-I</b> service management validation requirements specified in this table and table 4-60, Data Set Composition and Relationship Requirements. If the <b>SAS-I</b> fails any of the service management requirements, CM shall cease processing the <b>SAS-I</b> and respond to UM with an <b>SAS-FR</b> message. The content of the <b>SAS-FR</b> depends on the nature of the validation failure, and is specified in table 4-64.
SASC-4	If the Complex has locally defined <b>SAS-I</b> relationship requirements in addition to those specified in this Recommend Standard, CM shall validate that the <b>SAS-I</b> conforms to all such local requirements. [service management validation]

SASC-5	If the Complex has locally defined <b>SAS-I</b> requirements in addition to those specified in this Recommended Standard that could cause a <b>SAS-I</b> to be denied, CM shall validate that the <b>SAS-I</b> conforms to all such local requirements. [service management validation]
SASC-6	If <code>enforceOwnership</code> is 'true' in the Service Agreement, CM shall validate that the <code>smSource</code> associated with the <b>SAS-I</b> is the name of the owner of the Service Package associated with the <code>servicePackageId</code> referenced by the <code>servicePackageRef</code> in the <b>SAS-I</b> . [service management validation]
SASC-7	CM shall validate that the <b>scheduledServicePackageStopTime</b> for the referenced Service Package has not already passed. [service management validation]
SASC-8	CM shall validate that the Service Package referenced by the <code>servicePackageRef</code> parameter of the <b>SAS-I</b> : a) has been established; b) has not been deleted; and c) has not been cancelled. [service management validation]
SASC-9	If the <b>SAS-I</b> is valid, CM shall a) set the <code>primeScenarioRef</code> of the Service Package referenced by <code>servicePackageRef</code> to be that of the <code>primeScenarioRef</code> of the <b>SAS-I</b> ; b) if the Service Package referenced by <code>servicePackageRef</code> of the <b>SAS-I</b> is in execution, adjust all internal equipment to provide services as indicated by the <code>primeScenarioRef</code> of the <b>SAS-I</b> message; c) return a <b>SAS-SR</b> . [perform operation]
SASC-10	CM shall set the value of the <code>servicePackageRef</code> parameter of the <b>SAS-SR</b> or <b>SAS-FR</b> to the value of the <code>servicePackageRef</code> parameter of the <b>SAS-I</b> .
SASC-11	CM shall conform to all <b>SAS-SR</b> and <b>SAS-FR</b> Data Set Composition and Relationship Requirements when creating and transmitting an <b>SAS-SR</b> or <b>SAS-FR</b> as specified in table 4-62 and table 4-65, respectively.

#### 4.6.4 **SelectAlternateScenarioInvocation (SAS-I) MESSAGE (UM → CM)**

##### 4.6.4.1 General

The **SelectAlternateScenarioInvocation** message conforms to the data set composition and relationship requirements for, and inherits the parameters of, the <<Invocation>> stereotype as specified in 3.3.5.3.2. Figure 4-19 shows the message structure of the **SAS-I** as class diagrams.

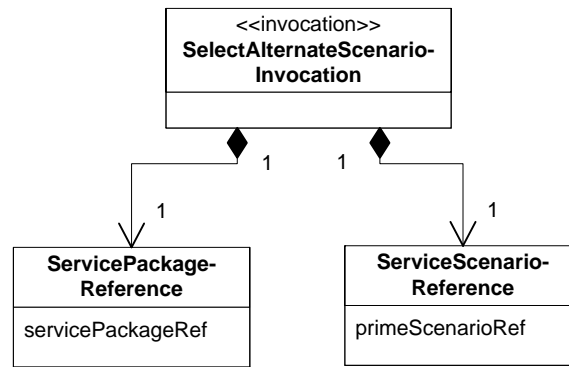

Figure 4-19: SAS-I Message Structure Presented in a Class Diagram

#### 4.6.4.2 Parameters

The contents of the **ServicePackageReference** data set are defined in table 4-17.

Table 4-59 defines the contents of the **ServiceScenarioReference** data set for the **SAS-I**.

Table 4-59: ServiceScenarioReference Data Set (SAS-I)

Parameter Name	Parameter Definition/Description	Data Type	Data Units	Applicable Service Agreement Parameter
primeScenarioRef	Contains the value of the primeScenarioRef that the referenced Service Package shall use at the time of Service Package execution or to which it shall immediately switch if the Service Package is already in execution.	String256	n/a	n/a

#### 4.6.4.3 Data Set Composition and Relationship Requirements

Table 4-60 defines the data set composition and relationship requirements for the **SAS-I** message.

Table 4-60: Data Set Composition and Relationship Requirements for SAS-I

SASD-1	The <b>SELECT_ALTERNATE_SCENARIO</b> Invocation message shall contain a) one <b>ServicePackageReference</b> data set; b) one <b>ServiceScenarioReference</b> data set. [syntactic validation]
SASD-2	For the <b>ServiceScenarioReference</b> data set the primeScenarioRef shall contain the value of one of the scenarioId parameters of the Service Package referenced by the servicePackageRef. [service management validation]



#### 4.6.5 `SelectAlternateScenarioSuccessfulReturn` (SAS-SR) MESSAGE (CM → UM)

##### 4.6.5.1 General

The `SelectAlternateScenarioSuccessfulReturn` message conforms to the data set composition and relationship requirements for, and inherits the parameters of, the `<<SuccessfulReturn>>` stereotype as specified in 3.3.5.3.3.2. Figure 4-20 shows the message structure of the SAS-SR as a class diagrams.

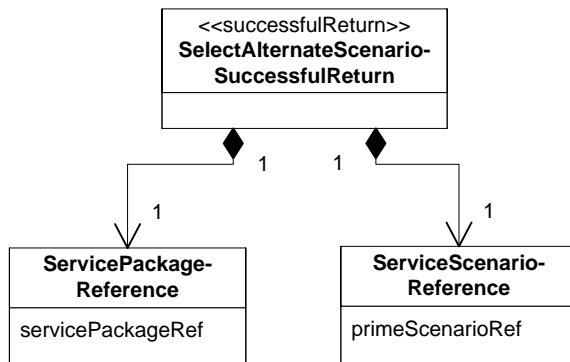

**Figure 4-20: SAS-SR Message Structure Presented in a Class Diagram**

##### 4.6.5.2 Parameters

The contents of the `ServicePackageReference` data set are defined in table 4-17.

Table 4-61 defines the contents of the `ServiceScenarioReference` data set for the SAS-SR.

**Table 4-61: serviceScenarioReference Data Set (SAS-SR)**

Parameter Name	Parameter Definition/Description	Data Type	Data Units	Applicable Service Agreement Parameter
primeScenarioRef	Contains the value of the primeScenarioRef of the corresponding SAS-I message. Represents a confirmation of the service scenario that shall be used at the time of Service Package execution or to which the Service Package shall immediately be switched if the Service Package is already in execution.	String256	n/a	n/a

4.6.5.3 Data Set Composition and Relationship Requirements

Table 4-62 defines the data set composition and relationship requirements for the **SAS-SR** message.

**Table 4-62: Data Set Composition and Relationship Requirements for SAS-SR**

SASD-3	The <b>SELECT_ALTERNATE_SCENARIO</b> Successful Return message shall contain a) one <b>ServicePackageReference</b> data set; b) one <b>ServiceScenarioReference</b> data set. [syntactic validation]
SASD-4	For the <b>ServicePackageReference</b> data set the <code>servicePackageRef</code> shall have the same value as the <code>servicePackageRef</code> parameter of the <b>SAS-I</b> message. [service management validation]
SASD-5	For the <b>ServiceScenarioReference</b> data set the <code>primeScenarioRef</code> shall have the same value as the <code>primeScenarioRef</code> parameter of the <b>SAS-I</b> message. [service management validation]

4.6.6 SelectAlternateScenarioFailedReturn (SAS-FR) MESSAGE (CM → UM)

4.6.6.1 General

The **SelectAlternateScenarioFailedReturn** message conforms to the data set composition and relationship requirements for, and inherits the parameters of, the `<<FailedReturnWithDenial>>` stereotype, as specified in 3.3.5.3.3.4.

The class diagram for the **SelectAlternateScenarioFailedReturn** message structure is shown in figure 4-21.

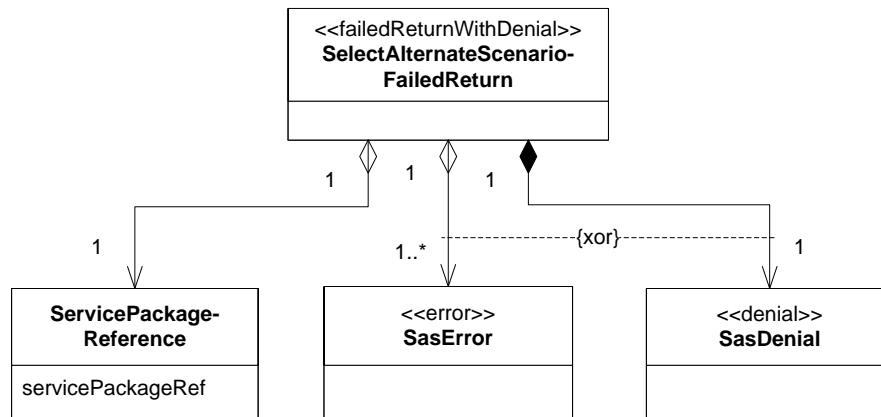

**Figure 4-21: SAS-FR Message Structure Presented as a Class Diagram**

#### 4.6.6.2 Parameters

The contents of the **ServicePackageReference** data set are defined in table 4-17.

The **SasError** dataset of the **SelectAlternateScenarioFailedReturn** message conforms to the data set composition and relationship requirements for, and inherits the parameters of, the <<Error>> data set stereotype, which contains a diagnostic parameter of the <<ErrorDiagnostic>> stereotype. Table 4-63 defines the values of the diagnostic parameter for the **SasError** data set, identifies the CM and data set composition service management requirements that result in that diagnostic value being returned, and identifies the contents of the **erroredItem** and **additionalInformation** parameters that accompany each diagnostic value.

**Table 4-63: SasError Data Set diagnostic Parameter Definition**

Diagnostic value	Definition/Description	Rqmt	Parameter or Data Set Identified by erroredItem	Content of additional Information
'operation timeout'	See table 3-11.	2PP-0103b		
'referenced Service Package Unknown'	No Service Package with this identifier has ever been established at CM for the referenced Service Agreement.	SASC-8(a)	servicePackageRef	n/a
'referenced Service Package already executed'	The referenced Service Package has already been executed by CM.	SASC-7	servicePackageRef	n/a
'referenced Service Package deleted'	The Service Package with this identifier has been deleted.	SASC-8(b)	servicePackageRef	n/a
'referenced Service Package cancelled'	The Service Package with this identifier has been cancelled.	SASC-8(c)	servicePackageRef	n/a
'scenario reference unknown'	The referenced scenario does not match any scenario of the referenced Service Package.	SASD-2	scenarioRef	n/a
'smSource not the owner of the Service Package'	The value of the <b>smSource</b> for the <b>SmMessageSet</b> containing the <b>SAS-I</b> is not the owner of the target Service Package.	SASC-6	smSource	n/a
'other'	The operation has failed due to an error that is local to the Service Agreement.	SASC-4	The invalid parameter or data set that causes the violation	Text-string description of the local error

The **SasDenial** dataset of the **SelectAlternateScenarioFailedReturn** message conforms to and inherits the parameters of the <<Denial>> data set stereotype, which contains a **reason** parameter of the <<DenialReason>> stereotype. Table 4-64 defines the additional values of the **reason** parameter for the **SasDenial** data set, identifies the CM and data set composition service management requirements that result in that **reason** value being returned, and identifies the contents of the **deniedItem** and **additionalInformation** parameters that accompany each **reason** value.

**Table 4-64: SasDenial Data Set reason Parameter Definition**

reason value	Definition/Description	Rqmt	Parameter or Data Set Identified by deniedItem	Content of additional Information
'other'	The operation has been denied for a reason that is local to the Service Agreement.	SASC-5	The invalid parameter or data set that causes the violation	Text-string description of the local denial reason

### 4.6.6.3 Data Set Composition and Relationship Requirements

Table 4-65 defines the data set composition and relationship requirements common for **SAS-FR** messages that are in addition to those of the <<FailedReturnWithDenial>> stereotype.

**Table 4-65: Data Set Composition and Relationship Requirements for SAS-FR**

SASD-6	The <b>SelectAlternateScenarioFailedReturn</b> message a) shall contain one <b>ServicePackageReference</b> data set; b) shall contain either one <b>SasDenial</b> data set or one or more <b>SasError</b> data sets. [syntactic validation]
SASD-7	For the <b>ServicePackageReference</b> data set the <code>servicePackageRef</code> shall have the same value as the <code>servicePackageRef</code> in the <b>SAS-I</b> message. [service management validation]

## 4.7 APPLY\_NEW\_TRAJECTORY (ANT) OPERATION

### 4.7.1 PURPOSE

The **APPLY\_NEW\_TRAJECTORY (ANT)** operation allows UM to apply a new (or different) trajectory to an existing Service Package at CM. The trajectory being applied to the existing Service Package must already exist at CM.

### 4.7.2 PROCEDURE

**4.7.2.1** The ANT operation is defined to be a three-phase operation in accordance with the operation procedure pattern specified in 3.4.2.

**4.7.2.2** The ANT operation is defined in terms of the following messages:

- **ApplyNewTrajectoryInvocation (ANT-I);**
- **ApplyNewTrajectorySuccessfulReturn (ANT-SR);**
- **ApplyNewTrajectoryFailedReturn (ANT-FR);**
- **ApplyNewTrajectoryAcknowledgedReturn (ANT-AR).**

**4.7.2.3** The message sequence diagram for the `APPLY_NEW_TRAJECTORY` operation is defined by applying the following argument list to the stereotyped sequence diagram for the three-phase operation procedure pattern specified in 3.4.2.2:

```
threePhaseOperationProcedurePatternSequence {UM, CM, ANT-I,
                                             ANT-AR, ANT-SR, ANT-FR}
```

**4.7.2.4** The activity diagram for the `APPLY_NEW_TRAJECTORY` operation is defined by applying the following argument list to the stereotyped activity diagram for the three-phase operation procedure pattern specified in 3.4.2.4:

```
threePhaseOperationProcedurePatternActivity {UM, CM, ANT-I,
                                             ANT-AR, ANT-SR, ANT-FR,
                                             antRoutineTimeout,
                                             antUrgentTimeout }
```

## 4.7.3 REQUIREMENTS

### 4.7.3.1 UM Requirements for the `APPLY_NEW_TRAJECTORY` Operation

The UM requirements for the **ANT** operation are defined in table 4-66.

**Table 4-66: UM Requirements for the **ANT** Operation**

ANTU-1	UM shall conform to all Invoker Requirements for Three-Phase Operation Procedures as specified in 3.4.2.5.1.
ANTU-2	UM shall conform to all <b>ANT-I</b> Data Set Composition and Relationship Requirements when creating and transmitting an <b>ANT-I</b> as specified in table 4-69.
ANTU-3	UM should submit <b>ANT-I</b> messages that are valid with respect to all service management validation requirements for CM as defined in table 4-67.
ANTU-4	UM shall validate that a received <b>ANT-SR</b> , <b>ANT-FR</b> , or <b>ANT-AR</b> conforms to all <b>ANT-SR</b> , <b>ANT-FR</b> , or <b>ANT-AR</b> syntactic validation requirements specified in table 4-70, table 4-71, and table 4-72, respectively. If the return fails any of the syntactic validation requirements, UM shall process the message set containing the syntactically invalid return in accordance with the Invoker Requirements for Three-Phase Operation Procedures. [syntactic validation]
ANTU-5	UM shall validate that a received <b>ANT-SR</b> , <b>ANT-FR</b> , or <b>ANT-AR</b> conforms to all <b>ANT-SR</b> , <b>ANT-FR</b> , or <b>ANT-AR</b> service management validation requirements specified in table 4-70, table 4-71, and table 4-72, respectively. If the return fails any of the service management validation requirements, UM shall process the service management invalid return in accordance with the Invoker Requirements for Three-Phase Operation Procedures. [service management validation]

### 4.7.3.2 CM Requirements for the APPLY\_NEW\_TRAJECTORY Operation

The CM requirements for the **ANT** operation are defined in table 4-67.

**Table 4-67: CM Requirements for the ANT Operation**

ANTC-1	CM shall conform to all Performer Requirements for Three-Phase Operation Procedures as specified in 3.4.2.5.1.
ANTC-2	CM shall validate that a received <b>ANT-I</b> conforms to all <b>ANT-I</b> syntactic validation requirements specified in table 4-69, Data Set Composition and Relationship Requirements for the <b>ANT-I</b> . If the <b>ANT-I</b> fails any of the syntactic requirements, CM shall process the message set containing the syntactically invalid invocation in accordance with the Performer Requirements for Three-Phase Operation Procedures.
ANTC-3	CM shall validate that the <b>ANT-I</b> conforms to all <b>ANT-I</b> service management validation requirements specified in this table and table 4-69, Data Set Composition and Relationship Requirements for the <b>ANT-I</b> . If the <b>ANT-I</b> fails any of the service management requirements, CM shall cease processing the <b>ANT-I</b> and respond to UM with an <b>ANT-FR</b> message. The content of the <b>ANT-FR</b> depends on the nature of the validation failure, and is specified in table 4-72 and table 4-73.
ANTC-4	If the Complex has locally defined <b>ANT-I</b> relationship requirements in addition to those specified in this Recommend Standard, CM shall validate that the <b>ANT-I</b> conforms to all such local requirements. [service management validation]
ANTC-5	If the Complex has locally defined <b>ANT-I</b> requirements in addition to those specified in this Recommended Standard that could cause a <b>ANT-I</b> to be denied, CM shall validate that the <b>ANT-I</b> conforms to all such local requirements. [service management validation]
ANTC-6	If <code>enforceOwnership</code> is 'true' in the Service Agreement, CM shall validate that the <code>smSource</code> associated with the <b>ANT-I</b> is the name of the owner of the Service Package associated with the <code>servicePackageId</code> referenced by the <code>servicePackageRef</code> in the <b>ANT-I</b> . [service management validation]
ANTC-7	If CM is unable to validate and perform the <b>ANT</b> operation prior to expiration of <code>minServiceDefinitionLeadTime</code> , CM may terminate the operation and issue an <b>ANT-FR</b> . [service management validation]
ANTC-8	CM shall validate that the <code>scheduledServicePackageStopTime</code> for the referenced Service Package has not already passed. [service management validation]
ANTC-9	CM shall validate that the Service Package referenced by the <code>servicePackageRef</code> parameter of the <b>ANT-I</b> : <ul style="list-style-type: none"> <li>a) has been established;</li> <li>b) has not been deleted; and</li> <li>c) has not been cancelled.</li> </ul> [service management validation]
ANTC-10	If the <b>ANT-I</b> is valid, CM shall update all affected Service Scenarios in the Service Package to reference the new Trajectory Prediction and send an <b>ANT-SR</b> message to UM. [Perform operation]
ANTC-11	CM shall conform to all <b>ANT-SR</b> , <b>ANT-FR</b> and <b>ANT-AR</b> Data Set Composition and Relationship Requirements when creating and transmitting a <b>ANT-SR</b> , <b>ANT-FR</b> and <b>ANT-AR</b> , as specified in table 4-70, table 4-71, and table 4-72, respectively.

#### 4.7.4 ApplyNewTrajectoryInvocation (ANT-I) MESSAGE (UM → CM)

##### 4.7.4.1 General

The **ApplyNewTrajectoryInvocation** (**ANT-I**) message conforms to the data set composition and relationship requirements for, and inherits the parameters of, the <<Invocation>> stereotype, as specified in 3.3.5.3.2. Figure 4-22 shows the message structure of the **ANT-I** as a class diagram.

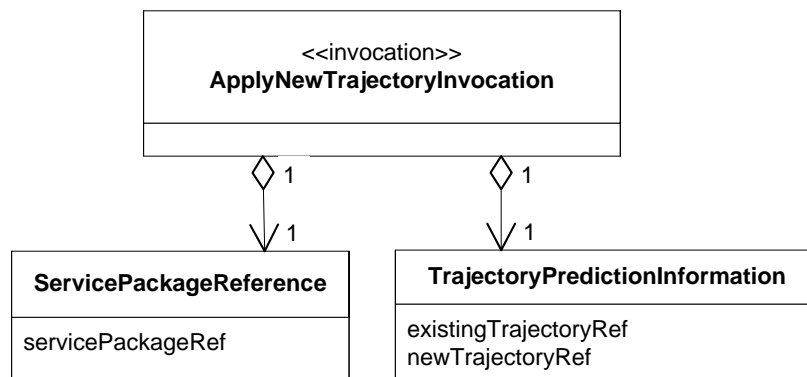

**Figure 4-22: ANT-I Message Structure Class Diagram**

#### 4.7.4.2 Parameters

The **ServicePackageReference** data set is defined in table 4-17.

The **TrajectoryPredictionInformation** data set is defined in table 4-68.

**Table 4-68: TrajectoryPredictionInformation Data Set**

Name	Definition/Description	Data Type	Units	Applicable Service Agreement Parameter
existingTrajectoryRef	Contains the value of a trajectoryId that identifies the Trajectory Prediction currently referenced by one or more Service Scenarios in the Service Package.	String256	n/a	n/a
newTrajectoryRef	Contains value of a trajectoryId that identifies the Trajectory Prediction that is to replace the existingTrajectoryRef for one or more Service Scenarios in the Service Package.	String256	n/a	n/a

#### 4.7.4.3 Data Set Composition and Relationship Requirements

Table 4-69 defines the data set composition and relationship requirements for the **ANT-I** message.

**Table 4-69: Data Set Composition and Relationship Requirements for ANT-I**

ANTD-1	The <b>ANT-I</b> shall contain one <b>ServicePackageReference</b> data set and one <b>TrajectoryPredictionInformation</b> data set. [syntactic validation]
ANTD-2	The parameter existingTrajectoryRef shall match the value trajectoryRef in one or more <b>ServiceScenarioResult</b> data sets in the Service Package identified by parameter servicePackageRef. [service management validation]
ANTD-3	The parameter newTrajectoryRef shall have the value of a trajectoryId that identifies a Trajectory Prediction that both (a) is available at CM for the referenced Service Agreement and (b) covers the time span required by the Service Package. [service management validation]



## 4.7.5 ApplyNewTrajectoryAcknowledgedReturn (ANT-AR) MESSAGE (CM→UM)

### 4.7.5.1 General

The **ApplyNewTrajectoryAcknowledgedReturn (ANT-AR)** message conforms to the data set composition and relationship requirements for, and inherits the parameters of, the <<AcknowledgedReturn>> stereotype, as specified in 3.3.5.3.3.5. Figure 4-23 shows the message structure of the **ANT-AR** as a class diagram.

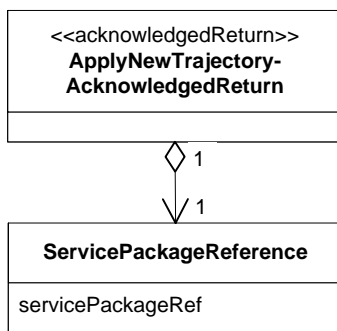

**Figure 4-23: ANT-AR Message Structure Class Diagram**

### 4.7.5.2 Parameters

The **ServicePackageReference** data set is defined in table 4-17.

### 4.7.5.3 Data Set Composition and Relationship Requirements

Table 4-70 defines the data set composition and relationship requirements for the **ANT-AR** message.

**Table 4-70: Data Set Composition and Relationship Requirements for ANT-AR**

ANTD-4	The <b>ApplyNewTrajectoryAcknowledgedReturn</b> message shall contain one <b>ServicePackageReference</b> data set. [syntactic validation]
ANTD-5	The <code>servicePackageRef</code> shall have the same value as the <code>servicePackageRef</code> of the corresponding <b>ANT-I</b> . [service management validation]

**4.7.6 ApplyNewTrajectorySuccessfulReturn (ANT-SR) MESSAGE (CM→UM)**

**4.7.6.1 General**

The **ApplyNewTrajectorySuccessfulReturn (ANT-SR)** message conforms to the data set composition and relationship requirements for, and inherits the parameters of, the <<SuccessfulReturn>> stereotype, as specified in 3.3.5.3.3.2, and the <<ServicePackageResult>> stereotype, as specified in 4.3.7. Figure 4-24 shows the message structure of the **ANT-SR** as a class diagram.

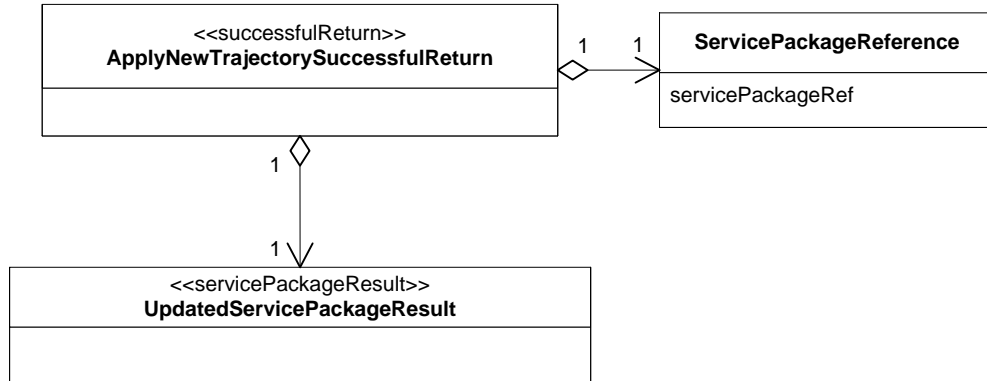

**Figure 4-24: ANT-SR Message Structure Presented in a Class Diagram**

**4.7.6.2 Parameters**

The contents of the **ServicePackageReference** data set are defined in table 4-17.

**4.7.6.3 Data Set Composition and Relationship Requirements**

Table 4-71 defines the data set composition and relationship requirements for the **ANT-SR** message that are in addition to those of the <<SuccessfulReturn>> and <<ServicePackageResult>> stereotypes.

**Table 4-71: Data Set Composition and Relationship Requirements for ANT-SR**

ANTD-6	The <b>ApplyNewTrajectorySuccessfulReturn</b> message shall contain: a) one <b>ServicePackageReference</b> data set; and b) one <b>UpdatedServicePackageResult</b> data set. [syntactic validation]
ANTD-7	For the <b>ServicePackageReference</b> data set, the <code>servicePackageRef</code> shall have the same value as the <code>servicePackageRef</code> parameter of the corresponding <b>ANT-I</b> . [service management validation]

#### 4.7.7 ApplyNewTrajectoryFailedReturn (ANT-FR) MESSAGE (CM → UM)

##### 4.7.7.1 General

The **ApplyNewTrajectoryFailedReturn (ANT-FR)** message conforms to the data set composition and relationship requirements for, and inherits the parameters of, the <<FailedReturnWithDenial>> stereotype, as specified in 3.3.5.3.3.4.

Figure 4-25 shows the message structure of the **ANT-FR** as a class diagram.

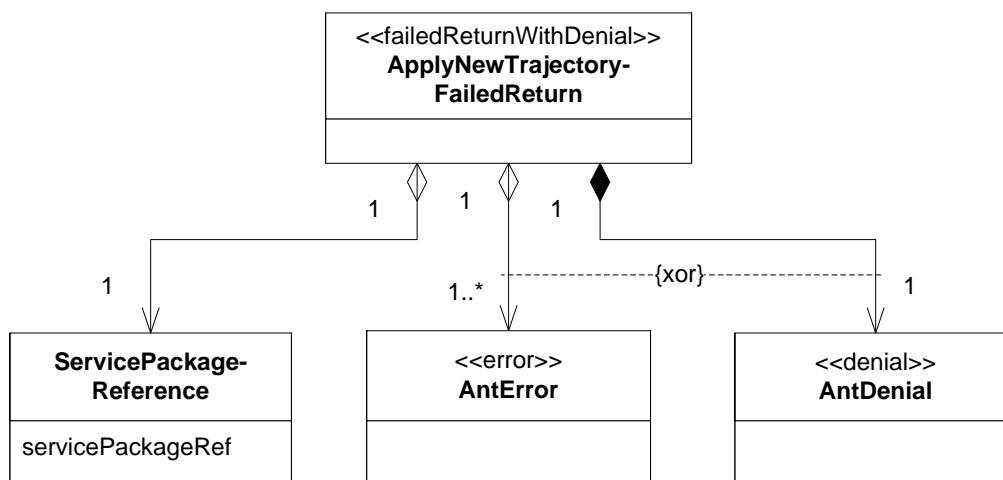

Figure 4-25: ANT-FR Message Structure Class Diagram

##### 4.7.7.2 Parameters

The contents of the **ServicePackageReference** data set are defined in table 4-17.

The **AntError** dataset of the **ApplyNewTrajectoryFailedReturn** message conforms to the data set composition and relationship requirements for, and inherits the parameters of, the <<Error>> data set stereotype, which contains a diagnostic parameter of the <<ErrorDiagnostic>> stereotype. Table 4-72 defines the additional values of the diagnostic parameter for the **AntError** data set, identifies the CM and data set composition service management requirements that result in that diagnostic value being returned, and identifies the contents of the `erroredItem` and `additionalInformation` parameters that accompany each diagnostic value.

**Table 4-72: AntError Data Set diagnostic Parameter Definition**

diagnostic value	Definition/Description	Rqmt	Parameter or Data Set Identified by erroredItem	Content of additional Information
'existingTrajectoryRef does not match any Service Scenario'	The parameter existingTrajectoryRef does not match the value of parameter trajectoryRef in any of the <b>ServiceScenario-Result</b> data sets in the Service Package identified by parameter servicePackageRef.	ANTD-2	existingTrajectoryRef	n/a
'smSource not the owner of the Service Package'	The value of the smSource for the <b>SmMessageSet</b> containing the <b>ANT-I</b> is not the owner of the target Service Package.	ANTC-6	smSource	n/a
'newTrajectoryRef non-existent'	There is no Trajectory Prediction with the identifier newTrajectoryRef registered at CM for the referenced Service Agreement.	ANTD-3	existingTrajectoryRef	not required
'operation timeout'	See table 3-11.	3PP-0104b	n/a	n/a
'referenced Service Package unknown'	No Service Package with this identifier has ever been established at CM for the referenced Service Agreement.	ANTC-9a	servicePackageRef	n/a
'referenced Service Package already executed'	The referenced Service Package has already been executed by CM.	ANTC-8	servicePackageRef	n/a
'referenced Service Package deleted'	The Service Package with this identifier has been deleted.	ANTC-9b	servicePackageRef	n/a
'referenced Service Package cancelled'	The Service Package with this identifier has been cancelled.	ANTC-9c	servicePackageRef	n/a
'other'	The operation has failed due to an error that is local to the Service Agreement.	ANTC-4	The invalid parameter or data set that causes the violation	Text-string description of the local error

The **AntDenial** dataset of the **ApplyNewTrajectoryFailedReturn** message conforms to the data set composition and relationship requirements for, and inherits the parameters of, the <<Denial>> data set stereotype, which contains a reason parameter of the <<DenialReason>> stereotype. Table 4-73 defines the additional values of the reason parameter for the **AntDenial** data set, identifies the CM and data set composition service management requirements that result in that reason value being returned, and identifies the contents of the deniedItem and additionalInformation parameters that accompany each reason value.

**Table 4-73: AntDenial Data Set reason Parameter Definition**

reason value	Definition/ Description	Rqmt	Parameter or Data Set Identified by deniedItem	Content of additional Information
'minService-DefinitionLead-Time expired'	CM is unable to perform the ANT operation in time for either a pending or executing Service Package.	ANTC-7	servicePackageRef	n/a
'other'	The operation is denied for a reason that is local to the Service Agreement.	ANTC-5	The invalid parameter or data set that causes the violation	Text-string description of the local denial reason.

### 4.7.7.3 Data Set Composition and Relationship Requirements

Table 4-74 defines the data set composition and relationship requirements for the **ANT-FR** message that are in addition to those of the <<FailedReturnWithDenial>> stereotype.

**Table 4-74: Data Set Composition and Relationship Requirements for ANT-FR**

ANTD-8	The <b>ApplyNewTrajectoryFailedReturn</b> message a) shall contain one <b>ServicePackageReference</b> data set; b) shall contain either one <b>AntDenial</b> data set or one or more <b>AntError</b> data sets. [syntactic validation]
ANTD-9	The <b>servicePackageRef</b> parameter shall contain the same value as the <b>servicePackageRef</b> parameter in the corresponding <b>ANT-I</b> . [service management validation]

## 4.8 SERVICE\_PACKAGE\_CANCELLED (SPC) OPERATION

### 4.8.1 PURPOSE

The **SERVICE\_PACKAGE\_CANCELLED (SPC)** Operation allows CM to notify UM that it has cancelled a Service Package from its operational schedule.

### 4.8.2 PROCEDURE

**4.8.2.1** The SPC operation is defined to be a notify operation in accordance with the operation procedure pattern specified in 3.4.3.

**4.8.2.2** The SPC operation is defined in terms of the following messages:

- **ServicePackageCancelledNotification (SPC-N);**
- **ServicePackageCancelledConfirmation (SPC-C).**

**4.8.2.3** The message sequence diagram for the `SERVICE_PACKAGE_CANCELLED` operation is defined by applying the following argument list to the stereotyped sequence diagram for the notify operation procedure pattern specified in 3.4.3.2:

```
notifyOperationProcedurePatternSequence {CM, UM, SPC-N, SPC-C}
```

**4.8.2.4** The activity diagram for the `SERVICE_PACKAGE_CANCELLED` operation is defined by applying the following argument list to the stereotyped activity diagram for the notify operation procedure pattern specified in 3.4.3.4:

```
notifyOperationProcedurePatternActivity {CM, UM, SPC-N, SPC-C}
```

### 4.8.3 REQUIREMENTS

#### 4.8.3.1 UM Requirements for the `SERVICE_PACKAGE_CANCELLED` Operation

The UM requirements for the `SPC` operation are defined in table 4-75.

**Table 4-75: UM Requirements for the `SPC` Operation**

SPCU-1	UM shall conform to all Recipient Requirements for Notify Operation Procedures as specified in 3.4.3.5.2.
SPCU-2	UM shall validate that a received <code>SPC-N</code> conforms to all <code>SPC-N</code> syntactic validation requirements specified in table 4-78. If the notification fails any of the syntactic validation requirements, UM shall process the message set containing the syntactically invalid notification in accordance with the Recipient Requirements for Notify Operation Procedures as defined in table 3-40.
SPCU-3	UM shall validate that a received <code>SPC-N</code> conforms to all <code>SPC-N</code> service management validation requirements specified in this table and table 4-78. If the notification fails any of the service management validation requirements, UM shall process the service management-invalid notification in accordance with the Recipient Requirements for Notify Operation Procedures as defined in table 3-40.
SPCU-4	If the <code>servicePackageRef</code> does not match the <code>servicePackageId</code> for any Service Package within the context of the referenced Service Agreement, UM <ol style="list-style-type: none"> <li>shall cease processing the <code>SPC-N</code>;</li> <li>should contact CM via means outside of this Recommended Standard.</li> </ol> [service management validation]
SPCU-5	If the <code>SPC-N</code> is valid, UM shall <ol style="list-style-type: none"> <li>remove the Service Package from its operational schedule;</li> <li>remove the Service Package as counting against the following parameters of the Service Agreement:           <ol style="list-style-type: none"> <li><code>maxSlsServicePackages</code> (for an SLS Service Package);</li> <li><code>maxSlsServicePackagesPerTimePeriod</code> (for an SLS Service Package);</li> <li><code>maxRtrvlServicePackages</code> (for a Retrieval Service Package); and</li> <li><code>maxRtrvlServicePackagesPerTimePeriod</code> (for a Retrieval Service Package);</li> </ol> </li> <li>remove each of the transfer service instances of the Service Package as counting against the <code>maxInstancesOfTsType</code> parameter for that transfer service's type, as specified in the Service Agreement;</li> <li>return a <code>SPC-C</code>.</li> </ol> [confirm operation]
SPCU-6	UM shall conform to all <code>SPC-C</code> Data Set Composition and Relationship Requirements when creating and transmitting an <code>SPC-C</code> as specified in table 4-79.

### 4.8.3.2 CM Requirements for the **SERVICE\_PACKAGE\_CANCELLED** Operation

The CM requirements for the **SPC** operation are defined in table 4-76.

**Table 4-76: CM Requirements for the SPC Operation**

SPCC-1	CM shall conform to all Notifier Requirements for Notify Operation Procedures as specified in 3.4.3.5.1.
SPCC-2	CM shall conform to all <b>SPC-N</b> Data Set Composition and Relationship Requirements when creating and transmitting an <b>SPC-N</b> as specified in table 4-78.
SPCC-3	Upon occurrence of an event that requires the Service Package to be cancelled, CM shall <ol style="list-style-type: none"> <li>a) remove the Service Package from its operational schedule;</li> <li>b) remove the Service Package as counting against the following parameters of the Service Agreement:             <ol style="list-style-type: none"> <li>1) maxSlsServicePackages (for SLS Service Packages);</li> <li>2) maxSlsServicePackagesPerTimePeriod (for SLS Service Packages);</li> <li>3) maxRtrvlServicePackages (for Retrieval Service Packages); and</li> <li>4) maxRtrvlServicePackagesPerTimePeriod (for Retrieval Service Packages);</li> </ol> </li> <li>c) Transmit a <b>SPC-N</b>.</li> </ol> <p>[perform operation]</p>
SPCC-4	CM shall validate that a received <b>SPC-C</b> conforms to all <b>SPC-C</b> syntactic validation requirements specified in table 4-79. If the confirmation fails any of the syntactic validation requirements, CM shall process the message set containing the syntactically invalid confirmation in accordance with the Notifier Requirements for Notify Operation Procedures as defined in table 3-39.
SPCC-5	CM shall validate that a received <b>SPC-C</b> conforms to all <b>SPC-C</b> service management validation requirements specified in table 4-79. If the confirmation fails any of the service management validation requirements, CM shall process the service management-invalid confirmation in accordance with the Notifier Requirements for Notify Operation Procedures as defined in table 3-39.

#### 4.8.4 ServicePackageCancelledNotification (SPC-N) MESSAGE (CM→UM)

##### 4.8.4.1 General

The **ServicePackageCancelledNotification** message conforms to the data set composition and relationship requirements for, and inherits the parameters of, the <<Notification>> stereotype as specified in 3.3.5.3.4. Figure 4-26 shows the message structure of the **SPC-N** as class diagrams.

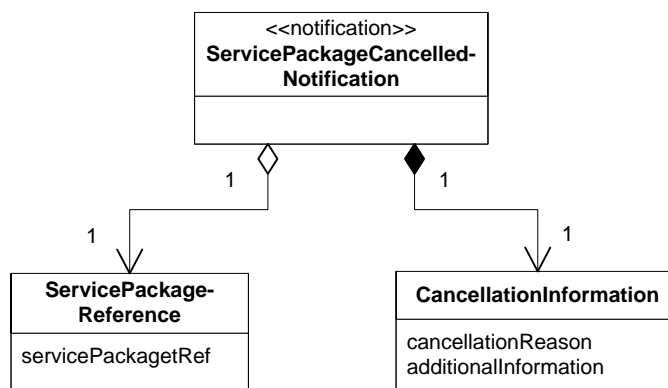

Figure 4-26: SPC-N Message Structure Class Diagram

##### 4.8.4.2 Parameters

The contents of the **ServicePackageReference** data set are defined in table 4-17.

Table 4-77 defines those parameters unique to the **SPC-N** message.



**Table 4-77: CancellationInformation Data Set (SPC-N)**

Parameter Name	Parameter Definition/Description	Data Type	Data Units	Applicable Service Agreement Parameter
additional-Information	Elaboration on the cancellation reason.	String256	n/a	n/a
cancellation-Reason	<p>Reason for cancellation of Service Package. Legal values are:</p> <ul style="list-style-type: none"> <li>– ‘deferred Service Package parameter(s) not supplied’– Deferred Service Package parameters were not supplied as of the expiration of minServiceDefinitionLeadTime;</li> <li>– ‘sufficient resources are no longer available’;</li> <li>– ‘environmental conditions preclude delivery of services’;</li> <li>– ‘trajectory prediction(s) not available to support Service Package’–One or more trajectory predictions referenced by the Service Package were not available to support the complete* Service Package as of the expiration of minServiceDefinitionLeadTime;</li> <li>– ‘other’.</li> </ul> <p>NOTE – The referenced trajectory prediction(s) must be available for the complete time span from (scheduledServicePackageStartTime – trajectoryPredictionTimeWindowExtension) through (scheduledServicePackageStopTime + t trajectoryPredictionTimeWindowExtension) in order for the Trajectory Prediction to be used to support the Service Package.</p>	Enum	n/a	n/a

**4.8.4.3 Data Set Composition and Relationship Requirements**

Table 4-78 defines the data set composition and relationship requirements for the **SPC-N** message.

**Table 4-78: Data Set Composition and Relationship Requirements for SPC-N**

SPCD-1	The <b>ServicePackageCancelledNotification</b> message a) shall contain one <b>ServicePackageReference</b> data set; b) shall contain one <b>CancellationInformation</b> data set. [syntactic validation]
SPCD-2	For the <b>ServicePackageReference</b> data set the <code>servicePackageRef</code> shall have the same value as the <code>servicePackageId</code> parameter of a Service Package, as conveyed in the original <b>CSP-I</b> , that is pending execution, or is currently executing. [service management validation]

**4.8.5 ServicePackageCancelledConfirmation (SPC-C) MESSAGE (UM→CM)**

**4.8.5.1 General**

The **ServicePackageCancelledConfirmation** message conforms to the data set composition and relationship requirements for, and inherits the parameters of, the <<Confirmation>> stereotype as specified in 3.3.5.3.5. Figure 4-27 shows the message structure of the **SPC-C** as class diagrams.

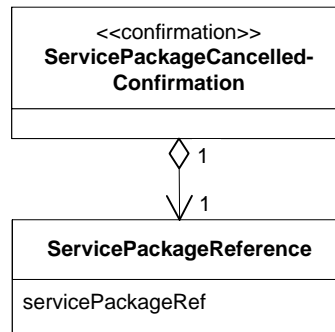

**Figure 4-27: SPC-C Message Structure Class Diagram**

**4.8.5.2 Parameters**

The contents of the **ServicePackageReference** data set are defined in table 4-17.

### 4.8.5.3 Data Set Composition and Relationship Requirements

Table 4-79 defines the data set composition and relationship requirements for the **SPC-C** message.

**Table 4-79: Data Set Composition and Relationship Requirements for SPC-C**

SPCD-3	The <b>ServicePackageCancelledConfirmation</b> message shall contain one <b>ServicePackageReference</b> data set. [syntactic validation]
SPCD-4	The <code>servicePackageRef</code> parameter shall contain the same value as the <code>servicePackageRef</code> parameter in the corresponding <b>SPC-N</b> . [service management validation]

## 4.9 SERVICE\_PACKAGE\_MODIFIED (SPM) OPERATION

### 4.9.1 PURPOSE

The **SERVICE\_PACKAGE\_MODIFIED** (SPM) allows CM to notify UM about minor modifications applied to a Space Link Session Service Package as a result of changing conditions at CM. The nature of the modifications is such that CM may continue with a commitment to provide service that would otherwise necessitate a **SERVICE\_PACKAGE\_CANCELLED**. Examples of the minor modifications are:

- change to a different antenna with equivalent capabilities as that originally selected;
- changes in `scheduledSpaceCommServiceStartTime` and `scheduledSpaceCommServiceStopTime` for one or more carriers that are still within the respective `spaceCommServiceStartTimeLead` and `spaceCommServiceStartTimeLag` constraints of the effective **CREATE\_SERVICE\_PACKAGE** or **REPLACE\_SERVICE\_PACKAGE** operation and continue to meet the needs of the `minimumServiceDuration`.

### NOTES

- 1 This implies that CM retains the information content of the **CSP-I** or **RSP-I** that created the Service Package, in order to be able to effectively implement the **SPM** Operation.
- 2 It is possible via the UM parameterization of the **CREATE\_SERVICE\_PACKAGE** and/or **REPLACE\_SERVICE\_PACKAGE** operations to disallow CM from performing the **SERVICE\_PACKAGE\_MODIFIED** Operation; if this is the case, CM has no choice but to perform a **SERVICE\_PACKAGE\_CANCELLED** Operation for the changed conditions. For example, if the **CSP-I** specified `antennaSelection = requiredAntennaRef`, then if there is a need to change the antenna, CM would have to cancel rather than modify the Service Package.

## 4.9.2 PROCEDURE

**4.9.2.1** The SPM operation is defined to be a notify operation in accordance with the operation procedure pattern specified in 3.4.3.

**4.9.2.2** The SPM operation is defined in terms of the following messages:

- **ServicePackageModifiedNotification (SPM-N);**
- **ServicePackageModifiedConfirmation (SPM-C).**

**4.9.2.3** The message sequence diagram for the SERVICE\_PACKAGE\_MODIFIED operation is defined by applying the following argument list to the stereotyped sequence diagram for the notify operation procedure pattern specified in 3.4.3.2:

notifyOperationProcedurePatternSequence {CM, UM, **SPM-N**, **SPM-C**}

**4.9.2.4** The activity diagram for the SERVICE\_PACKAGE\_MODIFIED operation is defined by applying the following argument list to the stereotyped activity diagram for the notify operation procedure pattern specified in 3.4.3.4:

notifyOperationProcedurePatternActivity {CM, UM, **SPM-N**, **SPM-C**}

## 4.9.3 REQUIREMENTS

### 4.9.3.1 UM Requirements for the SERVICE\_PACKAGE\_MODIFIED Operation

The UM requirements for the **SPM** operation are defined in table 4-80.

**Table 4-80: UM Requirements for SPM Operation**

SPMU-1	UM shall conform to all Recipient Requirements for Notify Operation Procedures as specified in 3.4.3.5.2.
SPMU-2	UM shall validate that a received <b>SPM-N</b> conforms to all <b>SPM-N</b> syntactic validation requirements specified in table 4-84, Data Set Composition and Relationship Requirements for the <b>SPM-N</b> . If the <b>SPM-N</b> fails any of the syntactic requirements, UM shall process the message set containing the syntactically invalid <b>SPM-N</b> in accordance with the Recipient Requirements for Notify Operation Procedures as defined in table 3-40.
SPMU-3	UM shall validate that a received <b>SPM-N</b> conforms to all <b>SPM-N</b> service management validation requirements specified in this table and table 4-84. If the notification fails any of the service management validation requirements, UM shall process the service management-invalid notification in accordance with the Recipient Requirements for Notify Operation Procedures as defined in table 3-40.
SPMU-4	If the <b>SPM-N</b> passes all syntactic and service management validation, UM shall update its schedule of operations and internal equipment in accordance with the information conveyed in the <b>SPM-N</b> and send a <b>SPM-C</b> message to CM. [confirm operation]
SPMU-5	UM shall conform to all <b>SPM-C</b> Data Set Composition and Relationship Requirements when creating and transmitting a <b>SPM-C</b> as specified in table 4-85.

### 4.9.3.2 CM Requirements for the **SERVICE\_PACKAGE\_MODIFIED** Operation

The CM requirements for the **SPM** operation are defined in table 4-81.

**Table 4-81: CM Requirements for the SPM Operation**

SPMC-1	CM shall conform to all <b>SPM-N</b> Data Set Composition and Relationship Requirements when creating and transmitting an <b>SPM-N</b> as specified in table 4-84.
SPMC-2	CM shall conform to all Notifier Requirements for Notify Operation Procedures as specified in 3.4.3.5.1.
SPMC-3	CM shall perform a <b>SERVICE_PACKAGE_MODIFIED</b> Operation for modification in relation to only the following Service Package parameters: <ul style="list-style-type: none"> <li>a) <code>scheduledServicePackageStartTime</code>;</li> <li>b) <code>scheduledServicePackageStopTime</code>;</li> <li>c) <code>scheduledSpaceCommServiceStartTime</code>;</li> <li>d) <code>scheduledSpaceCommServiceStopTime</code>;</li> <li>e) <code>scheduledCarrierStartTime</code>;</li> <li>f) <code>scheduledCarrierStopTime</code>;</li> <li>g) <code>assignedAntennaRef</code>;</li> <li>h) <code>providerId</code>;</li> <li>i) <code>providerPortId</code>.</li> </ul>
SPMC-4	When performing a <b>SERVICE_PACKAGE_MODIFIED</b> operation, CM shall create a modified Service Package that meets the following conditions: <ul style="list-style-type: none"> <li>a) the <code>scheduledSpaceCommServiceStartTime</code> of each resulting <b>SpaceCommunicationServiceResult</b> shall be within the limits of the <code>spaceCommServiceStartTimeLead</code> and <code>spaceCommServiceStartTimeLag</code> parameters of the corresponding original <b>SpaceCommunicationServiceRequest</b>;</li> <li>b) the <code>scheduledStartTime</code> and <code>scheduledSpaceCommServiceStopTime</code> of each resulting <b>SpaceCommunicationServiceResult</b> data set shall satisfy the <code>minimumServiceDuration</code> parameter of the corresponding original <b>SpaceCommunicationServiceRequest</b>;</li> <li>c) any change to <code>antennaAssignment</code> in a <b>SpaceCommunicationServiceResult</b> shall meet the antenna constraints that were applied to the corresponding original <b>SpaceCommunicationServiceRequest</b>;</li> <li>d) any change to <code>antennaAssignment</code> shall indicate and provide for an antenna that is consistent with the Carrier Profile and Service Agreement as referenced by Service Package;</li> <li>e) any change to the modifiable parameters (as defined by SPMC-3) shall be compatible with <b>RSpaceLinkEventsResult</b> and <b>FSpaceLinkEventsResult</b> data sets, if specified in the Service Package, such that CM will accommodate the event(s) at the time(s) specified;</li> <li>f) any change to the modifiable parameters (as defined by SPMC-3) shall be compatible with <b>RSpaceLinkEvents</b> and <b>FSpaceLinkEvents</b> Data Sets, if referenced (via <code>spaceLinkEventsProfileRef</code> parameters) in the Service Package, such that CM will properly execute the event sequence profile at the times specified.</li> </ul> <p>[service management validation]</p>
SPMC-5	If CM cannot meet conditions defined by SPMC-4 and service cannot be provided without modifications to the Service Package CM shall not perform a <b>SERVICE_PACKAGE_MODIFIED</b> Operation but shall perform a <b>SERVICE_PACKAGE_CANCELLED</b> Operation (see 4.8).

SPMC-6	<p>In addition to the parameter changes allowed by the <code>SERVICE_PACKAGE_MODIFIED</code> Operation (as defined by SPMC-4), CM shall indicate and include modifications in the <b>SPM-N</b> as follows:</p> <ul style="list-style-type: none"> <li>a) any change to any <code>scheduledSpaceCommServiceStartTime</code> or <code>scheduledSpaceCommServiceStopTime</code> shall also include appropriate updates in the <code>scheduledServiceInstanceStartTime</code> and <code>scheduledServiceInstanceStopTime</code> parameters such that the <code>startTimeOffset</code> and <code>stopTimeOffset</code> parameters of the pending Service Package are satisfied;</li> <li>b) any change to <code>assignedAntennaRef</code> shall also include appropriate updates to the <code>providerId</code> and <code>providerPortId</code> parameters such that the SLE Transfer Services can operate properly.</li> </ul>
SPMC-7	CM should transmit the <b>SPM-N</b> before the <code>minServiceDefinitionLeadTime</code> .
SPMC-8	CM shall validate that a received <b>SPM-C</b> , conforms to all <b>SPM-C</b> syntactic validation requirements specified in table 4-85. If the confirmation fails any of the syntactic validation requirements, CM shall process the syntactically invalid confirmation in accordance with the Notifier Requirements for Notify Operation Procedures.
SPMC-9	CM shall validate that a received <b>SPM-C</b> conforms to all <b>SPM-C</b> service management validation requirements specified in table 4-85. If the confirmation fails any of the service management validation requirements, CM shall process the service management-invalid confirmation in accordance with the Notifier Requirements for Notify Operation Procedure as defined in table 3-39.

#### 4.9.4 ServicePackageModifiedNotification (SPM-N) MESSAGE (CM→UM)

##### 4.9.4.1 General

The **ServicePackageModifiedNotification** message conforms to the data set composition and relationship requirements for, and inherits the parameters of, the <<Notification>> stereotype as specified in 3.3.5.3.4, and the <<ServicePackageResult>> stereotype, as specified in 4.3.7. Figure 4-28 shows the message structure of the **SPM-N** as a class diagram.

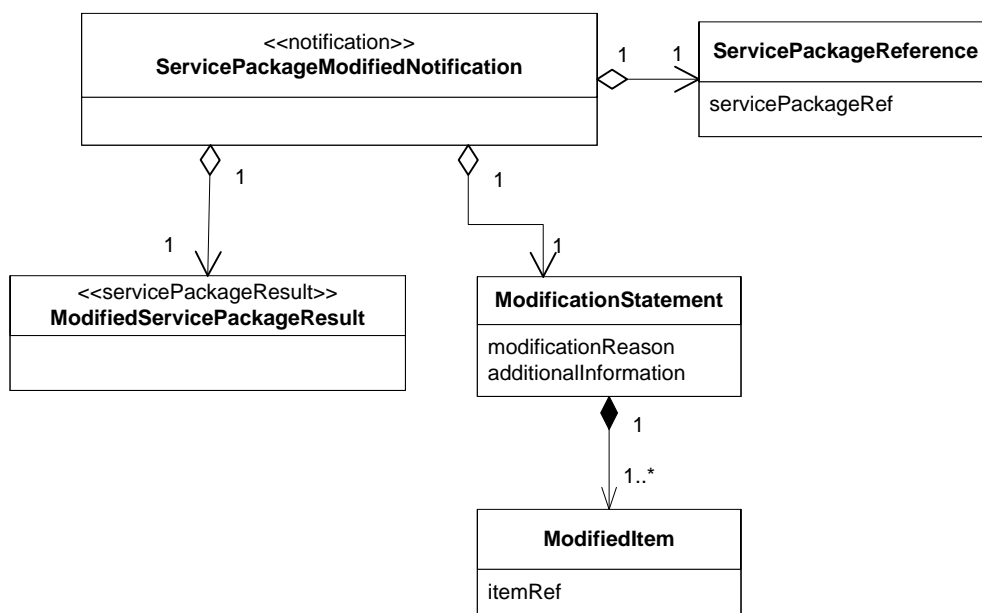

Figure 4-28: SPM-N Message Structure Presented in a Class Diagram

##### 4.9.4.2 Parameters

Table 4-82 defines the **ModificationStatement** data set, and table 4-83 defines the **ModifiedItem** data set.

**Table 4-82: ModificationStatement Data Set**

Parameter Name	Parameter Definition/Description	Data Type	Data Units	Applicable Service Agreement Parameter
additionalInformation	Text string that provides further information about the modificationReason.	String256 or NULL	n/a	n/a
modificationReason	Reason the Service Package has been modified. Possible values are: <ul style="list-style-type: none"> <li>– ‘antennaChange’—in order to provide service a change in antenna assignment has occurred; there is no change in service times; there may be related changes in providerId and/or providerPortId;</li> <li>– ‘scheduleChange’—in order to provide service a change in service time has occurred; there is no change to assigned antenna; there may be related changes in providerId and/or providerPortId;</li> <li>– ‘antennaAndScheduleChange’—in order to provide service a change in both antenna assignment and service time has occurred; there may be related changes in providerId and/or providerPortId;</li> <li>– ‘providerIdChange’ —in order to provide service a change in providerId has occurred; there are no changes to assigned antenna or service time;</li> <li>– ‘providerPortIdChange’ —in order to provide service a change in providerPortId has occurred; there are no changes to assigned antenna or service time;</li> <li>– ‘trajectoryPredictionConformance’ – the currently referenced Trajectory Prediction cannot be supported by the originally scheduled Service Package; there may be changes to scheduled start and stop times, antennaId, providerId, and/or providerPortId;</li> <li>– ‘other’—modification is for a reason other than those stated above.</li> </ul>	Enum	n/a	n/a

The contents of the **ServicePackageReference** data set are defined in table 4-17.



**Table 4-83: ModifiedItem Data Set**

Parameter Name	Parameter Definition/Description	Data Type	Data Units	Applicable Service Agreement Parameter
itemRef	Contains the Distinguished Name of the parameter that has been modified. The naming of the parameter includes any references or identifications such that it is unambiguous.	String	n/a	n/a

#### 4.9.4.3 Data Set Composition and Relationship Requirements

Table 4-84 defines the data set composition and relationship requirements for the **SPM-N** message.

**Table 4-84: Data Set Composition and Relationship Requirements for SPM-N**

SPMD-1	The <b>ServicePackageModifiedNotification</b> message shall contain a) one <b>ServicePackageReference</b> data set; b) one <b>ModifiedServicePackageResult</b> data set; c) one <b>ModificationStatement</b> data set. [syntactic validation]
SPMD-2	The <b>ModificationStatement</b> data set a) may have null content for the <b>additionalInformation</b> parameter when the <b>modificationReason</b> is one of 'antennaChange', 'scheduleChange' or 'antennaAndScheduleChange'; b) shall include a non-null <b>additionalInformation</b> parameter if the <b>modificationReason</b> parameter have a value of 'other'; c) shall contain a <b>ModifiedItem</b> data set for each parameter that has been modified. [syntactic validation]
SPMD-3	For the <b>ServicePackageReference</b> data set the <b>servicePackageRef</b> shall have the same value as the <b>servicePackageId</b> parameter of a scheduled Service Package. [service management validation]

**4.9.5 ServicePackageModifiedConfirmation (SPM-C) MESSAGE (UM→CM)**

**4.9.5.1 General**

Figure 4-29 shows the message structure of the **SPM-C** as class diagrams.

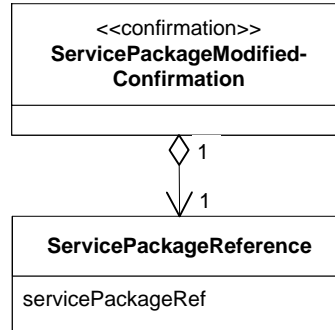

**Figure 4-29: SPM-C Message Structure Class Diagram**

**4.9.5.2 Parameters**

The **ServicePackageModifiedConfirmation** message conforms to the data set composition and relationship requirements for, and inherits the parameters of, the <<Confirmation>> stereotype as specified in 3.3.5.3.5.

**4.9.5.3 Data Set Composition and Relationship Requirements for SPM-C**

Table 4-85 defines the data set composition and relationship requirements for the **SPM-C** message.

**Table 4-85: Data Set Composition and Relationship Requirements for SPM-C**

SPMD-4	The <b>ServicePackageModifiedConfirmationReturn</b> message shall contain one <b>ServicePackageReference</b> data set. [syntactic validation]
SPMD-5	The <code>servicePackageRef</code> parameter shall contain the same value as the <code>servicePackageRef</code> parameter in the corresponding <b>SPM-N</b> . [service management validation]

## 4.10 QUERY\_SERVICE\_PACKAGE (QSP) OPERATION

### 4.10.1 PURPOSE

The `QUERY_SERVICE_PACKAGE (QSP)` operation allows UM to query the content of an existing Service Package at the CM.

### 4.10.2 PROCEDURE

**4.10.2.1** The `QSP` operation is defined to be a two-phase operation in accordance with the operation procedure pattern specified in 3.4.1.

**4.10.2.2** The `QSP` operation is defined in terms of the following messages:

- `QueryServicePackageInvocation (QSP-I)`;
- `QueryServicePackageSuccessfulReturn (QSP-SR)`;
- `QueryServicePackageFailedReturn (QSP-FR)`.

**4.10.2.3** The message sequence diagram for the `QUERY_SERVICE_PACKAGE` operation is defined by applying the following argument list to the stereotyped sequence diagram for the two-phase operation procedure pattern specified in 3.4.1.2:

```
twoPhaseOperationProcedurePatternSequence {UM, CM, QSP-I, QSP-SR,
                                           QSP-FR}
```

**4.10.2.4** The activity diagram for the `QUERY_SERVICE_PACKAGE` operation is defined by applying the following argument list to the stereotyped activity diagram for the two-phase operation procedure pattern specified in 3.4.1.4:

```
twoPhaseOperationProcedurePatternActivity {UM, CM, QSP-I,
                                             QSP-SR, QSP-FR,
                                             qspRoutineTimeout,
                                             qspUrgentTimeout}
```

### 4.10.3 REQUIREMENTS

#### 4.10.3.1 UM Requirements for the `QUERY_SERVICE_PACKAGE` Operation

The UM requirements for the `QSP` operation are defined in table 4-86.

**Table 4-86: UM Requirements for `QSP` Operation**

QSPU-1	UM shall conform to all Invoker Requirements for Two-Phase Operation Procedures as specified in 3.4.1.5.1.
QSPU-2	UM shall conform to all <code>QSP-I</code> Data Set Composition and Relationship Requirements when creating and transmitting an <code>QSP-I</code> as specified in table 4-88.
QSPU-3	UM shall validate that a received <code>QSP-SR</code> or <code>QSP-FR</code> conforms to <code>QSP-SR</code> or <code>QSP-FR</code> syntactic validation requirements specified in table 4-89 or table 4-90, respectively. If the return fails any of the syntactic validation requirements, UM shall process the message set containing the syntactically invalid return in accordance with the Invoker Requirements for Two-Phase Operation Procedures.
QSPU-4	UM shall validate that a received <code>QSP-SR</code> or <code>QSP-FR</code> conforms to all <code>QSP-SR</code> or <code>QSP-FR</code> service management validation requirements specified in table 4-89 or table 4-90, respectively. If the return fails any of the service management validation requirements, UM shall process the service management-invalid return in accordance with the Invoker Requirements for Two-Phase Operation Procedures.

#### 4.10.3.2 CM Requirements for the `QUERY_SERVICE_PACKAGE` Operation

The CM requirements for the `QSP` operation are defined in table 4-87.

**Table 4-87: CM Requirements for `QSP` Operation**

QSPC-1	CM shall conform to all Performer Requirements for Two-Phase Operation Procedures as specified in 3.4.1.5.2.
QSPC-2	CM shall validate that a received <code>QSP-I</code> conforms to all <code>QSP-I</code> syntactic validation requirements specified in table 4-88, Data Set Composition and Relationship Requirements for the <code>QSP-I</code> . If the <code>QSP-I</code> fails any of the syntactic requirements, CM shall process the message set containing the syntactically invalid invocation in accordance with the Performer Requirements for Two-Phase Operation Procedures.
QSPC-3	CM shall validate that the <code>QSP-I</code> conforms to all <code>QSP-I</code> service management validation requirements specified in this table and table 4-88, Data Set Composition and Relationship Requirements. If the <code>QSP-I</code> fails any of the service management requirements, CM shall cease processing the <code>QSP-I</code> and respond to UM with an <code>QSP-FR</code> message. The content of the <code>QSP-FR</code> depends on the nature of the validation failure, and is specified in table 4-90.
QSPC-4	If the Complex has locally defined <code>QSP-I</code> relationship requirements in addition to those specified in this Recommended Standard, CM shall validate that the <code>QSP-I</code> conforms to all such local requirements. [service management validation]
QSPC-5	CM shall validate that the <code>scheduledServicePackageStopTime</code> for the referenced Service Package has not already passed. [service management validation]

QSPC-6	CM shall validate that the Service Package referenced by the <code>servicePackageRef</code> parameter of the <b>QSP-I</b> : a) has been established; b) has not been deleted; and c) has not been cancelled. [service management validation]
QSPC-7	If the <b>QSP-I</b> is valid, CM shall return the requested Service Package in a <b>QSP-SR</b> . [Perform operation]
QSPC-8	CM shall conform to all <b>QSP-SR</b> and <b>QSP-FR</b> Data Set Composition and Relationship Requirements when creating and transmitting an <b>QSP-SR</b> and <b>QSP-FR</b> as specified in table 4-89 or table 4-91, respectively.

#### 4.10.4 QueryServicePackageInvocation (QSP-I) MESSAGE (UM → CM)

##### 4.10.4.1 General

The **QueryServicePackageInvocation** message conforms to the data set composition and relationship requirements for, and inherits the parameters of, the `<<Invocation>>` stereotype as specified in 3.3.5.3.2. Figure 4-30 shows the message structure of the **QSP-I** as class diagrams.

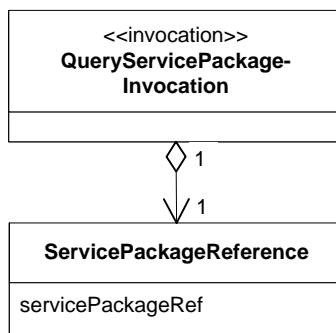

Figure 4-30: QSP-I Message Structure Class Diagram

##### 4.10.4.2 Parameters

The contents of the **ServicePackageReference** data set are defined in table 4-17.

### 4.10.4.3 Data Set Composition and Relationship Requirements

Table 4-88 defines the data set composition and relationship requirements for the **QSP-I** message.

**Table 4-88: Data Set Composition and Relationship Requirements for QSP-I**

QSPD-1	The <b>QSP-I</b> message shall contain one <b>ServicePackageReference</b> data set. [syntactic validation]
--------	---

### 4.10.5 QueryServicePackageSuccessfulReturn (QSP-SR) MESSAGE (CM→UM)

#### 4.10.5.1 General

The **QueryServicePackageSuccessfulReturn** message conforms to the data set composition and relationship requirements for, and inherits the parameters of, the <<SuccessfulReturn>> stereotype as specified in 3.3.5.3.3.2, and the <<ServicePackageResult>> stereotype as specified in 4.3.7, except as specified in QSPD-4 in table 4-89. Figure 4-31 shows the **QSP-SR** message as a class diagram.

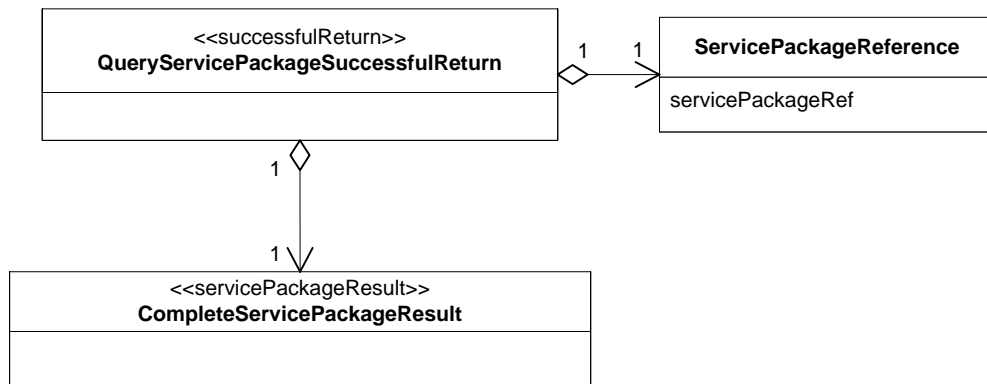

**Figure 4-31: QSP-SR Message Structure Presented in a Class Diagram**

#### 4.10.5.2 Parameters

The contents of the **ServicePackageReference** data set are defined in table 4-17.

#### 4.10.5.3 Data Set Composition and Relationship Requirements

Table 4-89 defines the data set composition and relationship requirements for the **QSP-SR** message that are in addition to or exceptions to those of the <<SuccessfulReturn>> and <<ServicePackageResult>> stereotypes.

**Table 4-89: Data Set Composition and Relationship Requirements for QSP-SR**

QSPD-2	The <b>QueryServicePackageSuccessfulReturn</b> message shall contain one <b>ServicePackageReference</b> data set. [syntactic validation]
QSPD-3	For the <b>ServicePackageReference</b> data set, the <code>servicePackageRef</code> shall have the same value as the <code>servicePackageRef</code> parameter of the <b>QSP-I</b> . [service management validation]
QSPD-4	The following composition rules for the <<ServicePackageResult>> stereotype (see table 4-39) do not apply to the QSP-SR: a) CSPD-33; b) CSPD-34; c) CSPD-39; d) CSPD-40; e) CSPD-52. NOTE – QPSD-5 thru QPSD-10 replace and refine the requirements referenced in (a)-(e).
QSPD-5	Each <b>SlsTsInstanceResult</b> data set shall contain: a) one <b>SlsTsProfileInEffect</b> data set; and b) zero or one <b>SlsTsProfileRespecResult</b> data sets. [syntactic validation]
QSPD-6	For a Service Package created via <code>CreateServicePackage</code> or replaced via <code>ReplaceServicePackage</code> , for each <b>SlsTsProfileRespecification</b> data set in the corresponding <b>SpaceLinkSessionServicePackageRequest</b> data set that references a CCSDS-standard Space Link Session Transfer Service Profile, the <b>SlsTsInstanceResult</b> data set with the same value for the <code>transferServiceProfileRef</code> parameter shall contain one <b>SlsTsProfileRespecResult</b> . [service management validation] NOTE – <b>SlsTsProfileRespecification</b> data sets that reference bilateral (i.e., non-CCSDS-standard) Space Link Session Transfer Service Profiles are reflected in the content of the <code>bilateralSlsTsInstanceResultData</code> parameter of the corresponding <b>BilateralSlsTsInstanceResult</b> data set. How these changes are reflected are determined bilaterally and are outside the scope of this Recommended Standard.
QSPD-7	Each <b>SpaceCommunicationServiceResult</b> data set shall contain: a) one <b>SpaceCommunicationServiceProfileInEffect</b> data sets; b) one or more <b>CarrierResult</b> data sets; and c) zero or one <b>SpaceCommunicationServiceProfileRespecResult</b> data set. [syntactic validation]
QSPD-8	For a Service Package created via <code>CreateServicePackage</code> or replaced via <code>ReplaceServicePackage</code> , for each <b>SpaceCommunicationServiceProfile-Respecification</b> data set in a <b>SpaceCommunicationServiceRequest</b> data set of the corresponding <b>SpaceLinkSessionServicePackageRequest</b> data set, the corresponding <b>SpaceCommunicationServiceResult</b> data set shall contain one <b>SpaceCommunicationServiceProfileRespecResult</b> data set. [service management validation]
QSPD-9	Each <b>RetrievalTsInstanceResult</b> data set shall contain one <b>RetrievalTsProfileInEffect</b> data set. [syntactic validation]

QSPD-10	<p>For each <b>RetrievalTsProfileRespecification</b> data set in the corresponding <b>RetrievalServicePackageRequest</b> that references a CCSDS-standard Retrieval Transfer Service Profile, the <b>RetrievalTsInstanceResult</b> data set shall contain one <b>RetrievalTsProfileRespecResult</b> data set.</p> <p>[service management validation]</p> <p>NOTE – <b>RetrievalTsProfileRespecification</b> data sets that reference <u>bilateral</u> Retrieval Transfer Service Profiles are reflected in the content of the <u>bilateral-RtrvlTsInstanceResultData</u> parameter of the corresponding <b>Bilateral-RetrievalTsInstanceResult</b> data set. How these changes are reflected are determined bilaterally and are outside the scope of this Recommended Standard.</p>
---------	---

#### 4.10.6 QueryServicePackageFailedReturn (QSP-FR) MESSAGE (CM → UM)

##### 4.10.6.1 General

The **QueryServicePackageFailedReturn** message conforms to the data set composition and relationship requirements for, and inherits the parameters of, the <<FailedReturn>> stereotype, as specified in table 3-10.

Figure 4-32 shows the message structure of the **QSP-FR** as a class diagram.

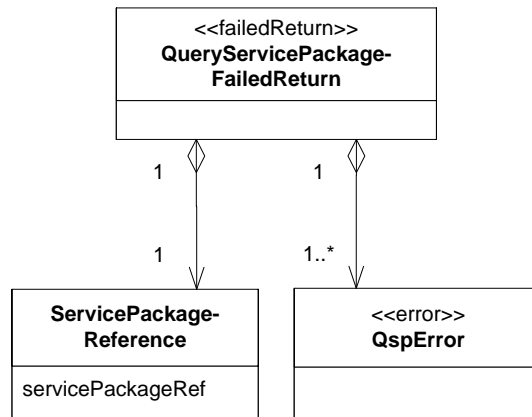

Figure 4-32: QSP-FR Message Structure Class Diagram

##### 4.10.6.2 Parameters

The contents of the **ServicePackageReference** data set are defined in table 4-17.

The **QspError** dataset of the **QueryServicePackageFailedReturn** message conforms to the data set composition and relationship requirements for, and inherits the parameters of, the <<Error>> data set stereotype, which contains a diagnostic parameter of the <<ErrorDiagnostic>> stereotype. Table 4-90 defines the additional values of the diagnostic parameter for the **QspError** data set, identifies the CM and data set composition service management requirements that result in that diagnostic value being returned, and identifies the contents of the erroredItem and additional-Information parameters that accompany each diagnostic value.



**Table 4-90: QspError Data Set diagnostic Parameter Definition**

diagnostic value	Definition/Description	Rqmt	Content of erroredItem	Content of additional Information
'operation timeout'	See table 3-11.	2PP-0103b		
'referenced Service Package Unknown'	No Service Package with this identifier has ever been established at CM for the referenced Service Agreement.	QSPC-6(a)	servicePackageRef	n/a
'referenced Service Package already executed'	The referenced Service Package has already been executed by CM.	QSPC-5	servicePackageRef	n/a
'referenced Service Package deleted'	The Service Package with this identifier has been deleted.	QSPC-6(b)	servicePackageRef	n/a
'referenced Service Package cancelled'	The Service Package with this identifier has been cancelled.	QSPC-6(c)	servicePackageRef	n/a
'other'	The operation has failed due to an error that is local to the Service Agreement.	QSPC-4	The invalid parameter or data set that causes the violation	Text-string description of the local error

#### 4.10.6.3 Data Set Composition and Relationship Requirements

Table 4-91 defines the data set composition and relationship requirements for the **QSP-FR** message that are in addition to those of the <<FailedReturnWithDenial>> stereotype.

**Table 4-91: Data Set Composition and Relationship Requirements for QSP-FR**

QSPD-11	The <b>QueryServicePackageFailedReturn</b> message a) shall contain one <b>ServicePackageReference</b> data set; b) shall contain one or more <b>QspError</b> data sets. [syntactic validation]
QSPD-12	The <b>servicePackageRef</b> shall have the same value as the <b>servicePackageRef</b> parameter of the corresponding <b>QSP-I</b> message. [service management validation]

## 4.11 CONFIRM\_TENTATIVE\_SERVICE\_PACKAGE (CTSP) OPERATION

### 4.11.1 PURPOSE

The CONFIRM\_TENTATIVE\_SERVICE\_PACKAGE (CTSP) operation allows CM to request that UM confirm a proposed Space Link Session Service Package that has been tentatively scheduled by CM through rule-based scheduling. Depending on the CTSP schedulingMode of the Service Agreement, CM either commits the resources needed to support the proposed Service Package as part of the process of generating the Service Package, or provisionally identifies a space link session that is available at the time that the Service Package is generated.

### 4.11.2 PROCEDURE

**4.11.2.1** The CTSP operation is defined to be a three-phase operation in accordance with the operation procedure pattern specified in 3.4.2.

**4.11.2.2** The CTSP operation is defined in terms of the following messages:

- ConfirmTentativeServicePackageInvocation (CTSP-I);
- ConfirmTentativeServicePackageAcknowledgedReturn (CTSP-AR);
- ConfirmTentativeServicePackageSuccessfulReturn (CTSP-SR);
- ConfirmTentativeServicePackageFailedReturn (CTSP-FR).

**4.11.2.3** The message sequence diagram for the CONFIRM\_TENTATIVE\_SERVICE\_PACKAGE operation is defined by applying the following argument list to the stereotyped sequence diagram for the three-phase operation procedure pattern specified in 3.4.2.2:

```
threePhaseOperationProcedurePatternSequence {CM, UM, CTSP-I,
                                             CTSP-AR, CTSP-SR, CTSP-
                                             FR}
```

**4.11.2.4** The activity diagram for the CONFIRM\_TENTATIVE\_SERVICE\_PACKAGE operation is defined by applying the following argument list to the stereotyped activity diagram for the three-phase operation procedure pattern specified in 3.4.2.4:

```
threePhaseOperationProcedurePatternActivity {CM, UM, CTSP-I,
                                             CTSP-AR, CTSP-SR, CTSP-
                                             FR, ctspRoutineTimeout,
                                             ctspUrgentTimeout}
```

### 4.11.3 REQUIREMENTS

#### 4.11.3.1 UM Requirements for the CONFIRM\_TENTATIVE\_SERVICE\_PACKAGE Operation

The UM requirements for the **CTSP** operation are defined in table 4-92.

**Table 4-92: UM Requirements for the CTSP Operation**

CTSPU-1	UM shall conform to all Performer Requirements for Three-Phase Operation Procedures as specified in 3.4.2.5.2.
CTSPU-2	UM shall validate that a received <b>CTSP-I</b> conforms to all CTSP-I syntactic validation requirements specified in table 4-101. If the <b>CTSP-I</b> fails any of the syntactic requirements, UM shall process the message set containing the syntactically invalid invocation in accordance with the Performer Requirements for Three-Phase Operation Procedures.
CTSPU-3	UM should validate that the <b>CTSP-I</b> conforms to all <b>CTSP-I</b> service management validation requirements specified in this table and table 4-101. If the <b>CTSP-I</b> fails any of the service management requirements, UM shall cease processing the <b>CTSP-I</b> and respond to CM with a <b>CTSP-FR</b> message. The content of the <b>CTSP-FR</b> depends on the nature of the validation failure, and is specified in tables 4-104 and 4-105.
CTSPU-4	UM shall validate that each <b>CTSP-I</b> parameter that is constrained by a Service Agreement parameter is consistent with the applicable Service Agreement parameter. [service management validation]
CTSPU-5	UM shall validate that all <b>CTSP-I</b> parameter values that are related to each other (as defined in the Data Set Composition and Relationship Requirements) contain mutually compatible values. [service management validation]
CTSPU-6	If the Service Agreement incorporates locally defined <b>CTSP-I</b> relationship requirements in addition to those specified in this Recommended Standard, UM shall validate that the <b>CTSP-I</b> conforms to all such local requirements. [service management validation]
CTSPU-7	If the <b>CTSP-I</b> is valid and UM decides to confirm the tentative Service Package, UM shall: <ol style="list-style-type: none"> <li>a) generate and send a <b>CTSP-SR</b> to CM;</li> <li>b) count the Service Package as applying against the following parameters of the Service Agreement;           <ol style="list-style-type: none"> <li>1) maxSlsServicePackages;</li> <li>2) maxSlsServicePackagesPerTimePeriod.</li> </ol> </li> </ol> [perform operation]
CTSPU-8	If UM decides to <i>not</i> accept the tentative Service Package, UM shall generate and send a <b>CTSP-FR</b> to CM. [perform operation]
CTSPU-9	UM shall conform to all <b>CTSP-AR</b> , <b>CTSP-SR</b> , and <b>CTSP-FR</b> Data Set Composition and Relationship Requirements when creating and transmitting a <b>CTSP-AR</b> (see in table 4-102), <b>CTSP-SR</b> (see table 4-103), and <b>CTSP-FR</b> (see table 4-106).

### 4.11.3.2 CM Requirements for the CONFIRM\_TENTATIVE\_SERVICE\_PACKAGE Operation

The CM requirements for the CTSP operation are defined in table 4-93.

**Table 4-93: CM Requirements for the CTSP Operation**

CTSPC-1	<p>a) CM shall generate the rule-based Service Package in accordance with the rules that have been mutually agreed between the Space Mission and the Complex.</p> <p>b) If the schedulingMode is specified as 'committed' in the Service Agreement, CM shall commit and reserve the resources necessary to support the proposed Service Package.</p> <p>NOTE – The specification of the rules for generation of rule-based Service Packages, and the process by which those rules are used to generate specific rule-based Service Packages, are outside the scope of the specification of the CTSP operation.</p>
CTSPC-2	CM shall not invoke the CTSP operation for a rule-based Service Package if the Service Package would cause the total number of proposed and established Service Packages to exceed maxSlsServicePackages.
CTSPC-3	CM shall not invoke the CTSP operation for a rule-based Service Package if the Service Package would cause the total number of proposed and established Service Packages to exceed maxSlsServicePackagesPerTimePeriod for any time period.
CTSPC-4	CM shall conform to all Invoker Requirements for Three-Phase Operation Procedures as specified in 3.4.2.5.1.
CTSPC-5	CM shall conform to all CTSP-I Data Set Composition and Relationship Requirements when creating and transmitting a CTSP-I as specified in table 4-101.
CTSPC-6	CM shall submit CTSP-I messages that are valid with respect to all service management validation requirements for UM as defined in table 4-101.
CTSPC-7	CM shall validate that a received CTSP-SR, CTSP-FR, or CTSP-AR conforms to all CTSP-SR, CTSP-FR, or CTSP-AR syntactic validation requirements specified in table 4-102, table 4-103, or table 4-106, respectively. If the return fails any of the syntactic validation requirements, CM shall process the message set containing the syntactically invalid return in accordance with the Invoker Requirements for Three-Phase Operation Procedures.
CTSPC-8	CM shall validate that a received CTSP-SR, CTSP-FR, or CTSP-AR conforms to all CTSP-SR, CTSP-FR, or CTSP-AR service management validation requirements specified in table 4-102, table 4-103, or table 4-106, respectively. If the return fails any of the service management validation requirements, CM shall process the service management-invalid return in accordance with the Invoker Requirements for Three-Phase Operation Procedures.
CTSPC-9	<p>If the CTSP-SR is valid:</p> <ol style="list-style-type: none"> <li>a) CM shall schedule the Service Package;</li> <li>b) CM shall count the Service Package as applying against the following parameters of the Service Agreement: <ol style="list-style-type: none"> <li>1) maxSlsServicePackages;</li> <li>2) maxSlsServicePackagesPerTimePeriod.</li> </ol> </li> </ol>
CTSPC-10	If the CTSP-FR is valid, CM shall decommit any resources that have been assigned to the tentative Service Package. (i.e., if the schedulingMode is 'committed').

### 4.11.4 ConfirmTentativeServicePackageInvocation (CTSP-I) MESSAGE (CM → UM)

#### 4.11.4.1 General

The **ConfirmTentativeServicePackageInvocation** is used by CM to propose a rule-based Space Link Session Service Package.

The **ConfirmTentativeServicePackageInvocation** message conforms to and inherits the parameters of the <<Invocation>> stereotype as specified in 3.3.5.3.2. Figure 4-33 shows the structure of the **ConfirmTentativeServicePackageInvocation (CTSP-I)** message as a class diagram.

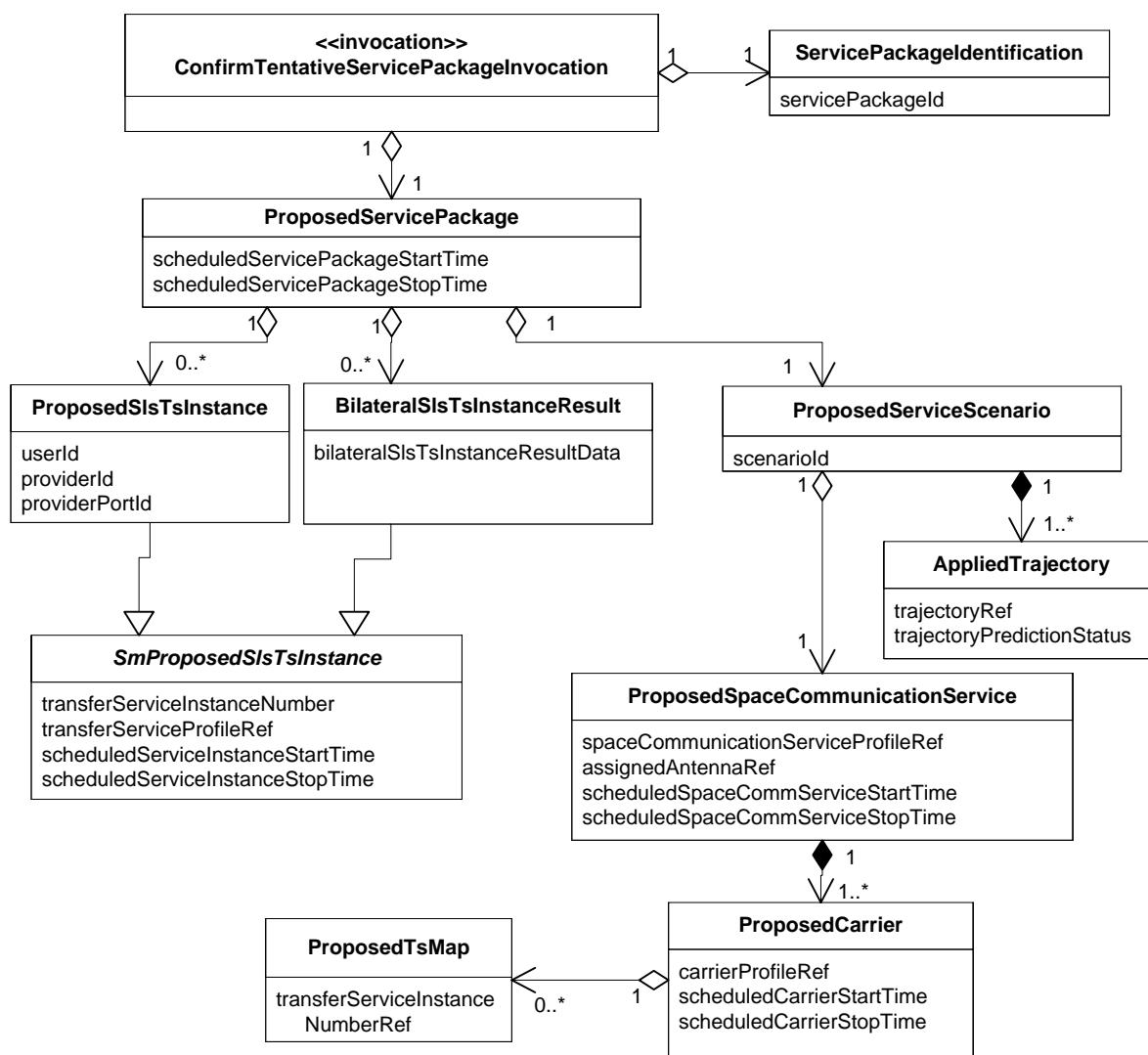

Figure 4-33: CTSP-I Message Structure Class Diagram

#### 4.11.4.2 Parameters

Tables 4-94 through 4-100 define the constituent data sets for the **ConfirmTentative-ServicePackageInvocation** message, with the exception of:

- the **ServicePackageIdentification** data set, which is defined in table 4-15; and
- the **BilateralSlsTsInstanceResult** data set, which is defined in table 4-24.

**Table 4-94: ProposedServicePackage Data Set**

Parameter Name	Parameter Definition/Description	Data Type	Data Units	Applicable Service Agreement Parameter
scheduled-ServicePackageStartTime	Time at which the Service Package is scheduled to start. The scheduled start of the Service Package corresponds to the earlier of: <ul style="list-style-type: none"> <li>a) the scheduled start of signal acquisition for the first (earliest-starting) space link carrier in the <b>ProposedSpaceCommunication-Service</b> data set; and</li> <li>b) the scheduled start time of the first (earliest-starting) transfer service instance in all <b>ProposedSlsTsInstance</b> and <b>BilateralSlsTsInstanceResult</b> data sets in the Service Package.</li> </ul>	UTC	n/a	n/a
scheduled-ServicePackageStopTime	The time at which the Service Package is scheduled to stop. The scheduled start of the Service Package corresponds to the later of: <ul style="list-style-type: none"> <li>a) the scheduled end of signal acquisition for the last (latest-ending) space link carrier in the <b>ProposedSpaceCommunication-Service</b> data set; and</li> <li>b) the scheduled stop time of the last (latest-ending) transfer service instance in all <b>ProposedSlsTsInstance</b> and <b>BilateralSlsTsInstanceResult</b> data sets in the Service Package.</li> </ul> The scheduled stop of the space communication service corresponds to the scheduled stop of signal acquisition for the last (latest-ending) space link carrier in the referenced Space Communication Service Profile. NOTE – Because the CTSP tentatively schedules only a single Space Communication Service Profile per Service Package, the scheduled-ServicePackageStopTime has the same value as the scheduledSpaceCommServiceStopTime. It is included in the <b>CTSP-I</b> for consistency with the <b>&lt;&lt;ServicePackageResult&gt;&gt;</b> stereotype.	UTC	n/a	n/a

**Table 4-95: ProposedServiceScenario Data Set**

Parameter Name	Parameter Definition/Description	Data Type	Data Units	Applicable Service Agreement Parameter
scenarioId	The identifier to be used as the value of the scenarioRef and primeScenarioRef parameters of Service Package operations that may subsequently operate on this Service Package.	String256	n/a	n/a

**Table 4-96: AppliedTrajectory Data Set**

Parameter Name	Parameter Definition/Description	Data Type	Data Units	Applicable Service Agreement Parameter
trajectoryRef	Name of the default trajectory prediction that will be used to generate acquisition data for this Service Package. NOTE 1 – If the Service Agreement specifies that Trajectory Predictions are used to confirm visibility in the scheduling process, this parameter also identifies the Trajectory Prediction used to generate this tentative Service Package. NOTE 2 – The Trajectory Prediction used to actually support the execution of the Service Package may be subsequently replaced via the SAS operation.	String256	n/a	Default-TrajectoryPrediction-trajectoryRef
trajectoryPrediction-Status	Status of the referenced Trajectory Prediction as it applies to this Service Package: – ‘trajectory prediction available to support the Service Package’: the referenced Trajectory Prediction is suitable for generation of spacecraft acquisition products in support of the Service Package; – ‘trajectory prediction available but does not support the Service Package’: the referenced Trajectory Prediction is available at CM but does not cover the time span required by the Service Package. The referenced Trajectory Prediction must be either extended or replaced (via ANT) before the Service Package can transition from the Pending to the Defined state; – ‘trajectory prediction status not evaluated’: the status of the referenced Trajectory Prediction at CM has not been determined.			

**Table 4-97: ProposedSpaceCommunicationService Data Set**

Parameter Name	Parameter Definition/Description	Data Type	Data Units	Applicable Service Agreement Parameter
assignedAntennaRef	See table 4-22.			
spaceCommunication-ServiceProfileRef	Contains the value of the spaceCommunicationServiceProfileId parameter of the Space Communication Service Profile to be utilized when providing services for the <b>ProposedSpaceCommunicationService</b> .	String256	n/a	n/a
scheduledSpaceComm-ServiceStartTime	See table 4-22.			
scheduledSpaceComm-ServiceStopTime	See table 4-22.			

**Table 4-98: ProposedSIsTsInstance Data Set**

Parameter Name	Parameter Definition/Description	Data Type	Data Units	Applicable Service Agreement Parameter
providerId	See table 4-23.			
providerPortId	See table 4-23.			
scheduledService-InstanceStartTime	See table 4-23.			
scheduledService-InstanceStopTime	See table 4-23.			
transferServiceInstance-Number	See table 4-23.			
transferServiceProfileRef	See table 4-10.			
userId	See table 4-23			

**Table 4-99: ProposedCarrier Data Set**

Parameter Name	Parameter Definition/Description	Data Type	Data Units	Applicable Service Agreement Parameter
carrierProfileRef	Contains the value of the carrierProfileId parameter of the <b>SpaceLinkCarrierProfile</b> data set of the referenced Space Communication Service Profile that are used to configure the service production and transfer services associated with this carrier.	String256	n/a	n/a
scheduledCarrierStartTime	The time at which the carrier is scheduled to start.	UTC	n/a	n/a
scheduledCarrierStopTime	The time at which the carrier is scheduled to stop.	UTC	n/a	n/a



**Table 4-100: ProposedTsMap Data Set**

Parameter Name	Parameter Definition/Description	Data Type	Data Units	Applicable Service Agreement Parameter
transferService-InstanceNumberRef	The value of a transferServiceInstanceNumber parameter of one of the <b>ProposedSlsTsInstance</b> or <b>BilateralSlsTsInstanceResult</b> data sets for this Service Package.	Unsigned integer	n/a	n/a

#### 4.11.4.3 Data Set Composition and Relationship Requirements

Table 4-101 defines the data set composition and relationship requirements for the **ProposedServicePackage** messages.

**Table 4-101: Data Set Composition and Relationship Requirements for CTSP-I**

CTSPD-1	A <b>CTSP-I</b> message shall contain: a) one <b>ServicePackageIdentification</b> data set; and b) one <b>ProposedServicePackage</b> data set. [syntactic validation]
CTSPD-2	In the <b>ServicePackageIdentification</b> data set, the <code>servicePackageId</code> shall be unique with respect to all other <code>servicePackageId</code> parameters relative to the Service Agreement. [service management validation]
CTSPD-3	The <b>ProposedServicePackage</b> data set shall contain: a) one <b>ProposedServiceScenario</b> data set; b) zero or more <b>ProposedSlsTsInstance</b> data sets; and c) zero or more <b>BilateralSlsTsInstanceResult</b> data sets. [syntactic validation]
CTSPD-4	The <b>ProposedServiceScenario</b> data set shall contain: a) one <b>ProposedSpaceCommunicationService</b> data set; and b) one or more <b>AppliedTrajectory</b> data sets. [syntactic validation]
CTSPD-5	The <b>ProposedSpaceCommunicationService</b> data set shall contain one or more <b>ProposedCarrier</b> data sets. [syntactic validation]
CTSPD-6	The <b>ProposedSpaceCommunicationService</b> data set shall contain one <b>ProposedCarrier</b> data set for each <b>SpaceLinkCarrierProfile</b> data set in the Space Communication Service Profile that is referenced by the <code>spaceCommunicationServiceProfileRef</code> parameter of the <b>ProposedSpaceCommunicationService</b> data set. [service management validation]
CTSPD-7	Each <b>ProposedCarrier</b> data set shall contain zero or more <b>TsMapResult</b> data sets. [syntactic validation]
CTSPD-8	Each <b>ProposedCarrier</b> data set that corresponds to a <b>SpaceLinkCarrierProfile</b> data set in a Space Communication Service Profile shall contain one <b>TsMapResult</b> data set for each <b>FcltuTSM</b> , <b>RaftTSM</b> , <b>RcftTSM</b> , and <b>BilateralTSM</b> data set contained by the corresponding <b>SpaceLinkCarrierProfile</b> data set. [service management validation]

CTSPD-9	There shall be one <b>ProposedSlsTsInstance</b> data set for each SLE Transfer Service Profile that is referenced by a <b>TsMapResult</b> data set. [service management validation]
CTSPD-10	The Trajectory Prediction referenced by the trajectoryRef parameter shall be an available Trajectory Prediction. [service management validation]
CTSPD-11	Each <b>SlsTsInstanceResult</b> data set shall have a unique value for the transferServiceInstanceNumber parameter, within the scope of the Service Package. [service management validation]

**4.11.5 ConfirmTentativeServicePackageAcknowledgedReturn (CTSP-AR)  
MESSAGE (UM→CM)**

**4.11.5.1 General**

The **ConfirmTentativeServicePackageAcknowledgedReturn** message inherits the parameters of the <<AcknowledgedReturn>> stereotype as specified in 3.3.5.3.3.5. Figure 4-34 shows the message structure of the **CTSP-AR** as a class diagram.

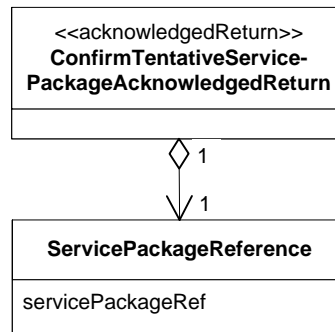

**Figure 4-34: CTSP-AR Message Structure Class Diagram**

**4.11.5.2 Parameters**

The contents of the **ServicePackageReference** data set are defined in table 4-17.

**4.11.5.3 Data Set Composition and Relationship Requirements**

Table 4-102 defines the data set composition and relationship requirements for the **CTSP-AR** message.

**Table 4-102: Data Set Composition and Relationship Requirement for CTSP-AR**

CTSPD-12	The <b>ConfirmTentativeServicePackageAcknowledgedReturn</b> message shall contain one <b>ServicePackageReference</b> data set. [syntactic validation]
CTSPD-13	The <b>servicePackageRef</b> shall have the same value as the <b>servicePackageId</b> of the corresponding <b>CTSP-I</b> . [service management validation]

#### 4.11.6 ConfirmTentativeServicePackageSuccessfulReturn (CTSP-SR) MESSAGE (UM → CM)

##### 4.11.6.1 General

The **ConfirmTentativeServicePackageSuccessfulReturn** message conforms to and inherits the parameters of the <<SuccessfulReturn>> stereotype, as specified in 3.3.5.3.3.2.

The class diagram for the **ConfirmTentativeServicePackageSuccessfulReturn (CTSP-SR)** message structure is shown in figure 4-35.

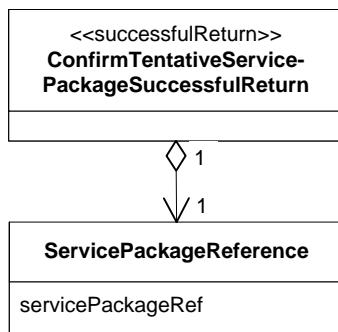

**Figure 4-35: CTSP-SR Message Structure Class Diagram**

##### 4.11.6.2 Parameters

The **ServicePackageReference** data set is defined in table 4-17.

##### 4.11.6.3 Data Set Composition and Relationship Requirements

Table 4-103 defines the data set composition and relationship requirements for the **CTSP-SR** message.

**Table 4-103: Data Set Composition and Relationship Requirements for CTSP-SR**

CTSPD-14	The <b>ConfirmTentativeServicePackageSuccessfulReturn</b> message shall contain one <b>ServicePackageReference</b> data set. [syntactic validation]
CTSPD-15	For the <b>ServicePackageReference</b> data set, the <code>servicePackageRef</code> shall have the same value as the <code>servicePackageId</code> parameter of the <b>CTSP-I</b> . [service management validation]

**4.11.7 ConfirmTentativeServicePackageFailedReturn (CTSP-FR)  
MESSAGE (UM → CM)**

**4.11.7.1 General**

The **ConfirmTentativeServicePackageFailedReturn** message conforms to the data set composition and relationship requirements for, and inherits the parameters of, the <<FailedReturnWithDenial>> stereotype, as specified in 3.3.5.3.3.4.

The class diagram for the **ConfirmTentativeServicePackageFailedReturn** message structure is shown in figure 4-36.

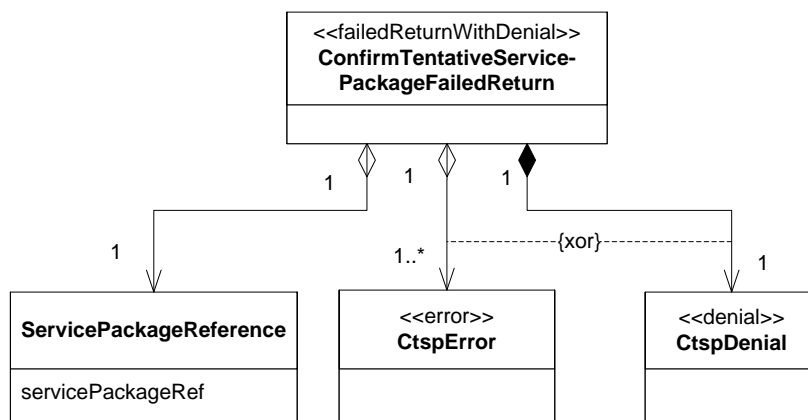

**Figure 4-36: CTSP-FR Message Structure Class Diagram**

**4.11.7.2 Parameters**

The contents of the **ServicePackageReference** data set are defined in table 4-17.

The **CtspError** dataset of the **ConfirmTentativeServicePackageFailedReturn** message conforms to the data set composition and relationship requirements for, and inherits the parameters of, the <<Error>> data set stereotype, which contains a `reason` parameter of the <<ErrorDiagnostic>> stereotype. Table 4-104 defines the values of the

diagnostic parameter for the **CtspError** data set, identifies the UM and data set composition service management requirements that result in that diagnostic value being returned, and identifies the contents of the erroredItem and additional-Information parameters that accompany s each diagnostic value.

**Table 4-104: CtspError Data Set diagnostic Parameter Definition**

diagnostic value	Definition/Description	Rqmt	Parameter or Data Set Identified by erroredItem	Content of additional Information
'servicePackage-Id already in use'	A Service Package with this identifier already exists for the referenced Service Agreement.	CTSPD-2	servicePackageId	n/a
'unknown or invalid trajectoryRef'	The <b>CTSP-I</b> contains a trajectoryRef parameter that does not reference a trajectory at UM, or that is invalid for the cumulative duration of the proposed Space Communication Services that comprise the scenario with which the referenced trajectory is to be associated.  NOTE – There is a separate <b>CtspError</b> data set for each unknown/invalid trajectoryRef value.	CTSPD-10	The trajectoryRef parameter with no matching trajectory at UM or that references a Trajectory Prediction that is invalid.	n/a
'mutually incompatible parameter values'	The <b>CTSP-I</b> contains two or more parameters that are incompatible with each other.	CTSPU-5	One of the parameters that are mutually incompatible  (See GRD-0026, table 3-12.)	n/a
'duplicate serviceInstanceNumber encountered'	The <b>CTSP-I</b> contains two or more transferServiceInstanceNumber parameters with the same value.  NOTE – There is a separate <b>CtspError</b> data set for each duplicate service-InstanceNumber value.	CTSPD-11	One of the transfer-ServiceInstance-Number parameters that contain the same value	String-formatted integer value of the duplicate transfer-Service-Instance-Number parameter

diagnostic value	Definition/Description	Rqmt	Parameter or Data Set Identified by erroredItem	Content of additional Information
'parameter value not supported by referenced Service Agreement'	The <b>CTSP-I</b> contains one or more parameters that are not in accord with the referenced Service Agreement.	CTSPU-4	The parameter with a value that is not supported by the referenced Service Agreement constraints	String-formatted, out-of-bounds value of the parameter
'operation timeout'	See table 3-11.	3PP-0104b		n/a
'other'	The operation has failed due to an error that is local to the Service Agreement.	CTSPU-6	The invalid parameter or data set that causes the violation	Text-string description of the local error

The **CtspDenial** dataset of the **ConfirmTentativeServicePackageFailed-Return** message conforms to the data set composition and relationship requirements for, and inherits the parameters of, the <<Denial>> data set stereotype, which contains a reason parameter of the <<DenialReason>> stereotype. Table 4-105 defines the values of the reason parameter for the **CtspDenial** data set, identifies the UM and data set composition service management requirements that result in that reason value being returned, and identifies the contents of the **deniedItem** and **additionalInformation** parameters that accompany each reason value.

**Table 4-105: CtspDenial Data Set reason Parameter Definition**

reason value	Definition/Description	Rqmt	Parameter or Data Set Identified by deniedItem	Content of additional Information
'service package declined'	UM declines to accept the tentative Service Package.	CTSPU-8	servicePackageId	n/a

#### 4.11.7.3 Data Set Composition and Relationship Requirements for CTSP-FR

Table 4-106 defines the data set composition and relationship requirements common for **CTSP-FR** messages that are in addition to those of the <<FailedReturnWithDenial>> stereotype.

**Table 4-106: Data Set Composition and Relationship Requirements for CTSP-FR**

CTSPD-16	The <code>servicePackageRef</code> parameter shall contain the same value as the <code>servicePackageId</code> parameter in the corresponding <b>CTSP-I</b> . [service management validation]
CTSPD-17	The <b>ConfirmTentativeServicePackageFailedReturn</b> message a) shall contain one <b>ServicePackageReference</b> data set; b) shall contain either one <b>CtspDenial</b> data set or one or more <b>CtspError</b> data sets. [syntactic validation]
CTSPD-18	If the cause of the failure is ‘unknown or invalid trajectoryRef’, the <b>CTSP-FR</b> shall contain one <b>CtspError</b> data set for each unknown/invalid trajectoryRef contained in the <b>CTSP-I</b> .
CTSPD-19	If the cause of the failure is ‘duplicate serviceInstanceNumber encountered’, the <b>CTSP-FR</b> shall contain one <b>CtspError</b> data set for each transferServiceInstanceNumber parameters containing a duplicated transfer service instance number in the <b>CTSP-I</b> .

## 4.12 APPLY\_NEW\_SPACE\_LINK\_EVENTS\_PROFILE (ANSLEP) OPERATION

### 4.12.1 PURPOSE

The **APPLY\_NEW\_SPACE\_LINK\_EVENTS\_PROFILE (ANSLEP)** operation allows UM to apply a new (or different) space link events profile to an existing Service Package at CM. The space link events profile being applied to the existing Service Package must already exist at CM.

### 4.12.2 PROCEDURE

**4.12.2.1** The **ANSLEP** operation is defined to be a three-phase operation in accordance with the operation procedure pattern specified in 3.4.2.

**4.12.2.2** The **ANSLEP** operation is defined in terms of the following messages:

- **ApplyNewSpaceLinkEventsProfileInvocation (ANSLEP-I);**
- **ApplyNewSpaceLinkEventsProfileSuccessfulReturn (ANSLEP-SR);**
- **ApplyNewSpaceLinkEventsProfileFailedReturn (ANSLEP-FR);**
- **ApplyNewSpaceLinkEventsProfileAcknowledgedReturn (ANSLEP-AR).**

**4.12.2.3** The message sequence diagram for the **APPLY\_NEW\_SPACE\_LINK\_EVENTS\_PROFILE** operation is defined by applying the following argument list to the stereotyped sequence diagram for the three-phase operation procedure pattern specified in 3.4.2.2:

```
threePhaseOperationProcedurePatternSequence {UM, CM, ANSLEP-I,
                                             ANSLEP-AR, ANSLEP-SR,
                                             ANSLEP-FR}
```

**4.12.2.4** The activity diagram for the `APPLY_NEW_SPACE_LINK_EVENTS_PROFILE` operation is defined by applying the following argument list to the stereotyped activity diagram for the three-phase operation procedure pattern defined in 3.4.2.4:

```
threePhaseOperationProcedurePatternActivity {UM, CM, ANSLEP-I,
                                             ANSLEP-AR, ANSLEP-SR,
                                             ANSLEP-FR,
                                             anslepRoutineTimeout,
                                             anslepUrgentTimeout }
```

### 4.12.3 REQUIREMENTS

#### 4.12.3.1 UM Requirements for the `APPLY_NEW_SPACE_LINK_EVENTS_PROFILE` Operation

The UM requirements for the **ANSLEP** operation are defined in table 4-107.

**Table 4-107: UM Requirements for the ANSLEP Operation**

ANSLEPU-1	UM shall conform to all Invoker Requirements for Three-Phase Operation Procedures as specified in 3.4.2.5.1.
ANSLEPU-2	UM shall conform to all <b>ANSLEP-I</b> Data Set Composition and Relationship Requirements when creating and transmitting an <b>ANSLEP-I</b> as specified in table 4-110.
ANSLEPU-3	UM should submit <b>ANSLEP-I</b> messages that are valid with respect to all service management validation requirements for CM as defined table 4-110.
ANSLEPU-4	UM shall validate that a received <b>ANSLEP-SR</b> , <b>ANSLEP-FR</b> , or <b>ANSLEP-AR</b> conforms to all <b>ANSLEP-SR</b> , <b>ANSLEP-FR</b> , or <b>ANSLEP-AR</b> syntactic validation requirements specified in table 4-111, table 4-112, and table 4-115, respectively. If the return fails any of the syntactic validation requirements, UM shall process the message set containing the syntactically invalid return in accordance with the Invoker Requirements for Three-Phase Operation Procedures. [syntactic validation]
ANSLEPU-5	UM shall validate that a received <b>ANSLEP-SR</b> , <b>ANSLEP-FR</b> , or <b>ANSLEP-AR</b> conforms to all <b>ANSLEP-SR</b> , <b>ANSLEP-FR</b> , or <b>ANSLEP-AR</b> service management validation requirements specified in table 4-111, table 4-112, and table 4-115, respectively. If the return fails any of the service management validation requirements, UM shall process the service management invalid return in accordance with the Invoker Requirements for Three-Phase Operation Procedures. [service management validation]

#### 4.12.3.2 CM Requirements for the `APPLY_NEW_SPACE_LINK_EVENTS_PROFILE` Operation

The CM requirements for the **ANSLEP** operation are defined in table 4-108.



**Table 4-108: CM Requirements for the ANSLEP Operation**

ANSLEPC-1	CM shall conform to all Performer Requirements for Three-Phase Operation Procedures as specified in 3.4.2.5.1.
ANSLEPC-2	CM shall validate that a received <b>ANSLEP-I</b> conforms to all <b>ANSLEP-I</b> syntactic validation requirements specified in table 4-110, Data Set Composition and Relationship Requirements for the <b>ANSLEP-I</b> . If the <b>ANSLEP-I</b> fails any of the syntactic requirements, CM shall process the message set containing the syntactically invalid invocation in accordance with the Performer Requirements for Three-Phase Operation Procedures.
ANSLEPC-3	CM shall validate that the <b>ANSLEP-I</b> conforms to all <b>ANSLEP-I</b> service management validation requirements specified in this table and table 4-110, Data Set Composition and Relationship Requirements for the <b>ANSLEP-I</b> . If the <b>ANSLEP-I</b> fails any of the service management requirements, CM shall cease processing the <b>ANSLEP-I</b> and respond to UM with an <b>ANSLEP-FR</b> message. The content of the <b>ANSLEP-FR</b> depends on the nature of the validation failure, and is specified in table 4-113 and table 4-114.
ANSLEPC-4	If the SLE Complex has locally defined <b>ANSLEP-I</b> relationship requirements in addition to those specified in this Recommend Standard, CM shall validate that the <b>ANSLEP-I</b> conforms to all such local requirements. [service management validation]
ANSLEPC-5	If the Complex has locally defined <b>ANSLEP-I</b> requirements in addition to those specified in this Recommended Standard that could cause a <b>ANSLEP-I</b> to be denied, CM shall validate that the <b>ANSLEP-I</b> conforms to all such local requirements. [service management validation]
ANSLEPC-6	If <code>enforceOwnership</code> is 'true' in the Service Agreement, CM shall validate that the <code>smSource</code> associated with the <b>ANSLEP-I</b> is the name of the owner of the Service Package associated with the <code>servicePackageId</code> referenced by the <code>servicePackageRef</code> in the <b>ANSLEP-I</b> . [service management validation]
ANSLEPC-7	CM shall validate that the required resources are available to fulfill the Service Package with the new Space Link Events Profile data. If the required resources are not available, CM shall cease processing the <b>ANSLEP-I</b> and respond to UM with a <b>ANSLEP-FR</b> message containing an <b>AnslepDenial</b> data set. [service management validation]
ANSLEPC-8	If CM is unable to validate and perform the ANSLEP operation prior to expiration of <code>minServiceDefinitionLeadTime</code> , CM may terminate the operation and issue an <b>ANSLEP-FR</b> . [service management validation]
ANSLEPC-9	CM shall validate that the <code>scheduledServicePackageStopTime</code> for the referenced Service Package has not already completed execution. [service management validation]
ANSLEPC-10	CM shall validate that the Service Package referenced by the <code>servicePackageRef</code> parameter of the <b>ANSLEP-I</b> : a) has been established; b) has not been deleted; and c) has not been cancelled. [service management validation]
ANSLEPC-11	If the <b>ANSLEP-I</b> is valid, CM shall update all affected Service Scenarios in the Service Package to reference the new Space Link Events Profile and send an <b>ANSLEP-SR</b> message to UM. [Perform operation]
ANSLEPC-12	CM shall conform to all <b>ANSLEP-SR</b> , <b>ANSLEP-FR</b> and <b>ANSLEP-AR</b> Data Set Composition and Relationship Requirements when creating and transmitting a <b>ANSLEP-SR</b> , <b>ANSLEP-FR</b> and <b>ANSLEP-AR</b> , as specified in table 4-111, table 4-112, and table 4-115, respectively.

#### 4.12.4 ApplyNewSpaceLinkEventsProfileInvocation (ANSLEP-I) MESSAGE (UM → CM)

##### 4.12.4.1 General

The **ApplyNewSpaceLinkEventsProfileInvocation** (ANSLEP-I) message conforms to the data set composition and relationship requirements for, and inherits the parameters of, the <<Invocation>> stereotype, as specified in 3.3.5.3.2. Figure 4-37 shows the message structure of the **ANSLEP-I** as a class diagram.

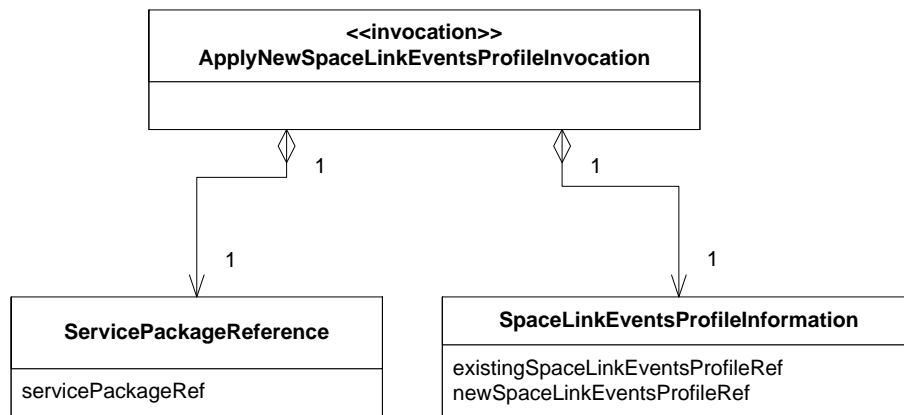

**Figure 4-37: ANSLEP-I Message Structure Class Diagram**

#### 4.12.4.2 Parameters

The **ServicePackageReference** data set is defined in table 4-17.

The **SpaceLinkEventsProfileInformation** data set is defined in table 4-109.

**Table 4-109: SpaceLinkEventsProfileInformation Data Set**

Name	Definition/Description	Data Type	Units	Applicable Service Agreement Parameter
existingSpaceLinkEventsProfileRef	Contains the value of a spaceLinkEventsProfileId that identifies the Space Link Events Profile currently referenced by one or more <b>CarrierResult</b> data sets in the Service Package.	String256	n/a	n/a
newSpaceLinkEventsProfileRef	Contains value of a spaceLinkEventsProfileId that identifies the Space Link Events Profile that is to replace the existingSpaceLinkEventsProfileRef for one or more <b>CarrierResult</b> data sets in the Service Package.	String256	n/a	n/a

#### 4.12.4.3 Data Set Composition and Relationship Requirements

Table 4-110 defines the data set composition and relationship requirements for the **ANSLEP-I** message.

**Table 4-110: Data Set Composition and Relationship Requirements for ANSLEP-I**

ANSLEPD-1	The <b>ANSLEP-I</b> shall contain one <b>ServicePackageReference</b> data set and one <b>SpaceLinkEventsProfileInformation</b> data set. [syntactic validation]
ANSLEPD-2	The parameter existingSpaceLinkEventsProfileRef shall match the value spaceLinkEventsProfileRef in one or more <b>CarrierResult</b> data sets in the Service Package identified by parameter servicePackageRef. [service management validation]
ANSLEPD-3	The parameter newSpaceLinkEventsProfileRef shall have the value of a spaceLinkEventsProfileId that identifies an available Space Link Events Profile for the referenced Service Agreement. [service management validation]

**4.12.5 ApplyNewSpaceLinkEventsProfileAcknowledgedReturn (ANSLEP-AR) MESSAGE (CM→UM)**

**4.12.5.1 General**

The **ApplyNewSpaceLinkEventsProfileAcknowledgedReturn (ANSLEP-AR)** message conforms to the data set composition and relationship requirements for, and inherits the parameters of, the <<AcknowledgedReturn>> stereotype, as specified in 3.3.5.3.3.5. Figure 4-38 shows the message structure of the **ANSLEP-AR** as a class diagram.

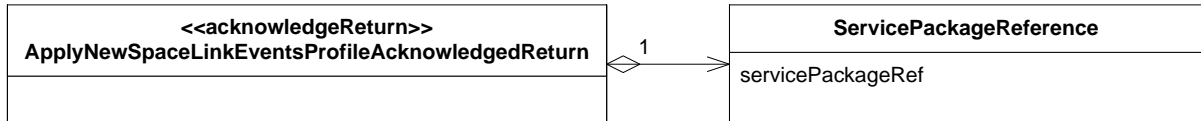

**Figure 4-38: ANSLEP-AR Message Structure Class Diagram**

**4.12.5.2 Parameters**

The **ServicePackageReference** data set is defined in table 4-17.

**4.12.5.3 Data Set Composition and Relationship Requirements**

Table 4-111 defines the data set composition and relationship requirements for the **ANSLEP-AR** message.

**Table 4-111: Data Set Composition and Relationship Requirements for ANSLEP-AR**

ANSLEPD-4	The <b>ApplyNewSpaceLinkEventsProfileAcknowledgedReturn</b> message shall contain one <b>ServicePackageReference</b> data set. [syntactic validation]
ANSLEPD-5	The <b>servicePackageRef</b> shall have the same value as the <b>servicePackageId</b> of the corresponding <b>ANSLEP-I</b> . [service management validation]

### 4.12.6 ApplyNewSpaceLinkEventsProfileSuccessfulReturn (ANSLEP-SR) MESSAGE (CM→UM)

#### 4.12.6.1 General

The **ApplyNewSpaceLinkEventsProfileSuccessfulReturn** (ANSLEP-SR) message conforms to the data set composition and relationship requirements for, and inherits the parameters of, the <<SuccessfulReturn>> stereotype, as specified in 3.3.5.3.3.2, and the <<ServicePackageResult>> stereotype, as specified in 4.3.7. Figure 4-39 shows the message structure of the ANSLEP-SR as a class diagram.

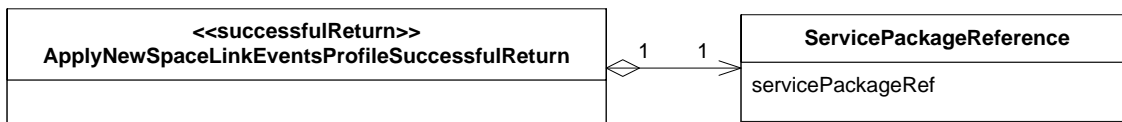

Figure 4-39: ANSLEP-SR Message Structure Presented in a Class Diagram

#### 4.12.6.2 Parameters

The contents of the **ServicePackageReference** data set are defined in table 4-17.

#### 4.12.6.3 Data Set Composition and Relationship Requirements

Table 4-112 defines the data set composition and relationship requirements for the ANSLEP-SR message that are in addition to those of the <<SuccessfulReturn>> and <<ServicePackageResult>> stereotypes.

Table 4-112: Data Set Composition and Relationship Requirements for ANSLEP-SR

ANSLEPD-6	The <b>ApplyNewSpaceLinkProfileSuccessfulReturn</b> message shall contain one <b>ServicePackageReference</b> data set. [syntactic validation].
ANSLEPD-7	For the <b>ServicePackageReference</b> data set, the <code>servicePackageRef</code> shall have the same value as the <code>servicePackageRef</code> parameter of the corresponding <b>ANSLEP-I</b> . [service management validation]

**4.12.7 ApplyNewSpaceLinkEventsProfileFailedReturn (ANSLEP-FR)  
MESSAGE (CM → UM)**

**4.12.7.1 General**

The **ApplyNewSpaceLinkEventsProfileFailedReturn (ANSLEP-FR)** message conforms to the data set composition and relationship requirements for, and inherits the parameters of, the <<FailedReturnWithDenial>> stereotype, as specified in 3.3.5.3.3.4.

Figure 4-40 shows the message structure of the **ANSLEP-FR** as a class diagram.

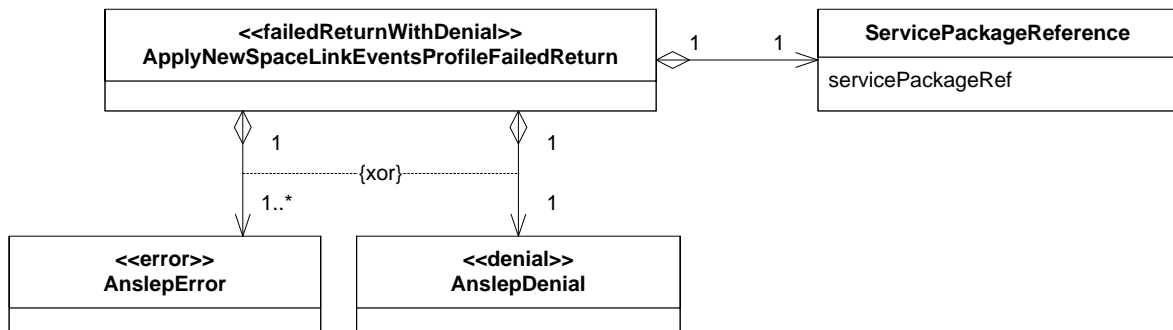

**Figure 4-40: ANSLEP-FR Message Structure Class Diagram**

**4.12.7.2 Parameters**

The contents of the **ServicePackageReference** data set are defined in table 4-17.

The **AnslepError** data set of the **ANSLEP-FR** message conforms to the data set composition and relationship requirements for, and inherits the parameters of, the <<Error>> data set stereotype, which contains a diagnostic parameter of the <<ErrorDiagnostic>> stereotype. Table 4-113 defines the additional values of the diagnostic parameter for the **AnslepError** data set, identifies the CM and data set composition service management requirements that result in that diagnostic value being returned, and identifies the contents of the erroredItem and additional-Information parameters that accompany each diagnostic value.

**Table 4-113: AnslepError Data Set diagnostic Parameter Definition**

diagnostic value	Definition/Description	Rqmt	Parameter or Data Set Identified by erroredItem	Content of additional Information
'existingSpace-LinkEventsProfileRef does not match any carrier'	The parameter existingSpaceLinkEventsProfileRef does not match the value of parameter spaceLinkEventsProfileRef in any of the <b>CarrierResult</b> data sets in the Service Package identified by parameter servicePackageRef.	ANSLEP D-3	existingSpace-LinkEventsProfileRef	n/a
'smSource not the owner of the Service Package'	The value of the smSource for the <b>SmMessageSet</b> containing the <b>ANSLEP-I</b> is not the owner of the target Service Package.	ANSLEP C-6	smSource	n/a
'newSpaceLink-EventsProfileRef non-existent'	There is no Space Link Events Profile with the identifier newSpaceLinkEventsProfileRef registered at CM for the referenced Service Agreement.	ANSLEP D-4	existingSpace-LinkEventsProfileRef	not required
'operation timeout'	See table 3-11.	3PP-0104b	n/a	n/a
'referenced Service Package unknown'	No Service Package with this identifier has ever been established at CM for the referenced Service Agreement.	ANSLEP C-10a	servicePackage-Ref	n/a
'referenced Service Package already executed'	The referenced Service Package has already been executed by CM.	ANSLEP C-9	servicePackage-Ref	n/a
'referenced Service Package deleted'	The Service Package with this identifier has been deleted.	ANSLEP C-10b	servicePackage-Ref	n/a
'referenced Service Package cancelled'	The Service Package with this identifier has been cancelled.	ANSLEP C-10c	servicePackage-Ref	n/a
'other'	The operation has failed due to an error that is local to the Service Agreement.	ANSLEP C-4	The invalid parameter or data set that causes the violation	Text-string description of the local error

The **AnslepDenial** data set of the **ANSLEP-FR** message conforms to and inherits the parameters of the <<Denial>> data set stereotype, which contains a reason parameter of the <<DenialReason>> stereotype. Table 4-114 defines the additional values of the reason parameter for the **AnslepDenial** data set, identifies the CM and data set composition service management requirements that result in that reason value being returned, and identifies the contents of the deniedItem and additional-Information parameters that accompany each reason value.

**Table 4-114: AnslepDenial Data Set reason Parameter Definition**

reason value	Definition/ Description	Rqmt	Parameter or Data Set Identified by deniedItem	Content of additional Information
'minServiceDefinitionLeadTime expired'	CM is unable to perform the ANSLEP operation in time for either a pending or executing Service Package.	ANSLEPC-8	servicePackageRef	n/a
'insufficient resource(s) for new event sequence application'	CM is unable to reserve/allocate one or more units of internal equipment for one or more scenarios because of the change in Event Sequence.	ANSLEPC-7	newSpaceLink-EventsProfileRef	n/a
'other'	The operation is denied for a reason that is local to the Service Agreement.	ANSLEPC-5	The invalid parameter or data set that causes the violation	Text-string description of the local denial reason.

#### 4.12.7.3 Data Set Composition and Relationship Requirements

Table 4-115 defines the data set composition and relationship requirements for the **ANSLEP-FR** message that are in addition to those of the <<FailedReturnWithDenial>> stereotype.

**Table 4-115: Data Set Composition and Relationship Requirements for ANSLEP-FR**

ANSLEPD-8	The <b>ApplyNewSpaceLinkEventsProfileFailedReturn</b> message a) shall contain one <b>ServicePackageReference</b> data set; b) shall contain either one <b>AnslepDenial</b> data set or one or more <b>AnslepError</b> data sets. [syntactic validation]
ANSLEPD-9	The <b>servicePackageRef</b> parameter shall contain the same value as the <b>servicePackageRef</b> parameter in the corresponding <b>RSP-I</b> . [service management validation]



## 5 CONFIGURATION PROFILE OPERATIONS

### 5.1 GENERAL

The Configuration Profile operations that may be invoked by UM are:

- `ADD_SPACE_COMMUNICATION_SERVICE_PROFILE` (ASCSP)—to add a new Space Communication Service Profile at CM;
- `DELETE_SPACE_COMMUNICATION_SERVICE_PROFILE` (DSCSP)—to delete a Space Communication Service Profile that is currently available at CM;
- `QUERY_SPACE_COMMUNICATION_SERVICE_PROFILE` (QSCSP)—to query the content of a Space Communication Service Profile that is currently available at CM;
- `ADD_SPACE_LINK_EVENTS_PROFILE` (ASLEP)—to add a new Space Link Events Profile at CM;
- `QUERY_SPACE_LINK_EVENTS_PROFILE` (QSLEP)—to query a Space Link Events Profile that is currently available at CM;
- `DELETE_SPACE_LINK_EVENTS_PROFILE` (DSLEP)—to delete a Space Link Events Profile that is currently available at CM;
- `ADD_SLS_TRANSFER_SERVICE_PROFILE` (ASTSP)—to add a new Space Link Session (SLS) Transfer Service Profile at CM;
- `QUERY_TRANSFER_SERVICE_PROFILE` (QTSP)—to query an SLS or Retrieval Transfer Service Profile that is currently available at CM;
- `DELETE_TRANSFER_SERVICE_PROFILE` (DTSP)—to delete an SLS or Retrieval Transfer Service Profile that is currently available at CM;
- `ADD_RETRIEVAL_TRANSFER_SERVICE_PROFILE` (ARTSP)—to add a new Retrieval Transfer Service Profile at CM.

No Configuration Profile operations may be invoked by CM.

Subsections 5.3 through 5.12 define those operations used by UM to create, delete, and query each configuration profile that is available at the CM.

### 5.2 LIFECYCLE AND OWNERSHIP OF A CONFIGURATION PROFILE

#### 5.2.1 LIFECYCLE

The lifecycle of a configuration profile, as created using the SCCS-SM-standard Configuration Profile management operations and held by CM, is modeled as a state machine and is shown in figure 5-1, and in table 5-1. The state machine shall be used to define the state of all configuration profiles (Space Communication Service Profiles, Space Link Events Profiles.

SLS Transfer Service Profiles, and Retrieval Transfer Service Profiles) and is parameterized with the service operation messages applicable to each type of information entity.

Any service management messages that fail validation at the level of the Document Exchange Protocol are never associated to an information entity, cannot affect the state of an existing information entity, and do not appear in the state machine.

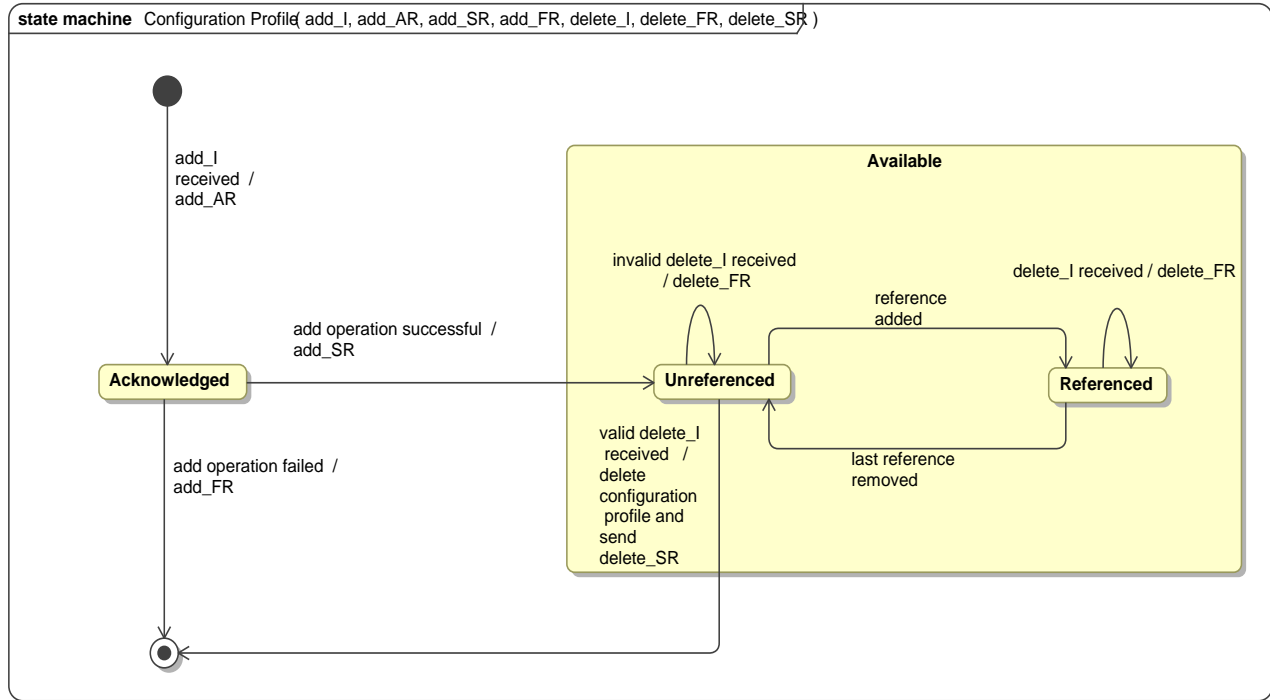

Figure 5-1: State Diagram for Generic Configuration Profile

Table 5-1: State Table for Generic Configuration Profile

States	Available			
	Initial	Acknowledged	Unreferenced	Referenced
<b>add-I</b>	add-AR -> Acknowledged	*	*	*
<b>add-operation successful</b>	*	add-SR -> Unreferenced	*	*
<b>add-operation failed</b>	*	add-FR -> Final	*	*
<b>delete-I received</b>	*	*	[delete-I valid] delete-SR -> Final else delete-FR -> Unreferenced	delete-FR -> Referenced
<b>reference added</b>	*	*	-> Referenced	
<b>last ref removed</b>	*	*	*	-> Unreferenced

The State Machine for the Space Communication Service Profile lifecycle shall conform to the parameterized state machine shown, with the following argument list:

```
configurationProfile { ASCSP-I, ASCSP-AR, ASCSP-SR, ASCSP-FR
                      DSCSP-I, DSCSP-SR, DSCSP-FR,
                      QSCSP-I, QSCSP-SR}
```

and reference criteria as described in DSCSPC-05 and DSCSPC-06.

The State Machine for the Space Link Events Profile lifecycle shall conform to the parameterized state machine shown, with the following argument list:

```
configurationProfile { ASLEP-I, ASLEP-AR, ASLEP-SR, ASLEP-FR
                      DSLEP-I, DSLEP-SR, DSLEP-FR,
                      QSLEP-I, QSLEP-SR}
```

and reference criteria as described in DSLEPC-04.

The State Machine for the Space Link Session Transfer Service Profile lifecycle shall conform to the parameterized state machine shown, with the following argument list:

```
configurationProfile { ASTSP-I, ASTSP-AR, ASTSP-SR, ASTSP-FR
                      DTSP-I, DTSP-SR, DTSP-FR,
                      QTSP-I, QTSP-SR}
```

and reference criteria as described in DTSPC-05.

The State Machine for the Retrieval Transfer Service Profile lifecycle shall conform to the parameterized state machine shown, with the following argument list:

```
configurationProfile { ARTSP-I, ARTSP-AR, ARTSP-SR, ARTSP-FR
                      DTSP-I, DTSP-SR, DTSP-FR,
                      QTSP-I, QTSP-SR}
```

and reference criteria as described in DTSPC-06.

## 5.2.2 OWNERSHIP OF CONFIGURATION PROFILES

Each configuration profile (Space Communication Service Profile, Space Link Events Profile, SLS Transfer Service Profile, or Retrieval Transfer Service Profile) shall be owned by the UM entity associated with the `smSource` used in the `SmMessageSet` that contained the invocation message that created the configuration profile.

### 5.3 ADD\_SPACE\_COMMUNICATION\_SERVICE\_PROFILE (ASCSP) OPERATION

#### 5.3.1 PURPOSE

The ADD\_SPACE\_COMMUNICATION\_SERVICE\_PROFILE (ASCSP) operation is used by UM to add a new Space Communication Service Profile to the set of Space Communication Service Profiles already available at CM for a given Service Agreement.

#### 5.3.2 PROCEDURE

**5.3.2.1** The ASCSP operation is defined to be a three-phase operation in accordance with the operation procedure pattern specified in 3.4.2.

**5.3.2.2** The ASCSP operation is defined in terms of the following messages:

- **AddSpaceCommunicationServiceProfileInvocation (ASCSP-I);**
- **AddSpaceCommunicationServiceProfileAcknowledgedReturn (ASCSP-AR);**
- **AddSpaceCommunicationServiceProfileSuccessfulReturn (ASCSP-SR);**
- **AddSpaceCommunicationServiceProfileFailedReturn (ASCSP-FR).**

**5.3.2.3** The message sequence diagram for the ADD\_SPACE\_COMMUNICATION\_SERVICE\_PROFILE operation is defined by applying the following argument list to the stereotyped sequence diagram for the three-phase operation procedure pattern specified in 3.4.2.2:

```
threePhaseOperationProcedurePatternSequence {UM, CM, ASCSP-I,
                                             ASCSP-AR, ASCSP-SR,
                                             ASCSP-FR}
```

**5.3.2.4** The activity diagram for the ADD\_SPACE\_COMMUNICATION\_SERVICE\_PROFILE operation is defined by applying the following argument list to the stereotyped activity diagram for the three-phase operation procedure pattern specified in 3.4.2.4:

```
threePhaseOperationProcedurePatternActivity {UM, CM, ASCSP-I,
                                                ASCSP-AR, ASCSP-SR,
                                                ASCSP-FR,
                                                ascspRoutineTimeout,
                                                ascspUrgentTimeout}
```

### 5.3.3 REQUIREMENTS

#### 5.3.3.1 UM Requirements for the ADD\_SPACE\_COMMUNICATION\_SERVICE\_ - PROFILE Operation

The UM requirements for the **ASCSP** operation are defined in table 5-2.

**Table 5-2: UM Requirements for the ASCSP Operation**

ASCSPU-01	UM shall conform to all <b>ASCSP-I</b> Data Set Composition and Relationship Requirements when creating and transmitting an <b>ASCSP-I</b> as specified in table 5-25 and table 5-27.
ASCSPU-02	UM shall conform to all Invoker Requirements for Three-Phase Operation Procedures as specified in 3.4.2.5.1.
ASCSPU-03	UM should send <b>ASCSP-I</b> messages that are valid with respect to all service management validation requirements for CM as defined in table 5-25 and table 5-27.
ASCSPU-04	UM shall validate that a received <b>ASCSP-AR</b> , <b>ASCSP-SR</b> , or <b>ASCSP-FR</b> conforms to all <b>ASCSP-AR</b> , <b>ASCSP-SR</b> , or <b>ASCSP-FR</b> syntactic validation requirements specified in table 5-29, table 5-30, or, table 5-32, respectively. If the return fails any of the syntactic validation requirements, UM shall process the message set containing the syntactically invalid return in accordance with the Invoker Requirements for Three-Phase Operation Procedures.
ASCSPU-05	UM shall validate that a received <b>ASCSP-AR</b> , <b>ASCSP-SR</b> , or <b>ASCSP-FR</b> conforms to all <b>ASCSP-AR</b> , <b>ASCSP-SR</b> , or <b>ASCSP-FR</b> service management validation requirements specified in table 5-29, table 5-30, or, table 5-32, respectively. If the return fails any of the service management validation requirements, UM shall process the service management-invalid return in accordance with the Invoker Requirements for Three-Phase Operation Procedures.

### 5.3.3.2 CM Requirements for the **ADD\_SPACE\_COMMUNICATION\_ - SERVICE\_PROFILE** Operation

The CM requirements for the **ASCSP** operation are defined in table 5-3.

**Table 5-3: CM Requirements for the ASCSP Operation**

ASCSPC-01	CM shall conform to all Performer Requirements for Three-Phase Operation Procedures as specified in 3.4.2.5.2.
ASCSPC-02	CM shall validate that a received <b>ASCSP-I</b> conforms to all <b>ASCSP-I</b> syntactic validation requirements specified in table 5-25 and table 5-27, Data Set Composition and Relationship Requirements for the <b>ASCSP-I</b> . If the <b>ASCSP-I</b> fails any of the syntactic requirements, CM shall process the message set containing the syntactically invalid invocation in accordance with the Performer Requirements for Three-Phase Operation Procedures.
ASCSPC-03	CM shall validate that the <b>ASCSP-I</b> conforms to all <b>ASCSP-I</b> service management validation requirements specified in this table and in table 5-25 and table 5-27, Data Set Composition and Relationship Requirements. If the <b>ASCSP-I</b> fails any of the service management requirements, CM shall cease processing the <b>ASCSP-I</b> and respond to UM with an <b>ASCSP-FR</b> message. The content of the <b>ASCSP-FR</b> depends on the nature of the validation failure, and is specified table 5-31.
ASCSPC-04	CM shall validate that the <b>ASCSP-I</b> would not cause the number of Carrier Profiles to exceed <code>maxCarrierProfiles</code> for the referenced Service Agreement parameter. [service management validation]
ASCSPC-05	CM shall validate that each <b>ASCSP-I</b> parameter that is constrained by a Service Agreement parameter is consistent with the applicable Service Agreement parameter. [service management validation]
ASCSPC-06	CM shall validate that all <b>ASCSP-I</b> parameter values that are related to each other (as defined in the Data Set Composition and Relationship Requirements) contain mutually compatible values. [service management validation]
ASCSPC-07	If the Complex has locally defined <b>ASCSP-I</b> relationship requirements in addition to those specified in this Recommended Standard, CM shall validate that the <b>ASCSP-I</b> conforms to all such local requirements. [service management validation]
ASCSPC-08	If the <b>ASCSP-I</b> passes all syntactic and service management validation, CM shall: <ul style="list-style-type: none"> <li>a) add the Carrier Profile to the set of Carrier Profiles already available at CM;</li> <li>b) count the Carrier Profile as applying against the <code>maxCarrierProfiles</code> parameter of the Service Agreement; and</li> <li>c) send an <b>ASCSP-SR</b> message to CM.</li> </ul> [perform operation]
ASCSPC-09	CM shall conform to all <b>ASCSP-SR</b> Data Set Composition and Relationship Requirements when creating and transmitting an <b>ASCSP-SR</b> as specified in table 5-30.
ASCSPC-10	CM shall conform to all <b>ASCSP-FR</b> Data Set Composition and Relationship Requirements when creating and transmitting an <b>ASCSP-FR</b> as specified in table 5-32.
ASCSPC-11	CM shall conform to all <b>ASCSP-AR</b> Data Set Composition and Relationship Requirements when creating and transmitting an <b>ASCSP-AR</b> as specified in table 5-29.

### 5.3.4 <<SpaceCommunicationServiceProfile>> DATA SET STEREOTYPE

#### 5.3.4.1 General

The <<SpaceCommunicationServiceProfile>> data set stereotype captures the parameters and data set relationships that are common among messages that create Space Communication Service Profiles or report their contents. Figure 5-2 shows the message structure of the <<SpaceCommunicationServiceProfile>> data set stereotype as a class diagram.

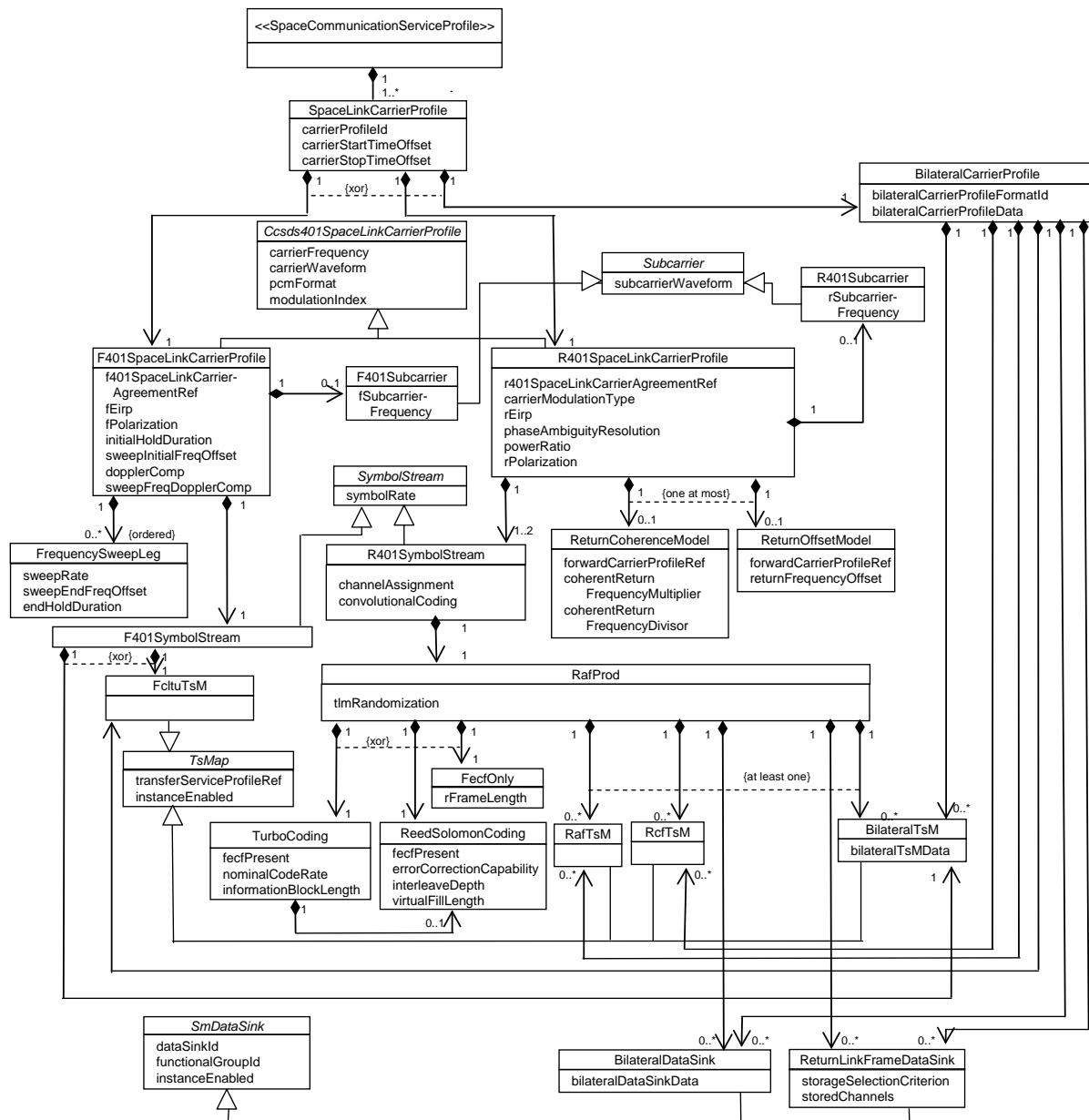

Figure 5-2: <<SpaceCommunicationServiceProfile>> Stereotype Structure Class Diagram

### 5.3.4.2 Parameters

The constituent data sets of the <<SpaceCommunicationServiceProfile>> stereotype are defined in tables 5-4 through 5-24.

**Table 5-4: SpaceLinkCarrierProfile Data Set**

Parameter Name	Parameter Definition/Description	Data Type	Units	Applicable Service Agreement Parameter
carrierProfileId	Unique identifier of the Carrier Profile, relative to the Service Agreement.	String256	n/a	n/a
carrierStartTime-Offset	Offset from the scheduled start time of the space communication service that contains this carrier, which is to be added to the scheduled start time of the space communication service to produce the scheduled start time for the carrier. NOTE – The carrier can start no earlier than the start of the space communication service of which it is a part.	Unsigned Integer	seconds	
carrierStopTime-Offset	Offset from the scheduled stop time of the space communication service that contains this carrier, which is to be subtracted from the scheduled stop time of the space communication service to produce the scheduled stop time for the carrier. NOTE – The carrier can stop no later than the start of the space communication service of which it is a part.	Non-positive Integer	seconds	

**Table 5-5: F401SpaceLinkCarrierProfile Data Set**

Parameter Name	Parameter Definition/Description	Data Type	Units	Applicable Service Agreement Parameter
carrierFrequency	Specifies the rest (not Doppler-shifted) frequency.	Positive Integer	Hz	F401SpaceLink-CarrierAgreement:-carrierFrequency-Range
carrierWaveform	Specifies the carrier waveform to be used. The value is one of the following: – ‘sine’ sine wave; – ‘square’ square wave.	Enum	n/a	F401SpaceLink-CarrierAgreement:-carrierWaveform-Options



Parameter Name	Parameter Definition/Description	Data Type	Units	Applicable Service Agreement Parameter
dopplerComp	Specifies whether or not the frequency is Doppler-compensated following the frequency sweep. The value is one of the following: <ul style="list-style-type: none"> <li>– ‘fixed’—uncompensated for Doppler;</li> <li>– ‘DopplerCompensated’—Doppler compensation applied.</li> </ul>	Enum	n/a	n/a
f401SpaceLinkCarrierAgreementRef	References the f401SpaceLinkCarrierAgreementId that is bound to the <b>F401SpaceLinkCarrierAgreement</b> data set in the Service Agreement that shall be used to validate the values of parameters in this Carrier Profile.	String256	n/a	f401SpaceLinkCarrierAgreementId
fEirp	Specifies the Complex’s transmitter’s equivalent (or effective) isotropic radiated power (EIRP).	Integer	dBm*	fMinEirp, fMaxEirp
fPolarization	Indicates the polarization of the forward RF carrier. The value is one of the following: <ul style="list-style-type: none"> <li>– ‘LinearHorizontal’;</li> <li>– ‘LinearVertical’</li> <li>– ‘RCP’—right-hand circular polarization;</li> <li>– ‘LCP’—left-hand circular polarization.</li> </ul>	Enum	n/a	fPolarizationOptions
initialHoldDuration	Specifies the duration at which the initial radiated frequency is to be held (beginning at the carrier start time) before the frequency sweep begins.  NOTE – The initial radiated frequency is defined as the carrier rest frequency plus the value of the sweepInitialFreqOffset parameter, and possibly compensated for Doppler.	Positive Integer	Seconds	n/a

Parameter Name	Parameter Definition/Description	Data Type	Units	Applicable Service Agreement Parameter
modulationIndex	Angle by which the RF carrier is to be phase-shifted with respect to the un-modulated RF carrier.	Unsigned Integer	milli-radians	F401SpaceLinkCarrier-Agreement:modulation-IndexRange
pcmFormat	<p>Specifies the PCM format of the data that is modulated onto the carrier or subcarrier. The value is one of the following:</p> <ul style="list-style-type: none"> <li>– ‘NRZ-L’: non-return to zero-level;</li> <li>– ‘NRZ-M’: non-return to zero-mark;</li> <li>– ‘BiPhase-L’: bi-phase level;</li> <li>– ‘BiPhase-M’: bi-phase mark.</li> </ul> <p>NOTE – If a subcarrier data set does not exist for this carrier (indicating that the data is modulated directly onto the carrier) the pcmFormat parameter applies to the data on the carrier. If a subcarrier data set exists (indicating that the subcarrier carries the data instead of the carrier), the pcmFormat parameter applies to the data on the subcarrier.</p>	Enum	n/a	pcmFormatOptions
sweepFreqDopplerComp	<p>Specifies whether or not the sweep frequency is Doppler-compensated. The value is one of the following:</p> <ul style="list-style-type: none"> <li>– ‘fixed’—uncompensated for Doppler;</li> <li>– ‘DopplerCompensated’—Doppler compensation applied.</li> </ul>	Enum	n/a	n/a
sweepInitialFreq-Offset	Specifies the offset to be applied to the rest frequency in order to define the non-Doppler-compensated radiated frequency at the beginning of the frequency sweep.	Integer	Hz	n/a

\* decibels referenced to one milliwatt.

**Table 5-6: FrequencySweepLeg Data Set**

Parameter Name	Parameter Definition/Description	Data Type	Units	Applicable Service Agreement Parameter
sweepRate	Specifies the rate at which the sweep leg transitions from the frequency at the beginning of the sweep leg to the frequency at the end of the sweep leg.	Positive Integer	Hz/sec	n/a
sweepEndFreqOffset	The frequency offset from the rest frequency at which the sweep leg is to end.  NOTE – A positive value results in a sweep leg end frequency that is higher than the rest frequency, a negative value results in a sweep leg end frequency that is lower than the rest frequency, and a zero value results in the sweep leg ending at the rest frequency.	Positive Integer	Hz	n/a
endHoldDuration	The duration for which the sweep leg end frequency is to be held constant (although possibly Doppler-compensated, if applied) before the leg ends.	Positive Integer	seconds	n/a

**Table 5-7: F401Subcarrier Data Set**

Parameter Name	Parameter Definition/Description	Data Type	Units	Applicable Service Agreement Parameter
fSubcarrierFrequency	The frequency to be used on the forward subcarrier.	Positive Integer	Hz	R401SpaceLink-Carrier-Agreement:-fSubcarrier-FrequencyRange
subcarrierWaveform	Specifies the subcarrier waveform to be used. The value is one of the following: – ‘sine’ sine wave; – ‘square’ square wave.	Enum	n/a	R401SpaceLink-Carrier-Agreement:-subcarrier-WaveformOptions

**Table 5-8: F401SymbolStream Data Set**

Parameter Name	Parameter Definition/Description	Data Type	Units	Applicable Service Agreement Parameter
symbolRate	The rate at which symbols (of the symbol stream) are to appear on the space link.  NOTE – The rate is that which is measured at the output of any encoder that is applied to the forward data stream.	Positive Integer	milli-symbol s/sec	F401SymbolStream-Agreement: symbolRateRange

**Table 5-9: Fc1tuTSM Data Set**

Parameter Name	Parameter Definition/Description	Data Type	Units	Applicable Service Agreement Parameter
instanceEnabled	Specifies whether this transfer service is to be enabled when the associated space link carrier is scheduled.	Boolean	n/a	n/a
transferService-ProfileRef	References the SLS Transfer Service Configuration Profile that defines the characteristics of the transfer service instance.	String256	n/a	n/a

**Table 5-10: R401SpaceLinkCarrierProfile Data Set**

Parameter Name	Parameter Definition/Description	Data Type	Units	Applicable Service Agreement Parameter
carrierFrequency	See table 5-5.			
carrierModulationType	The modulation type that shall be applied to the RF carrier. The value is one of the following: <ul style="list-style-type: none"> <li>– ‘BPSK’— Binary Phase Shift Key;</li> <li>– ‘QPSK’— Quaternary Phase Shift Key;</li> <li>– ‘UQPSK’— Unbalanced Quaternary Phase Shift Key;</li> <li>– ‘OQPSK’— Offset Quaternary Phase Shift Key;</li> <li>– ‘GMSK’— Gaussian Minimum Shift Key;</li> <li>– ‘PCM/PM’— Pulse Code Modulation/Phase Modulation;</li> <li>– ‘8PSK’— Square Root Raised Cosine filtered 4-Dimensional 8 PSK Trellis Coded Modulation;</li> <li>– ‘unmodulated’ – The carrier does not have data directly modulated onto it.</li> </ul>	Enum	n/a	carrierModulationTypeOptions
carrierWaveform	Specifies the carrier waveform to be used. The value is one of the following: <ul style="list-style-type: none"> <li>– ‘sine’ sine wave;</li> <li>– ‘square’ square wave.</li> </ul>	Enum	n/a	carrierWaveformOptions
modulationIndex	See table 5-5.			
pcmFormat	See table 5-5.			
phaseAmbiguityResolution	The phase ambiguity resolution technique to be applied when OQPSK modulation is used. The valid values are: <ul style="list-style-type: none"> <li>– ‘Uncoded-Differential’;</li> <li>– ‘Uncoded-Unique-Word’;</li> <li>– ‘Coded-Differential-Inside-FEC’;</li> <li>– ‘Coded-Differential-Outside-FEC’;</li> <li>– ‘Coded-Nondifferential-Unique-Word’; and</li> <li>– ‘Coded-Nondifferential-Metric-Error’.</li> </ul> NOTES 1 See CCSDS 401 (reference [14]) for definitions of these terms. 2 This parameter has a n on-null value only when OQPSK modulation is used.	Enum or NULL	n/a	phaseAmbiguityResolutionOptions

Parameter Name	Parameter Definition/Description	Data Type	Units	Applicable Service Agreement Parameter
powerRatio	The ratio between the power of the I-channel and the Q-channel in the UQPSK modulation (expressed in dB) to be used. NOTE – This parameter has a non-null value only when UQPSK modulation is used.	Positive Integer [3..12] or NULL	dB	powerRatioOptions
r401SpaceLink-CarrierAgreementRef	References the r401SpaceLink-CarrierAgreementId that is bound to the <b>R401SpaceLinkCarrierAgreement</b> parameters in the Service Agreement that should be used to validate the parameters contained in this Carrier Profile.	String-256	n/a	r401SpaceLink-CarrierAgreement-Id
rEirp	Specifies the equivalent (or effective) isotropic radiated power from the spacecraft.	Integer	dBm*	rMinEirp, rMaxEirp
rPolarization	Indicates the polarization of the return RF carrier. The value is one of the following: <ul style="list-style-type: none"> <li>– ‘LinearHorizontal’;</li> <li>– ‘LinearVertical’;</li> <li>– ‘RCP’—right-hand circular polarization;</li> <li>– ‘LCP’—left-hand circular polarization;</li> <li>– ‘combined’—a combination of polarizations.</li> </ul>	Enum	n/a	rPolarization-Options
* decibels referenced to one milliwatt.				

Table 5-11: R401Subcarrier Data Set

Parameter Name	Parameter Definition/Description	Data Type	Units	Applicable Service Agreement Parameter
rSubcarrierFrequency	The frequency to be used on the return subcarrier.	Positive integer	Hz	rSubcarrier-FrequencyRange
subcarrierWaveform	See table 5-7.			

**Table 5-12: ReturnCoherenceModel Data Set**

Parameter Name	Parameter Definition/Description	Data Type	Units	Applicable Service Agreement Parameter
coherentReturnFrequencyDivisor	The denominator of the ratio of the return to forward frequencies.	Positive Integer	n/a	n/a
coherentReturnFrequencyMultiplier	The numerator of the ratio of the return to forward frequencies.	Positive Integer	n/a	n/a
forwardCarrierProfileRef	References the carrierProfileId of the forward Carrier Profile that is to be used as the reference for the return carrier frequency.	String256	n/a	n/a

**Table 5-13: ReturnOffsetModel Data Set**

Parameter Name	Parameter Definition/Description	Data Type	Units	Applicable Service Agreement Parameter
forwardCarrierProfileRef	See table 5-12.			
returnFrequencyOffset	Offset of the return carrier frequency from the forward carrier frequency. A positive value indicates that the return frequency is greater than the forward frequency by the magnitude of the offset. A negative value indicates that the return frequency is less than the forward frequency by the magnitude of the offset.	Integer	Hz	n/a

Table 5-14: R401SymbolStream Data Set

Parameter Name	Parameter Definition/Description	Data Type	Units	Applicable Service Agreement Parameter
convolutionalCoding	Convolutional coding to use: <ul style="list-style-type: none"> <li>– ‘notUsed’—convolutional coding is not used on this symbol stream in this Service Package;</li> <li>– ‘rateOneHalf’—rate one-half convolutional coding is used on this symbol stream in this Service Package;</li> <li>– ‘rateTwoThirds’—rate one-half, punctured to two-thirds, convolutional coding is used on this symbol stream in this Service Package;</li> <li>– ‘rateThreeQuarters’—the use of rate one-half, punctured to three-quarters, convolutional coding is used on this symbol stream in this Service Package;</li> <li>– ‘rateFiveSixths’—the use of rate one-half, punctured to five-sixths, convolutional coding is used on this symbol stream in this Service Package;</li> <li>– ‘rateSevenEighths’—the use of rate one-half, punctured to seven-eighths, convolutional coding is used on this symbol stream in this Service Package.</li> </ul>	Enum	n/a	convolutionalCodingOptions



Parameter Name	Parameter Definition/Description	Data Type	Units	Applicable Service Agreement Parameter
channelAssignment	<p>Specifies which symbol stream of the carrier or subcarrier this data set characterizes. The value of this parameter is one of the following:</p> <ul style="list-style-type: none"> <li>– ‘bpskChannel’;</li> <li>– ‘qpskIChannelOnly’;</li> <li>– ‘qpskQChannelOnly’;</li> <li>– ‘qpskIChannelSeparate’;</li> <li>– ‘qpskQChannelSeparate’;</li> <li>– ‘qpskInterleaved’;</li> <li>– ‘oqpskIChannelOnly’;</li> <li>– ‘oqpskQChannelOnly’;</li> <li>– ‘oqpskIChannelSeparate’;</li> <li>– ‘oqpskQChannelSeparate’;</li> <li>– ‘oqpskInterleaved’;</li> <li>– ‘uqpskIChannelOnly’;</li> <li>– ‘uqpskQChannelOnly’;</li> <li>– ‘gmskChannel’;</li> <li>– ‘8pskChannel’;</li> <li>– ‘pcmPmChannel’;</li> <li>– ‘pcmPskPmChannel’.</li> </ul> <p>NOTE – The values ‘bpskChannel’ through ‘pcmPmChannel’ apply only to symbol streams that are the result of carrier modulation. The value ‘pcmPskPmChannel’ applies only to symbol streams that are the result of subcarrier modulation.</p>	Enum	n/a	channelAssignmentOptions
symbolRate	See table 5-8.			

Table 5-15: RafProd Data Set

Parameter Name	Parameter Definition/Description	Data Type	Units	Applicable Service Agreement Parameter
tlmRandomization	<p>Specifies whether the Pseudo-Randomizer (see section 7 of reference [4]) shall be applied to the data received in the symbol stream. The values are:</p> <ul style="list-style-type: none"> <li>– ‘tlmRandomizationUsed’, indicating that randomization shall be applied;</li> <li>– ‘tlmRandomizationNotUsed’, indicating that randomization shall not be applied.</li> </ul>	Enum	n/a	tlmRandomizationOptions

**Table 5-16: FecfOnly Data Set**

Parameter Name	Parameter Definition/Description	Data Type	Units	Applicable Service Agreement Parameter
rFrameLength	The length of the frames on the symbol stream to be processed. The length of the Attached Sync Marker is <u>not</u> included in this value. NOTE – The minimum value of 7 octets is derived from the minimum Transfer Frame Primary Header length of 6 octets plus 1 octet of Transfer Frame Data Field content (references [2] and [5]). The maximum value of 2048 octets is specified in reference [4].	Positive Integer [7..2048])	Octets	transferFrameLengthRange

**Table 5-17: ReedSolomonCoding Data Set**

Parameter Name	Parameter Definition/Description	Data Type	Units	Applicable Service Agreement Parameter
errorCorrection-Capability	The maximum number of errored symbols per codeword to be correctable (see reference [4]).	Integer [8,16]	Octets	eccOptions
fecfPresent	Indicates whether the Frame Error Control Field is present in the frames.	Boolean	n/a	n/a
interleaveDepth	The depth of interleave that shall be used on this all frames channel for the duration of the carrier.	Integer [1,2,3,4,5,8]	n/a	interleave-Options
virtualFillLength	The number of virtual fill symbols that are virtually included in each frame (see reference [4]).	Integer [0..223])	Octets	

**Table 5-18: TurboCoding Data Set**

Parameter Name	Parameter Definition/Description	Data Type	Units	Applicable Service Agreement Parameter
nominalCodeRate	The nominal ratio of information block length to the Turbo codeblock length (see reference [4]). The values are: <ul style="list-style-type: none"> <li>– ‘1/2’;</li> <li>– ‘1/3’;</li> <li>– ‘1/4’; and</li> <li>– ‘1/6’.</li> </ul>	Enum	n/a	turboCodeRateOptions
fecfPresent	See table 5-17.			
informationBlockLength	The length of the information block (see reference [4]).	Integer [1784, 3568, 7136, 8920, 16384]	Bits	informationBlockLengthOptions

**Table 5-19: RaFTSM Data Set**

Parameter Name	Parameter Definition/Description	Data Type	Units	Applicable Service Agreement Parameter
instanceEnabled	See table 5-9.			
transferServiceProfileRef	See table 5-9.			

**Table 5-20: RcFTSM Data Set**

Parameter Name	Parameter Definition/Description	Data Type	Units	Applicable Service Agreement Parameter
instanceEnabled	See table 5-9.			
transferServiceProfileRef	See table 5-9.			

**Table 5-21: BilateralCarrierProfile Data Set**

Parameter Name	Parameter Definition/Description	Data Type	Units	Applicable Service Agreement Parameter
bilateralCarrierProfileData	Contains the Carrier Profile data in the format defined by the parameter bilateralCarrierProfileFormatId.	Bilateral-Data	n/a	n/a
bilateralCarrierProfileFormatId	Identification of Carrier Profile format other than the CCSDS standard Carrier Profile format. This format must be bilaterally agreed between UM and CM.	String256	n/a	allowed-BilateralCarrierProfileFormatIds

**Table 5-22: BilateralTSM Data Set**

Parameter Name	Parameter Definition/Description	Data Type	Units	Applicable Service Agreement Parameter
bilateralTSMData	Contains the transfer service mapping data in the format defined by the bilateralTransferServiceProfileFormatId parameter of the SLS Transfer Service Profile referenced by the transferServiceProfileRef.	Bilateral-Data	n/a	n/a
instanceEnabled	See table 5-9.			
transferServiceProfileRef	See table 5-9.			

**Table 5-23: ReturnLinkFrameDataSink Data Set**

Parameter Name	Parameter Definition/Description	Data Type	Units	Applicable Service Agreement Parameter
dataSinkId	Identifies this instance of data sink for the associated space link carrier.	String256	n/a	
functionalGroupId	The functional group identifier that is to be associated with the data that is stored via this data sink instance. NOTE – The functional group identifier is a component of the transfer service instance identifier. A retrieval transfer service instance has access to the data that has been stored with a matching functionalGroupId.	String256	n/a	
instanceEnabled	Specifies whether this data store is to be enabled when the associated space link carrier is scheduled.	Boolean	n/a	n/a
storageSelectionCriterion	The set of space link data channels that may be stored via this data sink instance. The set of valid values are: <ul style="list-style-type: none"> <li>– ‘all’—all frames (annotated for quality and continuity) of all virtual channels on the symbol stream are to be stored;</li> <li>– ‘list of channels’—all frames (annotated for quality and continuity) of the list of virtual channels specified in the stored-Channels parameter are to be stored.</li> </ul>	Enum	n/a	n/a

Parameter Name	Parameter Definition/Description	Data Type	Units	Applicable Service Agreement Parameter
storedChannels	<p>If storageSelection-Criterion = 'list of channels', the list of channelIds that may be stored by this data sink instance, where channelId = gVcId   mcId:</p> <ul style="list-style-type: none"> <li>– gVcId = (vn, scid, vcid) triplet, where: <ul style="list-style-type: none"> <li>• vn (transfer frame version number) = Integer [0..1];</li> <li>• scid (spacecraft identifier) = Integer in the range of [0..1023] for vn = 0 and in the range of [0..255] for vn = 1;</li> <li>• vcid (virtual channel identifier) = Integer in the range of [0..63] for vn = 0 and in the range of [0..255] for vn = 1;</li> </ul> </li> <li>– 'mcId' = (vn, scid) pair, where vn and scid are as defined above.</li> </ul> <p>If storageSelection-Criterion = 'all', Null.</p>	list of channel Ids or NULL	n/a	n/a

Table 5-24: BilateralDataSink Data Set

Parameter Name	Parameter Definition/Description	Data Type	Units	Applicable Service Agreement Parameter
dataSinkId	See table 5-23.			
functionalGroupId	See table 5-23.			
instanceEnabled	See table 5-9.			
bilateralDataSinkData	<p>Contains bilaterally defined configuration data for the data sink.</p> <p>NOTE – The bilateral definition of the syntax and semantics of this parameter is outside the scope of this Recommended Standard.</p>	Bilateral-Data	n/a	n/a

### 5.3.4.3 Data Set Composition and Relationship Requirements

Table 5-25 defines the data set composition and relationship requirements for the <<SpaceCommunicationServiceProfile>> data set stereotype.

**Table 5-25: Data Set Composition and Relationship Requirements for all SpaceCommunicationServiceProfiles**

ASCSPD-01	A data set conforming to the <<SpaceCommunicationServiceProfile>> stereotype shall contain one or more <b>SpaceLinkCarrierProfile</b> data sets. [syntactic validation]
ASCSPD-02	Each <b>SpaceLinkCarrierProfile</b> data set shall contain one and only one of the following: a) <b>F401SpaceLinkCarrierProfile</b> data set; b) <b>R401SpaceLinkCarrierProfile</b> data set; c) <b>BilateralCarrierProfile</b> data set. [syntactic validation]
ASCSPD-03	The <code>carrierProfileId</code> parameter for each Space Link Carrier Profile shall be unique relative to the Service Agreement. [service management validation]
ASCSPD-04	If the <b>BilateralCarrierProfile</b> data set is present, the content of the <code>bilateralCarrierProfileData</code> parameter shall conform to the data set composition and relationship requirements for the format of the Bilateral Carrier Profile indicated by parameter <code>bilateralCarrierProfileFormatId</code> . [service management validation]
ASCSPD-05	For each <b>BilateralTSM</b> data set present, the content of the <code>bilateralTsMData</code> parameter shall conform to the data set composition and relationship requirements for the format indicated by parameter <code>bilateralTransferServiceProfileFormatId</code> of the SLS Transfer Service Profile referenced by the <code>transferServiceProfileId</code> parameter. [service management validation]
ASCSPD-06	For each <b>BilateralDataSink</b> data set present, the content of the <code>bilateralDataSinkData</code> parameter shall conform to the data set composition and relationship requirements for the format indicated by <code>dataSinkId</code> parameter. [service management validation]
ASCSPD-07	In each <b>F401SpaceLinkCarrierProfile</b> data set, the <code>f401SpaceLinkCarrierAgreementRef</code> parameter shall contain the value of an <code>f401SpaceLinkCarrierAgreementId</code> in the associated Service Agreement. [service management validation]
ASCSPD-08	A <b>F401SpaceLinkCarrierProfile</b> data set shall contain zero or one <b>F401Subcarrier</b> data set. [syntactic validation]
ASCSPD-09	A <b>F401SpaceLinkCarrierProfile</b> data set shall contain a) one <b>F401SymbolStream</b> data set; and b) zero or more <b>FrequencySweepLeg</b> data sets. [syntactic validation]
ASCSPD-10	A <b>F401SymbolStream</b> data set shall contain one and only one of the following: a) <b>FcltuTSM</b> data set; or b) <b>BilateralTSM</b> data set. [syntactic validation]

ASCSPD-11	In each <b>FcltuTsm</b> data set, the value of the <code>transferServiceProfileRef</code> attribute shall match the value of the <code>transferServiceProfileId</code> of a previously defined SLS Transfer Service Profile that defines an FCLTU SLS transfer service profile. [service management validation]
ASCSPD-12	In each <b>BilateralTsm</b> data set contained by an <b>F401SymbolStream</b> data set, the value of the <code>transferServiceProfileRef</code> attribute shall match the value of the <code>transferServiceProfileId</code> of a previously defined SLS Transfer Service Profile that defines a bilateral SLS transfer service profile. [service management validation]
ASCSPD-13	In each <b>R401SpaceLinkCarrierProfile</b> data set, the <code>r401SpaceLinkCarrierAgreementRef</code> attribute shall contain the value of a <code>r401SpaceLinkCarrierAgreementId</code> in the referenced Service Agreement. [service management validation]
ASCSPD-14	If the value of the <code>carrierModulationType</code> parameter of a <b>R401SpaceLinkCarrierProfile</b> data set is 'BPSK', then the <b>R401SpaceLinkCarrierProfile</b> data set shall contain one <b>R401SymbolStream</b> data set, the value of the <code>channelAssignment</code> parameter shall be 'bpskChannel', and the value of the <code>modulationIndex</code> parameter shall be between 1561 and 1571 milliradians (inclusive). [service management validation]
ASCSPD-15	If the value of the <code>carrierModulationType</code> parameter of the <b>R401SpaceLinkCarrierProfile</b> data set is 'UQPSK', then the <b>R401SpaceLinkCarrierProfile</b> data set shall contain one <b>R401SymbolStream</b> data set, the value of the <code>channelAssignment</code> parameter shall be either 'uqpskIChannel' or 'uqpskQChannel', and the value of the <code>modulationIndex</code> parameter shall be between 1561 and 1571 milliradians (inclusive). [service management validation]
ASCSPD-16	If the value of the <code>carrierModulationType</code> parameter of the <b>R401SpaceLinkCarrierProfile</b> data set is 'QPSK' or 'OQPSK', then the <b>R401SpaceLinkCarrierProfile</b> data set shall contain one or two <b>R401SymbolStream</b> data sets and the value of the <code>modulationIndex</code> parameter shall be between 1561 and 1571 milliradians (inclusive). [service management validation]
ASCSPD-17	If the value of the <code>carrierModulationType</code> parameter of the <b>R401SpaceLinkCarrierProfile</b> data set is 'QPSK' and the <b>R401SpaceLinkCarrierProfile</b> data set contains one <b>R401SymbolStream</b> data set, then the value of the <code>channelAssignment</code> parameter shall be 'qpskIChannelOnly', 'qpskQChannelOnly', or 'qpskInterleaved'. [service management validation]
ASCSPD-18	If the value of the <code>carrierModulationType</code> parameter of the <b>R401SpaceLinkCarrierProfile</b> data set is 'QPSK' and the <b>R401SpaceLinkCarrierProfile</b> data set contains two <b>R401SymbolStream</b> data sets, then the value of the <code>channelAssignment</code> parameter for one of the <b>R401SymbolStream</b> data sets shall be 'qpskIChannelSeparate' and the value of the <code>channelAssignment</code> parameter for the other <b>R401SymbolStream</b> data set shall be 'qpskQChannelSeparate'. [service management validation]
ASCSPD-19	If the value of the <code>carrierModulationType</code> parameter of the <b>R401SpaceLinkCarrierProfile</b> data set is 'OQPSK' and the <b>R401SpaceLinkCarrierProfile</b> data set contains one <b>R401SymbolStream</b> data set, then the value of the <code>channelAssignment</code> parameter shall be 'oqpskIChannelOnly', 'oqpskQChannelOnly', or 'oqpskInterleaved'. [service management validation]



ASCSPD-20	<p>If the value of the <code>carrierModulationType</code> parameter of the <b>R401SpaceLinkCarrierProfile</b> data set is 'OQPSK' and the <b>R401SpaceLinkCarrierProfile</b> data set contains two <b>R401SymbolStream</b> data sets, then the value of the <code>channelAssignment</code> parameter for one of the <b>R401SymbolStream</b> data sets shall be 'oqpskIChannelSeparate' and the value of the <code>channelAssignment</code> parameter for the other <b>R401SymbolStream</b> data set shall be 'oqpskQChannelSeparate'.</p> <p>[service management validation]</p>
ASCSPD-21	<p>If the value of the <code>carrierModulationType</code> parameter of a <b>R401SpaceLinkCarrierProfile</b> data set is 'GMSK', then the <b>R401SpaceLinkCarrierProfile</b> data set shall contain one <b>R401SymbolStream</b> data set, the value of the <code>channelAssignment</code> parameter shall be 'gmskChannel', and the value of the <code>modulationIndex</code> parameter shall be between 1561 and 1571 milliradians (inclusive).</p> <p>[service management validation]</p>
ASCSPD-22	<p>If the value of the <code>carrierModulationType</code> parameter of a <b>R401SpaceLinkCarrierProfile</b> data set is 'PCM/PM', then the <b>R401SpaceLinkCarrierProfile</b> data set shall contain one <b>R401SymbolStream</b> data set, the value of the <code>modulationIndex</code> parameter shall be between 100 and 1560 milliradians (inclusive), and the value of the <code>channelAssignment</code> parameter shall be 'pcmPmChannel'.</p> <p>[service management validation]</p>
ASCSPD-23	<p>If the value of the <code>carrierModulationType</code> parameter of a <b>R401SpaceLinkCarrierProfile</b> data set is '8PSK', then the <b>R401SpaceLinkCarrierProfile</b> data set shall contain one <b>R401SymbolStream</b> data set, the value of the <code>channelAssignment</code> parameter shall be '8pskChannel', and the value of the <code>modulationIndex</code> parameter shall be between 1561 and 1571 milliradians (inclusive).</p> <p>[service management validation]</p>
ASCSPD-24	<p>The value of the <code>channelAssignment</code> parameter for any <b>R401SymbolStream</b> data set shall match the <code>channelAssignmentAgreement</code> parameter for one of the <b>R401SymbolStreamAgreement</b> data sets contained by the <b>R401SpaceLinkCarrierAgreement</b> data set referenced by the <code>r401SpaceLinkCarrierAgreementRef</code> parameter.</p> <p>[service management validation]</p>
ASCSPD-25	<p>a) A <b>R401SpaceLinkCarrierProfile</b> data set shall contain one <b>R401Subcarrier</b> data set if and only if:</p> <ol style="list-style-type: none"> <li>1) the <b>R401SpaceLinkCarrierAgreement</b> data set referenced by the <code>r401SpaceLinkCarrierAgreementRef</code> parameter contains a <b>R401SubcarrierAgreement</b> data set; and [service management validation]</li> <li>2) the value of the <code>carrierModulationType</code> parameter of a <b>R401SpaceLinkCarrierProfile</b> data set is 'unmodulated'. [syntactic validation]</li> </ol> <p>b) If an <b>R401SpaceLinkCarrierProfile</b> data set contains an <b>R401Subcarrier</b> data set, then the <b>R401SpaceLinkCarrierProfile</b> data set shall contain one <b>R401SymbolStream</b> data set and the value of the <code>channelAssignment</code> parameter shall be 'pcmPskPmChannel'. [service management validation]</p> <p>NOTE – If the <b>R401SpaceLinkCarrierProfile</b> data set contains an <b>R401Subcarrier</b> data set, the <b>R401SymbolStream</b> data set is associated with the subcarrier and not the carrier.</p>

ASCSPD-26	The values of all <code>transferServiceProfileRef</code> parameters of all transfer service mapping ( <b>XXXTsM</b> ) data sets shall be unique within the context of the Space Communication Service Profile. [service management validation].
ASCSPD-27	The <code>powerRatio</code> parameter shall have a non-null value in the <b>R401SpaceLinkCarrierProfile</b> data set only if the value of the <code>carrierModulationType</code> parameter is 'UQPSK'. [syntactic validation]
ASCSPD-28	The <code>phaseAmbiguityResolution</code> parameter shall have a non-null value in the <b>R401SpaceLinkCarrierProfile</b> data set only if the value of the <code>carrierModulationType</code> parameter is 'OQPSK'. [syntactic validation]
ASCSPD-29	The <b>R401SpaceLinkCarrierProfile</b> data set shall contain: a) Neither a <b>ReturnCoherenceModel</b> data set nor a <b>ReturnOffsetModel</b> data set; b) One <b>ReturnCoherenceModel</b> data set; or c) One <b>ReturnOffsetModel</b> data set. [syntactic validation]
ASCSPD-30	A <b>R401SymbolStream</b> data set shall contain one <b>RafProd</b> data set. [syntactic validation]
ASCSPD-31	A <b>RafProd</b> data set shall contain at least one of the following: a) <b>RaftTsM</b> data set; b) <b>RcftTsM</b> data set; c) <b>BilateralTsM</b> data set; d) <b>ReturnFrameLinkDataSink</b> data set; and/or e) <b>BilateralDataSink</b> data set. A <b>RafProd</b> data set may contain more than one of any of the above-specified data sets. [service management validation]
ASCSPD-32	In each <b>RaftTsM</b> data set, the value of the <code>transferServiceProfileRef</code> parameter shall match the value of the <code>transferServiceProfileId</code> of an available SLS Transfer Service Profile that defines an RAF SLS transfer service profile. [service management validation]
ASCSPD-33	In each <b>RcftTsM</b> data set, the value of the <code>transferServiceProfileRef</code> parameter shall match the value of the <code>transferServiceProfileId</code> of an available SLS Transfer Service Profile that defines an RCF SLS transfer service. [service management validation]
ASCSPD-34	In each <b>BilateralTsM</b> data set contained by an <b>RafProd</b> data set, the value of the <code>transferServiceProfileRef</code> parameter shall match the value of the <code>transferServiceProfileId</code> of an available SLS Transfer Service Profile that defines a bilateral SLS transfer service profile that is appropriate for use with a return carrier. [service management validation]  NOTE – The means by which the appropriateness is determined is itself defined bilaterally and is outside the scope of this Recommended Standard.
ASCSPD-35	In each <b>ReturnLinkFrameDataSink</b> data set and <b>BilateralDataSink</b> , the value of the <code>dataSinkId</code> shall be unique within the context of the Space Communication Service Profile. [service management validation]

ASCSPD-36	<p>a) A <b>BilateralCarrierProfile</b> data set shall contain at least one of the following:</p> <ol style="list-style-type: none"> <li>1) <b>FcltuTSM</b> data set;</li> <li>2) <b>RaftTSM</b> data set;</li> <li>3) <b>RcfTSM</b> data set;</li> <li>4) <b>BilateralTSM</b> data set;</li> <li>5) <b>ReturnLinkFrameDataSink</b> data set; and/or</li> <li>6) <b>BilateralDataSink</b> data set.</li> </ol> <p>b) A <b>BilateralCarrierProfile</b> data set may contain more than one of any of the above-specified data sets.</p> <p>[service management validation]</p>
ASCSPD-37	<p>Each <b>BilateralCarrierProfile</b> data set shall contain transfer service mapping (TSM) and Data Sink data sets that are appropriate for that <b>BilateralCarrierProfile</b> data set.</p> <p>[service management validation]</p> <p>NOTE – The means by which the appropriateness is determined is itself defined bilaterally and is outside the scope of this Recommended Standard.</p>
ASCSPD-38	<p>a) A <b>RafProd</b> data set shall contain one and only one of the following:</p> <ol style="list-style-type: none"> <li>1) one <b>FecfOnly</b> data set;</li> <li>2) one <b>ReedSolomonCoding</b> data set;</li> <li>3) one <b>TurboCoding</b> data set; or</li> <li>4) one <b>ReedSolomonCoding</b> data set and one <b>TurboCoding</b> data set.</li> </ol> <p>b) A <b>TurboCoding</b> data set shall contain zero or one <b>ReedSolomonCoding</b> data set.</p> <p>[syntactic validation]</p>
ASCSPD-39	<p>If the <b>RafProd</b> data set contains a <b>ReedSolomonCoding</b> data set that contains a <b>TurboCoding</b> data set, then the following constraints on parameter values apply:</p> <ol style="list-style-type: none"> <li>a) the <code>errorCorrectionCapability</code> parameter of the <b>ReedSolomonCoding</b> data set must equal to 16;</li> <li>b) the <code>virtualFillLength</code> parameter of the <b>ReedSolomonCoding</b> data set must equal to 0 (zero);</li> <li>c) the <code>interleaveDepth</code> parameter of the <b>ReedSolomonCoding</b> data set must equal to one of [1, 2, 4, or 5]; and</li> <li>d) the <code>informationBlockLength</code> parameter of the <b>TurboCoding</b> data set must be equal to <math>223 \cdot 8 \cdot \text{interleaveDepth}</math> parameter value of the <b>ReedSolomonCoding</b> data set.</li> </ol> <p>(See reference [4] for the reasons for these constraints.)</p> <p>[service management validation]</p>

**5.3.5 AddSpaceCommunicationServiceProfileInvocation MESSAGE  
(ASCSP-I)(UM → CM)**

**5.3.5.1 General**

The **AddSpaceCommunicationServiceProfileInvocation** message conforms to the data set composition and relationship requirements for, and inherits the parameters of, the <<Invocation>> and <<SpaceCommunicationServiceProfile>> stereotype, as specified in 3.3.5.3.2 and 5.3.4, respectively. Figure 5-3 shows the message structure of the **ASCSP-I** message as a class diagram.

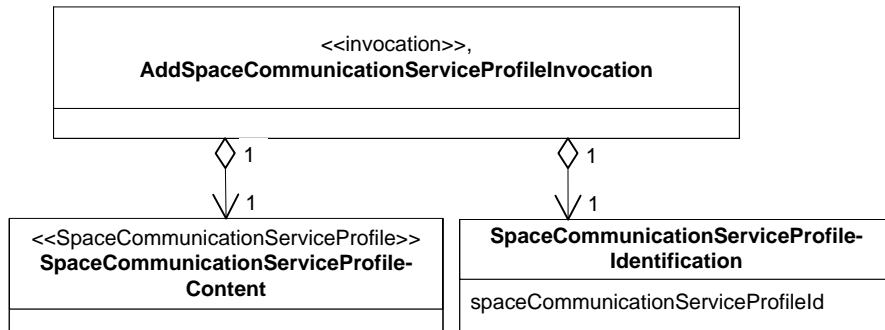

**Figure 5-3: ASCSP-I Message Structure Class Diagram**

**5.3.5.2 Parameters**

The constituent data set of the **ASCSP-I** message is defined in table 5-26.

**Table 5-26: SpaceCommunicationServiceProfileIdentification Data Set**

Parameter Name	Parameter Definition/Description	Data Type	Units	Applicable Service Agreement Parameter
spaceCommunicationServiceProfileId	Unique identifier of the Space Communication Service Profile, relative to the Service Agreement.	String256	n/a	n/a

**5.3.5.3 Data Set Composition and Relationship Requirements**

Table 5-27 defines the data set composition and relationship requirements for the **ASCSP-I** message.

**Table 5-27: Data Set Composition and Relationship Requirements for ASCSP-I**

ASCSPD-40	The <b>ASCSP-SR</b> shall contain: a) one <b>SpaceCommunicationServiceProfileIdentification</b> data set; and b) one <b>SpaceCommunicationServiceProfileContent</b> data set. [syntactic validation]
ASCSPD-41	The <code>spaceCommunicationServiceProfileId</code> parameter value of the <b>ASCSP-I</b> shall be unique with respect to all other Space Communication Service Profiles relative to the Service Agreement. [service management validation]

### 5.3.6 AddSpaceCommunicationServiceProfileAcknowledgedReturn (ASCSP-AR) (CM → UM)

#### 5.3.6.1 General

The **AddSpaceCommunicationServiceProfileAcknowledgedReturn** message conforms to the data set composition and relationship requirements for, and inherits the parameters of, the <<AcknowledgedReturn>> stereotype, as specified in 3.3.5.3.3.5. Figure 5-4 is the message structure class diagram for the **ASCSP-AR** message.

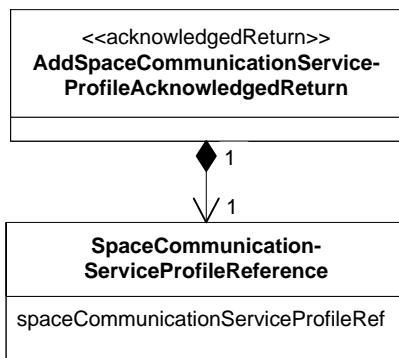
**Figure 5-4: ASCSP-AR Message Structure Class Diagram**

#### 5.3.6.2 Parameters

The constituent data set of the **ASCSP-AR** message is defined in table 5-28.

**Table 5-28: SpaceCommunicationServiceProfileReference Data Set**

Parameter Name	Parameter Definition/Description	Data Type	Units	Applicable Service Agreement Parameter
spaceCommunicationServiceProfileRef	Contains the value of the spaceCommunicationServiceProfileId parameter of the <b>ASCSP-I</b> that added the Space Communication Service Profile.	String 256	n/a	n/a

**5.3.6.3 Data Set Composition and Relationship Requirements**

Table 5-29 defines the data set composition and relationship requirements for the **ASCSP-AR** message.

**Table 5-29: Data Set Composition and Relationship Requirements for ASCSP-AR**

ASCSPD-42	The spaceCommunicationServiceProfileRef parameter value of the <b>ASCSP-AR</b> shall be equal to the spaceCommunicationServiceProfileId parameter of the <b>ASCSP-I</b> that attempted to invoke the operation. [service management validation]
ASCSPD-43	The <b>ASCSP-AR</b> shall contain one SpaceCommunicationServiceProfileReference data set.

**5.3.7 AddSpaceCommunicationServiceProfileSuccessfulReturn (ASCSP-SR) (CM → UM)**

**5.3.7.1 General**

The **AddSpaceCommunicationServiceProfileSuccessfulReturn** message conforms to the data set composition and relationship requirements for, and inherits the parameters of, the <<SuccessfulReturn>> stereotype, as specified in 3.3.5.3.3.2. Figure 5-5 is the message structure class diagram for the **ASCSP-SR** message.

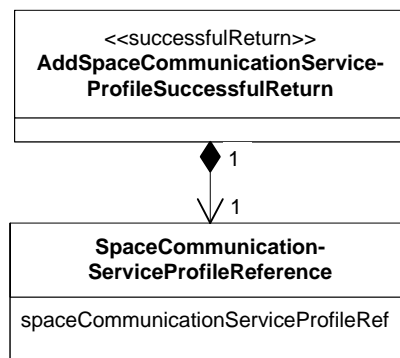

**Figure 5-5: ASCSP-SR Message Structure Class Diagram**

5.3.7.2 Parameters

The contents of the **SpaceCommunicationServiceProfileReference** data set are defined in table 5-28.

5.3.7.3 Data Set Composition and Relationship Requirements

Table 5-30 defines the data set composition and relationship requirements for the **ASCSP-SR** message.

**Table 5-30: Data Set Composition and Relationship Requirements for ASCSP-SR**

ASCSPD-44	The <b>ASCSP-SR</b> shall contain one <b>SpaceCommunicationServiceProfileReference</b> data set. [syntactic validation]
ASCSPD-45	The <b>SpaceCommunicationServiceProfileRef</b> parameter value of the <b>ASCSP-SR</b> shall be equal to the <b>SpaceCommunicationServiceProfileId</b> parameter of the <b>ASCSP-I</b> that invoked the operation. [service management validation]

5.3.8 AddSpaceCommunicationServiceProfileFailedReturn (ASCSP-FR) MESSAGE (CM → UM)

5.3.8.1 General

The **AddSpaceCommunicationServiceProfileFailedReturn** message conforms to the data set composition and relationship requirements for, and inherits the parameters of, the <<FailedReturn>> stereotype, as specified in table 3-10. Figure 5-6 is the message structure class diagram for the **ASCSP-FR** message.

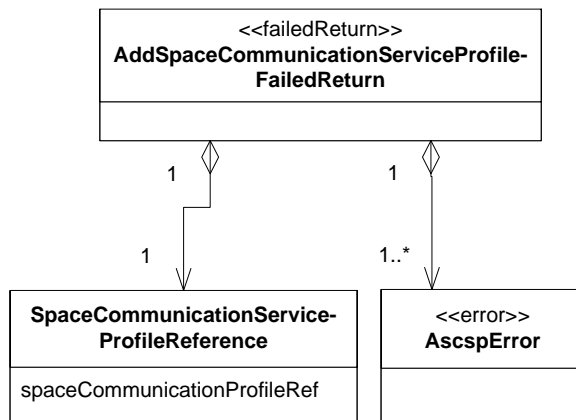

**Figure 5-6: ASCSP-FR Message Structure Class Diagram**

### 5.3.8.2 Parameters

The contents of the **SpaceCommunicationServiceProfileReference** data set are defined in table 5-28.

The **AscspError** dataset of the **AddSpaceCommunicationServiceProfile-FailedReturn** message conforms to the data set composition and relationship requirements for, and inherits the parameters of the <<Error>> data set stereotype, which contains a diagnostic parameter of the <<ErrorDiagnostic>> stereotype. Table 5-31 defines the additional values of the diagnostic parameter for the **AscspError** data set, identifies the CM and data set composition service management requirements that result in that diagnostic value being returned, and identifies the contents of the **erroredItem** and **additionalInformation** parameters that accompany each diagnostic value.

**Table 5-31: AscspError Data Set diagnostic Parameter Definition**

diagnostic value	Definition/Description	Rqmt	Parameter or Data Set Identified by erroredItem	Content of additional Information
'carrierProfileId value already in use'	There is a Carrier Profile with this identifier already registered at CM for the referenced Service Agreement.	ASCSPD-03	carrier-ProfileId	n/a
'spaceCommunicationServiceProfileId value already in use'	There is a Space Communication Service Profile with this identifier already registered at CM for the referenced Service Agreement.	ASCSPD-41	spaceCommunicationServiceProfileId	n/a
'exceeds maxCarrierProfiles'	<b>ASCSP-I</b> would cause the number of Carrier Profiles to exceed maxCarrierProfiles.	ASCSPC-04	carrier-ProfileId	n/a



diagnostic value	Definition/Description	Rqmt	Parameter or Data Set Identified by erroredItem	Content of additional Information
'mutually incompatible parameter values'	Two or more parameters of the <b>ASCSP-I</b> contain mutually incompatible values.	ASCSPC-06, ASCSPD-14, ASCSPD-15, ASCSPD-16, ASCSPD-17, ASCSPD-18, ASCSPD-19, ASCSPD-20, ASCSPD-21, ASCSPD-22, ASCSPD-23, ASCSPD-39	One of the mutually incompatible parameters (see GRD-0026, table 3-12)	n/a
'non-conformant to data set composition and relationship requirements of indicated bilateral format'	<p>The contents of the parameter <b>bilateralCarrierProfile</b> Data in the <b>BilateralCarrierProfile</b> data set do not meet the relevant data set composition and relationship requirements.</p> <p>The contents of the parameter <b>bilateralTsMData</b> in the <b>BilateralTsM</b> data set do not meet the relevant data set composition and relationship requirements.</p> <p>The contents of the parameter <b>bilateralDataSinkData</b> in the <b>BilateralDataSink</b> data set do not meet the relevant data set composition and relationship requirements.</p>	<p>ASCSPD-04</p> <p>ASCSPD-05</p> <p>ASCSPD-06</p>	<p>The <b>Bilateral-Carrier-Profile</b> data set</p> <p>The <b>Bilateral-TsM</b> data set</p> <p>The <b>Bilateral-DataSink</b> data set</p>	n/a
'operation timeout'	See table 3-11.	3PP-0104b		

diagnostic value	Definition/Description	Rqmt	Parameter or Data Set Identified by erroredItem	Content of additional Information
'Transfer Service Profile referenced by multiple carriers in the same Space Communication Service Profile'	A SLS Transfer Service Profile is referenced by more than one carrier in the Space Communication Service Profile.	ASCSPD-26	One of the transfer service mapping (XXXTsM) data set that contains one of the multiple references to the same SLS Transfer Service Profile.	The name of the Transfer Service Profile that is referenced multiple times.
'parameter value not supported by referenced Service Agreement'	The value of the parameter is not within the values permitted by the corresponding Service Agreement parameter.	ASCSPC-05, ASCSPD-25 ASCSPD-07 ASCSPD-13 ASCSPD-24	The parameter of the <b>ASCSP-I</b> that is in violation  r401Sub-carrier  f401SpaceLinkCarrier-AgreementRef  r401SpaceLinkCarrier-AgreementRef  channel-Assignment	n/a
'no matching transferService-ProfileId for transferService-ProfileRef'	The transferService-ProfileRef parameter references an SLS Transfer Service Profile or Retrieval Transfer Service Profile that is not available at CM.	ASCSPD-11, ASCSPD-12 ASCSPD-32 ASCSPD-33 ASCSPD-34	transfer-Service-ProfileRef	n/a
'multiple appearances of the same dataSinkId'	The <b>Space Communication Service Profile</b> contains two or more Data Sinks with the same value for the dataSinkId parameter.  NOTE – For each instance of the repeated dataSinkId, there is a separate <b>AscspError</b> data set.	ASCSPD-35	dataSinkId	value of the repeated Data Sink ID
'inappropriate Transfer Service Mapping or Data Sink for bilateral carrier'	The type or configuration of a Transfer Service Mapping or Data Sink is inappropriate for the Bilateral Carrier Profile to which it is attached.	ASCSPD-37	transferServiceProfile-Ref or dataSinkId	value of the transferServiceProfile-Ref or dataSinkId

diagnostic value	Definition/Description	Rqmt	Parameter or Data Set Identified by erroredItem	Content of additional Information
'no outlet for data'	No transfer services or data sinks included as outlets for the data from the return link symbol stream.	ASCSPD-31 ASCSPD-33	<b>RafProd</b> <b>BilateralCarrierProfile</b>	n/a
'other'	The operation has failed due to an error that is local to the Service Agreement.	ASCSPC-07	The invalid parameter or data set that causes the violation	Text-string description of the local error

### 5.3.8.3 Data Set Composition and Relationship Requirements

Table 5-32 defines the data set composition and relationship requirements for the **ASCSP-FR** message that are in addition to those of the <<FailedReturnWithDenial>> stereotype.

**Table 5-32: Data Set Composition and Relationship Requirements for the ASCSP-FR**

ASCSPD-46	The <code>spaceCommunicationServiceProfileRef</code> parameter value of the <b>ASCSP-FR</b> shall be equal to the <code>spaceCommunicationServiceProfileId</code> parameter of the <b>ASCSP-I</b> that attempted to invoke the operation. [service management validation]
ASCSPD-47	The <b>ASCSP-FR</b> shall contain one <b>SpaceCommunicationServiceProfileReference</b> data set. [syntactic validation]
ASCSPD-48	The <b>ASCSP-FR</b> shall contain one or more <b>AscspError</b> data sets. [syntactic validation]
ASCSPD-49	If the cause of the failure is 'Transfer Service Profile referenced by multiple carriers in the same Space Communication Service Profile', the <b>ASCSP-FR</b> shall contain one <b>AscspError</b> data set for each transfer service mapping data set that contains a repeated value for the <code>transferServiceProfileRef</code> parameter.

## 5.4 DELETE\_SPACE\_COMMUNICATION\_SERVICE\_PROFILE (DSCSP) OPERATION

### 5.4.1 PURPOSE

The DELETE\_SPACE\_COMMUNICATION\_SERVICE\_PROFILE (DSCSP) operation is used by UM to instruct CM to remove a previously installed Space Communication Service Profile from the set of Space Communication Service Profiles available at CM for a given Service Agreement.

### 5.4.2 PROCEDURE

**5.4.2.1** The DSCSP operation is defined to be a two-phase operation in accordance with the operation procedure pattern specified in 3.4.1.

**5.4.2.2** The DSCSP operation is defined in terms the following messages:

- DeleteSpaceCommunicationServiceProfileInvocation (DSCSP-I);
- DeleteSpaceCommunicationServiceProfileSuccessfulReturn (DSCSP-SR);
- DeleteSpaceCommunicationServiceProfileFailedReturn (DSCSP-FR).

**5.4.2.3** The message sequence diagram for the DELETE\_SPACE\_COMMUNICATION\_SERVICE\_PROFILE operation is defined by applying the following argument list to the stereotyped sequence diagram for the two-phase operation procedure pattern specified in 3.4.1.2:

```
twoPhaseOperationProcedurePatternSequence {UM, CM, DSCSP-I,
DSCSP-SR, DSCSP-FR}
```

**5.4.2.4** The activity diagram for the DELETE\_SPACE\_COMMUNICATION\_SERVICE\_PROFILE operation is defined by applying the following argument list to the stereotyped activity diagram for the two-phase operation procedure pattern specified in 3.4.1.4:

```
twoPhaseOperationProcedurePatternActivity {UM, CM, DSCSP-I,
DSCSP-SR, DSCSP-FR,
dscspRoutineTimeout,
dscspUrgentTimeout}
```

### 5.4.3 REQUIREMENTS

#### 5.4.3.1 UM Requirements for the DELETE\_SPACE\_COMMUNICATION\_ - SERVICE\_PROFILE Operation

The UM requirements for the **DSCSP** operation are defined in table 5-33.

**Table 5-33: UM Requirements for the DSCSP Operation**

DSCSPU-01	UM shall conform to all Invoker Requirements for Two-Phase Operation Procedures as specified in 3.4.1.5.1.
DSCSPU-02	UM shall conform to all <b>DSCSP-I</b> Data Set Composition and Relationship Requirements when creating and transmitting an <b>DSCSP-I</b> as specified in table 5-35.
DSCSPU-03	UM should send <b>DSCSP-I</b> messages that are valid with respect to all service management validation requirements for CM as defined in table 5-34.
DSCSPU-04	UM shall validate that a received <b>DSCSP-SR</b> or <b>DSCSP-FR</b> conforms to all <b>DSCSP-SR</b> or <b>DSCSP-FR</b> syntactic validation requirements specified in table 5-36 or table 5-38, respectively. If the return fails any of the syntactic validation requirements, UM shall process the message set containing the syntactically invalid return in accordance with the Invoker Requirements for Two-Phase Operation Procedures.
DSCSPU-05	UM shall validate that a received <b>DSCSP-SR</b> or <b>DSCSP-FR</b> conforms to all <b>DSCSP-SR</b> or <b>DSCSP-FR</b> service management validation requirements specified in table 5-36 or table 5-38, respectively. If the return fails any of the service management validation requirements, UM shall process the service management-invalid return in accordance with the Invoker Requirements for Two-Phase Operation Procedures.

#### 5.4.3.2 CM Requirements for the DELETE\_SPACE\_COMMUNICATION\_ - SERVICE\_PROFILE Operation

The CM requirements for the **DSCSP** operation are defined in table 5-34.

**Table 5-34: CM Requirements for the DSCSP Operation**

DSCSPC-01	CM shall conform to all Performer Requirements for Two-Phase Operation Procedures as specified in 3.4.1.5.2.
DSCSPC-02	CM shall validate that a received <b>DSCSP-I</b> conforms to all <b>DSCSP-I</b> syntactic validation requirements specified in table 5-35, Data Set Composition and Relationship Requirements for the <b>DSCSP-I</b> . If the <b>DSCSP-I</b> fails any of the syntactic requirements, CM shall process the message set containing the syntactically invalid return in accordance with the Performer Requirements for Two-Phase Operation Procedures.
DSCSPC-03	CM shall validate that the <b>DSCSP-I</b> conforms to all <b>DSCSP-I</b> service management validation requirements specified in this table and table 5-35, Data Set Composition and Relationship Requirements. If the <b>DSCSP-I</b> fails any of the service management requirements, CM shall cease processing the <b>DSCSP-I</b> and respond to UM with an <b>DSCSP-FR</b> message. The content of the <b>DSCSP-FR</b> depends on the nature of the validation failure, and is specified in table 5-37.
DSCSPC-04	CM shall validate that the <code>spaceCommunicationServiceProfileRef</code> matches the <code>spaceCommunicationServiceProfileId</code> for a Space Communication Service Profile within the context of the referenced Service Agreement. [service management validation]
DSCSPC-05	CM shall validate that there are no pending or executing Service Packages referencing the Space Communication Service Profile to be deleted. [service management validation]
DSCSPC-06	CM shall validate that there are no Space Link Events Profiles referencing any of the Space Link Carrier Profiles that are defined as part of that Space Communication Service Profile to be deleted. [service management validation]
DSCSPC-07	If <code>enforceOwnership</code> is 'true' in the Service Agreement, CM shall validate that the <code>smSource</code> associated with the <b>DSCSP-I</b> is the name of the owner of the Space Communication Service Profile associated with the <code>spaceCommunicationServiceProfileId</code> referenced by the <code>spaceCommunicationServiceProfileRef</code> in the <b>DSCSP-I</b> . [service management validation]
DSCSPC-08	If the Complex has locally defined <b>DSCSP-I</b> relationship requirements in addition to those specified in this Recommended Standard, CM shall validate that the <b>DSCSP-I</b> conforms to all such local requirements. [service management validation]
DSCSPC-09	If the <b>DSCSP-I</b> is valid, CM shall: <ul style="list-style-type: none"> <li>a) delete the referenced Space Communication Service Profile and any Carrier Profiles defined by it;</li> <li>b) remove the Carrier Profiles as counting against the <code>maxCarrierProfiles</code> parameter of the Service Agreement; and</li> <li>c) return a <b>DSCSP-SR</b>.</li> </ul> [perform operation]
DSCSPC-10	CM shall conform to all <b>DSCSP-SR</b> Data Set Composition and Relationship Requirements when creating and transmitting an <b>DSCSP-SR</b> as specified in table 5-36.
DSCSPC-11	CM shall conform to all <b>DSCSP-FR</b> Data Set Composition and Relationship Requirements when creating and transmitting an <b>DSCSP-FR</b> as specified in table 5-38.

**5.4.4 DeleteSpaceCommunicationServiceProfileInvocation (DSCSP-I) MESSAGE (UM → CM)**

**5.4.4.1 General**

The **DeleteSpaceCommunicationServiceProfileInvocation** message conforms to the data set composition and relationship requirements for, and inherits the parameters of, the <<Invocation>> stereotype, as specified in 3.3.5.3.2. Figure 5-7 is the message structure class diagram for the **DSCSP-I** message.

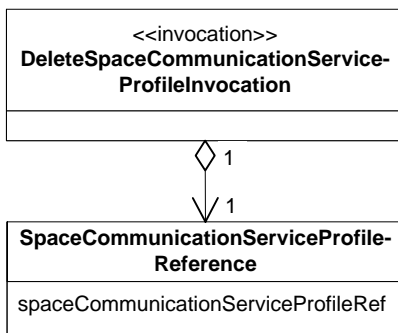

**Figure 5-7: DSCSP-I Message Structure Class Diagram**

**5.4.4.2 Parameters**

The contents of the **SpaceCommunicationServiceProfileReference** data set are defined in table 5-28.

**5.4.4.3 Data Set Composition and Relationship Requirements**

Table 5-35 defines the data set composition and relationship requirements for the **DSCSP-I** message.

**Table 5-35: Data Set Composition and Relationship Requirements for the DSCSP-I**

DSCSPD-01	The <b>DSCSP-I</b> shall contain one <b>SpaceCommunicationsServiceProfileReference</b> data set. [syntactic validation]
-----------	--

**5.4.5 DeleteSpaceCommunicationServiceProfileSuccessfulReturn (DSCSP-SR) MESSAGE (CM → UM)**

**5.4.5.1 General**

The **DeleteSpaceCommunicationServiceProfileSuccessfulReturn** message conforms to the data set composition and relationship requirements for, and inherits the parameters of, the <<SuccessfulReturn>> stereotype, as specified in 3.3.5.3.3.2. Figure 5-8 is the message structure class diagram for the **DSCSP-SR** message.

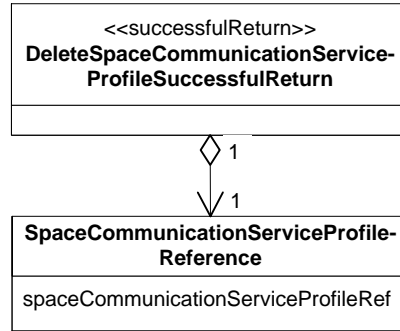

**Figure 5-8: DSCSP-SR Message Structure Class Diagram**

**5.4.5.2 Parameters**

The contents of the **SpaceCommunicationServiceProfileReference** data set are defined in table 5-28.

**5.4.5.3 Data Set Composition and Relationship Requirements**

Table 5-36 defines the data set composition and relationship requirements for the **DSCSP-SR** message.

**Table 5-36: Data Set Composition and Relationship Requirements for the DSCSP-SR**

DSCSPD-02	The <b>DSCSP-SR</b> shall contain one <b>SpaceCommunicationServiceProfileReference</b> data set. [syntactic validation]
DSCSPD-03	The <code>spaceCommunicationServiceProfileRef</code> parameter value of the <b>DSCSP-SR</b> shall be equal to the <code>spaceCommunicationServiceProfileRef</code> parameter of the <b>DSCSP-I</b> that invoked the operation. [service management validation]



## 5.4.6 DeleteSpaceCommunicationServiceProfileFailedReturn (DSCSP-FR) MESSAGE (CM → UM)

### 5.4.6.1 General

The **DeleteSpaceCommunicationServiceProfileFailedReturn** message conforms to the data set composition and relationship requirements for, and inherits the parameters of, the <<FailedReturn>> stereotype, as specified in table 3-10. Figure 5-9 is the message structure class diagram for the **DSCSP-FR** message.

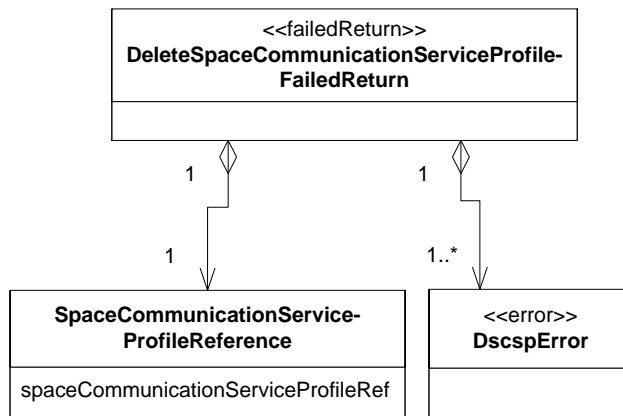

Figure 5-9: DSCSP-FR Message Structure Class Diagram

### 5.4.6.2 Parameters

The contents of the **SpaceCommunicationServiceProfileReference** data set are defined in table 5-28.

The **DscspError** dataset of the **DeleteSpaceCommunicationServiceProfileFailedReturn** message conforms to and inherits the parameters of the <<Error>> data set stereotype, which contains a diagnostic parameter of the <<ErrorDiagnostic>> stereotype. Table 5-37 defines the additional values of the diagnostic parameter for the **DscspError** data set, identifies the CM and data set composition service management requirements that result in that diagnostic value being returned, and identifies the contents of the `erroredItem` and `additionalInformation` parameters that accompany each diagnostic value.

**Table 5-37: DscspError Data Set diagnostic Parameter Definition**

diagnostic value	Definition/Description	Rqmt	Parameter or Data Set Identified by erroredItem	Content of additional Information
'operation timeout'	See table 3-11.	2PC-0103		
'referenced Space Communication Service Profile bound to pending Service Package'	The referenced Space Communication Service Profile cannot be deleted because it is bound to a pending Service Package.	DSCSPC-05	spaceCommunicationServiceProfileRef	Value of the servicePackageRef of a Service Package that is bound to the Space Communication Service Profile
'referenced Space Communication Service Profile contains a carrier profile that is bound to an available Space Link Events Profile'	The referenced Space Communication Service Profile cannot be deleted because it contains a carrier profile that is bound to an available Space Link Events Profile.	DSCSPC-06	carrierProfileId of the <b>SpaceLink-CarrierProfile</b> data set that is referenced by an operational Space Link Events Profile	
'referenced spaceCommunicationsServiceProfileId unknown'	The referenced spaceCommunicationServiceProfileId is not registered at CM within the context of the referenced Service Agreement.	DSCSPC-04	spaceCommunicationServiceProfileRef	n/a
'smSource not the owner'	The value of the smSource for the <b>SmMessageSet</b> containing the <b>DSCSP-I</b> is not the owner of the target Space Communication Service Profile.	DSCSPC-07	smSource	n/a
'other'	The operation has failed due to an error that is local to the Service Agreement.	DSCSPC-08	The invalid parameter or data set that causes the violation	Text-string description of the local error

### 5.4.6.3 Data Set Composition and Relationship Requirements

Table 5-38 defines the data set composition and relationship requirements for the **DSCSP-FR** message that are in addition to those of the <<FailedReturnWithDenial>> stereotype.

**Table 5-38: Data Set Composition and Relationship Requirements for the DSCSP-FR**

DSCSPD-04	The <b>DSCSP-FR</b> shall contain: a) one <b>SpaceCommunicationServiceProfileReference</b> data set; and b) one or more <b>DscspError</b> data sets. [syntactic validation]
DSCSPD-05	If the cause of the failure is ‘referenced Space Communication Service Profile contains a carrier profile that is bound to a pending Service Package’, the <b>DSCSP-FR</b> shall contain one <b>DscspError</b> data set for each Service Package that is bound to the Carrier Profile at the time that service management validation is attempted.
DSCSPD-06	If the cause of the failure is ‘referenced Space Communication Service Profile contains a carrier profile that is bound to an operational Space Link Events Profile’, the <b>DSCSP-FR</b> shall contain one <b>DscspError</b> data set for each Space Link Events Profile that is bound to the Carrier Profile at the time that service management validation is attempted.
DSCSPD-07	The <code>spaceCommunicationServiceProfileRef</code> parameter value of the <b>DSCSP-FR</b> shall be equal to the <code>spaceCommunicationServiceProfileId</code> parameter of the <b>DSCSP-I</b> that invoked the operation. [service management validation]

## 5.5 QUERY\_SPACE\_COMMUNICATION\_SERVICE\_PROFILE (QSCSP) OPERATION

### 5.5.1 PURPOSE

The QUERY\_SPACE\_COMMUNICATION\_SERVICE\_PROFILE (QSCSP) operation is used by UM to request a copy of Space Communication Service Profile that is already available at CM for a given Service Agreement.

### 5.5.2 PROCEDURE

**5.5.2.1** The QSCSP operation is defined to be a two-phase operation in accordance with the operation procedure pattern specified in 3.4.1.

**5.5.2.2** The QSCSP operation is defined in terms of the following messages:

- **QuerySpaceCommunicationServiceProfileInvocation (QSCSP-I);**
- **QuerySpaceCommunicationServiceProfileSuccessfulReturn (QSCSP-SR);**
- **QuerySpaceCommunicationServiceProfileFailedReturn (QSCSP-FR).**

**5.5.2.3** The message sequence diagram for the QUERY\_SPACE\_COMMUNICATION\_SERVICE\_PROFILE operation is defined by applying the following argument list to the stereotyped sequence diagram for the two-phase operation procedure pattern specified in 3.4.1.2:

```
twoPhaseOperationProcedurePatternSequence {UM, CM, QSCSP-I,
QSCSP-SR, QSCSP-FR}
```

**5.5.2.4** The activity diagram for the QUERY\_SPACE\_COMMUNICATION\_SERVICE\_PROFILE operation is defined by applying the following argument list to the stereotyped activity diagram for the two-phase operation procedure pattern specified in 3.4.1.4:

```
twoPhaseOperationProcedurePatternActivity {UM, CM, QSCSP-I,
QSCSP-SR, QSCSP-FR,
qscspRoutineTimeout,
qscspUrgentTimeout}
```

### 5.5.3 REQUIREMENTS

#### 5.5.3.1 UM Requirements for the QUERY\_SPACE\_COMMUNICATION\_ - SERVICE\_PROFILE Operation

The UM requirements for the QSCSP operation are defined in table 5-39.

**Table 5-39: UM Requirements for the QSCSP Operation**

QSCSPU-01	UM shall conform to all Invoker Requirements for Two-Phase Operation Procedures as specified in 3.4.1.5.1.
QSCSPU-02	UM shall conform to all QSCSP-I Data Set Composition and Relationship Requirements when creating and transmitting an QSCSP-I as specified in table 5-41.
QSCSPU-03	UM should send QSCSP-I messages that are valid with respect to all service management validation requirements for CM as defined in table 5-41.
QSCSPU-04	UM shall validate that a received QSCSP-SR or QSCSP-FR conforms to all QSCSP-SR or QSCSP-FR syntactic validation requirements specified in table 5-42 or table 5-44, respectively. If the return fails any of the syntactic validation requirements, UM shall process the message set containing the syntactically invalid return in accordance with the Invoker Requirements for Two-Phase Operation Procedures.
QSCSPU-05	UM shall validate that a received QSCSP-SR or QSCSP-FR conforms to all QSCSP-SR or QSCSP-FR service management validation requirements specified in table 5-42 or table 5-44, respectively. If the return fails any of the service management validation requirements, UM shall process the service management-invalid return in accordance with the Invoker Requirements for Two-Phase Operation Procedures.

#### 5.5.3.2 CM Requirements for the QUERY\_SPACE\_COMMUNICATION\_ - SERVICE\_PROFILE Operation

The CM requirements for the QSCSP operation are defined in table 5-40.

**Table 5-40: CM Requirements for the QSCSP Operation**

QSCSPC-01	CM shall conform to all Performer Requirements for Two-Phase Operation Procedures as specified in 3.4.1.5.2.
QSCSPC-02	CM shall validate that a received <b>QSCSP-I</b> conforms to all <b>QSCSP-I</b> syntactic validation requirements specified in table 5-41, Data Set Composition and Relationship Requirements for the <b>QSCSP-I</b> . If the <b>QSCSP-I</b> fails any of the syntactic requirements, CM shall process the message set containing the syntactically invalid return in accordance with the Performer Requirements for Two-Phase Operation Procedures.
QSCSPC-03	CM shall validate that the <b>QSCSP-I</b> conforms to all <b>QSCSP-I</b> service management validation requirements specified in this table and table 5-41, Data Set Composition and Relationship Requirements. If the <b>QSCSP-I</b> fails any of the service management requirements, CM shall cease processing the <b>QSCSP-I</b> and respond to UM with an <b>QSCSP-FR</b> message. The content of the <b>QSCSP-FR</b> depends on the nature of the validation failure, and is specified in table 5-43.
QSCSPC-04	CM shall validate that the <code>spaceCommunicationServiceProfileRef</code> matches the <code>spaceCommunicationServiceProfileId</code> for a Space Communication Service Profile within the context of the referenced Service Agreement. [service management validation]
QSCSPC-05	If the Complex has locally defined <b>QSCSP-I</b> relationship requirements in addition to those specified in this Recommended Standard, CM shall validate that the <b>QSCSP-I</b> conforms to all such local requirements. [service management validation]
QSCSPC-06	If the <b>QSCSP-I</b> is valid, CM shall create a copy of the requested Space Communication Service Profile and return it in a <b>QSCSP-SR</b> . [perform operation]
QSCSPC-07	CM shall conform to all <b>QSCSP-SR</b> Data Set Composition and Relationship Requirements when creating and transmitting an <b>QSCSP-SR</b> as specified in table 5-42.
QSCSPC-08	CM shall conform to all <b>QSCSP-FR</b> Data Set Composition and Relationship Requirements when creating and transmitting an <b>QSCSP-FR</b> as specified in table 5-44.

**5.5.4 QuerySpaceCommunicationServiceProfileInvocation (QSCSP-I) MESSAGE (UM → CM)**

**5.5.4.1 General**

The **QuerySpaceCommunicationServiceProfileInvocation** message conforms to the data set composition and relationship requirements for, and inherits the parameters of, the <<Invocation>> stereotype, as specified in 3.3.5.3.2. Figure 5-10 is the message structure class diagram for the **QSCSP-I** message.

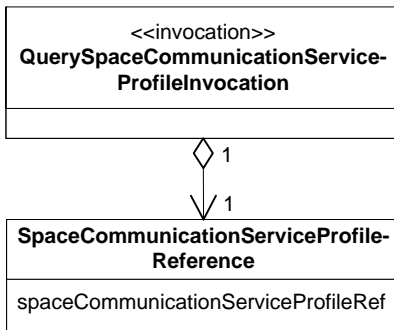

**Figure 5-10: QSCSP-I Message Structure Class Diagram**

**5.5.4.2 Parameters**

The contents of the **SpaceCommunicationServiceProfileReference** data set are defined in table 5-28.

**5.5.4.3 Data Set Composition and Relationship Requirements**

Table 5-41 defines the data set composition and relationship requirements for the **QSCSP-I** message.

**Table 5-41: Data Set Composition and Relationship Requirements for the QSCSP-I**

QSCSPD-01	The <b>QSCSP-I</b> shall contain one <b>SpaceCommunicationServiceProfileReference</b> data set. [syntactic validation]
-----------	---

**5.5.5 QuerySpaceCommunicationServiceProfileSuccessfulReturn (QSCSP-SR) MESSAGE (CM→UM)**

**5.5.5.1 General**

The **QuerySpaceCommunicationServiceProfileSuccessfulReturn** message conforms to the data set composition and relationship requirements for, and inherits the parameters of, the <<SuccessfulReturn>> stereotype (as specified in 3.3.5.3.3.2), and the <<SpaceCommunicationServiceProfile>> stereotype (as specified in 5.2.4). Figure 5-11 is the message structure class diagram for the **QSCSP-SR** message.

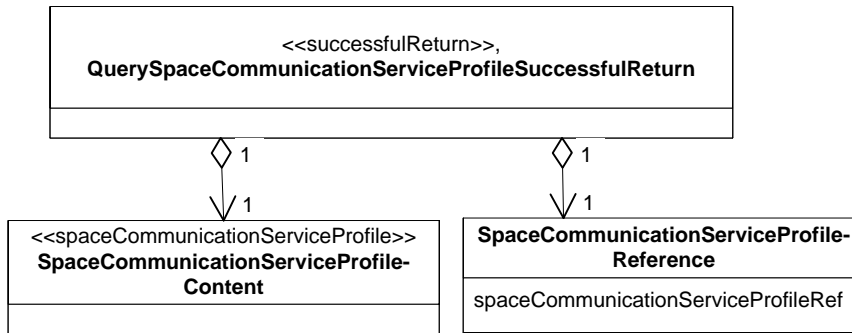

**Figure 5-11: QSCSP-SR Message Structure Class Diagram**

**5.5.5.2 Parameters**

The contents of the **SpaceCommunicationServiceProfileReference** data set are defined in table 5-28.

**5.5.5.3 Data Set Composition and Relationship Requirements**

Table 5-42 defines the data set composition and relationship requirements for the **QSCSP-SR** message.

**Table 5-42: Data Set Composition and Relationship Requirements for the QSCSP-SR**

QSCSPD-02	The <b>QSCSP-SR</b> shall contain: a) one <b>SpaceCommunicationServiceProfileReference</b> data set; and b) one <b>SpaceCommunicationServiceProfileContent</b> data set. [syntactic validation]
QSCSPD-03	The <code>spaceCommunicationServiceProfileRef</code> parameter value of the <b>QSCSP-SR</b> shall be equal to the <code>spaceCommunicationServiceProfileId</code> parameter of the <b>QSCSP-I</b> that invoked the operation. [service management validation]



## 5.5.6 QuerySpaceCommunicationServiceProfileFailedReturn (QSCSP-FR) MESSAGE (CM → UM)

### 5.5.6.1 General

The **QuerySpaceCommunicationServiceProfileFailedReturn** message conforms to the data set composition and relationship requirements for, and inherits the parameters of, the <<FailedReturn>> stereotype, as specified in table 3-10. Figure 5-12 is the message structure class diagram for the **QSCSP-FR** message.

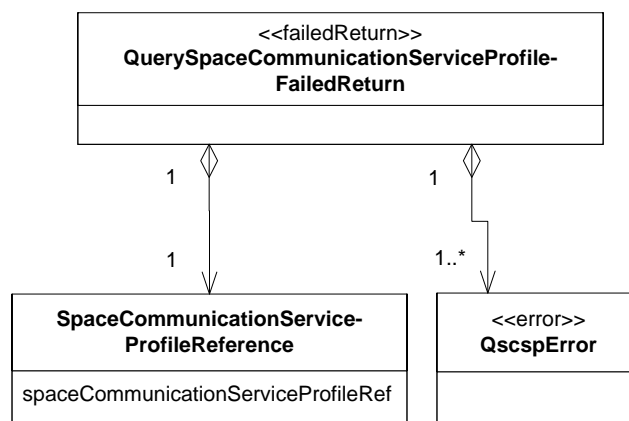

Figure 5-12: QSCSP-FR Message Structure Class Diagram

### 5.5.6.2 Parameters

The contents of the **SpaceCommunicationServiceProfileReference** data set are defined in table 5-28.

The **QscspError** data set of the **QuerySpaceCommunicationServiceProfileFailedReturn** message conforms to the data set composition and relationship requirements for, and inherits the parameters of, the <<Error>> data set stereotype, which contains a diagnostic parameter of the <<ErrorDiagnostic>> stereotype. Table 5-43 defines the additional values of the diagnostic parameter for the **QscspError** data set, identifies the CM and data set composition service management requirements that result in that diagnostic value being returned, and identifies the contents of the **erroredItem** and **additionalInformation** parameters that accompany each diagnostic value.

**Table 5-43: QscspError Data Set diagnostic Parameter Definition**

diagnostic value	Definition/Description	Rqmt	Parameter or Data Set Identified by erroredItem	Content of additional Information
'operation timeout'	See table 3-32.	2PC-0103		
'referenced spaceCommunicationServiceProfileId unknown'	The referenced spaceCommunicationServiceProfileId is not registered at CM within the context of the referenced Service Agreement.	QSCSPC-04	spaceCommunicationServiceProfileRef	n/a
'other'	The operation has failed due to an error that is local to the Service Agreement.	QSCSPC-05	The invalid parameter or data set that causes the violation	Text-string description of the local error

### 5.5.6.3 Data Set Composition and Relationship Requirements for QSCSP-FR

Table 5-44 defines the data set composition and relationship requirements for the **QSCSP-FR** message that are in addition to those of the <<FailedReturnWithDenial>> stereotype.

**Table 5-44: Data Set Composition and Relationship Requirements for the QSCSP-FR**

QSCSPD-04	The <b>QSCSP-FR</b> shall contain: a) one <b>SpaceCommunicationServiceProfileReference</b> data set; and b) one or more <b>QscspError</b> data sets. [syntactic validation]
QSCSPD-05	The <code>spaceCommunicationServiceProfileRef</code> parameter value of the <b>QSCSP-FR</b> shall be equal to the <code>spaceCommunicationServiceProfileId</code> parameter of the <b>QSCSP-I</b> that invoked the operation. [service management validation]

## 5.6 ADD\_SPACE\_LINK\_EVENTS\_PROFILE (ASLEP) OPERATION

### 5.6.1 PURPOSE

The `ADD_SPACE_LINK_EVENTS_PROFILE (ASLEP)` operation is used by UM to add a Space Link Events Profile to a set of profiles already available at the CM for a given Service Agreement.

### 5.6.2 PROCEDURE

**5.6.2.1** The ASLEP operation is defined to be a three-phase operation in accordance with the operation procedure pattern specified in 3.4.2.

**5.6.2.2** The ASLEP operation is defined in terms of the following messages:

- **AddSpaceLinkEventsProfileInvocation (ASLEP-I);**
- **AddSpaceLinkEventsProfileAcknowledgedReturn (ASLEP-AR);**
- **AddSpaceLinkEventsProfileSuccessfulReturn (ASLEP-SR);**
- **AddSpaceLinkEventsProfileFailedReturn (ASLEP-FR).**

**5.6.2.3** The message sequence diagram for the ADD\_SPACE\_LINK\_EVENTS\_PROFILE operation is defined by applying the following argument list to the stereotyped sequence diagram for the three-phase operation procedure pattern specified in 3.4.2.2:

```
threePhaseOperationProcedurePatternSequence {UM, CM, ASLEP-I,
                                             ASLEP-AR, ASLEP-SR,
                                             ASLEP-FR}
```

**5.6.2.4** The activity diagram for the ADD\_SPACE\_LINK\_EVENTS\_PROFILE operation is defined by applying the following argument list to the stereotyped activity diagram for the three-phase operation procedure pattern specified in 3.4.2.4:

```
threePhaseOperationProcedurePatternActivity {UM, CM, ASLEP-I,
                                               ASLEP-SR, ASLEP-SR,
                                               ASLEP-FR,
                                               aepRoutineTimeout,
                                               aepUrgentTimeout}
```

### 5.6.3 REQUIREMENTS

#### 5.6.3.1 UM Requirements for the ADD\_SPACE\_LINK\_EVENTS\_PROFILE Operation

The UM requirements for the **ASLEP** operation are defined in table 5-45.

**Table 5-45: UM Requirements for the ASLEP Operation**

ASLEPU-1	UM shall conform to all <b>ASLEP-I</b> Data Set Composition and Relationship Requirements when creating and transmitting an <b>ASLEP-I</b> as specified in table 5-57 and table 5-60.
ASLEPU-2	UM shall conform to all Invoker Requirements for Three-Phase Operation Procedures as specified in 3.4.2.5.1.
ASLEPU-3	UM should send <b>ASLEP-I</b> messages that are valid with respect to all service management validation requirements for CM as defined in table 5-57.
ASLEPU-4	UM shall validate that a received <b>ASLEP-AR</b> , <b>ASLEP-SR</b> or <b>ASLEP-FR</b> conforms to all <b>ASLEP-AR</b> , <b>ASLEP-SR</b> or <b>ASLEP-FR</b> syntactic validation requirements specified in table 5-62, table 5-63, or table 5-65, respectively. If the return fails any of the syntactic validation requirements, UM shall process the message set containing the syntactically invalid return in accordance with the Invoker Requirements for Three-Phase Operation Procedures.
ASLEPU-5	UM shall validate that a received <b>ASLEP-AR</b> , <b>ASLEP-SR</b> or <b>ASLEP-FR</b> conforms to all <b>ASLEP-AR</b> , <b>ASLEP-SR</b> or <b>ASLEP-FR</b> service management validation requirements specified in table 5-62, table 5-63, or table 5-65, respectively. If the return fails any of the service management validation requirements, UM shall process the service management-invalid return in accordance with the Invoker Requirements for Three-Phase Operation Procedures.

#### 5.6.3.2 CM Requirements for the ADD\_SPACE\_LINK\_EVENTS\_PROFILE Operation

The CM requirements for the **ASLEP** operation are defined in table 5-46.

**Table 5-46: CM Requirements for the ASLEP Operation**

ASLEPC-01	CM shall conform to all Performer Requirements for Three-Phase Operation Procedures as specified in 3.4.2.5.2.
ASLEPC-02	CM shall validate that a received <b>ASLEP-I</b> conforms to all <b>ASLEP-I</b> syntactic validation requirements specified in table 5-57 and table 5-60. If the <b>ASLEP-I</b> fails any of the syntactic requirements, CM shall process the message set containing the syntactically invalid return in accordance with the Performer Requirements for Three-Phase Operation Procedures.
ASLEPC-03	CM shall validate that the <b>ASLEP-I</b> conforms to all <b>ASLEP-I</b> service management validation requirements specified in table 5-57 and table 5-60, Data Set Composition and Relationship Requirements. If the <b>ASLEP-I</b> fails any of the service management requirements, CM shall cease processing the <b>ASLEP-I</b> and respond to UM with an <b>ASLEP-FR</b> message. The content of the <b>ASLEP-FR</b> depends on the nature of the validation failure, and is specified in table 5-64.
ASLEPC-04	CM shall validate that the <b>ASLEP-I</b> would not cause the number of Space Link Events Profiles to exceed the <code>maxSpaceLinkEventsProfiles</code> for the referenced Service Agreement. [service management validation]

ASLEPC-05	CM shall validate that each <b>ASLEP-I</b> parameter that is constrained by the referenced Service Agreement is consistent with such constraints. [service management validation]
ASLEPC-06	CM shall validate that all <b>ASLEP-I</b> parameter values that are related to each other (as defined in the Data Set Composition and Relationship Requirements) contain mutually compatible values. [service management validation]
ASLEPC-07	If the Complex has locally defined <b>ASLEP-I</b> relationship requirements in addition to those specified in this Recommended Standard, CM shall validate that the <b>ASLEP-I</b> conforms to all such local requirements. [service management validation]
ASLEPC-08	If the <b>BilateralSpaceLinkEventsProfile</b> data set is used in the <b>ASLEP-I</b> , then CM shall validate that the <b>BilateralSpaceLinkEventsProfile</b> data set composition and relationship requirements for the format indicated by parameter <b>bilateralSpaceLinkEventsProfileFormatId</b> are met. [service management validation]
ASLEPC-09	If the <b>ASLEP-I</b> passes all syntactic and service management validation, CM shall: <ul style="list-style-type: none"> <li>a) add the Space Link Events Profile to the set of active Space Link Events Profiles available at CM;</li> <li>b) count the Space Link Events Profile as applying against the <b>maxSpaceLinkEventsProfiles</b> parameter of the Service Agreement;</li> <li>c) and send an <b>ASLEP-SR</b> message to UM.</li> </ul> [perform operation]
ASLEPC-10	CM shall conform to all <b>ASLEP-SR</b> Data Set Composition and Relationship Requirements when creating and transmitting an <b>ASLEP-SR</b> as specified in table 5-63.
ASLEPC-11	CM shall conform to all <b>ASLEP-FR</b> Data Set Composition and Relationship Requirements when creating and transmitting an <b>ASLEP-FR</b> as specified in table 5-65.
ASLEPC-12	CM shall conform to all <b>ASLEP-AR</b> Data Set Composition and Relationship Requirements when creating and transmitting an <b>ASLEP-AR</b> as specified in table 5-62.
ASLEPC-13	CM shall validate that every <b>[R F]SpaceLinkEvents</b> data set in <b>SpaceLinkEventsProfile</b> is in conformance with the parameters of the Space Link Carrier Profile indicated by the applicable <b>carrierProfileRef</b> and referenced <b>serviceAgreementRef</b> . [service management validation]

### 5.6.4 <<SmSpaceLinkEventsProfile>> DATA SET STEREOTYPE

#### 5.6.4.1 General

The <<SmSpaceLinkEventsProfile>> data set stereotype captures the parameters and data set relationships that are common among messages that create Space Link Events Profiles or report their contents. Figure 5-13 shows the message structure of the <<SmSpaceLinkEventsProfile>> data set stereotype as a class diagram.

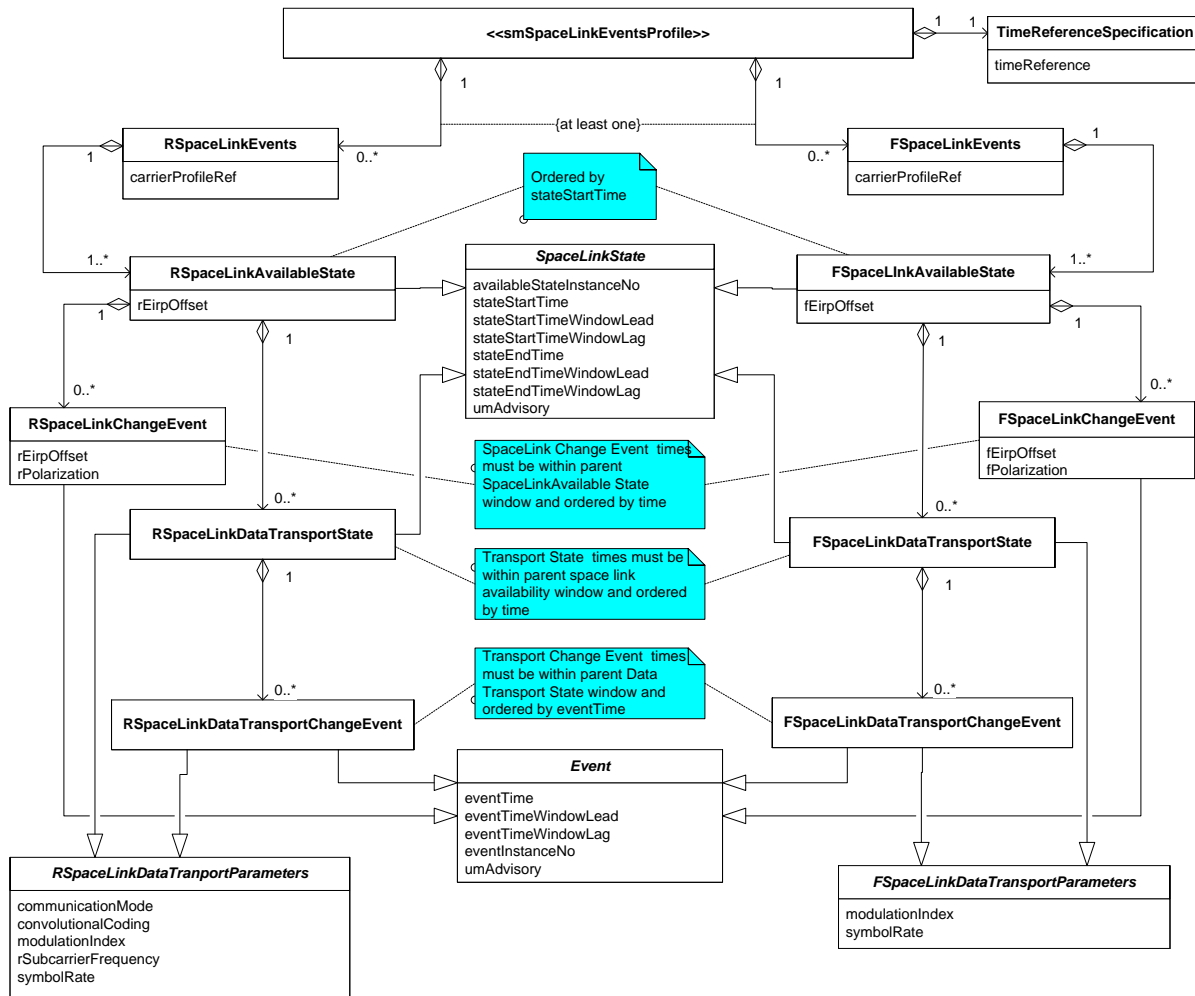

Figure 5-13: <<SmSpaceLinkEventsProfile>> Stereotype Structure Class Diagram

### 5.6.4.2 Parameters

The constituent data sets of the <<SmSpaceLinkEventsProfile>> stereotype are defined in tables 5-47 through 5-56.

**Table 5-47: TimeReferenceSpecification Data Set**

Parameter Name	Parameter Definition/Description	Data Type	Data Units	Applicable Service Agreement Parameter
timeReference	Indicates if the Events are expressed in relative terms or absolute terms. Allowed values are: – ‘absolute’—All events are expressed in absolute time; – ‘relative’—All events are expressed in relative time.	Enum	n/a	n/a

**Table 5-48: RSpaceLinkEvents, FSpaceLinkEvents Data Set  
<<SmSpaceLinkEventsProfile>>**

Parameter Name	Parameter Definition/Description	Data Type	Data Units	Applicable Service Agreement Parameter
carrierProfileRef	Contains the value of the carrierProfileId identifying the unique Carrier Profile within the referenced Service Agreement against which the [F R] Space Link Events data set of the Space Link Events Profile operates.	String256	n/a	n/a

**Table 5-49: RSpaceLinkAvailableState Data Set**  
 <<SmSpaceLinkEventsProfile>>

Parameter Name	Parameter Definition/Description	Data Type	Data Units	Applicable Service Agreement Parameter
availableState-InstanceNo	A monotonically increasing positive integer.	Positive Integer	n/a	n/a
rEirpOffset	The offset, if any, to the signal strength of the return carrier, as applied to the rEirp parameter of the R401SpaceLinkCarrierProfile (see table 5-10) indicated by the carrierProfileRef parameter (see table 5-48). NOTE— In real world operations it may be possible to provide only an estimated value. Establishing the range of accuracy for such an estimate is beyond the scope of this recommendation.	Integer	dBm	rMinEirp, rMaxEirp
stateStartTime	Expected or predicted time at which state is established. If expressed in relative terms, then stateStartTime is the time at which an event is to occur expressed relative to the scheduledCarrierStartTime of the SpaceCommunicationServiceResult data set referencing the carrier profile associated with the space link events profile. If expressed in absolute terms, the time is the spacecraft event time (SCET).	UTC (if absolute), Positive Integer (if relative)	Seconds (if relative)	n/a
stateStartTimeWindow-Lead	An offset that is subtracted from the stateScheduledStartTime in a Space Link Events Result to specify the earliest time that the carrier acquisition may occur.	Positive Integer	seconds	maxState-Start-TimeWindowLead
stateStartTimeWindow-Lag	An offset that is added to the stateScheduledStartTime in a Space Link Events Result to specify the latest time that the carrier acquisition may occur.	Positive Integer	seconds	maxState-Start-TimeWindowLag
stateEndTime	Expected or predicted time at which the state is terminated. If expressed in relative terms, then stateEndTime is the time at which an event is to occur expressed relative to the scheduledCarrierStartTime of the SpaceCommunicationServiceResult data set referencing the carrier profile associated with the space link events profile. If expressed in absolute terms, the time is the spacecraft event time (SCET).	UTC (if absolute), Positive Integer (if relative), or NULL	Seconds (if relative)	n/a



stateEndTimeWindowLead	An offset that is subtracted from the stateScheduledEndTime in a Space Link Events Result to specify the earliest time that the carrier lock may be lost.	Positive Integer or NULL	seconds	maxStateEndTime-WindowLead
stateEndTimeWindowLag	An offset that is added to the stateScheduledEndTime in a Space Link Events Result to specify the latest time that the carrier lock may be lost.	Positive Integer or NULL	seconds	maxStateEndTime-WindowLag
umAdvisory	Additional information related to a space link or data transport state or change events that UM may convey to CM. If no such information is available associated with the event being reported, the value shall be NULL. NOTE– This information and any resulting actions on the part of CM are not defined in this recommendation and are specific to the implementations involved.	String or NULL	n/a	n/a

**Table 5-50: FSpaceLinkAvailableState Data Set  
<<SmSpaceLinkEventsProfile>>**

Parameter Name	Parameter Definition/Description	Data Type	Data Units	Applicable Service Agreement Parameter
availableState-InstanceNo	See table 5-49.			
fEirpOffset	The offset, if any, to the signal strength of the forward carrier, applied to the fEirp parameter of the F401SpaceLinkCarrierProfile (see table 5-5) indicated by the carrierProfileRef parameter (see table 5-48).	Integer	dBm	fMinEirp, fMaxEirp
stateStartTime	See table 5-49.			
stateStartTimeWindow-Lead	See table 5-49.			
stateStartTimeWindow-Lag	See table 5-49.			
stateEndTime	See table 5-49.			
stateEndTimeWindowLead	See table 5-49.			
stateEndTimeWindowLag	See table 5-49.			
umAdvisory	See table 5-49.			

**Table 5-51: RSpaceLinkChangeEvent Data Set**  
 <<SmSpaceLinkEventsProfile>>

Parameter Name	Parameter Definition/Description	Data Type	Data Units	Applicable Service Agreement Parameter
rEirpOffset	See table 5-48.			
eventTime	The time at which an event is to occur. It can be expressed in either relative terms or absolute terms. If expressed in relative terms, then eventTime is the time at which an event is to occur expressed relative to the stateStartTime of the container <b>[R F]SpaceLinkAvailableStates</b> . If expressed in absolute terms, the time is the spacecraft event time (SCET). NOTE – The absolute time for the event is returned as the eventScheduledTime, a parameter of the Service Package Result.	UTC (if absolute), Positive Integer (if relative)	Seconds (if relative)	n/a
eventTimeWindowLead	An offset that is subtracted from the event-ScheduledTime in a Space Link Events Result to specify the earliest time that the event may occur.	Positive Integer	seconds	maxEventTimeWindowLead
eventTimeWindowLag	An offset that is added to the event-ScheduledTime in a Space Link Events Result to specify the latest time that the event may occur.	Positive Integer	seconds	maxEventTimeWindowLag
eventInstanceNo	A monotonically increasing positive integer.	Positive Integer	n/a	n/a
rPolarization	See table 5-10.			
umAdvisory	See table 5-49.			

**Table 5-52: FSpaceLinkChangeEvent Data Set  
<<SmSpaceLinkEventsProfile>>**

Parameter Name	Parameter Definition/Description	Data Type	Data Units	Applicable Service Agreement Parameter
fEirpOffset	See table 5-51.	Integer	dBm	fMinEirp, fMaxEirp
eventTime	See table 5-51.			
eventTimeWindowLead	See table 5-51.			
eventTimeWindowLag	See table 5-51.			
eventInstanceNo	See table 5-51.			
fPolarization	See table 5-5.			
umAdvisory	See table 5-49.			

**Table 5-53: RSpaceLinkDataTransportState Data Set  
<<SmSpaceLinkEventsProfile>>**

Parameter Name	Parameter Definition/Description	Data Type	Data Units	Applicable Service Agreement Parameter
availableState-InstanceNo	See table 5-49.			
stateStartTime	See table 5-49.			
stateStartTime-WindowLead	See table 5-49.			
stateStartTime-WindowLag	See table 5-49.			
stateEndTime	See table 5-49.			
stateEndTime-WindowLead	See table 5-49.			
stateEndTime-WindowLag	See table 5-49.			

Parameter Name	Parameter Definition/Description	Data Type	Data Units	Applicable Service Agreement Parameter
communicationMode	<p>The ground-spacecraft communication mode for tracking the return carrier. Legal values are:</p> <p>‘1-way’—one way: a carrier for a return space link only is present: The return carrier frequency tracking is in reference to the carrierFrequency parameter value of the <b>R401SpaceLinkCarrier-Profile</b> data set.</p> <p>NOTE – This indicates that the return carrier frequency is being generated in reference to an on-board spacecraft resource (e.g., oscillator).</p> <p>‘2-way’—two way: carriers for both forward and return space links are present: The return carrier frequency may be coherent with the forward carrier as defined by the Carrier Profile in either a <b>ReturnCoherenceModel</b> data set or a <b>ReturnOffsetModel</b> data set. Both the forward and return carrier space link service involve the same antennaRef parameter.</p> <p>‘3-way’—three way: carriers for both forward and return space links are present: The return carrier frequency may be coherent with the forward carrier frequency as defined in a Carrier Profile in either a <b>ReturnCoherenceModel</b> data set or a <b>ReturnOffsetModel</b> data set. The forward and return carrier space link involves different antennaRef parameters.</p> <p>NOTE – Whether the antenna is selected by UM or CM is subject to the planning agreed between the UM and the CM.</p> <p>‘3-way external network’—Return link may be coherent with forward carrier involving a third CM provider. Any necessary carrier information shall be exchanged via the messagePrivateAnnotation parameter in the <b>AddSpaceLink-EventsProfileInvocation</b> using a bilaterally agreed format.</p>	Enum	n/a	
convolutional-Coding	See table 5-14.			
modulationIndex	See table 5-5.			

Parameter Name	Parameter Definition/Description	Data Type	Data Units	Applicable Service Agreement Parameter
rSubcarrier-Frequency	See table 5-11 for definition. In this context, this parameter is set to NULL when subcarrier is not present.	Positive Integer or NULL		
symbolRate	See table 5-8.			
umAdvisory	See table 5-49.			

**Table 5-54: FSpaceLinkDataTransportState Data Set**  
 <<SmSpaceLinkEventsProfile>>

Parameter Name	Parameter Definition/Description	Data Type	Data Units	Applicable Service Agreement Parameter
availableState-InstanceNo	See table 5-49.			
stateStartTime	See table 5-49.			
stateStartTimeWindow-Lead	See table 5-49.			
stateStartTimeWindow-Lag	See table 5-49.			
stateEndTime	See table 5-49.			
stateEndTimeWindow-Lead	See table 5-49.			
stateEndTimeWindowLag	See table 5-49.			
modulationIndex	See table 5-5.			
symbolRate	See table 5-8.			
umAdvisory	See table 5-49.			

**Table 5-55: FSpaceLinkDataTransportChangeEvent Data Set**  
 <<SmSpaceLinkEventsProfile>>

Parameter Name	Parameter Definition/Description	Data Type	Data Units	Applicable Service Agreement Parameter
eventTime	See table 5-51.			
eventTimeWindowLead	See table 5-51.			
eventTimeWindowLag	See table 5-51.			
eventInstanceNo	See table 5-51.			
modulationIndex	See table 5-5.			F401SpaceLinkCarrier-Agreement: modulationIndexRange
fPolarization	See table 5-5.			
symbolRate	See table 5-8.			
umAdvisory	See table 5-49.			

**Table 5-56: RSpaceLinkDataTransportChangeEvent Data Set  
<<SmSpaceLinkEventsProfile>>**

Parameter Name	Parameter Definition/Description	Data Type	Data Units	Applicable Service Agreement Parameter
eventTime	See table 5-51.			
eventTimeWindowLead	See table 5-51.			
eventTimeWindowLag	See table 5-51.			
eventInstanceNo	See table 5-51.			
communicationMode	See table 5-53.			
convolutionalCoding	See table 5-14.			
modulationIndex	See table 5-5.			R401SpaceLink- CarrierAgreement: modulationIndexRange
rSubcarrierFrequency	See table 5-11 for definition. In this context, this parameter is set to NULL when subcarrier is not present.	Positive Integer or NULL		
rPolarization	See table 5-10.			
symbolRate	See table 5-8.			
umAdvisory	See table 5-49.			

### 5.6.4.3 Data Set Composition and Relationship Requirements

Table 5-57 defines the data set composition and relationship requirements for the **SmSpaceLinkEventsProfile** data sets.

**Table 5-57: Data Set Composition and Relationship Requirements for all SmSpaceLinkEventsProfile Data Sets**

ASLEPD-1	<p>A <b>SmSpaceLinkEventsProfile</b> data set:</p> <ul style="list-style-type: none"> <li>a) shall contain at least one of <b>RSpaceEvent</b> data set or <b>FSpaceEvent</b> data set;</li> <li>b) may contain any combination of <b>[R F]SpaceEvent</b> data sets; and</li> <li>c) shall contain one <b>TimeReferenceSpecification</b> data set.</li> </ul> <p>[syntactic validation]</p>
ASLEPD-2	<p>Each <b>[R F]SpaceLinkEvents</b> data set</p> <ul style="list-style-type: none"> <li>a) shall contain at least one <b>[R F]SpaceLinkAvailableStates</b> data set;</li> </ul> <p>[syntactic validation]</p> <ul style="list-style-type: none"> <li>b) shall have a <b>carrierProfileRef</b> parameter corresponding to an available Space Link Carrier Profile associated with the service agreement referenced in message invocation container;</li> </ul> <p>[service management validation]</p> <ul style="list-style-type: none"> <li>c) shall have all <b>stateStartTime</b> and <b>eventTime</b> parameters associated with contained data sets be consistent with the <b>timeReference</b> parameter of the <b>TimeReferenceSpecification</b> data set (i.e., all <b>stateStartTime</b> and <b>eventTime</b> values shall be in absolute units if the <b>timeReference</b> has a value of ‘absolute’ or in relative units if the <b>timeReference</b> has a value of ‘relative’);</li> </ul> <p>[service management validation]</p> <ul style="list-style-type: none"> <li>d) shall order all <b>[R F]SpaceLinkAvailableStates</b> data sets chronologically in ascending value of the <b>stateStartTime</b> parameter (i.e., each available state shall be ordered later than its predecessors);</li> </ul> <p>[service management validation]</p> <ul style="list-style-type: none"> <li>e) shall order all <b>[R F]SpaceLinkAvailableStates</b> data sets with monotonically increasing <b>availableStateInstanceNo</b> parameter values.</li> </ul> <p>[service management validation]</p>

ASLEPD-3	<p>Each <b>[R F]SpaceLinkAvailableState</b> data set:</p> <ul style="list-style-type: none"> <li>a) shall contain zero or more <b>[R F]SpaceLinkChangeEvent</b> data sets; [syntactic validation]</li> <li>b) shall contain zero or more <b>[R F]FSpaceLinkDataTransportState</b> data sets; [syntactic validation]</li> <li>c) shall have a <code>stateEndTime</code> parameter value which is either null or greater than the corresponding <code>stateStartTime</code>; [service management validation]</li> <li>d) shall have null <code>stateEndTimeWindowLag</code> and <code>stateEndTimeWindowLead</code> parameter values if the corresponding <code>stateEndTime</code> parameter value is also null; [service management validation]</li> <li>e) shall have an <code>availableStateInstanceNo</code> parameter value which is unique within the <b>[R F]SpaceLinkEvents</b>;</li> <li>f) shall have an <code>availableStateInstanceNo</code> parameter value which is larger than all other <code>availableStateInstanceNo</code> parameters corresponding to earlier <b>[R F]SpaceLinkAvailableStates</b> data sets; [service management validation]</li> <li>g) shall constrain all <code>stateStartTime</code> parameters such that application of the <code>stateStartTimeWindowLead</code> and <code>stateStartTimeWindowLag</code> parameters do not violate <code>minEventTemporalSpacing</code>; [service management validation]</li> <li>h) shall order all contained <b>[R F]SpaceLinkChangeEvent</b> data sets chronologically in ascending order by <code>eventTime</code>; [service management validation]</li> <li>i) shall order all contained <b>[R F]SpaceLinkChangeEvent</b> data sets in ascending order by <code>eventInstanceNo</code>; [service management validation]</li> <li>j) shall order all contained <b>[R F]SpaceLinkDataTransportState</b> data sets chronologically in ascending order by <code>stateStartTime</code>; [service management validation]</li> <li>k) shall order all contained <b>[R F]SpaceLinkDataTransportState</b> data sets in ascending order by <code>availableStateInstanceNo</code>. [service management validation]</li> </ul>
ASLEPD-4	<p>Each <b>[R F]SpaceLinkChangeEvent</b> data set:</p> <ul style="list-style-type: none"> <li>a) shall constrain the <code>eventTime</code> parameter such that application of the <code>eventTimeWindowLead</code> and <code>eventStartTimeWindowLag</code> parameters do not violate <code>minEventTemporalSpacing</code>; [service management validation]</li> <li>b) shall have an <code>eventInstanceNo</code> parameter value which is unique within the <b>[R F]SpaceLinkAvailableStates</b>;</li> <li>c) shall have an <code>eventInstanceNo</code> parameter value which is larger than all other <code>eventInstanceNo</code> parameters corresponding to earlier <b>[R F]SpaceLinkChangeEvent</b> data sets. [service management validation]</li> </ul>



ASLEPD-5	<p>Each <b>[R F]SpaceLinkDataTransportState</b> data set:</p> <ul style="list-style-type: none"> <li>a) shall contain zero or more <b>[R F]SpaceLinkDataTransportChangeEvent</b> data sets;</li> </ul> <p>[syntactic validation]</p> <ul style="list-style-type: none"> <li>b) shall have a <code>stateEndTime</code> parameter value which is either null or greater than the corresponding <code>stateStartTime</code>;</li> </ul> <p>[service management validation]</p> <ul style="list-style-type: none"> <li>c) shall have null <code>stateEndTimeWindowLag</code> and <code>stateEndTimeWindowLead</code> parameter values if the corresponding <code>stateEndTime</code> parameter value is also null;</li> </ul> <p>[service management validation]</p> <ul style="list-style-type: none"> <li>d) shall have an <code>availableStateInstanceNo</code> parameter value which is unique within the <b>[R F]SpaceLinkAvailableStates</b>;</li> <li>e) shall have an <code>availableStateInstanceNo</code> parameter value which is larger than all other <code>availableStateInstanceNo</code> parameters corresponding to earlier <b>[R F]SpaceLinkDataTransportState</b> data sets;</li> </ul> <p>[service management validation]</p> <ul style="list-style-type: none"> <li>f) shall order all contained <b>[R F]SpaceLinkDataTransportChangeEvent</b> data sets chronologically in ascending order by <code>eventTime</code>;</li> </ul> <p>[service management validation]</p> <ul style="list-style-type: none"> <li>g) shall order all contained <b>[R F]SpaceLinkDataTransportChangeEvent</b> data sets in ascending order by <code>eventInstanceNo</code>.</li> </ul> <p>[service management validation]</p>
ASLEPD-6	<p>Each <b>[R F]SpaceLinkDataTransportChangeEvent</b> data set:</p> <ul style="list-style-type: none"> <li>a) shall constrain the <code>eventTime</code> parameter such that application of the <code>eventTimeWindowLead</code> and <code>eventStartTimeWindowLag</code> parameters do not violate <code>minEventTemporalSpacing</code>;</li> <li>b) shall have an <code>eventTime</code> parameter value be within the interval bound by the parent <b>[R F]SpaceLinkDataTransportState</b> data set after adjustments are made for all possible values resulting from application of <code>eventTimeWindow</code>, <code>stateStartTimeWindow</code>, and <code>stateEndTimeWindow</code> parameters.</li> </ul> <p>[service management validation]</p>

5.6.5 AddSpaceLinkEventProfileInvocation MESSAGE (ASLEP-I) (UM → CM)

5.6.5.1 General

The **AddSpaceLinkEventsProfileInvocation** message conforms to the data set composition and relationship requirements for, and inherits the parameters of, the <<Invocation>> stereotype, as specified in 3.3.5.3.2. Figure 5-14 shows the message structure of the **ASLEP-I** message as a class diagram.

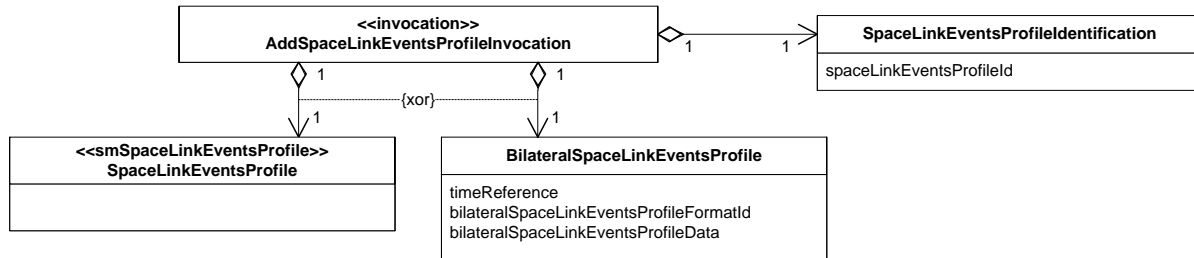

Figure 5-14: ASLEP-I Message Structure Class Diagram

5.6.5.2 Parameters

The **SpaceLinkEventsProfile** data set conforms to the data set composition and relationship requirements for, and inherits the parameters of, the <<SmSpaceLinkEventsProfile>> stereotype, as specified in 5.6.4.

The remaining constituent data sets of the **ASLEP-I** message are defined in tables 5-58 and 5-59.

Table 5-58: SpaceLinkEventsProfileIdentification Data Set

Parameter Name	Parameter Definition/Description	Data Type	Units	Applicable Service Agreement Parameter
spaceLinkEventsProfileId	Unique identifier of the space link events profile, relative to a Service Agreement.	String256	n/a	

**Table 5-59: BilateralSpaceLinkEventsProfile Data Set**

Parameter Name	Parameter Definition/Description	Data Type	Units	Applicable Service Agreement Parameter
bilateralSpaceLinkEvents-ProfileData	Contains the Events data in the format defined by the parameter bilateralEvents-ProfileFormatId.	Bilateral-Data	n/a	
bilateralSpaceLinkEvents-ProfileFormatId	Identification of Space Link Events Profile format other than the CCSDS standard format. This format must be bilaterally agreed between UM and CM.	String256	n/a	
timeReference	See table 5-48.			

### 5.6.5.3 Data Set Composition and Relationship Requirements

Table 5-60 defines the data set composition and relationship requirements for the **ASLEP-I** message that are in addition to those of the <<SmSpaceLinkEventsProfile>> stereotype.

**Table 5-60: Data Set Composition and Relationship Requirements for ASLEP-I**

ASLEPD-7	The <b>ASLEP-I</b> message shall contain a) one <b>SpaceLinkEventsServiceProfileIdentification</b> data set; and b) one and only one of the following: 1) <b>SpaceLinkEventsProfile</b> data set, 2) <b>BilateralSpaceLinkEventsProfile</b> data set. [syntactic validation]
ASLEPD-8	The <b>spaceLinkEventsProfileId</b> parameter shall be unique with respect to all other <b>spaceLinkEventsProfileId</b> parameters within the context of the Service Agreement referenced by the container of the invocation. [service management validation]

**5.6.6 AddSpaceLinkEventsProfileAcknowledgedReturn (ASLEP-AR) MESSAGE (CM → UM)**

**5.6.6.1 General**

The **AddSpaceLinkEventsProfileAcknowledgedReturn** message conforms to the data set composition and relationship requirements for, and inherits the parameters of, the <<AcknowledgedReturn>> stereotype, as specified in 3.3.5.3.3.5. Figure 5-15 is the message structure class diagram for the **ASLEP-AR** message.

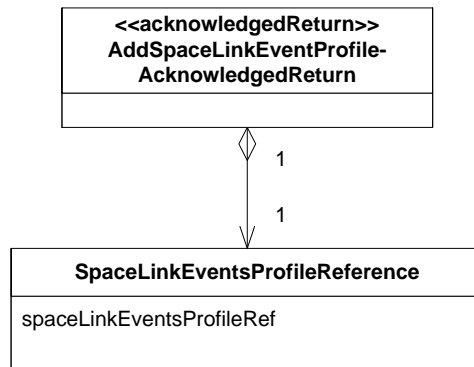

**Figure 5-15: ASLEP-AR Message Structure Class Diagram**

**5.6.6.2 Parameters**

The contents of the **SpaceLinkEventsProfileReference** data set are defined in table 5-61.

**Table 5-61: SpaceLinkEventsProfileReference Data Set**

Parameter Name	Parameter Definition/Description	Data Type	Data Units	Applicable Service Parameter
spaceLinkEvents-ProfileRef	The value of the spaceLinkEventsProfileId parameter of the Space Link Events Profile to which this message refers.	String256	n/a	n/a

**5.6.6.3 Data Set Composition and Relationship Requirements**

Table 5-62 defines the data set composition and relationship requirements for the **ASLEP-AR** message.

**Table 5-62: Data Set Composition and Relationship Requirements for ASLEP-AR**

ASLEPD-9	The <b>ASLEP-SR</b> shall contain one <b>SpaceLinkEventsProfileReference</b> data set. [syntactic validation]
ASLEPD-10	The <code>spaceLinkEventsProfileRef</code> parameter value of the <b>ASLEP-SR</b> shall be equal to the <code>spaceLinkEventsProfileId</code> parameter of the <b>ASLEP-I</b> that invoked the operation. [service management validation]

**5.6.7 AddSpaceLinkEventsProfileSuccessfulReturn MESSAGE (ASLEP-SR)(CM → UM)**

**5.6.7.1 General**

The **AddSpaceLinkEventsProfileSuccessfulReturn** message conforms to the data set composition and relationship requirements for, and inherits the parameters of, the <<SuccessfulReturn>> stereotype, as specified in 3.3.5.3.3.2. Figure 5-16 shows the message structure of the **ASLEP-SR** message as a class diagram.

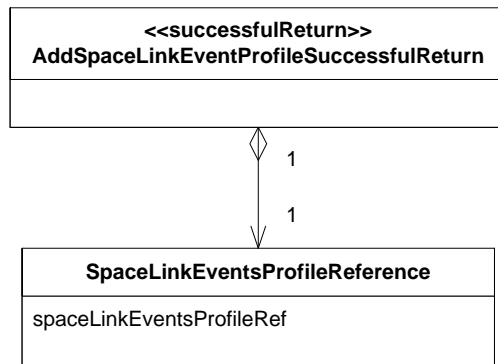

**Figure 5-16: ASLEP-SR Message Structure Class Diagram**

**5.6.7.2 Parameters**

Table 5-61 defines the parameter of the **SpaceLinkEventsProfileReference**.

5.6.7.3 Data Set Composition and Relationship Requirements

Table 5-63 defines the data set composition and relationship requirements for the **ASLEP-SR** message.

**Table 5-63: Data Set Composition and Relationship Requirements for the ASLEP-SR**

ASLEPD-11	The <b>ASLEP-SR</b> shall contain one <b>SpaceLinkEventsProfileReference</b> data set. [syntactic validation]
ASLEPD-12	The <code>spaceLinkEventsProfileRef</code> parameter value of the <b>ASLEP-SR</b> shall be equal to the <code>spaceLinkEventsProfileId</code> parameter of the <b>ASLEP-I</b> that invoked the operation. [service management validation]

5.6.8 AddSpaceLinkEventsProfileFailedReturn (ASLEP-FR) MESSAGE (CM → UM)

5.6.8.1 General

The **AddSpaceLinkEventsProfileFailedReturn** message conforms to the data set composition and relationship requirements for, and inherits the parameters of, the stereotype, as specified in table 3-10. Figure 5-17 is the message structure class diagram for the **ASLEP-FR** message.

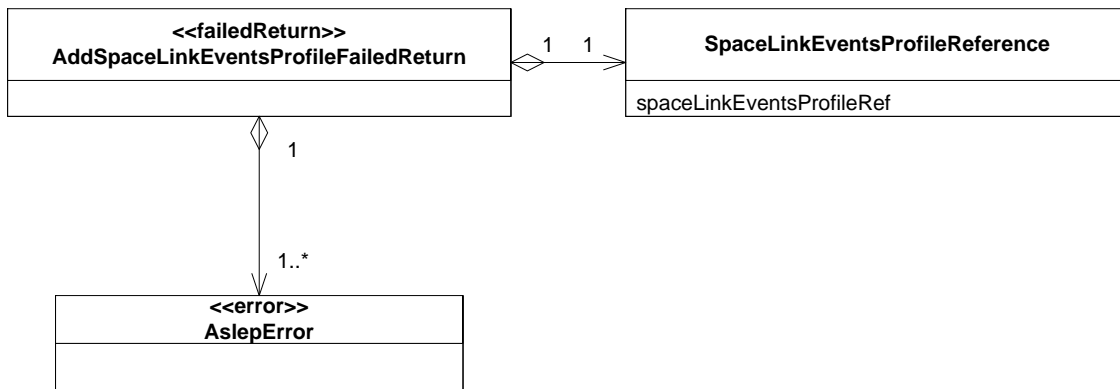

**Figure 5-17: ASLEP-FR Message Structure Class Diagram**

5.6.8.2 Parameters

The contents of the **SpaceLinkEventsProfileReference** data set are defined in table 5-61.

The **AslepError** data set of the **AddSpaceLinkEventsProfileFailedReturn** message conforms to the data set composition and relationship requirements for, and inherits

the parameters of, the <<Error>> data set stereotype, which contains a diagnostic parameter of the <<ErrorDiagnostic>> stereotype. Table 5-64 defines the additional values of the diagnostic parameter for the **AslepError** data set, identifies the CM and data set composition service management requirements that result in that diagnostic value being returned, and identifies the contents of the erroredItem and additional-Information parameters that accompany each diagnostic value.

**Table 5-64: AslepError Data Set diagnostic Parameter Definition**

diagnostic value	Definition/Description	Rqmt	Parameter or Data Set Identified by erroredItem	Content of additional Information
'availableState-InstanceNo out of sequence'	One or more values for the availableState-InstanceNo parameter less or equal to its predecessor.	ASLEPC-3, ASLEPD-2e, ASLEPD-3f, ASLEPD-3k, ASLEPD-5e	available-StateInstance-No	Predecessor and successor availableStateInstanceNo values if any
'availableState-InstanceNo not unique'	The values of the availableState-InstanceNo parameters of two or more data sets are not unique.	ASLEPD-3d ASLEPD-5d	One of the redundant available-StateInstance-No parameters	n/a
'eventInstanceNo out of sequence'	One or more values for the eventInstanceNo parameter is less or equal to its predecessor.	ASLEPD-3i, ASLEPD-4c, ASLEPD-5g	eventInstance-No	Predecessor and successor eventInstance-No values if any
'eventInstanceNo not unique'	The values of the eventInstanceNo parameters of two or more data sets are not unique.	ASLEPD-4b	One of the redundant eventInstance-No parameters	n/a
'events profile ID already in use'	There is an Events Profile with this identifier already registered at CM for the referenced Service Agreement.	ASLEPD-8	spaceLink-EventsProfile-Id	n/a
'exceeds maxSpaceLink-EventsProfiles'	<b>ASLEP-I</b> would cause the number of Space Link Events Profiles to exceed maxSpaceLinkEvents-Profiles.	ASLEPC-4	spaceLink-EventsProfile-Id	n/a

diagnostic value	Definition/Description	Rqmt	Parameter or Data Set Identified by erroredItem	Content of additional Information
'inconsistent time reference'	A stateStartTime or eventTime parameter associated with a contained data set is not consistent with the timeReference parameter of the <b>TimeReference-Specification</b> data set.	ASLEPD-2c	The stateStartTime or eventTime parameter that is not consistent with the timeReference parameter	n/a
'insufficient time between events'	One or more <b>[R F]SpaceLinkAvialableState, [R F]SpaceLinkChangeEvent, [R F]SpaceLinkDataTransportState, or [R F]SpaceLinkDataTransportChangeEvent</b> data set violate minEventTemporalSpacing.	ASLEPD-3g, ASLEPD-4a, ASLEPD-6a	First <b>[R F]-SpaceLink-Available-States, [R F]-SpaceLink-ChangeEvent, [R F]Space-LinkData-Transport-State, or [R F]Space-LinkData-Transport-ChangeEvent</b> that is in violation	n/a
'mutually incompatible parameter values'	Two or more parameters of the <b>ASLEP-I</b> contain mutually incompatible values.	ASLEPC-6, ASLEPD-3c, ASLEPD-3d, ASLEPD-5b, ASLEPD-5c, ASLEPD-6b	One of the mutually incompatible parameters (see GRD-0026, table 3-12)	n/a
'no matching carrierProfileId for carrier-ProfileRef'	The carrierProfileRef parameter references a Space Link Carrier Profile or Retrieval Transfer Service Profile that is not available at CM.	ASLEPD-2b	carrierProfileRef	n/a



diagnostic value	Definition/Description	Rqmt	Parameter or Data Set Identified by erroredItem	Content of additional Information
'non-conformant to data set composition and relationship requirements of indicated bilateral format'	The contents of the parameter <code>bilateralEvents-ProfileData</code> in the <b>BilateralEvents-Profile</b> data set do not meet the relevant data set composition and relationship requirements as specified in referenced bilaterally agreed format <code>bilateralEvents-ProfileFormatId</code> .	ASLEPC-08	n/a	n/a
'operation timeout'	See table 3-11.	3PP-0104b		
'parameter value not supported by referenced Service Agreement'	The value of the parameter is not within the values permitted by the corresponding Service Agreement parameter.	ASLEPC-5	The parameter of the <b>ASLEP-I</b> that is in violation	n/a
'time out of order'	A data set contains a <code>stateStartTime</code> or <code>eventTime</code> that is not greater than the corresponding time of the data set that precedes it.	ASLEPD-2d, ASLEPD-3h, ASLEPD-3j, ASLEPD-5f	The data set that is out of time order.	n/a
'other'	The operation has failed due to an error that is local to the Service Agreement.	ASLEPC-7	The invalid parameter or data set that causes the violation	Text-string description of the local error

### 5.6.8.3 Data Set Composition and Relationship Requirements

Table 5-65 defines the data set composition and relationship requirements for the **ASLEP-FR** message that are in addition to those of the <<FailedReturnWithDenial>> stereotype.

**Table 5-65: Data Set Composition and Relationship Requirements for ASLEP-FR**

ASLEPD-13	The <b>ASLEP-FR</b> shall contain one <b>SpaceLinkEventsProfileReference</b> data set. [syntactic validation]
ASLEPD-14	The <code>spaceLinkEventsProfileRef</code> parameter value of the <b>ASLEP-FR</b> shall be equal to the <code>spaceLinkEventsProfileId</code> parameter of the <b>ASLEP-I</b> that invoked the operation. [service management validation]
ASLEPD-15	The <b>ASLEP-FR</b> shall contain one or more <b>AslepError</b> data sets. [syntactic validation]
ASLEPD-16	If the cause of the failure is ‘mutually incompatible parameter values’, the <b>ASLEP-FR</b> shall contain one <b>AslepError</b> data set for each incompatible parameter.

## 5.7 DELETE\_SPACE\_LINK\_EVENTS\_PROFILE (DSLEP) OPERATION

### 5.7.1 PURPOSE

The `DELETE_SPACE_LINK_EVENTS_PROFILE` (DSLEP) operation is used by UM to delete an Events Profile from a set of profiles residing at CM for a given Service Agreement.

### 5.7.2 PROCEDURE

**5.7.2.1** The DSLEP operation is defined to be a two-phase operation in accordance with the operation procedure pattern specified in 3.4.1.

**5.7.2.2** The DSLEP operation is defined in terms of the following messages:

- **DeleteSpaceLinkEventsProfileInvocation** (DSLEP-I);
- **DeleteSpaceLinkEventsProfileSuccessfulReturn** (DSLEP-SR);
- **DeleteSpaceLinkEventsProfileFailedReturn** (DSLEP-FR).

**5.7.2.3** The message sequence diagram for the `DELETE_SPACE_LINK_EVENTS_PROFILE` operation is defined by applying the following argument list to the stereotyped sequence diagram for the two-phase operation procedure pattern specified in 3.4.1.2:

```
twoPhaseOperationProcedurePatternSequence {UM, CM, DSLEP-I,  
                                           DSLEP-SR, DSLEP-FR}
```

**5.7.2.4** The activity diagram for the `DELETE_SPACE_LINK_EVENTS_PROFILE` operation is defined by applying the following argument list to the stereotyped activity diagram for the two-phase operation procedure pattern specified in 3.4.1.4:

```
twoPhaseOperationProcedurePatternActivity {UM, CM, DSLEP-I,  
                                           DSLEP-SR, DSLEP-FR,  
                                           dslepRoutineTimeout,  
                                           dslepUrgentTimeout}
```

### 5.7.3 REQUIREMENTS

#### 5.7.3.1 UM Requirements for the DELETE\_SPACE\_LINK\_EVENTS\_PROFILE Operation

The UM requirements for the **DSLEP** operation are defined in table 5-66.

**Table 5-66: UM Requirements for the DSLEP Operation**

DSLEPU-01	UM shall conform to all Invoker Requirements for Two-Phase Operation Procedures as specified in 3.4.1.5.1.
DSLEPU-02	UM shall conform to all <b>DSLEP-I</b> Data Set Composition and Relationship Requirements when creating and transmitting an <b>DSLEP-I</b> as specified in table 5-68.
DSLEPU-03	UM should send <b>DSLEP-I</b> messages that are valid with respect to all service management validation requirements for CM as defined in table.
DSLEPU-04	UM shall validate that a received <b>DSLEP-SR</b> or <b>DSLEP-FR</b> conforms to all <b>DSLEP-SR</b> or <b>DSLEP-FR</b> syntactic validation requirements specified in table 5-63 or table 5-65, respectively. If the return fails any of the syntactic validation requirements, UM shall process the message set containing the syntactically invalid return in accordance with the Invoker Requirements for Two-Phase Operation Procedures.
DSLEPU-05	UM shall validate that a received <b>DSLEP-SR</b> or <b>DSLEP-FR</b> conforms to all <b>DSLEP-SR</b> or <b>DSLEP-FR</b> service management validation requirements specified in table 5-63 or table 5-65, respectively. If the return fails any of the service management validation requirements, UM shall process the service management-invalid return in accordance with the Invoker Requirements for Two-Phase Operation Procedures.

#### 5.7.3.2 CM Requirements for the DELETE\_SPACE\_LINK\_EVENTS\_PROFILE Operation

The CM requirements for the **DSLEP** operation are defined in table 5-67.

**Table 5-67: CM Requirements for the DSLEP Operation**

DSLEPC-01	CM shall conform to all Performer Requirements for Two-Phase Operation Procedures as specified in 3.4.1.5.2.
DSLEPC-02	CM shall validate that a received <b>DSLEP-I</b> conforms to all <b>DSLEP-I</b> syntactic validation requirements specified in table 5-68, Data Set Composition and Relationship Requirements for the <b>DSLEP-I</b> . If the <b>DSLEP-I</b> fails any of the syntactic requirements, CM shall process the message set containing the syntactically invalid return in accordance with the Performer Requirements for Two-Phase Operation Procedures.
DSLEPC-03	CM shall validate that the <code>spaceLinkEventsProfileRef</code> matches the <code>spaceLinkEventsProfileId</code> for a Space Link Events Profile within the context of the referenced Service Agreement. [service management validation]
DSLEPC-04	CM shall validate that the <code>spaceLinkEventsProfileRef</code> identifies a Space Link Events Profile that has no pending or executing Service Packages referencing it. [service management validation]

DSLEPC-05	If enforceOwnership is 'true' in the Service Agreement, CM shall validate that the smSource associated with the <b>DSLEP-I</b> is the name of the owner of the events associated with the spaceLinkEventsProfileId referenced by the spaceLinkEventsProfileRef in the <b>DSLEP-I</b> . [service management validation]
DSLEPC-06	If the Complex has locally defined <b>DSLEP-I</b> relationship requirements in addition to those specified in this Recommended Standard, CM shall validate that the <b>DSLEP-I</b> conforms to all such local requirements. [service management validation]
DSLEPC-07	If the <b>DSLEP-I</b> is valid, CM shall <ol style="list-style-type: none"> <li>delete the referenced <b>SpaceLinkEventsProfile</b>;</li> <li>remove the Space Link Events Profile as counting against the maxSpaceLinkEventsProfiles parameter of the Service Agreement; and</li> <li>return a <b>DSLEP-SR</b>.</li> </ol> [perform operation]
DSLEPC-08	CM shall conform to all <b>DSLEP-SR</b> Data Set Composition and Relationship Requirements when creating and transmitting an <b>DSLEP-SR</b> as specified in table 5-63.
DSLEPC-09	CM shall conform to all <b>DSLEP-FR</b> Data Set Composition and Relationship Requirements when creating and transmitting an <b>DSLEP-FR</b> as specified in table 5-65.

**5.7.4 DeleteSpaceLinkEventsProfileInvocation MESSAGE (DSLEP-I)**  
(UM → CM)

**5.7.4.1 General**

The **DeleteSpaceLinkEventsProfileInvocation** message conforms to the data set composition and relationship requirements for, and inherits the parameters of, the <<Invocation>> stereotype, as specified in 3.3.5.3.2. Figure 5-18 is the message structure class diagram for the **DSLEP-I** message.

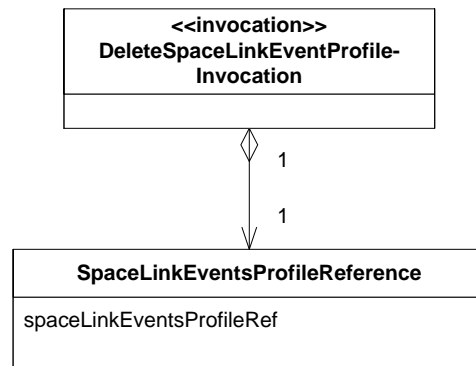

**Figure 5-18: DSLEP-I Message Structure Class Diagram**

**5.7.4.2 Parameters**

The contents of the **SpaceLinkEventsProfileReference** data set are defined in table 5-61.

### 5.7.4.3 Data Set Composition and Relationship Requirements

Table 5-68 defines the data set composition and relationship requirements for the DSLEP-I message.

**Table 5-68: Data Set Composition and Relationship Requirements for the DSLEP-I**

DSLEPD-1	The <b>DSLEP-I</b> shall contain one <b>SpaceLinkEventsProfileReference</b> data set. [syntactic validation]
----------	---

### 5.7.5 DeleteEventsProfileSuccessfulReturn MESSAGE (DSLEP-SR) (CM → UM)

#### 5.7.5.1 General

The **DeleteEventsProfileSuccessfulReturn** message conforms to the data set composition and relationship requirements for, and inherits the parameters of, the <<SuccessfulReturn>> stereotype, as specified in 3.3.5.3.3.2. Figure 5-19 is the message structure class diagram for the **DSLEP-SR** message.

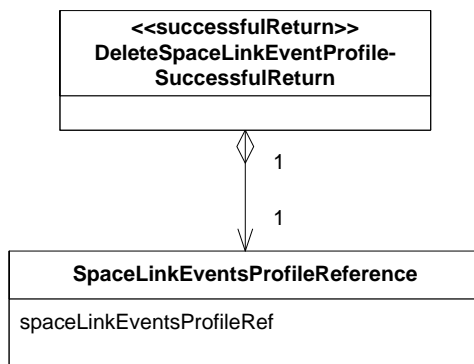

**Figure 5-19: DSLEP-SR Message Structure Class Diagram**

#### 5.7.5.2 Parameters

The contents of the **SpaceLinkEventsProfileReference** data set are defined in table 5-61.

5.7.5.3 Data Set Composition and Relationship Requirements

Table 5-69 defines the data set composition and relationship requirements for the **DSLEP-SR** message.

**Table 5-69: Data Set Composition and Relationship Requirements for the DSLEP-SR**

DSLEPD-2	The <b>DSLEP-SR</b> shall contain one <b>SpaceLinkEventsProfileReference</b> data set. [syntactic validation]
DSLEPD-3	The <code>spaceLinkEventsProfileRef</code> parameter value of the <b>DSLEP-SR</b> shall be equal to the <code>spaceLinkEventsProfileRef</code> parameter of the <b>DSLEP-I</b> that invoked the operation. [service management validation]

5.7.6 DeleteSpaceLinkEventsProfileFailedReturn MESSAGE (DSLEP-FR) (CM → UM)

5.7.6.1 General

The **DeleteSpaceLinkEventsProfileFailedReturn** message conforms to the data set composition and relationship requirements for, and inherits the parameters of, the `<<FailedReturn>>` stereotype, as specified in table 3-10. Figure 5-20 is the message structure class diagram for the **DSLEP-FR** message.

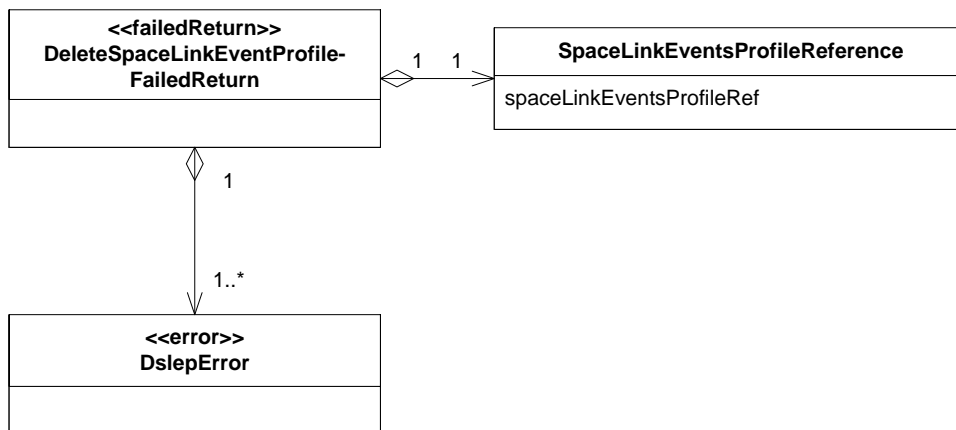

**Figure 5-20: DSLEP-FR Message Structure Class Diagram**

5.7.6.2 Parameters

The contents of the **SpaceLinkEventsProfileReference** data set are defined in table 5-61.

The **DslepError** dataset of the **DeleteSpaceLinkEventsProfileFailed-Return** message conforms to the data set composition and relationship requirements for, and inherits the parameters of the <<Error>> data set stereotype, which contains a diagnostic parameter of the <<ErrorDiagnostic>> stereotype. Table 5-70 defines the additional values of the diagnostic parameter for the **DslepError** data set, identifies the CM and data set composition service management requirements that result in that diagnostic value being returned, and identifies the contents of the `erroredItem` and `additionalInformation` parameters that accompany each diagnostic value.

**Table 5-70: DslepError Data Set diagnostic Parameter Definition**

diagnostic value	Definition/Description	Rqmt	Parameter or Data Set Identified by erroredItem	Content of additional Information
'referenced spaceLink-EventsProfileRef bound to pending Service Package'	The referenced Space Link Events Profile cannot be deleted because it is bound to a pending Service Package.	DSLEPC-04	spaceLink-EventsProfile-Ref	value of the service-PackageRef of a Service Package that is bound to the Events Profile
'referenced spaceLinkEvents-ProfileRef unknown'	The referenced spaceLinkEventsProfileRef is not registered at CM in the context of the referenced Service Agreement.	DSLEPC-03	spaceLink-EventsProfile-Ref	n/a
'smSource not the owner'	The value of the smSource for the <b>SmMessageSet</b> containing the <b>DSLEP-I</b> is not the owner of the target events profile.	DSLEPC-05	smSource	n/a
'operation timeout'	See table 3-11.	2PC-0103		
'other'	The operation has failed due to an error that is local to the Service Agreement.	DSLEPC-06	The invalid parameter or data set that causes the violation	Text-string description of the local error

### 5.7.6.3 Data Set Composition and Relationship Requirements

Table 5-71 defines the data set composition and relationship requirements for the **DSLEP-FR** message that are in addition to those of the <<FailedReturnWithDenial>> stereotype.

**Table 5-71: Data Set Composition and Relationship Requirements for DSLEP-FR**

DSLEPD-4	The <b>DSLEP-FR</b> shall contain one <b>SpaceLinkEventsProfileReference</b> data set. [syntactic validation]
DSLEPD-5	The <code>spaceLinkEventsProfileRef</code> parameter value of the <b>DSLEP-FR</b> shall be equal to the <code>spaceLinkEventsProfileRef</code> parameter of the <b>DSLEP-I</b> that invoked the operation. [service management validation]
DSLEPD-6	The <b>DSLEP-FR</b> shall contain one or more <b>DslepError</b> data sets. [syntactic validation]
DSLEPD-7	If the <code>diagnostic</code> parameter value is 'spaceLinkEventsProfileRef bound to pending Service Package', the <b>DSLEP-FR</b> shall contain one <b>DslepError</b> data set for each Service Package that is bound to the Events Profile at the time that service management validation is performed.

## 5.8 QUERY\_SPACE\_LINK\_EVENTS\_PROFILE (QSLEP) OPERATION

### 5.8.1 PURPOSE

The `QUERY_SPACE_LINK_EVENTS_PROFILE` (QSLEP) operation is used by UM to query the contents of a Space Link Events Profile that is already available at CM for a given Service Agreement.

### 5.8.2 PROCEDURE

**5.8.2.1** The QSLEP operation is defined to be a two-phase operation in accordance with the operation procedure pattern specified in 3.4.1.

**5.8.2.2** The QSLEP operation is defined in terms of the following messages:

- **QuerySpaceLinkEventsProfileInvocation** (QSLEP-I);
- **QuerySpaceLinkEventsProfileSuccessfulReturn** (QSLEP-SR);
- **QuerySpaceLinkEventsProfileFailedReturn** (QSLEP-FR).

**5.8.2.3** The message sequence diagram for the `QUERY_SPACE_LINK_EVENTS_PROFILE` operation is defined by applying the following argument list to the stereotyped sequence diagram for the two-phase operation procedure pattern specified in 3.4.1.2:

```
twoPhaseOperationProcedurePatternSequence {UM, CM, QSLEP-I,
                                           QSLEP-SR, QSLEP-FR}
```



**5.8.2.4** The activity diagram for the `QUERY_SPACE_LINK_EVENTS_PROFILE` operation is defined by applying the following argument list to the stereotyped activity diagram for the two-phase operation procedure pattern specified in 3.4.1.4:

```
twoPhaseOperationProcedurePatternActivity {UM, CM, QSLEP-I,
                                           QSLEP-SR, QSLEP-FR,
                                           qslepRoutineTimeout,
                                           qslepUrgentTimeout}
```

### 5.8.3 REQUIREMENTS

#### 5.8.3.1 UM Requirements for the `QUERY_SPACE_LINK_EVENTS_PROFILE` Operation

The UM requirements for the `QSLEP` operation are defined in table 5-72.

**Table 5-72: UM Requirements for the `QSLEP` Operation**

QSLEPU-1	UM shall conform to all Invoker Requirements for Two-Phase Operation Procedures as specified in 3.4.1.5.1.
QSLEPU-2	UM shall conform to all <code>QSLEP-I</code> Data Set Composition and Relationship Requirements when creating and transmitting an <code>QSLEP-I</code> as specified in table 5-74.
QSLEPU-3	UM should send <code>QSLEP-I</code> messages that are valid with respect to all service management validation requirements for CM as defined in table 5-74.
QSLEPU-4	UM shall validate that a received <code>QSLEP-SR</code> or <code>QSLEP-FR</code> conforms to all <code>QSLEP-SR</code> or <code>QSLEP-FR</code> syntactic validation requirements specified in table 5-75 or table 5-77, respectively. If the return fails any of the syntactic validation requirements, UM shall process the message set containing the syntactically invalid return in accordance with the Invoker Requirements for Two-Phase Operation Procedures.
QSLEPU-5	UM shall validate that a received <code>QSLEP-SR</code> or <code>QSLEP-FR</code> conforms to all <code>QSLEP-SR</code> or <code>QSLEP-FR</code> service management validation requirements specified in table 5-75 or table 5-77, respectively. If the return fails any of the service management validation requirements, UM shall process the service management-invalid return in accordance with the Invoker Requirements for Two-Phase Operation Procedures.
QSLEPU-6	If the <code>BilateralEventsProfile</code> data set is used in the <code>QSLEP-SR</code> , then UM shall validate that the <code>BilateralEventsProfile</code> data set composition and relationship requirements for the format indicated by parameter <code>bilateralSpaceLinkEventsProfileFormatId</code> are met. [service management validation]

### 5.8.3.2 CM Requirements for the `QUERY_SPACE_LINK_EVENTS_PROFILE` Operation

The CM requirements for the `QSLEP` operation are defined in table 5-73.

**Table 5-73: CM Requirements for the `QSLEP` Operation**

QSLEPC-1	CM shall conform to all Performer Requirements for Two-Phase Operation Procedures as specified in 3.4.1.5.2.
QSLEPC-2	CM shall validate that a received <code>QSLEP-I</code> conforms to all <code>QSLEP-I</code> syntactic validation requirements specified in table 5-74, Data Set Composition and Relationship Requirements for the <code>QSLEP-I</code> . If the <code>QSLEP-I</code> fails any of the syntactic requirements, CM shall process the message set containing the syntactically invalid return in accordance with the Performer Requirements for Two-Phase Operation Procedures.
QSLEPC-3	CM shall validate that the <code>spaceLinkEventsProfileRef</code> matches the <code>spaceLinkEventsProfileId</code> for an Events Profile within the context of the referenced Service Agreement. [service management validation]
QSLEPC-4	If the Complex has locally defined <code>QSLEP-I</code> relationship requirements in addition to those specified in this Recommended Standard, CM shall validate that the <code>QSLEP-I</code> conforms to all such local requirements. [service management validation]
QSLEPC-5	If the <code>QSLEP-I</code> is valid, CM shall create a copy of the requested Events Profile and return it in a <code>QSLEP-SR</code> . [perform operation]
QSLEPC-6	CM shall conform to all <code>QSLEP-SR</code> Data Set Composition and Relationship Requirements when creating and transmitting an <code>QSLEP-SR</code> as specified in table 5-62.
QSLEPC-7	CM shall conform to all <code>QSLEP-FR</code> Data Set Composition and Relationship Requirements when creating and transmitting an <code>QSLEP-FR</code> as specified in table 5-61.

### 5.8.4 `QuerySpaceLinkEventsProfileInvocation` MESSAGE (`QSLEP-I`)(UM → CM)

#### 5.8.4.1 General

The `QuerySpaceLinkEventsProfileInvocation` message conforms to the data set composition and relationship requirements for, and inherits the parameters of, the `<<Invocation>>` stereotype, as specified in 3.3.5.3.2. Figure 5-21 is the message structure class diagram for the `QSLEP-I` message.

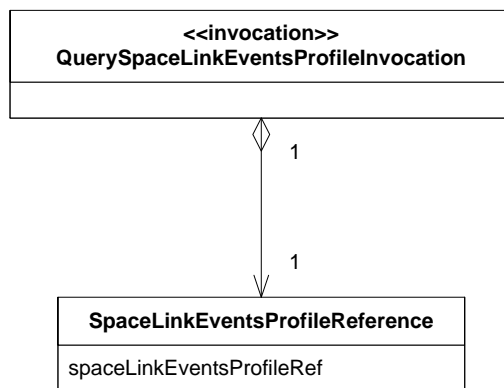

Figure 5-21: QSLEP-I Message Structure Class Diagram

#### 5.8.4.2 Parameters

The contents of the `SpaceLinkEventsProfileReference` data set are defined in table 5-61.

#### 5.8.4.3 Data Set Composition and Relationship Requirements

Table 5-74 defines the data set composition and relationship requirements for the `QSLEP-I` message.

Table 5-74: Data Set Composition and Relationship Requirements for the `QSLEP-I`

QSLEPD-1	The <code>QSLEP-I</code> shall contain one <code>SpaceLinkEventsProfileReference</code> data set. [syntactic validation]
----------	---

### 5.8.5 QuerySpaceLinkEventsProfileSuccessfulReturn MESSAGE (QSLEP-SR) (CM → UM)

#### 5.8.5.1 General

The `QuerySpaceLinkEventsProfileSuccessfulReturn` message conforms to the data set composition and relationship requirements for, and inherits the parameters of, the `<<SuccessfulReturn>>` stereotype, as specified in 3.3.5.3.3.2. Figure 5-22 is the message structure class diagram for the `QSLEP-SR` message.

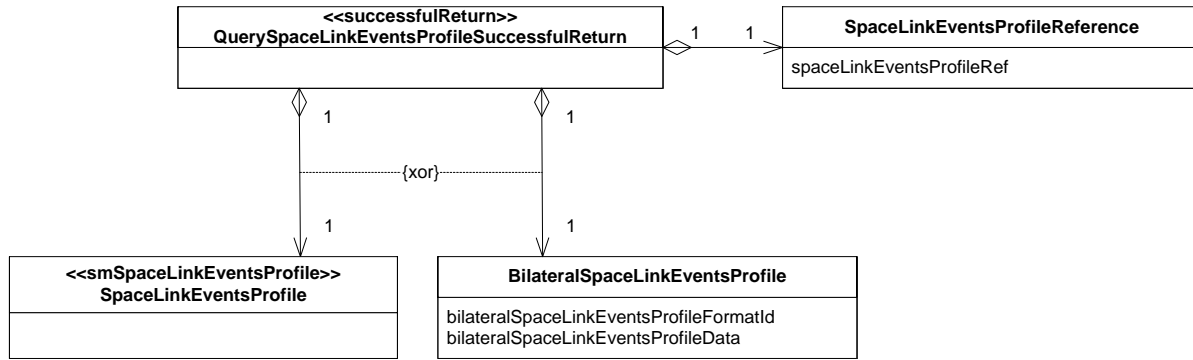

Figure 5-22: QSLEP-SR Message Structure Class Diagram

5.8.5.2 Parameters

The contents of the **SpaceLinkEventsProfileReference** data set are defined in table 5-61.

The **SpaceLinkEventsProfile** data set conforms to the data set composition and relationship requirements for, and inherits the parameters of, the <<StandardSpaceLinkEventsProfile>> stereotype, as specified in 5.6.4.

The contents of the **BilateralSpaceLinkEventsProfile** data set are defined in table 5-59.

5.8.5.3 Data Set Composition and Relationship Requirements

Table 5-75 defines the data set composition and relationship requirements for the **QSLEP-SR** message.

Table 5-75: Data Set Composition and Relationship Requirements for the QSLEP-SR

<p>QSLEPD-2</p>	<p>The <b>QSLEP-SR</b> shall comply with all data set composition and relationship requirements for the <b>ASLEP-I</b> message specified in table 5-74, with the following exception: the <b>QSLEP-SR</b> shall contain one <b>SpaceLinkEventsProfileReference</b> instead of one <b>SpaceLinkEventsProfileIdentification</b> data set. [syntactic validation]</p>
<p>QSLEPD-3</p>	<p>The <code>spaceLinkEventsProfileRef</code> parameter value of the <b>QSLEP-SR</b> shall be equal to the <code>spaceLinkEventsProfileRef</code> parameter of the <b>QSLEP-I</b> that invoked the operation. [service management validation]</p>

## 5.8.6 QuerySpaceLinkEventsProfileFailedReturn MESSAGE (QSLEP-FR)(CM → UM)

### 5.8.6.1 General

The **QuerySpaceLinkEventsProfileFailedReturn** message conforms to the data set composition and relationship requirements for, and inherits the parameters of, the <<FailedReturn>> stereotype, as specified in table 3-10. Figure 5-23 is the message structure class diagram for the **QSLEP-FR** message.

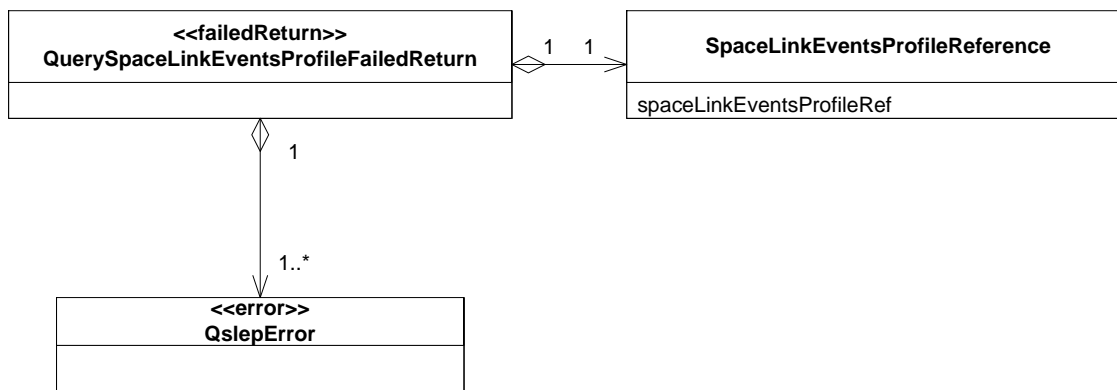

Figure 5-23: QSLEP-FR Message Structure Class Diagram

### 5.8.6.2 Parameters

The contents of the **SpaceLinkEventsProfileReference** data set are defined in table 5-61.

The **QslepError** dataset of the **QuerySpaceLinkEventsProfileFailedReturn** message conforms to the data set composition and relationship requirements for, and inherits the parameters of, the <<Error>> data set stereotype, which contains a diagnostic parameter of the <<ErrorDiagnostic>> stereotype. Table 5-76 defines the additional values of the diagnostic parameter for the **QslepError** data set, identifies the CM and data set composition service management requirements that result in that diagnostic value being returned, and identifies the contents of the erroredItem and additional-Information parameters that accompany each diagnostic value.

**Table 5-76: QslepError Data Set diagnostic Parameter Definition**

diagnostic value	Definition/Description	Rqmt	Parameter or Data Set Identified by erroredItem	Content of additional Information
'referenced Space Link Events Profile unknown'	The Space Link Events Profile referenced by spaceLinkEventsProfileRef is not registered at CM with respect to the referenced Service Agreement.	QSLEPC-3	spaceLinkEventsProfileRef	n/a
'operation timeout'	See table 3-11.	2PC-0103		
'other'	The operation has failed due to an error that is local to the Service Agreement.	QSLEPC-4	The invalid parameter or data set that causes the violation	Text-string description of the local error

### 5.8.6.3 Data Set Composition and Relationship Requirements

Table 5-77 defines the data set composition and relationship requirements for the QSLEP-FR message that are in addition to those of the <<FailedReturnWithDenial>> stereotype.

**Table 5-77: Data Set Composition and Relationship Requirements for QSLEP-FR**

QSLEPD-4	The QSLEP-FR shall contain one SpaceLinkEventsProfileReference data set. [syntactic validation]
QSLEPD-5	The spaceLinkEventsProfileRef parameter value of the QSLEP-FR shall be equal to the spaceLinkEventsProfileRef parameter of the QSLEP-I that invoked the operation. [service management validation]
QSLEPD-6	The QSLEP-FR shall contain one or more QslepError data sets. [syntactic validation]

## 5.9 ADD\_SLS\_TRANSFER\_SERVICE\_PROFILE (ASTSP) OPERATION

### 5.9.1 PURPOSE

The ADD\_SLS\_TRANSFER\_SERVICE\_PROFILE (ASTSP) operation is used by UM to add a new Space Link Session (SLS) Transfer Service Profile to the set of Transfer Service Profiles already available at CM for a given Service Agreement.

### 5.9.2 PROCEDURE

**5.9.2.1** The ASTSP operation is defined to be a three-phase operation in accordance with the operation procedure pattern specified in 3.4.2.

**5.9.2.2** The ASTSP operation is defined in terms of the following messages:

- **AddSlsTransferServiceProfileInvocation (ASTSP-I);**
- **AddSlsTransferServiceProfileAcknowledgedReturn (ASTSP-AR);**
- **AddSlsTransferServiceProfileSuccessfulReturn (ASTSP-SR);**
- **AddSlsTransferServiceProfileFailedReturn (ASTSP-FR).**

**5.9.2.3** The message sequence diagram for the ADD\_SLS\_TRANSFER\_SERVICE\_PROFILE operation is defined by applying the following argument list to the stereotyped sequence diagram for the three-phase operation procedure pattern specified in 3.4.2.2:

```
threePhaseOperationProcedurePatternSequence {UM, CM, ASTSP-I,
ASTSP-AR, ASTSP-SR,
ASTSP-FR}
```

**5.9.2.4** The activity diagram for the ADD\_SLS\_TRANSFER\_SERVICE\_PROFILE operation is defined by applying the following argument list to the stereotyped activity diagram for the three-phase operation procedure pattern specified in 3.4.2.4:

```
threePhaseOperationProcedurePatternActivity {UM, CM, ASTSP-I,
ASTSP-AR, ASTSP-SR,
ASTSP-FR
astspRoutineTimeout,
astspUrgentTimeout}
```

### 5.9.3 REQUIREMENTS

#### 5.9.3.1 UM Requirements for the ADD\_SLS\_TRANSFER\_SERVICE\_PROFILE Operation

The UM requirements for the **ASTSP** operation are defined in table 5-78.

**Table 5-78: UM Requirements for the ASTSP Operation**

ASTSPU-01	UM shall conform to all <b>ASTSP-I</b> Data Set Composition and Relationship Requirements when creating and transmitting an <b>ASTSP-I</b> as specified in table 5-84 and table 5-86.
ASTSPU-02	UM shall conform to all Invoker Requirements for Three-Phase Operation Procedures as specified in 3.4.2.5.1.
ASTSPU-03	UM should send <b>ASTLSP-I</b> messages that are valid with respect to all service management validation requirements for CM as defined table 5-86.
ASTSPU-04	UM shall validate that a received <b>ASTSP-AR</b> , <b>ASTSP-SR</b> , or <b>ASTSP-FR</b> conforms to all <b>ASTSP-AR</b> , <b>ASTSP-SR</b> , or <b>ASTSP-FR</b> syntactic validation requirements specified in table 5-88, table 5-89, or table 5-91, respectively. If the return fails any of the syntactic validation requirements, UM shall process the message set containing the syntactically invalid return in accordance with the Invoker Requirements for Three-Phase Operation Procedures.
ASTSPU-05	UM shall validate that a received <b>ASTSP-AR</b> , <b>ASTSP-SR</b> , or <b>ASTSP-FR</b> conforms to all <b>ASTSP-AR</b> , <b>ASTSP-SR</b> , or <b>ASTSP-FR</b> service management validation requirements specified in table 5-88, table 5-89, or table 5-91, respectively. If the return fails any of the service management validation requirements, UM shall process the service management-invalid return in accordance with the Invoker Requirements for Three-Phase Operation Procedures.



### 5.9.3.2 CM Requirements for the ADD\_SLS\_TRANSFER\_SERVICE\_PROFILE Operation

The CM requirements for the **ASTSP** operation are defined in table 5-79.

**Table 5-79: CM Requirements for the ASTSP Operation**

ASTSPC-01	CM shall conform to all Performer Requirements for Three-Phase Operation Procedures as specified in 3.4.2.5.2.
ASTSPC-02	CM shall validate that a received <b>ASTSP-I</b> conforms to all <b>ASTSP-I</b> syntactic validation requirements specified in table 5-86, Data Set Composition and Relationship Requirements for the <b>ASTSP-I</b> . If the <b>ASTSP-I</b> fails any of the syntactic requirements, CM shall process the message set containing the syntactically invalid invocation in accordance with the Performer Requirements for Three-Phase Operation Procedures.
ASTSPC-03	CM shall validate that the <b>ASTSP-I</b> conforms to all <b>ASTSP-I</b> service management validation requirements specified in this table and table 5-86 Data Set Composition and Relationship Requirements. If the <b>ASTSP-I</b> fails any of the service management requirements, CM shall cease processing the <b>ASTSP-I</b> and respond to UM with an <b>ASTSP-FR</b> message. The content of the <b>ASTSP-FR</b> depends on the nature of the validation failure, and is specified in table 5-91.
ASTSPC-04	CM shall validate that each <b>ASTSP-I</b> parameter that is constrained by a Service Agreement parameter is consistent with the applicable Service Agreement parameter. [service management validation]
ASTSPC-05	CM shall validate that all <b>ASTSP-I</b> parameter values that are related to each other (as defined in the Data Set Composition and Relationship Requirements) contain mutually compatible values. [service management validation]
ASTSPC-06	If the Complex has locally defined <b>ASTSP-I</b> relationship requirements in addition to those specified in this Recommended Standard, CM shall validate that the <b>ASTSP-I</b> conforms to all such local requirements. [service management validation]
ASTSPC-07	If the <b>ASTSP-I</b> passes all syntactic and service management validation, CM shall: <ul style="list-style-type: none"> <li>a) add the SLS Transfer Service Profile to the set of SLS Transfer Service Profiles available at CM;</li> <li>b) count the SLS Transfer Service Profile as applying against the <code>maxTransferServiceProfiles</code> parameter of the Service Agreement;</li> <li>c) send an <b>ASTSP-SR</b> message to CM.</li> </ul> [perform operation]
ASTSPC-08	CM shall conform to all <b>ASTSP-SR</b> Data Set Composition and Relationship Requirements when creating and transmitting an <b>ASTSP-SR</b> as specified in table 5-89.
ASTSPC-09	CM shall conform to all <b>ASTSP-FR</b> Data Set Composition and Relationship Requirements when creating and transmitting an <b>ASTSP-FR</b> as specified table 5-91.
ASTSPC-10	CM shall conform to all <b>ASTSP-AR</b> Data Set Composition and Relationship Requirements when creating and transmitting an <b>ASTSP-AR</b> as specified in table 5-88.

### 5.9.4 <<SlsTsProfile>> DATA SET STEREOTYPE

#### 5.9.4.1 General

The <<SlsTsProfile>> data set stereotype captures the parameters and data set relationships that are common among messages that create Space Link Session Transfer Service Profiles or report their contents. Figure 5-24 shows the message structure of the <<SlsTsProfile>> data set stereotype as a class diagram.

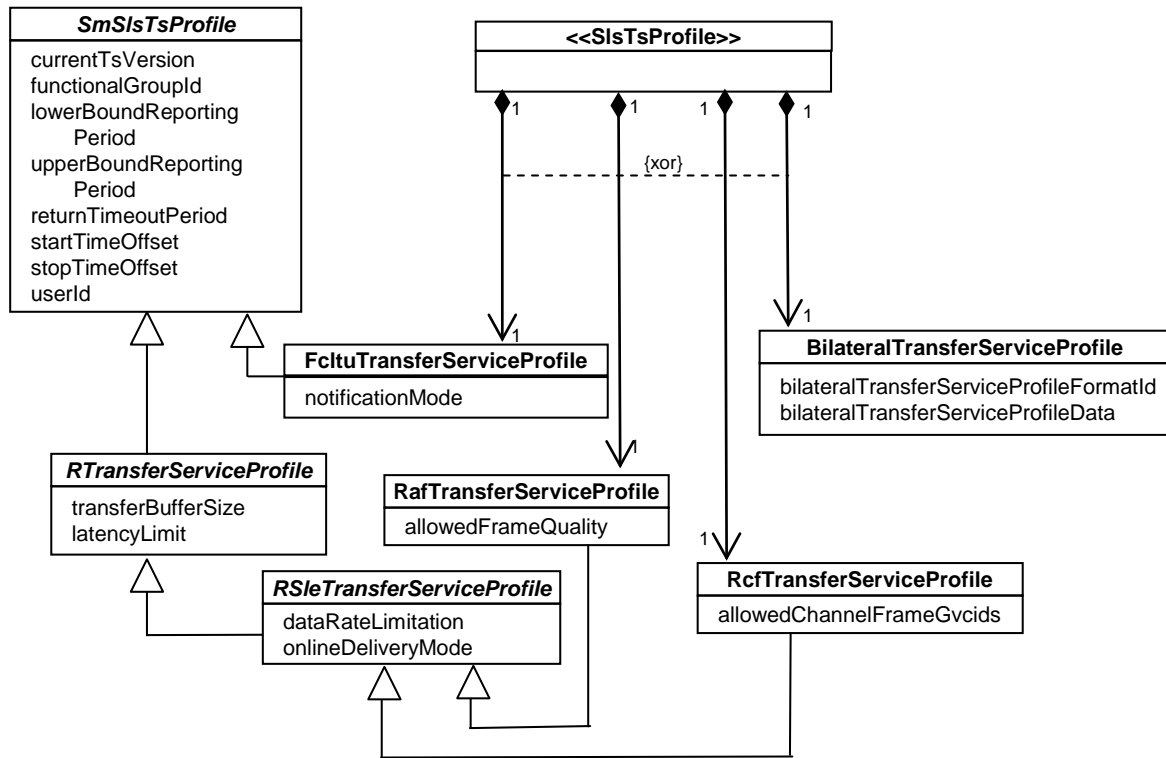

Figure 5-24: <<SlsTsProfile>> Data Set Stereotype Structure Class Diagram

#### 5.9.4.2 Parameters

The constituent data sets of the <<SlsTsProfile>> stereotype are defined in tables 5-80 through 5-83.

**Table 5-80: FcltuTransferServiceProfile Data Set**

Parameter Name	Parameter Definition/Description	Data Type	Units	Applicable Service Agreement Parameter
currentTsVersion	The supported CCSDS transfer service version number, carried in the <code>version-number</code> parameter of the BIND operation for the transfer service (see reference [11] for further definition and use of this parameter).	Positive Integer	n/a	n/a
functionalGroupId	The identifier of the functional group to be inserted as value of the functional group component of the transfer service instance identifier contained within the SLE-SDUs of the service.	String256	n/a	n/a
lowerBoundReportingPeriod	The minimum allowable value for the <code>reporting-cycle</code> parameter of the SCHEDULE-STATUS-REPORT operation for the transfer service instance (see reference [11] for further definition and use of this parameter).	Positive Integer	seconds	minLowerBound-Report-Period
upperBoundReportingPeriod	The maximum allowable value for the <code>reporting-cycle</code> parameter of the SCHEDULE-STATUS-REPORT operation for the transfer service instance (see reference [11] for further definition and use of this parameter).	Positive Integer	seconds	maxUpperBound-Report-Period
notificationMode	Specifies when the user is to be sent a 'production interrupted' notification with respect to the occurrence of a production fault: <ul style="list-style-type: none"> <li>– 'immediate': the provider shall send the 'production interrupted' notification immediately on occurrence of a production fault;</li> <li>– 'deferred': the provider shall wait until a CLTU is ready to be radiated before sending the 'production interrupted' notification.</li> </ul> (See subsection 3.7.2.3 in reference [11] for further definition and use of this parameter.)	Enum	n/a	n/a

Parameter Name	Parameter Definition/Description	Data Type	Units	Applicable Service Agreement Parameter
startTimeOffset	<p>Offset that is to be added to the <code>scheduledCarrierStartTime</code> of the earliest-starting carrier in the Service Package which references an instance of this Transfer Service Profile, for the purpose of establishing the beginning of availability of the Transfer Service instance.</p> <p>NOTE – A negative start time offset means that the service instance starts before the earliest-starting carrier that uses it starts, and a positive start time offset means that the service instance starts after the earliest-starting carrier that uses it starts.</p>	Integer	seconds	maxSi-Start-TimeOffsetLead
stopTimeOffset	<p>Offset that is to be applied to the <code>scheduledCarrierStopTime</code> of the latest-ending carrier which references an instance of this Transfer Service Profile, for the purpose of establishing the end of availability of the Transfer Service instance.</p> <p>NOTE – A negative stop time offset means that the service instance stops before the latest-ending carrier that uses it stops, and a positive stop time offset means that the service instance stop after the latest-ending carrier that uses it stops.</p>	Integer	seconds	maxSi-Stop-TimeOffsetLag
returnTimeoutPeriod	The amount of time the transfer service instance invoker shall wait for a return. If the return to an operation invocation that needs confirmation does not arrive within this period, the invoker shall release the association by invoking the transfer service PEER-ABORT operation (see reference [9] for further definition and use of this parameter).	Positive Integer	seconds	n/a
userId	The <code>UserId</code> value that is assigned to the Transfer Service instance that uses this profile.	String [3..16]	n/a	n/a

**Table 5-81: RafTransferServiceProfile Data Set**

Parameter Name	Parameter Definition/Description	Data Type	Units	Applicable Service Agreement Parameter
permittedFrameQualities	The set of allowed frame qualities that can be selected in the requested-frame-quality parameter of the START invocation. The allowed values are: <ul style="list-style-type: none"> <li>– ‘good-frames-only’;</li> <li>– ‘erred-frames-only’;</li> <li>– ‘all-frames’;</li> <li>– ‘undefined’.</li> </ul>	set of enumerated values	n/a	n/a
currentTsVersion	See table 5-80.			
dataRateLimitation	The maximum data rate at which the transfer service instance may transfer SLE-SDUs to the user. If rate metering is unsupported, or if there is no limit on the rate, the value is NULL.	Positive Integer or NULL	bits/second	maxDataRateLimitation
onlineDeliveryMode	The mode in which the data units are delivered. The values ‘are: <ul style="list-style-type: none"> <li>– ‘timelyOnline’;</li> <li>– ‘completeOnline’.</li> </ul> See reference [8] for further definition of delivery mode.	Enum	n/a	n/a
functionalGroupId	See table 5-80.			
latencyLimit	The maximum delay between reception of an SL-DU (Space Link Data Unit) and the delivery of the associated SLE-SDU (Space Link Extension Service Data Unit) to the user (see reference [8] for further definition and use of latency limit).	Positive Integer	sec	n/a
lowerBoundReportingPeriod	See table 5-80.			
upperBoundReportingPeriod	See table 5-80.			
startTimeOffset	See table 5-80.			
stopTimeOffset	See table 5-80.			
returnTimeoutPeriod	See table 5-80.			
transferBufferSize	The size of the transfer buffer, in maximum-length TRANSFER-DATA invocation messages for the transfer service. The minimum value shall be 200 (per table D-2 of reference [8]). *** Units = Maximum-length transfer service TRANSFER-DATA invocation messages, as defined in [8].	Positive Integer [200..*]	***	n/a
userId	See table 5-80.			

Table 5-82: RcfTransferServiceProfile Data Set

Parameter Name	Parameter Definition/Description	Data Type	Units	Applicable Service Agreement Parameter
permittedGlobalVcidSet	The list of channelIds that may be transferred by this service instance, where $channelId = gVcId   mcId$ . – $gVcId = (vn, scid, vcid)$ triplet, where: <ul style="list-style-type: none"> <li>• <math>vn</math> (transfer frame version number) = Integer [0..1];</li> <li>• <math>scid</math> (spacecraft identifier) = Integer in the range of [0..1023] for <math>vn = 0</math> and in the range of [0..255] for <math>vn = 1</math>;</li> <li>• <math>vcid</math> (virtual channel identifier) = Integer in the range of [0..63] for <math>vn = 0</math> and in the range of [0..255] for <math>vn = 1</math>;</li> </ul> – ‘ $mcId$ ’ = $(vn, scid)$ pair, where $vn$ and $scid$ are as defined above.	list of channelIds	n/a	n/a
currentTsVersion	See table 5-80.			
dataRateLimitation	See table 5-80.			
onlineDeliveryMode	See table 5-80.			
functionalGroupId	See table 5-80.			
latencyLimit	See table 5-80.			
lowerBoundReportingPeriod	See table 5-80.			
lowerBoundReportingPeriod	See table 5-80.			
startTimeOffset	See table 5-80.			
stopTimeOffset	See table 5-80.			
returnTimeoutPeriod	See table 5-80.			
transferBufferSize	See table 5-81.			
userId	See table 5-80.			

**Table 5-83: BilateralTransferServiceProfile Data Set**

Parameter Name	Parameter Definition/Description	Data Type	Units	Applicable Service Agreement Parameter
bilateralTransferService-ProfileData	Contains the Transfer Service Profile data in the format defined by the parameter bilateralTransferServiceProfileFormatId.	Bilateral-Data	n/a	n/a
bilateralTransferService-ProfileFormatId	Identification of Transfer Service Profile format other than the CCSDS standard Transfer Service Profile format. This format must be bilaterally agreed between UM and CM.	String256	n/a	allowed-BilateralTransferService-Profile-FormatIds

### 5.9.4.3 Data Set Composition and Relationship Requirements

Table 5-84 defines the data set composition and relationship requirements for the <<SlsTsProfile>> stereotype data set.

**Table 5-84: Data Set Composition and Relationship Requirements for the <<SlsTsProfile>> Stereotype Data Set**

ASTSPD-01	The SlsTsProfile data set shall contain one and only one of the following: <ul style="list-style-type: none"> <li>a) <b>FcltuTransferServiceProfile</b> data set;</li> <li>b) <b>RafTransferServiceProfile</b> data set;</li> <li>c) <b>RcfTransferServiceProfile</b> data set;</li> <li>d) <b>BilateralTransferServiceProfile</b> data set.</li> </ul> [syntactic validation]
ASTSPD-02	If the <b>BilateralTransferServiceProfile</b> data set is present, the content of the bilateralTransferServiceProfileData parameter shall conform to the data set composition and relationship requirements for the format of the Bilateral Transfer Service Profile indicated by parameter bilateralTransferServiceProfileFormatId. [service management validation]

**5.9.5 AddSlsTransferServiceProfileInvocation MESSAGE (ASTSP-I)  
(UM → CM)**

**5.9.5.1 General**

The **AddSlsTransferServiceProfileInvocation** message conforms to the data set composition and relationship requirements for, and inherits the parameters of, the <<Invocation>> stereotype, as specified in 3.3.5.3.2, and the <<SlsTsProfile>> stereotype, as specified in 5.8.4. Figure 5-25 shows the message structure of the **ASTSP-I** message as a class diagram.

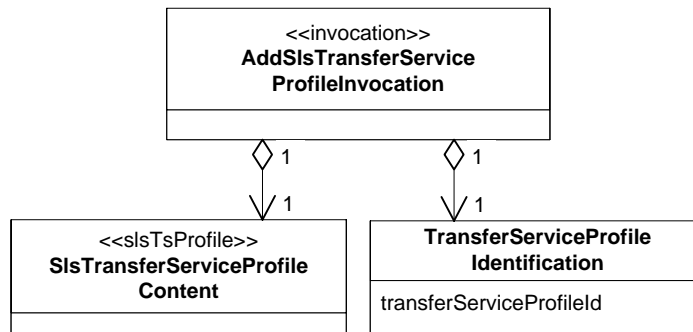

**Figure 5-25: ASTSP-I Message Structure Class Diagram**

**5.9.5.2 Parameters**

The contents of the constituent data set of the **ASTSP-I** message is defined in table 5-85.

**Table 5-85: TransferServiceProfileIdentification Data Set**

Parameter Name	Parameter Definition/Description	Data Type	Units	Applicable Service Agreement Parameter
transferService-ProfileId	Unique identifier of the Transfer Service Profile, relative to the Service Agreement.	String256	n/a	n/a

**5.9.5.3 Data Set Composition and Relationship Requirements**

Table 5-86 defines the data set composition and relationship requirements for the **ASTSP-I** message.



**Table 5-86: Data Set Composition and Relationship Requirements for the ASTSP-I**

ASTSPD-03	The <b>ASTSP-I</b> shall contain: a) one <b>TransferServiceProfileIdentification</b> data set; and b) one <b>SlsTransferServiceProfileContent</b> data set. [syntactic validation]
ASTSPD-04	The <code>transferServiceProfileId</code> parameter shall be unique relative to the Service Agreement. [service management validation].

## 5.9.6 AddSlsTransferServiceProfileAcknowledgedReturn (ASTSP-AR) (CM → UM)

### 5.9.6.1 General

The **AddSlsTransferServiceProfileAcknowledgedReturn** message conforms to the data set composition and relationship requirements for, and inherits the parameters of, the <<AcknowledgedReturn>> stereotype, as specified in 3.3.5.3.3.5. Figure 5-26 is the message structure class diagram for the **ASTSP-AR** message.

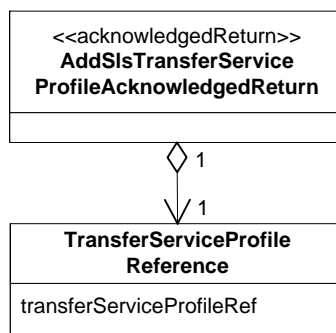
**Figure 5-26: ASTSP-AR Message Structure Class Diagram**

### 5.9.6.2 Parameters

The constituent data set of the **ASTSP-AR** message is defined in table 5-87.

**Table 5-87: TransferServiceProfileReference Data Set**

Parameter Name	Parameter Definition/Description	Data Type	Units	Applicable Service Agreement Parameter
transferService-ProfileRef	Contains the value of the transferServiceProfileId parameter of the <b>ASTSP-I</b> that added the Transfer Service Profile.	String 256	n/a	n/a

**5.9.6.3 Data Set Composition and Relationship Requirements**

Table 5-88 defines the data set composition and relationship requirements for the **ASTSP-AR** message.

**Table 5-88: Data Set Composition and Relationship Requirements for the ASTSP-AR**

ASTSPD-05	The <b>ASTSP-AR</b> shall contain one <b>TransferServiceProfileReference</b> data set. [syntactic validation]
ASTSPD-06	The transferServiceProfileRef parameter value of the <b>ASTSP-AR</b> shall be equal to the transferServiceProfileId parameter of the <b>ASTSP-I</b> that attempted to invoke the operation. [service management validation]

**5.9.7 AddSIsTransferServiceProfileSuccessfulReturn (ASTSP-SR) (CM → UM)**

**5.9.7.1 General**

The **AddSIsTransferServiceProfileSuccessfulReturn** message conforms to the data set composition and relationship requirements for, and inherits the parameters of the <<SuccessfulReturn>> stereotype, as specified in 3.3.5.3.3.2. Figure 5-27 is the message structure class diagram for the **ASTSP-SR** message.

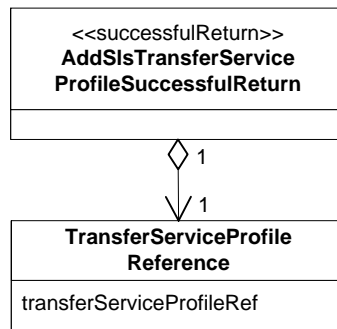

**Figure 5-27: ASTSP-SR Message Structure Class Diagram**

5.9.7.2 Parameters

The contents of the **TransferServiceProfileReference** data set are defined in table 5-87.

5.9.7.3 Data Set Composition and Relationship Requirements

Table 5-89 defines the data set composition and relationship requirements for the **ASTSP-SR** message.

**Table 5-89: Data Set Composition and Relationship Requirements for the ASTSP-SR**

ASTSPD-07	The <b>ASTSP-SR</b> shall contain one <b>TransferServiceProfileReference</b> data set. [syntactic validation]
ASTSPD-08	The <b>transferServiceProfileRef</b> parameter value of the <b>ASTSP-SR</b> shall be equal to the <b>transferServiceProfileId</b> parameter of the <b>ASTSP-I</b> that invoked the operation. [service management validation]

5.9.8 AddSlsTransferServiceProfileFailedReturn (ASTSP-FR) MESSAGE (CM → UM)

5.9.8.1 General

The **AddSlsTransferServiceProfileFailedReturn** message conforms to the data set composition and relationship requirements for, and inherits the parameters of, the <<FailedReturn>> stereotype, as specified in table 3-10. Figure 5-28 is the message structure class diagram for the **ASTSP-FR** message.

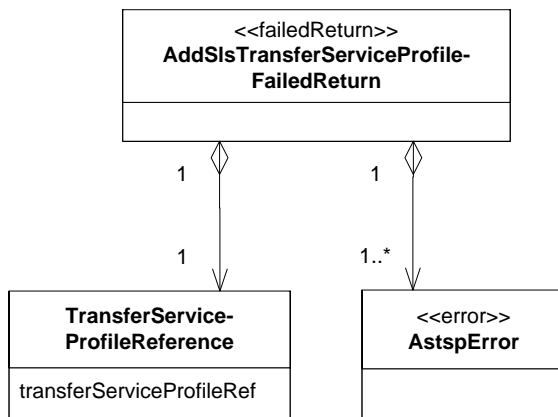

**Figure 5-28: ASTSP-FR Message Structure Class Diagram**

### 5.9.8.2 Parameters

The contents of the **TransferServiceProfileReference** data set are defined in table 5-87.

The **AstspError** dataset of the **AddSlsTransferServiceProfileFailed-Return** message conforms to the data set composition and relationship requirements for, and inherits the parameters of, the <<Error>> data set stereotype, which contains a diagnostic parameter of the <<ErrorDiagnostic>> stereotype. Table 5-90 defines the additional values of the diagnostic parameter for the **AstspError** data set, identifies the CM and data set composition service management requirements that result in that diagnostic value being returned, and identifies the contents of the **erroredItem** and **additionalInformation** parameters that accompany each diagnostic value.

**Table 5-90: AstspError Data Set diagnostic Parameter Definition**

diagnostic value	Definition/Description	Rqmt	Parameter or Data Set Identified by erroredItem	Content of additional Information
'Transfer Service Profile ID already in use'	There is a Transfer Service Profile with this identifier already registered at CM for the referenced Service Agreement.	ASTSPD-04	transfer-Service-ProfileId	n/a
'mutually incompatible parameter values'	Two or more parameters of the <b>ASTSP-I</b> contain mutually incompatible values.	ASTSPC-05	One of the mutually incompatible parameters (see GRD-0026, table 3-12)	n/a
'non-conformant to data set composition and relationship requirements of indicated bilateral format'	The contents of the parameter <b>bilateralTransfer-ServiceProfileData</b> in the <b>BilateralTransfer-ServiceProfile</b> data set do not meet the relevant data set composition and relationship requirements.	ASTSPD-02	n/a	n/a
'operation timeout'	See table 3-11.	2PC-0103		
'parameter value not supported by referenced Service Agreement'	The value of the parameter is not within the values permitted by the corresponding Service Agreement parameter.	ASTSPC-04	The parameter of the <b>ASTSP-I</b> that is in violation	n/a
'other'	The operation has occurred due to an error that is local to the Service Agreement.	ASTSPC-06	The invalid parameter or data set that causes the violation	Text-string description of the local error

### 5.9.8.3 Data Set Composition and Relationship Requirements

Table 5-91 defines the data set composition and relationship requirements for the **ASTSP-FR** message that are in addition to those of the <<FailedReturnWithDenial>> stereotype.

**Table 5-91: Data Set Composition and Relationship Requirements for the ASTSP-FR**

ASTSPD-09	The <code>transferServiceProfileRef</code> parameter value of the <b>ASTSP-FR</b> shall be equal to the <code>transferServiceProfileId</code> parameter of the <b>ASTSP-I</b> that attempted to invoke the operation. [service management validation]
ASTSPD-10	The <b>ASTSP-FR</b> shall contain one <b>TransferServiceProfileReference</b> data set. [syntactic validation]
ASTSPD-11	The <b>ASTSP-FR</b> shall contain one or more <b>AstspError</b> data sets. [syntactic validation]

## 5.10 ADD\_RETRIEVAL\_TRANSFER\_SERVICE\_PROFILE (ARTSP) OPERATION

### 5.10.1 PURPOSE

The `ADD_RETRIEVAL_TRANSFER_SERVICE_PROFILE` (ARTSP) operation is used by UM to add a new Retrieval Transfer Service Profile to the set of Transfer Service Profiles already available at CM for a given Service Agreement.

### 5.10.2 PROCEDURE

**5.10.2.1** The ARTSP operation is defined to be a three-phase operation in accordance with the operation procedure pattern specified in 3.4.2.

**5.10.2.2** The ARTSP operation is defined in terms of the following messages:

- **AddRetrievalTransferServiceProfileInvocation** (ARTSP-I);
- **AddRetrievalTransferServiceProfileAcknowledgedReturn** (ARTSP-AR);
- **AddRetrievalTransferServiceProfileSuccessfulReturn** (ARTSP-SR);
- **AddRetrievalTransferServiceProfileFailedReturn** (ARTSP-FR).

**5.10.2.3** The message sequence diagram for the `ADD_RETRIEVAL_TRANSFER_SERVICE_PROFILE` operation is defined by applying the following argument list to the stereotyped sequence diagram for the three-phase operation procedure pattern specified in 3.4.2.2:

```
threePhaseOperationProcedurePatternSequence {UM, CM, ARTSP-I,
                                             ARTSP-AR, ARTSP-SR,
                                             ARTSP-FR}
```

**5.10.2.4** The activity diagram for the `ADD_RETRIEVAL_TRANSFER_SERVICE_PROFILE` operation is defined by applying the following argument list to the stereotyped activity diagram for the three-phase operation procedure pattern specified in 3.4.2.4:

```
threePhaseOperationProcedurePatternActivity {UM, CM, ARTSP-I,
                                              ARTSP-AR, ARTSP-SR,
                                              ARTSP-FR
                                              artspRoutineTimeout,
                                              artspUrgentTimeout}
```

### 5.10.3 REQUIREMENTS

#### 5.10.3.1 UM Requirements for the `ADD_RETRIEVAL_TRANSFER_SERVICE_PROFILE` Operation

The UM requirements for the **ARTSP** operation are defined in table 5-92.

**Table 5-92: UM Requirements for the ARTSP Operation**

ARTSPU-01	UM shall conform to all <b>ARTSP-I</b> Data Set Composition and Relationship Requirements when creating and transmitting an <b>ARTSP-I</b> as specified in table 5-98.
ARTSPU-02	UM shall conform to all Invoker Requirements for Three-Phase Operation Procedures as specified in 3.4.2.5.1.
ARTSPU-03	UM should send <b>ARTLSP-I</b> messages that are valid with respect to all service management validation requirements for CM as defined in table 5-98.
ARTSPU-04	UM shall validate that a received <b>ARTSP-AR</b> , <b>ARTSP-SR</b> , or <b>ARTSP-FR</b> conforms to all <b>ARTSP-AR</b> , <b>ARTSP-SR</b> , or <b>ARTSP-FR</b> syntactic validation requirements specified in table 5-99, table 5-100, or table 5-102, respectively. If the return fails any of the syntactic validation requirements, UM shall process the message set containing the syntactically invalid return in accordance with the Invoker Requirements for Three-Phase Operation Procedures.
ARTSPU-05	UM shall validate that a received <b>ARTSP-AR</b> , <b>ARTSP-SR</b> , or <b>ARTSP-FR</b> conforms to all <b>ARTSP-AR</b> , <b>ARTSP-SR</b> , or <b>ARTSP-FR</b> service management validation requirements specified in table 5-99, table 5-100, or table 5-102, respectively. If the return fails any of the service management validation requirements, UM shall process the service management-invalid return in accordance with the Invoker Requirements for Three-Phase Operation Procedures.

### 5.10.3.2 CM Requirements for the **ADD\_RETRIEVAL\_TRANSFER\_SERVICE\_-PROFILE** Operation

The CM requirements for the **ARTSP** operation are defined in table 5-93.

**Table 5-93: CM Requirements for the ARTSP Operation**

ARTSPC-01	CM shall conform to all Performer Requirements for Three-Phase Operation Procedures as specified in 3.4.2.5.2.
ARTSPC-02	CM shall validate that a received <b>ARTSP-I</b> conforms to all <b>ARTSP-I</b> syntactic validation requirements specified in table 5-98, Data Set Composition and Relationship Requirements for the <b>ARTSP-I</b> . If the <b>ARTSP-I</b> fails any of the syntactic requirements, CM shall process the message set containing the syntactically invalid invocation in accordance with the Performer Requirements for Three-Phase Operation Procedures.
ARTSPC-03	CM shall validate that the <b>ARTSP-I</b> conforms to all <b>ARTSP-I</b> service management validation requirements specified in this table and table 5-98 Data Set Composition and Relationship Requirements. If the <b>ARTSP-I</b> fails any of the service management requirements, CM shall cease processing the <b>ARTSP-I</b> and respond to UM with an <b>ARTSP-FR</b> message. The content of the <b>ARTSP-FR</b> depends on the nature of the validation failure, and is specified in table 5-101.
ARTSPC-04	CM shall validate that each <b>ARTSP-I</b> parameter that is constrained by a Service Agreement parameter is consistent with the applicable Service Agreement parameter. [service management validation]
ARTSPC-05	CM shall validate that all <b>ARTSP-I</b> parameter values that are related to each other (as defined in the Data Set Composition and Relationship Requirements) contain mutually compatible values. [service management validation]
ARTSPC-06	If the Complex has locally defined <b>ARTSP-I</b> relationship requirements in addition to those specified in this Recommended Standard, CM shall validate that the <b>ARTSP-I</b> conforms to all such local requirements. [service management validation]
ARTSPC-07	If the <b>ARTSP-I</b> passes all syntactic and service management validation, CM shall: <ul style="list-style-type: none"> <li>a) add the Retrieval Transfer Service Profile to the set of Retrieval Transfer Service Profiles already available at CM;</li> <li>b) count the Retrieval Transfer Service Profile as applying against the <code>maxTransferServiceProfiles</code> parameter of the Service Agreement;</li> <li>c) send an <b>ARTSP-SR</b> message to CM.</li> </ul> [perform operation]
ARTSPC-08	CM shall conform to all <b>ARTSP-SR</b> Data Set Composition and Relationship Requirements when creating and transmitting an <b>ARTSP-SR</b> as specified in table 5-100.
ARTSPC-09	CM shall conform to all <b>ARTSP-FR</b> Data Set Composition and Relationship Requirements when creating and transmitting an <b>ARTSP-FR</b> as specified in table 5-102.
ARTSPC-10	CM shall conform to all <b>ARTSP-AR</b> Data Set Composition and Relationship Requirements when creating and transmitting an <b>ARTSP-AR</b> as specified in table 5-99.

5.10.4 <<RetrievalTsProfile>> DATA SET STEREOTYPE

5.10.4.1 General

The <<RetrievalTsProfile>> data set stereotype captures the parameters and data set relationships that are common among messages that create Retrieval Transfer Service Profiles or report their contents. Figure 5-29 shows the message structure of the <<RetrievalTsProfile>> data set stereotype as a class diagram.

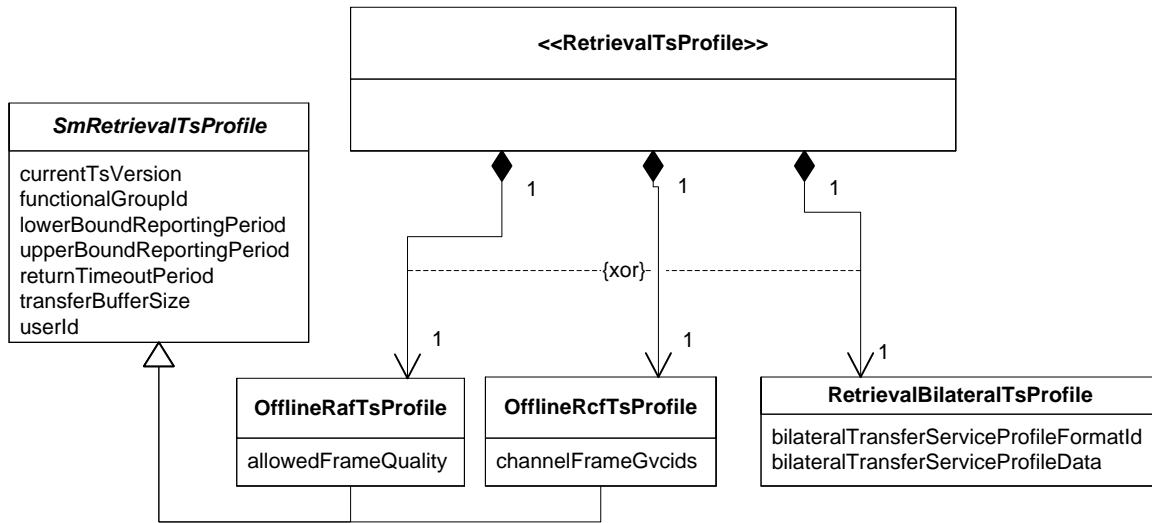

Figure 5-29: <<RetrievalTsProfile>> Data Set Stereotype Structure Class Diagram



### 5.10.4.2 Parameters

The constituent data sets of the <<RetrievalTsProfile>> stereotype are defined in table 5-94 through table 5-96.

**Table 5-94: OfflineRaftTsProfile Data Set**

Parameter Name	Parameter Definition/Description	Data Type	Units	Applicable Service Agreement Parameter
permittedFrameQualities	See table 5-81.			
currentTsVersion	See table 5-80.			
functionalGroupId	The identifier of set of data associated with a particular data flow (e.g., the data from a particular symbol stream). It is also inserted as value of the functional group component of the transfer service instance identifier (table 5-23) contained within the SLE-SDUs of the service.	String256	n/a	n/a
lowerBoundReportingPeriod	See table 5-80.			
upperBoundReportingPeriod	See table 5-80.			
returnTimeoutPeriod	See table 5-80.			
transferBufferSize	See table 5-81.			
userId	See table 5-80.			

**Table 5-95: OfflineRcfTsProfile Data Set**

Parameter Name	Parameter Definition/Description	Data Type	Units	Applicable Service Agreement Parameter
permittedGlobalVcidSet	See table 5-82.			
currentTsVersion	See table 5-80.			
functionalGroupId	See table 5-23.			
lowerBoundReportingPeriod	See table 5-80.			
upperBoundReportingPeriod	See table 5-80.			
returnTimeoutPeriod	See table 5-80.			
transferBufferSize	See table 5-81.			
userId	See table 5-80.			

**Table 5-96: RetrievalBilateralTsProfile Data Set**

Parameter Name	Parameter Definition/Description	Data Type	Units	Applicable Service Agreement Parameter
bilateralTransferService-ProfileData	See table 5-83.			
bilateralTransferService-ProfileFormatId	See table 5-83.			

**5.10.4.3 Data Set Composition and Relationship Requirements**

Table 5-97 defines the data set composition and relationship requirements for the <<RetrievalTsProfile>> stereotype data set.

**Table 5-97: Data Set Composition and Relationship Requirements for the <<RetrievalTsProfile>> Stereotype Data Set**

ARTSPD-01	The RetrievalTsProfile data set shall contain one and only one of the following: a) <b>OfflineRafTransferServiceProfile</b> data set; b) <b>OfflineRcfTransferServiceProfile</b> data set; c) <b>RetrievalBilateralTransferServiceProfile</b> data set. [syntactic validation]
ARTSPD-02	If the <b>RetrievalBilateralTsProfile</b> data set is present, the content of the <b>bilateralTransferServiceProfileData</b> parameter shall conform to the data set composition and relationship requirements for the format of the Retrieval Bilateral Transfer Service Profile indicated by parameter <b>bilateralTransferServiceProfileFormatId</b> . [service management validation]

**5.10.5 AddRetrievalTransferServiceProfileInvocation MESSAGE  
(ARTSP-I)(UM → CM)**

**5.10.5.1 General**

The **AddRetrievalTransferServiceProfileInvocation** message conforms to the data set composition and relationship requirements for, and inherits the parameters of, the <<Invocation>> stereotype, as specified in 3.3.5.3.2, and the <<RetrievalTsProfile>> stereotype, as specified in 5.9.4. Figure 5-30 shows the message structure of the **ARTSP-I** message as a class diagram.

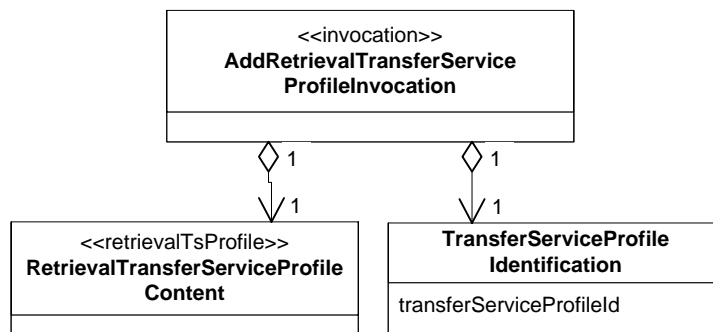

Figure 5-30: ARTSP-I Message Structure Class Diagram

5.10.5.2 Parameters

The **TransferServiceProfileIdentification** constituent data set of the **ARTSP-I** message is defined in table 5-85.

5.10.5.3 Data Set Composition and Relationship Requirements

Table 5-98 defines the data set composition and relationship requirements for the **ARTSP-I** message.

Table 5-98: Data Set Composition and Relationship Requirements for the ARTSP-I

ARTSPD-03	The <b>ARTSP-I</b> shall contain: a) one <b>TransferServiceProfileIdentification</b> data set; and b) one <b>RetrievalTransferServiceProfileContent</b> data set. [syntactic validation]
ARTSPD-04	The <code>transferServiceProfileId</code> parameter shall be unique relative to the Service Agreement. [service management validation].

5.10.6 AddRetrievalTransferServiceProfileAcknowledgedReturn (ARTSP-AR) (CM → UM)

5.10.6.1 General

The **AddRetrievalTransferServiceProfileAcknowledgedReturn** message conforms to the data set composition and relationship requirements for, and inherits the parameters of, the <<AcknowledgedReturn>> stereotype, as specified in 3.3.5.3.3.5. Figure 5-31 is the message structure class diagram for the **ARTSP-AR** message.

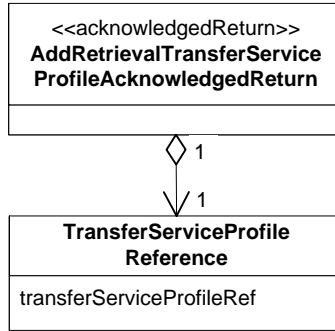

Figure 5-31: ARTSP-AR Message Structure Class Diagram

5.10.6.2 Parameters

The contents of the **TransferServiceProfileReference** data set are defined in table 5-85.

5.10.6.3 Data Set Composition and Relationship Requirements

Table 5-99 defines the data set composition and relationship requirements for the **ARTSP-AR** message.

Table 5-99: Data Set Composition and Relationship Requirements for the ARTSP-AR

ARTSPD-05	The <b>ARTSP-AR</b> shall contain one <b>TransferServiceProfileReference</b> data set. [syntactic validation]
ARTSPD-06	The <b>transferServiceProfileRef</b> parameter value of the <b>ARTSP-AR</b> shall be equal to the <b>transferServiceProfileId</b> parameter of the <b>ARTSP-I</b> that attempted to invoke the operation. [service management validation]

5.10.7 AddRetrievalTransferServiceProfileSuccessfulReturn (ARTSP-SR) (CM → UM)

5.10.7.1 General

The **AddRetrievalTransferServiceProfileSuccessfulReturn** message conforms to the data set composition and relationship requirements for, and inherits the parameters of, the <<SuccessfulReturn>> stereotype, as specified in 3.3.5.3.3.2. Figure 5-32 is the message structure class diagram for the **ARTSP-SR** message.

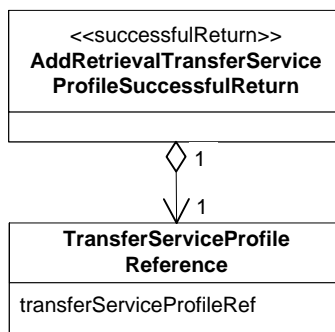

Figure 5-32: ARTSP-SR Message Structure Class Diagram

### 5.10.7.2 Parameters

The **TransferServiceProfileReference** constituent data set of the **ARTSP-SR** message is defined in table 5-85.

### 5.10.7.3 Data Set Composition and Relationship Requirements

Table 5-100 defines the data set composition and relationship requirements for the **ARTSP-SR** message.

Table 5-100: Data Set Composition and Relationship Requirements for the ARTSP-SR

ARTSPD-07	The <b>ARTSP-SR</b> shall contain one <b>TransferServiceProfileReference</b> data set. [syntactic validation]
ARTSPD-08	The <b>transferServiceProfileRef</b> parameter value of the <b>ARTSP-SR</b> shall be equal to the <b>transferServiceProfileId</b> parameter of the <b>ARTSP-I</b> that invoked the operation. [service management validation]

## 5.10.8 AddRetrievalTransferServiceProfileFailedReturn (ARTSP-FR) MESSAGE (CM → UM)

### 5.10.8.1 General

The **AddRetrievalTransferServiceProfileFailedReturn** message conforms to the data set composition and relationship requirements for, and inherits the parameters of, the <<FailedReturn>> stereotype, as specified in table 3-10. Figure 5-33 is the message structure class diagram for the **ARTSP-FR** message.

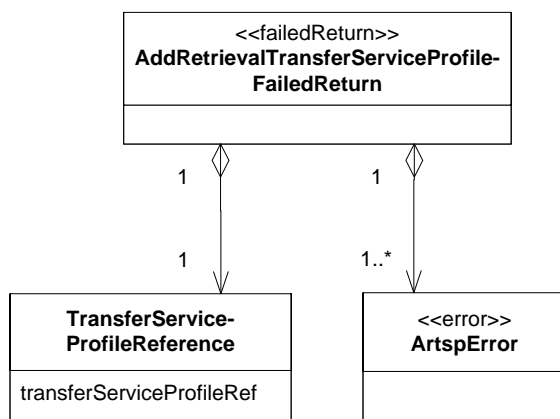

**Figure 5-33: ARTSP-FR Message Structure Class Diagram**

### 5.10.8.2 Parameters

The contents of the **TransferServiceProfileReference** constituent data set are defined in table 5-85.

The **ArtspError** dataset of the **AddRetrievalTransferServiceProfile-FailedReturn** message conforms to the data set composition and relationship requirements for, and inherits the parameters of, the <<Error>> data set stereotype, which contains a diagnostic parameter of the <<ErrorDiagnostic>> stereotype. Table 5-101 defines the additional values of the diagnostic parameter for the **ArtspError** data set, identifies the CM and data set composition service management requirements that result in that diagnostic value being returned, and identifies the contents of the erroredItem and additionalInformation parameters that accompany each diagnostic value.

**Table 5-101: ArtspError Data Set diagnostic Parameter Definition**

diagnostic value	Definition/Description	Rqmt	Parameter or Data Set Identified by erroredItem	Content of additional Information
'Transfer Service Profile ID already in use'	There is a Transfer Service Profile with this identifier already registered at CM for the referenced Service Agreement.	ARTSPD-04	transfer-Service-ProfileId	n/a
'mutually incompatible parameter values'	Two or more parameters of the <b>ARTSP-I</b> contain mutually incompatible values.	ARTSPC-05	One of the mutually incompatible parameters  See GRD-0026, table 3-12.	n/a
'non-conformant to data set composition and relationship requirements of indicated bilateral format'	The contents of the parameter bilateralTransfer-ServiceProfileData in the <b>RetrievalBilateralTs-Profile</b> data set do not meet the relevant data set composition and relationship requirements.	ARTSPD-02	n/a	n/a
'operation timeout'	See table 3-11.	3PP-0104b		
'parameter value not supported by referenced Service Agreement'	The value of the parameter is not within the values permitted by the corresponding Service Agreement parameter.	ARTSPC-04	The parameter of the <b>ARTSP-I</b> that is in violation	n/a
'other'	The operation has failed due to an error that is local to the Service Agreement.	ARTSPC-06	The invalid parameter or data set that causes the violation	Text-string description of the local error

### 5.10.8.3 Data Set Composition and Relationship Requirements

Table 5-102 defines the data set composition and relationship requirements for the **ARTSP-FR** message that are in addition to those of the <<FailedReturn>> stereotype.

**Table 5-102: Data Set Composition and Relationship Requirements for the ARTSP-FR**

ARTSPD-09	The transferServiceProfileRef parameter value of the <b>ARTSP-FR</b> shall be equal to the transferServiceProfileId parameter of the <b>ARTSP-I</b> that attempted to invoke the operation. [service management validation]
ARTSPD-10	The <b>ARTSP-FR</b> shall contain one <b>TransferServiceProfileReference</b> data set. [syntactic validation]
ARTSPD-11	The <b>ARTSP-FR</b> shall contain one or more <b>ArtspError</b> data sets. [syntactic validation]

## 5.11 DELETE\_TRANSFER\_SERVICE\_PROFILE (DTSP) OPERATION

### 5.11.1 PURPOSE

The DELETE\_TRANSFER\_SERVICE\_PROFILE (DTSP) operation is used by U M to instruct CM to remove a previously installed Transfer Service Profile from the set of Transfer Service Profiles available at CM for a given Service Agreement.

### 5.11.2 PROCEDURE

**5.11.2.1** The DTSP operation is defined to be a two-phase operation in accordance with the operation procedure pattern specified in 3.4.1.

**5.11.2.2** The DTSP operation is defined in terms of the following messages:

- DeleteTransferServiceProfileInvocation (DTSP-I);
- DeleteTransferServiceProfileSuccessfulReturn (DTSP-SR); and
- DeleteTransferServiceProfileFailedReturn (DTSP-FR).

**5.11.2.3** The message sequence diagram for the DELETE\_TRANSFER\_SERVICE\_PROFILE operation is defined by applying the following argument list to the stereotyped sequence diagram for the two-phase operation procedure pattern specified in 3.4.1.2:

```
twoPhaseOperationProcedurePatternSequence {UM, CM, DTSP-I, DTSP-
SR, DTSP-FR}
```

**5.11.2.4** The activity diagram for the DELETE\_TRANSFER\_SERVICE\_PROFILE operation is defined by applying the following argument list to the stereotyped activity diagram for the two-phase operation procedure pattern specified in 3.4.1.4:

```
twoPhaseOperationProcedurePatternActivity {UM, CM, DTSP-I, DTSP-
SR, DTSP-FR,
dtspRoutineTimeout,
dtspUrgentTimeout}
```



### 5.11.3 REQUIREMENTS

#### 5.11.3.1 UM Requirements for the DELETE\_TRANSFER\_SERVICE\_PROFILE Operation

The UM requirements for the DTSP operation are defined in table 5-103.

**Table 5-103: UM Requirements for the DTSP Operation**

DTSPU-01	UM shall conform to all Invoker Requirements for Two-Phase Operation Procedures as specified in 3.4.1.5.1.
DTSPU-02	UM shall conform to all DTSP-I Data Set Composition and Relationship Requirements when creating and transmitting an DTSP-I as specified in table 5-105.
DTSPU-03	UM should send DTSP-I messages that are valid with respect to all service management validation requirements for CM as defined in table 5-105.
DTSPU-04	UM shall validate that a received DTSP-SR or DTSP-FR conforms to all DTSP-SR or DTSP-FR syntactic validation requirements specified in table 5-106 or table 5-107, respectively. If the return fails any of the syntactic validation requirements, UM shall process the message set containing the syntactically invalid return in accordance with the Invoker Requirements for Two-Phase Operation Procedures.
DTSPU-05	UM shall validate that a received DTSP-SR or DTSP-FR conforms to all DTSP-SR or DTSP-FR service management validation requirements specified in table 5-106 or table 5-108, respectively. If the return fails any of the service management validation requirements, UM shall process the service management-invalid return in accordance with the Invoker Requirements for Two-Phase Operation Procedures.

### 5.11.3.2 CM Requirements for the DELETE\_TRANSFER\_SERVICE\_PROFILE Operation

The CM requirements for the **DTSP** operation are defined in table 5-104.

**Table 5-104: CM Requirements for the DTSP Operation**

DTSPC-01	CM shall conform to all Performer Requirements for Two-Phase Operation Procedures as specified in 3.4.1.5.2.
DTSPC-02	CM shall validate that a received <b>DTSP-I</b> conforms to all <b>DTSP-I</b> syntactic validation requirements specified in table 5-105, Data Set Composition and Relationship Requirements for the <b>DTSP-I</b> . If the <b>DTSP-I</b> fails any of the syntactic requirements, CM shall process the message set containing the syntactically invalid return in accordance with the Performer Requirements for Two-Phase Operation Procedures.
DTSPC-03	CM shall validate that the <b>DTSP-I</b> conforms to all <b>DTSP-I</b> service management validation requirements specified in this table and table 5-105, Data Set Composition and Relationship Requirements. If the <b>DTSP-I</b> fails any of the service management requirements, CM shall cease processing the <b>DTSP-I</b> and respond to UM with an <b>DTSP-FR</b> message. The content of the <b>DTSP-FR</b> depends on the nature of the validation failure, and is specified in table 5-107.
DTSPC-04	CM shall validate that the <code>transferServiceProfileRef</code> matches the <code>transferServiceProfileId</code> for a Transfer Service Profile within the context of the referenced Service Agreement. [service management validation]
DTSPC-05	If the <code>transferServiceProfileRef</code> references an SLS Transfer Service Profile, CM shall validate that there are no available Space Communication Service Profiles bound to the SLS Transfer Service Profile to be deleted. [service management validation]
DTSPC-06	If the <code>transferServiceProfileRef</code> references a Retrieval Transfer Service Profile, CM shall validate that there are no scheduled Service Packages bound to the Retrieval Transfer Service Profile to be deleted. [service management validation]
DTSPC-07	If <code>enforceOwnership</code> is 'true' in the Service Agreement, CM shall validate that the <code>smSource</code> associated with the <b>DTSP-I</b> is the name of the owner of the Transfer Service Profile associated with the <code>transferServiceProfileId</code> referenced by the <code>transferServiceProfileRef</code> in the <b>DTSP-I</b> . [service management validation]
DTSPC-08	If the Complex has locally defined <b>DTSP-I</b> relationship requirements in addition to those specified in this Recommended Standard, CM shall validate that the <b>DTSP-I</b> conforms to all such local requirements. [service management validation]
DTSPC-09	If the <b>DTSP-I</b> is valid, CM shall: <ul style="list-style-type: none"> <li>a) delete the referenced Transfer Service Profile;</li> <li>b) remove the Transfer Service Profile as counting against the <code>maxTransferServiceProfiles</code> parameter of the Service Agreement; and</li> <li>c) return a <b>DTSP-SR</b>.</li> </ul> [perform operation]
DTSPC-10	CM shall conform to all <b>DTSP-SR</b> Data Set Composition and Relationship Requirements when creating and transmitting an <b>DTSP-SR</b> as specified in table 5-106.
DTSPC-11	CM shall conform to all <b>DTSP-FR</b> Data Set Composition and Relationship Requirements when creating and transmitting an <b>DTSP-FR</b> as specified in table 5-108.

**5.11.4 DeleteTransferServiceProfileInvocation (DTSP-I) MESSAGE (UM → CM)**

**5.11.4.1 General**

The **DeleteTransferServiceProfileInvocation** message conforms to the data set composition and relationship requirements for, and inherits the parameters of, the <<Invocation>> stereotype, as specified in 3.3.5.3.2. Figure 5-34 is the message structure class diagram for the **DTSP-I** message.

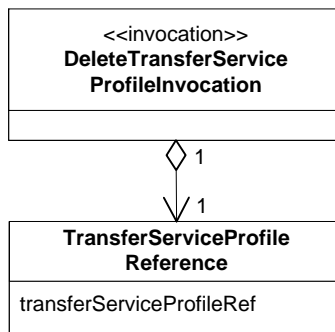

**Figure 5-34: DTSP-I Message Structure Class Diagram**

**5.11.4.2 Parameters**

The contents of the **TransferServiceProfileReference** data set are defined in table 5-85.

**5.11.4.3 Data Set Composition and Relationship Requirements**

Table 5-105 defines the data set composition and relationship requirements for the **DTSP-I** message.

**Table 5-105: Data Set Composition and Relationship Requirements for the DTSP-I**

DTSPD-01	The <b>DTSP-I</b> shall contain one <b>TransferServiceProfileReference</b> data set. [syntactic validation]
----------	--

**5.11.5 DeleteTransferServiceProfileSuccessfulReturn (DTSP-SR) MESSAGE (CM → UM)**

**5.11.5.1 General**

The **DeleteTransferServiceProfileSuccessfulReturn** message conforms to the data set composition and relationship requirements for, and inherits the parameters of, the <<SuccessfulReturn>> stereotype, as specified in 3.3.5.3.3.2. Figure 5-35 is the message structure class diagram for the **DTSP-SR** message.

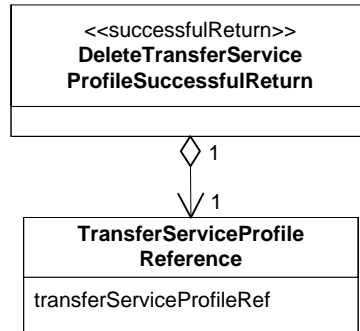

**Figure 5-35: DTSP-SR Message Structure Class Diagram**

**5.11.5.2 Parameters**

The contents of the **TransferServiceProfileReference** data set are defined in table 5-85.

**5.11.5.3 Data Set Composition and Relationship Requirements**

Table 5-106 defines the data set composition and relationship requirements for the **DTSP-SR** message.

**Table 5-106: Data Set Composition and Relationship Requirements for the DTSP-SR**

DTSPD-02	The <b>DTSP-SR</b> shall contain one <b>TransferServiceProfileReference</b> data set. [syntactic validation]
DTSPD-03	The <code>transferServiceProfileRef</code> parameter value of the <b>DTSP-SR</b> shall be equal to the <code>transferServiceProfileRef</code> parameter of the <b>DTSP-I</b> that invoked the operation. [service management validation]

### 5.11.6 DeleteTransferServiceProfileFailedReturn (DTSP-FR) MESSAGE (CM → UM)

#### 5.11.6.1 General

The **DeleteTransferServiceProfileFailedReturn** message conforms to the data set composition and relationship requirements for, and inherits the parameters of, the <<FailedReturn>> stereotype, as specified in table 3-10. Figure 5-36 is the message structure class diagram for the **DTSP-FR** message.

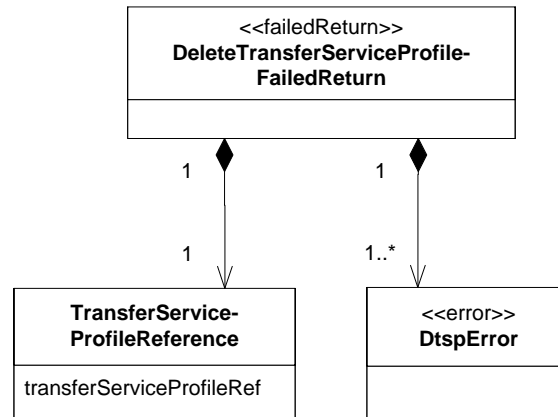

Figure 5-36: DTSP-FR Message Structure Class Diagram

#### 5.11.6.2 Parameters

The contents of the **TransferServiceProfileReference** data set are defined in table 5-85.

The **DtspError** dataset of the **DeleteTransferServiceProfileFailedReturn** message conforms to and inherits the parameters of the <<Error>> data set stereotype, which contains a diagnostic parameter of the <<ErrorDiagnostic>> stereotype. Table 5-107 defines the additional values of the diagnostic parameter for the **DtspError** data set, identifies the CM and data set composition service management requirements that result in that diagnostic value being returned, and identifies the contents of the erroredItem and additionalInformation parameters that accompany each diagnostic value.

**Table 5-107: DtspError Data Set diagnostic Parameter Definition**

diagnostic value	Definition/Description	Rqmt	Parameter or Data Set Identified by erroredItem	Content of additional Information
'operation timeout'	See table 3-11.	2PC-0103		
'referenced Retrieval Transfer Service Profile bound to scheduled Service Package'	The referenced Retrieval Transfer Service Profile cannot be deleted because it is bound to a scheduled Service Package.	DTSPC-06	transfer-Service-ProfileRef	Value of the servicePackageRef of a Service Package that is bound to the Retrieval Transfer Service Profile
'referenced SLS Transfer Service Profile bound to available Space Communication Service Profile'	The referenced SLS Transfer Service Profile cannot be deleted because it is bound to an available Space Communication Service Profile.	DTSPC-05	transfer-Service-ProfileRef	Value of the spaceCommunicationService-ProfileRef of a Space Communication Service Profile that is bound to the SLS Transfer Service Profile
'referenced transferService-ProfileId unknown'	The referenced transferService-ProfileId is not registered at CM within the context of the Service Agreement.	DTSPC-04	transfer-Service-ProfileRef	n/a
'smSource not the owner'	The value of the smSource for the SmMessageSet containing the DTSP-I is not the owner of the target Transfer Service Profile.	DTSPC-07	smSource	n/a
'other'	The operation has failed due to an error that is local to the Service Agreement.	DTSPC-08	The invalid parameter or data set that causes the violation	Text-string description of the local error

### 5.11.6.3 Data Set Composition and Relationship Requirements

Table 5-108 defines the data set composition and relationship requirements for the **DTSP-FR** message that are in addition to those of the <<FailedReturn>> stereotype.

**Table 5-108: Data Set Composition and Relationship Requirements for the DTSP-FR**

DTSPD-04	The <b>DTSP-FR</b> shall contain: a) one <b>TransferServiceProfileReference</b> data set; and b) one or more <b>DtspError</b> data sets. [syntactic validation]
DTSPD-05	If the cause of the failure is ‘referenced SLS Transfer Service Profile is bound to an available Space Communication Service Profile’, the <b>DTSP-FR</b> shall contain one <b>DtspError</b> data set for each SLS Transfer Service Profile that is bound to the Space Communication Service Profile at the time that service management validation is attempted.
DTSPD-06	If the cause of the failure is ‘referenced Retrieval Transfer Service Profile is bound to a scheduled Service Package’, the <b>DTSP-FR</b> shall contain one <b>DtspError</b> data set for each Retrieval Transfer Service Profile that is bound to the Service Package at the time that service management validation is attempted.
DTSPD-07	The <code>transferServiceProfileRef</code> parameter value of the <b>DTSP-FR</b> shall be equal to the <code>transferServiceProfileId</code> parameter of the <b>DTSP-I</b> that invoked the operation. [service management validation]

## 5.12 QUERY\_TRANSFER\_SERVICE\_PROFILE (QTSP) OPERATION

### 5.12.1 PURPOSE

The `QUERY_TRANSFER_SERVICE_PROFILE` (QTSP) operation is used by UM to request a copy of a Transfer Service Profile that is already available at CM for a given Service Agreement.

### 5.12.2 PROCEDURE

**5.12.2.1** The QTSP operation is defined to be a two-phase operation in accordance with the operation procedure pattern specified in 3.4.1.

**5.12.2.2** The QTSP operation is defined in terms of the following messages:

- **QueryTransferServiceProfileInvocation** (QTSP-I);
- **QueryTransferServiceProfileSuccessfulReturn** (QTSP-SR); and
- **QueryTransferServiceProfileFailedReturn** (QTSP-FR).

**5.12.2.3** The message sequence diagram for the `QUERY_TRANSFER_SERVICE_PROFILE` operation is defined by applying the following argument list to the stereotyped sequence diagram for the two-phase operation procedure pattern specified in 3.4.1.2:

```
twoPhaseOperationProcedurePatternSequence {UM, CM, QTSP-I, QTSP-SR, QTSP-FR}
```

**5.12.2.4** The activity diagram for the `QUERY_TRANSFER_SERVICE_PROFILE` operation is defined by applying the following argument list to the stereotyped activity diagram for the two-phase operation procedure pattern specified in 3.4.1.4:

```
twoPhaseOperationProcedurePatternActivity {UM, CM, QTSP-I, QTSP-SR, QTSP-FR,
qtspRoutineTimeout,
qtspUrgentTimeout}
```

**5.12.3 REQUIREMENTS**

**5.12.3.1 UM Requirements for the `QUERY_TRANSFER_SERVICE_PROFILE` Operation**

The UM requirements for the `QTSP` operation are defined in table 5-109.

**Table 5-109: UM Requirements for the `QTSP` Operation**

QTSPU-01	UM shall conform to all Invoker Requirements for Two-Phase Operation Procedures as specified in 3.4.1.5.1.
QTSPU-02	UM shall conform to all <code>QTSP-I</code> Data Set Composition and Relationship Requirements when creating and transmitting an <code>QTSP-I</code> as specified in table 5-111.
QTSPU-03	UM should send <code>QTSP-I</code> messages that are valid with respect to all service management validation requirements for CM as defined in table 5-111.
QTSPU-04	UM shall validate that a received <code>QTSP-SR</code> or <code>QTSP-FR</code> conforms to all <code>QTSP-SR</code> or <code>QTSP-FR</code> syntactic validation requirements specified in table 5-112 or table 5-114, respectively. If the return fails any of the syntactic validation requirements, UM shall process the message set containing the syntactically invalid return in accordance with the Invoker Requirements for Two-Phase Operation Procedures.
QTSPU-05	UM shall validate that a received <code>QTSP-SR</code> or <code>QTSP-FR</code> conforms to all <code>QTSP-SR</code> or <code>QTSP-FR</code> service management validation requirements specified in table 5-112 or table 5-114, respectively. If the return fails any of the service management validation requirements, UM shall process the service management-invalid return in accordance with the Invoker Requirements for Two-Phase Operation Procedures.



### 5.12.3.2 CM Requirements for the **QUERY\_TRANSFER\_SERVICE\_PROFILE** Operation

The CM requirements for the **QTSP** operation are defined in table 5-110.

**Table 5-110: CM Requirements for the QTSP Operation**

QTSPC-01	CM shall conform to all Performer Requirements for Two-Phase Operation Procedures as specified in 3.4.1.5.2.
QTSPC-02	CM shall validate that a received <b>QTSP-I</b> conforms to all <b>QTSP-I</b> syntactic validation requirements specified in table 5-111, Data Set Composition and Relationship Requirements for the <b>QTSP-I</b> . If the <b>QTSP-I</b> fails any of the syntactic requirements, CM shall process the message set containing the syntactically invalid return in accordance with the Performer Requirements for Two-Phase Operation Procedures.
QTSPC-03	CM shall validate that the <b>QTSP-I</b> conforms to all <b>QTSP-I</b> service management validation requirements specified in this table and table 5-111 Data Set Composition and Relationship Requirements. If the <b>QTSP-I</b> fails any of the service management requirements, CM shall cease processing the <b>QTSP-I</b> and respond to UM with an <b>QTSP-FR</b> message. The content of the <b>QTSP-FR</b> depends on the nature of the validation failure, and is specified in table 5-113.
QTSPC-04	CM shall validate that the <code>transferServiceProfileRef</code> matches the <code>transferServiceProfileId</code> for a Transfer Service Profile within the context of the referenced Service Agreement. [service management validation]
QTSPC-05	If the Complex has locally defined <b>QTSP-I</b> relationship requirements in addition to those specified in this Recommended Standard, CM shall validate that the <b>QTSP-I</b> conforms to all such local requirements. [service management validation]
QTSPC-06	If the <b>QTSP-I</b> is valid, CM shall create a copy of the requested Transfer Service Profile and return it in a <b>QTSP-SR</b> . [perform operation]
QTSPC-07	CM shall conform to all <b>QTSP-SR</b> Data Set Composition and Relationship Requirements when creating and transmitting an <b>QTSP-SR</b> as specified in table 5-112.
QTSPC-08	CM shall conform to all <b>QTSP-FR</b> Data Set Composition and Relationship Requirements when creating and transmitting an <b>QTSP-FR</b> as specified in table 5-114.

**5.12.4 QueryTransferServiceProfileInvocation (QTSP-I) MESSAGE (UM → CM)**

**5.12.4.1 General**

The **QueryTransferServiceProfileInvocation** message conforms to the data set composition and relationship requirements for, and inherits the parameters of, the <<Invocation>> stereotype, as specified in 3.3.5.3.2. Figure 5-37 is the message structure class diagram for the **QTSP-I** message.

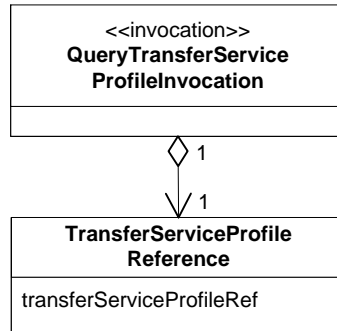

**Figure 5-37: QTSP-I Message Structure Class Diagram**

**5.12.4.2 Parameters**

The contents of the **TransferServiceProfileReference** data set are defined in table 5-85.

**5.12.4.3 Data Set Composition and Relationship Requirements**

Table 5-111 defines the data set composition and relationship requirements for the **QTSP-I** message.

**Table 5-111: Data Set Composition and Relationship Requirements for the QTSP-I**

QTSPD-01	The <b>QTSP-I</b> shall contain one <b>TransferServiceProfileReference</b> data set. [syntactic validation]
----------	--

### 5.12.5 QueryTransferServiceProfileSuccessfulReturn (QTSP-SR) MESSAGE (CM→UM)

#### 5.12.5.1 General

The **QueryTransferServiceProfileSuccessfulReturn** message conforms to the data set composition and relationship requirements for, and inherits the parameters of, the <<SuccessfulReturn>> stereotype (as specified in 3.3.5.3.3.2). Figure 5-38 is the message structure class diagram for the **QTSP-SR** message.

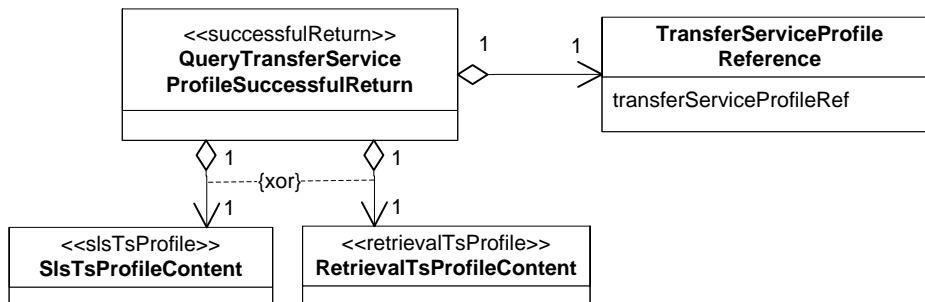

Figure 5-38: QTSP-SR Message Structure Class Diagram

#### 5.12.5.2 Parameters

The contents of the **TransferServiceProfileReference** data set are defined in table 5-85.

The **SlsTsProfileContent** data set conforms to the data set composition and relationship requirements for, and inherits the parameters of, the <<SlsTsProfile>> (as specified in 5.9.4).

The **RetrievalTsProfileContent** data set conforms to the data set composition and relationship requirements for, and inherits the parameters of, the <<RetrievalTsProfile>> (as specified in 5.10.4).

#### 5.12.5.3 Data Set Composition and Relationship Requirements

Table 5-112 defines the data set composition and relationship requirements for the **QTSP-SR** message.

**Table 5-112: Data Set Composition and Relationship Requirements for the QTSP-SR**

QTSPD-02	The <b>QTSP-SR</b> shall contain one <b>TransferServiceProfileReference</b> data set. [syntactic validation]
QTSPD-03	The <b>QTSP-SR</b> shall contain one and only one of the following: a) a <b>SlsTsProfileContent</b> data set; or b) a <b>RetrievalTsProfileContent</b> data set. [syntactic validation]
QTSPD-04	The <code>transferServiceProfileRef</code> parameter value of the <b>QTSP-SR</b> shall be equal to the <code>transferServiceProfileId</code> parameter of the <b>QTSP-I</b> that invoked the operation. [service management validation]

**5.12.6 QueryTransferServiceProfileFailedReturn (QTSP-FR) MESSAGE**  
(CM → UM)

**5.12.6.1 General**

The **QueryTransferServiceProfileFailedReturn** message conforms to the data set composition and relationship requirements for, and inherits the parameters of, the <<FailedReturn>> stereotype, as specified in table 3-10. Figure 5-39 is the message structure class diagram for the **QTSP-FR** message.

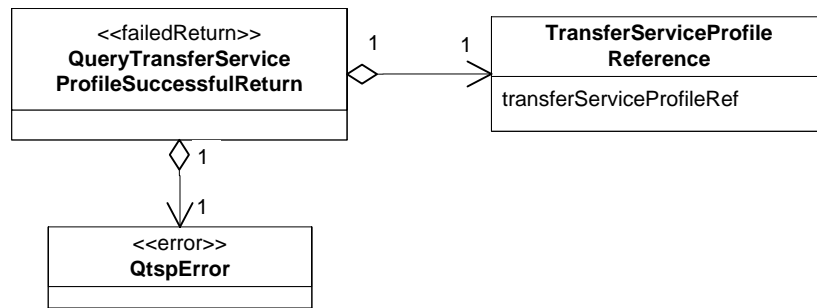

**Figure 5-39: QTSP-FR Message Structure Class Diagram**

### 5.12.6.2 Parameters

The contents of the **TransferServiceProfileReference** data set are defined in table 5-85.

The **QtspError** data set of the **QueryTransferServiceProfileFailedReturn** message conforms to the data set composition and relationship requirements for, and inherits the parameters of, the <<Error>> data set stereotype, which contains a diagnostic parameter of the <<ErrorDiagnostic>> stereotype. Table 5-113 defines the additional values of the diagnostic parameter for the **QtspError** data set, identifies the CM and data set composition service management requirements that result in that diagnostic value being returned, and identifies the contents of the **erroredItem** and **additionalInformation** parameters that accompany each diagnostic value.

**Table 5-113: QtspError Data Set diagnostic Parameter Definition**

diagnostic value	Definition/Description	Rqmt	Parameter or Data Set Identified by erroredItem	Content of additional Information
'operation timeout'	See table 3-11.	2PC-0103		
'referenced transferServiceProfileId unknown'	The referenced transferServiceProfileId is not registered at CM within the context of the referenced Service Agreement.	QTSPC-04	transferServiceProfileRef	n/a
'other'	The operation has failed due to an error that is local to the Service Agreement.	QTSPC-05	The invalid parameter or data set that causes the violation	Text-string description of the local error

### 5.12.6.3 Data Set Composition and Relationship Requirements for QTSP-FR

Table 5-114 defines the data set composition and relationship requirements for the **QTSP-FR** message that are in addition to those of the <<FailedReturn>> stereotype.

**Table 5-114: Data Set Composition and Relationship Requirements for the QTSP-FR**

QTSPD-05	The <b>QTSP-FR</b> shall contain: a) one <b>TransferServiceProfileReference</b> data set; and b) one or more <b>QtspError</b> data sets. [syntactic validation]
QTSPD-06	The transferServiceProfileRef parameter value of the <b>QTSP-FR</b> shall be equal to the transferServiceProfileId parameter of the <b>QTSP-I</b> that invoked the operation. [service management validation]

## 6 TRAJECTORY PREDICTION OPERATIONS

### 6.1 GENERAL

The Trajectory Prediction operations that may be invoked by UM are:

- ADD\_TRAJECTORY\_PREDICTION—to add a new Trajectory Prediction at CM;
- DELETE\_TRAJECTORY\_PREDICTION—to delete a Trajectory Prediction that is currently available at CM;
- QUERY\_TRAJECTORY\_PREDICTION—to query the content of a Trajectory Prediction that is available at CM; and
- EXTEND\_TRAJECTORY\_PREDICTION—to add trajectory prediction data to a Trajectory Prediction that is already available at CM.

No Trajectory Prediction operations can be invoked by CM.

Subsections 6.3 through 6.6 define those operations used by UM to create, delete and query each Trajectory Prediction that exists at the CM.

NOTE 1 – When operating in the ‘invoked deletion only’ mode (see trajectoryPredictionDeletionMode in table 7-15), UM is responsible for managing the Trajectory Predictions available at CM, and therefore UM should keep track of the expiration times for the Trajectory Predictions and delete and add as necessary. CM does not notify UM when the Trajectory Predictions that are available at CM expire.

NOTE 2 – There is a limited amount of storage space available at CM for Trajectory Predictions related to a Service Agreement (i.e., as defined by parameter maxSizeTrajectoryFilestore, specified in table 7-15). CM rejects new Trajectory Predictions once this storage space is exceeded.

### 6.2 LIFECYCLE AND OWNERSHIP OF A TRAJECTORY PREDICTION

#### 6.2.1 LIFECYCLE

The lifecycle of a trajectory prediction, as created using the standard SCCS-SM trajectory prediction operations and held by CM, is modeled as a state machine and is shown in figure 6-1, and in table 6-1.

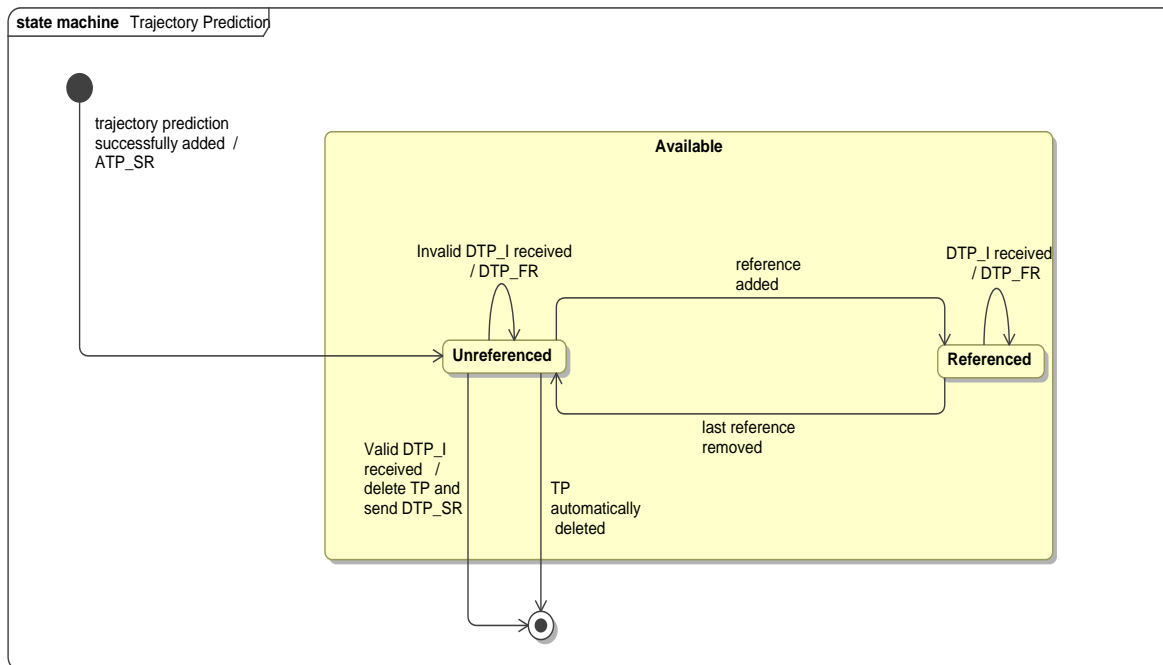

Figure 6-1: State Diagram for Trajectory Prediction

Table 6-1: State Table for Trajectory Prediction

States	Available			
	Initial	Acknowledged	Unreferenced	Referenced
trajectory prediction successfully added	ATP-SR -> Unreferenced	*	*	*
DTP-I received	*	*	[DTP-I valid] DTP-SR -> Final else DTP-FR -> Unreferenced	DTP-FR -> Referenced
reference added	*	*	-> Referenced	
last ref removed	*	*	*	-> Unreferenced
TP automatically deleted	*	*	-> Final	

The trajectory prediction lifecycle shall conform to the state machine shown, with reference criteria as described in DTPC-07.

### 6.2.2 OWNERSHIP OF TRAJECTORY PREDICTIONS

Each trajectory prediction shall be owned by the UM entity associated with the `smSource` used in the `SmMessageSet` that contained the invocation message that created the trajectory prediction.

### 6.3 ADD\_TRAJECTORY\_PREDICTION (ATP) OPERATION

#### 6.3.1 PURPOSE

The ADD\_TRAJECTORY\_PREDICTION (ATP) operation allows UM to add a new Trajectory Prediction at CM.

#### 6.3.2 PROCEDURE

**6.3.2.1** The ATP operation is defined to be a two-phase operation in accordance with the operation procedure pattern specified in 3.4.1.

**6.3.2.2** The ATP operation is defined in terms of the following messages:

- **AddTrajectoryPredictionInvocation (ATP-I);**
- **AddTrajectoryPredictionSuccessfulReturn (ATP-SR);**
- **AddTrajectoryPredictionFailedReturn (ATP-FR).**

**6.3.2.3** The message sequence diagram for the ADD\_TRAJECTORY\_PREDICTION operation is defined by applying the following argument list to the stereotyped sequence diagram for the two-phase operation procedure pattern specified in 3.4.1.2:

```
twoPhaseOperationProcedurePatternSequence {UM, CM, ATP-I, ATP-SR,  
                                             ATP-FR}
```

**6.3.2.4** The activity diagram for the ADD\_TRAJECTORY\_PREDICTION operation is defined by applying the following argument list to the stereotyped activity diagram for the two-phase operation procedure pattern specified in 3.4.1.4:

```
twoPhaseOperationProcedurePatternActivity {UM, CM, ATP-I, ATP-SR,  
                                             ATP-FR, atpRoutineTimeout,  
                                             atpUrgentTimeout}
```

#### 6.3.3 REQUIREMENTS

##### 6.3.3.1 UM Requirements for the ADD\_TRAJECTORY\_PREDICTION Operation

The UM requirements for the **ATP** operation are defined in table 6-2.



**Table 6-2: UM Requirements for the ATP Operation**

ATPU-01	UM shall conform to all Invoker Requirements for Two-Phase Operation Procedures as specified in 3.4.1.5.1.
ATPU-02	UM shall conform to all <b>ATP-I</b> Data Set Composition and Relationship Requirements when creating and transmitting an <b>ATP-I</b> as specified in table 6-11.
ATPU-03	UM should submit <b>ATP-I</b> messages that are valid with respect to all service management validation requirements for CM as defined in table 6-3.
ATPU-04	UM shall validate that a received <b>ATP-SR</b> or <b>ATP-FR</b> conforms to all <b>ATP-SR</b> or <b>ATP-FR</b> syntactic validation requirements specified in tables 6-14 and 6-16, respectively. If the return fails any of the syntactic validation requirements, UM shall process the message set containing the syntactically invalid return in accordance with the Invoker Requirements for Two-Phase Operation Procedures.
ATPU-05	UM shall validate that a received <b>ATP-SR</b> or <b>ATP-FR</b> conforms to all <b>ATP-SR</b> or <b>ATP-FR</b> service management validation requirements specified in tables 6-14 and 6-16, respectively. If the return fails any of the service management validation requirements, UM shall process the service management invalid return in accordance with the Invoker Requirements for Two-Phase Operation Procedures.
ATPU-06	UM should provide Trajectory Prediction start and stop times consistent with the Service Packages that will be referencing this Trajectory Prediction. Consistent times mean the following relationship is true: Trajectory Prediction start time < earliest Service Scenario start time < latest Service Scenario stop time < Trajectory Prediction stop time.

### 6.3.3.2 CM Requirements for the ADD\_TRAJECTORY\_PREDICTION Operation

The CM requirements for the **ATP** operation are defined in table 6-3.

**Table 6-3: CM Requirements for the ATP Operation**

ATPC-01	CM shall conform to Performer Requirements for Two-Phase Operation Procedures as specified in 3.4.1.5.2.
ATPC-02	CM shall conform to all <b>ATP-SR</b> and <b>ATP-FR</b> Data Set Composition and Relationship Requirements when creating and transmitting a <b>ATP-SR</b> and <b>ATP-FR</b> , as specified in tables 6-14 and 6-16, respectively.
ATPC-03	CM shall validate that a received <b>ATP-I</b> conforms to all <b>ATP-I</b> syntactic validation requirements specified in this table and table 6-11, Data Set Composition and Relationship Requirements for the <b>ATP-I</b> . If the <b>ATP-I</b> fails any of the syntactic requirements, CM shall process the message set containing the syntactically invalid invocation in accordance with the Performer Requirements for Two-Phase Operation Procedures.
ATPC-04	CM shall validate that the <b>ATP-I</b> conforms to all <b>ATP-I</b> service management validation requirements specified in table 6-11, Data Set Composition and Relationship Requirements for the <b>ATP-I</b> . If the <b>ATP-I</b> fails any of the service management requirements, CM shall cease processing the <b>ATP-I</b> and respond to UM with an <b>ATP-FR</b> message. The content of the <b>ATP-FR</b> depends on the nature of the validation failure, and is specified in table 6-15.
ATPC-05	CM shall validate that the <b>ATP-I</b> would not cause the storage area at CM reserved for Trajectory Predictions to exceed <code>maxSizeTrajectoryFilestore</code> for the referenced Service Agreement. [service management validation]
ATPC-06	CM shall validate that each <b>ATP-I</b> parameter that is constrained by a Service Agreement parameter is consistent with the applicable Service Agreement parameter. [service management validation]

ATPC-07	CM shall validate that all <b>ATP-I</b> parameter values that are related to each other (as defined in the Data Set Composition and Relationship Requirements) contain mutually compatible values. [service management validation]
ATPC-08	If the Complex has locally defined <b>ATP-I</b> relationship requirements in addition to those specified in this standard, CM shall validate that the <b>ATP-I</b> conforms to all such local requirements. [service management validation]
ATPC-09	If the <b>OrbitParameterMessageText</b> data set is used in the <b>ATP-I</b> , then CM shall validate that the contents of parameter <code>opmTextData</code> meet any data composition and relationship requirements defined for the Orbit Parameter Message (OPM) in the CCSDS Recommended Standard for Orbit Data Messages (ODM) (reference [13]). [service management validation]
ATPC-10	If the <b>OrbitParameterMessageXml</b> data set is used in the <b>ATP-I</b> , then CM shall validate that the contents of parameter <code>opmXmlData</code> meet any data composition and relationship requirements defined for the Orbit Parameter Message (OPM) in the CCSDS Recommended Standard for Orbit Data Messages (ODM) (references [13] and [15]). [service management validation]
ATPC-11	If the <b>OrbitEphemerisMessageText</b> data set is used in the <b>ATP-I</b> , then CM shall validate that the contents of parameter <code>oemTextData</code> meet any data composition and relationship requirements defined for the Orbit Ephemeris Message (OEM) in the CCSDS Recommended Standard for Orbit Data Messages (ODM) (reference [13]). [service management validation]
ATPC-12	If the <b>OrbitEphemerisMessageXml</b> data set is used in the <b>ATP-I</b> , then CM shall validate that the contents of parameter <code>oemXmlData</code> meet any data composition and relationship requirements defined for the Orbit Ephemeris Message (OEM) in the CCSDS Recommended Standard for Orbit Data Messages (ODM) (references [13] and [15]). [service management validation]
ATPC-13	If the <b>OrbitBilateralMessage</b> data set is used in the <b>ATP-I</b> , then CM shall validate that the <b>OrbitBilateralMessage</b> data set composition and relationship requirements for the format indicated by parameter <code>bilateralTrajectoryFormatId</code> are met. [service management validation]
ATPC-14	If the <b>ATP-I</b> passes syntactic and service management validation, CM shall: <ul style="list-style-type: none"> <li>a) add the Trajectory Prediction to the set of Trajectory Predictions already available at CM;</li> <li>b) count the Trajectory Prediction as applying against the <code>maxSizeTrajectoryFilestore</code> parameter of the Service Agreement; and</li> <li>c) return an <b>ATP-SR</b> message.</li> </ul> [perform operation]

6.3.4 AddTrajectoryPredictionInvocation (ATP-I) MESSAGE (UM → CM)

6.3.4.1 General

The **AddTrajectoryPredictionInvocation (ATP-I)** message conforms to the data set composition and relationship requirements for, and inherits the parameters of, the <<Invocation>> stereotype, as specified in 3.3.5.3.2. Figure 6-2 shows the **ATP-I** message structure as a class diagram.

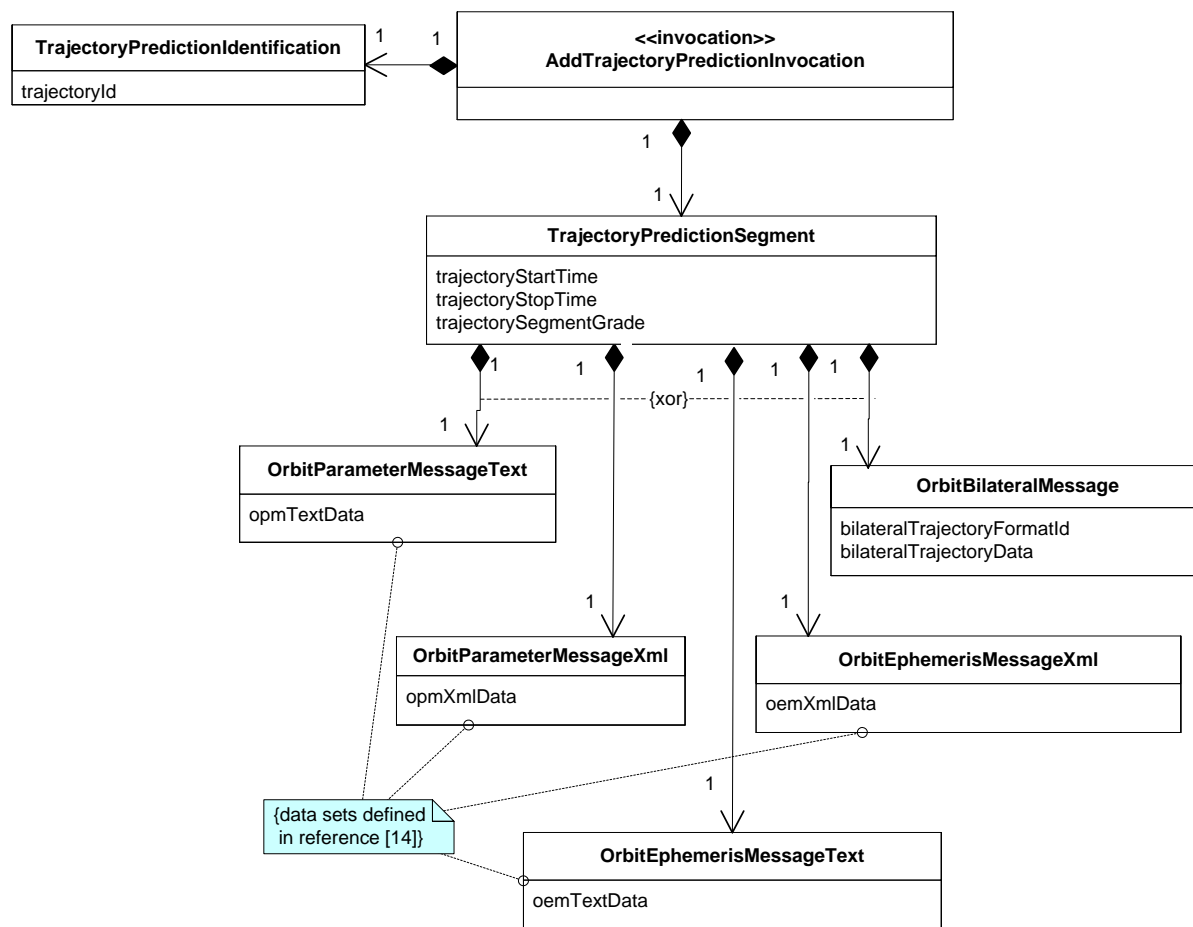

Figure 6-2: ATP-I Message Structure Class Diagram

### 6.3.4.2 Parameters

The **AddTrajectoryPredictionInvocation** message allows the selection between:

- a bi-laterally agreed message format, as represented in the diagram above by the **OrbitBilateralMessage** data set; or
- the two standard message formats for use in transferring spacecraft orbit information between space Agencies:
  - the Orbit Parameter Message (OPM); and
  - the Orbit Ephemeris Message (OEM);

NOTE – The OPM and OEM formats are defined by CCSDS both in plain text and in XML Schema.

- the adopted representation is indicated by the data set names:
  - **OrbitParameterMessageText**, for OPM in plain text format;
  - **OrbitParameterMessageXml**, for OPM in XML format;
  - **OrbitEphemerisMessageText**, for OEM in plain text format;
  - **OrbitEphemerisMessageXml**, for OEM in XML format.

The selection is restricted by the list of trajectory formats supported by the applicable Service Agreement, which is defined by the parameter `trajectoryFormatOptions` (table 7-15).

The specification of the parameters for the **OrbitParameterMessageText**, **OrbitParameterMessageXml**, **OrbitEphemerisMessageText** and **OrbitEphemerisMessageXml** data sets is given in references [13] and [15] and hence is not repeated here to avoid inconsistencies.

The parameters for the **ATP-I** message are defined in table 6-4 through table 6-10.

**Table 6-4: TrajectoryPredictionIdentification Data Set**

Name	Definition/Description	Data Type	Units	Applicable Service Agreement Parameter
<code>trajectoryId</code>	Identifier of Trajectory Prediction, unique within UM and CM domains.	String256	n/a	n/a

**Table 6-5: TrajectoryPredictionSegment Data Set**

<b>Name</b>	<b>Definition/Description</b>	<b>Data Type</b>	<b>Units</b>	<b>Applicable Service Agreement Parameter</b>
trajectory-SegmentGrade	Grade of the trajectory segment: <ul style="list-style-type: none"> <li>– ‘acquisition’—Used to acquire and track the spacecraft (the highest accuracy);</li> <li>– ‘sequence’—Suitable for use in event sequencing;</li> <li>– ‘schedule’—Suitable for use in scheduling;</li> <li>– ‘lifeOfMission’—To be used for very long-range planning;</li> <li>– ‘other’—Bilaterally defined.</li> </ul> NOTE – For the purposes of Version 1 of SCCS-SM, only the ‘acquisition’ and ‘schedule’ grades are relevant. The other values may be used to meet other, locally defined uses for trajectory predictions.	Enum	n/a	n/a
trajectoryStartTime	The initial time for which the data contained within the segment is valid for use for the purposes of predicting the trajectory of the space element at the specified grade.	UTC	n/a	n/a
trajectoryStopTime	The ending time for which the data contained within the segment is valid for use for the purposes of predicting the trajectory of the space element at the specified grade. NOTE – For OPM-bearing trajectory segments, the contained state vector is to be propagated until the trajectoryStopTime or later.	UTC	n/a	n/a

**Table 6-6: OrbitParameterMessageText Data Set**

<b>Name</b>	<b>Definition/Description</b>	<b>Data Type</b>	<b>Units</b>	<b>Applicable Service Agreement Parameter</b>
opmTextData	Contains the Trajectory Prediction data in the OPM format represented in plain text.	OpmText-Data	n/a	trajectoryFormatOptions

**Table 6-7: OrbitParameterMessageXml Data Set**

<b>Name</b>	<b>Definition/Description</b>	<b>Data Type</b>	<b>Units</b>	<b>Applicable Service Agreement Parameter</b>
opmXmlData	Contains the Trajectory Prediction data in the OPM format represented in XML.	OpmXml-Data	n/a	trajectoryFormatOptions

**Table 6-8: OrbitEphemerisMessageText Data Set**

Name	Definition/Description	Data Type	Units	Applicable Service Agreement Parameter
oemTextData	Contains the Trajectory Prediction data in the OEM format represented in plain text.	OemText-Data	n/a	trajectoryFormat-Options

**Table 6-9: OrbitEphemerisMessageXml Data Set**

Name	Definition/Description	Data Type	Units	Applicable Service Agreement Parameter
oemXmlData	Contains the Trajectory Prediction data in the OEM format represented in XML.	OemXml-Data	n/a	trajectoryFormat-Options

**Table 6-10: OrbitBilateralMessage Data Set**

Name	Definition/Description	Data Type	Units	Applicable Service Agreement Parameter
bilateral-TrajectoryData	Contains the Trajectory Prediction data in the format defined by the parameter <code>bilateralTrajectoryFormatId</code> .	Bilateral-Data	n/a	n/a
bilateral-Trajectory-FormatId	Identification of trajectory data format other than the two CCSDS standard formats OPM and OEM. This format has to be bi-laterally agreed between UM and CM.	String256	n/a	Trajectory-Prediction-Operations-Constraints: allowed-Bilateral-Trajectory-FormatIds

### 6.3.4.3 Data Set Composition and Relationship Requirements

Table 6-11 defines the data set composition and relationship requirements for the **ATP-I** message.

**Table 6-11: Data Set Composition and Relationship Requirements for ATP-I**

ATPD-01	The <b>ATP-I</b> shall contain: a) one <b>TrajectoryPredictionIdentification</b> data set; and b) one <b>TrajectoryPredictionSegment</b> data set. [syntactic validation]
ATPD-02	The <b>TrajectoryPredictionSegment</b> data set shall contain one and only one of the following data sets: a) <b>OrbitParameterMessageText</b> ; b) <b>OrbitParameterMessageXml</b> ; c) <b>OrbitEphemerisMessageText</b> ; d) <b>OrbitEphemerisMessageXml</b> ; or e) <b>OrbitBilateralMessage</b> . [syntactic validation]
ATPD-03	The parameter <code>trajectoryFormatOptions</code> in the <b>ServiceAgreement</b> data set (table 7-15) restricts the Trajectory Prediction format choices. This means that the <b>TrajectoryPredictionSegment</b> data set may contain: a) an <b>OrbitParameterMessageText</b> data set only if the <code>trajectoryFormatOptions</code> parameter set includes the enumeration value 'opmText'; b) an <b>OrbitParameterMessageXml</b> data set only if the <code>trajectoryFormatOptions</code> parameter set includes the enumeration value 'opmXml'; c) an <b>OrbitEphemerisMessageText</b> data set only if the <code>trajectoryFormatOptions</code> parameter set includes the enumeration value 'oemText'; d) an <b>OrbitEphemerisMessageXml</b> data set only if the <code>trajectoryFormatOptions</code> parameter set includes the enumeration value 'oemXml'; e) an <b>OrbitBilateralMessage</b> data set only if the <code>trajectoryFormatOptions</code> parameter set includes the enumeration value 'obm'. [service management validation]
ATPD-04	The <code>trajectoryId</code> parameter shall be unique in the context of the referenced Service Agreement. [service management validation]
ATPD-05	The format of parameters <code>opmTextData</code> in the <b>OrbitParameterMessageText</b> data set and <code>oemTextData</code> in the <b>OrbitEphemerisMessageText</b> data set shall comply with the plain text syntax of the Orbit Parameter Message (OPM) and the Orbit Ephemeris Message (OEM), respectively, defined in the CCSDS Recommended Standard for Orbit Data Messages (ODM) (reference [13]). [syntactic validation]
ATPD-06	The format of parameters <code>opmXmlData</code> in the <b>OrbitParameterMessageXml</b> data set and <code>oemXmlData</code> in the <b>OrbitEphemerisMessageXml</b> data set shall comply with the XML Schema syntax of the Orbit Parameter Message (OPM) and the Orbit Ephemeris Message (OEM), respectively, defined in the CCSDS XML Specification for Navigation Data Messages (reference [15]). [syntactic validation]
ATPD-07	The <code>trajectoryStopTime</code> shall be a time later than the <code>trajectoryStartTime</code> . [service management validation]
ATPD-08	The <code>trajectoryStartTime</code> shall have a value later than that of the <code>messageTimestamp</code> of the <b>ATP-I</b> . [service management validation]
ATPD-09	If the segment contains an Orbit Parameter Message (text or XML), the <code>trajectoryStartTime</code> must be equal to or later than the epoch of the vector. NOTE – The vector includes its epoch in the Orbit Parameter Message. [service management validation]

ATPD-10	<p>If the segment contains an Orbit Ephemeris Message (text or XML):</p> <ul style="list-style-type: none"> <li>a) The trajectoryStartTime shall be equal to or later than the epoch of the first vector of the OEM;</li> <li>b) The trajectoryStopTime shall be equal to or earlier than the epoch of the last vector of the OEM.</li> </ul> <p>NOTE – Each vector includes its epoch in the OEM. [service management validation]</p>
---------	--

### 6.3.5 AddTrajectoryPredictionSuccessfulReturn (ATP-SR) MESSAGE (CM → UM)

#### 6.3.5.1 General

The **AddTrajectoryPredictionSuccessfulReturn (ATP-SR)** message conforms to the data set composition and relationship requirements for, and inherits the parameters of, the <<SuccessfulReturn>> stereotype, as specified in 3.3.5.3.3.2. Figure 6-3 shows the message structure of the **ATP-SR** as a class diagram.

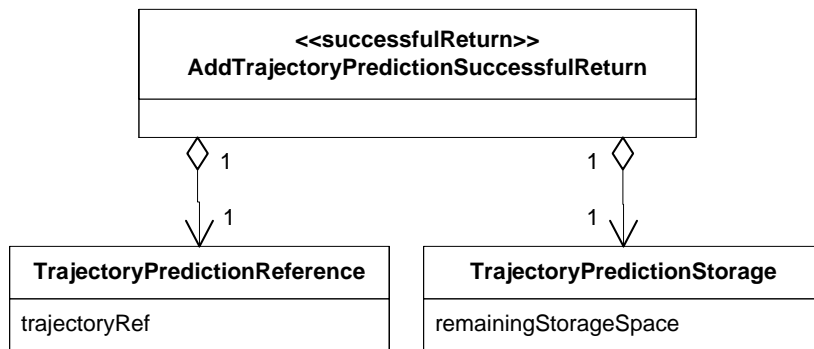

Figure 6-3: ATP-SR Message Structure Class Diagram

#### 6.3.5.2 Parameters

The parameters for the **ATP-SR** message are described in table 6-12 and table 6-13.

Table 6-12: TrajectoryPredictionReference Data Set

Name	Definition/Description	Data Type	Units	Applicable Service Agreement Parameter
trajectoryRef	Contains value of parameter trajectoryId or trajectoryRef of corresponding invocation.	String256	n/a	n/a



**Table 6-13: TrajectoryPredictionStorage Data Set**

Name	Definition/Description	Data Type	Units	Applicable Service Agreement Parameter
remainingStorage-Space	Remaining Trajectory Prediction storage area in the Complex after the addition of the new Trajectory Prediction.	Unsigned Integer	Mbytes	<b>Trajectory-Prediction-Operations-Constraints:</b> maxSize-Trajectory-Filestore

### 6.3.5.3 Data Set Composition and Relationship Requirements

Table 6-14 defines the data set composition and relationship requirements for the ATP-SR message.

**Table 6-14: Data Set Composition and Relationship Requirements for ATP-SR**

ATPD-11	The value of the trajectoryRef parameter shall be the same as the value of the trajectoryId of the <b>ATP-I</b> to which this return responds. [service management validation]
ATPD-12	The <b>ATP-SR</b> shall contain one <b>TrajectoryPredictionReference</b> data set. [syntactic validation]
ATPD-13	The <b>ATP-SR</b> shall contain one <b>TrajectoryPredictionStorage</b> data set. [syntactic validation]

## 6.3.6 AddTrajectoryPredictionFailedReturn (ATP-FR) MESSAGE (CM → UM)

### 6.3.6.1 General

The **AddTrajectoryPredictionFailedReturn (ATP-FR)** message conforms to the data set composition and relationship requirements for, and inherits the parameters of, the <<FailedReturn>> stereotype, as specified in table 3-10. The **AtpError** data set of the **ATP-FR** message conforms to and inherits the parameters of the <<Error>> data set stereotype, which contains a diagnostic parameter of the <<ErrorDiagnostic>> stereotype.

Figure 6-4 shows the message structure of the **ATP-FR** as a class diagram.

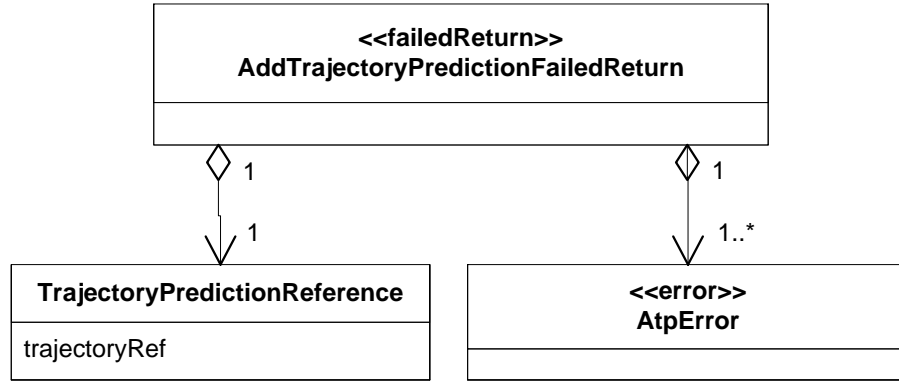

Figure 6-4: ATP-FR Message Structure Class Diagram

6.3.6.2 Parameters

The **TrajectoryPredictionReference** data set is defined in table 6-12.

Table 6-15 defines the additional values of the diagnostic parameter for the **AtpError** data set, identifies the CM and data set composition service management requirements that result in that diagnostic value being returned, and identifies the contents of the erroredItem and additionalInformation parameters that accompany each diagnostic value.

Table 6-15: AtpError Data Set diagnostic Parameter Definition

diagnostic value	Definition/Description	Rqmt	Parameter or Data Set Identified by erroredItem	Content of additional-Information
'exceeds Trajectory Prediction storage area at CM'	<b>ATP-I</b> would cause the Trajectory Prediction storage area at CM to be exceeded.	ATPC-05	trajectoryId	value of parameter remainingStorageSpace
'incompatible time'	The epoch of a (the) vector within the trajectory message is incompatible with the start or stop time of the <b>ATP-I</b> .	ATPD-09	trajectoryStartTime	n/a
		ATPD-10a	trajectoryStartTime	
		ATPD-10a	trajectoryStopTime	
'invalid trajectory-StopTime'	The value of parameter trajectoryStopTime is invalid because it is earlier than trajectoryStartTime.	ATPD-07	trajectoryStopTime	n/a

diagnostic value	Definition/Description	Rqmt	Parameter or Data Set Identified by erroredItem	Content of additional-Information
'mutually incompatible parameter values'	Two or more parameters of the <b>ATP-I</b> contain mutually incompatible values.	ATPC-07	One of the mutually incompatible parameters  See GRD-0026, table 3-12.	n/a
'non-conformant to data set composition and relationship requirements of indicated format'	If one of the following occurs: 1) the contents of the parameter <code>opmTextData</code> in the <b>OrbitParameter-MessageText</b> data set do not meet the OPM data set composition and relationship requirements; 2) the contents of the parameter <code>opmXmlData</code> in the <b>OrbitParameter-MessageXml</b> data set do not meet the OPM data set composition and relationship requirements; 3) the contents of the parameter <code>oemTextData</code> in the <b>OrbitEphemerisMessageText</b> data set do not meet the OEM data set composition and relationship requirements; 4) the contents of the parameter <code>oemXmlData</code> in the <b>OrbitEphemerisMessageXml</b> data set do not meet the OEM data set composition and relationship requirements; 5) the contents of the parameter <code>bilateralTrajectoryData</code> in the <b>Orbit-BilateralMessage</b> data set do not meet the relevant data set composition and relationship requirements.	ATPC-09	For cases 2) and 4), which adopt the XML format, <code>erroredItem</code> shall contain the distinguished name of the non-conformant element (the one that failed validation).	n/a for cases 2), 4), and 5)
		ATPC-10	For cases 1), 3) and 5), <code>erroredItem</code> shall contain the distinguished name of the <b>Trajectory-Prediction-Segment</b> data set. Any further information about non-conformance shall be conveyed via the contents of <code>additional-Information</code> .	For cases 1) and 3), <code>additionalInformation</code> shall specify the non-conformant field(s) that caused <b>ATP-I</b> to fail validation.
		ATPC-11		
		ATPC-12		
		ATPC-13		
'operation timeout'	When the operation cannot be completed before the disposition timer expires.	2PP-0103b in table 3-32	n/a	n/a

diagnostic value	Definition/Description	Rqmt	Parameter or Data Set Identified by erroredItem	Content of additional-Information
'parameter value not supported by referenced Service Agreement'	The value of the identified parameter is not within the values permitted by the referenced Service Agreement.	ATPC-06, ATPD-03	The parameter in violation	n/a
'trajectoryId already in use'	There is a Trajectory Prediction with this identifier already registered at CM for the referenced Service Agreement.	ATPD-04	trajectoryId	n/a
'trajectory-StartTime already past'	It is already past the time at which the segment was supposed to have started being used.	ATPD-08	trajectory-StartTime	
'other'	The operation has failed due to an error that is local to the Service Agreement.	ATPC-08	The invalid parameter or data set that causes the violation	Text-string description of the local error.

### 6.3.6.3 Data Set Composition and Relationship Requirements

Table 6-16 defines the data set composition and relationship requirements for the ATP-FR message that are in addition to those of the <<FailedReturn>> stereotype.

**Table 6-16: Data Set Composition and Relationship Requirements for ATP-FR**

ATPD-14	The <b>ATP-FR</b> shall contain one <b>TrajectoryPredictionReference</b> data set. [syntactic validation]
ATPD-15	The <b>ATP-FR</b> shall contain one or more <b>AtpError</b> data sets. [syntactic validation]
ATPD-16	The value of the trajectoryRef parameter shall be the same as the value of the trajectoryId of the <b>ATP-I</b> to which this return responds. [service management validation]

## 6.4 DELETE\_TRAJECTORY\_PREDICTION (DTP) OPERATION

### 6.4.1 PURPOSE

The DELETE\_TRAJECTORY\_PREDICTION (DTP) operation allows UM to instruct CM to remove a Trajectory Prediction from the set of Trajectory Predictions that are currently available at CM for a given Service Agreement.

### 6.4.2 PROCEDURE

**6.4.2.1** The DTP operation is defined to be a two-phase operation in accordance with the operation procedure pattern specified in 3.4.1.

**6.4.2.2** The DTP operation is defined in terms of the following messages:

- DeleteTrajectoryPredictionInvocation (DTP-I);
- DeleteTrajectoryPredictionSuccessfulReturn (DTP-SR);
- DeleteTrajectoryPredictionFailedReturn (DTP-FR).

**6.4.2.3** The message sequence diagram for the DELETE\_TRAJECTORY\_PREDICTION operation is defined by applying the following argument list to the stereotyped sequence diagram for the two-phase operation procedure pattern specified in 3.4.1.2:

```
twoPhaseOperationProcedurePatternSequence {UM, CM, DTP-I, DTP-SR,
                                           DTP-FR}
```

**6.4.2.4** The activity diagram for the DELETE\_TRAJECTORY\_PREDICTION operation is defined by applying the following argument list to the stereotyped activity diagram for the two-phase operation procedure pattern specified in 3.4.1.4:

```
twoPhaseOperationProcedurePatternActivity {UM, CM, DTP-I, DTP-SR,
                                           DTP-FR,
                                           dtpRoutineTimeout,
                                           dtpUrgentTimeout}
```

### 6.4.3 REQUIREMENTS

#### 6.4.3.1 UM Requirements for the DELETE\_TRAJECTORY\_PREDICTION Operation

The UM requirements for the **DTP** operation are defined in table 6-17.

**Table 6-17: UM Requirements for the DTP Operation**

DTPU-01	UM shall conform to all Invoker Requirements for Two-Phase Operation Procedures as specified in 3.4.1.5.1.
DTPU-02	UM shall conform to all <b>DTP-I</b> Data Set Composition and Relationship Requirements when creating and transmitting a <b>DTP-I</b> as specified in table 6-19.
DTPU-03	UM should send <b>DTP-I</b> messages that are valid with respect to all service management validation requirements for CM as defined in table 6-18.
DTPU-04	UM shall validate that a received <b>DTP-SR</b> or <b>DTP-FR</b> conforms to all <b>DTP-SR</b> or <b>DTP-FR</b> syntactic validation requirements specified in table 6-20 and table 6-22, respectively. If the return fails any of the syntactic validation requirements, UM shall process the message set containing the syntactically invalid return in accordance with the Invoker Requirements for Two-Phase Operation Procedures.
DTPU-05	UM shall validate that a received <b>DTP-SR</b> or <b>DTP-FR</b> conforms to all <b>DTP-SR</b> or <b>DTP-FR</b> service management validation requirements specified in table 6-20 and table 6-22, respectively. If the return fails any of the service management validation requirements, UM shall process the service management invalid return in accordance with the Invoker Requirements for Two-Phase Operation Procedures.

#### 6.4.3.2 CM Requirements for the DELETE\_TRAJECTORY\_PREDICTION Operation

The CM requirements for the **DTP** operation are defined in table 6-18.

**Table 6-18: CM Requirements for the DTP Operation**

DTPC-01	CM shall conform to all Performer Requirements for Two-Phase Operation Procedures as specified in 3.4.1.5.2.
DTPC-02	CM shall conform to all <b>DTP-SR</b> and <b>DTP-FR</b> Data Set Composition and Relationship Requirements when creating and transmitting a <b>DTP-SR</b> and <b>DTP-FR</b> , as specified in table 6-20 and table 6-22, respectively.
DTPC-03	CM shall validate that a received <b>DTP-I</b> conforms to all <b>DTP-I</b> syntactic validation requirements specified in table 6-19, Data Set Composition and Relationship Requirements for the <b>DTP-I</b> . If the <b>DTP-I</b> fails any of the syntactic requirements, CM shall process the message set containing the syntactically invalid invocation in accordance with the Performer Requirements for Two-Phase Operation Procedures.
DTPC-04	CM shall validate that the <b>DTP-I</b> conforms to all <b>DTP-I</b> service management validation requirements specified in this table and table 6-19, Data Set Composition and Relationship Requirements for the <b>DTP-I</b> . If the <b>DTP-I</b> fails any of the service management requirements, CM shall cease processing the <b>DTP-I</b> and respond to UM with an <b>DTP-FR</b> message. The content of the <b>DTP-FR</b> depends on the nature of the validation failure, and is specified in table 6-21.
DTPC-05	If <code>enforceOwnership</code> is 'true' in the Service Agreement, CM shall validate that the <code>smSource</code> associated with the <b>DTP-I</b> is the name of the owner of the Trajectory Prediction associated with the <code>trajectoryId</code> referenced by the <code>trajectoryRef</code> in the <b>DTP-I</b> . [service management validation]

DTPC-06	If the Complex has locally defined <b>DTP-I</b> relationship requirements in addition to those specified in this standard, CM shall validate that the <b>DTP-I</b> conforms to all such local requirements. [service management validation]
DTPC-07	If the Trajectory Prediction being deleted is referenced by pending or executing Service Packages, CM shall reject the <b>DTP-I</b> and send a <b>DTP-FR</b> . [service management validation]
DTPC-08	If the <b>DTP-I</b> passes syntactic and service management validation, CM shall: <ul style="list-style-type: none"> <li>a) delete the referenced Trajectory Prediction;</li> <li>b) remove the Trajectory Prediction as applying against the <code>maxSizeTrajectoryFilestore</code> parameter of the Service Agreement; and</li> <li>c) return a <b>DTP-SR</b> message.</li> </ul> [perform operation]

#### 6.4.4 DeleteTrajectoryPredictionInvocation (DTP-I) MESSAGE (UM → CM)

##### 6.4.4.1 General

The **DeleteTrajectoryPredictionInvocation (DTP-I)** message conforms to the data set composition and relationship requirements for, and inherits the parameters of, the `<<Invocation>>` stereotype, as specified in 3.3.5.3.2. Figure 6-5 shows the message structure of the **DTP-I** as a class diagram.

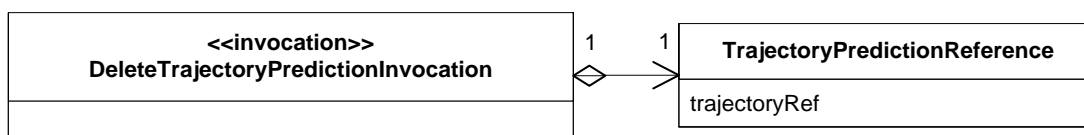

Figure 6-5: DTP-I Message Structure Class Diagram

##### 6.4.4.2 Parameters

The **TrajectoryPredictionReference** data set is defined in table 6-12.

##### 6.4.4.3 Data Set Composition and Relationship Requirements

Table 6-19 defines the data set composition and relationship requirements for the DTP-I message.

Table 6-19: Data Set Composition and Relationship Requirements for DTP-I

DTPD-01	The <b>DTP-I</b> shall contain one <b>TrajectoryPredictionReference</b> data set. [syntactic validation]
DTPD-02	The <code>trajectoryRef</code> parameter shall match the <code>trajectoryId</code> of the Trajectory Prediction to be deleted by this operation. [service management validation]

**6.4.5 DeleteTrajectoryPredictionSuccessfulReturn (DTP-SR)  
MESSAGE (CM → UM)**

**6.4.5.1 General**

The **DeleteTrajectoryPredictionSuccessfulReturn (DTP-SR)** message conforms to the data set composition and relationship requirements for, and inherits the parameters of, the <<SuccessfulReturn>> stereotype, as specified in 3.3.5.3.3.2. Figure 6-6 shows the message structure of the **DTP-SR** as a class diagram.

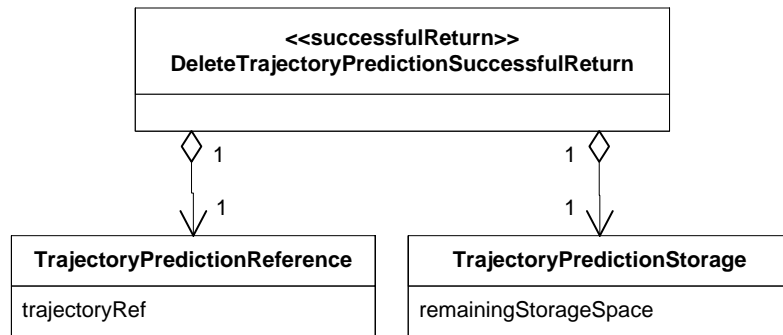

**Figure 6-6: DTP-SR Message Structure Class Diagram**

**6.4.5.2 Parameters**

The **TrajectoryPredictionReference** data set is defined in table 6-12.

The **TrajectoryPredictionStorage** data set is defined in table 6-13.

**6.4.5.3 Data Set Composition and Relationship Requirements**

Table 6-20 defines the data set composition and relationship requirements for the DTP-SR message.

**Table 6-20: Data Set Composition and Relationship Requirements for DTP-SR**

DTPD-03	The <b>DTP-SR</b> shall contain one <b>TrajectoryPredictionReference</b> data set. [syntactic validation]
DTPD-04	The <b>DTP-SR</b> shall contain one <b>TrajectoryPredictionStorage</b> data set. [syntactic validation]
DTPD-05	The value of the trajectoryRef parameter shall be the same as the value of the trajectoryRef of the <b>DTP-I</b> to which this return responds. [service management validation]



## 6.4.6 DeleteTrajectoryPredictionFailedReturn (DTP-FR) MESSAGE (CM → UM)

### 6.4.6.1 General

The **DeleteTrajectoryPredictionFailedReturn (DTP-FR)** message conforms to the data set composition and relationship requirements for, and inherits the parameters of, the `<<FailedReturn>>` stereotype, as specified in table 3-10. The **DtpError** data set of the **DTP-FR** message conforms to and inherits the parameters of the `<<Error>>` data set stereotype, which contains a diagnostic parameter of the `<<ErrorDiagnostic>>` stereotype.

Figure 6-7 shows the message structure of the **DTP-FR** as a class diagram.

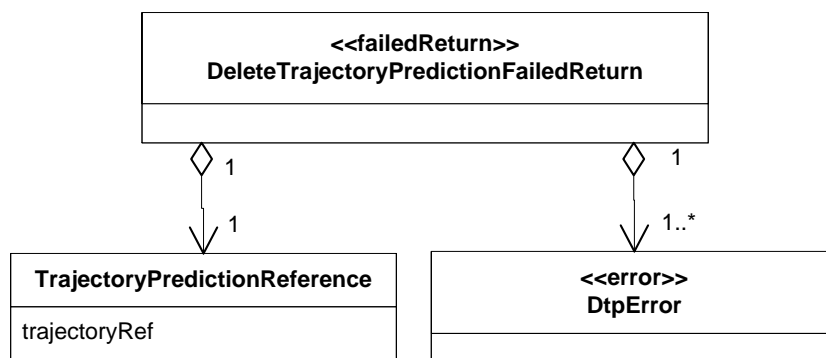

**Figure 6-7: DTP-FR Message Structure Class Diagram**

### 6.4.6.2 Parameters

The **TrajectoryPredictionReference** data set is defined in table 6-12.

Table 6-21 defines the additional values of the diagnostic parameter for the **DtpError** data set, identifies the CM and data set composition service management requirements that result in that diagnostic value being returned, and identifies the contents of the erroredItem and additionalInformation parameters that accompany each diagnostic value.

**Table 6-21: DtpError Data Set diagnostic Parameter Definition**

diagnostic value	Definition/Description	Rqmt	Parameter or Data Set Identified by erroredItem	Content of additional-Information
'operation timeout'	When the operation cannot be completed before the disposition timer expires.	2PP-0103b in table 3-32	not applicable	n/a
'smSource not the owner'	The value of the smSource is not the name of the owner of the target Trajectory Prediction.	DTPC-05	smSource	n/
'Trajectory Prediction referenced by Service Packages'	CM is unable to delete Trajectory Prediction because it is currently referenced by pending/executing Service Packages.	DTPC-07	trajectoryRef	value of the servicePackageRef of a Service Package that references the Trajectory Prediction
'trajectoryRef non-existent'	No Trajectory Prediction with this identifier is currently available at CM for the referenced Service Agreement.	DTPD-02	trajectoryRef	n/
'other'	The operation has failed due to an error that is local to the Service Agreement.	DTPC-06	The invalid parameter or data set that causes the violation	Text-string description of the local error

### 6.4.6.3 Data Set Composition and Relationship Requirements

Table 6-22 defines the data set composition and relationship requirements for the **DTP-FR** message that are in addition to those of the <<FailedReturn>> stereotype.

**Table 6-22: Data Set Composition and Relationship Requirements for DTP-FR**

DTPD-06	The <b>DTP-FR</b> shall contain one <b>TrajectoryPredictionReference</b> data set. [syntactic validation]
DTPD-07	The <b>DTP-FR</b> shall contain one or more <b>DtpError</b> data sets. [syntactic validation]
DTPD-08	The value of the trajectoryRef parameter shall be the same as the value of the trajectoryRef of the <b>DTP-I</b> to which this return responds. [service management validation]
DTPD-09	If the cause of the failure is 'Trajectory Prediction referenced by Service Packages', the <b>DTP-FR</b> shall contain one data set for each Service Package that references the Trajectory Prediction at the time that service management validation is attempted.

## 6.5 QUERY\_TRAJECTORY\_PREDICTION (QTP) OPERATION

### 6.5.1 PURPOSE

The QUERY\_TRAJECTORY\_PREDICTION (QTP) operation allows UM to request a copy of a Trajectory Prediction that is currently available at CM for a given Service Agreement.

### 6.5.2 PROCEDURE

**6.5.2.1** The QTP operation is defined to be a two-phase operation in accordance with the operation procedure pattern specified in 3.4.1.

**6.5.2.2** The QTP operation is defined in terms of the following messages:

- QueryTrajectoryPredictionInvocation (QTP-I);
- QueryTrajectoryPredictionSuccessfulReturn (QTP-SR);
- QueryTrajectoryPredictionFailedReturn (QTP-FR).

**6.5.2.3** The message sequence diagram for the QUERY\_TRAJECTORY\_PREDICTION operation is defined by applying the following argument list to the stereotyped sequence diagram for the two-phase operation procedure pattern specified in 3.4.1.2:

```
twoPhaseOperationProcedurePatternSequence {UM, CM, QTP-I, QTP-SR,
                                           QTP-FR}
```

**6.5.2.4** The activity diagram for the QUERY\_TRAJECTORY\_PREDICTION operation is defined by applying the following argument list to the stereotyped activity diagram for the two-phase operation procedure pattern specified in 3.4.1.4:

```
twoPhaseOperationProcedurePatternActivity {UM, CM, QTP-I, QTP-SR,
                                           QTP-FR,
                                           qtpRoutineTimeout,
                                           qtpUrgentTimeout}
```

### 6.5.3 REQUIREMENTS

#### 6.5.3.1 UM Requirements for the QUERY\_TRAJECTORY\_PREDICTION Operation

The UM requirements for the QTP operation are defined in table 6-23.

**Table 6-23: UM Requirements for the QTP Operation**

QTPU-01	UM shall conform to all Invoker Requirements for Two-Phase Operation Procedures as specified in 3.4.1.5.1.
QTPU-02	UM shall conform to all <b>QTP-I</b> Data Set Composition and Relationship Requirements when creating and transmitting a <b>QTP-I</b> as specified in table 6-25.
QTPU-03	UM should send <b>QTP-I</b> messages that are valid with respect to all service management validation requirements for CM as defined in table 6-24.
QTPU-04	UM shall validate that a received <b>QTP-SR</b> or <b>QTP-FR</b> conforms to all <b>QTP-SR</b> or <b>QTP-FR</b> syntactic validation requirements specified in table 6-27 and table 6-29, respectively. If the return fails any of the syntactic validation requirements, UM shall process the message set containing the syntactically invalid return in accordance with the Invoker Requirements for Two-Phase Operation Procedures.
QTPU-05	UM shall validate that a received <b>QTP-SR</b> or <b>QTP-FR</b> conforms to all <b>QTP-SR</b> or <b>QTP-FR</b> service management validation requirements specified in table 6-27 and table 6-29, respectively. If the return fails any of the service management validation requirements, UM shall process the service management invalid return in accordance with the Invoker Requirements for Two-Phase Operation Procedures.
QTPU-06	If the <b>OrbitBilateralMessage</b> data set is used in the <b>QTP-SR</b> , then UM shall validate that the <b>OrbitBilateralMessage</b> data set composition and relationship requirements for the format indicated by parameter <code>bilateralTrajectoryFormatId</code> are met. [service management validation]

### 6.5.3.2 CM Requirements for the QUERY\_TRAJECTORY\_PREDICTION Operation

The CM requirements for the **QTP** operation are defined in table 6-24.

**Table 6-24: CM Requirements for the QTP Operation**

QTPC-01	CM shall conform to all Performer Requirements for Two-Phase Operation Procedures as specified in 3.4.2.5.2.
QTPC-02	CM shall conform to all <b>QTP-SR</b> and <b>QTP-FR</b> Data Set Composition and Relationship Requirements when creating and transmitting a <b>QTP-SR</b> and <b>QTP-FR</b> , as specified in table 6-27 and table 6-29, respectively.
QTPC-03	CM shall validate that a received <b>QTP-I</b> conforms to all <b>QTP-I</b> syntactic validation requirements specified in table 6-25, Data Set Composition and Relationship Requirements for the <b>QTP-I</b> . If the <b>QTP-I</b> fails any of the syntactic requirements, CM shall process the message set containing the syntactically invalid invocation in accordance with the Performer Requirements for Two-Phase Operation Procedures.
QTPC-04	CM shall validate that the <b>QTP-I</b> conforms to all <b>QTP-I</b> service management validation requirements specified in this table and table 6-25, Data Set Composition and Relationship Requirements for the <b>QTP-I</b> . If the <b>QTP-I</b> fails any of the service management requirements, CM shall cease processing the <b>QTP-I</b> and respond to UM with an <b>QTP-FR</b> message. The content of the <b>QTP-FR</b> depends on the nature of the validation failure, and is specified in table 6-28.
QTPC-05	If the Complex has locally defined <b>QTP-I</b> relationship requirements in addition to those specified in this standard, CM shall validate that the <b>QTP-I</b> conforms to all such local requirements. [service management validation]
QTPC-06	If the <b>QTP-I</b> is valid, CM shall create a copy of the requested Trajectory Prediction and return it in a <b>QTP-SR</b> . [perform operation]

## 6.5.4 QueryTrajectoryPredictionInvocation (QTP-I) MESSAGE (UM → CM)

### 6.5.4.1 General

The **QueryTrajectoryPredictionInvocation** (QTP-I) message conforms to the data set composition and relationship requirements for, and inherits the parameters of, the <<Invocation>> stereotype, as specified in 3.3.5.3.2. Figure 6-8 shows the message structure of the QTP-I as a class diagram.

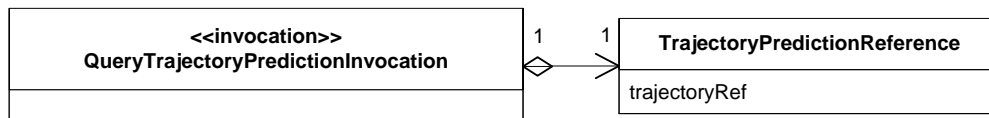

Figure 6-8: QTP-I Message Structure Class Diagram

### 6.5.4.2 Parameters

The **TrajectoryPredictionReference** data set is defined in table 6-12.

### 6.5.4.3 Data Set Composition and Relationship Requirements for QTP-I

Table 6-25 defines the data set composition and relationship requirements for the QTP-I message.

Table 6-25: Data Set Composition and Relationship Requirements for QTP-I

QTPD-01	The QTP-I shall contain one <b>TrajectoryPredictionReference</b> data set. [syntactic validation]
QTPD-02	The trajectoryRef parameter shall match the trajectoryId of the Trajectory Prediction to be retrieved by this operation. [service management validation]

## 6.5.5 QueryTrajectoryPredictionSuccessfulReturn (QTP-SR) MESSAGE (CM → UM)

### 6.5.5.1 General

The **QueryTrajectoryPredictionSuccessfulReturn** (QTP-SR) message conforms to the data set composition and relationship requirements for, and inherits the parameters of, the <<SuccessfulReturn>> stereotype, as specified in 3.3.5.3.3.2. Figure 6-9 shows the message structure of the QTP-SR as a class diagram.

6.5.5.2 Parameters

The **TrajectoryPredictionReference** data set is defined in table 6-12.

The **TrajectoryPredictionStorage** data set is defined in table 6-13.

The **TrajectoryPredictionSegment** data set is defined in table 6-5.

The **OrbitParameterMessageText** data set is defined in table 6-6.

The **OrbitParameterMessageXml** data set is defined in table 6-7.

The **OrbitEphemerisMessageText** data set is defined in table 6-8.

The **OrbitEphemerisMessageXml** data set is defined in table 6-9.

The **OrbitBilateralMessage** data set is defined in table 6-10.

The **ReferencingServicePackage** data set is defined in table 6-26.

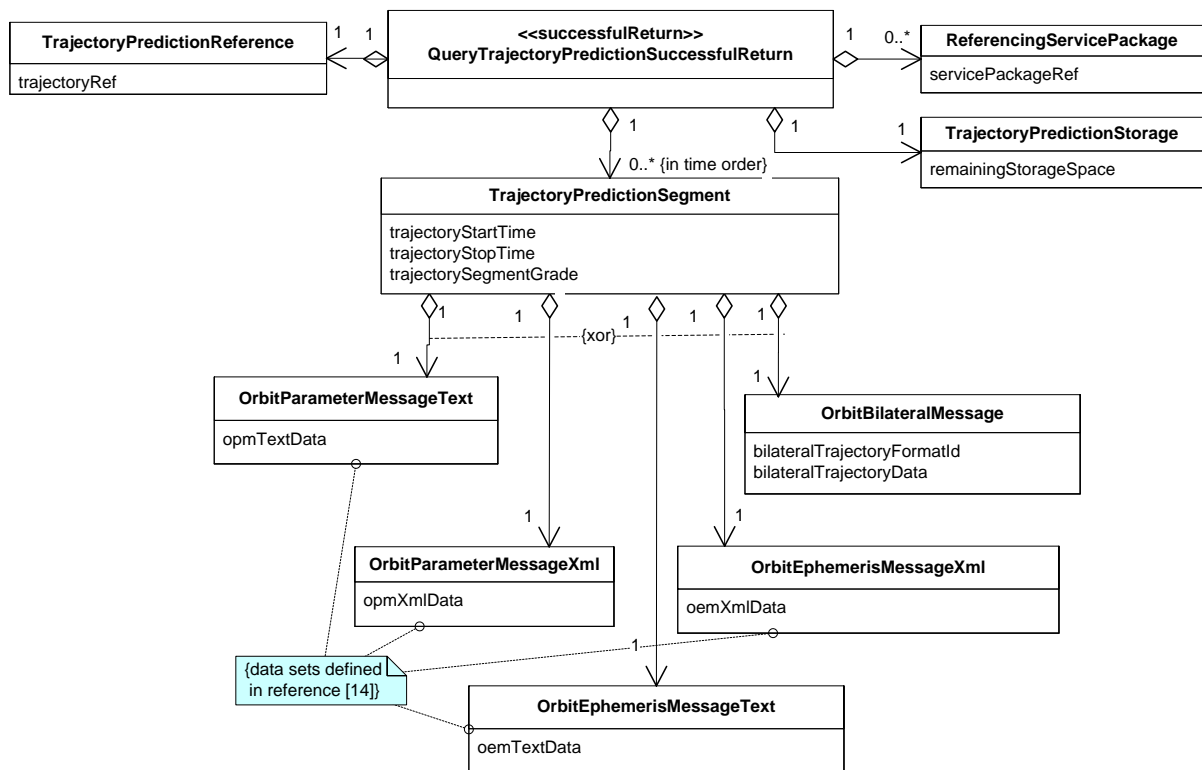

Figure 6-9: QTP-SR Message Structure Class Diagram

**Table 6-26: ReferencingServicePackage Data Set**

Name	Definition/Description	Data Type	Units	Applicable Service Agreement Parameter
servicePackageRef	A pending or executing Service Package that references the queried Trajectory Prediction. NOTE – There is one ReferencingServicePackage data set for each such referencing Service Package.	String256	n/a	n/a

### 6.5.5.3 Data Set Composition and Relationship Requirements

Table 6-27 defines the data set composition and relationship requirements for the **QTP-SR** message.

**Table 6-27: Data Set Composition and Relationship Requirements for QTP-SR**

QTPD-03	The <b>QTP-SR</b> shall contain: a) one <b>TrajectoryPredictionReference</b> data set; b) one <b>TrajectoryPredictionStorage</b> data set; c) zero or more <b>ReferencingServicePackage</b> data sets; d) zero or more <b>TrajectoryPredictionSegment</b> data sets. [syntactic validation]
QTPD-04	The value of the trajectoryRef parameter shall be the same as the value of the trajectoryRef of the <b>QTP-I</b> to which this return responds. [service management validation]
QTPD-05	ATP data set composition and relationship requirements ATPD-02, ATPD-03, ATPD-05, ATPD-06, ATPD-07, ATPD-09, and ATPD-10 apply to the <b>QTP-SR</b> message.
QTPD-06	The <b>TrajectoryPredictionSegment</b> data sets shall be ordered in trajectoryStartTime-increasing order. [service management validation]
QTPD-07	The trajectoryStopTime of the each <b>TrajectoryPredictionSegment</b> data set in the <b>QTP-SR</b> shall be less than or equal to the trajectoryStartTime of the <b>TrajectoryPredictionSegment</b> data set that follows it. [service management validation]

## 6.5.6 QueryTrajectoryPredictionFailedReturn (QTP-FR) MESSAGE (CM → UM)

### 6.5.6.1 General

The **QueryTrajectoryPredictionFailedReturn (QTP-FR)** message conforms to the data set composition and relationship requirements for, and inherits the parameters of, the <<FailedReturn>> stereotype, as specified in table 3-10. The **QtpError** data set of the **QTP-FR** message conforms to and inherits the parameters of the <<Error>> data set stereotype, which contains a diagnostic parameter of the <<ErrorDiagnostic>> stereotype.

Figure 6-10 shows the message structure of the **QTP-FR** as a class diagram.

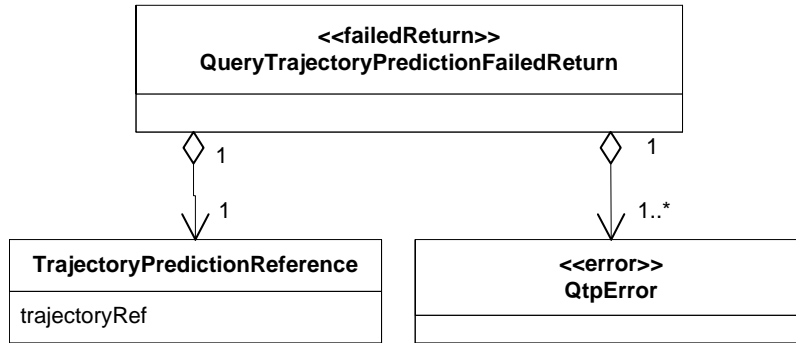

**Figure 6-10: QTP-FR Message Structure Class Diagram**

### 6.5.6.2 Parameters

The **TrajectoryPredictionReference** data set is defined in table 6-12.

Table 6-28 defines the additional values of the diagnostic parameter for the **QtpError** data set, identifies the CM and data set composition service management requirements that result in that diagnostic value being returned, and identifies the contents of the erroredItem and additionalInformation parameters that accompany each diagnostic value.

**Table 6-28: QtpError Data Set diagnostic Parameter Definition**

diagnostic value	Definition/Description	Rqmt	Content of erroredItem	Content of additional-Information
'operation timeout'	When the operation cannot be completed before the disposition timer expires.	2PP-0103b in table 3-32	not applicable	not required
'trajectoryRef non-existent'	No Trajectory Prediction with this identifier is currently available at CM for the referenced Service Agreement.	QTPD-01	trajectoryRef	not required
'other'	The operation has failed due to an error that is local to the Service Agreement.	QTPC-05	The invalid parameter or data set that causes the violation	Text-string description of the local error



### 6.5.6.3 Data Set Composition and Relationship Requirements

Table 6-29 defines the data set composition and relationship requirements for the **QTP-FR** message that are in addition to those of the <<FailedReturn>> stereotype.

**Table 6-29: Data Set Composition and Relationship Requirements for QTP-FR**

QTPD-08	The <b>QTP-FR</b> shall contain one <b>TrajectoryPredictionReference</b> data set. [syntactic validation]
QTPD-09	The value of the <code>trajectoryRef</code> parameter shall be the same as the value of the <code>trajectoryRef</code> of the <b>QTP-I</b> to which this return responds. [service management validation]

## 6.6 EXTEND\_TRAJECTORY\_PREDICTION (ETP) OPERATION

### 6.6.1 PURPOSE

The **EXTEND\_TRAJECTORY\_PREDICTION (ETP)** operation allows UM to extend a Trajectory Prediction that is already available at a CM.

### 6.6.2 PROCEDURE

**6.6.2.1** The ETP operation is defined to be a two-phase operation in accordance with the operation procedure pattern specified in 3.4.1.

**6.6.2.2** The ETP operation is defined in terms of the following messages:

- **ExtendTrajectoryPredictionInvocation (ETP-I);**
- **ExtendTrajectoryPredictionSuccessfulReturn (ETP-SR);**
- **ExtendTrajectoryPredictionFailedReturn (ETP-FR).**

**6.6.2.3** The message sequence diagram for the **EXTEND\_TRAJECTORY\_PREDICTION** operation is defined by applying the following argument list to the stereotyped sequence diagram for the two-phase operation procedure pattern specified in 3.4.1.2:

```
twoPhaseOperationProcedurePatternSequence {UM, CM, ETP-I, ETP-SR,  
                                         ETP-FR}
```

**6.6.2.4** The activity diagram for the **EXTEND\_TRAJECTORY\_PREDICTION** operation is defined by applying the following argument list to the stereotyped activity diagram for the two-phase operation procedure pattern specified in 3.4.1.4:

```
twoPhaseOperationProcedurePatternActivity {UM, CM, ETP-I, ETP-SR,  
                                           ETP-FR, etpRoutineTimeout,  
                                           etpUrgentTimeout}
```

### 6.6.3 REQUIREMENTS

#### 6.6.3.1 UM Requirements for the **EXTEND\_TRAJECTORY\_PREDICTION** Operation

The UM requirements for the **ETP** operation are defined in table 6-30.

**Table 6-30: UM Requirements for the ETP Operation**

ETPU-1	UM shall conform to all Invoker Requirements for Two-Phase Operation Procedures as specified in 3.4.2.5.1.
ETPU-2	UM shall conform to all ETP-I Data Set Composition and Relationship Requirements when creating and transmitting a ETP-I as specified in table 6-33.
ETPU-3	UM should submit ETP-I messages that are valid with respect to all service management validation requirements for CM as defined in table 6-30.
ETPU-4	UM shall validate that a received ETP-SR or ETP-FR conforms to all ETP-SR or ETP-FR syntactic validation requirements specified in table 6-34 or table 6-36, respectively. If the return fails any of the syntactic validation requirements, UM shall process the message set containing the syntactically invalid return in accordance with the Invoker Requirements for Two-Phase Operation Procedures.
ETPU-5	UM shall validate that a received ETP-SR or ETP-FR conforms to all ETP-SR or ETP-FR service management validation requirements specified in table 6-34 or table 6-36, respectively. If the return fails any of the service management validation requirements, UM shall process the service management-invalid return in accordance with the Invoker Requirements for Two-Phase Operation Procedures.

### 6.6.3.2 CM Requirements for the **EXTEND\_TRAJECTORY\_PREDICTION** Operation

The CM requirements for the **ETP** operation are defined in table 6-31.

**Table 6-31: CM Requirements for the ETP Operation**

ETPC-1	CM shall conform to CM requirements for the ATP operation specified in ATPC-1 and ATPC-5 through ATPC-14, with the substitution of <b>ETP-I</b> , <b>ETP-SR</b> , and <b>ETP-FR</b> for <b>ETP-I</b> , <b>ETP-SR</b> , and <b>ETP-FR</b> , respectively.
ETPC-2	CM shall validate that a received ETP-I conforms to all ETP-I syntactic validation requirements specified in table 6-33, Data Set Composition and Relationship Requirements for the ETP-I. If the ETP-I fails any of the syntactic requirements, CM shall process the message set containing the syntactically invalid invocation in accordance with the Performer Requirements for Two-Phase Operation Procedures.
ETPC-3	CM shall validate that a received ETP-I conforms to all ETP-I service management validation requirements specified in this table and table 6-33, Data Set Composition and Relationship Requirements for the ETP-I. If the ETP-I fails any of the service management requirements, CM shall process the message set containing the service management-invalid invocation in accordance with the Performer Requirements for Two-Phase Operation Procedures.
ETPC-4	CM shall validate that the Trajectory Prediction referenced by the <code>trajectoryRef</code> parameter of the <b>ETP-I</b> is available at CM. [service management validation]
ETPC-5	If <code>checkContinuity</code> is true, CM shall validate that the extension segment is continuous with the available Trajectory Prediction at the <code>trajectoryStartTime</code> of the extension segment. NOTE – The measurement of continuity is bilaterally defined. [service management validation]
ETPC-6	If <code>enforceOwnership</code> is 'true' in the Service Agreement, CM shall validate that the <code>SmSource</code> associated with the <b>ETP-I</b> is the name of the owner of the Trajectory Prediction associated with the <code>trajectoryId</code> referenced by the <code>trajectoryRef</code> in the <b>ETP-I</b> . [service management validation]
ETPC-7	If the ETP fails, CM shall retain the available Trajectory Prediction as it existed without the attempted extension.
ETPC-8	CM shall conform to all <b>ETP-AR</b> , <b>ETP-SR</b> , and <b>ETP-FR</b> Data Set Composition and Relationship Requirements when creating and returning a ETP-SR (see table 6-34) and ETP-FR (see table 6-36).

### 6.6.4 ExtendTrajectoryPredictionInvocation (ETP-I) MESSAGE (UM → CM)

#### 6.6.4.1 General

The **ExtendTrajectoryPredictionInvocation (ETP-I)** message conforms to the data set composition and relationship requirements for, and inherits the parameters of, the <<Invocation>> stereotype as specified in 3.3.5.3.2. Figure 6-11 shows the structure of the **ETP-I** message as a class diagram.

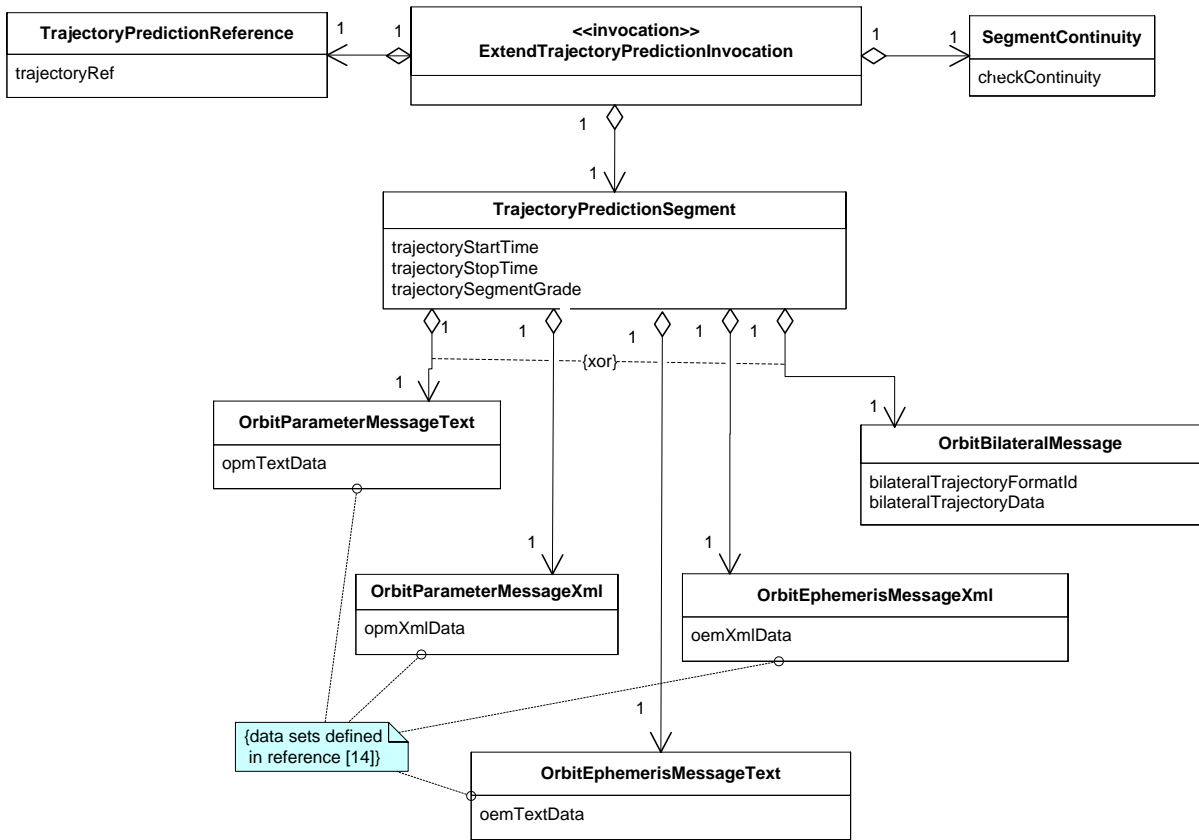

Figure 6-11: ETP-I Message Structure Presented in a Class Diagram

#### 6.6.4.2 Parameters

The **TrajectoryPredictionReference** data set is defined in table 6-12.

The **TrajectoryPredictionSegment** data set is defined in table 6-5.

The **OrbitParameterMessageText** data set is defined in table 6-6.

The **OrbitParameterMessageXml** data set is defined in table 6-7.

The **OrbitEphemerisMessageText** data set is defined in table 6-8.

The **OrbitEphemerisMessageXml** data set is defined in table 6-9.

The **OrbitBilateralMessage** data set is defined in table 6-10.

The **SegmentContinuity** data set is defined in table 6-32.

**Table 6-32: SegmentContinuity Data Set**

Name	Definition/Description	Data Type	Units	Applicable Service Agreement Parameter
checkContinuity	Specifies whether the continuity of the segment with the available Trajectory Prediction is to be validated.	Boolean	n/a	n/a

#### 6.6.4.3 Data Set Composition and Relationship Requirements

Table 6-33 defines the data set composition and relationship requirements for the **ETP-I** message.

**Table 6-33: Data Set Composition and Relationship Requirements for ETP-I**

ETPD-1	The <b>ETP-I</b> shall contain <ul style="list-style-type: none"> <li>a) one <b>TrajectoryPredictionReference</b> data set;</li> <li>b) one <b>SegmentContinuity</b> data set; and</li> <li>c) one <b>TrajectoryPredictionSegment</b> data set.</li> </ul> [syntactic validation]
ETPD-2	The ETP-I shall conform to Data Set Composition and Relationship Requirements ATPD-02 through ATPD-14 (table 6-10).
ETPD-3	The <b>trajectoryStopTime</b> shall have a value that is later than the stop time of the available Trajectory Prediction that is being extended. [service management validation]

**6.6.5 ExtendTrajectoryPredictionSuccessfulReturn (ETP-SR) MESSAGE (CM →UM)**

**6.6.5.1 General**

The **ExtendTrajectoryPredictionSuccessfulReturn (ETP-SR)** message conforms to the data set composition and relationship requirements for, and inherits the parameters of, the <<SuccessfulReturn>> stereotype, as specified in 3.3.5.3.3.2. Figure 6-12 shows the message structure of the **ETP-SR** as a class diagram.

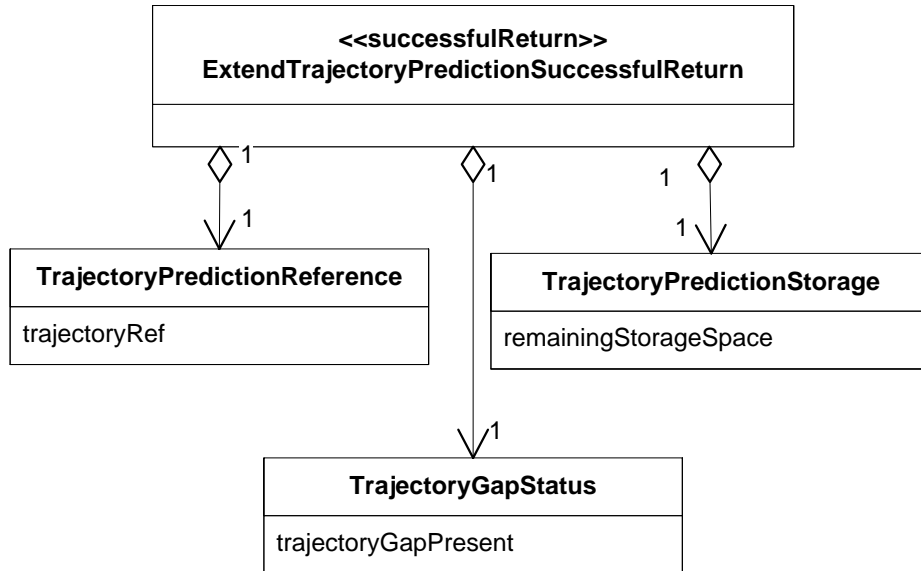

**Figure 6-12: ETP-SR Message Structure Presented in a Class Diagram**

**6.6.5.2 Parameters**

The **TrajectoryPredictionReference** data set is defined in table 6-12.

The **TrajectoryPredictionStorage** data set is defined in table 6-13.

The **TrajectoryGapStatus** data set is defined in table 6-34.

**Table 6-34: TrajectoryGapStatus Data Set**

Name	Definition/Description	Data Type	Units	Applicable Service Agreement Parameter
trajectoryGapPresent	Has a 'true' value if the trajectoryStartTime of the segment is greater than the stop time of the available Trajectory Prediction that the segment is intended to extend.	Boolean	n/a	n/a

### 6.6.5.3 Data Set Composition and Relationship Requirements for ETP-SR

Table 6-35 defines the data set composition and relationship requirements for the **ETP-SR** message that are in addition to those of the <<SuccessfulReturn>> stereotype.

**Table 6-35: Data Set Composition and Relationship Requirements for ETP-SR**

ETPD-4	The <b>ExtendTrajectoryPredictionSuccessfulReturn</b> message shall contain a) one <b>TrajectoryPredictionReference</b> data set; and b) one <b>TrajectoryPredictionStorage</b> data set. [syntactic validation]
ETPD-5	For the <b>TrajectoryPredictionReference</b> data set, the trajectoryRef shall have the same value as the trajectoryRef parameter of the corresponding <b>ETP-I</b> . [service management validation]

### 6.6.6 ExtendTrajectoryPredictionFailedReturn (ETP-FR) MESSAGE (CM → UM)

#### 6.6.6.1 General

The **ExtendTrajectoryPredictionFailedReturn (ETP-FR)** message conforms to the data set composition and relationship requirements for, and inherits the parameters of, the <<FailedReturn>> stereotype, as specified in table 3-10. The **EtpError** data set of the **ETP-FR** message conforms to and inherits the parameters of the <<Error>> data set stereotype, which contains a diagnostic parameter of the <<ErrorDiagnostic>> stereotype.

The class diagram for the **ExtendTrajectoryPredictionFailedReturn** message structure is shown in figure 6-13.

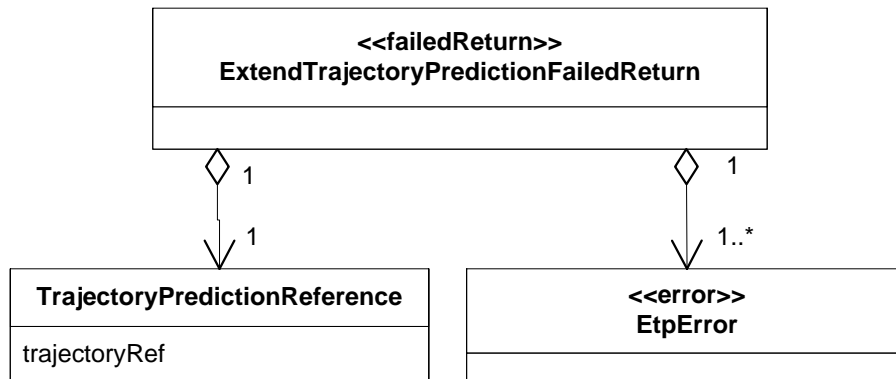

**Figure 6-13: ETP-FR Message Structure Class Diagram**

### 6.6.6.2 Parameters

The **TrajectoryPredictionReference** data set is defined in table 6-12.

The **EtpError** dataset of the **TrajectoryPredictionFailedReturn** message conforms to the data set composition and relationship requirements for, and inherits the parameters of, the <<Error>> data set stereotype, which contains a diagnostic parameter of the <<ErrorDiagnostic>> stereotype. The **EtpError** data set diagnostic parameter includes the same values as **AtpError** data set diagnostic parameter values defined in table 6-34, with the exclusion of the 'trajectoryId already in use' value.

In addition to the diagnostic values that are shared with the **AtpError** data set, the **EtpError** data set has additional diagnostic values. Table 6-36 defines the additional values of the diagnostic parameter for the **AtpError** data set, identifies the CM and data set composition service management requirements that result in that diagnostic value being returned, and identifies the contents of the erroredItem that accompanies each diagnostic value.

**Table 6-36: Additional EtpError Data Set diagnostic Parameter Definition**

diagnostic value	Definition/Description	Rqmt	Parameter or Data Set Identified by erroredItem	Content of additional Information
'discontinuous extension'	The extension segment is not continuous with the available Trajectory Prediction at the trajectoryStartTime of the extension segment.	ETPC-5	trajectory-StartTime	n/a
'incomplete extension'	The extension segment has a trajectoryStopTime that is earlier than or equal to the stop time of the available Trajectory Prediction that is to be extended.	ETPD-3	trajectory-StopTime	Stop time (UTC) of the Trajectory Prediction that is attempted to be extended.
'trajectoryRef non-existent'	No Trajectory Prediction with this identifier is currently available at CM for the referenced Service Agreement.	ETPC-4	trajectoryRef	n/a
'smSource not the owner'	The value of the smSource for the <b>SmMessageSet</b> containing the <b>ETP-I</b> is not the owner of the target Trajectory Prediction.	ETPC-6	smSource	n/a



### 6.6.6.3 Data Set Composition and Relationship Requirements

Table 6-37 defines the data set composition and relationship requirements for **ETP-FR** messages that are in addition to those of the <<FailedReturn>> stereotype.

**Table 6-37: Data Set Composition and Relationship Requirements for ETP-FR**

ETPD-6	<p>The <b>ETP-FR</b> message shall contain:</p> <ul style="list-style-type: none"> <li>a) one <b>TrajectoryPredictionReference</b> data set;</li> <li>b) one or more <b>EtpError</b> data sets.</li> </ul> <p>[syntactic validation]</p>
ETPD-7	<p>The trajectoryRef parameter shall contain the same value as the trajectoryRef parameter in the corresponding <b>ETP-I</b>.</p> <p>[service management validation]</p>

## 7 SERVICE AGREEMENT OPERATIONS

### 7.1 GENERAL

There is only one Service Agreement operation that can be invoked by UM:

- `QUERY_SERVICE_AGREEMENT`—to query the content of a Service Agreement that is currently available at CM.

No Service Agreement operations can be invoked by CM.

The means and procedures for the creation of a Service Agreement are currently outside the scope of this Recommended Standard.

No state machine is defined for the Service Agreement lifecycle, since there is no change of state defined within this Recommended Standard. The `QUERY_SERVICE_AGREEMENT` operation may be invoked at any time while the service agreement is active.

Subsection 7.3 below defines the `QUERY_SERVICE_AGREEMENT` operation.

### 7.2 OWNERSHIP OF SERVICE AGREEMENTS

Each Service Agreement shall be mutually owned by both UM and CM. No specific SM entity name is associated with ownership of the Service Agreement, because no operations exist for creation, modification, or deletion of a Service Agreement.

### 7.3 `QUERY_SERVICE_AGREEMENT` (QSA) OPERATION

#### 7.3.1 PURPOSE

The `QUERY_SERVICE_AGREEMENT` (QSA) operation allows UM to query the CM for the status of an existing Service Agreement.

#### 7.3.2 PROCEDURE

**7.3.2.1** The QSA operation is defined to be a two-phase operation in accordance with the operation procedure pattern specified in 3.4.1.

**7.3.2.2** The QSA operation is defined in terms of the following messages:

- `QueryServiceAgreementInvocation` (QSA-I);
- `QueryServiceAgreementSuccessfulReturn` (QSA-SR);
- `QueryServiceAgreementFailedReturn` (QSA-FR).

**7.3.2.3** The message sequence diagram for the `QUERY_SERVICE_AGREEMENT` operation is defined by applying the following argument list to the stereotyped sequence diagram for the two-phase operation procedure pattern specified in 3.4.1.2:

```
twoPhaseOperationProcedurePatternSequence {UM, CM, QSA-I, QSA-SR,
QSA-FR}
```

**7.3.2.4** The activity diagram for the `QUERY_SERVICE_AGREEMENT` operation is defined by applying the following argument list to the stereotyped activity diagram for the two-phase operation procedure pattern specified in 3.4.1.4:

```
twoPhaseOperationProcedurePatternActivity {UM, CM, QSA-I, QSA-SR,
QSA-FR, qsaRoutineTimeout,
qsaUrgentTimeout}
```

### 7.3.3 REQUIREMENTS

#### 7.3.3.1 UM Requirements for the `QUERY_SERVICE_AGREEMENT` Operation

The UM requirements for the `QSA` operation are defined in table 7-1.

**Table 7-1: UM Requirements for the `QSA` Operation**

QSAU-01	UM shall conform to all Invoker Requirements for Two-Phase Operation Procedures as specified in 3.4.1.5.1.
QSAU-02	UM shall validate that a received <code>QSA-SR</code> conforms to all <code>QSA-SR</code> syntactic validation requirements specified in table 7-53. If the return fails any of the syntactic validation requirements, UM shall process the message set containing the syntactically invalid return in accordance with the Invoker Requirements for Two-Phase Operation Procedures.
QSAU-03	UM shall validate that a received <code>QSA-SR</code> conforms to all <code>QSA-SR</code> service management validation requirements specified in table 7-53. If the return fails any of the service management validation requirements, UM shall process the service management-invalid return in accordance with the Invoker Requirements for Two-Phase Operation Procedures.
QSAU-04	If the <code>BilateralServiceAgreement</code> data set is used in the <code>QSA-SR</code> , then UM shall validate that the <code>BilateralServiceAgreement</code> data set composition and relationship requirements for the format indicated by parameter <code>bilateralServiceAgreementFormatId</code> are met. [service management validation]

### 7.3.3.2 CM Requirements for the **QUERY\_SERVICE\_AGREEMENT** Operation

The CM requirements for the **QSA** operation are defined in table 7-2.

**Table 7-2: CM Requirements for the **QSA** Operation**

QSAC-01	CM shall conform to all Performer Requirements for Two-Phase Operation Procedures as specified in 3.4.1.5.2.
QSAC-02	CM shall conform to all <b>QSA-SR</b> Data Set Composition and Relationship Requirements when creating and transmitting a <b>QSA-SR</b> , as specified in table 7-53.
QSAC-03	If the Complex has locally defined <b>QSA-I</b> relationship requirements in addition to those specified in this standard, CM shall validate that the <b>QSA-I</b> conforms to all such local requirements.
QSAC-04	If the <b>QSA-I</b> is valid, CM shall create a copy of the requested Service Agreement and return it in a <b>QSA-SR</b> message. [perform operation]

### 7.3.4 **QueryServiceAgreementInvocation (QSA-I) MESSAGE (UM → CM)**

#### 7.3.4.1 General

Figure 7-1 shows the message structure of the **QSA-I** message as a class diagram.



**Figure 7-1: **QSA-I** Message Structure Class Diagram**

#### 7.3.4.2 Parameters

The **QueryServiceAgreementInvocation (QSA-I)** message conforms to the data set composition and relationship requirements for, and inherits the parameters of, the **<<Invocation>>** stereotype, as specified in 3.3.5.3.2.

The **QSA-I** message does not contain any specific parameters as it relies on the value of the parameter **serviceAgreementRef** of the **SmMessageSet** data set, as defined in 3.3.5.2.

#### 7.3.4.3 Data Set Composition and Relationship Requirements

There are no specific data set composition and relationship requirements for **QSA-I**. The identification of the requested Service Agreement is conveyed by the containing SM message set.

### 7.3.5 QueryServiceAgreementSuccessfulReturn (QSA-SR) MESSAGE (CM→UM)

#### 7.3.5.1 General

The structure of the QueryServiceAgreementSuccessfulReturn (QSA-SR) message is presented in the class diagram of figures 7-2 and 7-3.

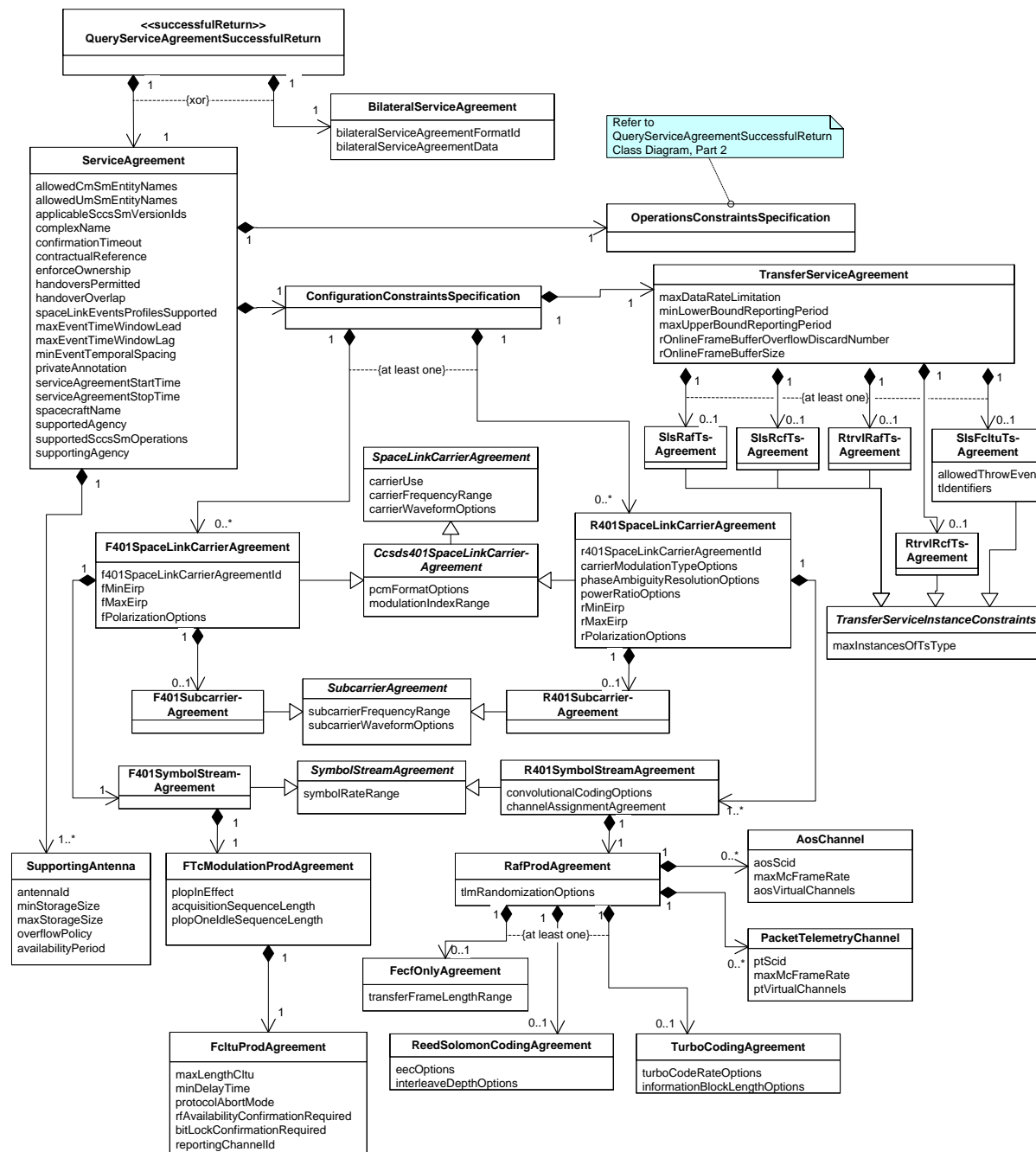

Figure 7-2: QSA-SR Message Structure Class Diagram, Part 1 of 2

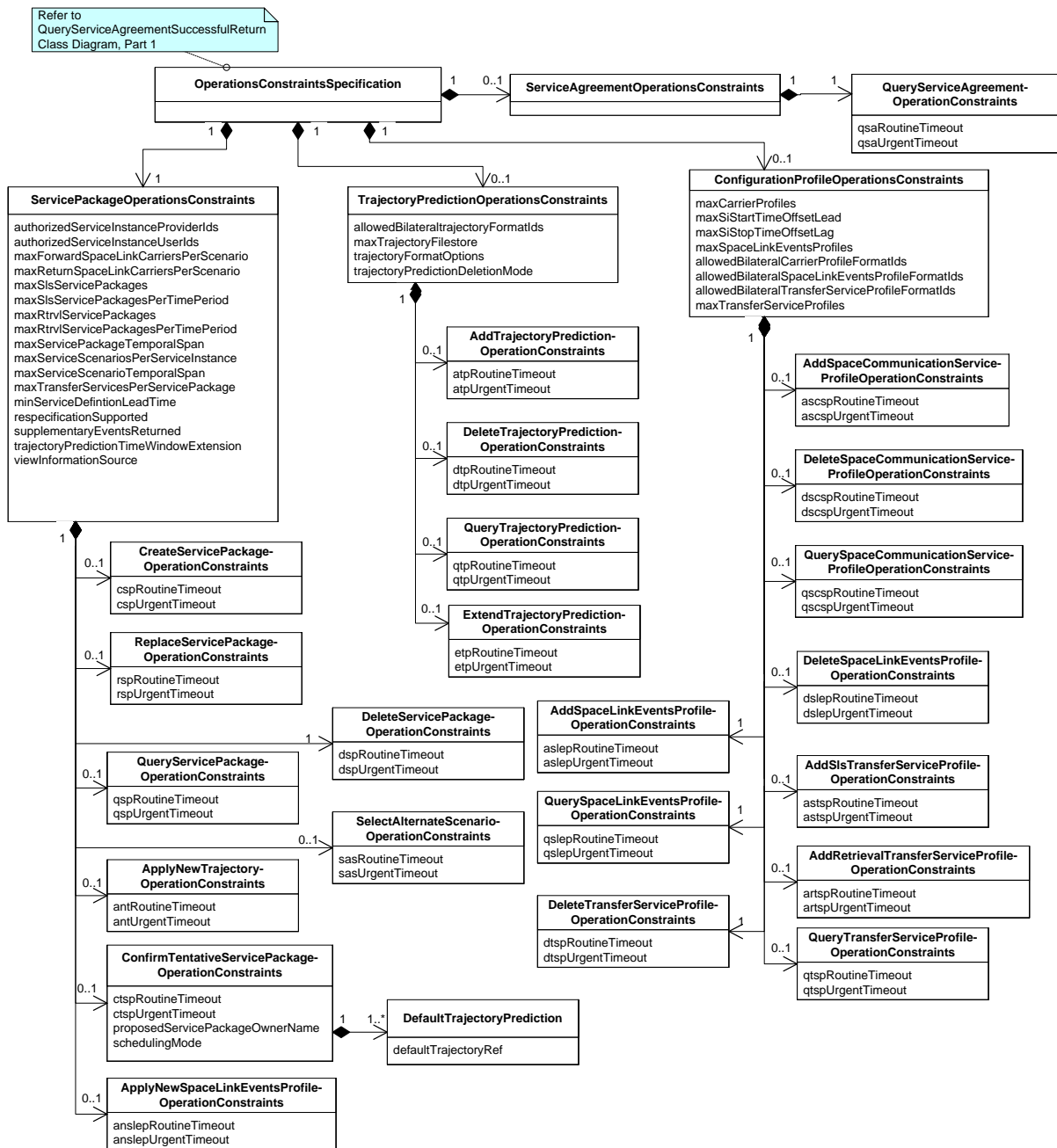

Figure 7-3: QSA-SR Message Structure Class Diagram, Part 2 of 2 (Operations Constraints Specification)

### 7.3.5.2 Parameters

The **QueryServiceAgreementSuccessfulReturn (QSA-SR)** message conforms to the data set composition and relationship requirements for, and inherits the parameters of, the <<SuccessfulReturn>> stereotype, as specified in 3.3.5.3.3.2. It also adds data sets to communicate the successful results of the QSA operation.

The parameters for the **QueryServiceAgreementSuccessfulReturn (QSA-SR)** message are described in table 7-3 through table 7-52. Although they are part of the **QSA-SR** message, the following data sets merely serve as containers for other data sets and have no parameters of their own, and therefore do not have table definitions:

- **ConfigurationConstraintsSpecification** data set;
- **OperationsConstraintsSpecification** data set; and
- **ServiceAgreementOperationsConstraintsSpecification** data set.

**Table 7-3: ServiceAgreement Data Set**

Name	Definition/Description	Data Type	Units
allowedCmSmEntityNames	List of SM Entity names that CM is allowed to use to identify itself in SM documents under the Service Agreement; i.e., these are the valid values for parameter <b>smSource</b> in the <b>SmMessageSet</b> (3.3.5.2), <b>InvalidInvocationResponse</b> (3.3.5.4), and <b>InvalidNotificationResponse</b> (3.3.5.4) generated by CM.  NOTE – This is also the list of SM Entity names that UM may use as the value of <b>smDestination</b> in SM documents sent to CM.	list of String256	n/a
allowedUmSmEntityNames	List of SM entity names that UM is allowed to use to identify itself SM documents under the Service Agreement; i.e., these are the valid values for parameter <b>smSource</b> in the <b>SmMessageSet</b> (3.3.5.2), <b>InvalidInvocationResponse</b> (3.3.5.4), and <b>InvalidNotificationResponse</b> (3.3.5.4) generated by UM.  NOTE – This is also the list of SM Entity names that CM may use as the value of <b>smDestination</b> in SM documents sent to UM.	list of String256	n/a
applicableSccsSmVersionIds	List of SM Service Specification version identifiers supported by the Service Agreement, i.e., these are the allowed values for parameter <b>sccsSmVersionRef</b> in the <b>SmMessageSet</b> (3.3.5.2) and <b>SmExceptionResponse</b> (3.3.5.4) data sets.	list of String256	n/a
complexName	Name of the Complex that shall provide space communication cross support services. Unique within UM and CM domains.	String256	n/a
confirmationTimeout	Maximum time interval the Notifier shall wait for a confirmation message after issuing a notification message as part of the confirmed notification procedure pattern (3.4.3).	Unsigned Integer	seconds

Name	Definition/Description	Data Type	Units
contractualReference	<p>References to list of contractually binding documents, which together shall provide the framework for the cross support activity and the enabling information for interaction between UM and CM. The documents in this list shall include (but not be limited to):</p> <ul style="list-style-type: none"> <li>– the definition of the allowed values of the importance parameter of CREATE_SERVICE_PACKAGE and REPLACE_SERVICE_PACKAGE invocations;</li> <li>– specification of the GMSK filter that is to be applied when GMSK modulation is used on a space link carrier;</li> <li>– if respecification of configuration profile parameter values in Service Package Requests is supported, specification of which parameters of which configuration profile types may be respecified;</li> <li>– if any Failed Return may have a diagnostic or reason parameter with value of 'other', the list of text-string values for the additional-Information parameters, and the local definitions of those values.</li> </ul>	list of String256	n/a
enforceOwnership	<p>Indicates whether ownership is to be enforced.</p> <ul style="list-style-type: none"> <li>– If 'true', CM is to permit only the owner of an information entity to replace and/or delete that information;</li> <li>– If 'false' an information entity can be replaced or deleted by any SM entity named in the allowedUmSmEntityNames of the Service Agreement.</li> </ul>	Boolean	n/a
spaceLinkEvents-ProfilesSupported	<p>Indicates whether Space Link Events Profiles are supported by the Service Agreement. If set to 'true', both the inclusion (by reference) of Space Link Events Profiles in the CSP and RSP operations and in the Space Link Events Profile operations (i.e., ADD_SPACE_LINK_EVENTS_PROFILE [ASLEP], DELETE_SPACE_LINK_EVENTS_PROFILE [DSLEP], and QUERY_SPACE_LINK_EVENTS_PROFILE [QSLEP]) are supported.</p>	Boolean	n/a
maxEventTimeWindowLead	<p>Maximum value allowed for the parameter eventTimeWindowLead in any <b>R   FSpaceLinkChangeEvent</b> or <b>R   FSpaceLinkDataTransportChangeEvent</b> data set (see 5.6.4.2). This parameter is only required if Space Link Events Profiles are supported by the Service Agreement. If Space Link Events Profiles are not supported, this parameter shall have null content.</p>	Unsigned Integer or NULL	seconds



Name	Definition/Description	Data Type	Units
maxEventTimeWindowLag	Maximum value allowed for the parameter eventTimeWindowLag in any <b>R   FSpaceLinkChangeEvent</b> or <b>R   FSpaceLinkDataTransportChangeEvent</b> data set (see 5.6.4.2). This parameter is only required if Space Link Events Profiles are supported by the Service Agreement. If Space Link Events Profiles are not supported, this parameter shall have null content.	Unsigned Integer or NULL	seconds
handoversPermitted-Agreement	Indicates whether the Service Agreement allows serial utilization of antennas to satisfy the requirements of Space Communication Service Requests: <ul style="list-style-type: none"> <li>– ‘true’—Service Packages may be satisfied by using two or more antennas per Space Communication Service Request;</li> <li>– ‘false’—CM must use a single antenna per Space Communication Service Request.</li> </ul>	Boolean	n/a
handoverOverlap	Minimum time overlap for multiple CarrierResult data sets that have the same carrierProfileRef value. If handoversPermittedAgreement is false, this parameter shall have the value NULL.	Unsigned Integer or NULL	seconds
privateAnnotation	Field to hold any required additional information related to the Service Agreement. If there is no private annotation information, the privateAnnotation parameter shall have null content.	String or NULL	n/a
serviceAgreementStart-Time	Date and time that the Service Agreement period starts.	UTC	n/a
serviceAgreementStop-Time	Date and time that the Service Agreement period ends.	UTC	n/a
spacecraftName	Name of the supported spacecraft. Unique within UM and CM domains.	String256	n/a
supportedAgency	Identifier of the supported Agency. Unique within UM and CM domains.	String256	n/a

Name	Definition/Description	Data Type	Units
supportedSccsSm-Operations	<p>Set of operations supported by the Service Agreement. It represents a set containing any combination of the following values, with no repeated components:</p> <ul style="list-style-type: none"> <li>– ‘CREATE_SERVICE_PACKAGE’;</li> <li>– ‘REPLACE_SERVICE_PACKAGE’;</li> <li>– ‘DELETE_SERVICE_PACKAGE’;</li> <li>– ‘QUERY_SERVICE_PACKAGE’;</li> <li>– ‘SELECT_ALTERNATE_SCENARIO’;</li> <li>– ‘APPLY_NEW_TRAJECTORY’;</li> <li>– ‘SERVICE_PACKAGE_MODIFIED’;</li> <li>– ‘SERVICE_PACKAGE_CANCELLED’;</li> <li>– ‘APPLY_NEW_SPACE_LINK_EVENTS_PROFILE’;</li> <li>– ‘ADD_SPACE_COMMUNICATION_SERVICE_PROFILE’;</li> <li>– ‘DELETE_SPACE_COMMUNICATION_SERVICE_PROFILE’;</li> <li>– ‘QUERY_SPACE_COMMUNICATION_SERVICE_PROFILE’;</li> <li>– ‘CONFIRM_TENTATIVE_SERVICE_PACKAGE’;</li> <li>– ‘ADD_SPACE_LINK_EVENTS_PROFILE’;</li> <li>– ‘DELETE_SPACE_LINK_EVENTS_PROFILE’;</li> <li>– ‘QUERY_SPACE_LINK_EVENTS_PROFILE’;</li> <li>– ‘ADD_SLS_TRANSFER_SERVICE_PROFILE’;</li> <li>– ‘ADD_RETRIEVAL_TRANSFER_SERVICE_PROFILE’;</li> <li>– ‘QUERY_TRANSFER_SERVICE_PROFILE’;</li> <li>– ‘DELETE_TRANSFER_SERVICE_PROFILE’;</li> <li>– ‘ADD_TRAJECTORY_PREDICTION’;</li> <li>– ‘DELETE_TRAJECTORY_PREDICTION’;</li> <li>– ‘QUERY_TRAJECTORY_PREDICTION’;</li> <li>– ‘EXTEND_TRAJECTORY_PREDICTION’;</li> <li>– ‘QUERY_SERVICE_AGREEMENT’.</li> </ul> <p>The set shall contain at least the following components:</p> <ul style="list-style-type: none"> <li>– ‘DELETE_SERVICE_PACKAGE’;</li> <li>– ‘SERVICE_PACKAGE_CANCELLED’;</li> <li>– One or both of: <ul style="list-style-type: none"> <li>– ‘CREATE_SERVICE_PACKAGE’;</li> <li>– ‘CONFIRM_TENTATIVE_SERVICE_PACKAGE’.</li> </ul> </li> </ul> <p>The minimum set matches the requirements for minimum compliance (see annex B).</p>	set of enumerated values	n/a
supportingAgency	Identifier of the supporting Agency. Unique within UM and CM domains.	String256	n/a
minEventTemporalSpacing	Minimum allowed time between Space Link Events.	Unsigned integer	Seconds

**Table 7-4: SupportingAntenna Data Set**

Name	Definition/Description	Data Type	Units
antennaId	Identifier to be used for this antenna.	String256	n/a
availabilityPeriod	Minimum period that the Complex is required to retain the stored data before it is automatically purged. If retrieval not supported at this antenna, the value shall be zero.	Unsigned Integer	days
minStorageSize	The minimum storage guaranteed at that location. If retrieval not supported at this antenna, the value shall be zero.	Unsigned Integer	Mega-Octets
maxStorageSize	The maximum storage that can be used by the mission at this antenna. If retrieval not supported at this antenna, the value shall be zero.	Unsigned Integer	Mega-Octets
overflowPolicy	The policy that shall be applied when new data is available to be stored but the storage space allocated to this mission is full. The values are: <ul style="list-style-type: none"> <li>– ‘fifo’: The new data is to replace an equal amount of the oldest in the data store;</li> <li>– ‘discard overflow data’: The new data is to be rejected until the space is freed due to the automatic purging of stored data at the expiration of its availability period;</li> <li>– ‘not applicable’: Used when retrieval is not supported at this antenna.</li> </ul>	Enum	n/a

**Table 7-5: ServicePackageOperationsConstraints Data Set**

Name	Definition/Description	Data Type	Units
authorizedService-InstanceProviderIds	List of valid values for the parameter providerId in the <b>SlsTsInstanceResult</b> and <b>RetrievalTsInstanceResult</b> data sets. Length of each string is restricted to [3..16] characters.	list of String [3..16]	n/a
authorizedService-InstanceUserIds	List of valid values for the parameter userId in the <b>SlsTsInstanceResult</b> , <b>RetrievalTsInstanceResult</b> , <b>FcltuTransferServiceProfile</b> , <b>RafTransferServiceProfile</b> , <b>RcfTransferServiceProfile</b> , <b>OfflineRafTsProfile</b> , and <b>OfflineRcfTsProfile</b> data sets. Length of each string is restricted to [3..16] characters.	list of String [3..16]	n/a
maxForwardSpaceLink-CarriersPerScenario	Maximum number of forward space link carriers that may be contained (by reference) within a single Service Scenario.	Unsigned Integer	n/a
maxReturnSpaceLink-CarriersPerScenario	Maximum number of return space link carriers that may be contained (by reference) within a single Service Scenario.	Unsigned Integer	n/a
maxSlsServicePackages	Maximum number of SLS Transfer Service Packages allowed in the context of the Service Agreement.	Unsigned Integer	n/a

Name	Definition/Description	Data Type	Units
maxSlsServicePackages-PerTimePeriod	Maximum number of SLS Transfer Service Packages allowed within a time period. Composed of two elements: (numberServicePackages, numberDays).	(Unsigned Integer, Unsigned Integer)	(n/a, days)
maxRtrvlServicePackages	Maximum number of Retrieval Transfer Service Packages allowed in the context of the Service Agreement.	Unsigned Integer	n/a
maxRtrvlService-PackagesPerTimePeriod	Maximum number of Retrieval Transfer Service Packages allowed within a time period. Composed of two elements: (numberServicePackages, numberDays).	(Unsigned Integer, Unsigned Integer)	(n/a, days)
maxServicePackage-TemporalSpan	Maximum allowed time interval between the earliest scheduledSpaceCommServiceStartTime and the latest scheduledSpaceComm-ServiceStopTime within a Service Package.	Unsigned Integer	seconds
maxServiceScenarios-PerServicePackage	Maximum number of <b>ServiceScenario</b> data sets allowed in a Service Package.	Unsigned Integer	n/a
maxServiceScenario-TemporalSpan	Maximum allowed time interval between the earliest scheduledSpaceCommServiceStartTime and the latest scheduledSpaceComm-ServiceStopTime within any <b>Service-Scenario</b> data set within a Service Package.	Unsigned Integer	seconds
maxTransferServices-PerServicePackage	Maximum total number of <b>SlsTsInstance-Result</b> and <b>BilateralSlsTsInstance-Result</b> data sets in a Service Package.	Unsigned Integer	n/a
minServiceDefinition-LeadTime	Minimum time interval before the start of the Service Package utilization phase by which the Service Package shall be fully defined.	Unsigned Integer	seconds
respecification-Supported	Indicates if respecification of Space Communication Service Profiles and Transfer Service Profiles is permitted in Service Package Requests. NOTE – If respecification is supported, the ContractualReference parameter shall identify which parameters of which configuration profile types may be respecified.	Boolean	
supplementaryEvents-Returned	Indicates if CM might return additional event information in ServicePackageResults that might affect the carrier or data transport states involved in a space link session.	Boolean	n/a
trajectoryPrediction-TimeWindowExtension	Specifies the amount of time prior to the scheduledServicePackageStartTime and following the scheduledServicePackageStopTime for which a Trajectory Prediction must be available in order to be used to generate acquisition data to support the Service Package.	Unsigned Integer	seconds
viewInformationSource	Indicates the source of visibility information in schedule generation: – ‘trajectory prediction’; – ‘bilaterally defined scheduling aids’.	Enum	n/a

**Table 7-6: CreateServicePackageOperationConstraints Data Set**

Name	Definition/Description	Data Type	Units
cspRoutineTimeout	Value of routineThreePhaseTimeout for the CREATE_SERVICE_PACKAGE operation.	Unsigned Integer	seconds
cspUrgentTimeout	Value of urgentThreePhaseTimeout for the CREATE_SERVICE_PACKAGE operation.	Unsigned Integer	seconds

**Table 7-7: ReplaceServicePackageOperationConstraints Data Set**

Name	Definition/Description	Data Type	Units
rspRoutineTimeout	Value of routineThreePhaseTimeout for the REPLACE_SERVICE_PACKAGE operation.	Unsigned Integer	seconds
rspUrgentTimeout	Value of urgentThreePhaseTimeout for the REPLACE_SERVICE_PACKAGE operation.	Unsigned Integer	seconds

**Table 7-8: DeleteServicePackageOperationConstraints Data Set**

Name	Definition/Description	Data Type	Units
dspRoutineTimeout	Value of routineTwoPhaseTimeout for the DELETE_SERVICE_PACKAGE operation.	Unsigned Integer	seconds
dspUrgentTimeout	Value of urgentTwoPhaseTimeout for the DELETE_SERVICE_PACKAGE operation.	Unsigned Integer	seconds

**Table 7-9: QueryServicePackageOperationConstraints Data Set**

Name	Definition/Description	Data Type	Units
qspRoutineTimeout	Value of routineTwoPhaseTimeout for the QUERY_SERVICE_PACKAGE operation.	Unsigned Integer	seconds
qspUrgentTimeout	Value of urgentTwoPhaseTimeout for the QUERY_SERVICE_PACKAGE operation.	Unsigned Integer	seconds

**Table 7-10: selectAlternateScenarioOperationConstraints Data Set**

Name	Definition/Description	Data Type	Units
sasRoutineTimeout	Value of routineTwoPhaseTimeout for the SELECT_ALTERNATE_SCENARIO operation.	Unsigned Integer	seconds
sasUrgentTimeout	Value of urgentTwoPhaseTimeout for the SELECT_ALTERNATE_SCENARIO operation.	Unsigned Integer	seconds

**Table 7-11: ApplyNewTrajectoryOperationConstraints Data Set**

Name	Definition/Description	Data Type	Units
antRoutineTimeout	Value of routineThreePhaseTimeout for the APPLY_NEW_TRAJECTORY operation.	Unsigned Integer	seconds
antUrgentTimeout	Value of urgentThreePhaseTimeout for the APPLY_NEW_TRAJECTORY operation.	Unsigned Integer	seconds

**Table 7-12: ConfirmTentativeServicePackageOperationConstraints Data Set**

Name	Definition/Description	Data Type	Units
ctspRoutineTimeout	Value of routineThreePhaseTimeout for the CONFIRM_TENTATIVE_SERVICE_PACKAGE operation.	Unsigned Integer	seconds
ctspUrgentTimeout	Value of urgentThreePhaseTimeout for the CONFIRM_TENTATIVE_SERVICE_PACKAGE operation.	Unsigned Integer	seconds
proposedServicePackage-OwnerName	Name of the UM entity to be used when a service Package is created by CM via a rule-based process and proposed to UM via an invocation of the CONFIRM_TENTATIVE_SERVICE_PACKAGE operation.	String256	n/a
schedulingMode	The status of a tentative Service Package at CM while awaiting the response from UM: <ul style="list-style-type: none"> <li>– ‘committed’—The Service Package has been placed on the CM schedule, and shall be removed only if and when UM returns a <b>CTSP-FR</b>;</li> <li>– ‘provisional’—The Service Package shall be added to the CM schedule only if and when UM returns a <b>CTSP-SR</b>.</li> </ul>	Enum	n/a

**Table 7-13: ApplyNewSpaceLinkEventsProfileOperationConstraints Data Set**

Name	Definition/Description	Data Type	Units
anslepRoutineTimeout	Value of routineThreePhaseTimeout for the Apply_New_Space_Link_Events_Profile operation.	Unsigned Integer	seconds
anslepUrgentTimeout	Value of urgentThreePhaseTimeout for the Apply_New_Space_Link_Events_Profile operation.	Unsigned Integer	seconds

**Table 7-14: DefaultTrajectoryPrediction Data Set**

Name	Definition/Description	Data Type	Units
defaultTrajectoryRef	Name of a Trajectory Prediction to be used in generating rule-based Service Packages.	String256	n/a

**Table 7-15: TrajectoryPredictionOperationsConstraints Data Set**

Name	Definition/Description	Data Type	Units
allowedBilateral-TrajectoryFormatIds	List of allowed bi-laterally agreed trajectory formats. It represents the list of allowed values for parameter <code>bilateralTrajectoryFormatId</code> (6.3.4).	list of String256 or NULL	n/a
maxSizeTrajectoryFile-store	Maximum size of the Trajectory Prediction storage area in the Complex.	Unsigned Integer	Mbytes
trajectoryFormatOptions	Set of Trajectory Prediction formats allowed for the Service Agreement. It represents a set containing any combination of the following values, with no repeated components: <ul style="list-style-type: none"> <li>– ‘opmText’—Orbit Parameter Message (OPM) format in plain text;</li> <li>– ‘opmXml’—Orbit Parameter Message (OPM) format in XML;</li> <li>– ‘oemText’—Orbit Ephemeris Message (OEM) format in plain text;</li> <li>– ‘oemXml’—Orbit Ephemeris Message (OEM) format in XML;</li> <li>– ‘obm’—Orbit Bilateral Message, for formats other than OPM and OEM.</li> </ul> The set shall contain at least one component.	set of enumerated values	n/a
trajectoryPrediction-DeletionMode	Specifies the behavior of the Complex when TP segments expire: <ul style="list-style-type: none"> <li>– ‘invoked deletion only’—Each Trajectory Prediction retains the contents of all of its TP segments until the TP is deleted via the DTP operation;</li> <li>– ‘auto TP deletion’—Each TP segment is automatically removed from the available TP when its period of applicability expires, and the TP itself is automatically deleted when the last available segment expires;</li> <li>– ‘auto segment deletion’—Each TP segment is automatically removed from the available TP when its period of applicability expires, but the TP itself remains available even though it may have no content.</li> </ul>	Enum	n/a

**Table 7-16: AddTrajectoryPredictionOperationConstraints Data Set**

Name	Definition/Description	Data Type	Units
atpRoutineTimeout	Value of <code>routineTwoPhaseTimeout</code> for the <code>ADD_TRAJECTORY_PREDICTION</code> operation.	Unsigned Integer	seconds
atpUrgentTimeout	Value of <code>urgentTwoPhaseTimeout</code> for the <code>ADD_TRAJECTORY_PREDICTION</code> operation.	Unsigned Integer	seconds

**Table 7-17: DeleteTrajectoryPredictionOperationConstraints Data Set**

<b>Name</b>	<b>Definition/Description</b>	<b>Data Type</b>	<b>Units</b>
ntpRoutineTimeout	Value of routineTwoPhaseTimeout for the DELETE_TRAJECTORY_PREDICTION operation.	Unsigned Integer	seconds
ntpUrgentTimeout	Value of urgentTwoPhaseTimeout for the DELETE_TRAJECTORY_PREDICTION operation.	Unsigned Integer	seconds

**Table 7-18: ExtendTrajectoryPredictionOperationConstraints Data Set**

<b>Name</b>	<b>Definition/Description</b>	<b>Data Type</b>	<b>Units</b>
etpRoutineTimeout	Value of routineTwoPhaseTimeout for the EXTEND_TRAJECTORY_PREDICTION operation.	Unsigned Integer	seconds
etpUrgentTimeout	Value of urgentTwoPhaseTimeout for the EXTEND_TRAJECTORY_PREDICTION operation.	Unsigned Integer	seconds

**Table 7-19: QueryTrajectoryPredictionOperationConstraints Data Set**

<b>Name</b>	<b>Definition/Description</b>	<b>Data Type</b>	<b>Units</b>
qtpRoutineTimeout	Value of routineTwoPhaseTimeout for the QUERY_TRAJECTORY_PREDICTION operation.	Unsigned Integer	seconds
qtpUrgentTimeout	Value of urgentTwoPhaseTimeout for the QUERY_TRAJECTORY_PREDICTION operation.	Unsigned Integer	seconds



**Table 7-20: ConfigurationProfileOperationsConstraints Data Set**

<b>Name</b>	<b>Definition/Description</b>	<b>Data Type</b>	<b>Units</b>
allowedBilateral-CarrierProfileFormatIds	List of values allowed for the <code>bilateralCarrierProfileFormatId</code> parameter, if bilateral space link carrier profiles are supported; otherwise, this parameter shall be NULL.	list of String256 or NULL	n/a
allowedBilateral-TransferServiceProfile-FormatIds	List of values allowed for the <code>bilateralTransferServiceProfile-FormatId</code> parameter, if bilateral transfer service profiles are supported; otherwise, this parameter shall be NULL.	list of String256 or NULL	n/a
allowedBilateralSpace-LinkEventsProfile-FormatIds	List of values allowed for the <code>bilateralSpaceLinkEventsProfileFormatId</code> parameter, if bilateral space link events profiles are supported; otherwise, this parameter shall be NULL.	list of String256 or NULL	n/a
maxCarrierProfiles	Maximum allowed number of <b>CarrierProfile</b> data sets for this <b>ServiceAgreement</b> at any given time.	Unsigned Integer	n/a
maxSiStartTimeOffset-Lead	Maximum allowed lead time offset value for parameter <code>startTimeOffset</code> in any SLS Transfer Service Profile. NOTE –This constraint only applies to <code>startTimeOffset</code> values less than zero, in which case the absolute value of <code>startTimeOffset</code> is used to evaluate against this constraint.	Unsigned Integer	seconds
maxSiStopTimeOffsetLag	Maximum allowed lag time offset value for parameter <code>stopTimeOffset</code> in any SLS Transfer Service Profile.	Unsigned Integer	seconds
maxSpaceLinkEvents-Profiles	Maximum allowed number of Space Link Events Profiles for this <b>ServiceAgreement</b> at any given time.	Unsigned Integer	n/a
maxTransferService-Profiles	Maximum allowed number of Transfer Service Profiles for this <b>ServiceAgreement</b> at any given time.	Unsigned Integer	n/a

**Table 7-21: AddSpaceCommunicationServiceProfileOperation-Constraints Data Set**

<b>Name</b>	<b>Definition/Description</b>	<b>Data Type</b>	<b>Units</b>
ascspRoutineTimeout	Value of <code>routineThreePhaseTimeout</code> for the <code>ADD_SPACE_COMMUNICATION_SERVICE_-PROFILE</code> operation.	Unsigned Integer	seconds
ascspUrgentTimeout	Value of <code>urgentThreePhaseTimeout</code> for the <code>ADD_SPACE_COMMUNICATION_SERVICE_-PROFILE</code> operation.	Unsigned Integer	seconds

**Table 7-22: DeleteSpaceCommunicationServiceProfileOperation-Constraints Data Set**

Name	Definition/Description	Data Type	Units
dscspRoutineTimeout	Value of routineTwoPhaseTimeout for the DELETE_SPACE_COMMUNICATION_SERVICE_-PROFILE operation.	Unsigned Integer	seconds
dscspUrgentTimeout	Value of urgentTwoPhaseTimeout for the DELETE_SPACE_COMMUNICATION_SERVICE_-PROFILE operation.	Unsigned Integer	seconds

**Table 7-23: QuerySpaceCommunicationServiceProfileOperation-Constraints Data Set**

Name	Definition/Description	Data Type	Units
qscspRoutineTimeout	Value of routineTwoPhaseTimeout) for the QUERY_SPACE_COMMUNICATION_SERVICE_-PROFILE operation.	Unsigned Integer	seconds
qscspUrgentTimeout	Value of urgentTwoPhaseTimeout for the QUERY_SPACE_COMMUNICATION_SERVICE_-PROFILE operation.	Unsigned Integer	seconds

**Table 7-24: AddSpaceLinkEventsProfileOperationConstraints Data Set**

Name	Definition/Description	Data Type	Units
aslepRoutineTimeout	Value of routineTwoPhaseTimeout for the ADD_SPACE_LINK_EVENTS_PROFILE operation.	Unsigned Integer	seconds
aslepUrgentTimeout	Value of urgentTwoPhaseTimeout for the ADD_SPACE_LINK_EVENTS_PROFILE operation.	Unsigned Integer	seconds

**Table 7-25: DeleteSpaceLinkEventsProfileOperationConstraints Data Set**

Name	Definition/Description	Data Type	Units
dslepRoutineTimeout	Value of routineTwoPhaseTimeout for the DELETE_SPACE_LINK_EVENTS_PROFILE operation.	Unsigned Integer	seconds
dslepUrgentTimeout	Value of urgentTwoPhaseTimeout for the DELETE_SPACE_LINK_EVENTS_PROFILE operation.	Unsigned Integer	seconds

**Table 7-26: QuerySpaceLinkEventsProfileOperationConstraints Data Set**

Name	Definition/Description	Data Type	Units
qslepRoutineTimeout	Value of routineTwoPhaseTimeout for the QUERY_SPACE_LINK_EVENTS_PROFILE operation.	Unsigned Integer	seconds
qslepUrgentTimeout	Value of urgentTwoPhaseTimeout for the QUERY_SPACE_LINK_EVENTS_PROFILE operation.	Unsigned Integer	seconds

**Table 7-27: AddSlsTransferServiceProfileOperationConstraints Data Set**

Name	Definition/Description	Data Type	Units
astpRoutineTimeout	Value of routineTwoPhaseTimeout for the ADD_SLS_TRANSFER_SERVICE_PROFILE operation.	Unsigned Integer	seconds
astpUrgentTimeout	Value of urgentTwoPhaseTimeout for the ADD_SLS_TRANSFER_SERVICE_PROFILE operation.	Unsigned Integer	seconds

**Table 7-28: AddRetrievalTransferServiceProfileOperation-Constraints Data Set**

Name	Definition/Description	Data Type	Units
artpRoutineTimeout	Value of routineTwoPhaseTimeout for the ADD_RETRIEVAL_TRANSFER_SERVICE_PROFILE operation.	Unsigned Integer	seconds
artpUrgentTimeout	Value of urgentTwoPhaseTimeout for the ADD_RETRIEVAL_TRANSFER_SERVICE_PROFILE operation.	Unsigned Integer	seconds

**Table 7-29: QueryTransferServiceProfileOperationConstraints Data Set**

Name	Definition/Description	Data Type	Units
qtspRoutineTimeout	Value of routineTwoPhaseTimeout for the QUERY_TRANSFER_SERVICE_PROFILE operation.	Unsigned Integer	seconds
qtspUrgentTimeout	Value of urgentTwoPhaseTimeout for the QUERY_TRANSFER_SERVICE_PROFILE operation.	Unsigned Integer	seconds

**Table 7-30: DeleteTransferServiceProfileOperationConstraints  
DataSet**

<b>Name</b>	<b>Definition/Description</b>	<b>Data Type</b>	<b>Units</b>
dtspRoutineTimeout	Value of routineTwoPhaseTimeout for the DELETE_TRANSFER_SERVICE_PROFILE operation.	Unsigned Integer	seconds
dtspUrgentTimeout	Value of urgentTwoPhaseTimeout for the DELETE_TRANSFER_SERVICE_PROFILE operation.	Unsigned Integer	seconds

**Table 7-31: QueryServiceAgreementOperationConstraints Data Set**

<b>Name</b>	<b>Definition/Description</b>	<b>Data Type</b>	<b>Units</b>
qsaRoutineTimeout	Value of routineTwoPhaseTimeout for the QUERY_SERVICE_AGREEMENT operation.	Unsigned Integer	seconds
qsaUrgentTimeout	Value of urgentTwoPhaseTimeout for the QUERY_SERVICE_AGREEMENT operation.	Unsigned Integer	seconds

**Table 7-32: F401SpaceLinkCarrierAgreement Data Set**

Name	Definition/Description	Data Type	Units
carrierFrequencyRange	The minimum and maximum nominal (not Doppler-corrected) values for the carrier frequency allowed during the Service Agreement period. Composed of two elements (minCarrierFrequency, maxCarrierFrequency).	pair of Unsigned Integers	Hz
carrierUse	The carrier usage to be applied to the carrier during the Service Agreement period t. Possible values: <ul style="list-style-type: none"> <li>– ‘remnant’—remnant carrier (phase modulation);</li> <li>– ‘suppressed’—suppressed carrier.</li> </ul>	Enum	n/a
carrierWaveformOptions	The set of waveforms that the carrier may use during the Service Agreement period. Possible values: <ul style="list-style-type: none"> <li>– ‘sine’—sine wave;</li> <li>– ‘square’—square wave.</li> </ul>	set of enumerated values	n/a
fmaxEirp	The maximum allowed value for the EIRP transmitted to the spacecraft.	Integer	dBm
fminEirp	The minimum allowed value for the EIRP transmitted to the spacecraft.	Integer	dBm
f401SpaceLinkCarrier-AgreementId	Identifier of <b>F401SpaceLinkCarrier-Agreement</b> data set, unique within <b>ServiceAgreement</b> data set.	String256	n/a
fPolarizationOptions	Set of nominal polarization of the RF carrier that shall be available during the Service Agreement period. It represents a set containing any combination of the following values, with no repeated components: <ul style="list-style-type: none"> <li>– ‘LinearHorizontal’;</li> <li>– ‘LinearVertical’;</li> <li>– ‘RCP’—right-hand circular polarization;</li> <li>– ‘LCP’—left-hand circular polarization.</li> </ul> The set shall contain at least one component.	set of enumerated values	n/a
modulationIndexRange	If carrierUse has the value ‘remnant’, the range on the angle by which the RF carrier is phase-shifted with respect to the un-modulated RF carrier that shall apply throughout the Service Agreement period. Composed of two elements (lowerBound, upperBound). If carrierUse has the value ‘suppressed’, NULL.	pair of Unsigned Integers or NULL	milli-radians
pcmFormatOptions	Set of PCM formats that may be modulated onto the carrier or subcarrier during the Service Agreement period. It contains any combination of the following values, with no repeated components: <ul style="list-style-type: none"> <li>– ‘NRZ-L’—no return to zero-level;</li> <li>– ‘NRZ-M’—no return to zero-mark;</li> <li>– ‘SP-L’—split phase level.</li> </ul> The set shall contain at least one component.	set of enumerated values	n/a

**Table 7-33: F401SubcarrierAgreement Data Set**

Name	Definition/Description	Data Type	Units
subcarrierFrequency-Range	The minimum and maximum values for the subcarrier frequency allowed during the Service Agreement period.	pair of Unsigned Integers	Hz
subcarrierWaveform-Options	The subcarrier waveforms that shall be used during the Service Agreement period. It contains any combination of the following values, with no repeated components: <ul style="list-style-type: none"> <li>– ‘sine’—sine wave;</li> <li>– ‘square’—square wave.</li> </ul> The set shall contain at least one component.	set of enumerated values	n/a

**Table 7-34: F401SymbolStreamAgreement Data Set**

Name	Definition/Description	Data Type	Units
symbolRateRange	The minimum and maximum values for the symbol rate to be expected on this symbol stream during the Service Agreement period. Composed of two elements (minSymbolRate, maxSymbolRate).	pair of Unsigned Integers	milli-symbols/second

**Table 7-35: FTcModulationProdAgreement Data Set**

Name	Definition/Description	Data Type	Units
acquisitionSequence-Length	The length of the acquisition sequence used in Telecommand Carrier Modulation Mode (CMM) 2. The default value is 16.	Unsigned Integer	bits
plopOneIdleSequence-Length	The length of the Idle Sequence to be used in Carrier Modulation Mode (CMM) 4 when PLOP-1 is used. Meaningful only if parameter plopInEffect is equal to ‘plop-1’. If plopInEffect = ‘plop-2’, the parameter shall be NULL.	Unsigned Integer in range [0..2040] or NULL	bits
plopInEffect	Used to specify the Physical Layer Operations Procedure (PLOP) to be used on the modulation channel. Possible enumeration values: <ul style="list-style-type: none"> <li>– ‘plop-1’;</li> <li>– ‘plop-2’.</li> </ul>	Enum	n/a

Table 7-36: FcltuProdAgreement Data Set

Name	Definition/Description	Data Type	Unit
bitLockConfirmation-Required	Indicates whether the 'No Bit Lock' flag in the CLCW affects the determination of the FCLTU production state. Possible enumeration values: <ul style="list-style-type: none"> <li>– 'clcwUsed'—the 'No Bit Lock' flag in the CLCW must indicate bit lock in order for the FCLTU production state to transition to, or remain, 'operational';</li> <li>– 'clcwNotUsed'—the 'No Bit Lock' flag in the CLCW shall not be used to determine the FCLTU production state.</li> </ul>	Enum	n/a
maxLengthCltu	The maximum length of the CLTUs that are carried by the CLTU data channel.	Unsigned Integer	octets
minDelayTime	The minimum value allowed for the delay-time parameter of the TRANSFER-DATA invocations carried by the transfer service instance.	Unsigned Integer	micro-seconds
protocolAbortMode	Indicates whether transmission of buffered CLTUs shall be continued following a protocol abort of the forward SLE transfer service instance(s) supplying the input data for this CLTU data channel. Possible enumeration values: <ul style="list-style-type: none"> <li>– 'flush'—all buffered CLTUs are to be discarded;</li> <li>– 'continue'—all buffered CLTUs are to be transmitted.</li> </ul>	Enum	n/a
reportingChannelId	The channelId value of the master channel or virtual channel that carries the CLCWs that report on this forward space link carrier associated with the FCLTU service instance, where channelId =gvcid mcid. <ul style="list-style-type: none"> <li>– gVcId = (vn, scid, vcid) triplet, where: <ul style="list-style-type: none"> <li>• vn (transfer frame version number) = Integer [0..1];</li> <li>• scid (spacecraft identifier) = Integer in the range of [0..1023] for vn = 0 and in the range of [0..255] for vn = 1;</li> <li>• vcid (virtual channel identifier) = Integer in the range of [0..63] for vn = 0 and in the range of [0..255] for vn = 1;</li> </ul> </li> <li>– 'mcId' = (vn, scid) pair, where vn and scid are as defined above.</li> </ul> If there is no CLCW related to this forward carrier, then the parameter is NULL.	channelId or NULL	n/a
rfAvailability-ConfirmationRequired	Indicates whether the 'No RF Available' flag in the CLCW affects the determination of the FCLTU production state. Possible enumeration values: <ul style="list-style-type: none"> <li>– 'clcwUsed'—the 'No RF Available' flag in the CLCW must indicate RF availability in order for the FCLTU production state to transition to, or remain, 'operational';</li> <li>– 'clcwNotUsed'—the 'No RF Available' in the CLCW shall not be used to determine the FCLTU production state.</li> </ul>	Enum	n/a

**Table 7-37: R401SpaceLinkCarrierAgreement Data Set**

Name	Definition/Description	Data Type	Units
carrierFrequencyRange	Defined in table 7-32.		
carrierUse	Defined in table 7-32.		
carrierWaveformOptions	Defined in table 7-32.		
modulationIndexRange	Defined in table 7-32.		
carrierModulationType-Options	Set of modulation types that shall be available for the RF carrier during the Service Agreement period. It represents a set containing any combination of the following values, with no repeated components: <ul style="list-style-type: none"> <li>– ‘BPSK’—Binary Phase Shift Key;</li> <li>– ‘QPSK’—Quaternary Phase Shift Key;</li> <li>– ‘UQPSK’—Unbalanced Quaternary Phase Shift Key;</li> <li>– ‘OQPSK’—Offset Quaternary Phase Shift Key;</li> <li>– ‘GMSK’—Gaussian Minimum Shift Key;</li> <li>– ‘PCM/PM’—Pulse Code Modulation/Phase Modulation;</li> <li>– ‘8PSK’—Square Root Raised Cosine filtered 4-Dimensional 8 PSK Trellis Coded Modulation;</li> <li>– ‘unmodulated’ – The carrier does not have data directly modulated onto it.</li> </ul>	set of enumerated values	n/a
pcmFormatOptions	Defined in table 7-32.		
powerRatioOptions	Set of ratios between the power of the I-channel and the Q-channel in the UQPSK modulation that shall be available during the Service Agreement period. The allowed values are: <ul style="list-style-type: none"> <li>– ‘three’;</li> <li>– ‘four’;</li> <li>– ‘five’;</li> <li>– ‘six’;</li> <li>– ‘seven’;</li> <li>– ‘eight’;</li> <li>– ‘nine’;</li> <li>– ‘ten’;</li> <li>– ‘eleven’;</li> <li>– ‘twelve’.</li> </ul> If UQPSK is not used, the value is NULL	set of enumerated values or NULL	n/a
r401SpaceLinkCarrier-AgreementId	Identifier <b>R401SpaceLinkCarrierAgreement</b> data set, unique within <b>ServiceAgreement</b> data set.	String256	n/a
rMaxEirp	The maximum allowed value for the EIRP received from the spacecraft.	Integer	dBm
rMinEirp	The minimum allowed value for the EIRP received from the spacecraft.	Integer	dBm



Name	Definition/Description	Data Type	Units
rPolarizationOptions	Set of nominal polarization of the RF carrier that shall be available during the Service Agreement period. It represents a set containing any combination of the following values, with no repeated components: <ul style="list-style-type: none"> <li>– ‘LinearHorizontal’;</li> <li>– ‘LinearVertical’;</li> <li>– ‘RCP’—right-hand circular polarization;</li> <li>– ‘LCP’—left-hand circular polarization;</li> <li>– ‘combined’—The polarization may be a combination of polarizations.</li> </ul> The set shall contain at least one component.	set of enumerated values	n/a

**Table 7-38: R401SubcarrierAgreement Data Set**

Name	Definition/Description	Data Type	Units
subcarrierFrequency-Range	See table 7-33.		
subcarrierWaveform-Options	See table 7-33.		

**Table 7-39: R401SymbolStreamAgreement Data Set**

Name	Definition/Description	Data Type	Units
convolutionalCoding-Options	Set of values that indicate which types of convolutional coding may be used on the symbol stream during the Service Agreement period. It represents a set containing any combination of the following values, with no repeated components: <ul style="list-style-type: none"> <li>– ‘notUsed’—the absence of convolutional coding on a symbol stream;</li> <li>– ‘rateOneHalf’—the use of rate one-half convolutional coding on a symbol stream;</li> <li>– ‘rateTwoThirds’—the use of rate one-half, punctured to two-thirds, convolutional coding;</li> <li>– ‘rateThreeQuarters’—the use of rate one-half, punctured to three-quarters, convolutional coding;</li> <li>– ‘rateFiveSixths’—the use of rate one-half, punctured to five-sixths, convolutional coding;</li> <li>– ‘rateSevenEighths’—the use of rate one-half, punctured to seven-eighths, convolutional coding.</li> </ul> The set shall contain at least one component.	set of enumerated values	n/a

Name	Definition/Description	Data Type	Units
channelAssignment-Agreement	<p>The combination of modulation type and channel used by this <b>R401SymbolStreamAgreement</b> data set. Possible values:</p> <ul style="list-style-type: none"> <li>– ‘bpskChannel’;</li> <li>– ‘qpskIChannelOnly’;</li> <li>– ‘qpskQChannelOnly’;</li> <li>– ‘qpskIChannelSeparate’;</li> <li>– ‘qpskQChannelSeparate’;</li> <li>– ‘qpskInterleaved’;</li> <li>– ‘oqpskIChannelOnly’;</li> <li>– ‘oqpskQChannelOnly’;</li> <li>– ‘oqpskIChannelSeparate’;</li> <li>– ‘oqpskQChannelSeparate’;</li> <li>– ‘oqpskInterleaved’;</li> <li>– ‘uqpskIChannelOnly’;</li> <li>– ‘uqpskQChannelOnly’;</li> <li>– ‘gmskChannel’;</li> <li>– ‘8pskChannel’;</li> <li>– ‘pcmPmChannel’;</li> <li>– ‘pcmPskPmChannel’.</li> </ul> <p>NOTES:</p> <ol style="list-style-type: none"> <li>1 The number of enumeration values determines how many <b>R401SymbolStreamAgreement</b> data sets can be contained by a <b>R401SpaceLinkCarrierAgreement</b> data set, i.e., [1..17]. Therefore, the allowed value for this parameter is restricted by the value of parameter <code>carrierModulationTypeOptions</code> in the <b>R401SpaceLinkCarrierAgreement</b> data set. For example, the value ‘qpskQChannelOnly’ is valid only if the set <code>carrierModulationTypeOptions</code> includes the enumeration value ‘QPSK’.</li> <li>2 This information is used to map uniquely the <b>R401SymbolStream</b> data sets to the <b>R401SymbolStreamAgreement</b> data sets.</li> <li>3 The values ‘bpskChannel’ through ‘pcmPmChannel’ apply only to symbol streams that are the result of carrier modulation. The value ‘pcmPskPmChannel’ applies only to symbol streams that are the result of subcarrier modulation.</li> <li>4 Refer to requirements in table 7-53.</li> </ol>	Enum	n/a
symbolRateRange	Defined in table 7-34.		

**Table 7-40: RafProdAgreement Data Set**

Name	Definition/Description	Data Type	Units
tImRandomizationOptions	Whether the use (or non-use) of pseudo-randomization on this all frames channel shall be constant or may change on a Carrier Profile basis. It represents a set containing any combination of the following values, with no repeated components: <ul style="list-style-type: none"> <li data-bbox="597 457 1148 520">– ‘tImRandomizationUsed’—pseudo-randomization used on this channel;</li> <li data-bbox="597 520 1148 583">– ‘tImRandomizationNotUsed’—pseudo-randomization <u>not</u> used on this channel.</li> </ul> The set shall contain at least one component.	set of enumerated values	n/a

**Table 7-41: FecfOnlyAgreement Data Set**

Name	Definition/Description	Data Type	Units
transferFrameLength-Range	The range of the length of CCSDS transfer frames on this all frames channel for the life of the Service Agreement. Composed of two elements (lowerBound, upperBound). <ul style="list-style-type: none"> <li data-bbox="597 909 1159 1066">– The lower bound value of 7 octets is derived from the minimum Transfer Frame Primary Header length of 6 octets plus 1 octet of Transfer Frame Data Field content (references [2] and [5]);</li> <li data-bbox="597 1066 1159 1129">– The upper bound value of 2048 octets is specified in reference [4].</li> </ul> NOTE – The length of the transfer frame does not include any Reed-Solomon check symbols that may be present.	pair of Unsigned Integers [7..2048]	octets

**Table 7-42: ReedSolomonCodingAgreement Data Set**

<b>Name</b>	<b>Definition/Description</b>	<b>Data Type</b>	<b>Units</b>
eccOptions	The set of values allowed for error-CorrectionCapability—The maximum number of errored symbols per codeword to be correctable (see reference [4]). It represents a set containing any combination of the following values, with no repeated components: <ul style="list-style-type: none"> <li>– ‘8’;</li> <li>– ‘16’.</li> </ul>	set of enumerated values	n/a
interleaveDepthOptions	The set of valid depths of interleave that may be used on this all frames channel. The set may contain any or all of the following values: <ul style="list-style-type: none"> <li>– ‘1’;</li> <li>– ‘2’;</li> <li>– ‘3’;</li> <li>– ‘4’;</li> <li>– ‘5’;</li> <li>– ‘8’.</li> </ul>	set of enumerated values	n/a

**Table 7-43: TurboCodingAgreement Data Set**

<b>Name</b>	<b>Definition/Description</b>	<b>Data Type</b>	<b>Units</b>
turboCodeRateOptions	The set of values allowed for the nominalCodeRate parameter, containing any combination of the following values, with no repeated components: <ul style="list-style-type: none"> <li>– ‘rateOneHalf’;</li> <li>– ‘rateOneThird’;</li> <li>– ‘rateOneFourth’; and</li> <li>– ‘rateOneSixth’.</li> </ul>	set of enumerated values.	n/a
informationBlockLength-Options	The set of values allowed for the information-BlockLength parameter, containing any combination of the following values, with no repeated components: <ul style="list-style-type: none"> <li>– ‘1784’;</li> <li>– ‘3568’;</li> <li>– ‘7136’;</li> <li>– ‘8920’; and</li> <li>– ‘16384’.</li> </ul>	set of enumerated values.	n/a

**Table 7-44: PacketTelemetryChannel Data Set**

Name	Definition/Description	Data Type	Units
maxMcFrameRate	The maximum rate at which the MC Frames shall be carried by the data channel. This parameter shall be NULL if the master channel as a whole cannot be acquired via any RCF transfer service instance.	Unsigned Integer or NULL	frames per second
ptScid	The spacecraft id (reference [2]).	Integer in the range [0..1023]	n/a
ptVirtualChannels	List of ptVirtualChannel, where ptVirtualChannel is a pair of the following values: <ul style="list-style-type: none"> <li>– maxVcFrameRate: is the maximum rate at which the VC Frames shall be carried by the data channel;</li> <li>– ptVcid: is the packet telemetry virtual channel id.</li> </ul> This parameter shall be NULL if none of the virtual channels in this master channel may be acquired via any RCF transfer service instance.	(List of (Unsigned Integer (maxVc-FrameRate) , Integer in the range [0..7] (ptVcid))) or NULL	(frames per second, n/a)

**Table 7-45: AosChannel Data Set**

Name	Definition/Description	Data Type	Units
aosScid	The spacecraft id (reference [5]).	Integer in the range [0..255]	n/a
aosVirtualChannels	List of aosVirtualChannel, where aosVirtualChannel is a pair of the following values: <ul style="list-style-type: none"> <li>– maxVcFrameRate: is the maximum rate at which the VC Frames shall be carried by the data channel;</li> <li>– aosVcid: is the AOS virtual channel id.</li> </ul> This parameter shall be NULL if none of the virtual channels in this master channel may be acquired via any RCF transfer service instance.	(List of (Unsigned Integer (maxVc-FrameRate) , Integer in the range [0..63] (aosVcid))) or NULL	(frames per second, n/a)
maxMcFrameRate	The maximum rate at which the MC Frames shall be carried by the data channel. This parameter shall be NULL if the master channel as a whole cannot be acquired via any RCF transfer service instance.	Unsigned Integer or NULL	frames per second

**Table 7-46: BilateralServiceAgreement Data Set**

Name	Definition/Description	Data Type	Units
bilateralService-AgreementFormatId	Identification of Service Agreement data format other than the format defined by the <b>ServiceAgreement</b> data set. This format has to be bi-laterally agreed between UM and CM.	String256	n/a
bilateralService-AgreementData	Contains the Service Agreement data in the format defined by the parameter <code>serviceAgreementBilateralFormatId</code> .	BilateralData	n/a

**Table 7-47: TransferServiceAgreement Data Set**

Name	Definition/Description	Data Type	Units
maxDataRateLimitation	The upper bound on the value of <code>dataRateLimitation</code> for any return transfer service instance in the context of the Service Agreement. If rate metering is unsupported, or if there is no limit on the rate, the parameter is NULL.	Positive Integer or NULL	bits/second
minLowerBoundReporting-Period	The minimum value that the <code>lowerBoundReportingPeriod</code> for any transfer service instance may take.	Positive Integer	seconds
maxUpperBoundReporting-Period	The maximum value that the <code>upperBoundReportingPeriod</code> for any transfer service instance may take.	Positive Integer	seconds
rOnlineFrameBuffer-OverflowDiscardNumber	The number of frames to be discarded if the return online frame buffer becomes full.	Positive Integer	frames
rOnlineFrameBufferSize	The size of the return online frame buffer for each complete online transfer service instance in the context of the Service Agreement.	Positive Integer	frames

**Table 7-48: s1sRafTsAgreement Data Set**

Name	Definition/Description	Data Type	Units
maxInstancesOfTsType	The maximum number of instances of this type of transfer service that can be supported by all Service Packages at any single time.	Positive Integer	n/a

**Table 7-49: s1sRcfTsAgreement Data Set**

Name	Definition/Description	Data Type	Units
maxInstancesOfTsType	See table 7-48.		

**Table 7-50: s1sFcltuTsAgreement Data Set**

Name	Definition/Description	Data Type	Units
maxInstancesOfTsType	See table 7-48.		
allowedThrowEvent-Identifiers	The list of numbers that are valid values for the event-identifier parameters of CLTU-THROW-EVENT operations.	list of Positive Integer	n/a

**Table 7-51: Rtrv1RafTsAgreement Data Set**

Name	Definition/Description	Data Type	Units
maxInstancesOfTsType	See table 7-48.		

**Table 7-52: Rtrv1RcfTsAgreement Data Set**

Name	Definition/Description	Data Type	Units
maxInstancesOfTsType	See table 7-48.		

### 7.3.5.3 Data Set Composition and Relationship Requirements

Table 7-53 defines the data set composition and relationship requirements for the **QSA-SR** message.

**Table 7-53: Data Set Composition and Relationship Requirements for QSA-SR**

QSAD-01	The <b>QueryServiceAgreementSuccessfulReturn</b> message shall contain either: a) one <b>ServiceAgreement</b> data set; or b) one <b>BilateralServiceAgreement</b> data set. [syntactic validation]
QSAD-02	The <b>ServiceAgreement</b> data set shall contain: a) one <b>ConfigurationConstraintsSpecification</b> data set; b) one <b>OperationsConstraintsSpecification</b> data set; c) one or more <b>SupportingAntenna</b> data sets. [syntactic validation]
QSAD-03	The <b>f401SpaceLinkCarrierAgreementId</b> and <b>r401SpaceLinkCarrierAgreementId</b> parameters shall be unique within the <b>ServiceAgreement</b> data set. [service management validation]
QSAD-04	The <b>ConfigurationConstraintsSpecification</b> data set shall contain: a) zero or more <b>F401SpaceLinkCarrierAgreement</b> data sets; b) zero or more <b>R401SpaceLinkCarrierAgreement</b> data sets; c) one <b>TransferServiceAgreement</b> data set. [syntactic validation]
QSAD-05	a) The <b>TransferServiceAgreement</b> data set shall contain at least one of the following: 1) <b>SlsRaftTsAgreement</b> data set; 2) <b>SlsRcfTsAgreement</b> data set; 3) <b>SlsFclutTsAgreement</b> data set; 4) <b>RtrvlRaftTsAgreement</b> data set; and 5) <b>RtrvlRcfTsAgreement</b> data set. b) The <b>TransferServiceAgreement</b> data set shall contain no more than one of each of the following: 1) <b>SlsRaftTsAgreement</b> data set; 2) <b>SlsRcfTsAgreement</b> data set; 3) <b>SlsFclutTsAgreement</b> data set; 4) <b>RtrvlRaftTsAgreement</b> data set; and 5) <b>RtrvlRcfTsAgreement</b> data set. [syntactic validation]  NOTE – The <b>TransferServiceAgreement</b> data set contains one <b>XxxTsAgreement</b> data set for each transfer service type supported by the <b>Service Agreement</b> .
QSAD-06	The <b>ConfigurationConstraintsSpecification</b> data set shall contain at least one <b>F401SpaceLinkCarrierAgreement</b> data set or one <b>R401SpaceLinkCarrierAgreement</b> data set. [syntactic validation]
QSAD-07	A <b>F401SpaceLinkCarrierAgreement</b> data set shall contain one <b>F401SymbolStreamAgreement</b> data set. [syntactic validation]



QSAD-08	A <b>F401SpaceLinkCarrierAgreement</b> data set shall contain zero or one <b>F401SubcarrierAgreement</b> data set. [syntactic validation]
QSAD-09	A <b>R401SpaceLinkCarrierAgreement</b> data set shall contain one or more <b>R401SymbolStreamAgreement</b> data sets. [syntactic validation]
QSAD-10	For a given <b>R401SpaceLinkCarrierAgreement</b> data set, there shall be only one <b>R401SymbolStreamAgreement</b> data set for each allowed value of the parameter <b>channelAssignmentAgreement</b> (defined in table 7-39). [service management validation]
QSAD-11	The value of parameter <b>channelAssignment</b> in the <b>R401SymbolStream</b> data set shall be equal to the value of parameter <b>channelAssignmentAgreement</b> in one of the <b>R401SymbolStreamAgreement</b> data sets contained by the <b>R401SpaceLinkCarrierAgreement</b> data set. [service management validation]
QSAD-12	A <b>R401SpaceLinkCarrierAgreement</b> data set shall contain zero or one <b>R401SubcarrierAgreement</b> data set. [syntactic validation]
QSAD-13	A <b>F401SymbolStreamAgreement</b> data set shall contain one <b>FtcModulationProdAgreement</b> data set. [syntactic validation]
QSAD-14	A <b>FtcModulationProdAgreement</b> data set shall contain one <b>FcltuProdAgreement</b> data set. [syntactic validation]
QSAD-15	A <b>R401SymbolStreamAgreement</b> data set shall contain one <b>RafProdAgreement</b> data set. [syntactic validation]
QSAD-16	A <b>RafProdAgreement</b> data set shall contain zero or one <b>FecfOnlyAgreement</b> sets. [syntactic validation]
QSAD-17	A <b>RafProdAgreement</b> data set shall contain zero or one <b>ReedSolomonCodingAgreement</b> sets. [syntactic validation]
QSAD-18	A <b>RafProdAgreement</b> data set shall contain zero or one <b>TurboCodingAgreement</b> sets. [syntactic validation]
QSAD-19	A <b>RafProdAgreement</b> data set shall contain zero or more <b>PacketTelemetryChannel</b> data sets. [syntactic validation]
QSAD-20	A <b>RafProdAgreement</b> data set shall contain zero or more <b>AosChannel</b> data sets. [syntactic validation]
QSAD-21	The <b>OperationsConstraintsSpecification</b> data set shall contain: a) one <b>ServicePackageOperationsConstraints</b> data set; b) zero or one <b>TrajectoryPredictionOperationsConstraints</b> data set; c) zero or one <b>ConfigurationProfileOperationsConstraints</b> data set; d) zero or one <b>ServiceAgreementOperationsConstraints</b> data set. [syntactic validation]

QSAD-22	<p>The <b>ServicePackageOperationsConstraints</b> data set shall contain:</p> <ul style="list-style-type: none"> <li>a) one or both of: <ul style="list-style-type: none"> <li>i) <b>CreateServicePackageOperationConstraints</b> data set;</li> <li>ii) <b>ConfirmTentativeServicePackageOperationConstraints</b> data set;</li> </ul> </li> <li>b) one <b>DeleteServicePackageOperationConstraints</b> data set;</li> <li>c) zero or one <b>ReplaceServicePackageOperationConstraints</b> data set;</li> <li>d) zero or one <b>QueryServicePackageOperationConstraints</b> data set;</li> <li>e) zero or one <b>SelectAlternateScenarioOperationConstraints</b> data set;</li> <li>f) zero or one <b>ApplyNewTrajectoryOperationConstraints</b> data set;</li> <li>g) zero or one <b>AddSpaceLinkEventsProfileOperationConstraints</b> data set.</li> </ul> <p>[syntactic validation]</p>
QSAD-23	<p>The <b>ConfirmTentativeServicePackageOperationConstraints</b> data set shall contain one or more <b>DefaultTrajectoryPrediction</b> data sets.</p> <p>[syntactic validation]</p>
QSAD-24	<p>The <b>TrajectoryPredictionOperationsConstraints</b> data set shall contain:</p> <ul style="list-style-type: none"> <li>a) zero or one <b>AddTrajectoryPredictionOperationConstraints</b> data set;</li> <li>b) zero or one <b>DeleteTrajectoryPredictionOperationConstraints</b> data set;</li> <li>c) zero or one <b>QueryTrajectoryPredictionOperationConstraints</b> data set;</li> <li>d) zero or one <b>ExtendTrajectoryPredictionOperationConstraints</b> data set.</li> </ul> <p>[syntactic validation]</p>
QSAD-25	<p>The <b>ConfigurationProfileOperationsConstraints</b> data set shall contain:</p> <ul style="list-style-type: none"> <li>a) one <b>AddSpaceCommunicationServiceProfileOperationConstraints</b> data set;</li> <li>b) one <b>DeleteSpaceCommunicationServiceProfileOperationConstraints</b> data set;</li> <li>c) zero or one <b>QuerySpaceCommunicationServiceProfileOperationConstraints</b> data set;</li> <li>d) zero or one <b>AddSpaceLinkEventsProfileOperationConstraints</b> data set;</li> <li>e) zero or one <b>DeleteSpaceLinkEventsProfileOperationConstraints</b> data set;</li> <li>f) zero or one <b>QuerySpaceLinkEventsProfileOperationConstraints</b> data set;</li> <li>g) zero or one <b>AddSlsTransferServiceProfileOperationConstraints</b> data set;</li> <li>h) zero or one <b>AddRetrievalTransferServiceProfileOperationConstraints</b> data set;</li> <li>i) zero or one <b>QueryTransferServiceProfileOperationConstraints</b> data set;</li> <li>j) zero or one <b>DeleteTransferServiceProfileOperationConstraints</b> data set.</li> </ul> <p>[syntactic validation]</p>
QSAD-26	<p>The <b>ServiceAgreementOperationsConstraints</b> data set shall contain one <b>QueryServiceAgreementOperationConstraints</b> data set.</p> <p>[syntactic validation]</p>
QSAD-27	<p>If there is no private annotation information, the <code>privateAnnotation</code> parameter shall have null content.</p> <p>[syntactic validation]</p>
QSAD-28	<p>If Space Link Events Profiles are not supported, the parameters <code>maxEventTimeWindowLead</code> and <code>maxEventTimeWindowLag</code> shall have null content.</p> <p>[syntactic validation]</p>
QSAD-29	<p>CM and UM shall mutually agree upon the allowable values for antenna identifiers that are held by <code>AntennaId</code> parameters of the <b>SupportingAntenna</b> data sets. The identifiers shall be unique with respect to the Service Agreement.</p> <p>[service management validation]</p>

QSAD-30	The valid values for parameter <code>pcmWaveformOptions</code> shall be restricted to 'NRZ-L' and 'NRZ-M' if subcarrier is used for this space link carrier, i.e., if a <b>F401SubcarrierAgreement</b> or <b>R401SubcarrierAgreement</b> data set is contained by the <b>F401SpaceLinkCarrierAgreement</b> or <b>R401SpaceLinkCarrierAgreement</b> data set, respectively, to which the parameter <code>pcmWaveformOptions</code> belongs. [service management validation]
QSAD-31	In a <b>R401SpaceLinkCarrierAgreement</b> data set, the valid values for parameter <code>carrierModulationTypeOptions</code> shall be restricted to only 'BPSK' if the value of parameter <code>carrierUse</code> is 'remnant'. [service management validation]

### 7.3.6 QueryServiceAgreementFailedReturn (QSA-FR) MESSAGE (CM → UM)

#### 7.3.6.1 General

The **QueryServiceAgreementFailedReturn (QSA-FR)** message conforms to the data set composition and relationship requirements for, and inherits the parameters of, the `<<FailedReturn>>` stereotype, as specified in table 3-10. The **QsaError** dataset of the **QSA-FR** message conforms to and inherits the parameters of the `<<Error>>` data set stereotype, which contains a diagnostic parameter of the `<<ErrorDiagnostic>>` stereotype.

Figure 7-4 shows the message structure of the **QSA-FR** as a class diagram. Most possible errors in the **QSA-I** message are intercepted by the SM document exchange protocol and reported in the **UnrecognizedMessageSetResponse** message (see 3.3.5.4).

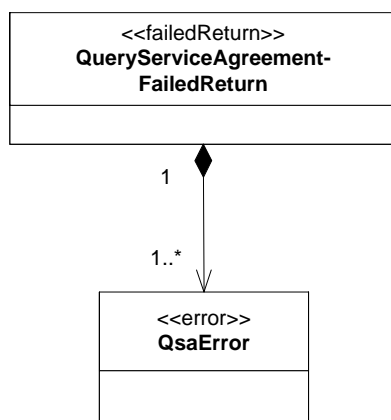

Figure 7-4: QSA-FR Message Structure Class Diagram

### 7.3.6.2 Parameters

Table 7-54 defines the additional values of the diagnostic parameter for the **QsaError** data set, identifies the CM and data set composition service management requirements that result in that diagnostic value being returned, and identifies the contents of the `erroredItem` and `additionalInformation` parameters that accompany each diagnostic value.

**Table 7-54: QsaError Data Set diagnostic Parameter Definition**

diagnostic value	Definition/Description	Rqmt	Parameter or Data Set Identified by <code>erroredItem</code>	Content of <code>additionalInformation</code>
'operation timeout'	When the operation cannot be completed before the disposition timer expires.	2PP-0103b	not applicable	not required
'other'	The operation has failed due to an error that is local to the Service Agreement.	QSAC-04	The invalid parameter or data set that causes the violation	Text-string description of the local error

### 7.3.6.3 Data Set Composition and Relationship Requirements

There are no specific data set composition and relationship requirements for **QSA-FR**. The identification of the requested Service Agreement is conveyed by the containing SM message set.

## ANNEX A

## DATA TYPE DEFINITIONS

## (NORMATIVE)

Table A-1 defines the types that are used by the parameters of this Recommended Standard. Any mapping of these types to a concrete transfer syntax (e.g., XML) must convey the range and semantic content of these type definitions.

Table A-1: SCCS-SM Data Type Definitions

Simple Type	Type Definition
BilateralData	Conforms to a format specification that is outside the scope of this Recommended Standard.
Boolean	valid values: {true, false}.
DistinguishedName	A finite-length sequence of characters. Instances of this type contain globally unambiguous names of parameters and data sets. Distinguished names identify the top-level information entity (e.g., Service Package or Space Communication Service Profile) and whatever information is necessary to distinguish the instance of the parameter or data set within that information entity. For example, if a Space Communication Service Profile contains two carrier profiles, the distinguished name of one of the <code>carrierFrequency</code> parameters would indicate not only which Space Communication Service Profile the parameter belongs to, but also which carrier profile within that Space Communication Service Profile. The exact syntax for expressing a distinguished name depends on the language (e.g., XML) that is used to represent the Space Communication Cross Support Service Management documents in real message exchanges.
Enum	String with a value restricted to one of a specified collection of values.
Integer	[-9223372036854775808, 9223372036854775807].
Negative Integer	[-18446744073709551615, -1].
NULL	The parameter has no value. This value is used only when the presence of the parameter is optional; e.g., 'Positive Integer or NULL' indicates that when the parameter is present it must be of type Positive Integer, but the parameter may have no value. NOTE – Depending on the concrete representation used, NULL parameters may be absent from the SM documents. This is the case for the W3C XML schema mapping documented in virtual annex [16].
OemTextData	String in the CCSDS Orbit Ephemeris Message (OEM) format in plain text as defined in reference [13].

Simple Type	Type Definition
OemXmlData	String in the CCSDS Orbit Ephemeris Message (OEM) format in XML conformant to the XML Schema defined in reference [15].
Opaque	A finite-length sequence of octets of unrestricted value. NOTE – In contrast with the String type, the content of an Opaque parameter is not constrained by the rules of the transfer syntax (e.g., XML) employed to exchange SM documents.
OpmTextData	String in the CCSDS Orbit Parameter Message (OPM) format in plain text as defined in reference [13].
OpmXmlData	String in the CCSDS Orbit Parameter Message (OPM) format in XML conformant to the XML Schema defined in reference [15].
Positive Integer	[1, 18446744073709551615].
Positive Unsigned Integer [A..B]	Positive Unsigned Integer with values restricted to the range $A \leq \text{value} \leq B$ .
Set of enumerated values	A set of String-valued components, each of which has a value restricted to one of a specified collection of values. Each value may appear at most once in the set. The set must contain at least one component. The component values may appear in any order within the set.
String	Finite-length sequence of characters. NOTE – The values of characters contained in a string may be constrained by the rules of the transfer syntax (e.g., XML) employed to exchange SM documents.
String[A..B]	String with length restricted such that it must be at least A characters in length but no more than B characters in length (where $1 \leq A \leq B$ ).
StringX	String with length restricted to [1..X] characters where X is the maximum number of characters (e.g., 128, 256).
Unsigned Integer	[0, 18446744073709551615].

Simple Type	Type Definition
UTC	<p>String in the form:            YYYY-MM-ddTHH:mm:ssZ            where:            YYYY is a four-digit numeral that represents the year;            ‘-’ is a separator between parts of the date portion;            MM is a two-digit numeral that represents the month;            dd is a two-digit numeral that represents the day;            ‘T’ is a separator indicating that time-of-day follows;            hh is a two-digit numeral that represents the hour [‘00’ -‘23’];            ‘.’ is a separator between parts of the time-of-day portion;            mm is a two-digit numeral that represents the minute [‘00’-‘59’];            ss is a two-integer-digit numeral that represents the whole seconds [‘00’-‘59’];            ‘Z’ represents the time zone, it indicates that it is a UTC time.</p>

NOTE – Multiple instances of any one these data types can be collected into a list, designated by the ‘list of <data type>’ expression. For example, ‘list of String256’ is a list of values, each of which conforms to the String256 type.

## ANNEX B

### INCREMENTAL ADOPTION

#### (NORMATIVE)

This Recommended Standard recognizes that an installed base of service management information and interfaces for SCCS-SM exists. As an aid for implementation planning in transitioning to the Recommended Standard for SCC-SM, this annex defines minimal compliance. It also provides guidance in recognition that adoption of the Recommended Standard may be incremental in nature.

The Service Package service represents the most likely set of services to be used on a routine basis, and as such is the highest priority service for interoperability. The operations CSP or CTSP, together with DSP and SPC, represent the minimum level of compliance required for effective SCCS-SM in conformance with the Recommended Standard. An implementation shall, at a minimum, implement a) one of either CSP or CTSP operations and b) both the DSP and SPC operations.

Implementation of the other SCCS-SM services may also be on an incremental basis. When incrementally adopting the other SCC-SM services, an implementation shall, at a minimum, implement the operations as indicated in table B-1.

For some of the operations, information content that is mutually agreed upon by multiple implementations but that is not in conformance with the Recommended Standard is allowed. In this case, the information is said to be *bilaterally defined*. An example is that of a network that offers non-CCSDS compliant telemetry or command modulation schemes; in this case, the appropriate profile information may be developed by the interoperating implementations while retaining use of the standard service package definitions in reference to this bilaterally defined profile information. Table B-1 provides an indication as to whether or not bilateral information is allowed for an operation; the definition of where the bilateral information may appear for each operation that allows bilateral content is defined in the class diagrams and Data Set Composition and Relationship Requirements section of each such operation. Use of bilaterally defined information lessens interoperability and is therefore discouraged.



**Table B-1: SCCS-SM Operations Compliance Levels**

<b>CS SM Compliance Matrix</b>				
Service	Operations	Implementation required for minimal compliance	Bilaterally Defined Content Allowed	Notes
Service Package	CSP	A	P	1
	DSP	Y	N	
	CTSP	A	N	
	SAS	N	N	
	ANT	N	N	
	ANSLEP	N	N	
	QSP	N	P	3
	RSP	N	P	1
	SPC	Y	N	
Configuration Profile	SPM	N	N	
	ASCSP	N	Y	
	ASTSP	N	Y	
	ARTSP	N	Y	
	DSCSP	N	N	2
	DTSP	N	N	2
	QSCSP	N	Y	3
	QTSP	N	Y	3
	ASLEP	N	Y	
DSLEP	N	N	2	
Trajectory Prediction	QSLEP	N	Y	3
	ATP	N	Y	
	DTP	N	N	2
Service Agreement	QTP	N	Y	3
	ETP	N	Y	
Service Agreement	QSA	N	Y	3

**Legend**

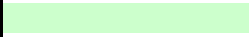
Y = Yes
N = No
P = Partial
A = Alternative option for compliance
 Operation shall be implemented to achieve minimal compliance.
 At least one of either CTSP or CTSP shall be provided for minimal compliance.

**Notes**

1	Bi-laterally defined content allowed only in successful return messages in relation to event sequencing information.
2	Messages involved with delete operations have very minimal content definitions.

## ANNEX C

## ACRONYMS AND ABBREVIATIONS

## (INFORMATIVE)

ANSLEP*	APPLY_NEW_SPACE_LINK_EVENTS_PROFILE
ARTSP*	ADD_RETRIEVAL_TRANSFER_SERVICE_PROFILE
ASCSP*	ADD_SPACE_COMMUNICATION_SERVICE_PROFILE
ASLEP*	ADD_SPACE_LINK_EVENTS_PROFILE
ASTSP*	ADD_SLS_TRANSFER_SERVICE_PROFILE
ANT*	APPLY_NEW_TRAJECTORY
ATP*	ADD_TRAJECTORY_PREDICTION
BPSK	binary phase shift key
CLCW	communications link control word
CLTU	communications link transmission unit
CM	complex management
CMM	carrier modulation mode
CSP*	CREATE_SERVICE_PACKAGE
CSTS	Cross Support Transfer Services
CTSP*	CONFIRM_TENTATIVE_SERVICE_PACKAGE
dBW	decibels referenced to one watt
DSCSP*	DELETE_SPACE_COMMUNICATION_SERVICE_PROFILE
DSLEP*	DELETE_SPACE_LINK_EVENTS_PROFILE
DSP*	DELETE_SERVICE_PACKAGE
DTP*	DELETE_TRAJECTORY_PREDICTION
DTSP*	DELETE_TRANSFER_SERVICE_PROFILE
EIRP	equivalent (or effective) isotropic radiated power
ETP*	EXTEND_TRAJECTORY_PREDICTION
FCLTU	forward communications link transmission unit
FSP	forward space packet
GMSK	Gaussian Minimum Shift Key
HTTP	hypertext transfer protocol
LCP	left-hand circular polarization

MDOS	mission data operations system
NRZ-L	non-return to zero-level
NRZ-M	non-return to zero-mark
OASIS	Organization for the Advancement of Structured Information Standards
ODM	orbit data message
OEM	orbit ephemeris message
OMG	Object Management Group
OPM	orbit parameter message
OQPSK	offset quaternary/quadrature/quadra phase shift key
PLOP	Physical Layer Operations Procedure
PDU	protocol data unit
PCM	Pulse Code Modulation
PSK	Phase Shift Key
PM	Phase Modulation.
QPSK	quaternary/quadrature/quadra phase shift key
QSA*	QUERY_SERVICE_AGREEMENT
QSCSP*	QUERY_SPACE_COMMUNICATION_SERVICE_PROFILE
QSLEP*	QUERY_SPACE_LINK_EVENTS_PROFILE
QSP*	QUERY_SERVICE_PACKAGE
QTP*	QUERY_TRAJECTORY_PREDICTION
QTSP*	QUERY_TRANSFER_SERVICE_PROFILE
RAF	return all frames
RCF	return channel frames
RF	radio frequency
RCP	right-hand circular polarization
ROCF	return operations control field
RSP*	REPLACE_SERVICE_PACKAGE
SAS*	SELECT_ALTERNATE_SCENARIO
SCCS	Space Communication Cross Support
SCET	spacecraft event time
SDU	service data unit
SLE	space link extension

SLS	Space Link Session
SM	service management
SOAP	simple object access protocol
SPC*	SERVICE_PACKAGE_CANCELLED
SPM*	SERVICE_PACKAGE_MODIFIED
TC	Telecommand
TCP	transmission control protocol
URL	uniform resource locator
TM	Telemetry
TT&C	tracking, telemetry, and command
UM	utilization management
UML	unified modeling language
UQPSK	unbalanced quaternary/quadrature/quadrature phase shift key
UTC	coordinated universal time
W3C	World Wide Web Consortium
XKMS	XML Key Management Specification
XML	extensible markup language

-----

\* Acronyms for SCCS-SM operations may appear with one of the following suffixes:

AR	Acknowledged Return
C	Complex Management (CM) -indicates a requirement for CM
D	Data; indicates a Data Set Composition and Relationship requirement
FR	Failed Return
I	Invocation
SR	Successful Return
U	Utilization Management (UM); indicates a requirement for UM

## ANNEX D

## SCCS SERVICE MANAGEMENT PARAMETERS TABLE

## (INFORMATIVE)

## D1 INTRODUCTION

This annex lists all the SCCS-SM parameters defined within this document in alphabetical order, according to SCCS Management Service.

## D2 SM DOCUMENT EXCHANGE PROTOCOL (SECTION 3)

Table D-1: SM Document Exchange Parameters List

Name	Data Set	Cross-reference
additionalInformation	<<Error>>	Table 3-11
	<<Denial>>	Table 3-13
deniedItem	<<Denial>>	Table 3-13
diagnostic	<<Error>>	Table 3-11
	<b>InvalidInvocationResponse</b>	Table 3-23
	<b>InvalidNotificationResponse</b>	Table 3-24
	<b>UnrecognizedMessageSetResponse</b>	Table 3-22
erroredItem	<<Error>>	Table 3-11
	<b>SmExceptionResponse</b>	Table 3-21
expectedDispositionTime	<<AcknowledgedReturn>>	Table 3-15
invocationMessageSequenceNumber	<<SuccessfulReturn>>	Table 3-8
	<<FailedReturnWithDenial>>	Table 3-10
	<b>InvalidInvocationResponse</b>	Table 3-23
messagePrivateAnnotation	<<Invocation>>	Table 3-6
	<<FailedReturnWithDenial>>	Table 3-10
messageSequenceNumber	<<Invocation>>	Table 3-6
	<<FailedReturnWithDenial>>	Table 3-10
messageTimestamp	<<Invocation>>	Table 3-6
	<<FailedReturnWithDenial>>	Table 3-10
notificationMessageSequenceNumber	<<Confirmation>>	Table 3-19
privateAnnotation	<<Error>>	Table 3-11
	<<Denial>>	Table 3-13
	<<AcknowledgedReturn>>	Table 3-15
	<b>SmExceptionResponse</b>	Table 3-21

Name	Data Set	Cross-reference
reason	<<Denial>>	Table 3-13
serviceAgreementRef	<b>SmMessageSet</b>	Table 3-4
	<b>InvalidInvocationResponse</b>	Table 3-23
	<b>InvalidNotificationResponse</b>	Table 3-24
smDestination	<b>SmMessageSet</b>	Table 3-4
	<b>InvalidInvocationResponse</b>	Table 3-23
	<b>InvalidNotificationResponse</b>	Table 3-24
smSource	<b>SmMessageSet</b>	Table 3-4
	<b>InvalidInvocationResponse</b>	Table 3-23
	<b>InvalidNotificationResponse</b>	Table 3-24
smOwnerName	<<SuccessfulReturn>>	Table 3-8
sccsSmVersionRef	<b>SmMessageSet</b>	Table 3-4
unrecognizedMessageSetInstance	<b>UnrecognizedMessageSetResponse</b>	Table 3-22
urgent	<<Invocation>>	Table 3-6

**D3 SERVICE PACKAGE SERVICE PARAMETERS (SECTION 4)****Table D-2: Service Package Parameters List**

Name	Data Set	Cross-reference
acceptabilityConstraintsType	AntennaConstraints	Table 4-8
accessStartTime	RetrievalServicePackageRequest	Table 4-13
accessStopTime	RetrievalServicePackageRequest	Table 4-13
additionalInformation	CancellationInformation	Table 4-77
	ModificationStatement	Table 4-82
antennaRef	Antenna	Table 4-9
	RetrievalServicePackageRequest	Table 4-13
assignedAntennaRef	SpaceCommunicationServiceResult	Table 4-22
availableStateInstanceNo	RSpaceLinkAvailableScheduledState	Table 4-29
bilateralRtrvlTsInstanceResultData	BilateralRetrievalTsInstanceResult	Table 4-38
bilateralSlsTsInstanceResultData	BilateralSlsTsInstanceResult	Table 4-24
bilateralSpaceLinkEventsResultsData	BilateralSpaceLinkEventsResult	Table 4-28
bilateralSpaceLinkEventsProfile-FormatRef	BilateralSpaceLinkEventsResult	Table 4-28
cancellationReason	CancellationInformation	Table 4-77
carrierProfileRef	CarrierResult	Table 4-25
	ProposedCarrier	Table 4-99
cmAdvisory	FSpaceLinkAvailableScheduledState	Table 4-29
communicationMode	RSpaceLinkDataTransportState	Table 5-53
constraintType	Antenna	Table 4-9
convolutionalCoding	R401SymbolStream	Table 5-14
eventAdvisory	FSpaceLinkChangeScheduledEvent	Table 4-31
eventInstanceNo	FSpaceLinkChangeScheduledEvent	Table 4-31
eventScheduledTime	FSpaceLinkChangeScheduledEvent	Table 4-31
existingSpaceLinkEventsProfileRef	SpaceLinkEventsProfileInformation	Table 4-109
existingTrajectoryRef	TrajectoryPredictionInformation	Table 4-68
fEirpOffset	FSpaceLinkAvailableScheduledState	Table 4-29
fPolarization	FSpaceLinkChangeScheduledEvent	Table 5-5
handoversPermitted	SpaceLinkSessionServicePackageRequest	Table 4-4
importance	SpaceLinkSessionServicePackageRequest	Table 4-4
itemRef	ModifiedItem	Table 4-83
minimumServiceDuration	SpaceCommunicationServiceRequest	Table 4-7
modificationReason	ModificationStatement	Table 4-82
modulationIndex	F401SpaceLinkCarrierProfile	Table 5-5
newSpaceLinkEventsProfileRef	SpaceLinkEventsProfileInformation	Table 4-109

Name	Data Set	Cross-reference
newTrajectoryRef	TrajectoryPredictionInformation	Table 4-68
parameterDistinguishedName	RespecifiedParameter	Table 4-11
parameterValue	RespecifiedParameter	Table 4-11
preferredServiceDuration	SpaceCommunicationServiceRequest	Table 4-7
primeScenarioRef	SpaceLinkSessionServicePackageRequest ServiceScenarioReference (SAS-SR)	Table 4-4 Table 4-61
providerId	SlsTsInstanceResult	Table 4-23
providerPortId	SlsTsInstanceResult	Table 4-23
rEirpOffset	RSpaceLinkAvailableScheduledState	Table 5-49
rPolarization	RSpaceLinkChangeScheduledEvent	Table 5-10
rSubcarrierFrequency	RSpaceLinkDataTransportScheduledEvent	Table 5-11
scenarioId	ServiceScenario ProposedServiceScenario	Table 4-5 Table 4-95
scenarioRef	ServiceScenarioResult	Table 4-20
scheduledAccessStartTime	RetrievalTsInstanceResult	Table 4-36
scheduledAccessStopTime	RetrievalTsInstanceResult	Table 4-36
scheduledCarrierStartTime	CarrierResult ProposedCarrier	Table 4-25 Table 4-99
scheduledCarrierStopTime	CarrierResult ProposedCarrier	Table 4-25 Table 4-99
scheduledServiceInstanceStartTime	SlsTsInstanceResult	Table 4-23
scheduledServiceInstanceStopTime	SlsTsInstanceResult	Table 4-23
scheduledServicePackageStartTime	SpaceLinkSessionServicePackageResult ProposedServicePackage	Table 4-20 Table 4-94
scheduledServicePackageStopTime	SpaceLinkSessionServicePackageResult	Table 4-20
scheduledSpaceCommServiceStartTime	SpaceCommunicationServiceResult	Table 4-22
scheduledSpaceCommServiceStopTime	SpaceCommunicationServiceResult	Table 4-22
sequenceOfEventsDeferred	SpaceCommunicationServiceRequest	Table 4-7
servicePackageDefinitionThresholdTime	SpaceLinkSessionServicePackageResult	Table 4-20
servicePackageId	ServicePackageIdentification	Table 4-15
servicePackageReadinessStatus	SpaceLinkSessionServicePackageResult	Table 4-20
servicePackageRef	ServicePackageReference	Table 4-17
spaceLinkEventsProfileRef	SpaceLinkEventsProfileReference	Table 4-12
spaceCommunicationServiceProfileRef	SpaceCommunicationServiceRequest ProposedSpaceCommunicationService	Table 4-7 Table 4-97
spaceCommServiceStartTime	SpaceCommunicationServiceRequest	Table 4-7
spaceCommServiceStartTimeLag	SpaceCommunicationServiceRequest	Table 4-7
spaceCommServiceStartTimeLead	SpaceCommunicationServiceRequest	Table 4-7
stateEndTimeWindowLag	FSpaceLinkAvailableScheduledState	Table 4-29



<b>Name</b>	<b>Data Set</b>	<b>Cross-reference</b>
stateEndTimeWindowLead	<b>FSpaceLinkAvailableScheduledState</b>	Table 4-29
stateScheduledEndTime	<b>FSpaceLinkAvailableScheduledState</b>	Table 4-29
stateScheduledStartTime	<b>FSpaceLinkAvailableScheduledState</b>	Table 4-29
stateStartTimeWindowLag	<b>FSpaceLinkAvailableScheduledState</b>	Table 4-29
stateStartTimeWindowLead	<b>FSpaceLinkAvailableScheduledState</b>	Table 4-29
symbolRate	<b>F401SymbolStream</b>	Table 5-8
timeReference	<b>SpaceCommunicationServiceRequest</b>	Table 4-7
trajectoryPredictionStatus	<b>TrajectoryResult</b>	Table 4-21
	<b>AppliedTrajectory</b>	Table 4-21
trajectoryRef	<b>TrajectoryReference</b>	Table 4-6
	<b>AppliedTrajectory</b>	Table 4-21
transferServiceInstanceNumber	<b>SlsTsInstanceResult</b>	Table 4-23
transferServiceInstanceNumberRef	<b>TsMapResult</b>	Table 4-26
	<b>ProposedTsMap</b>	Table 4-100
transferServiceProfileRef	<b>SlsTsProfileRespecification</b>	Table 4-10
	<b>RetrievalServicePackageRequest</b>	Table 4-13
transferServicesDeferred	<b>SpaceCommunicationServiceRequest</b>	Table 4-7
umAdvisory	<b>FSpaceLinkAvailableScheduledState</b>	Table 5-49
userId	<b>SlsTsInstanceResult</b>	Table 4-23

**D4 CONFIGURATION PROFILE SERVICE PARAMETERS (SECTION 5)****Table D-3: Configuration Profile Parameters List**

Name	Data Set	Cross-reference
permittedGlobalVcidSet	RcfTransferServiceProfile	Table 5-82
permittedFrameQualities	RafTransferServiceProfile	Table 5-81
availableStateInstanceNo	RSpaceLinkAvailableState	Table 5-49
bilateralCarrierProfileData	BilateralCarrierProfile	Table 5-21
bilateralCarrierProfileFormatId	BilateralCarrierProfile	Table 5-21
bilateralDataSinkData	BilateralDataSink	Table 5-24
bilateralSpaceLinkEventsProfileData	BilateralSpaceLinkEventsProfile	Table 5-59
bilateralSpaceLinkEventsProfileFormatId	BilateralSpaceLinkEventsProfile	Table 5-59
bilateralTransferServiceProfileData	BilateralTransferServiceProfile	Table 5-83
bilateralTransferServiceProfileFormatId	BilateralTransferServiceProfile	Table 5-83
bilateralTsMData	BilateralTsM	Table 5-22
carrierFrequency	F401SpaceLinkCarrierProfile	Table 5-5
carrierProfileId	SpaceLinkCarrierProfile	Table 5-4
carrierProfileRef	RSpaceLinkEvents, FSpaceLinkEvents	Table 5-48
carrierStartTimeOffset	SpaceLinkCarrierProfile	Table 5-4
carrierStopTimeOffset	SpaceLinkCarrierProfile	Table 5-4
carrierWaveform	F401SpaceLinkCarrierProfile R401SpaceLinkCarrierProfile	Table 5-5 Table 5-10
coherentReturnFrequencyDivisor	ReturnCoherenceModel	Table 5-12
coherentReturnFrequencyMultiplier	ReturnCoherenceModel	Table 5-12
communicationMode	RSpaceLinkDataTransportState	Table 5-53
convolutionalCoding	R401SymbolStream	Table 5-14
currentTsVersion	FcltuTransferServiceProfile	Table 5-80
dataRateLimitation	RafTransferServiceProfile	Table 5-81
dataSinkId	ReturnLinkFrameDataSink	Table 5-23
onlineDeliveryMode	RafTransferServiceProfile	Table 5-81
dopplerComp	F401SpaceLinkCarrierProfile	Table 5-5
fEirp	F401SpaceLinkCarrierProfile	Table 5-5
fEirpOffset	FSpaceLinkAvailableState	Table 5-50
endHoldDuration	FrequencySweepLeg	Table 5-6
errorCorrectionCapability	ReedSolomonCoding	Table 5-17
eventInstanceNo	RSpaceLinkChangeEvent	Table 5-51
eventTime	RSpaceLinkChangeEvent	Table 5-51
eventTimeWindowLag	RSpaceLinkChangeEvent	Table 5-51

## SPACE COMMUNICATION CROSS SUPPORT—SERVICE MANAGEMENT—SERVICE SPECIFICATION

Name	Data Set	Cross-reference
eventTimeWindowLead	RSpaceLinkChangeEvent	Table 5-51
f401SpaceLinkCarrierAgreementRef	F401SpaceLinkCarrierProfile	Table 5-5
forwardCarrierRef	ReturnCoherenceModel	Table 5-12
fPolarization	F401SpaceLinkCarrierProfile	Table 5-5
fSubcarrierFrequency	F401Subcarrier	Table 5-7
functionalGroupId	ReturnLinkFrameDataSink FcltuTransferServiceProfile OfflineRaftsProfile	Table 5-23 Table 5-80 Table 5-94
informationBlockLength	TurboCoding	Table 5-18
initialHoldDuration	F401SpaceLinkCarrierProfile	Table 5-5
instanceEnabled	FcltuTSM ReturnLinkFrameDataSink	Table 5-9 Table 5-23
interleaveDepth	ReedSolomonCoding	Table 5-17
channelAssignment	R401SymbolStream	Table 5-14
latencyLimit	RafTransferServiceProfile	Table 5-81
lowerBoundReportingPeriod	FcltuTransferServiceProfile	Table 5-80
modulationIndex	F401SpaceLinkCarrierProfile	Table 5-5
carrierModulationType	R401SpaceLinkCarrierProfile	Table 5-10
nominalCodeRate	TurboCoding	Table 5-18
notificationMode	FcltuTransferServiceProfile	Table 5-80
pcmFormat	F401SpaceLinkCarrierProfile	Table 5-5
phaseAmbiguityResolution	R401SpaceLinkCarrierProfile	Table 5-10
powerRatio	R401SpaceLinkCarrierProfile	Table 5-10
r401SpaceLinkCarrierAgreementRef	R401SpaceLinkCarrierProfile	Table 5-10
rEirp	R401SpaceLinkCarrierProfile	Table 5-10
rEirpOffset	RSpaceLinkAvailableState	Table 5-49
returnFrequencyOffset	ReturnOffsetModel	Table 5-13
returnTimeoutPeriod	FcltuTransferServiceProfile	Table 5-80
rFrameLength	FecfOnly	Table 5-16
rPolarization	R401SpaceLinkCarrierProfile	Table 5-10
rSubcarrierFrequency	R401Subcarrier RSpaceLinkDataTransportState	Table 5-11 Table 5-53
spaceLinkEventsProfileId	SpaceLinkEventsProfileIdentification	Table 5-58
spaceLinkEventsProfileRef	SpaceLinkEventsProfileReference	Table 5-61
spaceCommunicationServiceProfileId	SpaceCommunicationServiceProfileIdentification	Table 5-26
spaceCommunicationServiceProfileRef	SpaceCommunicationServiceProfileReference	Table 5-28
startTimeOffset	FcltuTransferServiceProfile	Table 5-80
stateEndTime	RSpaceLinkAvailableState, FSpaceLinkAvailableState	Table 5-49

Name	Data Set	Cross-reference
stateEndTimeWindowLag	RSpaceLinkAvailableState, FSpaceLinkAvailableState	Table 5-49
stateEndTimeWindowLead	RSpaceLinkAvailableState, FSpaceLinkAvailableState	Table 5-49
stateStartTime	RSpaceLinkAvailableState, FSpaceLinkAvailableState	Table 5-49
stateStartTimeWindowLag	RSpaceLinkAvailableState, FSpaceLinkAvailableState	Table 5-49
stateStartTimeWindowLead	RSpaceLinkAvailableState, FSpaceLinkAvailableState	Table 5-49
stopTimeOffset	FcltuTransferServiceProfile	Table 5-80
storageSelectionCriterion	ReturnLinkFrameDataSink	Table 5-23
storedChannels	ReturnLinkFrameDataSink	Table 5-23
fSubcarrierFrequency	F401Subcarrier	Table 5-7
subcarrierWaveform	F401Subcarrier	Table 5-7
sweepEndFreqOffset	FrequencySweepLeg	Table 5-6
sweepFreqDopplerComp	F401SpaceLinkCarrierProfile	Table 5-5
sweepInitialFreqOffset	F401SpaceLinkCarrierProfile	Table 5-5
sweepRate	FrequencySweepLeg	Table 5-6
symbolRate	F401SymbolStream	Table 5-8
timeReference	TimeReferenceSpecification	Table 5-47
tlmRandomization	RafProd	Table 5-15
transferBufferSize	RafTransferServiceProfile	Table 5-81
transferServiceProfileId	TransferServiceProfileIdentification	Table 5-85
transferServiceProfileRef	FcltuTSM TransferServiceProfileReference	Table 5-9 Table 5-87
umAdvisory	FSpaceLinkAvailableState	Table 5-49
upperBoundReportingPeriod	FcltuTransferServiceProfile	Table 5-80
userId	FcltuTransferServiceProfile	Table 5-80
virtualFillLength	ReedSolomonCoding	Table 5-17

**D5 TRAJECTORY PREDICTION SERVICE PARAMETERS (SECTION 6)****Table D-4: Trajectory Prediction Parameters List**

<b>Name</b>	<b>Data Set</b>	<b>Cross-reference</b>
bilateralTrajectoryData	OrbitBilateralMessage	Table 6-10
bilateralTrajectoryFormatId	OrbitBilateralMessage	Table 6-10
oemTextData	OrbitEphemerisMessageText	Table 6-8
oemXmlData	OrbitEphemerisMessageXml	Table 6-9
opmTextData	OrbitParameterMessageText	Table 6-6
opmXmlData	OrbitParameterMessageXml	Table 6-7
servicePackageRef	ReferencingServicePackage	Table 6-26
remainingStorageSpace	TrajectoryPredictionStorage	Table 6-13
trajectoryGapPresent	TrajectoryGapStatus	Table 6-34
trajectoryId	TrajectoryPredictionIdentification	Table 6-4
trajectoryRef	TrajectoryPredictionReference	Table 6-12
trajectorySegmentGrade	TrajectoryPredictionSegment	Table 6-5
trajectoryStartTime	TrajectoryPredictionSegment	Table 6-5
trajectoryStopTime	TrajectoryPredictionSegment	Table 6-5

**D6 SERVICE AGREEMENT SERVICE PARAMETERS (SECTION 7)****Table D-5: Service Agreement Parameters List**

<b>Name</b>	<b>Data Set</b>	<b>Cross-reference</b>
acquisitionSequenceLength	FTcModulationProdAgreement	Table 7-35
antennaId	SupportingAntenna	Table 7-4
allowedBilateralCarrierProfile-FormatIds	ConfigurationProfileOperationsConstraints	Table 7-20
allowedBilateralSpaceLinkEvents-ProfileFormatIds	ConfigurationProfileOperationsConstraints	Table 7-20
allowedBilateralTrajectoryFormatIds	TrajectoryPredictionOperationsConstraints	Table 7-15
allowedBilateralTransferService-ProfileFormatIds	ConfigurationProfileOperationsConstraints	Table 7-20
allowedCmSmEntityNames	ServiceAgreement	Table 7-3
allowedThrowEventIdentifiers	SlsFcltuTsAgreement	Table 7-50
allowedUmSmEntityNames	ServiceAgreement	Table 7-3
anslepRoutineTimeout	ApplyNewSpaceLinkEventsProfileOperation-Constraints	Table 7-13
anslepUrgentTimeout	ApplyNewSpaceLinkEventsProfileOperation-Constraints	Table 7-13
antRoutineTimeout	ApplyNewTrajectoryOperationConstraints	Table 7-11
antUrgentTimeout	ApplyNewTrajectoryOperationConstraints	Table 7-11
aosScid	AosChannel	Table 7-45
aosVirtualChannels	AosChannel	Table 7-45
applicableSccsSmVersionIds	ServiceAgreement	Table 7-3
artpRoutineTimeout	AddRetrievalTransferServiceProfileOperationConstraints	Table 7-28
artpUrgentTimeout	AddRetrievalTransferServiceProfileOperationConstraints	Table 7-28
aslepRoutineTimeout	AddSpaceLinkEventsProfileOperationConstraints	Table 7-24
aslepUrgentTimeout	AddSpaceLinkEventsProfileOperationConstraints	Table 7-24
ascspRoutineTimeout	AddSpaceCommunicationServiceProfileOperationConstraints	Table 7-21
ascspUrgentTimeout	AddSpaceCommunicationServiceProfileOperationConstraints	Table 7-21
astpRoutineTimeout	AddSlsTransferServiceProfileOperationConstraints	Table 7-27
astpUrgentTimeout	AddSlsTransferServiceProfileOperationConstraints	Table 7-27
atpRoutineTimeout	AddTrajectoryPredictionOperationConstraints	Table 7-16
atpUrgentTimeout	AddTrajectoryPredictionOperationConstraints	Table 7-16
authorizedServiceInstanceProviderIds	ServicePackageOperationsConstraints	Table 7-5
authorizedServiceInstanceUserIds	ServicePackageOperationsConstraints	Table 7-5
availabilityPeriod	SupportingAntenna	Table 7-4
bilateralServiceAgreementData	BilateralServiceAgreement	Table 7-46

## SPACE COMMUNICATION CROSS SUPPORT—SERVICE MANAGEMENT—SERVICE SPECIFICATION

Name	Data Set	Cross-reference
bilateralServiceAgreementFormatId	BilateralServiceAgreement	Table 7-46
bitLockConfirmationRequired	FcltuProdAgreement	Table 7-36
carrierFrequencyRange	F401SpaceLinkCarrierAgreement	Table 7-32
carrierUse	F401SpaceLinkCarrierAgreement	Table 7-32
carrierWaveformOptions	F401SpaceLinkCarrierAgreement	Table 7-32
complexName	ServiceAgreement	Table 7-3
confirmationTimeout	ServiceAgreement	Table 7-3
contractualReference	ServiceAgreement	Table 7-3
convolutionalCodingOptions	R401SymbolStreamAgreement	Table 7-39
cspRoutineTimeout	CreateServicePackageOperationConstraints	Table 7-6
cspUrgentTimeout	CreateServicePackageOperationConstraints	Table 7-6
ctspRoutineTimeout	ConfirmTentativeServicePackageOperation-Constraints	Table 7-12
ctspUrgentTimeout	ConfirmTentativeServicePackageOperation-Constraints	Table 7-12
dslepRoutineTimeout	DeleteSpaceLinkEventsProfileOperationConstraints	Table 7-25
dslepUrgentTimeout	DeleteSpaceLinkEventsProfileOperationConstraints	Table 7-25
dscspRoutineTimeout	DeleteSpaceCommunicationServiceProfileOperationCo nstraints	Table 7-22
dscspUrgentTimeout	DeleteSpaceCommunicationServiceProfileOperationCo nstraints	Table 7-22
dspRoutineTimeout	DeleteServicePackageOperationConstraints	Table 7-8
dspUrgentTimeout	DeleteServicePackageOperationConstraints	Table 7-8
dtspRoutineTimeout	DeleteTransferServiceProfileOperationConstraints	Table 7-30
dtspUrgentTimeout	DeleteTransferServiceProfileOperationConstraints	Table 7-30
dtpRoutineTimeout	DeleteTrajectoryPredictionOperationConstraints	Table 7-17
dtpUrgentTimeout	DeleteTrajectoryPredictionOperationConstraints	Table 7-17
eccOptions	ReedSolomonCodingAgreement	Table 7-42
fMaxEirp	F401SpaceLinkCarrierAgreement	Table 7-32
fMinEirp	F401SpaceLinkCarrierAgreement	Table 7-32
etpRoutineTimeout	ExtendTrajectoryPredictionOperationConstraints	Table 7-17
etpUrgentTimeout	ExtendTrajectoryPredictionOperationConstraints	Table 7-17
f401SpaceLinkCarrierAgreementId	F401SpaceLinkCarrierAgreement	Table 7-32
fPolarizationOptions	F401SpaceLinkCarrierAgreement	Table 7-32
fSubcarrierFrequencyRange	F401SubcarrierAgreement	Table 7-33
handoverOverlap	ServiceAgreement	Table 7-3
handoversPermittedAgreement	ServiceAgreement	Table 7-3
informationBlockLengthOptions	TurboCodingAgreement	Table 7-43
interleaveOptions	ReedSolomonCodingAgreement	Table 7-42
channelAssignmentAgreement	R401SymbolStreamAgreement	Table 7-39
maxCarrierProfiles	ConfigurationProfileOperationsConstraints	Table 7-20

Name	Data Set	Cross-reference
maxDataRateLimitation	TransferServiceAgreement	Table 7-47
maxEventTimeWindowLag	ServiceAgreement	Table 7-3
maxEventTimeWindowLead	ServiceAgreement	Table 7-3
maxForwardSpaceLinkCarriersPer-Scenario	ServicePackageOperationsConstraints	Table 7-5
maxLengthCltu	FcltuProdAgreement	Table 7-36
maxMcFrameRate	PacketTelemetryChannel AosChannel	Table 7-44 Table 7-45
maxInstancesOfTsType	SlsRaftsAgreement	Table 7-48
maxReturnSpaceLinkCarriersPerScenario	ServicePackageOperationsConstraints	Table 7-5
maxRtrvlServicePackages	ServicePackageOperationsConstraints	Table 7-5
maxRtrvlServicePackagesPerTimePeriod	ServicePackageOperationsConstraints	Table 7-5
maxServicePackageTemporalSpan	ServicePackageOperationsConstraints	Table 7-5
maxServiceScenariosPerServicePackage	ServicePackageOperationsConstraints	Table 7-5
maxServiceScenarioTemporalSpan	ServicePackageOperationsConstraints	Table 7-5
maxSiStartTimeOffsetLead	ConfigurationProfileOperationsConstraints	Table 7-20
maxSiStopTimeOffsetLag	ConfigurationProfileOperationsConstraints	Table 7-20
maxSizeTrajectoryFilestore	TrajectoryPredictionOperationsConstraints	Table 7-15
maxSlsServicePackages	ServicePackageOperationsConstraints	Table 7-5
maxSlsServicePackagesPerTimePeriod	ServicePackageOperationsConstraints	Table 7-5
maxSpaceLinkEventsProfiles	ConfigurationProfileOperationsConstraints	Table 7-20
maxStorageSize	SupportingAntenna	Table 7-4
maxTransferServicesPerServicePackage	ServicePackageOperationsConstraints	Table 7-5
maxUpperBoundReportingPeriod	TransferServiceAgreement	Table 7-47
minDelayTime	FcltuProdAgreement	Table 7-36
minEventTemporalSpacing	ServiceAgreement	Table 7-3
plopOneIdleSequenceLength	FTcModulationProdAgreement	Table 7-35
minLowerBoundReportingPeriod	TransferServiceAgreement	Table 7-47
minServiceDefinitionLeadTime	ServicePackageOperationsConstraints	Table 7-5
minStorageSize	SupportingAntenna	Table 7-4
modulationIndexRange	F401SpaceLinkCarrierAgreement	Table 7-32
carrierModulationTypeOptions	R401SpaceLinkCarrierAgreement	Table 7-37
overflowPolicy	SupportingAntenna	Table 7-4
pcmFormatOptions	F401SpaceLinkCarrierAgreement	Table 7-32
phaseAmbiguityResolutionOptions	R401SpaceLinkCarrierAgreement	Table 7-37
plopInEffect	FTcModulationProdAgreement	Table 7-35
powerRatioOptions	R401SpaceLinkCarrierAgreement	Table 7-37
privateAnnotation	ServiceAgreement	Table 7-3
proposedServicePackageOwnerName	ProposeServicePackageOperationsConstraints	Table 7-12



## SPACE COMMUNICATION CROSS SUPPORT—SERVICE MANAGEMENT—SERVICE SPECIFICATION

Name	Data Set	Cross-reference
protocolAbortMode	FcltuProdAgreement	Table 7-36
ptScid	PacketTelemetryChannel	Table 7-44
ptVirtualChannels	PacketTelemetryChannel	Table 7-44
qsaRoutineTimeout	QueryServiceAgreementOperationConstraints	Table 7-31
qsaUrgentTimeout	QueryServiceAgreementOperationConstraints	Table 7-31
qslepRoutineTimeout	QuerySpaceLinkEventsProfileOperationConstraints	Table 7-26
qslepUrgentTimeout	QuerySpaceLinkEventsProfileOperationConstraints	Table 7-26
qscspRoutineTimeout	QuerySpaceCommunicationServiceProfileOperationConstraints	Table 7-23
qscspUrgentTimeout	QuerySpaceCommunicationServiceProfileOperationConstraints	Table 7-23
qspRoutineTimeout	QueryServicePackageOperationConstraints	Table 7-9
qspUrgentTimeout	QueryServicePackageOperationConstraints	Table 7-9
qtspRoutineTimeout	QueryTransferServiceProfileOperationConstraints	Table 7-29
qtspUrgentTimeout	QueryTransferServiceProfileOperationConstraints	Table 7-29
qtpRoutineTimeout	QueryTrajectoryPredictionOperationConstraints	Table 7-19
qtpUrgentTimeout	QueryTrajectoryPredictionOperationConstraints	Table 7-19
r401SpaceLinkCarrierAgreementId	R401SpaceLinkCarrierAgreement	Table 7-37
rEirp	R401SpaceLinkCarrierAgreement	Table 7-37
reportingChannelId	FcltuProdAgreement	Table 7-36
rfAvailabilityConfirmationRequired	FcltuProdAgreement	Table 7-36
rOnlineFrameBufferOverflowDiscard-Number	TransferServiceAgreement	Table 7-47
rOnlineFrameBufferSize	TransferServiceAgreement	Table 7-47
rPolarizationOptions	R401SpaceLinkCarrierAgreement	Table 7-37
rspRoutineTimeout	ReplaceServicePackageOperationConstraints	Table 7-7
rspUrgentTimeout	ReplaceServicePackageOperationConstraints	Table 7-7
rSubcarrierFrequencyRange	R401SubcarrierAgreement	Table 7-38
sasRoutineTimeout	SelectAlternateScenarioOperationConstraints	Table 7-10
sasUrgentTimeout	SelectAlternateScenarioOperationConstraints	Table 7-10
schedulingMode	ConfirmTentativeServicePackageOperationConstraints	Table 7-12
serviceAgreementStartTime	ServiceAgreement	Table 7-3
serviceAgreementStopTime	ServiceAgreement	Table 7-3
spacecraftName	ServiceAgreement	Table 7-3
spaceLinkEventsProfileSupported	ServiceAgreement	Table 7-3
spaceLinkEventsProfileSupported	ServiceAgreement	Table 7-3
subcarrierWaveformOptions	F401SubcarrierAgreement	table 7-33
supplementaryEventsReported	ServicePackageOperationsConstraints	Table 7-5
supportedAgency	ServiceAgreement	Table 7-3
supportedSccsSmOperations	ServiceAgreement	Table 7-3

<b>Name</b>	<b>Data Set</b>	<b>Cross-reference</b>
supportingAgency	<b>ServiceAgreement</b>	Table 7-3
symbolRateRange	<b>F401SymbolStreamAgreement</b>	Table 7-34
t1mRandomizationOptions	<b>RafProdAgreement</b>	Table 7-40
trajectoryFormatOptions	<b>TrajectoryPredictionOperationsConstraints</b>	Table 7-15
trajectoryPredictionDeletionMode	<b>TrajectoryPredictionOperationsConstraints</b>	Table 7-15
trajectoryPredictionTimeWindow-Extension	<b>ServicePackageOperationsConstraints</b>	Table 7-5
defaultTrajectoryRef	<b>DefaultTrajectoryPrediction</b>	Table 7-14
transferFrameLengthRange	<b>FecfOnlyAgreement</b>	Table 7-41
turboCodeRateOptions	<b>TurboCodingAgreement</b>	Table 7-43
viewInformationSource	<b>ServicePackageOperationsConstraints</b>	Table 7-5

## ANNEX E

### OVERVIEW OF UNIFIED MODELING LANGUAGE (UML) DIAGRAMMING CONVENTIONS

#### (INFORMATIVE)

#### E1 OVERVIEW

This annex provides an overview of the Unified Modeling Language (UML) Version 2.0 specification of the Object Management Group (OMG) diagramming notation, semantics, and conventions that are used in this Recommended Standard for the class diagrams, sequence diagrams, activity diagrams, and state machine diagrams contained herein.

#### E2 CLASS DIAGRAM

##### E2.1 GENERAL

A UML class diagram describes the structure of a message, its parts, and how those parts interrelate. A UML class, represented in the diagram as a box, represents a data set. Class diagram conventions include composition, generalization, multiplicity and constraints. Enumeration notation is also used but only when it is involved in a composition constraint.

##### E2.2 CLASS DIAGRAM EXAMPLE

Figure E-1 demonstrates the UML conventions that are used in the class diagrams.

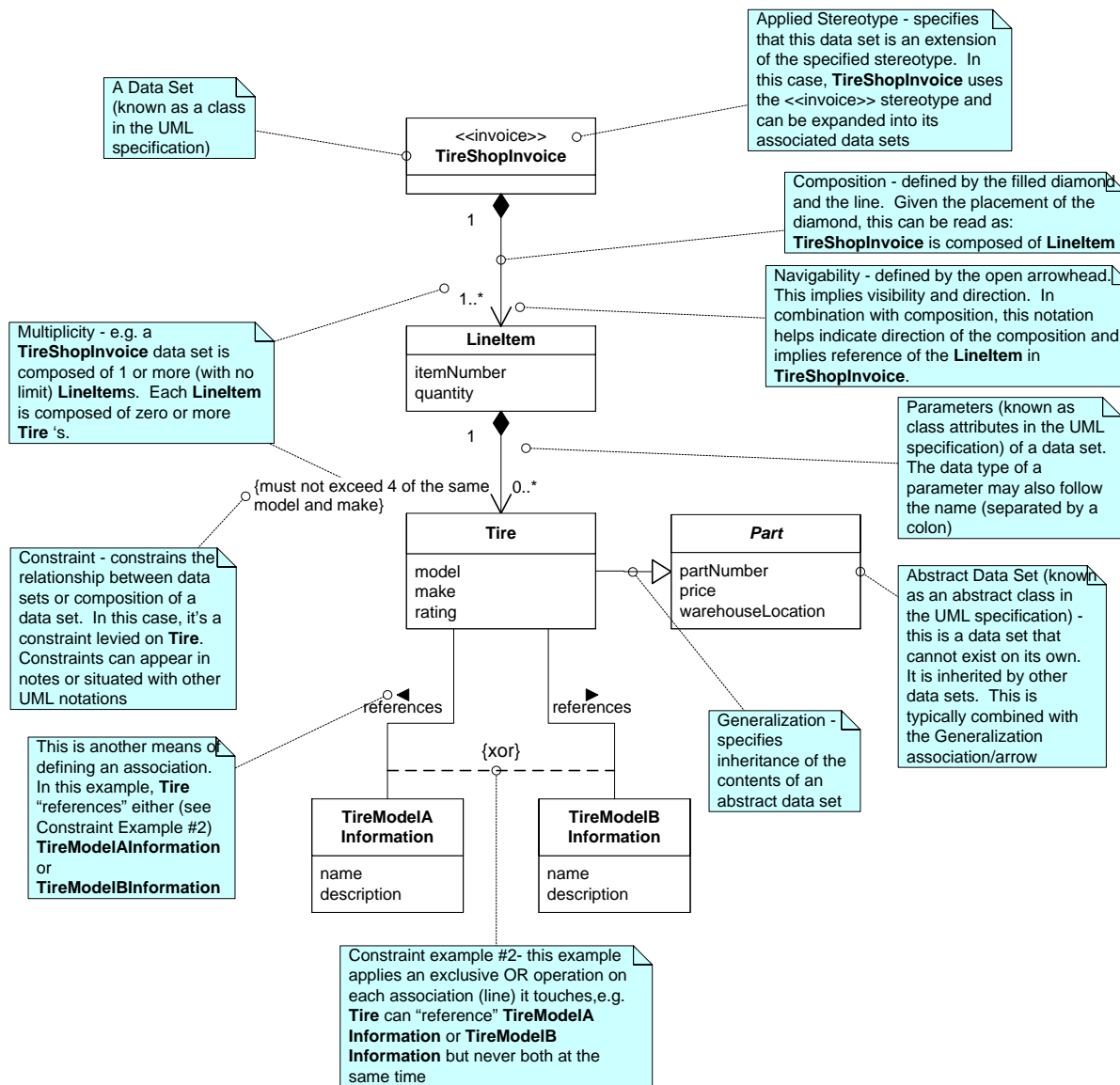

Figure E-1: Class Diagram Example

### E3 ACTIVITY DIAGRAM

#### E3.1 GENERAL

A UML activity diagram describes the possible actions that can take place given the flow of an invocation message of an operation procedure document exchange pattern. Activity diagram conventions include partitions to show whether UM or CM is responsible for the action, forks/joins to show parallel activity, guards and decisions/merges to guide flow, and pins to show parameterization of an action. The parameter pins are used in the definition of a stereotype or an activity group.

### E3.2 ACTIVITY DIAGRAM EXAMPLES

The following diagrams demonstrate the UML conventions used in the activity diagrams.

Activity Diagram 1 is illustrated in figure E-2. It shows the notion of ‘swim lanes’ and the lower-level graphical constructs used throughout the activity diagrams in the specification.

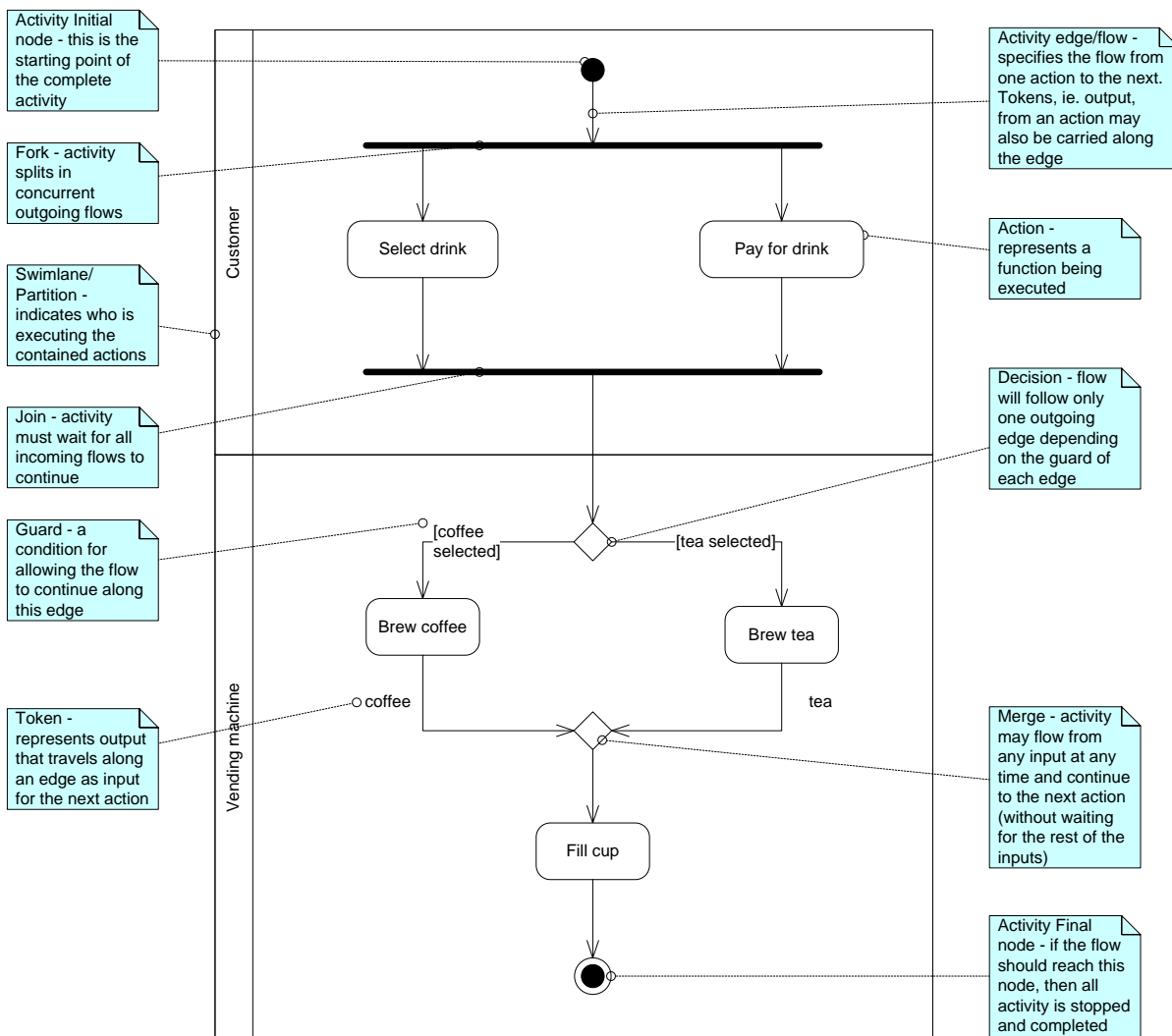

Figure E-2: Activity Diagram 1

Activity Diagram 2 is illustrated in figure E-3. It is an example of an activity diagram that ‘calls’ or utilizes another of the detailed activities stated in another activity diagram. This technique is used to factor-out commonly recurring activities in the specification such that they do not have to be repeated in detail in addressing higher-level activity flows.

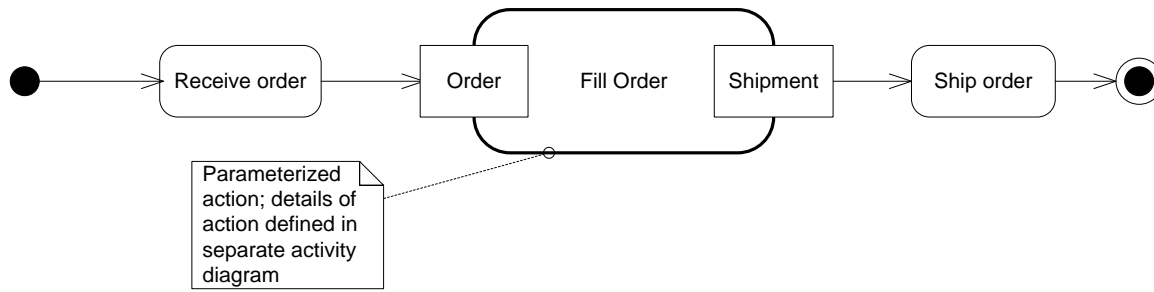

Figure E-3: Activity Diagram 2

Activity Diagram 3 is illustrated in figure E-4. It is an example of an activity diagram that is utilized or ‘called’ from another activity. As the intention is to have it utilized for multiple higher-level activities, it is parameterized. This example also identifies other graphical constructs used in the specification (such as ‘Parameter Pins’, etc.).

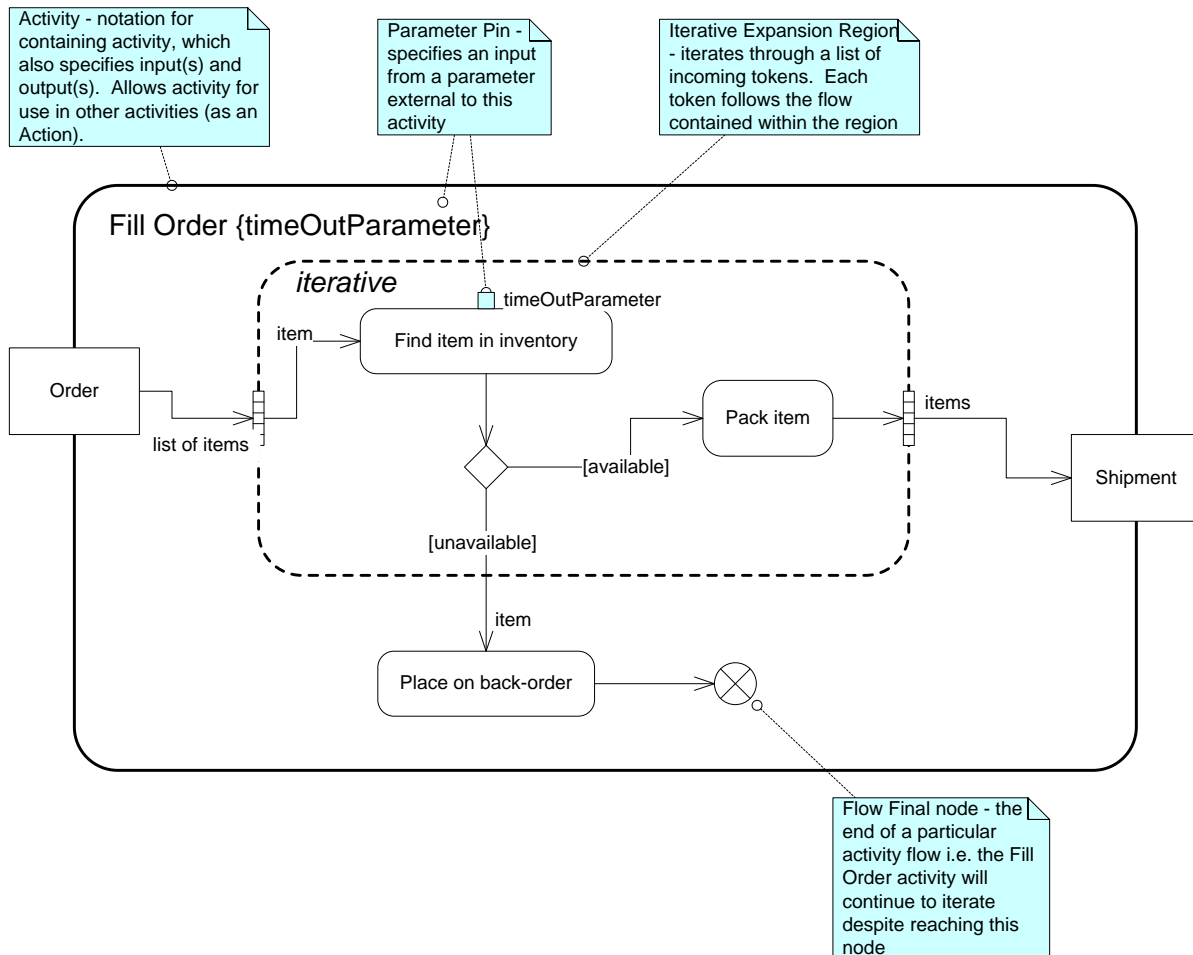

Figure E-4: Activity Diagram 3

## **E4 SEQUENCE DIAGRAM**

### **E4.1 GENERAL**

Sequence diagrams focus on message interactions between the UM and CM, clearly showing which messages are sent and who sends them. They describe the document exchange in a nominal scenario and use interaction frames to show conditional sequencing of messages, i.e., other scenarios.

### **E4.2 SEQUENCE DIAGRAM EXAMPLE**

Figure E-5 demonstrates the UML conventions used in the sequence diagrams.

UML provides a convention for specifying asynchronous and synchronous messages using variations in arrowheads. All messages in the specification of an operation are asynchronous, and thus all sequence diagrams will use the open arrowhead per the convention specified in the UML 2.0 specification.

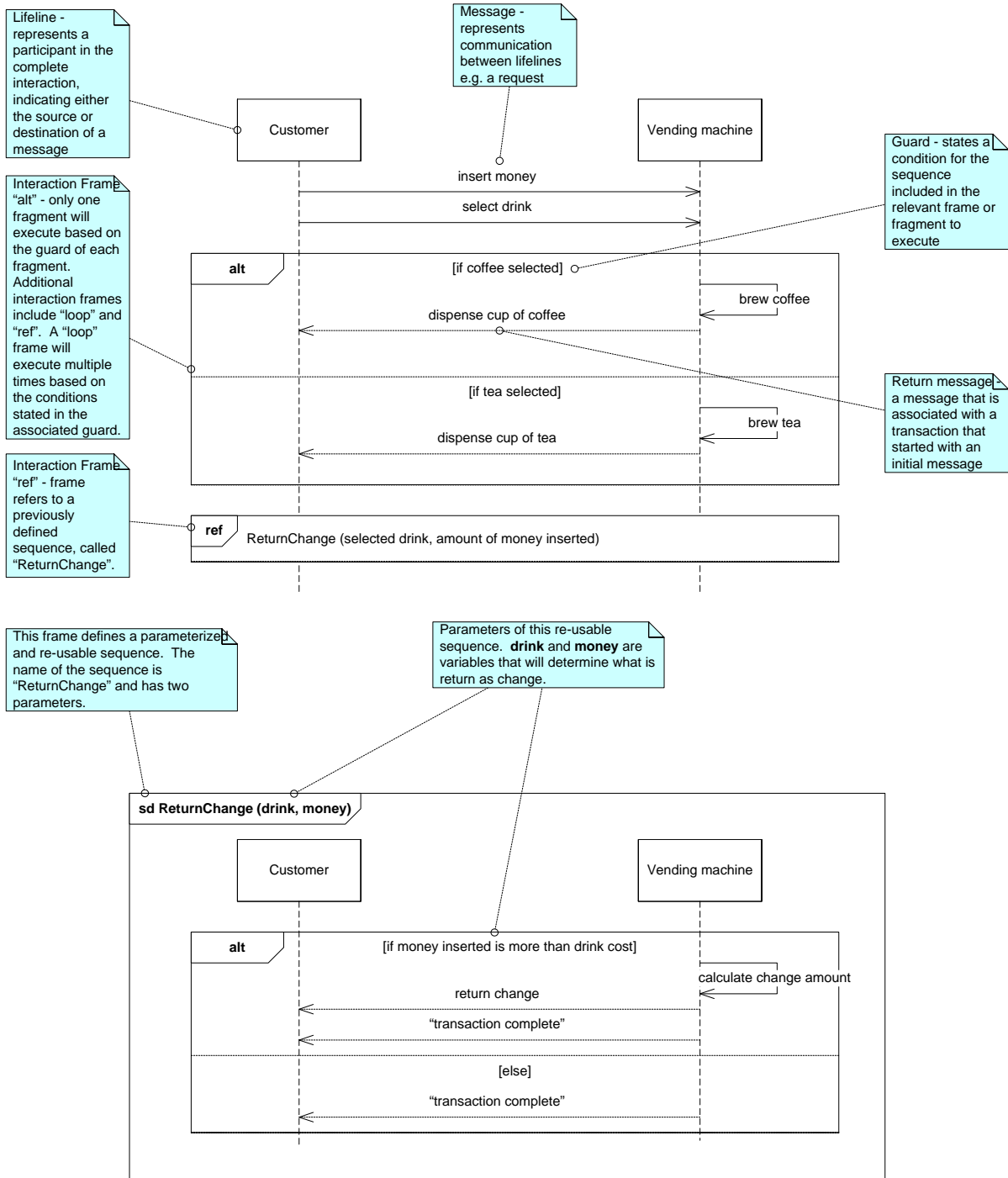

Figure E-5: Sequence Diagram Example



## E5 STATE MACHINE DIAGRAM

### E5.1 GENERAL

State machine diagrams show the dynamic behavior of an entity based on its response to events, showing how the entity reacts to events depending on its state. They can specify the behavior of an interaction from the point of view of one partner in the interaction. When the focus is on the dialogue between UM and CM, separate state machines show the behavior at either end. When the focus is on the life cycle of an information entity managed by CM in response to interaction with UM, then the states of that entity are shown as seen by CM.

### E5.2 STATE MACHINE DIAGRAM EXAMPLE

The following diagrams demonstrate the UML conventions used in the state machine diagrams.

Figure E-6 shows the same events have different effects depending on the state they arrive in, and possibly on ‘guard conditions’. For example, if the customer selects a drink before inserting enough money to pay for it, the machine transitions to the ‘Selected’ state, whereas if enough money has already been inserted, the machine immediately starts dispensing.

An event may cause a return to the same state, shown as an arrow returning to the state it starts from.

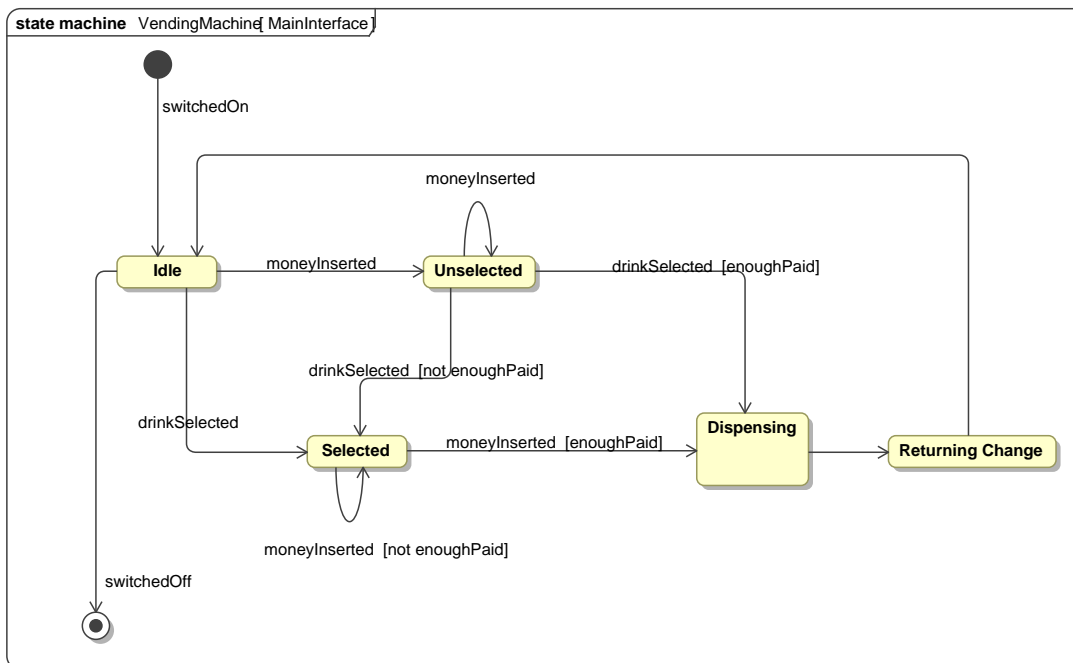

**Figure E-6: State Machine Diagram Example 1**

The ‘Dispensing’ state is a composite state: it has a number of substates. It is shown in detail in figure E-7.

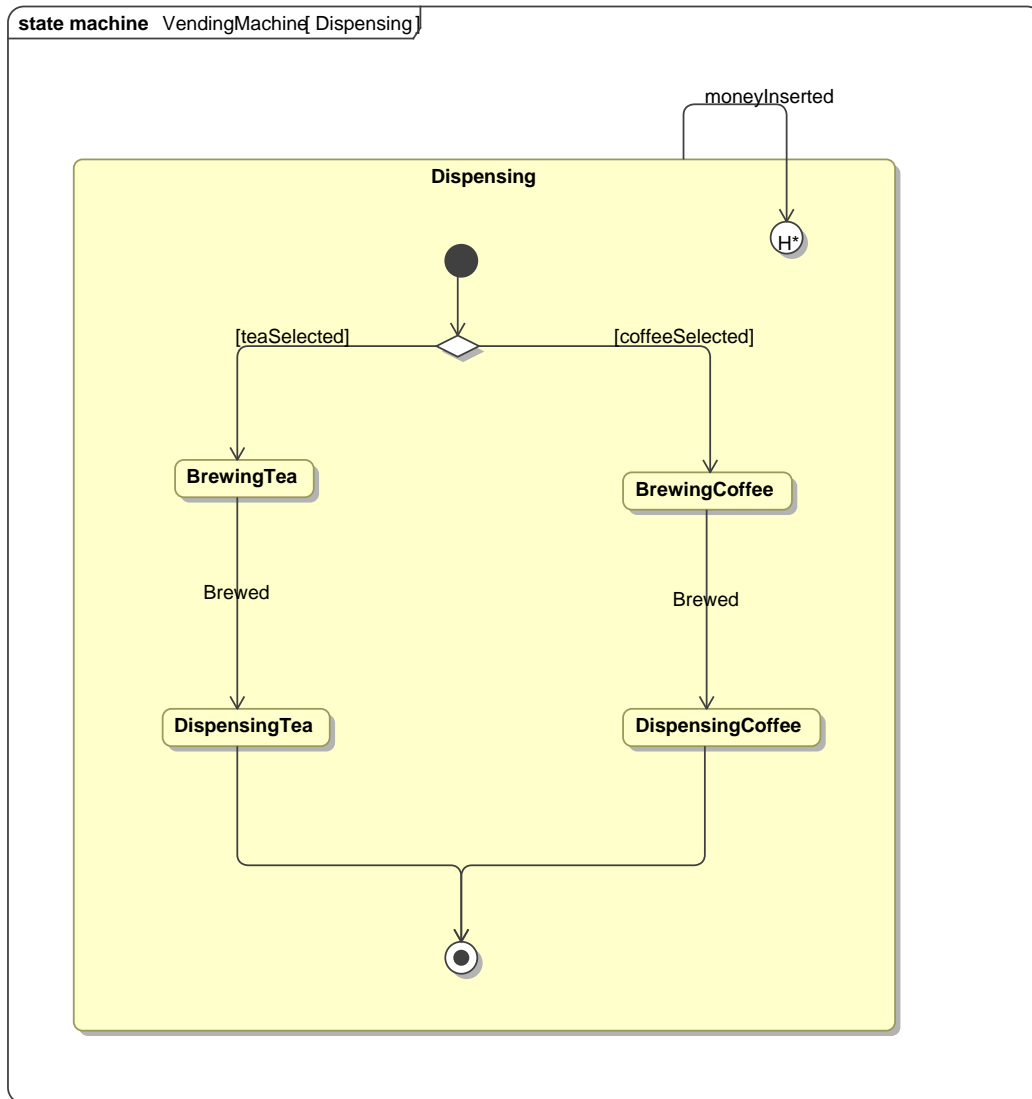

**Figure E-7: State Machine diagram Example 2**

If more money is inserted when the machine is already dispensing, it will go on with whatever it was already doing. This is shown by the ‘history’ pseudo-state (the ‘H’ in a circle), which means ‘return to the substate that the machine was in when it last left this state’.

U Utilization Management (UM) -indicates a requirement for UM

## ANNEX F

TIME PARAMETERS OF SCCS SERVICE MANAGEMENT  
INFORMATION ENTITIES

## (INFORMATIVE)

## F1 INTRODUCTION

This annex lists the time parameters associated with the various information entities that are managed through SCCS-SM, specifies the interrelationships between these parameters, and provides a graphical example of the interrelationships among timing parameters in a Service Package.

## F2 SCCS-SM TIME PARAMETERS

Table F-1 lists in alphabetical order the time-related parameters of the Service Package Request, the Service Package Result, the Proposed Service Package, the various configuration profiles that are used to generate the Service Package results and Proposed Service Packages, and the Service Agreement. Each parameter name is accompanied by the identification of the top-level information entity with which that parameter is associated. For each parameter, a description/definition is provided and the relationships with and constraints imposed by other SCCS-SM time parameters are specified, and references are provided to the tables in the main body in which these parameters are formally defined.

Table F-1: Time Parameters in SCCS-SM Information Entities

Parameter Name	Parameter Description/Definition, Relationships, and Constraints	Data Set
accessStartTime [Service Package Request]	Requested time to begin access to the DataStore for retrieval of data for delivery via the Retrieval Transfer Service instance. [UTC]	<b>Retrieval-Service-Package-Request</b> table 4-13
accessStopTime [Service Package Request]	Requested time to end access to the DataStore for retrieval of data. [UTC]	Same as for accessStartTime
carrierStartTime-Offset [Space Communication Service Profile]	Offset from the scheduled start time of the space communication service that contains this carrier. [Unsigned Integer, seconds] NOTE – The carrierStartTimeOffset is added to the scheduledSpaceCommServiceStartTime (Service Package Result) of the space communication service that contains the carrier. The carrier can start no earlier than the start of the space communication service of which it is a part.	<b>SpaceLink-Carrier-Profile</b> (table 5-4)

Parameter Name	Parameter Description/Definition, Relationships, and Constraints	Data Set
carrierStopTime-Offset [Space Communication Service Profile]	Offset from the scheduled stop time of the space communication service that contains this carrier. [Non-positive Integer, seconds] NOTE – The carrierStopTimeOffset is subtracted from the scheduledSpaceCommServiceStopTime (Service Package Result) of the space communication service that contains the carrier. The carrier can stop no later than the end of the space communication service of which it is a part.	Same as for carrierStartTimeOffset
eventScheduled-Time [Service Package Result]	The time at which the space link event is to occur, as measured at the antenna receiving/transmitting the signal, stated in absolute terms. [UTC]  If the timeReference of the referenced Space Link Events Profile is 'absolute', the eventScheduledTime is equal to the corresponding eventTime (Space Link Events Profile) in the referenced Space Link Events Profile.  If the timeReference of the referenced Space Link Events Profile is 'relative', the eventScheduledTime is equal to the corresponding eventTime (Space Link Events Profile) in the referenced Space Link Events Profile plus the scheduled-CarrierStartTime (Service Package Result) of the <b>CarrierResult</b> data set for the space link carrier with which the event is associated.	[F and R]-SpaceLink-Change-Scheduled-Event (table 4-31 and table 4-32)  [F and R]-SpaceLink-DataTransportChange-Scheduled-Event (table 4-35 and table 4-36)
eventTime [Space Link Events Profile]	The time at which an event is to occur. It can be expressed in either relative terms or absolute terms.  If expressed in relative terms, then eventTime is the time at which an event is to occur expressed relative to the stateStartTime (Space Link Events Profile) of the container [R F]SpaceLinkAvailableStates. [Positive Integer, seconds]  If expressed in absolute terms, the time is the spacecraft event time (SCET). [UTC] NOTE – The absolute time for the event is returned as the scheduledEventTime (Service Package Result), a parameter of the Service Package Result.	[F and R]-SpaceLink-ChangeEvent (table 5-51 and table 5-55)  [F and R]-spaceLink-DataTransportChange-Event (table 5-53 and table 5-54)
eventTimeWindow-Lag [Service Package Result]	An offset that is added to the eventScheduledTime (Service Package Result) in a Space Link Events Result to specify the latest time that the event may occur. [Positive Integer seconds]	Same as for eventScheduledTime
eventTimeWindow-Lag [Space Link Events Profile]	An offset that is added to the eventScheduledTime (Service Package Result) in a Space Link Events Result to specify the latest time that the event may occur. [Positive Integer, seconds]	Same as for eventTime
eventTimeWindow-Lead [Service Package Result]	An offset that is subtracted from the eventScheduledTime (Service Package Result) in a Space Link Events Result to specify the earliest time that the event may occur. [Positive Integer seconds]	Same as for eventScheduledTime
eventTimeWindow-Lead [Space Link Events Profile]	An offset that is subtracted from the eventScheduledTime (Service Package Result) in a Space Link Events Result to specify the earliest time that the event may occur. [Positive Integer, seconds]	Same as for eventTime

Parameter Name	Parameter Description/Definition, Relationships, and Constraints	Data Set
maxEventTime-WindowLag [Service Agreement]	Maximum value allowed for the parameter eventTimeWindowLag (Space Link Events Profile) in the <b>[R F]SpaceLinkChangeEvent</b> and <b>[R F]SpaceLinkDataTransportChangeEvent</b> data sets. This parameter is only required if Space Link Events Profiles are supported by the Service Agreement. [Unsigned Integer, seconds]  If Space Link Events Profiles are not supported, this parameter is NULL.	<b>Service-Agreement</b> (table 7-3)
maxEventTime-WindowLead [Service Agreement]	Maximum value allowed for the parameter eventTimeWindowLead (Space Link Events Profile) in the <b>[R F]SpaceLinkChangeEvent</b> and <b>[R F]SpaceLinkDataTransportChangeEvent</b> data sets. This parameter is only required if Space Link Events Profiles are supported by the Service Agreement. [Unsigned Integer, seconds]  If Space Link Events Profiles are not supported, this parameter is NULL.	<b>Service-Agreement</b> (table 7-3)
maxService-Package-TemporalSpan [Service Agreement]	Maximum allowed time interval between the scheduledServicePackageStartTime (Service Package Result) and scheduledServicePackageStopTime (Service Package Result) for all Service Packages. [Unsigned Integer, seconds]	<b>Service-Package-Operations-Constraints</b> (table 7-5)
maxService-Scenario-TemporalSpan [Service Agreement]	Maximum allowed time interval between the earliest scheduledSpaceCommServiceStartTime (Service Package Result) and the latest scheduledSpaceComm-ServiceStopTime (Service Package Result) for all <b>SpaceCommunicationServiceRequest</b> data sets within a <b>ServiceScenarioResult</b> data set. [Unsigned Integer, seconds]	<b>Service-Package-Operations-Constraints</b> (table 7-5)
maxSiStartTime-OffsetLead [Service Agreement]	Maximum allowed lead time offset value for parameter startTimeOffset in any SLS Transfer Service Profiles. [Unsigned Integer, seconds] NOTE – This constraint only applies to startTimeOffset values less than zero, in which case the absolute value of startTimeOffset is used to evaluate against this constraint.	<b>ConfigurationProfile-Operations-Constraints</b> (table 7-20)
maxSiStopTime-OffsetLag [Service Agreement]	Maximum allowed lag time offset value for parameter stopTimeOffset in any SLS Transfer Service Profiles. [Unsigned Integer, seconds]	<b>ConfigurationProfile-Operations-Constraints</b> (table 7-20)
minEventTemporal-Spacing [Service Agreement]	Minimum allowed time between Space Link Events. [Unsigned Integer, seconds]	<b>Service-Agreement</b> (table 7-3)

Parameter Name	Parameter Description/Definition, Relationships, and Constraints	Data Set
minimumService-Duration [Service Package Request]	<p>The minimum duration of space communication service required. If multiple carriers are being requested via the referenced Space Communication Service Profile, the value of minimumService-Duration corresponds to the shortest duration that is viable for the carrier that requires the longest duration in the service. [Positive Integer, seconds]</p> <p>The minimumServiceDuration is less than or equal to maxServiceScenarioTemporalSpan (Service Agreement).</p> <p>NOTES:</p> <ol style="list-style-type: none"> <li>1 If multiple carriers are being requested via the referenced Space Communication Service Profile, a carrier may have duration shorter than minimumServiceDuration if its carrierStartTimeOffset and/or carrierStopTimeOffset are non-zero in the Space Communication Service Profile.</li> <li>2 If there are to be multiple acquisitions and loss of signal (e.g., because of occulting planetary body) for a given carrier, this parameter indicates the minimum duration for the entire contact, including the intervening loss(es) of signal.</li> </ol>	<b>Space-Communication-Service-Request</b> (table 4-7)
minService-Definition-LeadTime [Service Agreement]	Minimum time interval before the start of the Service Package utilization phase by which the Service Package is supposed to be fully defined. [Unsigned Integer, seconds]	<b>Service-Package-Operations-Constraints</b> (table 7-5)
preferredService-Duration [Service Package Request]	<p>The preferred duration of the space communication service. If multiple carriers are being requested via the referenced Space Communication Service Profile, the value of preferredServiceDuration corresponds to the desired duration of the carrier that requires the longest duration in the service. [Positive Integer, seconds]</p> <p>The preferredServiceDuration is less than or equal to maxServiceScenarioTemporalSpan (Service Agreement).</p> <p>NOTES:</p> <ol style="list-style-type: none"> <li>1 This can also be thought of as a maximum acquisition contact duration desired by UM.</li> <li>2 If there are multiple acquisitions and loss of signal (e.g., because of occulting planetary body) for a given carrier, this parameter indicates the preferred duration for the entire contact, including the intervening loss(es) of signal.</li> </ol>	Same as for minimum-Service-Duration
scheduledAccess-StartTime [Service Package Result]	<p>Scheduled time to begin access to the DataStore for retrieval of data for delivery via the Retrieval Transfer Service instance. [UTC]</p> <p>The scheduled access start time is equal to the accessStartTime (Service Package Request) of the Service Package Request that initiated the generation of the Service Package.</p>	<b>RetrievalTs-Instance-Result</b> (table 4-37)  <b>Bilateral-RetrievalTs-Instance-Result</b> (table 4-38)

Parameter Name	Parameter Description/Definition, Relationships, and Constraints	Data Set
scheduledAccess-StopTime [Service Package Result]	<p>Scheduled time to end access to the DataStore for retrieval of data. [UTC]</p> <p>The scheduled access stop time is equal to the accessStopTime (Service Package Request) of the Service Package Request that initiated the generation of the Service Package.</p>	Same as for scheduled-AccessStartTime
scheduledCarrier-StartTime [Service Package Result/ Proposed Service Package]	<p>The time at which the carrier is scheduled to start. [UTC]</p> <p>The scheduled carrier start time is equal to the scheduledSpaceCommServiceStartTime (Service Package Result) of the <b>SpaceCommunicationServiceResult-ProposedSpaceCommunicationService</b> data set that contains the <b>CarrierResult/ProposedCarrier</b> data set for that carrier, plus the carrierStartTimeOffset (Space Communication Service Profile) for that carrier in the Space Communication Service Profile that is referenced by that <b>SpaceCommunicationServiceResult/ProposedSpaceCommunicationService</b> data set.</p>	<p><b>Carrier-Result</b> (table 4-25)</p> <p><b>Proposed-Carrier</b> (table 4-99)</p>
scheduledCarrier-StopTime [Service Package Result/ Proposed Service Package]	<p>The time at which the carrier is scheduled to stop. [UTC]</p> <p>The scheduled carrier stop time is equal to the scheduledSpaceCommServiceStopTime (Service Package Result) of the <b>SpaceCommunicationServiceResult-ProposedSpaceCommunicationService</b> data set that contains the <b>CarrierResult/ProposedCarrier</b> data set for that carrier, plus the carrierStopTimeOffset (Space Communication Service Profile) for that carrier in the Space Communication Service Profile that is referenced by that <b>SpaceCommunicationServiceResult/ProposedSpaceCommunicationService</b> data set.</p>	Same as for scheduled-Carrier-StartTime
scheduledService-InstanceStartTime [Service Package Result/ Proposed Service Package]	<p>Time that the Complex makes the transfer service port for the transfer service instance available for a transfer service bind operation from the transfer service user. [UTC]</p> <p>The scheduled service instance start time is equal to the value of the startTimeOffset of the SLS Transfer Service Profile that characterizes the transfer service instance, plus the scheduledCarrierStartTime (Service Package Result) of the first (earliest-starting) space link carrier that references that transfer service instance in all <b>SpaceCommunicationServiceResult</b> data sets for all scenarios in the Service Package.</p> <p>A space link carrier in a <b>SpaceCommunicationService-Result</b> data set references a transfer service instance if the transferServiceProfileRef of the transfer service instance is equal to the transferServiceProfileRef of a transfer service map (TsM) data set that is contained by the Space Communication Service Profile that is referenced by the <b>SpaceCommunicationServiceResult</b> data set.</p>	<p><b>SlsTs-Instance-Result</b> (table 4-23)</p> <p><b>BilateralSlsTsInstance-Result</b> (table 4-24)</p> <p><b>ProposedSls-TsInstance</b> (table 4-98)</p>

Parameter Name	Parameter Description/Definition, Relationships, and Constraints	Data Set
<p>scheduledService-InstanceStopTime [Service Package Result/Proposed Service Package]</p>	<p>Time that the Complex will disable the transfer service port for the transfer service instance. [UTC]</p> <p>The scheduled service instance stop time is equal to the value of the stopTimeOffset of the SLS Transfer Service Profile that characterizes the transfer service instance, plus the scheduledCarrierStopTime (Service Package Result/Proposed Service Package) of the last (latest-ending) space link carrier that references that transfer service instance in all <b>SpaceCommunicationServiceResult/ProposedSpaceCommunicationService</b> data sets for all scenarios in the Service Package.</p> <p>A space link carrier in a <b>SpaceCommunicationService-Result</b> data set references a transfer service instance if the transferServiceProfileRef of the transfer service instance is equal to the transferServiceProfileRef of a transfer service map (TsM) data set that is contained by the Space Communication Service Profile that is referenced by the <b>SpaceCommunicationServiceResult</b> data set.</p>	<p>Same as for scheduled-Service-Instance-StartTime</p>
<p>scheduledService-PackageStartTime [Service Package Result/Proposed Service Package]</p>	<p>Time at which the Service Package is scheduled to start. [UTC]</p> <p>The scheduled start of the Service Package is equal to the earlier of:</p> <ul style="list-style-type: none"> <li>a) the value of the scheduledSpaceCommServiceStartTime (Service Package Result) of the first (earliest-starting) <b>SpaceCommunicationServiceResult/ProposedSpaceCommunicationService</b> data set for all scenarios in the Service Package; and</li> <li>b) the value of the scheduledServiceInstanceStartTime (Service Package Result) of the first (earliest-starting) transfer service instance in all <b>SlsTsInstanceResult/ProposedTsInstanceResult</b> and <b>BilateralSlsTsInstanceResult</b> data sets in the Service Package.</li> </ul> <p>The scheduledServicePackageStartTime is later than the ServiceAgreementStartTime (Service Agreement).</p> <p>At (scheduledServicePackageStartTime minus minServiceDefinitionLeadTime (Service Agreement)), the scheduledServicePackageStartTime is later than the trajectoryStartTime (Trajectory Prediction) of the earliest-starting Trajectory Prediction referenced by the Service Package, minus trajectoryPredictionTimeWindowExtension (Service Agreement).</p> <p>The time span between scheduledService-PackageStartTime and scheduledService-PackageStopTime (Service Package Result/Proposed Service Package) is equal to or less than maxServicePackageTemporalSpan (Service Agreement).</p>	<p><b>SpaceLink-Session-Service-Package-Result</b> (table 4-19)</p> <p><b>Proposed-Service-Package</b> (table 4-94)</p>



Parameter Name	Parameter Description/Definition, Relationships, and Constraints	Data Set
<p>scheduledServicePackageStopTime [Service Package Result/Proposed Service Package]</p>	<p>Time at which the Service Package is scheduled to stop. [UTC]</p> <p>The scheduled stop of the Service Package is equal to the later of:</p> <p>a) the value of the scheduledSpaceCommServiceStopTime (Service Package Result/Proposed Service Package) of the last (latest-ending) <b>SpaceCommunicationServiceResult/ProposedSpaceCommunicationService</b> data set for all scenarios in the Service Package; and</p> <p>b) the value of the scheduledServiceInstanceStartTime (Service Package Result/Proposed Service Package) of the last (latest-ending) transfer service instance in all <b>SlsTsInstanceResult/ProposedSlsTsInstance</b> and <b>BilateralSlsTsInstanceResult</b> data sets in the Service Package.</p> <p>The scheduledServicePackageStopTime is earlier than the ServiceAgreementStoptTime (Service Agreement).</p> <p>At (scheduledServicePackageStartTime (Service Package Result/Proposed Service Package) minus minServiceDefinitionLeadTime (Service Agreement)), the scheduledServicePackageStopTime is earlier than the trajectoryStopTime (Trajectory Prediction) of the latest-ending Trajectory Prediction referenced by the Service Package, plus trajectoryPredictionTimeWindowExtension (Service Agreement).</p> <p>The time span between scheduledServicePackageStartTime (Service Package Result/Proposed Service Package) and scheduledServicePackageStopTime is equal to or less than maxServicePackageTemporalSpan (Service Agreement).</p>	<p>Same as for scheduledServicePackageStartTime</p>

Parameter Name	Parameter Description/Definition, Relationships, and Constraints	Data Set
<p>scheduledSpaceCommServiceStartTime</p> <p>[Service Package Result/Proposed Service Package]</p>	<p>Time at which the space communication service is scheduled to start. [UTC]</p> <p>For a Service Package created via the CSP or replaced via the RSP, the scheduledSpaceCommServiceStartTime is no earlier than (spaceCommServiceStartTime (Service Package Request) minus spaceCommServiceStartTimeLead (Service Package Request)) and no later than (spaceCommServiceStartTime plus spaceCommServiceStartTimeLag (Service Package Request)) of the <b>SpaceCommunicationServiceRequest</b> data set of the Service Package Request that initiated the generation of the Service Package.</p> <p>The scheduledSpaceCommServiceStartTime is later than the ServiceAgreementStartTime (Service Agreement).</p> <p>At (scheduledServicePackageStartTime (Service Package Result/Proposed Service Package) minus minServiceDefinitionLeadTime (Service Agreement)), the scheduledSpaceCommServiceStartTime is later than the trajectoryStartTime (Trajectory Prediction) of the earliest-starting Trajectory Prediction referenced by the Service Scenario containing the Space Communication Service Request, minus trajectoryPredictionTimeWindowExtension (Service Agreement).</p> <p>The time span between the scheduledSpaceCommServiceStartTime of a <b>SpaceCommunicationServiceResult/ProposedSpaceCommunicationService</b> data set and the scheduledSpaceCommServiceStopTime (Service Package Result/Proposed Service Package) of any <b>SpaceCommunicationServiceResult/ProposedSpaceCommunicationService</b> data set in the same <b>ServiceScenarioResult</b> data set is equal to or less than maxServiceScenarioTemporalSpan (Service Agreement).</p>	<p><b>SpaceCommunicationServiceResult</b> (table 4-22)</p> <p><b>ProposedSpaceCommunicationService</b> (table 4-97)</p>

Parameter Name	Parameter Description/Definition, Relationships, and Constraints	Data Set
<p>scheduledSpaceCommServiceStopTime [Service Package Result/Proposed Service Package]</p>	<p>The time at which the space communication service is scheduled to stop. [UTC]</p> <p>For a Service Package created via the CSP or replaced via the RSP, the scheduledSpaceCommServiceStopTime is no earlier than (scheduledSpaceCommServiceStartTime minus minimumServiceDuration (Service Package Request)) and no later than (scheduledSpaceCommServiceStartTime plus spaceCommServiceStartTimeLag (Service Package Request)) of the <b>SpaceCommunicationServiceRequest</b> data set of the Service Package Request that initiated the generation of the Service Package.</p> <p>The scheduledSpaceCommServiceStopTime is earlier than the ServiceAgreementStopTime (Service Agreement).</p> <p>At (scheduledServicePackageStartTime (Service Package Result/Proposed Service Package) minus minServiceDefinitionLeadTime (Service Agreement)), the scheduledSpaceCommServiceStopTime is earlier than the trajectoryStopTime (Trajectory Prediction) of the latest-ending Trajectory Prediction referenced by the Service Scenario containing the Space Communication Service Request, plus trajectoryPredictionTimeWindowExtension (Service Agreement).</p> <p>The time span between the scheduledSpaceCommServiceStopTime of a <b>SpaceCommunicationServiceResult</b> data set and the scheduledSpaceCommServiceStartTime (Service Package Result/Proposed Service Package) of any <b>SpaceCommunicationServiceResult/ProposedSpaceCommunicationService</b> data set in the same <b>ServiceScenarioResult</b> data set is equal to or less than maxServiceScenarioTemporalSpan (Service Agreement).</p>	<p>Same as for scheduledSpaceCommServiceStartTime</p>
<p>serviceAgreementStartTime [Service Agreement]</p>	<p>Date and time that the Service Agreement period starts. [UTC]</p>	<p><b>Service-Agreement</b> (table 7-3)</p>
<p>serviceAgreementStopTime [Service Agreement]</p>	<p>Date and time that the Service Agreement period ends. [UTC]</p>	<p><b>Service-Agreement</b> (table 7-3)</p>
<p>spaceCommServiceStartTime [Service Package Request]</p>	<p>Requested time to begin the space communication service for the given scenario. The start of the space communication service corresponds to the start of the first (earliest-starting) space link carrier being requested via the referenced Space Communication Service Profile for the given scenario. [UTC]</p> <p>The spaceCommServiceStartTime minus the spaceCommServiceStartTimeLead (Service Package Request) is later than ServiceAgreementStartTime (Service Agreement).</p>	<p><b>Space-CommunicationService-Request</b> (table 4-7)</p>
<p>spaceCommServiceStartTimeLag [Service Package Request]</p>	<p>Offset, relative to spaceCommServiceStartTime (Service Package Request), that indicates the latest time that the space communication service may begin. [Unsigned Integer, seconds]</p>	<p>Same as for minimumServiceDuration</p>

Parameter Name	Parameter Description/Definition, Relationships, and Constraints	Data Set
spaceComm-ServiceStart-TimeLead [Service Package Request]	Offset, relative to spaceCommServiceStartTime (Service Package Request) that indicates earliest time that the space link session may begin. [Unsigned Integer, seconds]	Same as for minimum-Service-Duration
startTimeOffset [SLS Transfer Service Profile]	<p>Offset that is to be added to the scheduledCarrierStartTime (Service Package Result) of the earliest-starting carrier which references a Transfer Service instance of this Transfer Service Profile, for the purpose of establishing the beginning of availability of the Transfer Service instance. [Integer, seconds]</p> <p>If startTimeOffset is less than zero, then the absolute value of startTimeOffset is not greater than maxSiStartTimeOffsetLead (Service Agreement).</p> <p>NOTE – A negative start time offset means that the service instance starts before the earliest-starting carrier that uses it starts, and a positive start time offset means that the service instance starts after the earliest-starting carrier that uses it starts.</p>	<p><b>Fcltu-Transfer-Service-Profile</b> (table 5-80)</p> <p><b>RafTransfer-Service-Profile</b> (table 5-79)</p> <p><b>RcfTransfer-Service-Profile</b> (table 5-80)</p>
stateEndTime [Space Link Events Profile]	<p>Expected or predicted time at which the state is terminated.</p> <p>If expressed in relative terms, then stateEndTime is the time at which an event is to occur expressed relative to the scheduledCarrierStartTime (Service Package Result) of the <b>SpaceCommunicationServiceResult</b> data set referencing the carrier profile associated with the space link events profile. [Positive Integer, seconds]</p> <p>If expressed in absolute terms, the time is the spacecraft event time (SCET). [UTC]</p>	<p><b>[F and R]-SpaceLink-Available-State</b> (table 5-49 and table 5-51)</p> <p><b>[F and R]-SpaceLink-Data-Transport-State</b> (table 5-53 and table 5-54)</p>
stateEndTime-WindowLag [Service Package Result]	An offset that is added to the stateScheduledEndTime (Service Package Result) in a Space Link Events Result to specify the latest time that the carrier lock may be lost. [Positive Integer seconds]	Same as for stateScheduledEndTime
stateEndTime-WindowLag [Space Link Events Profile]	An offset that is added to the stateScheduledEndTime (Service Package Result) in a Space Link Events Result to specify the latest time that the carrier lock may be lost. [Positive Integer, seconds]	Same as for stateEndTime
stateEndTime-WindowLead [Service Package Result]	An offset that is subtracted from the stateScheduledEndTime (Service Package Result) in a Space Link Events Result to specify the earliest time that the carrier lock may be lost. [Positive Integer seconds]	Same as for stateScheduledEndTime
stateEndTime-WindowLead [Space Link Events Profile]	An offset that is subtracted from the stateScheduledEndTime (Service Package Result) in a Space Link Events Result to specify the earliest time that the carrier lock may be lost. [Positive Integer, seconds]	Same as for stateEndTime

Parameter Name	Parameter Description/Definition, Relationships, and Constraints	Data Set
stateScheduledEndTime [Service Package Result]	<p>The time at which the space link availability interval is to end, as measured at the antenna receiving/transmitting the signal, stated in absolute terms. [UTC]</p> <p>If the timeReference of the referenced Space Link Events Profile is 'absolute', the stateScheduledEndTime is equal to the corresponding stateEndTime (Space Link Events Profile) in the referenced Space Link Events Profile.</p> <p>If the timeReference of the referenced Space Link Events Profile is 'relative', the stateScheduledEndTime is equal to the corresponding stateEndTime (Space Link Events Profile) in the referenced Space Link Events Profile plus the scheduledCarrierStartTime (Service Package Result of the <b>CarrierResult</b> data set for the space link carrier with which the state is associated).</p>	<p>[F and R]-SpaceLink-Available-Scheduled-State (table 4-29 and table 4-30)</p> <p>[F and R]-SpaceLink-Data-Transport-Scheduled-State (table 4-33 and table 4-34)</p>
stateScheduledStartTime [Service Package Result]	<p>The time at which the space link availability interval is to occur, as measured at the antenna receiving/transmitting the signal, stated in absolute terms. [UTC]</p> <p>If the timeReference of the referenced Space Link Events Profile is 'absolute', the stateScheduledStartTime is equal to the corresponding stateStartTime (Space Link Events Profile) in the referenced Space Link Events Profile.</p> <p>If the timeReference of the referenced Space Link Events Profile is 'relative', the stateScheduledStartTime is equal to the corresponding stateStartTime (Space Link Events Profile) in the referenced Space Link Events Profile plus the scheduledCarrierStartTime (Service Package Result) of the <b>CarrierResult</b> data set for the space link carrier with which the state is associated.</p>	Same as for stateScheduledEndTime
stateStartTime [Space Link Events Profile]	<p>Expected or predicted time at which state is established.</p> <p>If expressed in relative terms, then stateStartTime is the time at which an event is to occur expressed relative to the scheduledCarrierStartTime (Service Package Result) of the <b>SpaceCommunicationServiceResult</b> data set referencing the carrier profile associated with the space link events profile. [Positive Integer, seconds]</p> <p>If expressed in absolute terms, the time is the spacecraft event time (SCET). [UTC]</p>	Same as for stateEndTime
stateStartTime-WindowLag [Service Package Result]	An offset that is added to the stateScheduledStartTime (Service Package Result) in a Space Link Events Result to specify the latest time that the carrier acquisition may occur. [Positive Integer seconds]	Same as for stateScheduledEndTime
stateStartTime-WindowLag [Space Link Events Profile]	An offset that is added to the stateScheduleStartTime (Service Package Result) in a Space Link Events Result to specify the latest time that the carrier acquisition may occur. [Positive Integer, seconds]	Same as for stateEndTime

Parameter Name	Parameter Description/Definition, Relationships, and Constraints	Data Set
stateStartTime-WindowLead [Service Package Result]	An offset that is subtracted from the stateScheduledStartTime (Service Package Result) in a Space Link Events Result to specify the earliest time that the carrier acquisition may occur. [Positive Integer seconds]	Same as for stateScheduledEndTime
stateStartTime-WindowLead [Space Link Events Profile]	An offset that is subtracted from the stateScheduledStartTime (Service Package Result) in a Space Link Events Result to specify the earliest time that the carrier acquisition may occur. [Positive Integer, seconds]	Same as for stateEndTime
stopTimeOffset [SLS Transfer Service Profile]	Offset that is to be added to the scheduledCarrierStopTime (Service Package Result) of the earliest-ending carrier which references a Transfer Service instance of this Transfer Service Profile, for the purpose of establishing the end of availability of the Transfer Service instance. [Integer, seconds]  If stopTimeOffset is greater than zero, then startTimeOffset is not greater than maxSiStopTimeOffsetLag (Service Agreement).  NOTE – A negative stop time offset means that the service instance stops before the latest-ending carrier that uses it stops, and a positive stop time offset means that the service instance stop after the latest-ending carrier that uses it stops.	Same as for startTimeOffset
trajectory-PredictionTime-WindowExtension [Service Agreement]	Specifies the amount of time prior to the scheduledServicePackageStartTime (Service Package Result) and following the scheduledServicePackageStopTime (Service Package Result) for which a Trajectory Prediction is supposed to be available in order to be used to generate acquisition data to support the Service Package. [Unsigned Integer, seconds]	<b>Service-Package-Operations-Constraints</b> (table 7-5)
trajectoryStartTime [Trajectory Prediction]	The initial time for which the data contained within the segment is valid for use for the purposes of predicting the trajectory of the space element at the specified grade. [UTC]	<b>Trajectory-Prediction-Segment</b> (table 6-5)
trajectoryStopTime [Trajectory Prediction]	The ending time for which the data contained within the segment is valid for use for the purposes of predicting the trajectory of the space element at the specified grade. [UTC] NOTE – For OPM-bearing trajectory segments, the contained state vector is to be propagated until the trajectoryStopTime or later.	Same as for trajectoryStartTime

### F3 EXAMPLE SPACE LINK SESSION SERVICE PACKAGE RESULT

Figures F-1 and F-2 graphically illustrate an example of timing relationships among the various components of a Space Link Session Service Package as it is represented in a **SpaceLinkSessionServicePackageResult**. The different data sets that comprise the **SpaceLinkSessionServicePackageResult** are represented by bars of different colors. The beginning (left side) of the bar corresponds to the start time of the physical or logical component described by that data set. The end (right side) of the bar corresponds to the end time of the physical or logical component described by that data set.

The example illustrated in these figures represent the following scenario:

- The Service Package establishes two Space Communication Service instances, one for each of two Complex antennas (ground stations), corresponding to the track of the

satellite by using two antennas with an overlap to provide a longer pass and delivery of data.

- The ServicePackage handles only telemetry (return carrier).
- The ServicePackage employs a Space Link Events sequence (where an occultation occurs during the tracking of the first antenna).

Figure F-1 illustrates the top-level timing relationships within the Service Package Result, down to the component **SpaceCommunicationServiceResult** data sets. Figure F-2 illustrates the timing relationships among the components that comprise the first **SpaceCommunicationServiceResult** data set. Parameters are shown in color to match the containing data set. Parameters shown in grey are taken from profiles and are used to calculate the result, but do not appear in the result data set.

NOTE – This example illustrates a few but not all relationships among timing parameters. The complete description of the relationships are found in the table.

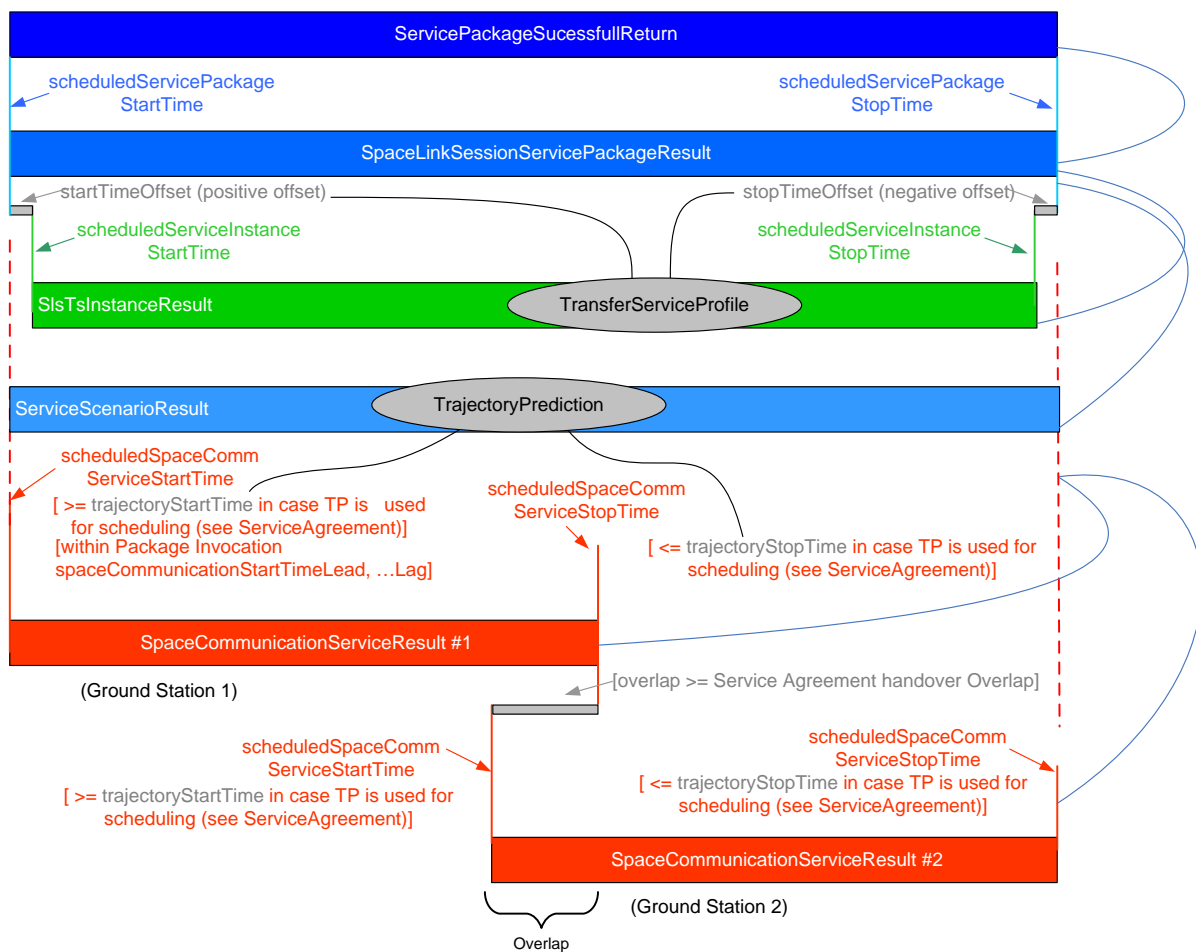

**Figure F-1: Example Top-Level Timing Relationships in a Service Package Result**

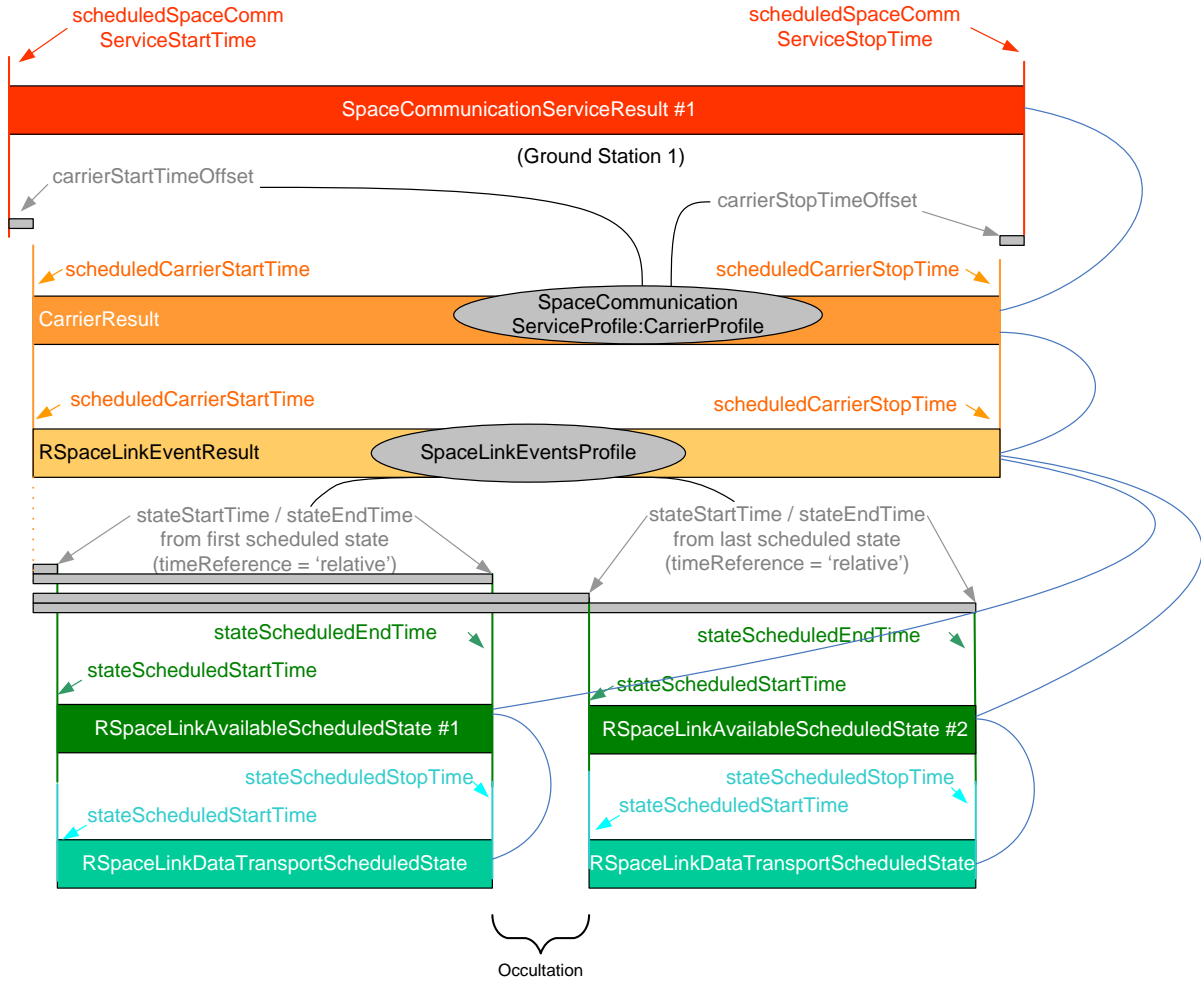

**Figure F-2: Example Timing Relationships in a `SpaceCommunicationServiceResult` Component of a Service Package Result**



**ANNEX G****INFORMATIVE REFERENCES****(INFORMATIVE)**

- [G1] *Cross Support Concept — Part 1: Space Link Extension Services*. Report Concerning Space Data System Standards, CCSDS 910.3-G-3. Green Book. Issue 3. Washington, D.C.: CCSDS, March 2006.
- [G2] *Space Communication Cross Support—Service Management—Operations Concept*. Draft Report Concerning Space Data System Standards, CCSDS 910.14-G-0. Draft Green Book. Issue 0. N.p: n.p., September 2008.
- [G3] R. Fielding, et al. *Hypertext Transfer Protocol -- HTTP/1.1*. RFC 2616. Reston, Virginia: ISOC, June 1999. <<http://www.ietf.org/rfc/rfc2616.txt>>
- [G4] Martin Gudgin, et al., eds. *SOAP Version 1.2 Part 1: Messaging Framework*. 2nd Edition. W3C Recommendation. N.p.: W3C, April 2007. <<http://www.w3.org/TR/2007/REC-soap12-part1-20070427/>>
- [G5] J. Postel. *Transmission Control Protocol*. STD 7. Reston, Virginia: ISOC, September 1981. <<http://ietfreport.isoc.org/rfc/std/std7.txt>>





# British Standards Institution (BSI)

BSI is the independent national body responsible for preparing British Standards and other standards-related publications, information and services. It presents the UK view on standards in Europe and at the international level.

BSI is incorporated by Royal Charter. British Standards and other standardisation products are published by BSI Standards Limited.

## Revisions

British Standards and PASs are periodically updated by amendment or revision. Users of British Standards and PASs should make sure that they possess the latest amendments or editions.

It is the constant aim of BSI to improve the quality of our products and services. We would be grateful if anyone finding an inaccuracy or ambiguity while using British Standards would inform the Secretary of the technical committee responsible, the identity of which can be found on the inside front cover. Similar for PASs, please notify BSI Customer Services.

**Tel: +44 (0)20 8996 9001 Fax: +44 (0)20 8996 7001**

BSI offers BSI Subscribing Members an individual updating service called PLUS which ensures that subscribers automatically receive the latest editions of British Standards and PASs.

**Tel: +44 (0)20 8996 7669 Fax: +44 (0)20 8996 7001**

**Email: [plus@bsigroup.com](mailto:plus@bsigroup.com)**

## Buying standards

You may buy PDF and hard copy versions of standards directly using a credit card from the BSI Shop on the website [www.bsigroup.com/shop](http://www.bsigroup.com/shop). In addition all orders for BSI, international and foreign standards publications can be addressed to BSI Customer Services.

**Tel: +44 (0)20 8996 9001 Fax: +44 (0)20 8996 7001**

**Email: [orders@bsigroup.com](mailto:orders@bsigroup.com)**

In response to orders for international standards, BSI will supply the British Standard implementation of the relevant international standard, unless otherwise requested.

## Information on standards

BSI provides a wide range of information on national, European and international standards through its Knowledge Centre.

**Tel: +44 (0)20 8996 7004 Fax: +44 (0)20 8996 7005**

**Email: [knowledgecentre@bsigroup.com](mailto:knowledgecentre@bsigroup.com)**

BSI Subscribing Members are kept up to date with standards developments and receive substantial discounts on the purchase price of standards. For details of these and other benefits contact Membership Administration.

**Tel: +44 (0)20 8996 7002 Fax: +44 (0)20 8996 7001**

**Email: [membership@bsigroup.com](mailto:membership@bsigroup.com)**

Information regarding online access to British Standards and PASs via British Standards Online can be found at [www.bsigroup.com/BSOL](http://www.bsigroup.com/BSOL)

Further information about British Standards is available on the BSI website at [www.bsi-group.com/standards](http://www.bsi-group.com/standards)

## Copyright

All the data, software and documentation set out in all British Standards and other BSI publications are the property of and copyrighted by BSI, or some person or entity that own copyright in the information used (such as the international standardisation bodies) has formally licensed such information to BSI for commercial publication and use. Except as permitted under the Copyright, Designs and Patents Act 1988 no extract may be reproduced, stored in a retrieval system or transmitted in any form or by any means – electronic, photocopying, recording or otherwise – without prior written permission from BSI. This does not preclude the free use, in the course of implementing the standard, of necessary details such as symbols, and size, type or grade designations. If these details are to be used for any other purpose than implementation then the prior written permission of BSI must be obtained. Details and advice can be obtained from the Copyright & Licensing Department.

**Tel: +44 (0)20 8996 7070**

**Email: [copyright@bsigroup.com](mailto:copyright@bsigroup.com)**

## BSI

389 Chiswick High Road London W4 4AL UK

Tel +44 (0)20 8996 9001

Fax +44 (0)20 8996 7001

[www.bsigroup.com/standards](http://www.bsigroup.com/standards)