

BS ISO 15765-2:2016



BSI Standards Publication

Road vehicles — Diagnostic communication over Controller Area Network (DoCAN)

Part 2: Transport protocol and network layer services

National foreword

This British Standard is the UK implementation of ISO 15765-2:2016. It supersedes BS ISO 15765-2:2011 which is withdrawn.

The UK participation in its preparation was entrusted to Technical Committee AUE/16, Data Communication (Road Vehicles).

A list of organizations represented on this committee can be obtained on request to its secretary.

This publication does not purport to include all the necessary provisions of a contract. Users are responsible for its correct application.

© The British Standards Institution 2016.
Published by BSI Standards Limited 2016

ISBN 978 0 580 87374 4

ICS 43.040.15

Compliance with a British Standard cannot confer immunity from legal obligations.

This British Standard was published under the authority of the Standards Policy and Strategy Committee on 30 April 2016.

Amendments/corrigenda issued since publication

Date	Text affected
------	---------------

**Road vehicles — Diagnostic
communication over Controller Area
Network (DoCAN) —**

Part 2:
**Transport protocol and network layer
services**

*Véhicules routiers — Communication de diagnostic sur gestionnaire
de réseau de communication (DoCAN) —*

Partie 2: Protocole de transport et services de la couche réseau





COPYRIGHT PROTECTED DOCUMENT

© ISO 2016, Published in Switzerland

All rights reserved. Unless otherwise specified, no part of this publication may be reproduced or utilized otherwise in any form or by any means, electronic or mechanical, including photocopying, or posting on the internet or an intranet, without prior written permission. Permission can be requested from either ISO at the address below or ISO's member body in the country of the requester.

ISO copyright office
Ch. de Blandonnet 8 • CP 401
CH-1214 Vernier, Geneva, Switzerland
Tel. +41 22 749 01 11
Fax +41 22 749 09 47
copyright@iso.org
www.iso.org

Contents

Page

Foreword	v
Introduction	vi
1 Scope	1
2 Normative references	1
3 Terms, definitions and abbreviated terms	2
3.1 Terms and definitions.....	2
3.2 Abbreviated terms.....	2
4 Conventions	3
5 Document overview	3
6 ISO 11898-1 CAN data link layer extension	4
6.1 CLASSICAL CAN and CAN FD frame feature comparison.....	4
6.2 Illustration of CAN parameters for transport protocol and network layer services.....	5
6.3 Additional requirements for CAN FD.....	6
7 Network layer overview	7
7.1 General.....	7
7.2 Services provided by network layer to higher layers.....	7
7.3 Internal operation of network layer.....	8
8 Network layer services	10
8.1 General.....	10
8.2 Specification of network layer service primitives.....	11
8.2.1 N_USData.request.....	11
8.2.2 N_USData.confirm.....	11
8.2.3 N_USData_FF.indication.....	11
8.2.4 N_USData.indication.....	12
8.2.5 N_ChangeParameters.request.....	12
8.2.6 N_ChangeParameter.confirm.....	13
8.3 Service data unit specification.....	13
8.3.1 Mtype, message type.....	13
8.3.2 N_AI, address information.....	13
8.3.3 <Length>.....	16
8.3.4 <MessageData>.....	16
8.3.5 <Parameter>.....	16
8.3.6 <Parameter_Value>.....	16
8.3.7 <N_Result>.....	16
8.3.8 <Result_ChangeParameter>.....	17
9 Transport layer protocol	18
9.1 Protocol functions.....	18
9.2 SingleFrame transmission.....	18
9.2.1 SingleFrame transmission with TX_DL = 8.....	18
9.2.2 SingleFrame transmission with TX_D > 8.....	19
9.3 Multiple-frame transmission.....	19
9.4 Transport layer protocol data units.....	21
9.4.1 Protocol data unit types.....	21
9.4.2 SF N_PDU.....	21
9.4.3 FF N_PDU.....	21
9.4.4 CF N_PDU.....	21
9.4.5 FC N_PDU.....	21
9.4.6 Protocol data unit field description.....	22
9.5 Transmit data link layer data length (TX_DL) configuration.....	22
9.5.1 Definition of TX_DL configuration values.....	22
9.5.2 Creating CAN frames based on N_TAtype and TX_DL.....	23

9.5.3	Verifying the correctness of received CAN frames.....	23
9.5.4	Receiver determination RX_DL.....	25
9.6	Protocol control information specification.....	25
9.6.1	N_PCI.....	25
9.6.2	SingleFrame N_PCI parameter definition.....	26
9.6.3	FirstFrame N_PCI parameter definition.....	28
9.6.4	ConsecutiveFrame N_PCI parameter definition.....	29
9.6.5	FlowControl N_PCI parameter definition.....	30
9.7	Maximum number of FC.WAIT frame transmissions (N_WFTmax).....	33
9.8	Network layer timing.....	33
9.8.1	Timing parameters.....	33
9.8.2	Network layer timeouts.....	37
9.8.3	Unexpected arrival of N_PDU.....	37
9.8.4	Wait frame error handling.....	39
9.9	Interleaving of messages.....	39
10	Data link layer usage.....	39
10.1	Data link layer service parameters.....	39
10.2	Data link layer interface services.....	39
10.2.1	L_Data.request.....	39
10.2.2	L_Data.confirm.....	39
10.2.3	L_Data.indication.....	40
10.3	Mapping of the N_PDU fields.....	40
10.3.1	Addressing formats.....	40
10.3.2	Normal addressing.....	40
10.3.3	Normal fixed addressing.....	41
10.3.4	Extended addressing.....	41
10.3.5	Mixed addressing.....	42
10.4	CAN frame data length code (DLC).....	43
10.4.1	DLC parameter.....	43
10.4.2	CAN frame data.....	43
10.4.3	Data length code (DLC) error handling.....	45
Annex A	(normative) Use of normal fixed and mixed addressing with data link layer according to SAE J1939.....	46
Annex B	(normative) Reserved CAN IDs.....	49
Bibliography	50

Foreword

ISO (the International Organization for Standardization) is a worldwide federation of national standards bodies (ISO member bodies). The work of preparing International Standards is normally carried out through ISO technical committees. Each member body interested in a subject for which a technical committee has been established has the right to be represented on that committee. International organizations, governmental and non-governmental, in liaison with ISO, also take part in the work. ISO collaborates closely with the International Electrotechnical Commission (IEC) on all matters of electrotechnical standardization.

The procedures used to develop this document and those intended for its further maintenance are described in the ISO/IEC Directives, Part 1. In particular the different approval criteria needed for the different types of ISO documents should be noted. This document was drafted in accordance with the editorial rules of the ISO/IEC Directives, Part 2 (see www.iso.org/directives).

Attention is drawn to the possibility that some of the elements of this document may be the subject of patent rights. ISO shall not be held responsible for identifying any or all such patent rights. Details of any patent rights identified during the development of the document will be in the Introduction and/or on the ISO list of patent declarations received (see www.iso.org/patents).

Any trade name used in this document is information given for the convenience of users and does not constitute an endorsement.

For an explanation on the meaning of ISO specific terms and expressions related to conformity assessment, as well as information about ISO's adherence to the WTO principles in the Technical Barriers to Trade (TBT) see the following URL: [Foreword - Supplementary information](#)

The committee responsible for this document is ISO/TC 22, *Road vehicles*, Subcommittee SC 31, *Data communication*.

This third edition cancels and replaces the second edition (ISO 15765-2:2011), which has been technically revised.

ISO 15765 consists of the following parts, under the general title *Road vehicles — Diagnostic communication over Controller Area Network (DoCAN)*¹⁾:

- *Part 1: General information and use case definition*
- *Part 2: Transport protocol and network layer services*
- *Part 4: Requirements for emissions-related systems*

1) ISO 15765-3 Implementation of unified diagnostic services (UDS on CAN) has been withdrawn and replaced by ISO 14229-3 Road vehicles — Unified diagnostic services (UDS) — Part 3: Unified diagnostic services on CAN implementation (UDSonCAN)

Introduction

This part of ISO 15765 has been established in order to define common requirements for vehicle diagnostic systems implemented on a controller area network (CAN) communication link, as specified in ISO 11898-1. Although primarily intended for diagnostic systems, it also meets requirements from other CAN-based systems needing a network layer protocol.

To achieve this, it is based on the Open Systems Interconnection (OSI) Basic Reference Model in accordance with ISO/IEC 7498-1 and ISO/IEC 10731, which structures communication systems into seven layers as shown in [Table 1](#).

Table 1 — Enhanced and legislated on-board diagnostics specifications applicable to the OSI layers

OSI 7 layers ^a	Vehicle-manufacturer-enhanced diagnostics	Legislated OBD (on-board diagnostics)	Legislated WWH-OBDD (on-board diagnostics)
Application (layer 7)	ISO 14229-1, ISO 14229-3	ISO 15031-5	ISO 27145-3, ISO 14229-1
Presentation (layer 6)	Vehicle manufacturer specific	ISO 15031-2, ISO 15031-5, ISO 15031-6, SAE J1930-DA, SAE J1979-DA, SAE J2012-DA	ISO 27145-2, SAE 1930-DA, SAE J1979-DA, SAE J2012-DA, SAE J1939-DA (SPNs), SAE J1939-73 Appendix A (FMIs)
Session (layer 5)	ISO 14229-2		
Transport protocol (layer 4)	ISO 15765-2	ISO 15765-2	ISO 15765-4, ISO 15765-2
Network (layer 3)			
Data link (layer 2)	ISO 11898-1	ISO 11898-1	ISO 15765-4, ISO 11898-1
Physical (layer 1)	ISO 11898-1, ISO 11898-2, ISO 11898-3, or vehicle manufacturer specific	ISO 11898-1, ISO 11898-2	ISO 15765-4, ISO 11898-1, ISO 11898-2
			ISO 27145-4

^a 7 layers according to ISO/IEC 7498-1 and ISO/IEC 10731

The application layer services covered by ISO 14229-3 have been defined in compliance with diagnostic services established in ISO 14229-1 and ISO 15031-5 but are not limited to use only with them. ISO 14229-3 is also compatible with most diagnostic services defined in national standards or vehicle manufacturer's specifications.

For other application areas, ISO 15765 can be used with any CAN physical layer.

Road vehicles — Diagnostic communication over Controller Area Network (DoCAN) —

Part 2: Transport protocol and network layer services

1 Scope

This part of ISO 15765 specifies a transport protocol and network layer services tailored to meet the requirements of CAN-based vehicle network systems on controller area networks as specified in ISO 11898-1. It has been defined in accordance with the diagnostic services established in ISO 14229-1 and ISO 15031-5 but is not limited to use with them and is also compatible with most other communication needs for in-vehicle networks.

ISO 11898-1 specifies variable length CAN frames with a maximum payload size dependent on the protocol device used. A CLASSICAL CAN protocol device can transmit/receive frames with payload sizes ranging from 0 bytes to 8 bytes per frame. A CAN FD (flexible data rate) protocol device can transmit/receive frames with payload sizes from 0 bytes to 64 bytes. A CAN FD protocol device is also capable of transmitting/receiving CLASSICAL CAN frames.

The diagnostic communication over controller area network (DoCAN) protocol supports the standardized service primitive interface as specified in ISO 14229-2 (UDS).

This part of ISO 15765 provides the transport protocol and network layer services to support different application-layer implementations such as

- enhanced vehicle diagnostics (emissions-related system diagnostics beyond legislated functionality, non-emissions-related system diagnostics),
- emissions-related on-board diagnostics (OBD) as specified in ISO 15031,
- world-wide harmonized on-board diagnostics (WWH-OBD) as specified in ISO 27145, and
- end of life activation on on-board pyrotechnic devices (ISO 26021).

The transport protocol specifies an unconfirmed communication.

NOTE This part of ISO 15765 does not determine whether CLASSICAL CAN, CAN FD or both are recommended or required to be implemented by other standards referencing this part of ISO 15765.

2 Normative references

The following documents, in whole or in part, are normatively referenced in this document and are indispensable for its application. For dated references, only the edition cited applies. For undated references, the latest edition of the referenced document (including any amendments) applies.

ISO/IEC 7498-1, *Information technology — Open Systems Interconnection — Basic Reference Model: The Basic Model — Part 1*

ISO 11898-1:2015²⁾, *Road vehicles — Controller area network (CAN) — Part 1: Data link layer and physical signalling*

2) The dated reference is to the first version of ISO 11898-1 that includes the definition of CAN FD. Versions after the dated reference are also valid. Future dated references are valid for CAN FD.

3 Terms, definitions and abbreviated terms

3.1 Terms and definitions

For the purposes of this document, the terms and definitions given in ISO/IEC 7498-1, ISO 11898-1 and the following apply.

3.1.1

CAN frame data length

CAN_DL

physical length of CAN frame data/payload in bytes

Note 1 to entry: See [Table 3](#).

3.1.2

transmit data link layer data length

TX_DL

configures the maximum usable payload length in bytes of the data link layer in the transmitter for the application that implements the network layer as defined in this part of ISO 15765

Note 1 to entry: The TX_DL is a fixed configuration value on the sender side for the PDU transmission.

3.1.3

Received data link layer data length

RX_DL

retrieved maximum usable payload length in bytes of the data link layer in the receiver for the application that implements the network layer as defined in this part of ISO 15765

Note 1 to entry: The RX_DL value is retrieved from the FirstFrame (FF) CAN_DL of a segmented PDU and is used to verify the correct data length of ConsecutiveFrames (CF).

3.2 Abbreviated terms

For the purposes of this part of ISO 15765, the following abbreviated terms apply.

BRS	bit rate switch
BS	BlockSize
CAN	controller area network
CAN_DL	CAN frame data link layer data length in bytes
CAN FD	controller area network with flexible data rate and larger payload as defined in ISO 11898-1
CLASSICAL CAN	controller area network with static data rate and up to 8 data bytes as defined in ISO 11898-1
CF	ConsecutiveFrame
CTS	continue to send
DLC	CAN frame data link layer data length code
DoCAN	diagnostic communication over CAN
ECU	electronic control unit
FC	FlowControl
FF	FirstFrame
FF_DL	FirstFrame data length in bytes
FMI	failure mode indicator
FS	FlowStatus
Mtype	message type
N/A	not applicable

N_AE	network address extension
N_AI	network address information
N_Ar	network layer timing parameter Ar
N_As	network layer timing parameter As
N_Br	network layer timing parameter Br
N_Bs	network layer timing parameter Bs
N_ChangeParameter	network layer service name
N_Cr	network layer timing parameter Cr
N_Cs	network layer timing parameter Cs
N_Data	network data
N_PCI	network protocol control information
N_PCIttype	network protocol control information type
N_PDU	network protocol data unit
N_SA	network source address
N_SDU	network service data unit
N_TA	network target address
N_TAtype	network target address type
N_USData	network layer unacknowledged segmented data transfer service name
NW	network
NWL	network layer
OBD	on-board diagnostics
OSI	Open Systems Interconnection
PCI	protocol control information
RX_DL	received data link layer data length in bytes
SF	SingleFrame
SF_DL	SingleFrame data length in bytes
SN	SequenceNumber
SPN	suspect parameter number
ST _{min}	SeparationTime minimum
TX_DL	transmit data link layer data length in bytes
UDS	unified diagnostic services
WWH-OBD	world-wide harmonized OBD

4 Conventions

This International Standard is based on the conventions discussed in the OSI service conventions (ISO/IEC 10731) as they apply for diagnostic services.

5 Document overview

[Figure 1](#) illustrates the most applicable application implementations utilizing the DoCAN protocol.

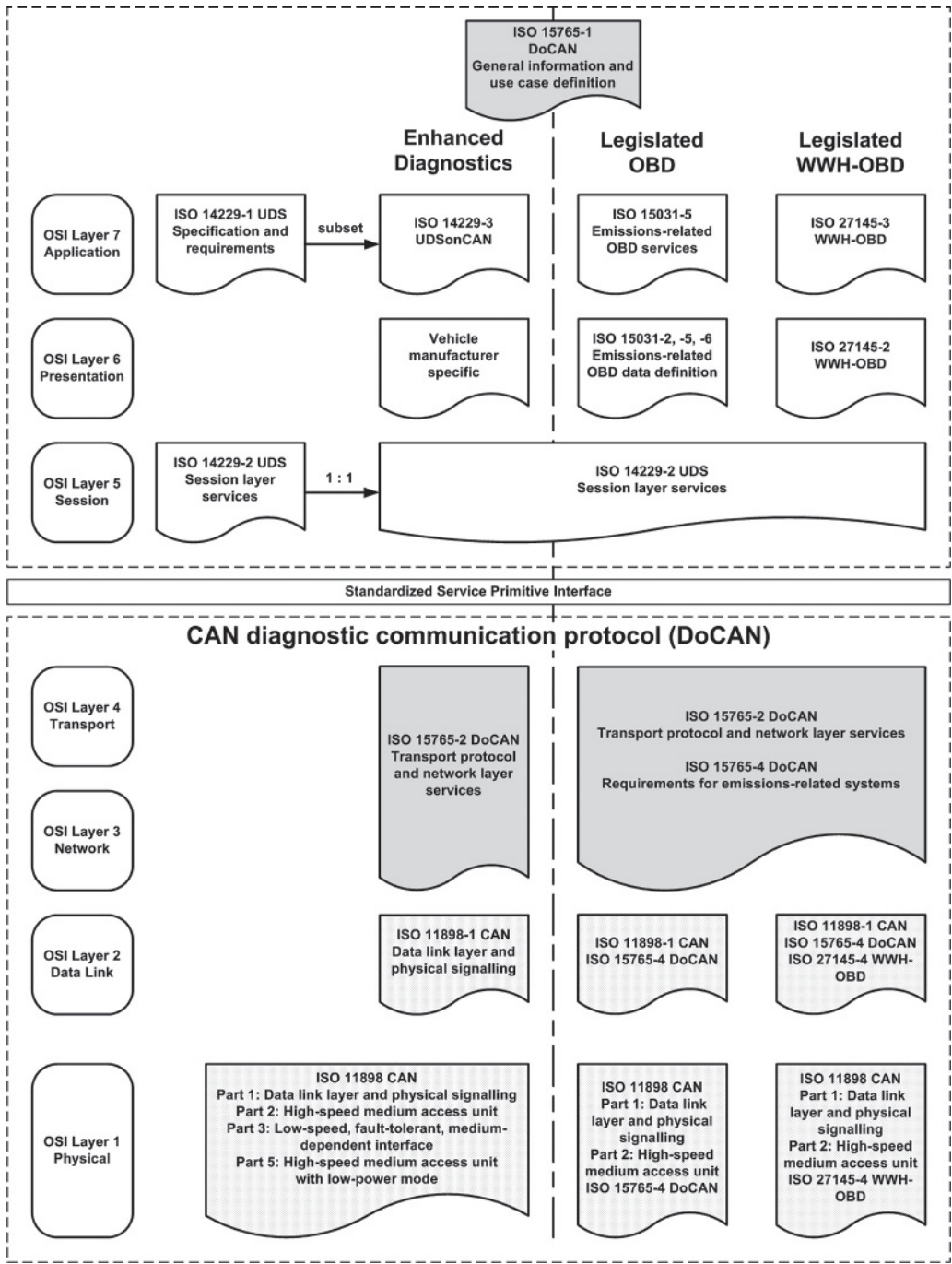

Figure 1 — DoCAN document reference according to the OSI model

6 ISO 11898-1 CAN data link layer extension

6.1 CLASSICAL CAN and CAN FD frame feature comparison

ISO 11898-1 CLASSICAL CAN frames support payload lengths up to a maximum of 8 bytes. ISO 11898-1 CAN FD frames support payload lengths up to a maximum of 64 bytes. Therefore, the segmented transfer of data using FirstFrame (FF), FlowControl (FC) and ConsecutiveFrame (CF) type frames needs to be implemented with a variable configurable payload length without changing the original protocol concept. The SF frame type has also been adapted to support the increased payload length allowed with CAN FD frames.

Table 2 outlines the different features of the CAN frame types provided by ISO 11898-1.

Table 2 — CAN frame feature comparison

RefNo	Feature	CLASSICAL CAN	CAN FD
#1	Payload length 0..8 bytes Data length code (DLC) 0..8	Yes	Yes
#2	Payload length 8 bytes Data length code (DLC) 9..15 ^a	Yes	No
#3	Payload length 12..64 bytes ^b Data length code (DLC) 9..15	No	Yes
#4	Different bit rates supported for the arbitration and data phases of a CAN frame.	No	Yes
#5	Remote transmission request (RTR)	Yes	No

^a For CLASSICAL CAN, the DLC values 9..15 are automatically reduced to the value of 8 which leads to the maximum possible CAN_DL for CLASSICAL CAN.

^b CAN FD does not support all payload lengths between 8 bytes and 64 bytes (e.g. a CAN FD frame with 10 meaningful data bytes requires a payload length of 12 bytes); see Table 3 and 10.4.2.3.

6.2 Illustration of CAN parameters for transport protocol and network layer services

Figure 2 shows the mapping of CAN parameters onto the network/transport layer addressing information N_AI. It illustrates the validity and applicability of network/transport layer parameters and the resulting support of CLASSICAL CAN vs. CAN FD data link layer. Figure 2 describes this for the example of using either normal or normal fixed addressing. For extended addressing and mixed addressing, the concept in general also applies but the mapping of the N_AI parameter onto the CAN frame differs.

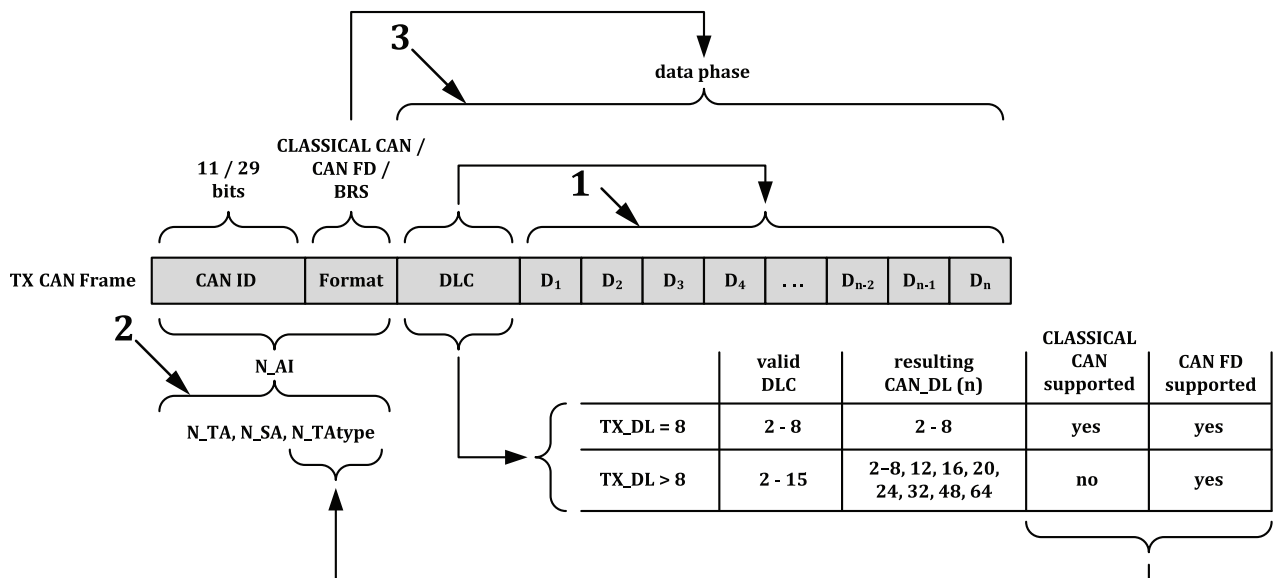

Key

- 1 DLC value results in a CAN_DL value (n), which is the physical length of a CAN frame data/payload; in the receiver, CAN_DL is used to determine the sender TX_DL value
- 2 the shown N_AI mapping is an example for normal and normal fixed addressing only
- 3 the bit rate switch (BRS) in the 'Format' information defines the transmission speed of the data phase

Figure 2 — Illustration of CAN parameters for network layer services

Table 3 — CLASSICAL CAN/CAN FD data length comparison table

Data length code (DLC)	CLASSICAL CAN data length (CAN_DL)	CAN FD data length (CAN_DL)
0	0	0
1	1	1
2	2	2
3	3	3
4	4	4
5	5	5
6	6	6
7	7	7
8	8	8
9	8 ^a	12
10	8 ^a	16
11	8 ^a	20
12	8 ^a	24
13	8 ^a	32
14	8 ^a	48
15	8 ^a	64

^a For CLASSICAL CAN, the DLC values 9..15 are automatically reduced to the value of 8 which leads to the maximum possible CAN_DL for CLASSICAL CAN.

6.3 Additional requirements for CAN FD

If a CAN FD protocol device is used, this part of ISO 15765 can be configured to create either CLASSICAL CAN or CAN FD type frames. When CAN FD type frames are enabled for the data link layer, two new options need to be supported as follows.

- a) The BRS bit which is part of a CAN FD frame and is used to determine if the data phase is to be transmitted at a different bit rate than the arbitration phase. The bitrate of the data phase is defined to be equal or higher than the arbitration bitrate. Bit rate switching does not influence the transport protocol itself (see [Figure 2](#)).
- b) The maximum allowed payload length (CAN_DL, 8 .. 64 bytes); see [Table 3](#).

Accommodating different maximum payload length values requires the addition of a new configuration variable “transmit data link layer data length” (TX_DL) for the transmitting node as specified in [9.5](#).

The configurable TX_DL value acts as a switch and upper bound for the valid CAN frame data lengths (CAN_DL) for the transmitting node.

- TX_DL equal to 8:

The transport protocol behaves identical to previous versions of this International Standard based on ISO 11898-1 (CLASSICAL CAN with 8 byte payload). See RefNo #1 in [Table 2](#). CAN Frames created by the protocol for transmission shall only use DLC values 2..8. This applies to both, CLASSICAL CAN and CAN FD type frames;

- TX_DL greater than 8:

Only ISO 11898-1 CAN FD type frames shall be used. DLC values 2..15 are allowed. See RefNo #1 and RefNo #3 in [Table 2](#).

7 Network layer overview

7.1 General

This part of ISO 15765 specifies an unconfirmed network layer communication protocol for the exchange of data between network nodes, e.g. from ECU to ECU, or between external test equipment and an ECU. If the data to be transferred does not fit into a single CAN frame, a segmentation method is provided.

In order to describe the functioning of the network layer, it is necessary to consider services provided to higher layers and the internal operation of the network layer.

7.2 Services provided by network layer to higher layers

The service interface defines a set of services that are needed to access the functions offered by the network layer, i.e. transmission/reception of data and setting of protocol parameters.

Two types of service are defined.

a) Communication services:

These services, of which the following are defined, enable the transfer of up to 4 294 967 295 bytes of data.

- 1) N_USData.request: This service is used to request the transfer of data. If necessary, the network layer segments the data.
- 2) N_USData_FF.indication: This service is used to signal the beginning of a segmented message reception to the upper layer.
- 3) N_USData.indication: This service is used to provide received data to the higher layers.
- 4) N_USData.confirm: This service confirms to the higher layers that the requested service has been carried out (successfully or not).

b) Protocol parameter setting services:

These services, of which the following are defined, enable the dynamic setting of protocol parameters.

- 1) N_ChangeParameter.request: This service is used to request the dynamic setting of specific internal parameters.
- 2) N_ChangeParameter.confirm: This service confirms to the upper layer that the request to change a specific protocol has completed (successfully or not).

7.3 Internal operation of network layer

The internal operation of the network layer provides methods for segmentation, transmission with FlowControl, and reassembly. The main purpose of the network layer is to transfer messages that might or might not fit in a single CAN frame. Messages that do not fit into a single CAN frame are segmented into multiple parts, where each can be transmitted in a CAN frame.

[Figure 3](#) shows an example of an unsegmented message transmission.

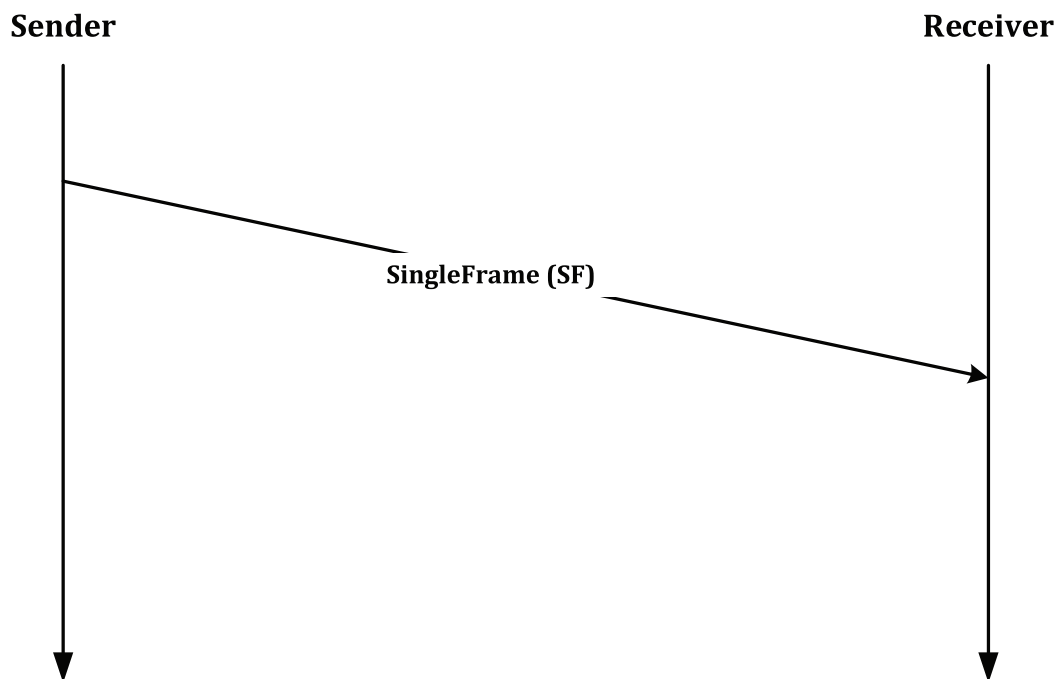

Figure 3 — Example of an unsegmented message

[Figure 4](#) shows an example of a segmented message transmission.

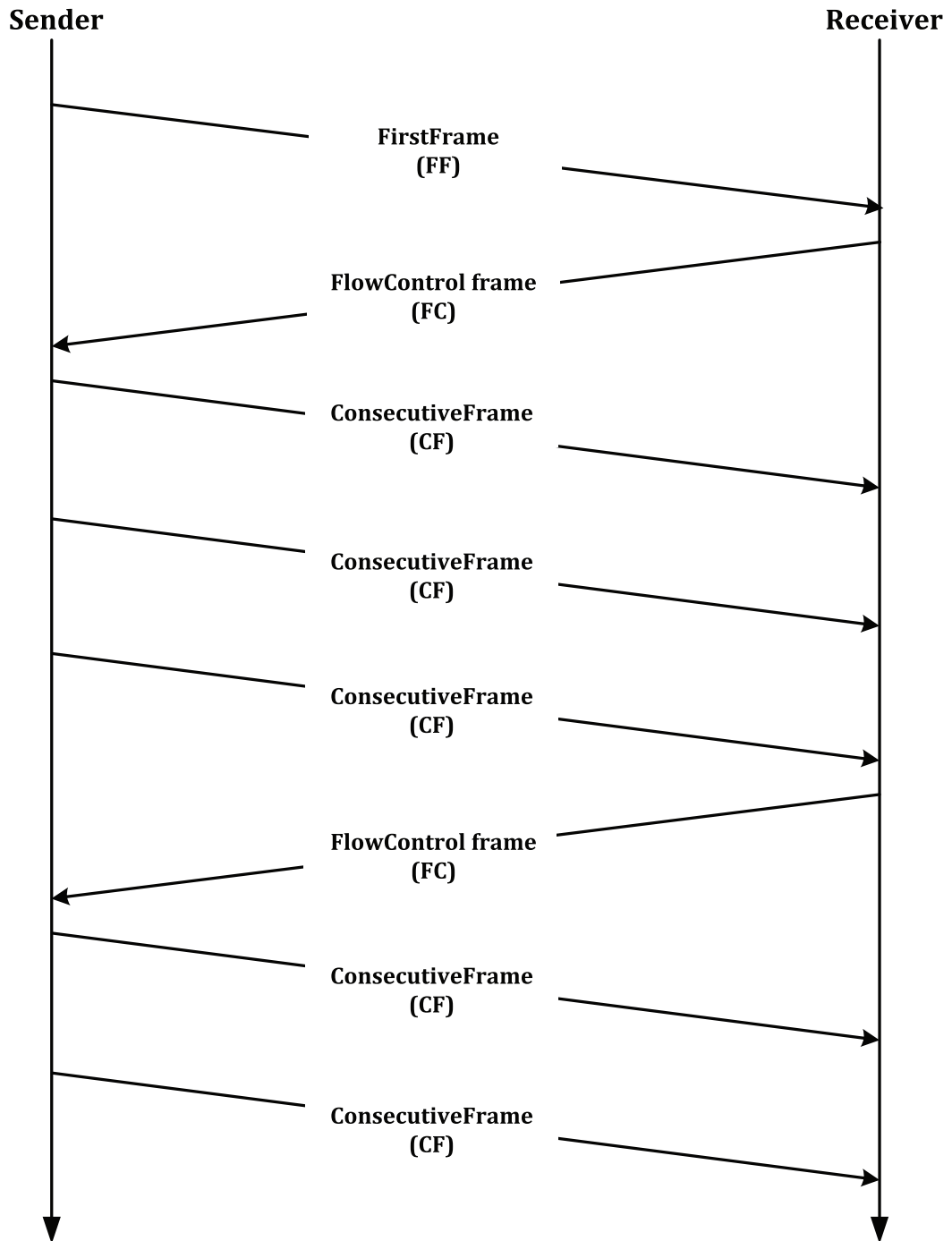

Figure 4 — Example of a segmented message

FlowControl is used to adjust the sender to the network layer capabilities of the receiver. This FlowControl scheme allows the use of diagnostic gateways and sub-networks.

8 Network layer services

8.1 General

All network layer services have the same general structure. To define the services, three types of service primitive are specified as follows:

- a service request primitive, used by higher communication layers or the application to pass control information and data required to be transmitted to the network layer;
- a service indication primitive, used by the network layer to pass status information and received data to upper communication layers or the application;
- a service confirmation primitive, used by the network layer to pass status information to higher communication layers or the application.

This service specification does not specify an application programming interface but only a set of service primitives that are independent of any implementation.

All network layer services have the same general format. Service primitives are written in the form:

```
service_name.type    (  
    parameter A,  
    parameter B  
    [,parameter C, ...]  
    )
```

where “service_name” is the name of the service, e.g. N_USData, “type” indicates the type of service primitive, and “parameter A, parameter B [,parameter C, ...]” are the N_SDU as a list of values passed by the service primitive. The square brackets indicate that this part of the parameter list may be empty.

The service primitives define how a service user (e.g. diagnostic application) cooperates with a service provider (e.g. network layer). The following service primitives are specified in this part of ISO 15765: request, indication and confirm.

- Using the service primitive request (service_name.request), a service user requests a service from the service provider.
- Using the service primitive indication (service_name.indication), the service provider informs a service user about an internal event of the network layer or the service request of a peer protocol layer entity service user.
- With the service primitive confirm (service_name.confirm), the service provider informs the service user about the result of a preceding service request of the service user.

8.2 Specification of network layer service primitives

8.2.1 N_USData.request

The service primitive requests transmission of <MessageData> with <Length> bytes from the sender to the receiver peer entities identified by the address information in N_SA, N_TA, N_TAtype [and N_AE] (see 8.3 for parameter definition).

```
N_USData.request    (
                    Mtype
                    N_SA
                    N_TA
                    N_TAtype
                    [N_AE]
                    <MessageData>
                    <Length>
                    )
```

Each time the N_USData.request service is called, the network layer shall signal the completion (or failure) of the message transmission to the service user by issuing an N_USData.confirm service call.

8.2.2 N_USData.confirm

The N_USData.confirm service is issued by the network layer. The service primitive confirms the completion of an N_USData.request service identified by the address information in N_SA, N_TA, N_TAtype [and N_AE]. The parameter <N_Result> provides the status of the service request (see 8.3 for parameter definition).

```
N_USData.confirm    (
                    Mtype
                    N_SA
                    N_TA
                    N_TAtype
                    [N_AE]
                    <N_Result>
                    )
```

8.2.3 N_USData_FF.indication

The N_USData_FF.indication service is issued by the network layer. The service primitive indicates to the adjacent upper layer the arrival of a FirstFrame (FF) of a segmented message received from a peer protocol entity, identified by the address information in N_SA, N_TA, N_TAtype [and N_AE] (see 8.3 for parameter definition). This indication shall take place upon receipt of the FF of a segmented message.

```
N_USData_FF.indication    (
                          Mtype
                          N_SA
                          N_TA
                          N_TAtype
                          [N_AE]
                          <Length>)

```

The N_USData_FF.indication service shall always be followed by an N_USData.indication service call from the network layer, indicating the completion (or failure) of message reception.

An N_USData_FF.indication service call shall only be issued by the network layer if a correct FF message segment has been received.

If the network layer detects any type of error in an FF, then the message shall be ignored by the network layer and no N_USData_FF.indication shall be issued to the adjacent upper layer.

If the network layer receives an FF with a data length value (FF_DL) that is greater than the available receiver buffer size, then this shall be considered as an error condition and no N_USData_FF.indication shall be issued to the adjacent upper layer.

8.2.4 N_USData.indication

The N_USData.indication service is issued by the network layer. The service primitive indicates <N_Result> events and delivers <MessageData> with <Length> bytes received from a peer protocol entity identified by the address information in N_SA, N_TA, N_TAtype [and N_AE] to the adjacent upper layer (see 8.3 for parameter definition).

The parameters <MessageData> and <Length> are valid only if <N_Result> equals N_OK.

```
N_USData.indication    (
    Mtype
    N_SA
    N_TA
    N_TAtype
    [N_AE]
    <MessageData>
    <Length>
    <N_Result>
)
```

The N_USData.indication service call is issued after reception of a SingleFrame (SF) message or as an indication of the completion (or failure) of a segmented message reception.

If the network layer detects any type of error in an SF, then the message shall be ignored by the network layer and no N_USData.indication shall be issued to the adjacent upper layer.

8.2.5 N_ChangeParameters.request

The service primitive is used to request the change of an internal parameter's value on the local protocol entity. The <Parameter_Value> is assigned to the <Parameter> (see 8.3 for parameter definition).

A parameter change is always possible, except after reception of the FF (N_USData_FF.indication) and until the end of reception of the corresponding message (N_USData.indication).

```
N_ChangeParameter.request    (
    Mtype
    N_SA
    N_TA
    N_TAtype
    [N_AE]
    <Parameter>
    <Parameter_Value>
)
```

This is an optional service that can be replaced by implementation of fixed parameter values.

8.2.6 N_ChangeParameter.confirm

The service primitive confirms completion of an N_ChangeParameter.confirm service applying to a message identified by the address information in N_SA, N_TA, N_TAtype [and N_AE] (see 8.3 for parameter definition).

```
N_ChangeParameter.confirm    (
                               Mtype
                               N_SA
                               N_TA
                               N_TAtype
                               [N_AE]
                               <Parameter>
                               <Result_ChangeParameter>
                               )
```

8.3 Service data unit specification

8.3.1 Mtype, message type

Type: enumeration

Range: diagnostics, remote diagnostics

Description: The parameter Mtype shall be used to identify the type and range of address information parameters included in a service call. This part of ISO 15765 specifies a range of two values for this parameter. The intention is that users of this part of ISO 15765 can extend the range of values by specifying other types and combinations of address information parameters to be used with the network layer protocol specified in this part of ISO 15765. For each such new range of address information, a new value for the Mtype parameter shall be specified to identify the new address information.

- If Mtype = diagnostics, then the address information N_AI shall consist of the parameters N_SA, N_TA, and N_TAtype.
- If Mtype = remote diagnostics, then the address information N_AI shall consist of the parameters N_SA, N_TA, N_TAtype, and N_AE.

8.3.2 N_AI, address information

8.3.2.1 N_AI description

These parameters refer to addressing information. As a whole, the N_AI parameters are used to identify the source address (N_SA), the target address (N_TA) of message senders and recipients, as well as the communication model for the message (N_TAtype) and the optional address extension (N_AE).

8.3.2.2 N_SA, network source address

Type: 8 bits

Range: 00₁₆ to FF₁₆

Description: The N_SA parameter shall be used to encode the sending network layer protocol entity.

8.3.2.3 N_TA, network target address

Type: 8 bits

Range: 00₁₆ to FF₁₆

Description: The N_TA parameter shall be used to encode one or multiple (depending on the N_TAtype: physical or functional) receiving network layer protocol entities.

8.3.2.4 N_TAtype, Network target address type

Type: enumeration

Range: see [Table 4](#)

Description: The parameter N_TAtype is an extension to the N_TA parameter. It shall be used to encode the communication model used by the communicating peer entities of the network layer (see [Figure 2](#)). The following requirements shall be supported.

- The network layer protocol shall be capable of carrying out parallel transmission of different messages that are not mapped onto the same N_AI.
- Error handling for unexpected PDUs only pertains to messages with the same N_AI.
 - CLASSICAL CAN frames will not cause a CAN FD message to be terminated and vice-versa.
 - This explicitly prevents mixing CAN FD/CLASSICAL CAN frame types in a single message.

[Table 4](#) defines the allowed combinations of N_TAtype communication models.

Table 4 — Allowed combinations of N_TAtype communication models

N_TAtype	Physical/Functional addressing	<Format>
N_TAtype #1	Physical ^a	CAN base format (CLASSICAL CAN, 11-bit)
N_TAtype #2	Functional ^b	
N_TAtype #3	Physical ^a	CAN FD base format (CAN FD, 11-bit)
N_TAtype #4	Functional ^b	
N_TAtype #5	Physical ^a	CAN extended format (CLASSICAL CAN, 29-bit)
N_TAtype #6	Functional ^b	
N_TAtype #7	Physical ^a	CAN FD extended format (CAN FD, 29-bit)
N_TAtype #8	Functional ^b	
^a Physical addressing (1 to 1 communication) shall be supported for all types of network layer messages.		
^b Functional addressing (1 to <i>n</i> communication) shall only be supported for SingleFrame transmission.		

[Figure 5](#) and [Figure 6](#) show examples of allowed N_TAtype communication models and depict the involved specific parameters.

[Figure 5](#) shows an example of an enhanced diagnostic tool CLASSICAL CAN request for normal addressing (N_TAtype #2).

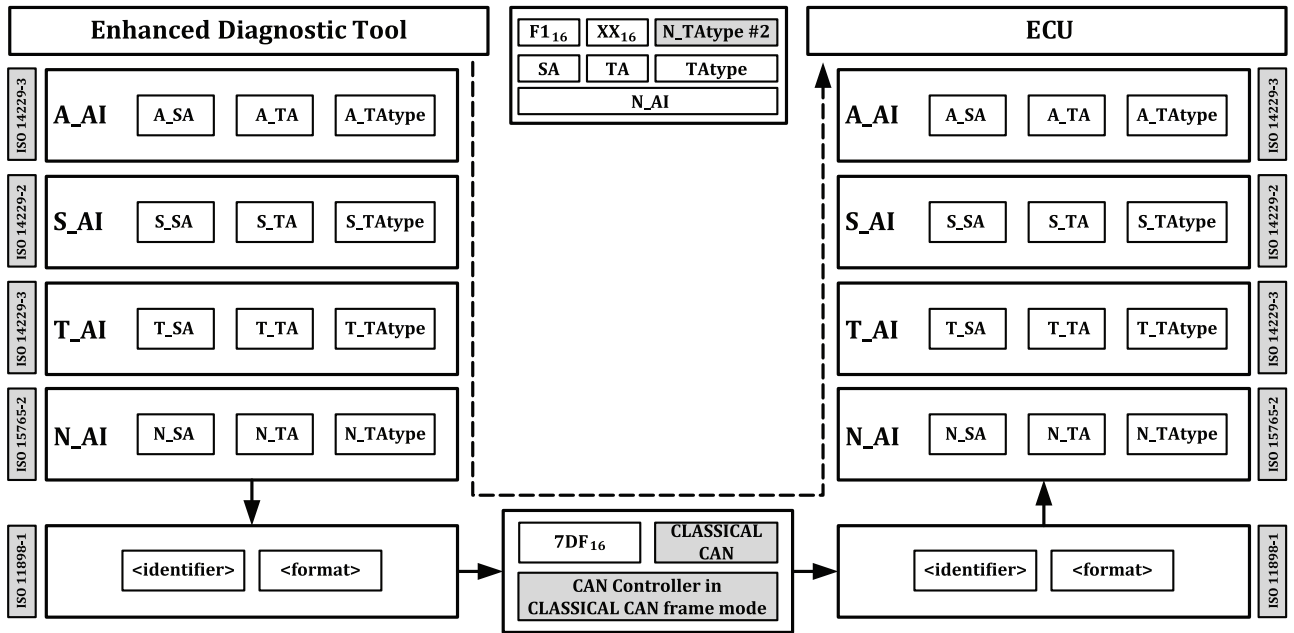

Figure 5 — Example of enhanced diagnostic tool CLASSICAL CAN request for normal addressing (N_TAtype #2)

Figure 6 shows an example of an enhanced diagnostic tool CAN FD request for normal addressing (N_TAtype #4).

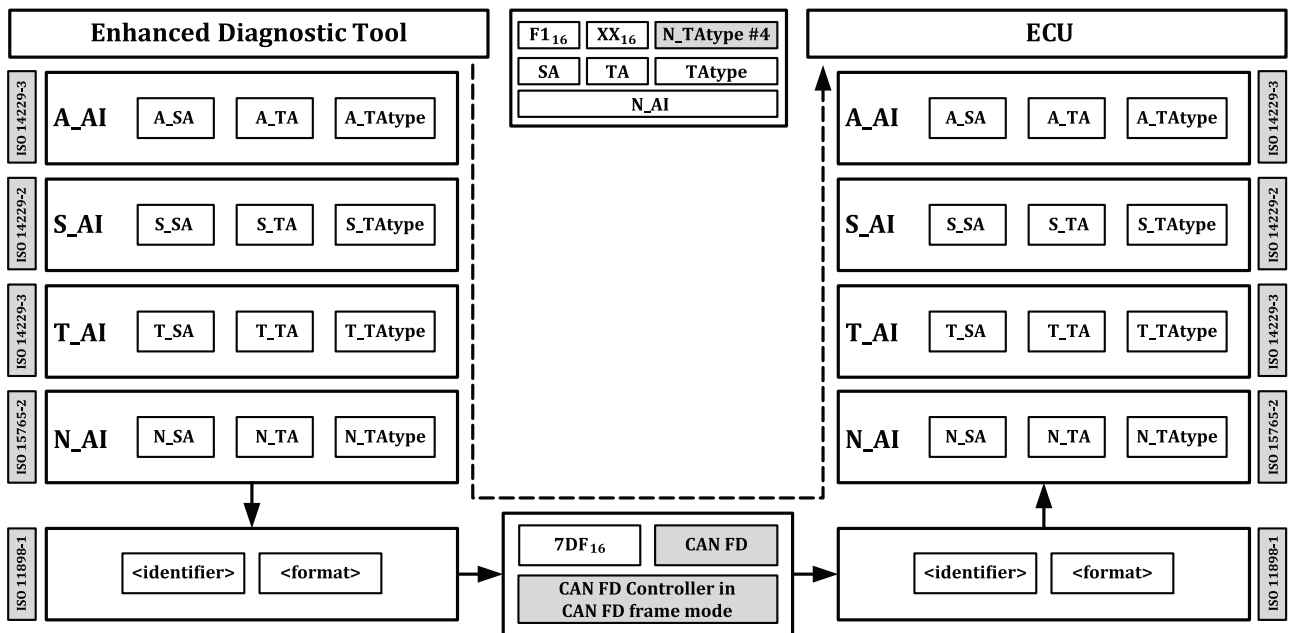

Figure 6 — Example of enhanced diagnostic tool CAN FD request for normal addressing (N_TAtype #4)

8.3.2.5 N_AE, network address extension

Type: 8 bits

Range: 00₁₆ to FF₁₆

Description: The N_AE parameter is used to extend the available address range for large networks and to encode both sending and receiving network layer entities of sub-networks other than the local network where the communication takes place. N_AE is only part of the addressing information if Mtype is set to remote diagnostics.

8.3.3 <Length>

Type: 32 bits

Range: 0000 0001₁₆ to FFFF FFFF₁₆

Description: This parameter includes the length of data to be transmitted/received.

8.3.4 <MessageData>

Type: string of bytes

Range: not applicable

Description: This parameter includes all data that the higher-layer entities exchange.

8.3.5 <Parameter>

Type: enumeration

Range: ST_{min}, BS

Description: This parameter identifies a parameter of the network layer.

8.3.6 <Parameter_Value>

Type: 8 bits

Range: 00₁₆ to FF₁₆

Description: This parameter is assigned to a protocol parameter <Parameter> as indicated in [9.6.5.3](#) and [9.6.5.4](#).

8.3.7 <N_Result>

Type: enumeration

Range: N_OK, N_TIMEOUT_A, N_TIMEOUT_Bs, N_TIMEOUT_Cr, N_WRONG_SN, N_INVALID_FS, N_UNEXP_PDU, N_WFT_OVRN, N_BUFFER_OVFLW, N_ERROR

Description: This parameter contains the status relating to the outcome of a service execution. If two or more errors are discovered at the same time, then the network layer entity shall use the parameter value found first in this list when indicating the error to the higher layers.

— N_OK

This value means that the service execution has been completed successfully; it can be issued to a service user on both the sender and receiver sides.

— N_TIMEOUT_A

This value is issued to the protocol user when the timer N_Ar/N_As has passed its time-out value N_Asmax/N_Armax; it can be issued to service users on both the sender and receiver sides.

— N_TIMEOUT_Bs

This value is issued to the service user when the timer N_Bs has passed its time-out value N_Bs_{max}; it can be issued to the service user on the sender side only.

— N_TIMEOUT_Cr

This value is issued to the service user when the timer N_Cr has passed its time-out value N_Cr_{max}; it can be issued to the service user on the receiver side only.

— N_WRONG_SN

This value is issued to the service user upon receipt of an unexpected SequenceNumber (PCI.SN) value; it can be issued to the service user on the receiver side only.

— N_INVALID_FS

This value is issued to the service user when an invalid or unknown FlowStatus value has been received in a FlowControl (FC) N_PDU; it can be issued to the service user on the sender side only.

— N_UNEXP_PDU

This value is issued to the service user upon receipt of an unexpected protocol data unit; it can be issued to the service user on the receiver side only.

— N_WFT_OVRN

This value is issued to the service user when the receiver has transmitted N_WFT_{max} FlowControl N_PDUs with FlowStatus = WAIT in a row and following this, it cannot meet the performance requirement for the transmission of a FlowControl N_PDU with FlowStatus = ClearToSend. It can be issued to the service user on the receiver side only.

— N_BUFFER_OVFLW

This value is issued to the service user upon receipt of a FlowControl (FC) N_PDU with FlowStatus = OVFLW. It indicates that the buffer on the receiver side of a segmented message transmission cannot store the number of bytes specified by the FirstFrame DataLength (FF_DL) parameter in the FirstFrame and therefore the transmission of the segmented message was aborted. It can be issued to the service user on the sender side only.

— N_ERROR

This is the general error value. It shall be issued to the service user when an error has been detected by the network layer and no other parameter value can be used to better describe the error. It can be issued to the service user on both the sender and receiver sides.

8.3.8 <Result_ChangeParameter>

Type: enumeration.

Range: N_OK, N_RX_ON, N_WRONG_PARAMETER, N_WRONG_VALUE

Description: This parameter contains the status relating to the outcome of a service execution.

— N_OK

This value means that the service execution has been completed successfully; it can be issued to a service user on both the sender and receiver sides.

— N_RX_ON

This value is issued to the service user to indicate that the service did not execute since reception of the message identified by <N_AI> was taking place; it can be issued to the service user on the receiver side only.

— N_WRONG_PARAMETER

This value is issued to the service user to indicate that the service did not execute due to an undefined <Parameter>; it can be issued to a service user on both the receiver and sender sides.

— N_WRONG_VALUE

This value is issued to the service user to indicate that the service did not execute due to an out-of-range <Parameter_Value>; it can be issued to a service user on both the receiver and sender sides.

9 Transport layer protocol

9.1 Protocol functions

The transport layer protocol shall perform the following functions:

- transmission/reception of messages up to 4 294 967 295 ($2^{32}-1$) data bytes;
- reporting of transmission/reception completion (or failure).

9.2 SingleFrame transmission

9.2.1 SingleFrame transmission with TX_DL = 8

Transmission of messages of up to six (TX_DL – 2, in the case of extended or mixed addressing) or seven (TX_DL – 1, in the case of normal addressing) data bytes is performed via transmission of a unique N_PDU (see 9.4.2), called SF (see Figure 7).

Reception of messages of up to six or seven data bytes is performed via reception of a unique N_PDU.

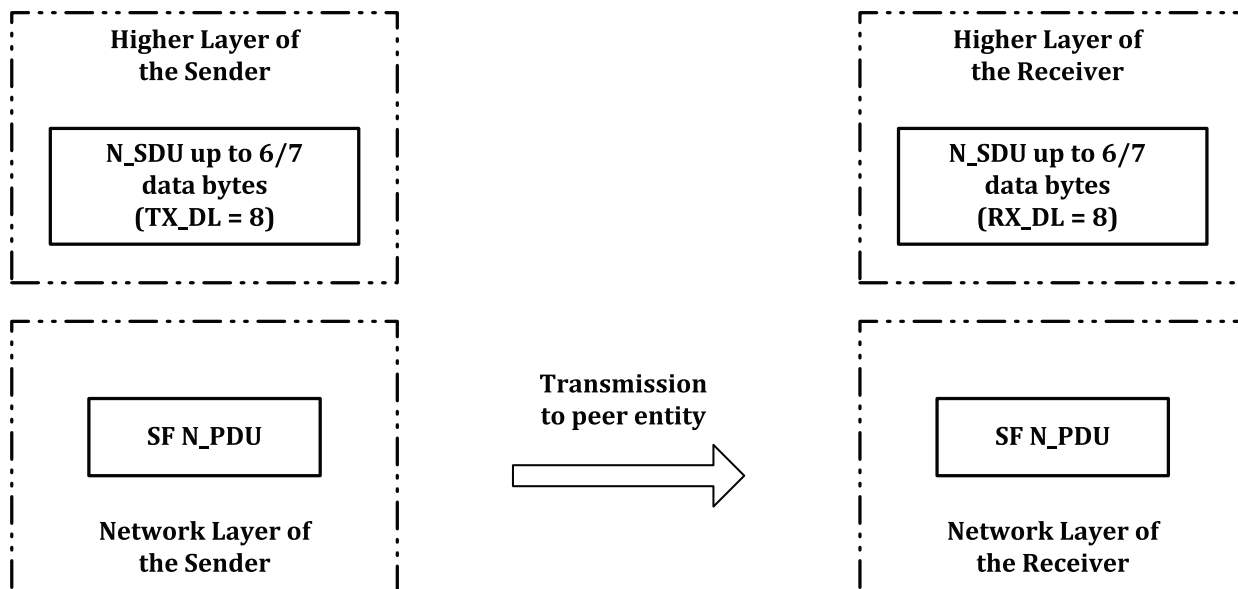

Figure 7 — Example of a SingleFrame (SF) transmission (TX_DL = 8)

9.2.2 SingleFrame transmission with TX_D > 8

Transmission of messages of up to TX_DL – 3 (in the case of extended or mixed addressing) or TX_DL – 2 (in the case of normal addressing) data bytes is performed via transmission of a unique N_PDU (see 9.4.2), called SF.

Reception of messages of up to TX_DL – 3 or TX_DL – 2 data bytes is performed via reception of a unique N_PDU.

9.3 Multiple-frame transmission

Transmission of longer messages is performed by segmenting the message and transmitting multiple N_PDUs. Reception of longer messages is performed by receiving multiple N_PDUs and reassembling of received data bytes (concatenation). The multiple N_PDUs are called FirstFrame (for the first N_PDU of the message) and ConsecutiveFrame (for all the following N_PDUs).

The receiver of a multiple N_PDU message has the possibility of adapting the transmission throughput to its capability by means of the FlowControl mechanism, using the FlowControl protocol data units (FC N_PDU).

Messages that are larger than the maximum SF_DL allowed by the used TX_DL are segmented into

- a FirstFrame protocol data unit (FF N_PDU), containing the first set of data bytes, and
- one or more ConsecutiveFrame protocol data units (CF N_PDU), each containing consecutive sets of data bytes. The last (or only) CF N_PDU contains the last set of data bytes.

The message length is transmitted in the FF N_PDU. All CF N_PDUs are numbered by the sender to help the receiver reassemble them in the same order.

The FlowControl mechanism (see Figure 8) allows the receiver to inform the sender about the receiver's capabilities, which the sender shall conform to.

These capabilities are defined as follows.

- a) BlockSize (BS): The maximum number of N_PDUs the receiver allows the sender to send before waiting for an authorization to continue transmission of the following N_PDUs. When BS is set to zero by the receiver, the sender is not waiting for an authorization to continue the transmission.
- b) SeparationTime minimum (ST_{min}): The minimum time the sender is to wait between transmission of two CF N_PDUs.

As the values for BS and ST_{min} are provided by every received FlowControl frame, two different modes for the adoption of these values are available for the receiver of a segmented message:

- dynamic: BS and ST_{min} are updated for the subsequent PDU communication for this message;
- static: constant BS and ST_{min} values are used for the communication for this message.

See 9.6.5.6 for possible implementation decisions and requirements for vehicle diagnosis.

All blocks, except the last one, will consist of BS N_PDUs. The last one will contain the remaining N_PDUs (from 1 up to BS).

Each time the sender/receiver waits for an N_PDU from the receiver/sender, a timeout mechanism allows detection of a transmission failure (see 9.8.2).

By means of FC N_PDUs, the receiver has the possibility of authorizing transmission of the following CF N_PDUs to delay transmission of that authorization or to deny reception of a segmented message in

the case that the number of bytes to be transferred exceeds the number of bytes that can be stored in the receiver buffer:

- a) FC.CTS: continue to send, the authorization to continue;
- b) FC.WAIT: the request to continue to wait;
- c) FC.OVFLW: buffer overflow, the indication that the number of bytes specified in the FirstFrame of the segmented message exceeds the number of bytes that can be stored in the buffer of the receiver entity.

There is an upper limit to the number of FC.WAIT a receiver is allowed to send in a row, called $N_{WFT_{max}}$. This parameter is a system design constant and is not transmitted in the FC N_PDU.

Figure 8 shows the segmentation on the sender side and reassembly on the receiver side.

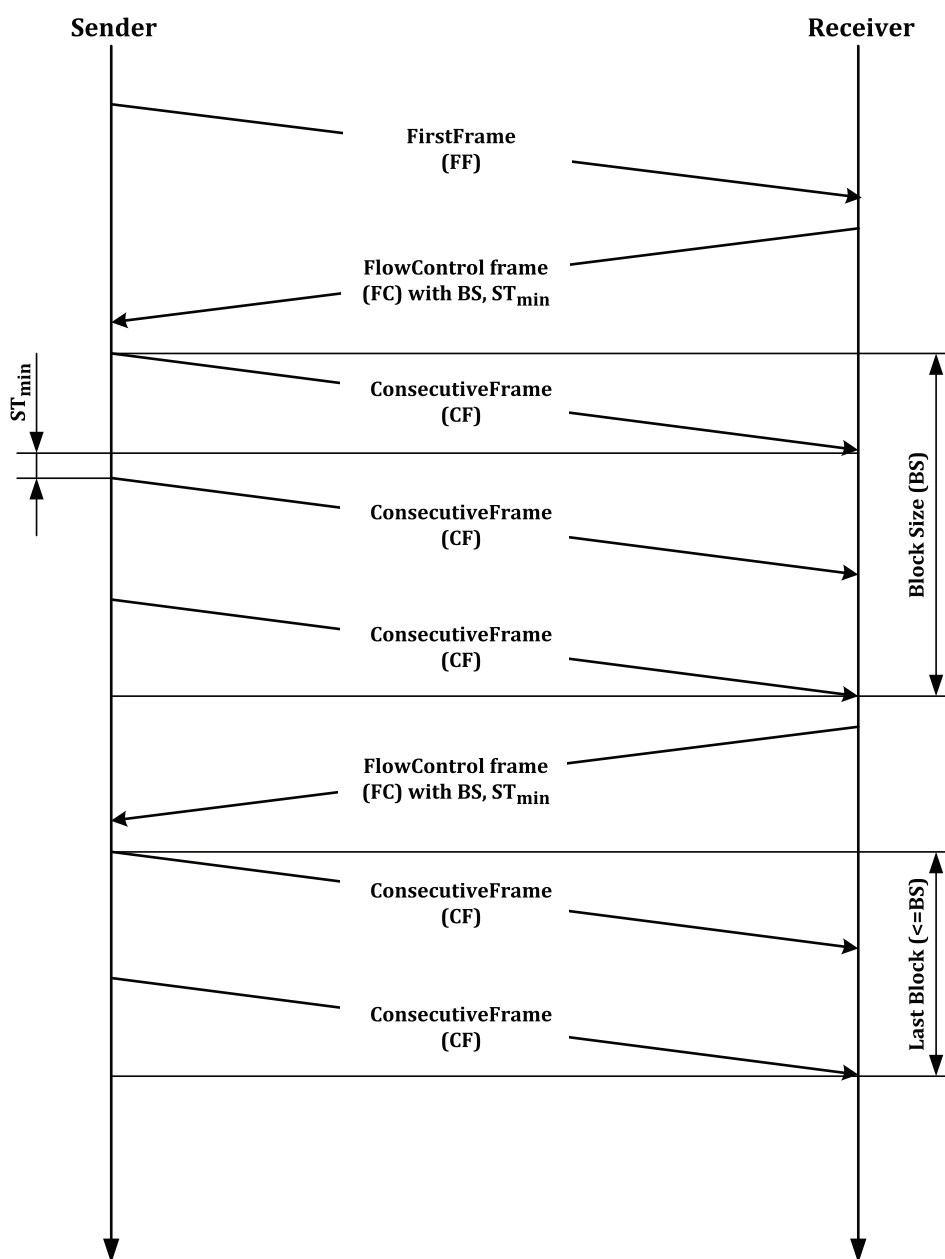

Figure 8 — FlowControl (FC) mechanism

9.4 Transport layer protocol data units

9.4.1 Protocol data unit types

The communication between the peer protocol entities of the network layer in different nodes is done by means of exchanging N_PDUs.

This part of ISO 15765 specifies four different types of transport layer protocol data units, SingleFrame (SF N_PDU), FirstFrame (FF N_PDU), ConsecutiveFrame (CF N_PDU) and FlowControl (FC N_PDU), which are used to establish a communication path between the peer network layer entities, to exchange communication parameters, to transmit user data and to release communication resources.

9.4.2 SF N_PDU

The SF N_PDU is identified by the SingleFrame protocol control information (SF N_PCI). The SF N_PDU shall be sent out by the sending network entity and can be received by one or multiple receiving network entities. It shall be sent out to transfer a service data unit that can be transferred via a single service request to the data link layer and to transfer unsegmented messages.

9.4.3 FF N_PDU

The FF N_PDU is identified by the FirstFrame protocol control information (FF N_PCI). The FF N_PDU shall be sent out by the sending network entity and received by a unique receiving network entity for the duration of the segmented message transmission. It identifies the first N_PDU of a segmented message transmitted by a network sending entity. The receiving network layer entity shall start assembling the segmented message on receipt of a FF N_PDU.

9.4.4 CF N_PDU

The CF N_PDU is identified by the ConsecutiveFrame protocol control information (CF N_PCI). The CF N_PDU transfers segments (N_Data) of the service data unit message data (<MessageData>). All N_PDUs transmitted by the sending entity after the FF N_PDU shall be encoded as CF N_PDUs. The receiving entity shall pass the assembled message to the service user of the network receiving entity after the last CF N_PDU has been received. The CF N_PDU shall be sent out by the sending network entity and received by a unique receiving network entity for the duration of the segmented message transmission.

9.4.5 FC N_PDU

The FC N_PDU is identified by the FlowControl protocol control information (FC N_PCI). The FC N_PDU instructs a sending network entity to start, stop or resume transmission of CF N_PDUs. It shall be sent by the receiving network layer entity to the sending network layer entity, when ready to receive more data, after correct reception of

- a) an FF N_PDU, or
- b) the last CF N_PDU of a block of ConsecutiveFrames, if further ConsecutiveFrames need to be sent.

The FC N_PDU can also inform a sending network entity to pause transmission of CF N_PDUs during a segmented message transmission or to abort the transmission of a segmented message if the length information (FF_DL) in the FF N_PDU transmitted by the sending entity exceeds the buffer size of the receiving entity.

9.4.6 Protocol data unit field description

9.4.6.1 N_PDU format

The protocol data unit (N_PDU) enables the transfer of data between the network layer in one node and the network layer in one or more other nodes (peer protocol entities). All N_PDUs consist of three (3) fields, as given in [Table 5](#).

Table 5 — N_PDU format

Address information	Protocol control information	Data field
N_AI	N_PCI	N_Data

9.4.6.2 Address information (N_AI)

The N_AI is used to identify the communicating peer entities of the network layer. The N_AI information received in the N_SDU (N_SA, N_TA, N_TAtype [and N_AE]) shall be copied and included in the N_PDU. If the message data (<MessageData> and <Length>) received in the N_SDU requires segmentation for the network layer to transmit the complete message, the N_AI shall be copied and included (repeated) in every N_PDU that is transmitted.

This field contains address information that identifies the type of message exchanged and the recipient(s) and sender between whom data exchange takes place.

NOTE For a detailed description of address information, see [8.3.2](#).

9.4.6.3 Protocol control information (N_PCI)

This field identifies the type of N_PDUs exchanged. It is also used to exchange other control parameters between the communicating network layer entities.

NOTE For a detailed specification of all N_PCI parameters, see [9.6](#).

9.4.6.4 Data field (N_Data)

The N_Data in the N_PDU is used to transmit the service user data received in the <MessageData> parameter in the N_USData.request service call. The <MessageData>, if needed, is segmented into smaller parts that each fit into the N_PDU data field before they are transmitted over the network.

The size of N_Data depends on the N_PDU type, the address format chosen, and the value of TX_DL.

9.5 Transmit data link layer data length (TX_DL) configuration

9.5.1 Definition of TX_DL configuration values

The transmit data link layer data length (TX_DL) configures the maximum usable payload length of the data link layer for the application that implements the network layer as defined in this part of ISO 15765. The TX_DL value is defined as the real payload length in bytes to provide simple calculations and sanity checks for the length definitions for N_PCI types specified in [9.6](#). The valid TX_DL values are derived from the payload length for data length code (DLC) values from 8 to 15 (see ISO 11898-1:2015, DLC table).

With TX_DL equal to 8, the protocol described in this part of ISO 15765 behaves identical to previous versions of this part of ISO 15765 which is based on ISO 11898-1 (CAN with 8 byte payload). [Table 6](#) describes valid transmit data link layer data length (TX_DL) values.

Table 6 — Definition of TX_DL configuration values

TX_DL	Description
<8	<p>Invalid This range of values is invalid.</p>
=8	<p>Configured CAN frame maximum payload length of 8 bytes For the use with ISO 11898-1 CLASSICAL CAN type frames and CAN FD type frames: — Valid DLC value range: 2..8; — Valid CAN_DL value range: 2..8.</p>
>8	<p>Configured CAN frame maximum payload length greater than 8 bytes For the use with ISO 11898-1 CAN FD type frames only: — Valid DLC value range: 2..15; — Valid CAN_DL value range: 2..8, 12, 16, 20, 24, 32, 48, 64; — Valid TX_DL value range: 12, 16, 20, 24, 32, 48, 64; — CAN_DL ≤ TX_DL.</p>

9.5.2 Creating CAN frames based on N_TAtype and TX_DL

CAN frames are generated based upon N_AI (see [8.3.2](#)), the configured addressing format (see [10.3.1](#)) for the given N_AI, the configured TX_DL value, and the size of the message to be transmitted.

9.5.3 Verifying the correctness of received CAN frames

Due to the fact that the TX_DL configuration of the sending node is not known by the receiver, the receiving node shall always adapt to the TX_DL settings of the sender.

The locally configured N_TAtype allows checking the received CAN frame type (CLASSICAL CAN/CAN FD) and is used to ignore wrong N_TAtype frames. Once the N_TAtype is correct, the different N_PCIttype values can be checked and assumptions on the RX_DL (the transmitters TX_DL) can be made.

See [Figure 9](#) for a complete state flow chart to process incoming CAN frames.

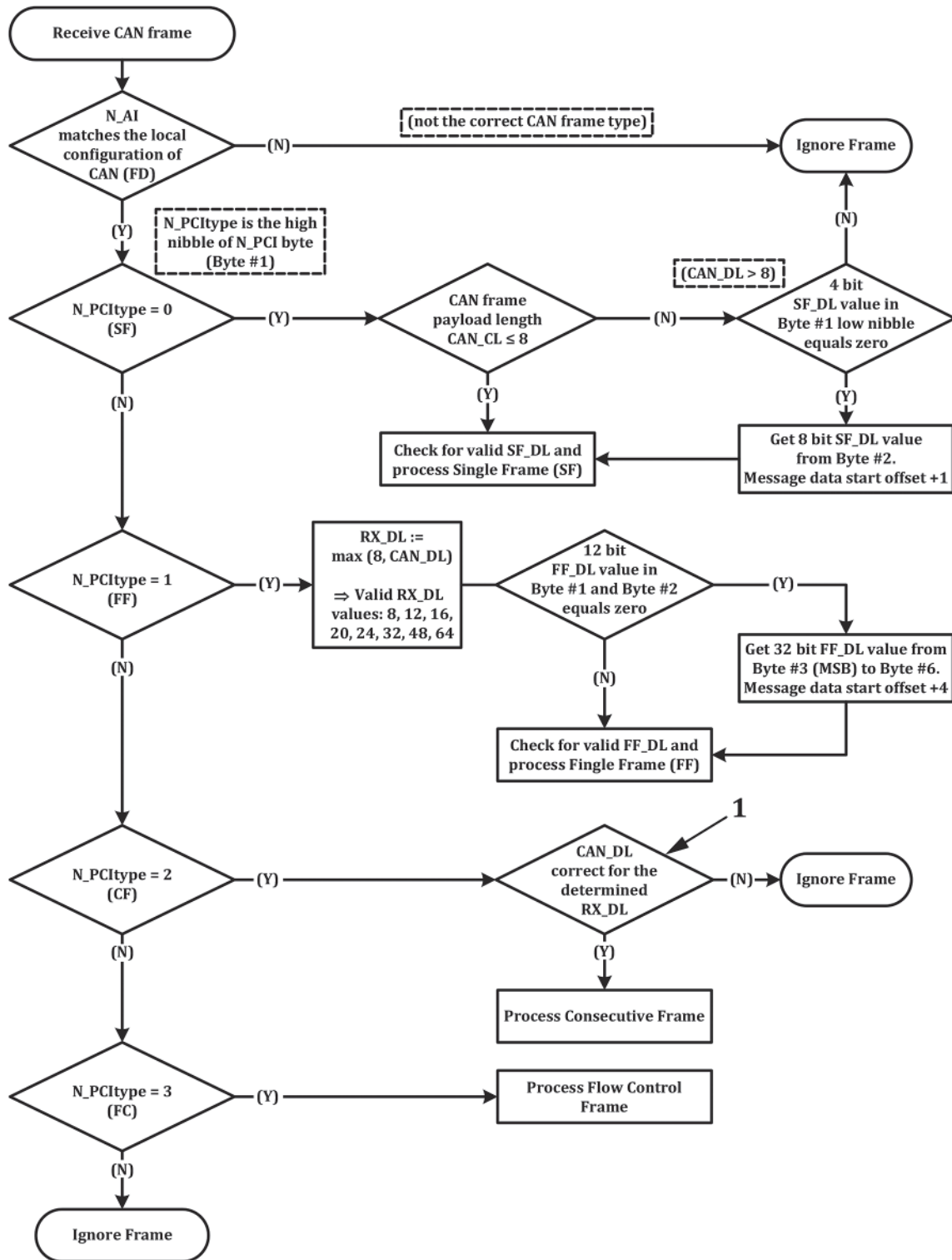

Key

- 1 CAN_DL shall be correct if the value matches RX_DL for all CF's except for the last (or only) CF; the last (or only) CF shall pass this check if CAN_DL is less or equal than RX_DL and the requirements in 9.6.4.2 are met; RX_DL comes from the FF and is fixed for this PDU reception process

Figure 9 — State flow — Verifying received CAN frames

9.5.4 Receiver determination RX_DL

To determine the RX_DL from a received FirstFrame N_PDU, the payload length in bytes (CAN_DL) is used.

- For CAN_DL values less than 8 bytes, the RX_DL value is invalid.³⁾
- For CAN_DL values equal to 8 bytes, the RX_DL value shall be 8.
- For CAN_DL values greater than 8 bytes, the RX_DL value equals the CAN_DL value.

[Table 7](#) defines the received CAN_DL to RX_DL mapping table.

Table 7 — Received CAN_DL to RX_DL mapping table

Received CAN_DL	RX_DL
0 to 7	invalid
8	8
12	12
16	16
20	20
24	24
32	32
48	48
64	64

9.6 Protocol control information specification

9.6.1 N_PCI

Each N_PDU is identified by means of an N_PCI. See [Table 8](#) and [Table 9](#).

[Table 8](#) defines the N_PCItypes bit values.

Table 8 — Definition of N_PCItypes bit values

N_PCI Byte #1 Bits 7 - 4	Description
0000 ₂ (0 ₁₆)	SingleFrame For unsegmented messages with CAN_DL ≤ 8, the message length is embedded in lower nibble of the only PCI byte (Byte #1). For unsegmented messages with CAN_DL > 8, the SingleFrame escape sequence shall be used where the lower nibble of the first PCI byte (Byte #1) is set to 0000 ₂ and the message length is embedded in the second PCI byte (Byte #2). SingleFrame (SF) shall be used to support the transmission of messages that can fit in a single CAN frame.
0001 ₂ (1 ₁₆)	FirstFrame A FirstFrame (FF) shall only be used to support the transmission of messages that cannot fit in a single CAN frame, i.e. segmented messages. On receipt of a FirstFrame (FF), the receiving network layer entity shall start assembling the segmented message. — For segmented messages with a message length ≤ 4 095, the lower nibble of the first PCI byte (Byte #1) and the second PCI byte (Byte #2) includes the message length. — For segmented messages with a message length > 4 095, the FirstFrame escape sequence shall be used where the lower nibble of the first PCI byte (Byte #1) is set to 0000 ₂ and the second PCI byte (Byte #2) is set to zero. The message length is embedded in the following four PCI bytes (Byte #3 .. Byte #6, MSB first).

³⁾ A valid FF always has a CAN_DL value greater than or equal to 8.

Table 8 (continued)

N_PCI Byte #1 Bits 7 – 4	Description
0010 ₂ (2 ₁₆)	ConsecutiveFrame When sending segmented data, all consecutive frames following the FF are encoded as ConsecutiveFrame (CF). On receipt of a ConsecutiveFrame (CF), the receiving network layer entity shall assemble the received data bytes until the whole message is received. The receiving entity shall pass the assembled message to the adjacent upper protocol layer after the last frame of the message has been received without error.
0011 ₂ (3 ₁₆)	FlowControl The purpose of FlowControl (FC) is to regulate the rate at which CF N_PDUs are sent to the receiver. Three distinct types of FlowControl (FC) protocol control information are specified to support this function. The type is indicated by a field of the protocol control information called FlowStatus (FS), as defined in 9.6.5.1.
4 ₁₆ – F ₁₆	Reserved This range of values is reserved by this part of ISO 15765.

Table 9 shows a summary of N_PCI bytes.

Table 9 — Summary of N_PCI bytes

N_PDU name	N_PCI bytes						
	Byte #1 Bits 7 – 4 Bits 3 – 0		Byte #2	Byte #3	Byte #4	Byte #5	Byte #6
SingleFrame (SF) (CAN_DL ≤ 8)	0000 ₂	SF_DL	—	—	—	—	—
SingleFrame (SF) (CAN_DL > 8) ^a	0000 ₂	0000 ₂	SF_DL	—	—	—	—
FirstFrame (FF) (FF_DL ≤ 4 095)	0001 ₂	FF_DL		—	—	—	—
FirstFrame (FF) (FF_DL > 4 095) ^b	0001 ₂	0000 ₂	0000 0000 ₂	FF_DL			
ConsecutiveFrame (CF)	0010 ₂	SN	—	—	—	—	—
FlowControl (FC)	0011 ₂	FS	BS	ST _{min}	N/A	N/A	N/A

^a Messages with CAN_DL > 8 shall use an escape sequence where the lower nibble of Byte #1 is set to 0 (invalid length). This signifies to the network layer that the value of SF_DL is determined based on the next byte in the frame (Byte #2). As CAN_DL is defined to be greater than 8, this definition is only valid for CAN FD type frames.

^b Messages larger than 4 095 bytes shall use an escape sequence where the lower nibble of Byte #1 and all bits in Byte #2 are set to 0 (invalid length). This signifies to the network layer that the value of FF_DL is determined based on the next 32 bits in the frame (Byte #3 is the MSB and Byte #6 the LSB).

NOTE Dash lines are not utilized for PCI information, but depending on the PDU, they might be utilized for payload data.

9.6.2 SingleFrame N_PCI parameter definition

9.6.2.1 SF N_PCI byte

The parameter SingleFrame data length (SF_DL) is used in the SF N_PDU to specify the number of service message data bytes. The ranges of valid SF_DL values depend on the configured transmit data link layer data length (TX_DL) and the actual payload to be transmitted (see Table 10 and Table 11). If the value of TX_DL > 8 and the payload size results in CAN_DL exceeding 8, then bits 0 .. 3 of the first PCI byte (Byte #1) are set to 0 and the SF_DL is embedded in the second PCI byte (Byte #2); see Table 9.

Table 10 — Definition of SF_DL values with CAN_DL ≤ 8

Value Bits 7 – 4	Description
0000 ₂	Reserved This value is reserved by this part of ISO 15765.
0001 ₂ .. 0110 ₂	SingleFrame DataLength (SF_DL) SF_DL shall be assigned the value of the service parameter <Length>.
0111 ₂	SingleFrame DataLength (SF_DL) with normal addressing only SF_DL shall be assigned the value of the service parameter <Length>. SF_DL = 7 is only allowed with normal addressing.
other values	Invalid This range of values is invalid.

NOTE 1 SF_DL is encoded in the low nibble of first N_PCI byte (Byte #1) value.

Table 11 — Definition of SF_DL values (CAN_DL > 8)

Value	Description
0000 0000 ₂ .. 0000 0110 ₂	Reserved This value is reserved by this part of ISO 15765.
0000 0111 ₂	SingleFrame DataLength (SF_DL) with extended addressing or mixed addressing SF_DL shall be assigned the value of the service parameter <Length>. SF_DL = 7 is only allowed with extended addressing or mixed addressing.
0000 1000 ₂ .. (CAN_DL – 3)	SingleFrame DataLength (SF_DL) SF_DL shall be assigned the value of the service parameter <Length>.
(CAN_DL – 2)	SingleFrame DataLength (SF_DL) with normal addressing only SF_DL shall be assigned the value of the service parameter <Length>. SF_DL = (CAN_DL – 2) is only allowed with normal addressing.
other values	Invalid This range of values is invalid.

NOTE 2 SF_DL is encoded in the second N_PCI byte (Byte #2) value. This is only allowed for CAN FD type frames.

9.6.2.2 SF_DL error handling

Received CAN_DL is less or equal to 8:

- If the network layer receives a SF where SF_DL is equal to 0, then the network layer shall ignore the received SF N_PDU;
- If the network layer receives an SF where SF_DL is greater than (CAN_DL – 1) of the received frame when using normal addressing or greater than (CAN_DL – 2) of the received frame for extended or mixed addressing, then the network layer shall ignore the received SF N_PDU;
- In the case of CAN frame data padding (see [10.4.2.1](#)): If the network layer receives an SF where the CAN_DL does not equal to 8, then the network layer shall ignore the received SF N_PDU;
- In the case of CAN frame data optimization (see [10.4.2.2](#)): If the network layer receives an SF where the value of SF_DL does not match the valid values shown in [Table 12](#), then the network layer shall ignore the received SF N_PDU.

Table 12 — Allowed SF_DL values for a given addressing scheme with optimized CAN_DL

Addressing type	CAN_DL value							
	0..1	2	3	4	5	6	7	8
Normal	Invalid	SF_DL = 1	SF_DL = 2	SF_DL = 3	SF_DL = 4	SF_DL = 5	SF_DL = 6	SF_DL = 7
Mixed or extended	Invalid	Invalid	SF_DL = 1	SF_DL = 2	SF_DL = 3	SF_DL = 4	SF_DL = 5	SF_DL = 6

Received CAN_DL is greater than 8:

- If the network layer receives an SF where the low nibble of the first PCI byte is not 0000₂, then the network layer shall ignore the received SF N_PDU;
- If the network layer receives an SF where the value of SF_DL does not fall into the valid range shown in [Table 13](#), then the network layer shall ignore the received SF N_PDU.

Table 13 — Allowed SF_DL values for a given CAN_DL greater than 8 and addressing scheme

Addressing type	CAN_DL value							
	12	16	20	24	32	48	64	
Normal	8 ≤ SF_DL ≤ 10	11 ≤ SF_DL ≤ 14	15 ≤ SF_DL ≤ 18	19 ≤ SF_DL ≤ 22	23 ≤ SF_DL ≤ 30	31 ≤ SF_DL ≤ 46	47 ≤ SF_DL ≤ 62	
Mixed or extended	7 ≤ SF_DL ≤ 9	10 ≤ SF_DL ≤ 13	14 ≤ SF_DL ≤ 17	18 ≤ SF_DL ≤ 21	22 ≤ SF_DL ≤ 29	30 ≤ SF_DL ≤ 45	46 ≤ SF_DL ≤ 61	

9.6.3 FirstFrame N_PCI parameter definition

9.6.3.1 FirstFrame DataLength (FF_DL) parameter definition

The parameter FF_DL is used in the FF N_PDU to specify the number of service message data bytes. For the sender, the range of valid FF_DL values depends on the addressing scheme and the configured transmit data link layer data length (TX_DL). The minimum values of FF_DL (FF_DL_{min}) based on addressing scheme and TX_DL are specified in [Table 14](#).

Table 14 — Minimum value of FF_DL based on the addressing scheme

Condition	FF_DL _{min} value
If the configured TX_DL is 8 and normal addressing is used.	8
If the configured TX_DL is 8 and mixed or extended addressing is used.	7
If the configured TX_DL > 8 and normal addressing is used.	TX_DL - 1
If the configured TX_DL > 8 and mixed or extended addressing is used.	TX_DL - 2

The receiver of an FF N_PDU does not have knowledge of the TX_DL of the sender. The receiver determines the minimum value of FF_DL (FF_DL_{min}) from [Table 14](#) based on the configured addressing scheme and the retrieved value of RX_DL from the CAN_DL of the FF N_PDU (see [9.5.4](#) for definition of how the receiver determines RX_DL).

Only messages larger than 4 095 bytes in length shall use the escape sequence where the lower nibble of the first PCI byte (Byte #1) and the entire second PCI byte (Byte #2) have all bits set to 0. This tells the network layer that the FF_DL is to be determined based on a 32 bit value contained in Byte #3 (MSB) through Byte #6 (LSB) of the first frame.

Table 15 — Valid FF_DL values

Value	Description
0 ... (FF_DL _{min} - 1)	Invalid This range of values is invalid.
FF_DL _{min} ... 4 095	FirstFrame DataLength (FF_DL) without escape sequence The encoding of the segmented message length results in a twelve bit length value (FF_DL) where the least significant bit (LSB) is specified to be bit 0 of the second N_PCI byte (Byte #2) and the most significant bit (MSB) is bit 3 of the first N_PCI byte (Byte #1). The maximum segmented message length supported is equal to 4 095 bytes of user data. It shall be assigned the value of the service parameter <Length>.
4 096 .. 4 294 967 295 (2 ³² -1)	FirstFrame DataLength (FF_DL) with escape sequence The encoding of the segmented message length results in a 32 bit length value (FF_DL) where the least significant bit (LSB) is specified to be bit 0 of the sixth N_PCI byte (Byte #6) and the most significant bit (MSB) is bit 7 of the third N_PCI byte (Byte #3). The maximum segmented message length supported is equal to 4 294 967 295 bytes of user data. It shall be assigned the value of the service parameter <Length>.

9.6.3.2 FF_DL error handling

If the network layer receives an N_PDU indicating a FirstFrame and CAN_DL < 8, then the network layer shall ignore the FF N_PDU.

If the network layer receives a FirstFrame with FF_DL that is greater than the available receiver buffer size, then this shall be considered as an error condition. The network layer shall abort the message reception and send an FC N_PDU with the parameter FlowStatus = Overflow.

If the network layer receives a FirstFrame with an FF_DL that is less than FF_DL_{min}, the network layer shall ignore the received FF N_PDU and not transmit a FC N_PDU.

NOTE Legacy devices that only support the 12 bit version of FF_DL will not send a FlowControl frame if the escape sequence is used as these devices would interpret FF_DL to be less than FF_DL_{min} and as such, not send an FC N_PDU.

If a FirstFrame is received with the escape sequence (where all bits of the lower nibble of PCI byte 1 and all bits of PCI byte 2 are set to 0's) and the FF_DL =< 4 095, then the network layer shall ignore the FF N_PDU and not transmit an FC N_PDU.

9.6.4 ConsecutiveFrame N_PCI parameter definition

9.6.4.1 CF N_PCI byte

The payload data length CAN_DL of the received CAN frame has to match the RX_DL value which was determined in the reception process of the FirstFrame (FF). Only the last CF in the multi-frame transmission may contain less than RX_DL bytes.

9.6.4.2 Transmitter requirements for last consecutive frame

A transmitter of a multi-frame message shall send the last (or only) consecutive frame with only the required number of bytes. See examples below for clarification (normal addressing).

EXAMPLE 1 A last CF with 9 data bytes shall be sent padded to 12 bytes.

EXAMPLE 2 A last CF with 3 bytes of data shall be sent with a CAN_DL of 8 or 4 [(dependent upon the use of CAN frame optimization (see [10.4.2.1](#) and [10.4.2.2](#))].

9.6.4.3 SequenceNumber (SN) parameter definition

The parameter SN is used in the ConsecutiveFrame (CF) N_PDU to specify the following:

- the numeric ascending order of the ConsecutiveFrames;
- that the SN shall start with zero for all segmented messages; the FirstFrame (FF) shall be assigned the value zero; it does not include an explicit SequenceNumber in the N_PCI field but shall be treated as the segment number zero;
- that the SN of the first CF immediately following the FF shall be set to one;
- that the SN shall be incremented by one for each new CF that is transmitted during a segmented message transmission;
- that the SN value shall not be affected by any FlowControl (FC) frame;
- that when the SN reaches the value of 15, it shall wraparound and be set to zero for the next CF.

This shall lead to the sequence given in [Table 16](#).

Table 16 — Summary of SN definition

N_PDU	FF	CF	CF	CF	CF	CF	CF	CF
SN	0 ₁₆	1 ₁₆	...	E ₁₆	F ₁₆	0 ₁₆	1 ₁₆	...

See [Table 17](#) for a definition of SN values.

Table 17 — Definition of SN values

Value	Description
0 ₁₆ – F ₁₆	SequenceNumber (SN) The SequenceNumber (SN) shall be encoded in the lower nibble bits of N_PCI byte #1. The SN shall be set to a value within the range of 0 to 15.

9.6.4.4 SequenceNumber (SN) error handling

If a CF N_PDU message is received with an unexpected SequenceNumber not in accordance with the definition in [9.6.4.3](#), the message reception shall be aborted and the network layer shall make an N_USData.indication service call with the parameter <N_Result> = N_WRONG_SN to the adjacent upper layer.

9.6.5 FlowControl N_PCI parameter definition

9.6.5.1 FlowStatus (FS) parameter definition

The parameter FlowStatus (FS) indicates whether the sending network entity can proceed with the message transmission.

A sending network entity shall support all specified (not reserved) values of the FS parameter.

[Table 18](#) defines the FS values.

Table 18 — Definition of FS values

Value	Description
0 ₁₆	ContinueToSend (CTS) The FlowControl ContinueToSend parameter shall be encoded by setting the lower nibble of the N_PCI byte #1 to "0". It shall cause the sender to resume the sending of ConsecutiveFrames. The meaning of this value is that the receiver is ready to receive a maximum of BS number of ConsecutiveFrames.
1 ₁₆	Wait (WAIT) The FlowControl Wait parameter shall be encoded by setting the lower nibble of the N_PCI byte #1 to "1". It shall cause the sender to continue to wait for a new FlowControl N_PDU and to restart its N_BS timer. If FlowStatus is set to Wait, the values of BS (BlockSize) and ST _{min} (SeparationTime minimum) in the FlowControl message are not relevant and shall be ignored.
2 ₁₆	Overflow (OVFLW) The FlowControl Overflow parameter shall be encoded by setting the lower nibble of the N_PCI byte #1 to "2". It shall cause the sender to abort the transmission of a segmented message and make an N_USData.confirm service call with the parameter <N_Result> = N_BUFFER_OVFLW. This N_PCI FlowStatus parameter value is only allowed to be transmitted in the FlowControl N_PDU that follows the FirstFrame N_PDU and shall only be used if the message length FF_DL of the received FirstFrame N_PDU exceeds the buffer size of the receiving entity. If FlowStatus is set to Overflow, the values of BS (BlockSize) and ST _{min} (SeparationTime minimum) in the FlowControl message are not relevant and shall be ignored.
3 ₁₆ – F ₁₆	Reserved This range of values is reserved by this part of ISO 15765.

9.6.5.2 FlowStatus (FS) error handling

If an FC N_PDU message is received with an invalid (reserved) FS parameter value, the message transmission shall be aborted and the network layer shall make an N_USData.confirm service call with the parameter <N_Result> = N_INVALID_FS to the adjacent upper layer.

9.6.5.3 BlockSize (BS) parameter definition

The BS parameter shall be encoded in byte #2 of the FC N_PCI.

The units of BS are the absolute number of CF N_PDUs per block.

EXAMPLE If BS is equal to 20, then the block will consist of 20 CF N_PDUs.

Only the last block of ConsecutiveFrames in a segmented data transmission may have less than the BS number of frames.

[Table 19](#) provides an overview of the FC N_PCI byte.

Table 19 — Definition of BS values

Value	Description
00 ₁₆	BlockSize (BS) The BS parameter value 0 shall be used to indicate to the sender that no more FC frames shall be sent during the transmission of the segmented message. The sending network layer entity shall send all remaining ConsecutiveFrames without any stop for further FC frames from the receiving network layer entity.
01 ₁₆ – FF ₁₆	BlockSize (BS) This range of BS parameter values shall be used to indicate to the sender the maximum number of ConsecutiveFrames that can be received without an intermediate FC frame from the receiving network entity.

9.6.5.4 SeparationTime minimum (ST_{min}) parameter definition

The ST_{min} parameter shall be encoded in byte #3 of the FC N_PCI.

This time is specified by the receiving entity. The ST_{min} parameter value specifies the minimum time gap allowed between the transmissions of two ConsecutiveFrame network protocol data units (CFs). See [Table 20](#).

Table 20 — Definition of ST_{min} values

Value	Description
00 ₁₆ – 7F ₁₆	SeparationTime minimum (ST_{min}) range: 0 ms – 127 ms The units of ST_{min} in the range 00 ₁₆ – 7F ₁₆ (0 – 127) are absolute milliseconds (ms).
80 ₁₆ – F0 ₁₆	Reserved This range of values is reserved by this part of ISO 15765.
F1 ₁₆ – F9 ₁₆	SeparationTime minimum (ST_{min}) range: 100 μ s – 900 μ s The units of ST_{min} in the range F1 ₁₆ – F9 ₁₆ are even multiples of 100 μ s, where parameter value F1 ₁₆ represents 100 μ s and parameter value F9 ₁₆ represents 900 μ s.
FA ₁₆ – FF ₁₆	Reserved This range of values is reserved by this part of ISO 15765.

The measurement of the ST_{min} starts after completion of transmission of a ConsecutiveFrame (CF) and ends at the request for the transmission of the next CF.

EXAMPLE If ST_{min} is equal to 10 (0A₁₆), then the minimum ST authorized between ConsecutiveFrame network protocol data units is equal to 10 ms.

9.6.5.5 SeparationTime minimum (ST_{min}) error handling

If an FC N_PDU message is received with a reserved ST_{min} parameter value, then the sending network entity shall use the longest ST_{min} value specified by this part of ISO 15765 (7F₁₆ = 127 ms) instead of the value received from the receiving network entity for the duration of the on-going segmented message transmission.

If the time between two subsequent CFs of a segmented data transmission ($N_{As} + N_{Cs}$) is smaller than the value commanded by the receiver via ST_{min} , there is no guarantee that the receiver of the segmented data transmission will correctly receive and process all frames. In any case, the receiver of the segmented data transmission is not required to monitor adherence to the ST_{min} value.

9.6.5.6 Dynamic BS/ ST_{min} values in subsequent FlowControl frames

If the server is the receiver of a segmented message transfer (i.e. the sender of the FlowControl frame), it may choose either to use the same values for BS and ST_{min} in subsequent FC (CTS) frames of the same segmented message or to vary these values from FC to FC frame.

If the client, connected to an ISO 15765-compliant in-vehicle diagnostic network, is the receiver of a segmented message transfer (i.e. the sender of the FlowControl frame), it shall use the same values for BS and ST_{min} in subsequent FC (CTS) frames of the same segmented message.

If the client is the sender of a segmented data transmission (i.e. the receiver of the FlowControl frame), it shall adjust to the values of BS and ST_{min} from each FC (CTS) received during the same segmented data transmission.

NOTE For in-vehicle gateway implementations (i.e. routing takes place on OSI layer 4; see ISO 14229-2[8]), the vehicle manufacturer chooses either that the FC parameters BS and ST_{min} vary during the transmission of a single segmented message or that these parameters are static values. Depending on this design decision, the vehicle manufacturer needs to ensure that server implementations are compatible with the respective in-vehicle gateway implementation.

9.7 Maximum number of FC.WAIT frame transmissions (N_WFTmax)

The purpose of this variable is to avoid communication sender nodes being potentially hooked up in case of a fault condition whereby the latter could be waiting continuously. This parameter is local to communication peers and is not transmitted and is hence not part of the FC protocol data unit.

- The N_WFT_{max} parameter shall indicate how many FC N_PDU WAITs can be transmitted by the receiver in a row.
- The N_WFT_{max} parameter upper limit shall be user defined at system generation time.
- The N_WFT_{max} parameter shall only be used on the receiving network entity during message reception.
- If the N_WFT_{max} parameter value is set to zero, then FlowControl shall rely upon FlowControl continue to send FC N_PDU CTS only. FlowControl wait (FC N_PDU WT) shall not be used by that network entity.

9.8 Network layer timing

9.8.1 Timing parameters

Performance requirement values are the binding communication requirements to be met by each communication peer in order to be compliant with the specification. A certain application may define specific performance requirements within the ranges defined in [Table 21](#).

Timeout values are defined to be higher than the values for the performance requirements in order to ensure a working system and to overcome communication conditions where the performance requirement can absolutely not be met (e.g. high bus load). Specified timeout values shall be treated as the lower limit for any given implementation. The real timeout shall occur no later than at the specified timeout value + 50 %.

The network layer shall issue an appropriate service primitive to the network layer service user upon detection of an error condition.

If a communication path is established between peer protocols entities, identified by N_AI (see [8.3.2.1](#) and [9.4.6.2](#) for further details), a single set of network layer timing parameters is assigned statically to this communication path. For the selection of the network layer timing parameters, no other information besides N_AI is used. If different network layer timing parameters are required for different use cases, then separate communication paths shall be established using different N_AI parameters, e.g. different N_TA and/or N_SA shall be defined for each individual use case that requires different network layer timing parameters.

[Figure 10](#) shows the network layer timing parameters of an unsegmented message while [Table 21](#) defines the network layer timing parameter values and their corresponding start and end positions based on the data link layer services.

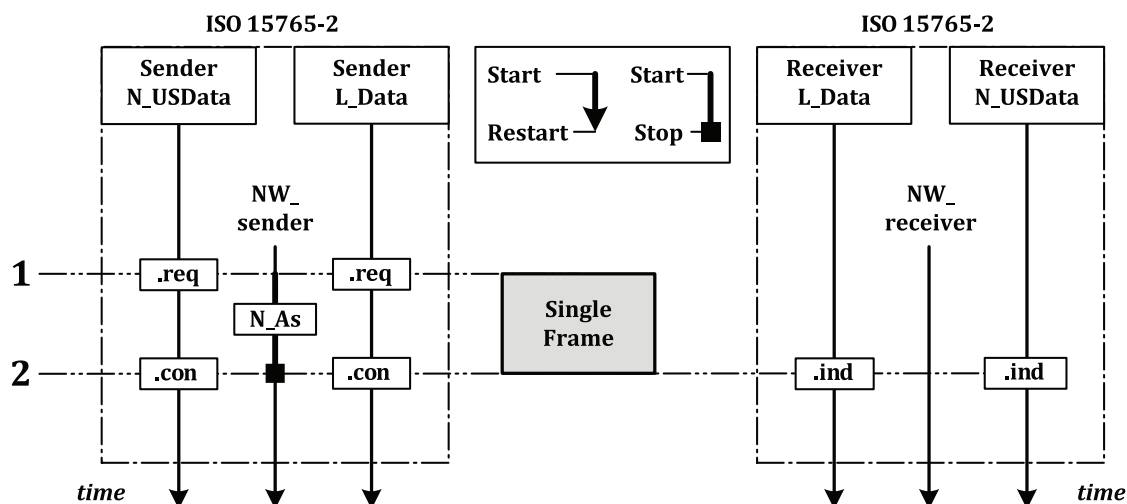

Key

- 1 Sender N_USData.req: the session layer issues an unsegmented message to the transport/network layer
 Sender L_Data.req: the transport/network layer transmits the SingleFrame to the data link layer and starts the N_As timer
- 2 Receiver L_Data.ind: the data link layer issues to the transport/network layer the reception of the CAN frame
 Receiver N_USData.ind: the transport/network layer issues to the session layer the completion of the unsegmented message
 Sender L_Data.con: the data link layer confirms to the transport/network layer that the CAN frame has been acknowledged; the sender stops the N_As timer
 Sender N_USData.con: the transport/network layer issues to the session layer the completion of the unsegmented message

Figure 10 — Placement of network layer timing parameters — Unsegmented message

Figure 11 shows the network layer timing parameters of a segmented message while Table 21 defines the network layer timing parameter values and their corresponding start and end positions based on the data link layer services.

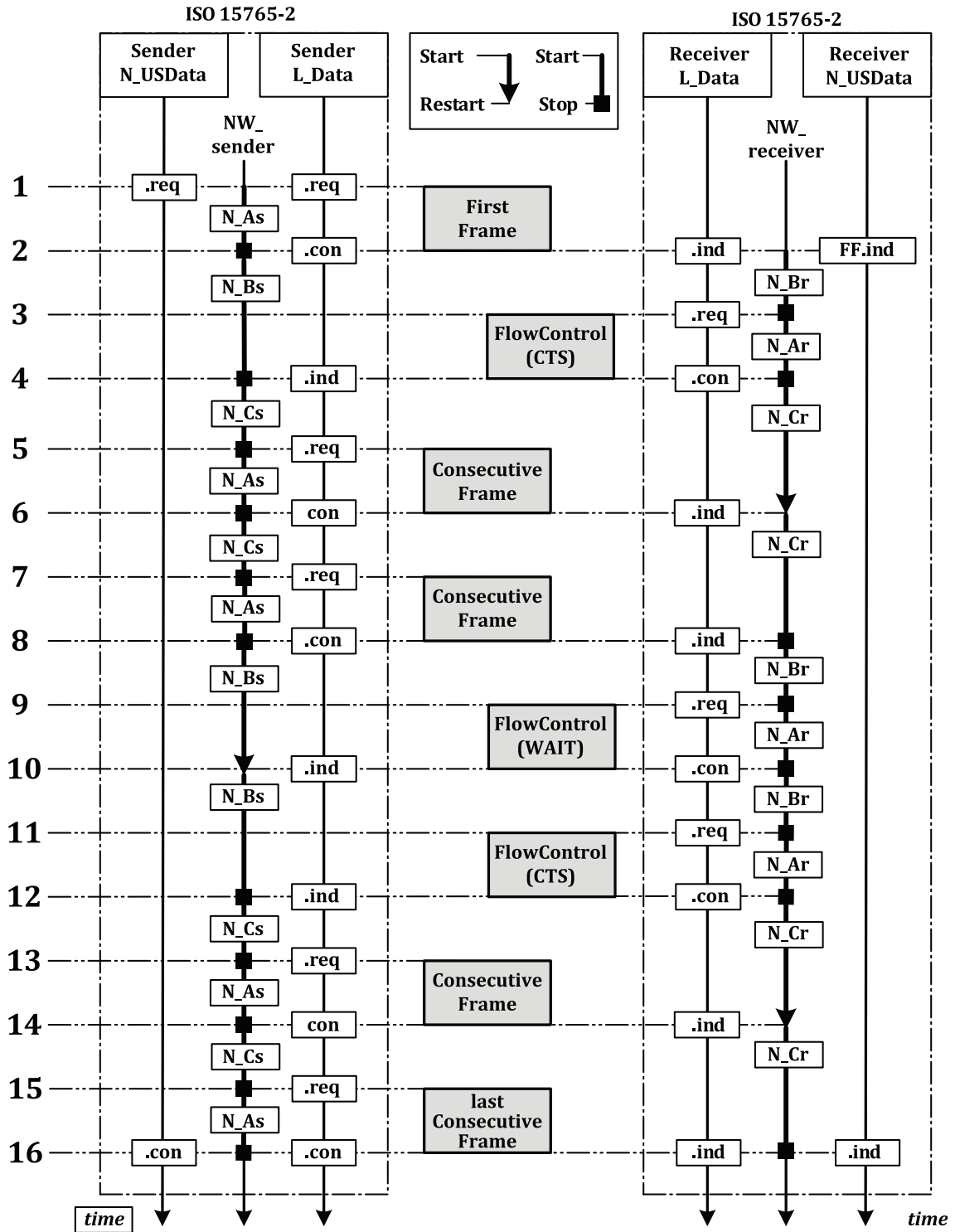

Key

- 1 Sender N_USData.req: the session layer issues a segmented message to the transport/network layer
Sender L_Data.req: the transport/network layer transmits the FirstFrame to the data link layer and starts the N_As timer
- 2 Receiver L_Data.ind: the data link layer issues to the transport/network layer the reception of the CAN frame; the receiver starts the N_Br timer
Receiver N_USData.FF.ind: the transport/network layer issues to the session layer the reception of a FirstFrame of a segmented message
Sender L_Data.con: the data link layer confirms to the transport/network layer that the CAN frame has been acknowledged; the sender stops the N_As timer and starts the N_Bs timer

- 3 Receiver L_Data.req: the transport/network layer transmits the FlowControl (ContinueToSend and BlockSize value = 2_d) to the data link layer and starts the N_Ar timer
- 4 Sender L_Data.ind: the data link layer issues to the transport/network layer the reception of the CAN frame; the sender stops the N_Bs timer and starts the N_Cs timer
Receiver L_Data.con: the data link layer confirms to the transport/network layer that the CAN frame has been acknowledged; the receiver stops the N_Ar timer and starts the N_Cr timer
- 5 Sender L_Data.req: the transport/network layer transmits the first ConsecutiveFrame to the data link layer and starts the N_As timer
- 6 Receiver L_Data.ind: the data link layer issues to the transport/network layer the reception of the CAN frame; the receiver restarts the N_Cr timer
Sender L_Data.con: the data link layer confirms to the transport/network layer that the CAN frame has been acknowledged; the sender stops the N_As timer and starts the N_Cs timer according to the separation time value (ST_{min}) of the previous FlowControl
- 7 Sender L_Data.req: when the N_Cs timer is elapsed (ST_{min}), the transport/network layer transmits the next ConsecutiveFrame to the data link layer and starts the N_As timer
- 8 Receiver L_Data.ind: the data link layer issues to the transport/network layer the reception of the CAN frame; the receiver stops the N_Cr timer and starts the N_Br timer
Sender L_Data.con: the data link layer confirms to the transport/network layer that the CAN frame has been acknowledged; the sender stops the N_As timer and starts the N_Bs timer; the sender is waiting for the next FlowControl.
- 9 Receiver L_Data.req: the transport/network layer transmits the FlowControl (Wait) to the data link layer and starts the N_Ar timer
- 10 Sender L_Data.ind: the data link layer issues to the transport/network layer the reception of the CAN frame; the sender restarts the N_Bs timer
Receiver L_Data.con: the data link layer confirms to the transport/network layer that the CAN frame has been acknowledged; the receiver stops the N_Ar timer and starts the N_Br timer
- 11 Receiver L_Data.req: the transport/network layer transmits the FlowControl (ContinueToSend) to the data link layer and starts the N_Ar timer
- 12 Sender L_Data.ind: the data link layer issues to the transport/network layer the reception of the CAN frame; the sender stops the N_Bs timer and starts the N_Cs timer
Receiver L_Data.con: the data link layer confirms to the transport/network layer that the CAN frame has been acknowledged; the receiver stops the N_Ar timer and starts the N_Cr timer
- 13 Sender L_Data.req: the transport/network layer transmits the ConsecutiveFrame to the data link layer and starts the N_As timer
- 14 Receiver L_Data.ind: the data link layer issues to the transport/network layer the reception of the CAN frame; the receiver restarts the N_Cr timer
Sender L_Data.con: the data link layer confirms to the transport/network layer that the CAN frame has been acknowledged; the sender stops the N_As timer and starts the N_Cs timer according to the separation time value (ST_{min}) of the previous FlowControl
- 15 Sender L_Data.req: when the N_Cs timer is elapsed (ST_{min}), the transport/network layer transmits the last ConsecutiveFrame to the data link layer and starts the N_As timer
- 16 Receiver L_Data.ind: the data link layer issues to the transport/network layer the reception of the CAN frame; the receiver stops the N_Cr timer
Receiver N_USData.ind: the transport/network layer issues to the session layer the completion of the segmented message
Sender L_Data.con: the data link layer confirms to the transport/network layer that the CAN frame has been acknowledged; the sender stops the N_As timer
Sender N_USData.con: the transport/network layer issues to session layer the completion of the segmented message

Figure 11 — Placement of network layer timing parameters — Segmented message

Table 21 — Network layer timing parameter values

Timing parameter	Description	Data link layer service		Time-out ms	Performance requirement ms
		Start	End		
N_As	Time for transmission of the CAN frame (any N_PDU) on the sender side	L_Data.request	L_Data.confirm	1 000	—
N_Ar	Time for transmission of the CAN frame (any N_PDU) on the receiver side	L_Data.request	L_Data.confirm	1 000	—
N_Bs	Time until reception of the next FlowControl N_PDU	L_Data.confirm (FF) L_Data.confirm (CF) L_Data.indication (FC)	L_Data.indication (FC)	1 000	—
N_Br	Time until transmission of the next FlowControl N_PDU	L_Data.indication (FF) L_Data.indication (CF) L_Data.confirm (FC)	L_Data.request (FC)	N/A	$(N_{Br} + N_{Ar}) < (0,9 \times N_{Bs} \text{ timeout})$
N-Cs	Time until transmission of the next ConsecutiveFrame N_PDU	L_Data.indication (FC) L_Data.confirm (CF)	L_Data.request (CF)	N/A	$(N_{Cs} + N_{As}) < (0,9 \times N_{Cr} \text{ timeout})$
N_Cr	Time until reception of the next Consecutive Frame N_PDU	L_Data.confirm (FC) L_Data.indication (CF)	L_Data.indication (CF)	1 000	—

9.8.2 Network layer timeouts

Table 22 defines the cause and action in a network layer timeout.

Table 22 — Network layer timeout error handling

Error	Cause	Action
N_As	Any N_PDU not transmitted in time on the sender side	Abort message transmission and issue N_USData.confirm with <N_Result> = N_TIMEOUT_A
N_Ar	Any N_PDU not transmitted in time on the receiver side	Abort message reception and issue N_USData.indication with <N_Result> = N_TIMEOUT_A
N_Bs	FlowControl N_PDU not received (lost, overwritten) on the sender side or preceding FirstFrame N_PDU or ConsecutiveFrame N_PDU not received (lost, overwritten) on the receiver side	Abort message transmission and issue N_USData.confirm with <N_Result> = N_TIMEOUT_Bs
N_Cr	ConsecutiveFrame N_PDU not received (lost, overwritten) on the receiver side or preceding FC N_PDU not received (lost, overwritten) on the sender side	Abort message reception and issue N_USData.indication with <N_Result> = N_TIMEOUT_Cr

9.8.3 Unexpected arrival of N_PDU

An unexpected N_PDU is defined as one that has been received by a node outside the expected order of N_PDUs. It could be an N_PDU defined by this part of ISO 15765 (SF N_PDU, FF N_PDU, CF N_PDU or FC N_PDU) that is received out of the normal expected order or else it could be an unknown N_PDU that cannot be interpreted by the definitions given in this part of ISO 15765.

As a general rule, arrival of an unexpected N_PDU from any node shall be ignored, with the exception of SF N_PDUs and physically addressed FF N_PDUs; functionally addressed FirstFrames shall be ignored. When the specified action is to ignore an unexpected N_PDU, this means that the network layer shall not notify the upper layers of its arrival.

Depending on the network layer design decision to support full- or half-duplex communication, the interpretation of “unexpected” differs:

- a) with half-duplex, point-to-point communication between two nodes is only possible in one direction at a time;
- b) with full-duplex, point-to-point communication between two nodes is possible in both directions at once.

In addition to this network layer design decision, it is necessary to consider the possibility that a reception or transmission from/to a node with the same address information (N_AI) as contained in the received unexpected N_PDU is in progress.

[Table 23](#) defines the network layer behaviour in the case of the reception of an unexpected N_PDU, in consideration of the actual network layer internal status (NWL status) and the design decision to support half- or full-duplex communication. [Table 23](#) only applies if the received N_PDU contains the same N_AI as the reception or transmission that is in progress at the time the N_PDU is received.

If the N_AI of the received N_PDU is different from the segmented message, an on-going reception/transmission shall be continued.

Table 23 — Handling of unexpected arrival of N_PDU with same N_AI as currently being processed

NWL status	Reception of				
	SF N_PDU	FF N_PDU	CF N_PDU	FC N_PDU	Unknown N_PDU
Segmented transmit in progress	Full-duplex: If a reception is in progress, see the corresponding cell below in this table; otherwise, process the SF N_PDU as the start of a new reception.	Full-duplex: If a reception is in progress, see the corresponding cell below in this table; otherwise, process the FF N_PDU as the start of a new reception.	Full-duplex: If a reception is in progress, see the corresponding cell below in this table.	Ignore ^a	Ignore
	Half-duplex: Ignore	Half-duplex: Ignore	Half-duplex: Ignore		
Segmented receive in progress	Terminate the current reception, report an N_USData.indication, with <N_Result> set to N_UNEXP_PDU, to the upper layer, and process the SF N_PDU as the start of a new reception.	Terminate the current reception, report an N_USData.indication, with <N_Result> set to N_UNEXP_PDU, to the upper layer, and process the FF N_PDU as the start of a new reception.	Ignore ^b : If awaited, process the CF N_PDU in the on-going reception and perform the required checks (e.g. SN in right order); otherwise, ignore it.	Full-duplex: If a transmission is in progress, see corresponding cell above in this table.	Ignore
				Half-duplex: Ignore	
Idle ^c	Process the SF N_PDU as the start of a new reception.	Process the FF N_PDU as the start of a new reception.	Ignore	Ignore	Ignore

^a FC parameter error handling is described separately in [9.6.5.2](#) and [9.6.5.5](#).

^b Handling of an unexpected SN is described separately in [9.6.4.4](#).

^c Neither a segmented transmission nor a segmented reception is in progress. This status “Idle” only describes the network layer itself and is not an indication of the availability of the layers above, which might be busy and thus might not be able to accept a new (SF) request or provide a diagnostic buffer for the data of a multi-frame request (FF).

9.8.4 Wait frame error handling

If the receiver has transmitted N_WFT_{max} FlowControl wait network protocol data units (FC N_PDU WAIT) in a row and, following this, it cannot meet the performance requirement for the transmission of a FlowControl ContinueToSend network protocol data unit (FC N_PDU CTS), then the receiver side shall abort the message reception and issue an N_USData.indication with <N_Result> set to N_WFT_OVRN to the higher layer.

The sender of the message is informed about the aborted message reception via an N_USData.confirm with <N_Result> set to N_TIMEOUT_Bs. (Because of the missing FlowControl N_PDU from the receiver, an N_Bs timeout occurs in the sender.)

9.9 Interleaving of messages

The network layer protocol shall be capable of carrying out parallel transmission of different messages that are not mapped onto the same N_AI. This is necessary to ensure that the receiving peer is able to reassemble in a consistent manner the received network protocol data units. This scheme enables, for example, gateway operation that needs to handle different message transmissions concurrently across distinct sub-networks.

10 Data link layer usage

10.1 Data link layer service parameters

The following data link layer service parameters are defined in ISO 11898-1:

- <Data>: CAN frame data;
- <DLC>: data length code;
- <Identifier>: CAN identifier;
- <Transfer_Status>: status of a transmission;
- <Format>: frame format (CAN, CAN FD, base: 11-bit, extended: 29-bit) (see [Table 4](#)).

10.2 Data link layer interface services

10.2.1 L_Data.request

The service primitive requests transmission of <Data> that shall be mapped within specific attributes of the data link protocol data unit selected by means of <Identifier>.

The <Identifier> shall provide reference to the specific addressing format used to transmit <Data>:

```
L_Data.request    (
                  <Identifier>
                  <Format>
                  <DLC>
                  <Data>
                  )
```

10.2.2 L_Data.confirm

The service primitive confirms the completion of an L_Data.request service for a specific <Identifier>.

The parameter <Transfer_Status> provides the status of the service request:

```
L_Data.confirm    (
                  <Identifier>
                  <Transfer_Status>
                  )
```

10.2.3 L_Data.indication

The service primitive indicates a data link layer event to the adjacent upper layer and delivers <Data> identified by <Identifier>:

```
L_Data.indication (
                  <Identifier>
                  <Format>
                  <DLC>
                  <Data>
                  )
```

10.3 Mapping of the N_PDU fields

10.3.1 Addressing formats

The exchange of network layer data is supported by three addressing formats: normal, extended and mixed addressing. Each addressing format requires a different number of CAN frame data bytes to encapsulate the addressing information associated with the data to be exchanged. Consequently, the number of data bytes transported within a single CAN frame depends on the type of addressing format chosen.

[10.3.2](#) to [10.3.5](#) specify the mapping mechanisms for each addressing format based on the data link layer services and service parameters defined in ISO 11898-1.

10.3.2 Normal addressing

[Table 24](#) defines the mapping of N_PDU parameters into CAN frame where the addressing format is normal and N_TAtype indicates the message is physical.

Table 24 — Mapping of N_PDU parameters into CAN frame — Normal addressing, N_TAtype = #1, #3, #5 and #7

N_PDU type	CAN identifier	CAN frame data field Byte 1 - n ^a
SingleFrame (SF)	N_AI	N_PCI, N_Data
FirstFrame (FF)	N_AI	N_PCI, N_Data
ConsecutiveFrame (CF)	N_AI	N_PCI, N_Data
FlowControl (FC)	N_AI	N_PCI
^a See Table 3 and Table 9 .		

[Table 25](#) defines the mapping of N_PDU parameters into CAN frame where the addressing format is normal and N_TAtype indicates the message is functional.

Table 25 — Mapping of N_PDU parameters into CAN frame — Normal addressing, N_TAtype = #2, #4, #6 and #8

N_PDU type	CAN identifier	CAN frame data field Byte 1 - n ^a
SingleFrame (SF)	N_AI	N_PCI, N_Data
^a See Table 3 and Table 9 .		

10.3.3 Normal fixed addressing

Normal fixed addressing is a subformat of normal addressing in which the mapping of the address information into the CAN identifier is further defined. In the general case of normal addressing, described above, the correspondence between N_AI and the CAN identifier is left open.

For normal fixed addressing, only 29 bit CAN identifiers are allowed. [Table 26](#) and [Table 27](#) define the mapping of the address information (N_AI) into the CAN identifier, depending on the target address type (N_TAtype). N_PCI and N_Data are placed in the CAN frame data field.

[Table 26](#) defines normal fixed addressing where N_TAtype indicates the message is physical.

Table 26 — Normal fixed addressing, N_TAtype = #5 and 7

N_PDU type	29 bit CAN identifier bit position						CAN frame data field byte position Byte 1 - n ^a
	28 - 26	25	24	23 - 16	15 - 8	7 - 0	
SingleFrame (SF)	110 ₂	0	0	218	N_TA	N_SA	N_PCI, N_Data
FirstFrame (FF)	110 ₂	0	0	218	N_TA	N_SA	N_PCI, N_Data
ConsecutiveFrame (CF)	110 ₂	0	0	218	N_TA	N_SA	N_PCI, N_Data
FlowControl (FC)	110 ₂	0	0	218	N_TA	N_SA	N_PCI
^a See Table 3 and Table 9 .							

[Table 27](#) defines normal fixed addressing where N_TAtype indicates the message is functional.

Table 27 — Normal fixed addressing, N_TAtype = #6 and 8

N_PDU type	29 bit CAN identifier bit position						CAN frame data field byte position Byte 1 - n ^a
	28 - 26	25	24	23 - 16	15 - 8	7 - 0	
SingleFrame (SF)	110 ₂	0	0	219	N_TA	N_SA	N_PCI, N_Data
^a See Table 3 and Table 9 .							

10.3.4 Extended addressing

[Table 28](#) defines the mapping of N_PDU parameters into CAN frame where the addressing format is extended and N_TAtype indicates the message is physical.

Table 28 — Mapping of N_PDU parameters into CAN frame — Extended addressing, N_TAtype = #1, #3, #5 and 7

N_PDU type	CAN identifier	Byte 1	Byte 2 - n ^a
SingleFrame (SF)	N_AI, except N_TA	N_TA	N_PCI, N_Data
FirstFrame (FF)	N_AI, except N_TA	N_TA	N_PCI, N_Data
ConsecutiveFrame (CF)	N_AI, except N_TA	N_TA	N_PCI, N_Data
FlowControl (FC)	N_AI, except N_TA	N_TA	N_PCI

^a See [Table 3](#) and [Table 9](#).

[Table 29](#) defines the mapping of N_PDU parameters into CAN frame where the addressing format is extended and N_TAtype indicates the message is functional.

Table 29 — Mapping of N_PDU parameters into CAN frame — Extended addressing, N_TAtype = #2, #4, #6 and 8

N_PDU type	CAN identifier	Byte 1	Byte 2 - n ^a
SingleFrame (SF)	N_AI, except N_TA	N_TA	N_PCI, N_Data

^a See [Table 3](#) and [Table 9](#).

10.3.5 Mixed addressing

10.3.5.1 29 bit CAN identifier

Mixed addressing is the addressing format to be used if Mtype is set to remote diagnostics.

[Table 30](#) and [Table 31](#) define the mapping of the address information (N_AI) into the 29 bit CAN identifier scheme and the first CAN frame data byte, depending on the target address type (N_TAtype). N_PCI and N_Data are placed in the remaining bytes of the CAN frame data field.

Table 30 — Mixed addressing with 29 bit CAN identifier, N_TAtype = #5 and 7

N_PDU type	29 bit CAN identifier bit position						CAN frame data field byte position	
	28 - 26	25	24	23 - 16	15 - 8	7 - 0	1	Byte 2 - n ^a
SingleFrame (SF)	110 ₂	0	0	206	N_TA	N_SA	N_AE	N_PCI, N_Data
FirstFrame (FF)	110 ₂	0	0	206	N_TA	N_SA	N_AE	N_PCI, N_Data
ConsecutiveFrame (CF)	110 ₂	0	0	206	N_TA	N_SA	N_AE	N_PCI, N_Data
FlowControl (FC)	110 ₂	0	0	206	N_TA	N_SA	N_AE	N_PCI

^a See [Table 3](#) and [Table 9](#).

Table 31 — Mixed addressing with 29 bit CAN identifier, N_TAtype = #6 and 8

N_PDU type	29 bit CAN identifier bit position						CAN frame data field byte position	
	28 - 26	25	24	23 - 16	15 - 8	7 - 0	1	Byte 2 - n ^a
SingleFrame (SF)	110 ₂	0	0	205	N_TA	N_SA	N_AE	N_PCI, N_Data

^a See [Table 3](#) and [Table 9](#).

10.3.5.2 11 bit CAN identifier

Mixed addressing is the addressing format to be used if Mtype is set to remote diagnostics.

[Table 32](#) and [Table 33](#) define the mapping of the address information (N_AI) into the 11 bit CAN identifier scheme. For each combination of N_SA, N_TA and N_TAtype, the same CAN identifier can be used. N_AE is placed in the first data byte of the CAN frame data field. N_PCI and N_Data are placed in the remaining bytes of the CAN frame data field.

Table 32 — Mixed addressing with 11 bit CAN identifier, N_TAtype = #1 and 3

N_PDU type	CAN identifier	CAN frame data field	
		Byte 1	Byte 2 - n ^a
SingleFrame (SF)	N_AI	N_AE	N_PCI, N_Data
FirstFrame (FF)	N_AI	N_AE	N_PCI, N_Data
ConsecutiveFrame (CF)	N_AI	N_AE	N_PCI, N_Data
FlowControl (FC)	N_AI	N_AE	N_PCI

^a See [Table 3](#) and [Table 9](#).

Table 33 — Mixed addressing with 11 bit CAN identifier, N_TAtype = #2 and 4

N_PDU type	CAN identifier	CAN frame data field	
		Byte 1	Byte 2 - n ^a
SingleFrame (SF)	N_AI	N_AE	N_PCI, N_Data

^a See [Table 3](#) and [Table 9](#).

10.4 CAN frame data length code (DLC)

10.4.1 DLC parameter

The DLC parameter specifies the number of data bytes transmitted in a CAN frame. This part of ISO 15765 does not specify any requirements concerning the length of the data field in a CAN frame other than those implied by the size of the network layer protocol data units.

An application that implements the network layer as defined in this part of ISO 15765 might either pad all CAN frames to their full length (see [10.4.2.1](#)) or optimize the DLC to the applicable length of the network layer protocol data unit (see [10.4.2.2](#)). CAN frames according to ISO 11898-1 (CAN FD frame type) may require a mandatory padding for DLC values greater than 8 (see [10.4.2.3](#)).

10.4.2 CAN frame data

10.4.2.1 CAN frame data padding (TX_DL = 8)

If this solution is used, the DLC is always set to 8, even if the N_PDU to be transmitted is shorter than 8 bytes. The sender has to pad any unused bytes in the frame, e.g. as depicted in [Table 34](#). In particular, this can be the case for an SF, FC frame or the last CF of a segmented message. If not specified differently, the default value CC₁₆ should be used for frame padding in order to minimize the stuff-bit insertions and bit alterations on the wire.

The DLC parameter of the CAN frame is set by the sender and read by the receiver to determine the number of data bytes per CAN frame to be processed by the network layer. The DLC parameter cannot be used to determine the message length; this information shall be extracted from the N_PCI information at the beginning of a message.

Table 34 — Data padding example (TX_DL = 8), normal addressing, N_PDU size 6 byte, DLC = 8

N_PDU type	CAN Identifier	CAN frame data field							
		Byte 1	Byte 2	Byte 3	Byte 4	Byte 5	Byte 6	Byte 7	Byte 8
SingleFrame (SF)	N_AI	N_PCI	N_Data					padding	
	345 ₁₆	05 ₁₆	44 ₁₆	55 ₁₆	66 ₁₆	77 ₁₆	88 ₁₆	CC ₁₆	CC ₁₆

10.4.2.2 CAN frame data optimization (TX_DL = 8)

If this solution is used, the DLC does not always need to be 8. If the N_PDU to be transmitted is shorter than 8 bytes, then the sender may optimize the CAN bus load by shortening the CAN frame data to contain only the number of bytes occupied by the N_PDU (no padding of unused data bytes). CAN frame data optimization can only be used for an SF, FC frame or the last CF of a segmented message.

EXAMPLE See [Table 35](#).

The DLC parameter of the CAN frame is set by the sender and read by the receiver to determine the number of data bytes per CAN frame to be processed by the network layer. The DLC parameter cannot be used to determine the message length; this information shall be extracted from the N_PCI information in the beginning of a message.

Table 35 — Data optimized example (TX_DL = 8), normal addressing, N_PDU size 6 byte, DLC = 6

N_PDU type	CAN Identifier	CAN frame data field					
		Byte 1	Byte 2	Byte 3	Byte 4	Byte 5	Byte 6
SingleFrame (SF)	N_AI	N_PCI	N_Data				
	345 ₁₆	05 ₁₆	44 ₁₆	55 ₁₆	66 ₁₆	77 ₁₆	88 ₁₆

10.4.2.3 Mandatory padding of CAN FD frames (TX_DL > 8)

According to ISO 11898-1, the data length code (DLC) from 0 to 8 specifies the CAN frame payload length in byte (1:1 mapping). For N_PDU length, values up to 8 bytes either the data padding (see [10.4.2.1](#)) or the DLC data optimization (see [10.4.2.2](#)) are applicable.

The ISO 11898-1 DLC values from 9 to 15 are assigned to non-linear discrete values for CAN frame payload length up to 64 byte. To prevent the transmission of uninitialized data, the padding of CAN frame data is mandatory for DLC values greater than 8 when the length of the N_PDU size to be transmitted is not equal to one of the discrete length values defined in the ISO 11898-1:2015, DLC table. An example is shown in [Table 36](#). For DLC values from 9 to 15, only the mandatory padding shall be used. If not specified differently, the value CC₁₆ should be used for padding as default, to minimize the stuff-bit insertions and bit alterations on the wire.

The DLC parameter of the CAN frame is set by the sender and read by the receiver to determine the number of data bytes per CAN frame to be processed by the network layer. The DLC parameter cannot be used to determine the message length; this information shall be extracted from the N_PCI information in the beginning of a message.

Table 36 — Data padding example (TX_DL > 8), normal addressing, N_PDU size 11 bytes, DLC = 9

N_PDU type	CAN Identifier	CAN frame data field											Byte 12
		Byte 1	Byte 2	Byte 3	Byte 4	Byte 5	Byte 6	Byte 7	Byte 8	Byte 9	Byte 10	Byte 11	
Single-Frame (SF)	N_AI	N_PCI		N_Data									Mandatory padding
	345 ₁₆	00 ₁₆	09 ₁₆	11 ₁₆	22 ₁₆	33 ₁₆	44 ₁₆	55 ₁₆	66 ₁₆	77 ₁₆	88 ₁₆	99 ₁₆	CC ₁₆

NOTE ISO 11898-1:2015, DLC table value 9 leads to a CAN FD frame payload length of 12 byte.

10.4.3 Data length code (DLC) error handling

Depending on the N_PCI value, the network layer can calculate the smallest expected value for the CAN DLC parameter in a received CAN frame.

Reception of a CAN frame with a DLC value smaller than expected (less than 8 for applications which pad the CAN frames or smaller than implied by the size of the network protocol data unit for implementations using data optimization) shall be ignored by the network layer without any further action.

For details, see specific error handling in [9.6](#).

Annex A (normative)

Use of normal fixed and mixed addressing with data link layer according to SAE J1939

A.1 Overview

This Annex describes how to map address information parameters, N_AI, into the CAN frame when a data link layer according to SAE J1939 is used.

A.2 Rules

A.2.1 Normal fixed addressing

[Table A.1](#) shows the mapping of address information parameters, N_AI, into the CAN frame when network target address type, N_TAtype, physical addressing is used.

Table A.1 — Normal addressing, physical addressed messages

SAE J1939 name	P	R	DP	PF	PS	SA	Data field
Bits	3	1	1	8	8	8	64
Content	default 110 ₂	0	0	218	N_TA	N_SA	N_PCI, N_Data
CAN ID bits	28 – 26	25	24	23 – 16	15 – 8	7 – 0	—
CAN data byte	—	—	—	—	—	—	1 – 8
CAN field	Identifier						Data

NOTE See [A.2.3](#) to [A.2.8](#) for definitions of the abbreviated terms used in this table.

[Table A.2](#) shows the mapping of address information parameters, N_AI, into the CAN frame when network target address type, N_TAtype, functional addressing is used.

Table A.2 — Normal addressing, functional addressed messages

SAE J1939 name	P	R	DP	PF	PS	SA	Data field
Bits	3	1	1	8	8	8	64
Content	default 110 ₂	0	0	219	N_TA	N_SA	N_PCI, N_Data
CAN ID bits	28 – 26	25	24	23 – 16	15 – 8	7 – 0	—
CAN data byte	—	—	—	—	—	—	1 – 8
CAN field	Identifier						Data

NOTE See [A.2.3](#) to [A.2.8](#) for definitions of the abbreviated terms used in this table.

A.2.2 Mixed addressing

[Table A.3](#) shows the mapping of address information parameters, N_AI, into the CAN frame when the network target address type, N_TAtype, physical addressing is used.

Table A.3 — Mixed addressing, physical addressed messages

SAE J1939 name	P	R	DP	PF	PS	SA	Data field	
Bits	3	1	1	8	8	8	8	56
Content	default 110 ₂	0	0	206	N_TA	N_SA	N_AE	N_PCI, N_Data
CAN ID bits	28 – 26	25	24	23 – 16	15 – 8	7 – 0		—
CAN data byte	—	—	—	—	—	—	1	2 – 8
CAN field	Identifier						Data	
NOTE See A.2.3 to A.2.8 for definitions of the abbreviated terms used in this table.								

[Table A.4](#) shows the mapping of address information parameters, N_AI, into the CAN frame when network target address type, N_TAtype, functional addressing is used.

Table A.4 — Mixed addressing, functional addressed messages

SAE J1939 name	P	R	DP	PF	PS	SA	Data field	
Bits	3	1	1	8	8	8	8	56
Content	default 110 ₂	0	0	205	N_TA	N_SA	N_AE	N_PCI, N_Data
CAN ID bits	28 – 26	25	24	23 – 16	15 – 8	7 – 0		—
CAN data byte	—	—	—	—	—	—	1	2 – 8
CAN field	Identifier						Data	
NOTE See A.2.3 to A.2.8 for definitions of the abbreviated terms used in this table.								

A.2.3 Priority (P)

The priority is user defined with a default value of six.

The 3 bit priority field is used to optimize message latency for transmission onto the CAN bus only. The priority field should be masked off by the receiver (ignored). The priority of any CAN message can be set from highest, 0 (000 bin.), to lowest, 7 (111 bin.).

A.2.4 Reserved bit (R)

The reserved bit shall be set to “0”.

A.2.5 Data page (DP)

The data page bit shall be set to “0”.

A.2.6 Protocol data unit format (PF)

The format is of the type PDU1, “destination specific”.

Diagnostic messages shall use the following parameter group numbers (PGN):

- mixed addressing: 52736 for N_TAtype = #5, which gives PF = 206;
- mixed addressing: 52480 for N_TAtype = #6, which gives PF = 205;
- normal fixed addressing: 55808 for N_TAtype = #5, which gives PF = 218;
- normal fixed addressing: 56064 for N_TAtype = #6, which gives PF = 219.

A.2.7 PDU-specific (PS)

The PDU-specific field shall contain the target address (destination address), N_TA.

A.2.8 Source address (SA)

The SA field shall contain the source address, N_SA.

A.2.9 Update rate

Update rate is defined according to user requirements.

A.2.10 Data length

Data length shall be 8 bytes.

Annex B (normative)

Reserved CAN IDs

The purpose of this Annex is to reserve CAN IDs out of the 11 bit CAN ID range for future use in International Standards.

[Table B.1](#) defines the reserved CAN ID ranges.

Table B.1 — ISO-reserved CAN IDs

CAN identifier	Description
7F4 ₁₆ – 7F6 ₁₆	Reserved by ISO 15765-2
7FA ₁₆ – 7FB ₁₆	Reserved by ISO 15765-2

Bibliography

- [1] ISO/IEC 10731, *Information technology — Open Systems Interconnection — Basic Reference Model — Conventions for the definition of OSI services*
- [2] ISO 11898-2, *Road vehicles — Controller area network (CAN) — Part 2: High-speed medium access unit*
- [3] ISO 11898-3, *Road vehicles — Controller area network (CAN) — Part 3: Low-speed, fault-tolerant, medium-dependent interface*
- [4] ISO 11898-4, *Road vehicles — Controller area network (CAN) — Part 4: Time-triggered communication*
- [5] ISO 11898-5, *Road vehicles — Controller area network (CAN) — Part 5: High-speed medium access unit with low-power mode*
- [6] ISO 11898-6, *Road vehicles — Controller area network (CAN) — Part 6: High-speed medium access unit with selective wake-up functionality*
- [7] ISO 14229-1, *Road vehicles — Unified diagnostic services (UDS) — Part 1: Specification and requirements*
- [8] ISO 14229-2, *Road vehicles — Unified diagnostic services (UDS) — Part 2: Session layer services*
- [9] ISO 14229-3, *Road vehicles — Unified diagnostic services (UDS) — Part 3: Unified diagnostic services on CAN implementation (UDSonCAN)*
- [10] ISO 15031-2, *Road vehicles — Communication between vehicle and external equipment for emissions-related diagnostics — Part 2: Guidance on terms, definitions, abbreviations and acronyms*
- [11] ISO 15031-5, *Road vehicles — Communication between vehicle and external equipment for emissions-related diagnostics — Part 5: Emissions-related diagnostic services*
- [12] ISO 15031-6, *Road vehicles — Communication between vehicle and external equipment for emissions-related diagnostics — Part 6: Diagnostic trouble code definitions*
- [13] ISO 15765-1, *Road vehicles — Diagnostic communication over Controller Area Network (DoCAN) — Part 1: General information and use case definition*
- [14] ISO 15765-4, *Road vehicles — Diagnostic communication over Controller Area Network (DoCAN) — Part 4: Requirements for emissions-related systems*
- [15] ISO 27145-2, *Road vehicles — Implementation of World-Wide Harmonized On-Board Diagnostics (WWH-OBD) communication requirements — Part 2: Common data dictionary*
- [16] ISO 27145-3, *Road vehicles — Implementation of World-Wide Harmonized On-Board Diagnostics (WWH-OBD) communication requirements — Part 3: Common message dictionary*
- [17] ISO 27145-4, *Road vehicles — Implementation of World-Wide Harmonized On-Board Diagnostics (WWH-OBD) communication requirements — Part 4: Connection between vehicle and test equipment*
- [18] SAE J1930, *Electrical/Electronic Systems Diagnostic Terms, Definitions, Abbreviations and Acronyms*
- [19] SAE J1939:2011, *Serial Control and Communications Heavy Duty Vehicle Network — Top Level Document*
- [20] SAE J1939-73:2010, *Application layer — Diagnostics*

- [21] SAE J1979, *E/E Diagnostic Test Modes*
- [22] SAE J2012, *Diagnostic Trouble Code Definitions*

British Standards Institution (BSI)

BSI is the national body responsible for preparing British Standards and other standards-related publications, information and services.

BSI is incorporated by Royal Charter. British Standards and other standardization products are published by BSI Standards Limited.

About us

We bring together business, industry, government, consumers, innovators and others to shape their combined experience and expertise into standards-based solutions.

The knowledge embodied in our standards has been carefully assembled in a dependable format and refined through our open consultation process. Organizations of all sizes and across all sectors choose standards to help them achieve their goals.

Information on standards

We can provide you with the knowledge that your organization needs to succeed. Find out more about British Standards by visiting our website at bsigroup.com/standards or contacting our Customer Services team or Knowledge Centre.

Buying standards

You can buy and download PDF versions of BSI publications, including British and adopted European and international standards, through our website at bsigroup.com/shop, where hard copies can also be purchased.

If you need international and foreign standards from other Standards Development Organizations, hard copies can be ordered from our Customer Services team.

Subscriptions

Our range of subscription services are designed to make using standards easier for you. For further information on our subscription products go to bsigroup.com/subscriptions.

With **British Standards Online (BSOL)** you'll have instant access to over 55,000 British and adopted European and international standards from your desktop. It's available 24/7 and is refreshed daily so you'll always be up to date.

You can keep in touch with standards developments and receive substantial discounts on the purchase price of standards, both in single copy and subscription format, by becoming a **BSI Subscribing Member**.

PLUS is an updating service exclusive to BSI Subscribing Members. You will automatically receive the latest hard copy of your standards when they're revised or replaced.

To find out more about becoming a BSI Subscribing Member and the benefits of membership, please visit bsigroup.com/shop.

With a **Multi-User Network Licence (MUNL)** you are able to host standards publications on your intranet. Licences can cover as few or as many users as you wish. With updates supplied as soon as they're available, you can be sure your documentation is current. For further information, email bsmusales@bsigroup.com.

Revisions

Our British Standards and other publications are updated by amendment or revision.

We continually improve the quality of our products and services to benefit your business. If you find an inaccuracy or ambiguity within a British Standard or other BSI publication please inform the Knowledge Centre.

Copyright

All the data, software and documentation set out in all British Standards and other BSI publications are the property of and copyrighted by BSI, or some person or entity that owns copyright in the information used (such as the international standardization bodies) and has formally licensed such information to BSI for commercial publication and use. Except as permitted under the Copyright, Designs and Patents Act 1988 no extract may be reproduced, stored in a retrieval system or transmitted in any form or by any means – electronic, photocopying, recording or otherwise – without prior written permission from BSI. Details and advice can be obtained from the Copyright & Licensing Department.

Useful Contacts:

Customer Services

Tel: +44 845 086 9001

Email (orders): orders@bsigroup.com

Email (enquiries): cservices@bsigroup.com

Subscriptions

Tel: +44 845 086 9001

Email: subscriptions@bsigroup.com

Knowledge Centre

Tel: +44 20 8996 7004

Email: knowledgecentre@bsigroup.com

Copyright & Licensing

Tel: +44 20 8996 7070

Email: copyright@bsigroup.com

BSI Group Headquarters

389 Chiswick High Road London W4 4AL UK