

Pallets for materials handling — Quality of fasteners for assembly of new and repair of used, flat, wooden pallets

ICS 55.180.20

National foreword

This British Standard reproduces verbatim ISO 15629:2002 and implements it as the UK national standard.

The UK participation in its preparation was entrusted by Technical Committee PKW/5, Primary and transport packaging, to Subcommittee PKW/5/34, Pallets, which has the responsibility to:

- aid enquirers to understand the text;
- present to the responsible international/European committee any enquiries on the interpretation, or proposals for change, and keep the UK interests informed;
- monitor related international and European developments and promulgate them in the UK.

A list of organizations represented on this subcommittee can be obtained on request to its secretary.

Cross-references

The British Standards which implement international publications referred to in this document may be found in the *BSI Catalogue* under the section entitled “International Standards Correspondence Index”, or by using the “Search” facility of the *BSI Electronic Catalogue* or of British Standards Online.

This publication does not purport to include all the necessary provisions of a contract. Users are responsible for its correct application.

Compliance with a British Standard does not of itself confer immunity from legal obligations.

This British Standard, having been prepared under the direction of the Consumer Products and Services Sector Policy and Strategy Committee, was published under the authority of the Standards Policy and Strategy Committee on 12 December 2002

Summary of pages

This document comprises a front cover, an inside front cover, the ISO title page, pages ii to iv, pages 1 to 17 and a back cover.

The BSI copyright date displayed in this document indicates when the document was last issued.

Amendments issued since publication

Amd. No.	Date	Comments

© BSI 12 December 2002

ISBN 0 580 40942 2

INTERNATIONAL
STANDARD

ISO
15629

First edition
2002-11-01

**Pallets for materials handling — Quality of
fasteners for assembly of new and repair of
used, flat, wooden pallets**

*Palettes pour la manutention et le transport de marchandises — Qualité des
éléments de fixation pour l'assemblage et la réparation des palettes en bois*



Reference number
ISO 15629:2002(E)

Foreword

ISO (the International Organization for Standardization) is a worldwide federation of national standards bodies (ISO member bodies). The work of preparing International Standards is normally carried out through ISO technical committees. Each member body interested in a subject for which a technical committee has been established has the right to be represented on that committee. International organizations, governmental and non-governmental, in liaison with ISO, also take part in the work. ISO collaborates closely with the International Electrotechnical Commission (IEC) on all matters of electrotechnical standardization.

International Standards are drafted in accordance with the rules given in the ISO/IEC Directives, Part 3.

Draft International Standards adopted by the technical committees are circulated to the member bodies for voting. Publication as an International Standard requires approval by at least 75 % of the member bodies casting a vote.

Attention is drawn to the possibility that some of the elements of this International Standard may be the subject of patent rights. ISO shall not be held responsible for identifying any or all such patent rights.

International Standard ISO 15629 was prepared by Technical Committee ISO/TC 51, *Pallets for unit load method of materials handling*.

Annexes A, B and C of this International Standard are for information only.

Introduction

Efficient international transportation of products depends on both pallet strength and functionality, or fit, to the materials handling systems. Existing ISO standards address issues of strength and some issues regarding functionality of pallets. However, major issues related to the minimum material quality and manufacturing and repair workmanship are not addressed in current ISO standards. These factors may significantly impact the efficiency of international unit-load material handling.

In November, 1996, ISO TC 51 approved a new work item “Timber Pallets for Materials Handling — Quality of Component Assembly and Repair” and established WG 7 to prepare a document.

This International Standard contains recommended minimum acceptable quality levels for mechanical fasteners used in the assembly of wooden pallets. Mechanical fasteners commonly used for the assembly of wooden pallets are classified as nails, staples, bolts and screws. The type and properties of fasteners affect pallet performance.

This International Standard does not address safety problems, if any, associated with the use of these fasteners. It is the responsibility of the user of this International Standard to establish appropriate safety and health practices and determine the applicability of regulatory limitations prior to use.

This document addresses the current commercial difficulty in pallet manufacture, that there is no recognized means of defining pallet nails with regard to their quality and strength. Table 2 gives a guide as to strength qualities for nails which are typically used in construction of very strong pallets as opposed to pallets designed for light loads.

Actual nail diameter, profiles and strengths are the responsibility of the specifier and user who may find the full-scale pallet tests described in ISO 8611-1 of value.

In September 1999 it was decided to publish four related International Standards:

- ISO 15629:2002, *Pallets for materials handling — Quality of fasteners for assembly of new and repair of used, flat, wooden pallets*
- ISO 18333, *Pallets for materials handling — Quality of new wooden components for flat pallets*
- ISO 18334, *Pallets for materials handling — Quality of assembly of new, wooden, flat pallets*
- ISO 18613, *Repair of flat wooden pallets*

Pallets for materials handling — Quality of fasteners for assembly of new and repair of used, flat, wooden pallets

1 Scope

This International Standard gives guidelines on nails and staples used in the assembly of new and repair of used wooden flat pallets.

For the purposes of this International Standard the term fasteners applies to nails and staples only.

This International Standard is prescriptive and performance-based and contains physical descriptions of fasteners as well as minimum recommended performance levels.

For information on other fasteners such as bolts and screws used in pallets, see ISO 445.

2 Normative references

The following normative documents contain provisions which, through reference in this text, constitute provisions of this International Standard. For dated references, subsequent amendments to, or revisions of, any of these publications do not apply. However, parties to agreements based on this International Standard are encouraged to investigate the possibility of applying the most recent editions of the normative documents indicated below. For undated references, the latest edition of the normative document referred to applies. Members of ISO and IEC maintain registers of currently valid International Standards.

ISO 445, *Pallets for materials handling — Vocabulary*

ISO 12777-1, *Methods of test for pallet joints — Part 1: Determination of bending resistance of pallet nails, other dowel-type fasteners and staples*

ISO 12777-2, *Methods of test for pallet joints — Part 2: Determination of withdrawal and head pull-through resistance of pallet nails and staples*

3 Terms and definitions

For the purposes of this International Standard, the terms and definitions given in ISO 445 apply together with the following.

3.1

fluted nail

round wire nail with thread-crests parallel to the nail shank

4 Nails and Staples

4.1 Classification

As used in pallets, nails are classified as plain- or smooth-shank, helical, annular ring, twisted or barbed. Staples have either round-wire or approximately square-wire legs, referring to the cross-sectional shape of the wire. Nails and staples shall be specified using at least nail wire diameter, length, thread type and point type. These and other characteristics which affect pallet nail and staple performance are listed in Table 1.

Table 1 — Physical and mechanical characteristics of nails and staples used in pallets

Nails — Shank profiles				Staples	
Plain (smooth)	Helical	Annular	Square twisted — barbed	Round wire	Square wire
Length nail (wire) diameter	Length nail (wire) diameter	Length nail (wire) diameter	Length nail (wire) diameter ^a	Length staple leg diameter	Length Staple leg width and thickness
Head diameter	Head diameter	Head diameter	Head diameter	Crown length	Crown length
—	Thread length	Thread length	—	—	—
—	Thread-crest diameter	Thread-crest diameter	Flute-crest diameter	—	—
—	Number of helixes	Number of rings	Number of helixes	—	—
—	Number of flutes	—	Number of flutes	—	—
Type of point	Type of point	Type of point	Type of point	Type of point	Type of point
Bending resistance	Bending resistance	Bending resistance	Bending resistance	Bending resistance	Bending resistance

^a The nail (wire) diameter is the thread crest diameter.

4.2 Measurement of physical characteristics

Methods of measuring the physical characteristics of nails and staples are described in annex A. When a complete assessment of fastener quality is required, separation resistance in accordance with ISO 12777-2 shall be determined by measuring both fastener shank withdrawal and head or crown pull-through. These tests shall include using wood specimens and specimen conditioning typical of those which occur during pallet use.

4.3 Minimum acceptable performance

The recommended minimum acceptable performance levels for nails and staples are specified in Table 2. Annex B is a correlation between the static bending resistance values reported in Table 2 and the MIBANT impact bend test as described in ISO 12777-1.

NOTE 1 Tests of joints containing multiple fasteners are described in ISO 12777-3.

NOTE 2 Pallet fasteners are sometimes coated. These coatings are intended to:

- increase corrosion resistance;
- improve separation resistance;
- improve drivability.

The effect of coatings on fastener performance shall be evaluated using tests described in ISO 12777-2.

Table 2 — Recommended minimum quality of staples and nails^a

Performance level ^d	Minimum separation resistance ^b per fastener			Minimum bending resistance ^c per fastener			Minimum ratio of nail head/nail (wire) diameter	Minimum staple crown length
	1	2	3	1	2	3		
Block or stringer fasteners	2 000 N	1 000 N	600 N	6,0 N·m	5,4 N·m	3,5 N·m	2,00	9,5 mm + 2 × (leg width or diameter)
Clinched mat fasteners	1 000 N	500 N	250 N	2,5 N·m	2,2 N·m	1,6 N·m	2,00	9,5 mm + 2 × (leg width or diameter)

^a The quality levels represent those of pallet fasteners successfully used. It is the responsibility of the pallet specifier to determine the appropriate fastener quality necessary for use.

^b Determined in accordance with ISO 12777-2 by measuring both fastener shank withdrawal and head or crown pull-through resistance.

^c Determined in accordance with ISO 12777-1.

^d Performance level refers to relative levels of pallet structural durability or resistance to rough handling during pallet use. Levels 1, 2, and 3 refer to fastener quality levels for use in reusable pallets of respectively high, medium and low levels of structural durability.

Annex A (informative)

Methods of measuring pallet nail and staple physical characteristics

A.1 Sampling

A random sample of at least twelve (12) specimens per “lot” of fasteners is recommended. Average values and an appropriate measure of statistical dispersion should be reported.

NOTE A “lot” consists of fasteners of a single shipment of the same specification and produced during a single continuous production run.

A.2 Fastener length

A.2.1 Nails

The nail length (l) is the distance, measured parallel to the nail-shank axis, from the top of the head to the tip of the point, as shown in Figure A.1. For this measurement, a caliper or ruler is used to measure to the nearest 0,5 mm.

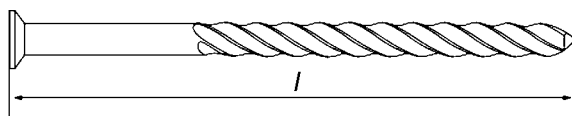

Figure A.1 — Schematic diagram of nail length measurement

A.2.2 Staples

The staple length (L) is the distance, measured parallel to the staple-leg axis, from the bottom of the crown to the tip of the point, as shown in Figure A.2. For this measurement, a caliper or ruler is used to measure to the nearest 0,5 mm.

A.3 Thread length

The thread length (L_T) is the continuous distance from the top end of the thread along the nail shank to the top of the point or the bottom end of the thread, as shown in Figure A.3. If the thread is not continuous, i.e. interrupted, the thread length is the length of the threaded portions of the nail shank penetrating the nailing member to the required depth. The thread length is measured with a caliper or ruler to the nearest 0,5 mm.

A.4 Nail or staple wire diameter

A.4.1 Plain, helical barbed and annular round-wire nails

The wire diameter (d) is the distance across the non-threaded portion of the nail shank away from the gripper marks, as shown in Figure A.4. The wire diameter is measured using a micrometer to the nearest 0,025 mm. If the nail is coated, the coating should be carefully removed where the measurement is to be made.

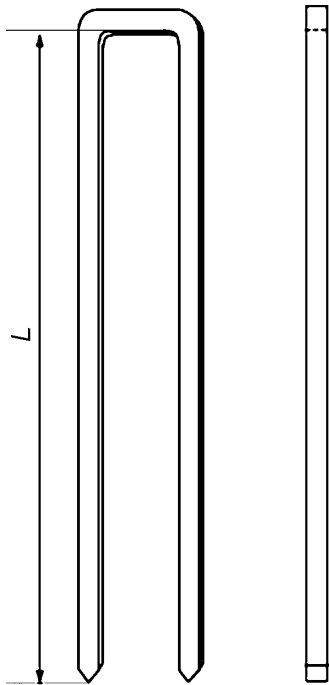

Figure A.2 — Schematic diagram of the staple length measurement

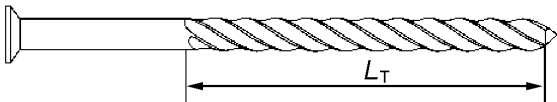
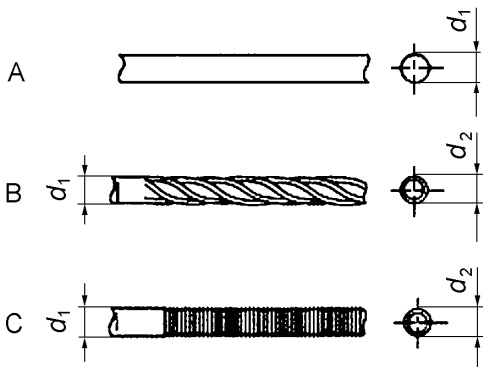

Figure A.3 — Schematic diagram of the thread length measurement



- Key**
- A Plain shank
 - B Helically threaded
 - C Annularly threaded
 - d_1 Wire diameter
 - d_2 Thread diameter

Figure A.4 — Schematic diagram of nail wire diameter (d) measurements

A.4.2 Staples

The wire diameter of both staple legs is the same. For round-wire bulk staples, it is the distance across one of the staple legs. For flattened-wire staples, usually having a rectangular cross-section, the corresponding measurements are the thickness (T) and the width (W) of the staple leg, as shown in Figure A.5. The thickness is the wire dimension in the direction perpendicular to the staple crown. The thickness is normally the largest cross-sectional leg dimension. The width is the wire dimension in the direction parallel to the staple crown. Both thickness and width are measured to the nearest 0,025 mm, along the uncoated portion of the staple leg, using a micrometer.

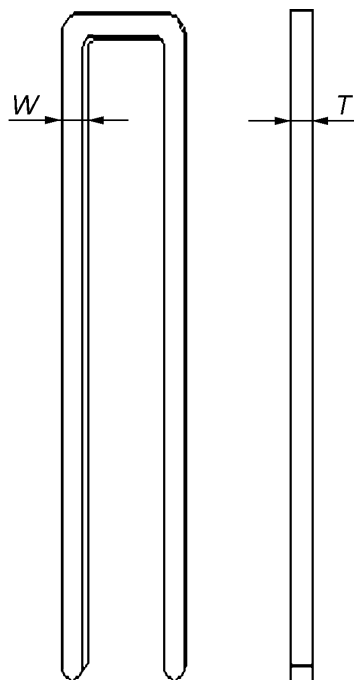
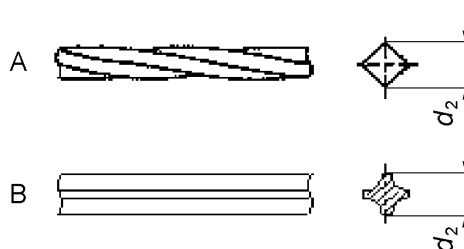

Figure A.5 — Schematic diagram of the measurement of staple width and thickness

A.4.3 Fluted or twisted square shank nails

For fluted or twisted square shank nails, the nail wire diameter (d) is to be the thread crest diameter, as shown in Figure A.6. Fluted nails are formed by drawing round wire through a threading die.



Key

- A Square wire twisted shank
- B Square wire fluted shank
- d_2 Diameter

Figure A.6 — Schematic diagram of the wire diameter measurement for fluted or twisted square shank nails

A.5 Thread-crest diameter

A.5.1 Fluted, twisted and threaded nails

The thread-crest diameter (D_T) of fluted, twisted, and threaded nails is the distance from crest to crest along the deformed portion of the nail shank, as shown in Figure A.7. It is measured in the direction perpendicular to the nail axis, to the nearest 0,025 mm, using a flat-spindle micrometer. To account for any non-uniformity or taper of the shank deformations, measurements should be made at least at three locations, that is near the two ends and along the centre of the flutes or threads while rotating the nail. Thread crests should be sharp and not rounded.

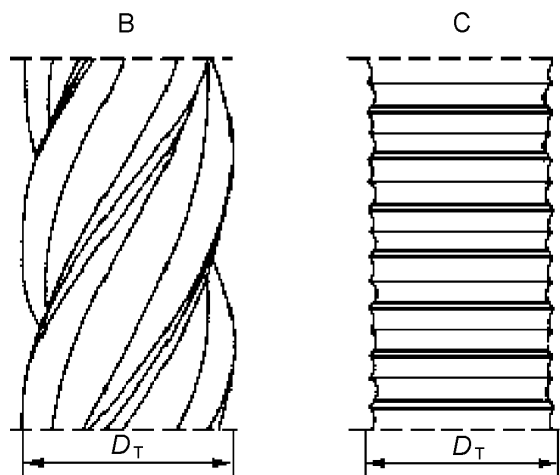

Key

- B Helically threaded shank
- C Annularly threaded shank
- D_T Thread-crest diameter

Figure A.7 — Schematic diagram of the thread crest diameter measurement

A.5.2 Individual nail

The thread-crest diameter (D_T) of an individual nail is the average of at least three measurements. This diameter may vary considerably for nails taken from a single sample or from a lot of nails as well as from several lots of nails of the same shipment.

A.6 Thread helixes

A.6.1 Helically threaded round-wire nails

For helically threaded round-wire nails, the number of helixes of helically threaded round-wire nails is the number of major thread crossings along the full thread length. Major threads are those threads in double thread-crest nails where the major and minor threads are located close and parallel to each other. Using a nail with a thread diameter equal to the average thread diameter of the sample and placing a ruler along the thread parallel to the nail axis, as shown in Figure A.8, count the number of thread crests (or projected thread crests in the case of a tapered thread). The number of helixes can be obtained by dividing the number of thread contacts by the exact length over which they were counted and multiplying the resulting value by the total thread length. This value should be rounded off to the nearest 0,1 helix.

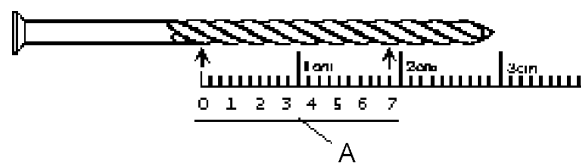

Key

- A Number of thread contacts
- Number of helixes = (7 thread contacts/1,9 cm thread length) × 3 cm

Figure A.8 — Schematic diagram of the number of helixes in a threaded nail

A.6.2 Twisted square-wire or fluted nails

For twisted square-wire nails, the flutes of twisted square-wire nails or fluted nails extend the entire length of the nail shank from the point to the underside of the head. The determination of the number of helixes of twisted square-wire nails should be the same as that for helically threaded round-wire nails, as shown in Figure A.9.

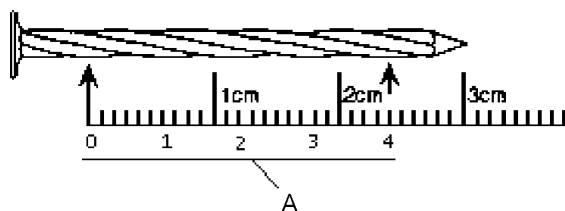

Key

- A Number of thread contacts
- Number of helixes = (4 thread contacts/2,4 cm thread length) × 3 cm

Figure A.9 — Schematic diagram of the number of helixes in a twisted square wire nail

A.7 Thread rings — Annularly threaded nails

For annularly threaded nails, the number of major thread rings along the nail shank should be counted and recorded. Major thread rings are those thread rings in double thread-crest nails where the major and minor thread rings are close and parallel to each other, as shown in Figure A.10. To determine the number of rings per inch along the threaded portion of the nail shank, the number of major thread rings should be counted and divided by the thread length. Since there is usually little variation in the number of major rings within a sample or lot of annularly threaded nails, the examination of five fasteners is sufficient to obtain a reliable value for the number of rings.

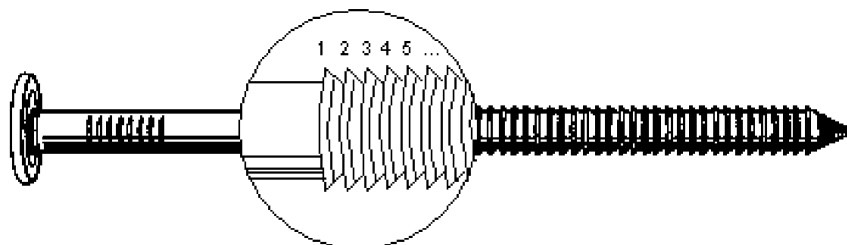

Key

- 1 2 3 4 5 ... = count of major thread rings

Figure A.10 — Schematic diagram of the major thread rings in annularly threaded nails

A.8 Thread flutes

A.8.1 Helically threaded and twisted square-wire nails

For helically threaded and twisted square-wire nails, the number of flutes along the nail shank can be observed by looking at the point end of the nail and counting the major depressions along the surface or of the cross-section of the nail shank, as shown in Figure A.11. The twisted square-wire nail has four flutes. The helically threaded nail normally has four or five flutes. For special nails and, particularly, for stout nails, the use of a larger number of flutes may occur.

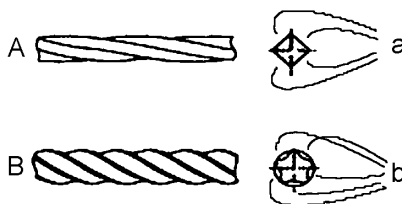

Key

A	Square twisted shank
B	Helically threaded shank
a	4 flutes
b	5 flutes

Figure A.11 — Schematic diagrams of flutes in threaded nails

A.8.2 Variation of the number of flutes

Variations in the number of flutes can be found within a sample of helically threaded nails. Therefore, all nails of a sample of threaded nails should be examined for the number of flutes along the shank. The thread angle should be computed for each nail with a different number of flutes.

A.9 Thread angle

For helically threaded round-wire and twisted square-wire nails, the thread angle (α_T) is measured relative to a plane perpendicular to the axis of the nail shank, as shown in Figure A.12. This angle can be measured using a protractor from the carbon impression obtained after having the nail shank rolled over a sheet of carbon paper. However, more consistent angle values can be obtained by computing the average thread angle, α_T , in degrees, using a calculator which is programmed in line with the following equation:

$$\alpha_T = \arctan \left\{ F / [D_T \times \pi \times (N / L_T)] \right\}$$

where

- F is the number of flutes along the nail shank;
- D_T is the average thread-crest diameter, in millimetres;
- N is the number of helices along the nail shank;
- L_T is the thread length, in millimetres;
- arctan is the arctangent.

The thread-angle value should be rounded off to the nearest degree.

If any variation in the number of thread flutes is observed within a sample or lot, the thread angle should be computed for each nail having a different number of flutes by inputting the appropriate number of helices for each number of flutes.

The thread angle (α_T) is sometimes expressed as slope (S). The thread slope is the slope of the line formed by the thread relative to the axis of the fastener shank.

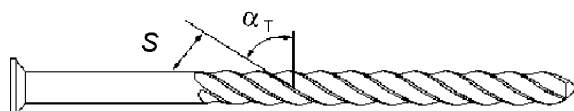

Figure A.12 — Schematic diagram of the thread angle of a helically threaded nail

A.10 Point length

The length of the nail and staple points (L_P), measured along the edge of the point, extends from the top of the point to its bottom end or tip, as shown in Figure A.13. A blunt or dull point has a round point end, in contrast to a sharp point which has a keen point end. The pallet fastener may be pointless as a result of shearing the fastener wire at a right angle to the wire axis during the fastener's manufacture. The pallet-nail and pallet-staple point should not exceed 5 mm.

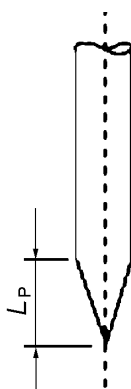

Figure A.13 — Schematic diagram of the point length measurement

NOTE The most common type of point is the diamond point, a symmetrical point having four approximately equal bevelled planes which form a pyramid. For pallet nails and staples, chisel and wedge points are often specified. The chisel point is a point with two major planes forming a "V" and a pair of minor planes on each shank, forming a hexagonal cross-section. In contrast, the wedge point has two convergent planes forming a "V", and the tapered wedge point has two major planes forming a "V" and a single minor plane on each flank forming a rectangular cross-section. Nail points, intended for clinching, have asymmetric points offset to one side of the nail shank. Sometimes these are called offset diamond points. Offset round points also are used on nails intended for clinching. No point nails have a cut end perpendicular to the shank. The staple leg often has a bevel point, that is a point sheared obliquely to the leg axis during the manufacturing process. The bevelled face of the outside-bevel divergent point is to produce an outward clinch or to provide additional penetration, or both, in a thin stapling member. Common fastener points are shown in Figure C.2.

A.11 Nail-head diameter (D_H) and head-rim thickness (T_H)

A.11.1 The head of a pallet nail should be flat or chequered and slightly countersunk. It should be concentric or nearly concentric. The head diameter (D_H) is the maximum distance across the nail head perpendicular to the nail axis. In the case of an oval- or square-shaped head, the head diameter is the maximum measurement, as shown in Figure A.14. They can be measured, using a micrometer, to the nearest 0,025 mm. This permits the determination of the nail-head size by using a metal gauging device with a number of nail holes representative of common nail-head sizes. If the nail head can be pushed through a nail hole of a certain size, the nail-head size is smaller than that representative of the particular hole size; and if the nail head cannot be pushed through a nail hole, the nail-head size

is larger than that representative of the particular hole size. Other gauges have a graduated tapered slot, which permit measuring the nail-head size by moving the head along the slot until the largest head diameter cannot be moved any further. The gauge marks at that location indicate the nail-head size.

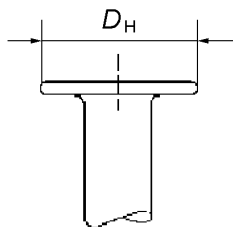
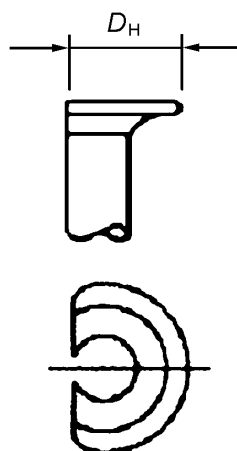

Figure A.14 — Schematic diagram of the nail head diameter measurement

A.11.2 Collated nails often have partial, that is incomplete, notched, or “D” heads with a semicircular rim and a portion of the head omitted during the heading process, to allow tight collating of nails in strips or coils, as shown in Figure A.15. The head-bearing area of partial heads should not be smaller than that of complete heads of same-size nails.



Key

D_H Maximum measurement

Figure A.15 — Schematic diagram of an incomplete or “D” nail head showing diameter measurement

A.11.3 The head-rim thickness is the thickness of the peripheral part of the head, measured parallel to the nail-shank axis, as show in Figure A.16. This is measured, using a micrometer, to the nearest 0,025 mm. The rim should be without any cracks which can result from improper forming of the head during the manufacturing process. The rim thickness should be such as not to result in rim failure during driving of the nail.

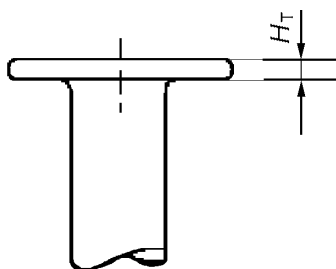

Key

H_T Head rim thickness

Figure A.16 — Schematic diagram of the head-rim thickness measurement

A.11.4 Every nail should have a fillet at the intersection of head and shank, as shown in Figure A.17. This curved intersection should be specified by its radius. For stout as well as long nails to be driven into dense members, the fillet should be larger than that used for a light nail, in order to prevent separation of head and shank during driving of the nail as well as during load transfer from head to shank.

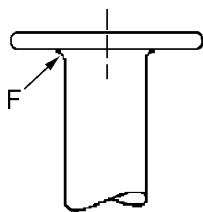

Key

F Fillet

Figure A.17 — Schematic diagram of a fillet between the head and shank of a nail

A.12 Staple-crown width and thickness

A.12.1 The width of the staple crown (W_C) is the distance measured along the crown including the staple legs, as shown in Figure A.18. It is measured to the nearest 0,5 mm.

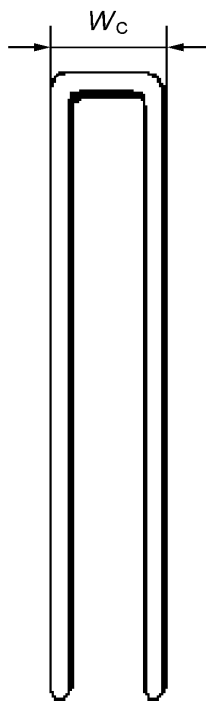

Figure A.18 — Schematic diagram of the staple crown measurement

A.12.2 The thickness of the staple crown is the dimension of the staple crown measured, using a micrometer, to the nearest 0,025 mm, perpendicular to the staple-crown width.

A.13 Shanks

A.13.1 Nail shank

The nail shank is that portion of the nail below the head to the tip of the point, as shown in Figure A.19.

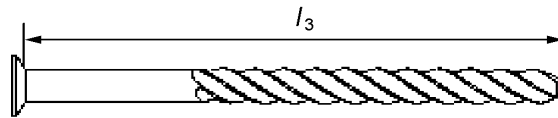

Key

l_3 Nail shank

Figure A.19 — Schematic diagram of the nail shank

A.13.2 Plain shank

The plain shank is the smooth portion of the nail shank under the head, as shown in Figure A.20.



Key

l_2 Plain shank

Figure A.20 — Schematic diagram of the plain shank of a threaded nail

A.13.3 Thread shank

The threaded shank is the threaded portion of the fastener shank, as shown in Figure A.21.

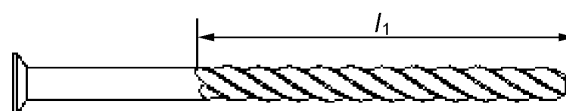

Key

l_1 Threaded shank

Figure A.21 — Schematic diagram of the threaded shank of a helically threaded nail

Annex B (informative)

Correlation between the result of MIBANT impact tests and the third and fourth point static bending tests

The MIBANT impact bend test and the static bend tests are described in ISO 12777-1. The purpose of this correlation is to permit users of this International Standard to estimate the static bending moment at yield point [static bending resistance (SBR)] from the MIBANT angle (α_M). Such estimates can be accomplished graphically from the regression curve (as shown in Figure B.1), or calculated using the regression equation (B.1). The regression analysis is based on least squares best fitting techniques of mean observations. Because of the level of data variation, determining conformance to the criteria in Table 2 of this International Standard should be based on direct measurement of the static bending yield strength according to the third or fourth point methods described in ISO 12777-1.

$$\text{SBR (N}\cdot\text{m)} = 138,72 [\alpha_M \text{ (degrees)}]^{-0,9653} \quad (\text{B.1})$$

Correlation coefficient (R^2) = 0,9679.

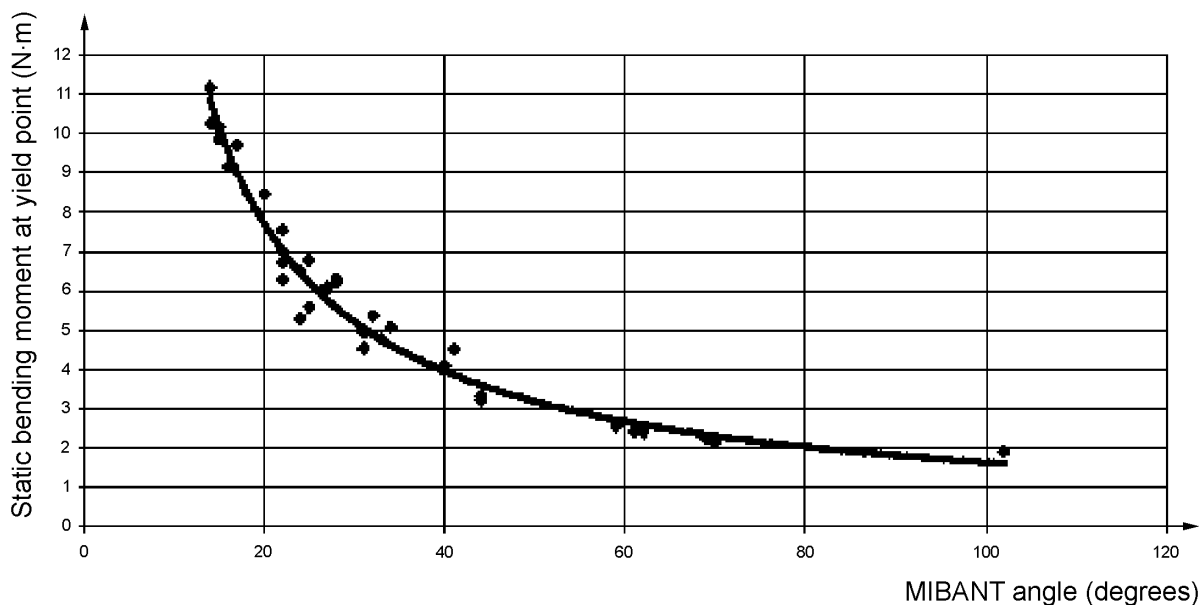

Figure B.1 — Correlation between MIBANT impact bending and static 3rd and 4th point bending tests of pallet fasteners

Annex C
(informative)

Fastener and point types

C.1 Fastener types

Fastener types used in pallet construction are as shown in Figure C.1 and as described in ISO 445.

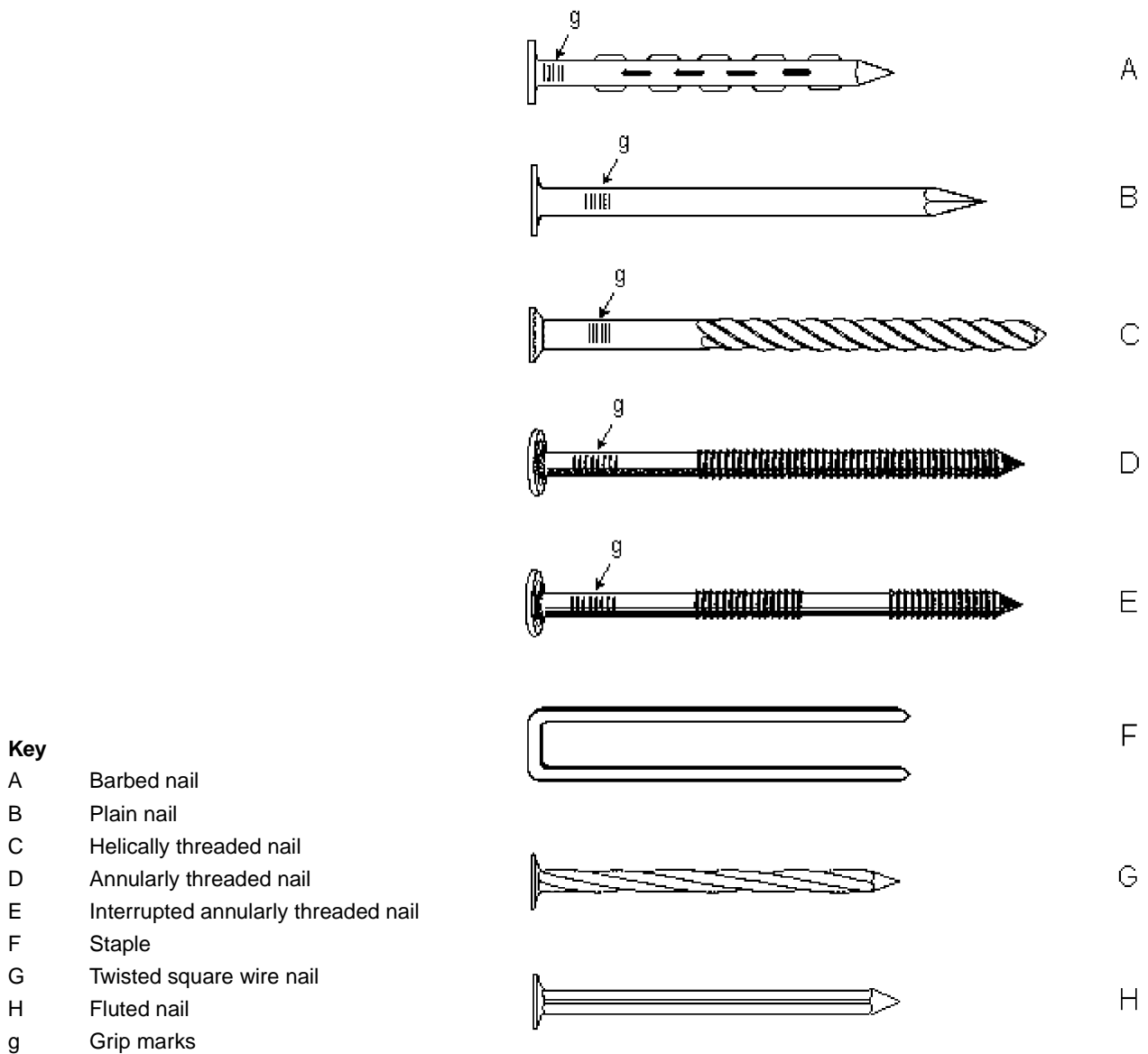

Figure C.1 — Schematic diagram of driven fastener types used in pallet construction

C.2 Point types

Common fastener points are shown in Figure C.2.

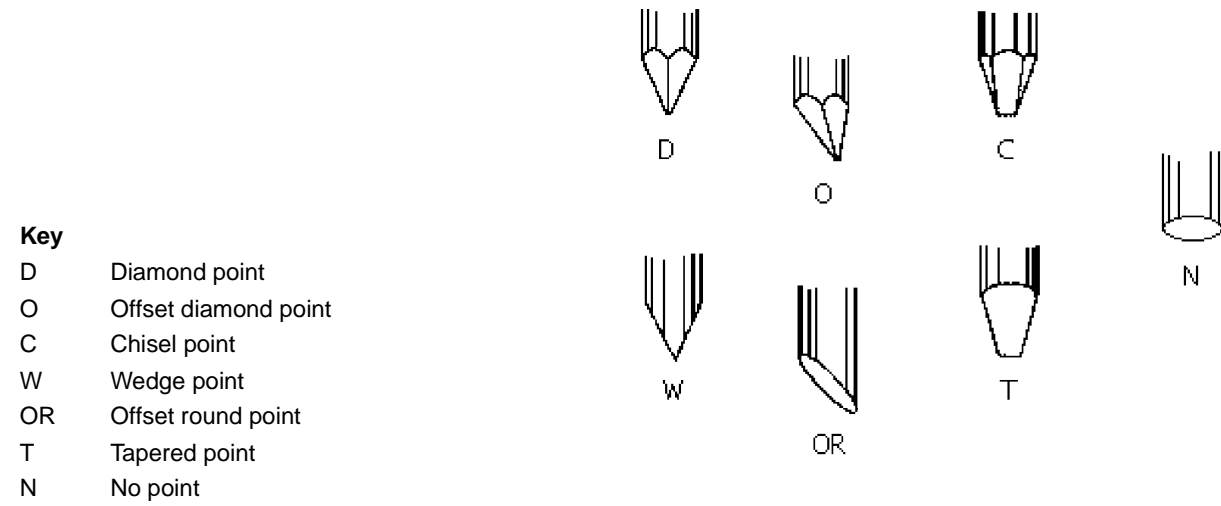

Figure C.2 — Schematic diagram of fastener points

Bibliography

- [1] ISO 12777-3, *Methods of test for pallet joints — Part 3: Determination of strength of pallet joints*
- [2] BEYER G., *Short report on nail testing: Bending strength test methods*, Swedish Institute for Wood Technology, Stockholm, Sweden
- [3] WHITE, M.S. and CLARKE J.W., 1998, *Comparative bending performance of mat fasteners used for block pallet manufacture*, W. H. Sardo Jr., Pallet & Container Research Laboratory, Virginia Tech, Blacksburg, VA 24061-0503, USA

BSI — British Standards Institution

BSI is the independent national body responsible for preparing British Standards. It presents the UK view on standards in Europe and at the international level. It is incorporated by Royal Charter.

Revisions

British Standards are updated by amendment or revision. Users of British Standards should make sure that they possess the latest amendments or editions.

It is the constant aim of BSI to improve the quality of our products and services. We would be grateful if anyone finding an inaccuracy or ambiguity while using this British Standard would inform the Secretary of the technical committee responsible, the identity of which can be found on the inside front cover.
Tel: +44 (0)20 8996 9000. Fax: +44 (0)20 8996 7400.

BSI offers members an individual updating service called PLUS which ensures that subscribers automatically receive the latest editions of standards.

Buying standards

Orders for all BSI, international and foreign standards publications should be addressed to Customer Services. Tel: +44 (0)20 8996 9001.
Fax: +44 (0)20 8996 7001. Email: orders@bsi-global.com. Standards are also available from the BSI website at <http://www.bsi-global.com>.

In response to orders for international standards, it is BSI policy to supply the BSI implementation of those that have been published as British Standards, unless otherwise requested.

Information on standards

BSI provides a wide range of information on national, European and international standards through its Library and its Technical Help to Exporters Service. Various BSI electronic information services are also available which give details on all its products and services. Contact the Information Centre.
Tel: +44 (0)20 8996 7111. Fax: +44 (0)20 8996 7048. Email: info@bsi-global.com.

Subscribing members of BSI are kept up to date with standards developments and receive substantial discounts on the purchase price of standards. For details of these and other benefits contact Membership Administration.
Tel: +44 (0)20 8996 7002. Fax: +44 (0)20 8996 7001.
Email: membership@bsi-global.com.

Information regarding online access to British Standards via British Standards Online can be found at <http://www.bsi-global.com/bsonline>.

Further information about BSI is available on the BSI website at <http://www.bsi-global.com>.

Copyright

Copyright subsists in all BSI publications. BSI also holds the copyright, in the UK, of the publications of the international standardization bodies. Except as permitted under the Copyright, Designs and Patents Act 1988 no extract may be reproduced, stored in a retrieval system or transmitted in any form or by any means – electronic, photocopying, recording or otherwise – without prior written permission from BSI.

This does not preclude the free use, in the course of implementing the standard, of necessary details such as symbols, and size, type or grade designations. If these details are to be used for any other purpose than implementation then the prior written permission of BSI must be obtained.

Details and advice can be obtained from the Copyright & Licensing Manager.
Tel: +44 (0)20 8996 7070. Fax: +44 (0)20 8996 7553.
Email: copyright@bsi-global.com.