

BS ISO 15623:2013



BSI Standards Publication

Intelligent transport systems — Forward vehicle collision warning systems — Performance requirements and test procedures

bsi.

...making excellence a habit.™

National foreword

This British Standard is the UK implementation of ISO 15623:2013.

The UK participation in its preparation was entrusted to Technical Committee EPL/278, Intelligent transport systems.

A list of organizations represented on this committee can be obtained on request to its secretary.

This publication does not purport to include all the necessary provisions of a contract. Users are responsible for its correct application.

© The British Standards Institution 2013. Published by BSI Standards Limited 2013

ISBN 978 0 580 71585 3

ICS 03.220.01; 35.240.60; 43.040.99

Compliance with a British Standard cannot confer immunity from legal obligations.

This British Standard was published under the authority of the Standards Policy and Strategy Committee on 31 August 2013.

Amendments issued since publication

| Date | Text affected |
|------|---------------|
|------|---------------|

INTERNATIONAL
STANDARD

ISO
15623

Second edition
2013-07-15

**Intelligent transport systems —
Forward vehicle collision warning
systems — Performance requirements
and test procedures**

*Systèmes intelligents de transport — Systèmes d'avertissement
de collision frontale du véhicule — Exigences de performance et
modes opératoires*



Reference number
ISO 15623:2013(E)

© ISO 2013



COPYRIGHT PROTECTED DOCUMENT

© ISO 2013

All rights reserved. Unless otherwise specified, no part of this publication may be reproduced or utilized otherwise in any form or by any means, electronic or mechanical, including photocopying, or posting on the internet or an intranet, without prior written permission. Permission can be requested from either ISO at the address below or ISO's member body in the country of the requester.

ISO copyright office
Case postale 56 • CH-1211 Geneva 20
Tel. + 41 22 749 01 11
Fax + 41 22 749 09 47
E-mail copyright@iso.org
Web www.iso.org

Published in Switzerland

Contents

Page

| | |
|---|-----------|
| Foreword | iv |
| Introduction | v |
| 1 Scope | 1 |
| 2 Normative references | 1 |
| 3 Terms and definitions | 1 |
| 4 Symbols and abbreviated terms | 4 |
| 5 Specifications and requirements | 5 |
| 5.1 System functionality..... | 5 |
| 5.2 Necessary functions..... | 5 |
| 5.3 Operating model..... | 5 |
| 5.4 Warning functionality..... | 6 |
| 5.5 Warning elements requirements..... | 7 |
| 5.6 System Classification..... | 9 |
| 5.7 Obstacle vehicle detection area and performance..... | 10 |
| 5.8 FVCWS performance on curves..... | 11 |
| 5.9 User safety requirements..... | 12 |
| 5.10 Human interface requirements..... | 12 |
| 5.11 Awareness of system limitations..... | 13 |
| 6 Evaluation test method for measuring detection performance | 13 |
| 6.1 Test target specification..... | 13 |
| 6.2 Environmental conditions..... | 13 |
| 6.3 Test method for detection zone..... | 13 |
| 6.4 Test method for warning distance range and accuracy..... | 14 |
| 6.5 Test method for target discrimination ability..... | 15 |
| Annex A (informative) Basic consideration of collision warning | 18 |
| Annex B (informative) Obstacle detection along curves | 23 |
| Annex C (informative) Laser radar — Coefficient of test target | 25 |
| Annex D (informative) Radio wave radar test target geometry | 29 |
| Bibliography | 30 |

Foreword

ISO (the International Organization for Standardization) is a worldwide federation of national standards bodies (ISO member bodies). The work of preparing International Standards is normally carried out through ISO technical committees. Each member body interested in a subject for which a technical committee has been established has the right to be represented on that committee. International organizations, governmental and non-governmental, in liaison with ISO, also take part in the work. ISO collaborates closely with the International Electrotechnical Commission (IEC) on all matters of electrotechnical standardization.

The procedures used to develop this document and those intended for its further maintenance are described in the ISO/IEC Directives, Part 1. In particular the different approval criteria needed for the different types of ISO documents should be noted. This document was drafted in accordance with the editorial rules of the ISO/IEC Directives, Part 2. www.iso.org/directives

Attention is drawn to the possibility that some of the elements of this document may be the subject of patent rights. ISO shall not be held responsible for identifying any or all such patent rights. Details of any patent rights identified during the development of the document will be in the Introduction and/or on the ISO list of patent declarations received. www.iso.org/patents

Any trade name used in this document is information given for the convenience of users and does not constitute an endorsement.

The committee responsible for this document is ISO/TC 204, *Intelligent transport systems*.

This second edition cancels and replaces the first edition (15623:2002), which has been technically revised.

Introduction

The main system function of a forward vehicle collision warning system (FVCWS) is to warn the driver when the subject vehicle encounters the situation of a forward vehicle in the subject vehicle's trajectory becoming a potential hazard. This is done by using information such as: (1) the range to forward vehicles, (2) the relative velocity of the forward vehicles with respect to subject vehicle and (3) whether a forward vehicle is in the subject vehicle trajectory. Based upon the information acquired, the controller identified as "FVCWS target selection and warning strategy" in [Figure 1](#) produces the warning to the driver.

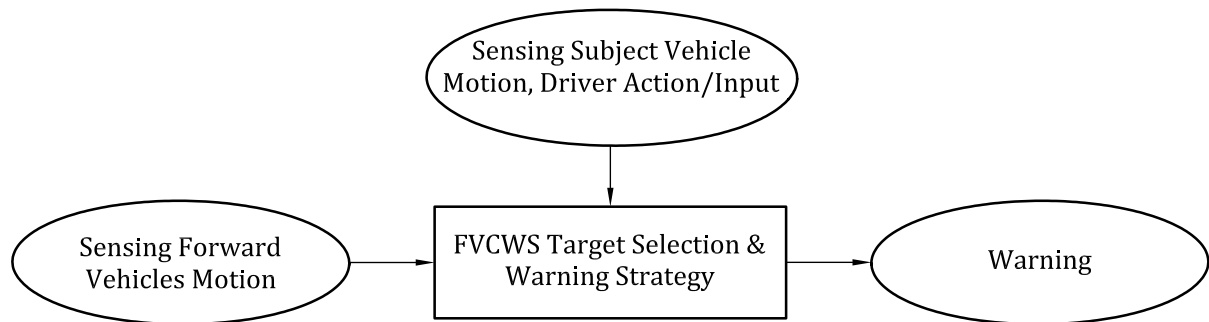

Figure 1 — Functional forward vehicle collision warning system's elements

Automobile manufacturers and component suppliers throughout the world have been vigorously pursuing the development and commercialisation of these FVCWS systems. Systems of this type have already been introduced on to the market in some countries. Thus the standardization efforts began in 1994 amongst interested countries. This International Standard is composed to address only the basic performance requirements and test procedures for the FVCWS type systems. This International Standard may be used as a basis by other standards for systems which have more features and may extend beyond this International Standard.

Intelligent transport systems — Forward vehicle collision warning systems — Performance requirements and test procedures

1 Scope

This International Standard specifies performance requirements and test procedures for systems capable of warning the driver of a potential rear-end collision with other vehicles ahead of the subject vehicle while it is operating at ordinary speed. The FVCWS operate in specified subject vehicle speed range, road curvature range and target vehicle types. This International Standard covers operations on roads with curve radii over 125 m, and motor vehicle including cars, trucks, buses, and motorcycles. Responsibility for the safe operation of the vehicle remains with the driver.

2 Normative references

The following documents, in whole or in part, are normatively referenced in this document and are indispensable for its application. For dated references, only the edition cited applies. For undated references, the latest edition of the referenced document (including any amendments) applies.

IEC 825-1:1993, *Safety of laser products — Part 1: Equipment classification, requirements and user's guide* (includes update of 1994)

3 Terms and definitions

For the purpose of this document, the following terms and definitions apply.

3.1

collision warning

information that the system gives to the driver indicating the need for urgent action to avoid or reduce the severity of a potential rear end collision with another forward vehicle

Note 1 to entry: This warning is issued in the advanced stages of a dangerous situation to warn the driver of the need to perform emergency braking, lane changing or other emergency manoeuvres in order to avoid a collision.

3.2

reflection coefficient of test target

RCTT

optical radar reflectivity of the target, which is defined as the radiated intensity towards the receiver ($I_{ref} - W/sr$) measured at target level, immediately after the reflection; divided by the intensity of irradiation received from the transmitter ($E_t - W/m^2$) measured at target level, immediately before the reflection

Note 1 to entry: The units for RCTT value are in m^2/sr (see [Annex C](#)).

3.3

forward vehicle

vehicle in front of and moving in the same direction and travelling on the same roadway as the subject vehicle

3.4

forward vehicle collision warning system

FVCWS

system capable of warning the driver of a potential collision with another forward vehicle in the forward path of the subject vehicle

3.5 obstacle vehicles

vehicles, both moving and stationary, considered potential hazards that can be detected by this system

EXAMPLE Motor vehicles only, that is cars, trucks, buses, and motorcycles.

3.6 preliminary collision warning

information that the system gives to the driver in the early stages of a potentially dangerous situation that may result in a rear end collision.

Note 1 to entry: The system may provide this warning prior to the collision warning.

3.7 radar cross section RCS

measure of the reflective strength of a radar target measured in square meters, and defined as 4π times the ratio of the power per unit solid angle scattered in a specified direction to the power per unit area in a radio wave incident on the scatterer from a specified direction

3.8 visibility

distance which the illuminance of a non-diffusive beam of white light with the colour temperature of 2700 K is decreased to 5 % of its original light source illuminance

3.9 adaptive Cruise Control ACC

enhancement to conventional cruise control systems which allows the subject vehicle to follow a forward vehicle at an appropriate distance by controlling the engine and/or power train and optionally the brake

Note 1 to entry: See ISO 15622.

3.10 adjacent lane

lane of travel sharing one lane boundary with the lane in which the subject vehicle is traveling and having the same direction of travel as the subject vehicle lane

3.11 clearance

$x_c(t)$
distance $x_c(t)$ from the target vehicle trailing surface to the subject vehicle leading surface

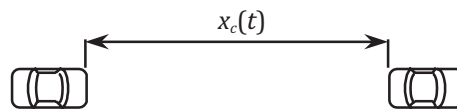

3.12 cut-in vehicle

forward adjacent vehicle that has a lateral component of motion towards the path of the subject vehicle

3.13 jerk

third derivative with respect to time of the position of an object; equivalently the rate of change of the acceleration of an object; considered a measure of harshness of vehicle motion

3.14 minimum velocity

V_{\min}
minimum subject vehicle (SV) speed for which the FVCWS must be capable of initiating a warning

3.15

rear-end collision

forward vehicle collision in which the front of the subject vehicle strikes the rear of the forward vehicle

3.16

relative velocity

$v_r(t)$

difference between the longitudinal velocities of the subject vehicle (SV) and the target vehicle (TV), $v_r(t)$, given by the equation; equivalently the rate of change with respect to time of the distance between the two vehicles. A positive value of relative velocity indicates that the target vehicle is moving faster than the subject vehicle, and that the distance between them is increasing with time

$$v_r(t) = v_{TV}(t) - v_{SV}(t)$$

3.17

required deceleration

A_{req}

minimum deceleration that, if constant, would enable the subject vehicle to match the velocity of the target vehicle without contacting the target vehicle and thus prevent a collision:

$$A_{req}(t) = A_{TV} + \frac{(V_r(t))^2}{2 * (x_c(t) - x_r(t))}$$

Note 1 to entry: $x_r(t)$ is the amount of reduction in the clearance distance due to reaction time.

3.18

subject vehicle

SV

vehicle equipped with FVCWS as defined herein

3.19

target vehicle

TV

forward vehicle that is closest in the forward path of the subject vehicle; forward vehicle that the FVCWS operates on

3.20

time to collision

TTC

estimated time that it will take a subject vehicle to collide with the target vehicle assuming the current relative speed remains constant, as given in the following equation:

$$TTC = -\frac{x_c(t)}{v_r(t)}$$

3.21

enhanced time to collision

ETTC

time that it will take a subject vehicle to collide with the target vehicle assuming the relative acceleration between the subject vehicle (SV) and target vehicle (TV) remains constant, as given in the following equation:

$$ETTC = \frac{\left[-(v_{TV} - v_{SV}) - \sqrt{(v_{TV} - v_{SV})^2 - 2 * (a_{TV} - a_{SV}) * x_c} \right]}{(a_{TV} - a_{SV})}$$

3.22

warning braking

action in which FVCWS respond to detection of a possible rear-end collision by automatically applying the brake for a short period of time to provide a warning to the driver

3.23

FVCWS warning modalities

means used to convey the different type of FVCWS warnings to the driver.

EXAMPLE Visual, auditory, and/or haptic cues.

3.24

lateral offset

lateral distance between the longitudinal centerlines of a subject vehicle (SV) and a target vehicle (TV), measured as a percentage of the width of the SV, such that if the centers of the two vehicles are aligned, the value is zero



4 Symbols and abbreviated terms

| | |
|----------------------------|--|
| $a_{\text{lateral_max}}$ | maximum allowed lateral acceleration in curves |
| a_{min} | minimum deceleration of the subject vehicle's emergency braking |
| d_0 | minimum detectable distance without distance measuring capability |
| d_1 | minimum detectable distance with distance measuring capability |
| d_2 | minimum detection distance for a cut-in vehicle |
| d_{max} | maximum detectable distance |
| h | upper detection height from ground |
| h_1 | lower detection height from ground |
| RCTT | reflection coefficient for test target for infrared reflector |
| T_{max} | maximum driver's brake reaction time after the warning |
| T_{min} | minimum driver's brake reaction time after the warning |
| Tresp | driver brake reaction time |
| Tb | braking system response time |
| RCS | radar cross section |
| $V_{\text{circle_start}}$ | speed of the test vehicles at the start of the test |
| V_{max} | maximum vehicle speed at which the system is capable of operating |
| V_{min} | minimum vehicle speed at which the system is capable of operating |
| $V_{\text{rel_max}}$ | maximum relative vehicle speed at which the system is capable of operating |
| W_L | lane width |
| W_V | subject vehicle width |

5 Specifications and requirements

5.1 System functionality

The purpose of the FVCWS is to provide warnings that will assist drivers in avoiding or reducing the severity of rear end crashes. These warnings should be provided in time to help drivers avoid most common rear end crashes by applying the brakes only. The timing of the alerts should be selected such that they strive to provide alerts early enough to help the driver avoid the crash or mitigate the harm caused by the crash without introducing other alerts perceived as nuisance or false. FVCWS provide warning only and do not perform vehicle control to mitigate the crash.

FVCWS may operate differently when the subject vehicle is applying an automatic braking commanded by other system in the vehicle such as full speed range ACC. In this situation, the FVCWS could take into account the capability of the automatic braking system. The fact that the vehicle is under sustained automatic braking may affect the warning criteria and warning modality.

5.2 Necessary functions

Vehicles equipped with FVCWS shall be equipped to fulfil the following functions.

- Detect the presence of forward vehicles,
- Determine measure or measures for relative position and position dynamic of the detected forward vehicles with respect to the subject vehicle,
- Determine the subject vehicle velocity,
- Estimate the path of the subject vehicle (Class II and III),
- Provide driver warnings in accordance with the FVCWS function and requirements.

5.3 Operating model

[Figure 2](#) shows the state transition diagram for the FVCWS.

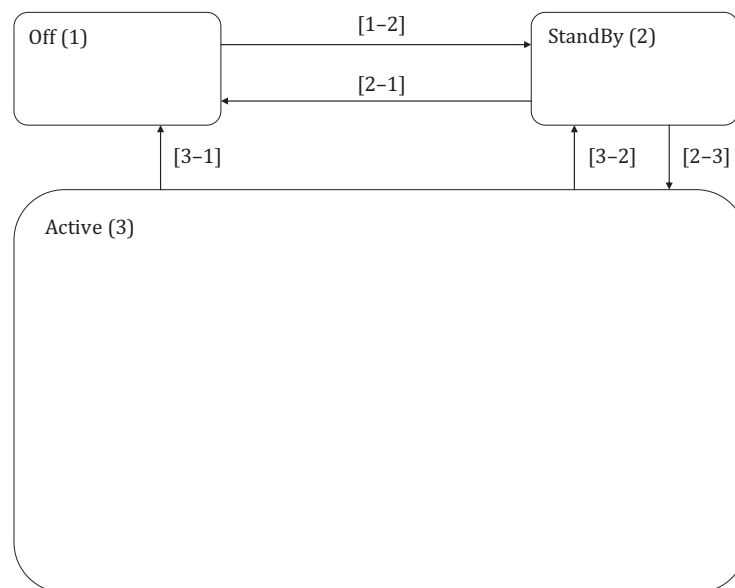

Figure 2 — FVCWS State Transition Diagram

Key

- [1-2] engine running, or engine running and on switch (if on switch exists)
- [2-1] ignition off or off switch or fault condition
- [3-1] ignition off or off switch or fault condition
- [2-3] $V_{\min} < \text{speed} < = V_{\max}$ and gear is not in reverse or park positions
- [3-2] ($V_{\min} > \text{speed}$) or ($\text{speed} > V_{\max}$) or gear is in reverse or park positions

5.3.1 State functional descriptions

The FVCWS state descriptions address the functional contents of FVCWS, identifying what functions are performed in each state. Descriptions that correspond to a functional requirement are presented in bold text.

5.3.1.1 FVCWS off (1)

No warning is performed in the FVCWS off state. It is optional to provide a driver-selected means of placing FVCWS in this state, other than the Ignition key (for example: on/off Switch). **Upon turning the ignition to the off position, the FVCWS transitions to the FVCWS off state. Whenever the Self-Test function determines that the FVCWS is not able to deliver adequate performance, a fault condition is set and FVCWS transitions to the FVCWS off state.**

5.3.1.2 FVCWS standby (2)

No warning is performed in the FVCWS standby state. **In this state, FVCWS monitors the vehicle speed and the gear position. If the vehicle speed comes within the FVCWS operating range and the gear select is in forward position (all gear positions except reverse and park), the system transitions from the standby state to the active state. FVCWS enters the FVCWS standby state from the FVCWS off state if the ignition cycle has been completed and the engine is running, or if the engine is running and the optional on/off switch is the "on" position. FVCWS enters this state from the active state if the conditions for activating are not met: if the vehicle speed value is outside the FVCWS operation range (hysteresis delta is added), reverse gear is selected, or park is selected.**

5.3.1.3 FVCWS active (3)

The warning is performed in this state whenever the warning conditions are met. **FVCWS enters this state if gear select is in any forward position and the vehicle speed value is in the FVCWS operation range.**

5.3.2 Operational limits

The value of V_{\min} shall be at most 11,2 m/s. The value of V_{\max} shall be at least the minimum of 27,8 m/s and the maximum vehicle operating speed. The value for $V_{\text{rel_min}}$ shall be at most 4,2 m/s. The value of $V_{\text{rel_max}}$ shall be at least 20 m/s.

5.4 Warning functionality

Forward vehicle collision warning systems shall provide warnings for moving (including "has been detected as moving by the sensor and now stopped") obstacle vehicles. Providing warnings for stationary obstacle vehicles (has never been detected moving at an absolute speed above 4,2 m/s) is optional. The FVCWS warning is provided in accordance with the following functions.

5.4.1 Monitoring distance and relative speed between obstacle vehicle and subject vehicle

A forward obstacle vehicle is sensed by obstacle detecting devices such as optical (laser) radar, radio wave radar, or image processing systems.

5.4.2 Judging the timing of collision

One possible way to judge the timing of a potential collision is by the results of evaluating the subject vehicle speed, the distance to the obstacle vehicle, the relative speed between the subject vehicle and the obstacle vehicle, and potentially the deceleration of the subject and the obstacle vehicles. When the system detects multiple vehicles at the same time, it shall select the one in the subject vehicle expected trajectory that the subject vehicle may collide with first if no action is taken as the obstacle vehicle.

5.4.3 Preliminary collision warning and Collision warning (see [Annex A](#))

Forward vehicle collision warning systems shall provide a collision warning to the driver. A preliminary collision warning is optional. The purpose of the preliminary collision warning is to inform the driver of the presence of a potential forward collision hazard. In this case the driver should prepare to take the necessary action to avoid a potential rear end collision. Even though the system is intended to provide this warning prior to the collision warning, it is possible that rapidly changing conditions can occur which result in the collision warning being issued without a preceding preliminary collision warning. The purpose of the collision warning is to inform the driver of the need to take action in order to avoid or reduce the severity of a possible imminent rear end collision.

Warnings consist of independent or combined use of visual, audible and/or tactile senses. However in the case of a collision warning, a visual warning, as well as audible and/or tactile warning shall be provided to the driver.

Warnings are issued depending on the relative speed between the subject vehicle and the obstacle vehicle, the subject vehicle speed, the inter-vehicle distance, the free running (driver's brake reaction) time, and potentially the deceleration of the subject and the obstacle vehicles.

When the subject vehicle is approaching an obstacle vehicle, the warning distance should be decided according to criteria with respect to required deceleration threshold values or their equivalents if other warning triggering methods are used.

5.5 Warning elements requirements

5.5.1 FVCWS output

FVCWS shall provide a collision warning to the driver. A preliminary collision warning is optional.

5.5.2 Warning modality

5.5.2.1 FVCWS collision warning shall contain a visual warning, as well as an audible and/or haptic.

5.5.2.2 FVCWS preliminary collision warning shall contain visual or audible or a combination of visual and audible modalities. Supplemental haptic modalities are optional for preliminary collision warning.

5.5.2.3 It is recommended that warning braking modality not be used for collision warning if the subject vehicle driver is applying the brakes.

5.5.2.4 The warning braking modality may be used for collision warning and preliminary collision warning when automatic braking is applied in the subject vehicle (i.e. when automatic braking action is underway).

5.5.2.5 Warning braking shall be applied for a duration that is less than 1 s. It shall result in a deceleration less than 0,5 g, and a maximum speed reduction of 2 m/s. To ensure the effectiveness of the warning braking, a minimum average deceleration of 0,1 g for a minimum duration of 100 ms shall be fulfilled.

5.5.2.6 Audible warning tone should be selected such that it can be easily heard and discriminated from warnings unrelated to forward direction threats (e.g. lateral threat warnings).

5.5.2.7 An actuation of seat-belt pretensioner may be used for FVCWS collision warning.

5.5.3 Required deceleration threshold

5.5.3.1 FVCWS shall issue a collision warning when the required deceleration exceeds a threshold value of A_{req} . The threshold value A_{req} shall not be greater than 0,68 g (considering the response time values in 5.5.4) in dry road and warm weather conditions.

5.5.3.2 FVCWS that provide a warning timing adjustment for the driver must have at least one setting that satisfies the required deceleration threshold value A_{req} requirement in [5.5.3.1](#).

5.5.3.3 FVCWS may issue a preliminary collision warning at a lower required deceleration threshold.

5.5.3.4 The required deceleration threshold for collision and preliminary warnings may be adapted based on the detected road condition, environmental and driver state conditions, driver behaviour and different driving scenarios.

5.5.3.5 In case when automatic braking is applied in the subject vehicle, it is optional to modify A_{req} such that its value exceeds the maximum deceleration capability of the active automatic braking system (for example: ACC system).

5.5.4 Response times

5.5.4.1 The driver reaction time to the warning (driver brake reaction time (T_{resp})) shall be incorporated in the calculation of the warning range. The T_{resp} value shall not be less than 0,8 s.

5.5.4.2 FVCWS that provide a warning timing adjustment for the driver must have a least one setting that satisfies the T_{resp} requirement in [5.5.4.1](#).

5.5.4.3 The braking system response time (T_b) may be incorporated in the calculation of the required deceleration. The selection of the braking system response time value is left to the FVCWS designer.

5.5.4.4 The driver brake reaction time (T_{resp}) and the braking system response time (T_b) may be set to zero if the subject vehicle driver is applying the brakes.

5.5.4.5 In case when automatic braking is applied in the subject vehicle, the driver reaction time to the warning [driver brake reaction time (T_{resp})] may be set to zero in the calculation of the required deceleration.

5.5.5 No Warning requirements

Subclause [5.5.5.1](#) states the condition when the FVCWS must not issue any type of warnings. Subclauses [5.5.5.2](#) to [5.5.5.7](#) provide examples when the FVCWS warning may be suppressed or delayed.

5.5.5.1 The FVCWS shall not issue any type of warnings if the subject vehicle deceleration is greater than or equal to the required deceleration threshold.

5.5.5.2 The FVCWS should not issue any type of warnings for a forward vehicle that is not in the lane of the subject vehicle on roads with radius of curvature defined for each class in [Table 1](#).

- 5.5.5.3** It is recommended that the FVCWS does not issue any type of warnings for a faster forward vehicle that cuts in front of the subject vehicle.
- 5.5.5.4** The FVCWS warning may be suppressed or delayed if the subject vehicle driver is applying the brakes.
- 5.5.5.5** The FVCWS warning may be suppressed or delayed if the TTC is greater than 4,0 s.
- 5.5.5.6** The FVCWS warning may be suppressed or delayed if the subject vehicle is detected to be performing a lane change or high dynamic manoeuvring, or if a throttle override (subject vehicle driver is overriding the automatic braking by applying throttle) is detected, or if an ACC maximum braking warning is active.
- 5.5.5.7** The FVCWS warning may be suppressed or delayed if the forward collision is avoidable by normal steering manoeuvre using an average lateral acceleration value less than or equal to 3,5 m/s².
- 5.5.5.8** The FVCWS warning may be suppressed or delayed if the situation is beyond the operational limits as defined in [5.3.2](#).

5.5.6 Warning distance range calculation example

The calculation of the minimum required distance can be performed based on the $T_{resp} = 0,8$ s and $A_{req} = 6,67$ m/s². Using the definition of A_{req} in [3.17](#),

$$Xc_min_Warning = \frac{v_r^2}{2 \times (6,67 - A_{TV})} + 0,8 \cdot v_r$$

5.5.7 Equivalent warning triggering point

For other systems that use different warning triggering methods (e.g. TTC or ETTC), the warning triggering time shall meet the requirements [5.5.3](#), [5.5.4](#) and [5.5.5](#).

5.6 System Classification

Systems are classified according to curve radius capability as shown in [Table 1](#).

Table 1 — System classifications

| Class | Horizontal curve radius capability |
|-------|---|
| I | curve radius greater than or equal to 500 m |
| II | curve radius greater than or equal to 250 m |
| III | curve radius greater than or equal to 125 m |

- Class I systems shall have the capability to detect forward obstacle vehicles in the subject vehicle's trajectory along curves of radii down to 500 m.
- Class II systems shall have the capability to detect forward obstacle vehicles in the subject vehicle's trajectory along curves of radii down to 250 m.
- Class III systems shall have the capability to detect forward obstacle vehicles in the subject vehicle's trajectory along curves of radii down to 125 m.

5.7 Obstacle vehicle detection area and performance

5.7.1 Obstacle vehicle detection area

5.7.1.1 Minimum detection area (Class I, II and III)

The minimum detection area of the FVCWS obstacle detection sensor is illustrated in [Figure 3](#).

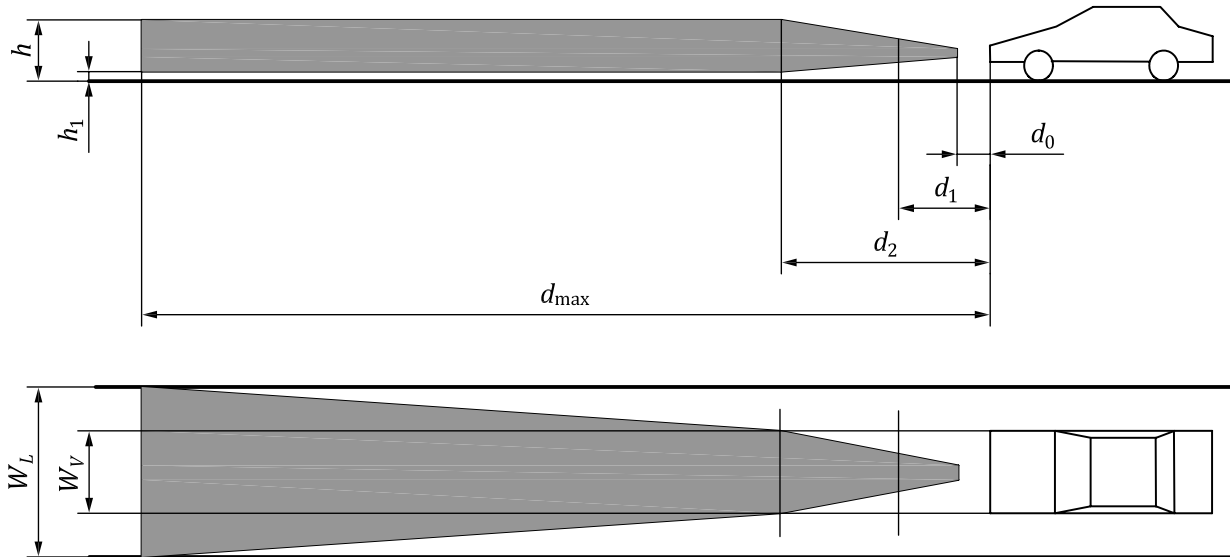

Figure 3 — Detection area

5.7.1.1.1 Detection range

Table 2 — Detection range requirements

| Distance | Formula or value | Meaning |
|-----------|---|---|
| d_{max} | $V_{rel_max} \times T_{max} + V_{rel_max}^2 / 2a_{min}$ | The maximum detectable distance. |
| d_2 | Less than or equal to 10 m for Class I Less than or equal to 7,5 m for Class II Less than or equal to 5 m for Class III | The minimum detection distance for a forward vehicle with a lateral offset of less than 20 %. |
| d_1 | $T_{min} \times V_{min}$ | The system's minimum distance with distance measuring capability. |
| d_0 | Less than or equal to 2 m | The minimum detectable distance without distance measuring capability. |

where

V_{max_rel} is the maximum relative speed at which the system is capable of operating (m/s);

V_{min} is the minimum vehicle speed at which the system is capable of operating (m/s);

T_{max} is the maximum driver's brake reaction time after the warning (s);

T_{min} is the minimum driver's brake reaction time after the warning (s);

a_{min} is the minimum deceleration of the subject vehicle's emergency braking (m/s²).

V_{\max_rel} , V_{\min} , T_{\max} , T_{\min} and a_{\min} are design parameters of the system, which will be decided by the vehicle manufacturer. [Annex A](#) gives indications about typical values for some of these parameters. The selected detection range shall satisfy the warning requirements in [5.5.3](#) and [5.5.4](#).

5.7.1.1.2 Detection width and detection height

Table 3 — Detection width and detection height requirements

| Distance | Minimum detection width | Minimum detection height |
|------------|--------------------------------------|---|
| d_{\max} | W_L (lane width) meters | h_1 (lower detection height from ground) = 0,2 m and h (upper detection height from ground) = 1,1 m |
| d_2 | W_V (subject vehicle width) meters | h_1 (lower detection height from ground) = 0,2 m and h (upper detection height from ground) = 1,1 m |
| d_1 | not specified | not specified |
| d_0 | not specified | not specified |

5.7.1.2 Detection range for horizontal curve radius

The width of the detection range for horizontal curve radius shall be extended in relation to the curve's radius (see [Annex B](#)).

5.7.2 Warning distance accuracy

The non-adaptive systems should produce the warning at a nominal range with a tolerance of max. (± 2 m or ± 15 %). The recurrent tests for this requirement should be executed with the same initial test conditions in order to prevent possible deviations in the system performance. Adaptive systems performance may not meet this requirement due to their nature. Adaptive system is a system in which its warning time is a function of different parameters, for example the detected road condition, environmental and driver state conditions, driver behaviour and different driving scenarios.

5.7.3 Target discrimination ability

5.7.3.1 Longitudinal discrimination

If there are two or more forward vehicles in the detection range from a distance d_1 to d_{\max} from the subject vehicle's front end, the system shall select the vehicle that is closest to the subject vehicle and in the subject vehicle's trajectory as the target vehicle that the FVCWS will operate on.

5.7.3.2 Lateral discrimination

If there are two or more forward vehicles in the subject vehicle's trajectory or in an adjacent position, the system shall select the vehicle in the subject vehicle's trajectory as the target vehicle that the FVCWS will operate on.

5.7.3.3 Overhead discrimination

If there are overhead objects at a height greater than 4,5 m above the roadway such as overhead sign, etc., the system shall not select any of these objects as the target vehicle.

5.8 FVCWS performance on curves

FVCWS shall be able to warn on in-path obstacle vehicles that exist in straight roads and curves with radius of curvature greater than or equal to 500 m for Class I, greater than or equal to 250 m for Class II and greater than or equal to 125 m for Class III.

5.9 User safety requirements

5.9.1 Optical radar

Shall satisfy the requirements for Class I lasers as defined in IEC 825-1.

5.9.2 Radio wave radar

The specification shall be based on the International Standard which may be established by radio wave radar experts in the future.

5.10 Human interface requirements

5.10.1 Warning output specification

All visual, audible, and haptic warnings shall be perceptible by the driver. It is recommended that the visual and audible warning satisfy appropriate human factors as shown in [Table 4](#). The content in [Table 4](#) is an example. The warning modality requirements for both collision and preliminary warnings are shown in [5.5.2](#).

Table 4 — Warning characteristics

| Warning | Visual warning | Auditory warning |
|-------------------------------|---|--|
| Collision warning | Colour: red Position: main glance direction Luminance: luminance enough in day light, not glaring in the night Interval: intermittent at short interval is recommended | pressure: sound pressure should be at the same level or higher of those of all auditory warnings present in the vehicle conveying more urgency than other auditory warnings tone: can be easily heard and discriminated from any other unrelated warnings in the vehicle interval: intermittent at short interval is recommended |
| Preliminary collision warning | Colour: yellow or amber Luminance: luminous enough in daylight, not glaring in the night Interval: continuous or intermittent at long interval | pressure: sound pressure overriding background noise tone: not annoying tone interval: continuous sound or intermittent at long interval or single sound |

5.10.2 Interference with other warnings

Even when a vehicle is equipped with a forward vehicle collision warning system along with other warning systems such as those for rear or side obstacles, the warning should be clearly distinguishable to the driver relative to other unrelated warnings.

5.10.3 Operational status display

Indications such as those below, which clearly identify the system's operational status shall be provided.

5.10.3.1 System in-operation indication

An indication which informs the driver that the system is operational may be provided (e.g. an illuminated power switch).

5.10.3.2 Fault indication

An indication which informs the driver of a system failure shall be provided (e.g. a fault indication on the display panel).

5.11 Awareness of system limitations

System users should be made aware of the system limitations as follows using appropriate means such as owner's manual and/or caution label.

For example warnings for head-on collision, crossing-path collision, operations beyond the sensor limit (including short radius curve, etc.), and the maximum velocity (V_{\max}) has been reached are not available with this system.

6 Evaluation test method for measuring detection performance

6.1 Test target specification

6.1.1 Optical radar

The test target is defined as possessing the physical size, shape, and surface profile of a representative motorcycle and with a reflection coefficient for test target (RCTT) which represents the reflectivity of motorcycles

6.1.2 Radio wave radar

The test target is defined by a radar cross section (RCS) that is representative of motorcycles.

NOTE In actual use, the measurement range of automotive obstacle vehicle detection sensors is comparatively short, it is difficult to achieve a plane wave on the scatterer. Therefore RCS values for the automotive use are defined by measured values in the actual using range for the sake of convenience.

Examples of possible test target geometry are discussed in the [Annex D](#).

6.1.3 Passive optical sensor

The test target is defined as possessing the physical size, shape, and surface profile of a representative motorcycles or passenger vehicle.

6.2 Environmental conditions

- Test location shall be on a flat, dry asphalt or concrete surface.
- Temperature range shall be $-20\text{ }^{\circ}\text{C}$ to $40\text{ }^{\circ}\text{C}$.
- Horizontal visibility shall be greater than 1 km.
- Test may occur during daylight conditions.

6.3 Test method for detection zone

The most realistic test for detection area is a dynamic test, however, a static test is available as an option also. The test shall be done as follows. The system shall detect a test target positioned at an arbitrary distance between d_0 and d_1 as shown in [Figure 4](#).

The system shall detect a test target positioned at an arbitrary distance between d_1 and d_2 as shown in [Figure 4](#). The system shall detect test targets positioned in turn at both distance d_2 and d_{\max} as shown in [Figure 4](#).

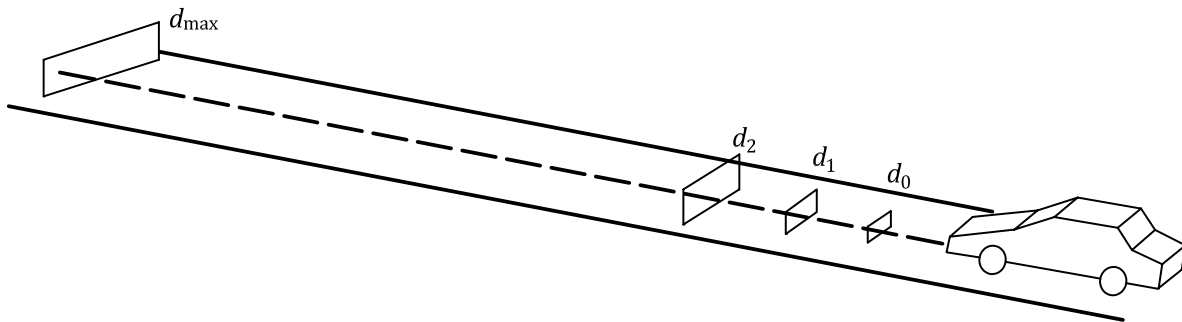

Figure 4 — Detection range

If detection cannot be validated without special measurement equipment, such as when a sensor and ECU are tightly integrated, the manufacturer may conduct this test using special measurement equipment and provide test results for inspection. Additionally, as this test allows for a dynamic test, it may be conducted simultaneously with another test in [Clause 6](#) such that the intent of this test method is fulfilled in the execution of another test. For example, a test vehicle meeting the previously defined test target specifications may be used as a test target. Successful initiation of a collision warning at the various distances defined in this test may be considered successful detection.

6.4 Test method for warning distance range and accuracy

6.4.1 Warning distance range test

The target and the subject vehicle are moving on the same lane on a straight road. The target vehicle is moving at a speed 8 ± 1 m/s. The subject vehicle is moving at a speed 20 ± 2 m/s. The measured warning distance shall be greater than or equal to distance calculated in [5.5.6](#).

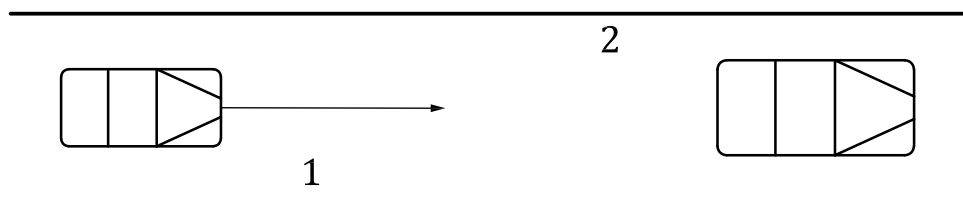

Key

- 1 SV traveling at 20 ± 2 m/s
- 2 TV traveling at 8 ± 1 m/s

Figure 5 — Warning distance range test

6.4.2 Warning distance accuracy test

This test shall be done with vehicles in motion.

The standard target shall be in the detection area. While the subject vehicle is driving towards the standard target at the speed $V = 20$ m/s the warning distance shall be measured by following procedure.

Two timings shall be measured. The first timing, t_0 is at the point where the subject vehicle to the standard target is equal to d . The second timing t_1 is at the point where the warning is issued. The warning distance from the standard target is calculated as $D = d - V \times (t_1 - t_0)$. The D is compared to the warning distance specified by manufacturer. The warning distance accuracy shall meet [5.7.2](#) in 70 % of the repeated tests. The number of repeated tests should be greater than or equal to 7 tests.

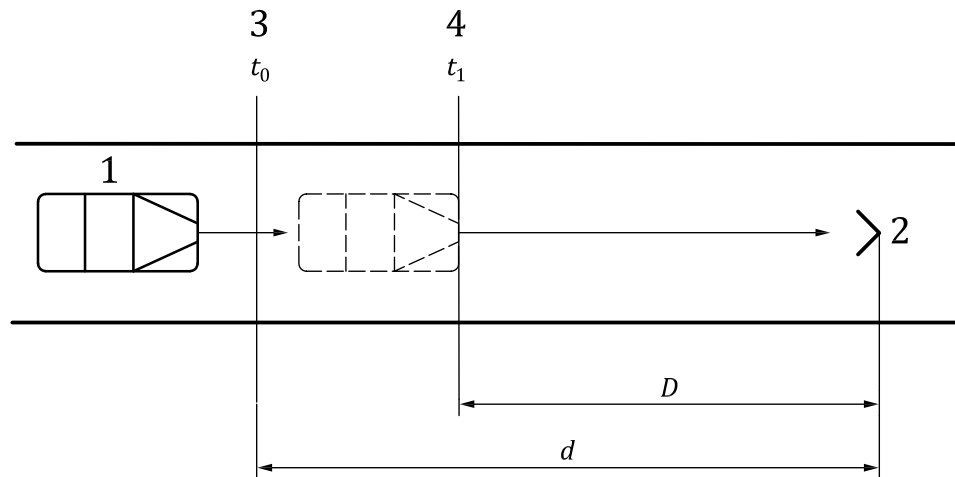

Key

- 1 subject vehicle
- 2 standard target
- 3 standard timing
- 4 warning timing

Figure 6 — Warning distance accuracy test

6.5 Test method for target discrimination ability

This test shall be done with vehicles in motion. The tests in this clause are finished when the vehicle has ‘produced a warning’. Tests should also show the ability to avoid nuisance warnings. For example test conditions which are finished when the manoeuvre is complete and no warning has been produced.

6.5.1 Longitudinal discrimination

Two target vehicles in the detection area are driving with the same speed which is 20 m/s. The subject vehicle is following the two target vehicles at speed = 20 m/s. The time gap between the two target vehicles shall be T_{\min} ($= 0,6 \pm 0,1$ s) and the two target vehicles are positioned along a line in such a way that the near target vehicle does not mask the far target vehicle. The time gap between the subject vehicle and the near target vehicle may be over $T_{\max.}$ ($= 1,5$ s). The subject vehicle accelerates until the system produces a collision warning. After that, the subject vehicle decelerates until the same time gap ($> 1,5$ s) is reached, and then follows the target vehicles with the same speed again. Next, after a few seconds only the near target vehicle decelerates to a speed which is low enough to have the subject vehicle produce the collision warning. The test is finished, when the subject vehicle has produced a warning.

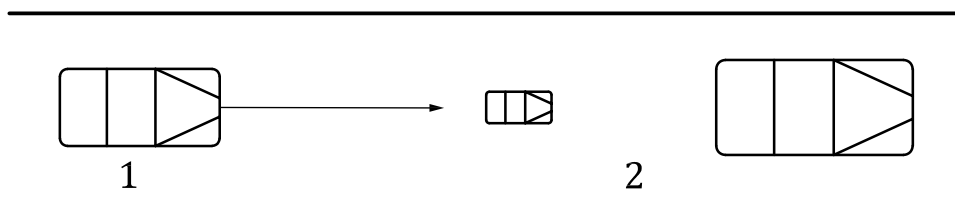

Key

- 1 subject vehicle
- 2 target vehicles

Figure 7 — Longitudinal target discrimination ability test

6.5.2 Lateral discrimination

6.5.2.1 Straight road lateral discrimination test

The test shall be performed dynamically. Subject vehicle and target vehicle are driving with the same speed, which is 20 m/s, and in a time gap which should be $T_{max.} (= 1,5 \text{ s})$. The forward vehicle drives beside the target vehicle at a same speed of 20 m/s. The spacing between the longitudinal centrelines of the preceding vehicles is $3,5 \text{ m} \pm 0,25 \text{ m}$. The width of the preceding vehicles shall be between 1,4 m and 2,0 m. The lateral displacement of the longitudinal centreline of the subject vehicle relative to the longitudinal centreline of the target vehicle shall be less than 0,5 m. After a few seconds the forward vehicle decelerates to a speed which is significantly lower than the speed of the subject and target vehicle. During passing of the forward vehicle, the subject vehicle shall not produce a warning. Next, after a few seconds the target vehicle decelerates to a speed which is low enough to have the subject vehicle produce the collision warning. The test is finished, when the subject vehicle has produced a warning.

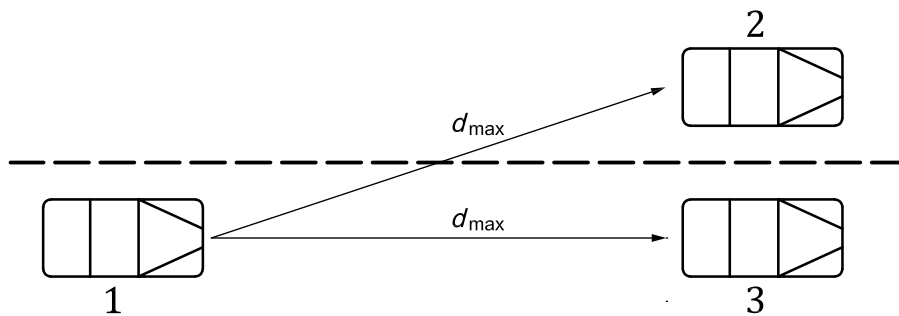

Key

- 1 subject vehicle
- 2 forward vehicle
- 3 target vehicle

Figure 8 — Straight road lateral target discrimination ability test

6.5.2.2 Curved road lateral target discrimination test

In addition to the straight road test, the following test shall be done on a circle or a sufficient part of a circle with a radius of 500 m or less in case of Class I, with a radius of 250 m or less in case of Class II, and with a radius of 125 m or less in case of Class III. The test shall be performed dynamically. Subject vehicle and target vehicle are driving in the same lane with the same speed and in a headway which does not cause a warning. The speed of the test vehicles at the start of the test is as follows.

$$V_{\text{circle_start}} = \min((a_{\text{lateral_max}} \times R)^{1/2}, V_{\text{max}}) \pm 1 \text{ m/s} \quad (1)$$

where

- $a_{\text{lateral_max}}$ 2,0 m/s² for Class I;
- $a_{\text{lateral_max}}$ 2,3 m/s² for Class II and III.

The forward vehicle drives beside the target vehicle in the outer lane. After a few seconds the forward vehicle decelerates to a speed which is significant lower than the speed of the subject and target vehicle. During passing of the forward vehicle, the subject vehicle shall not produce a warning. Next, after a few seconds the target vehicle decelerates to a speed which is low enough to have the subject vehicle produce the preliminary collision warning. The test is finished, when the subject vehicle has produced a warning.

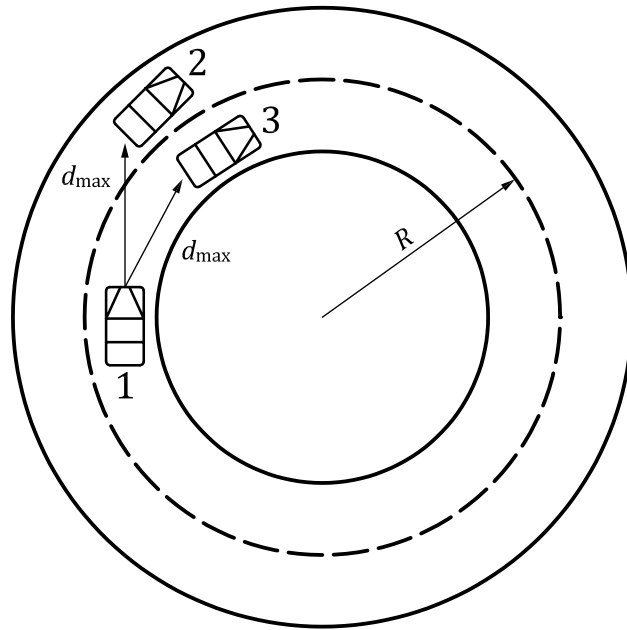

Key

- 1 subject vehicle
- 2 forward vehicle
- 3 target vehicle

Figure 9 — Curved test track and target discrimination ability test

6.5.3 Overhead discrimination

The test shall be performed dynamically. As shown in [Figure 10](#), the test target which may cause false warnings is installed. The test target shall be a representative of a concrete bridge or overhead traffic sign structure. The subject vehicle approaches the test target, and passes under it. The test is finished, when the subject vehicle has not produced a warning. The height of the test target is 4,5 m.

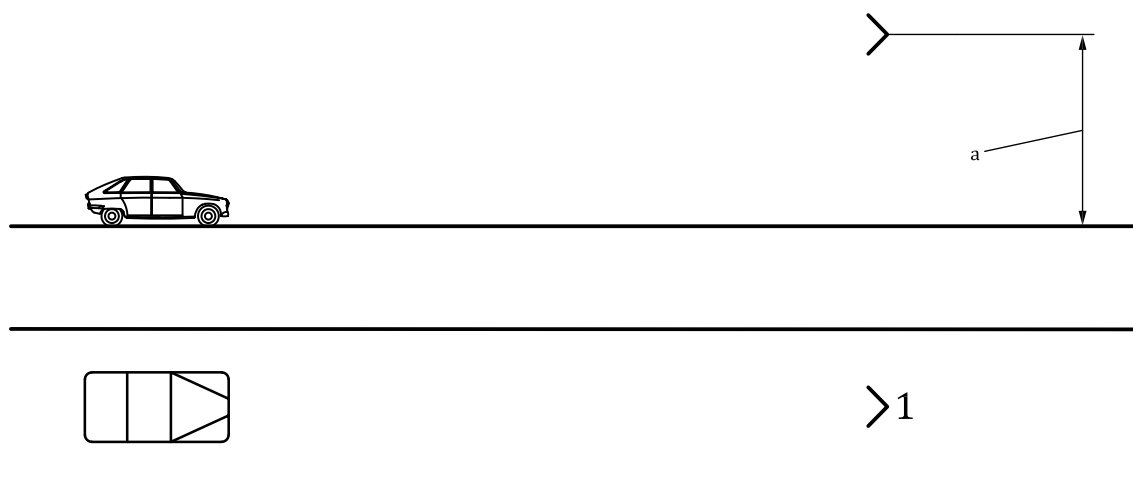

Key

- 1 test target
- a 4,5 m.

Figure 10 — Overhead target discrimination ability test

Annex A (informative)

Basic consideration of collision warning

A.1 Basic equation

As indicated in [Figure A.1](#), the basic mathematical model is based on a warning distance algorithm that takes preceding and subject vehicle absolute speed and calculates a warning distance. This warning distance is compared with the measured distance and if exceeded, the driver is warned. The warning distance for preliminary collision warning and collision warning may be adjusted by selecting appropriate free running (driver's brake reaction) time, T and vehicle deceleration, a .

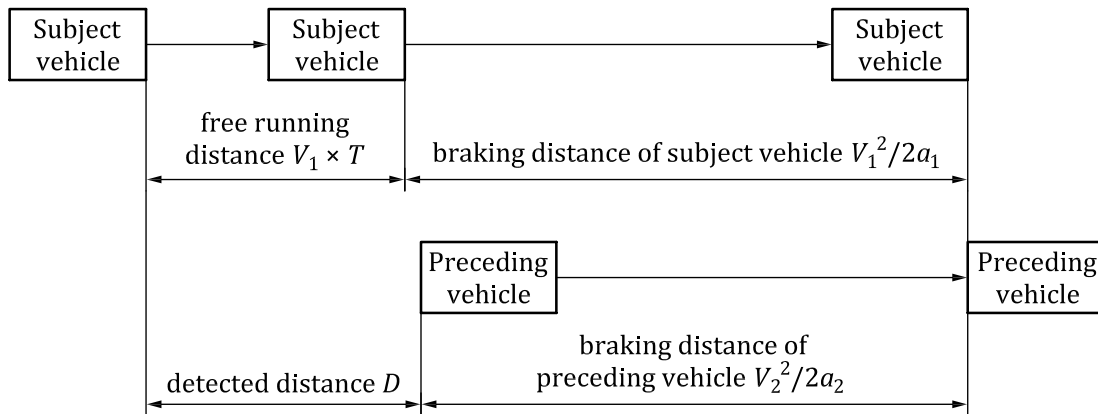

Figure A.1 — Operation principles

$$D = V_1 \times T + (V_1^2 / 2 a_1 - V_2^2 / 2 a_2) \tag{A.1}$$

where

- D is the distance to preceding vehicle (obstacle);
- V_1 is the subject vehicle speed;
- V_2 is the preceding vehicle (obstacle) speed;
- T is the free running (driver's brake reaction) time;
- a_1 is the subject vehicle deceleration;
- a_2 is the preceding vehicle (obstacle) deceleration.

A.2 Scenarios where warning is issued

Although there are many scenarios where the warning is issued, typical scenarios are examined.

A.2.1 Preceding vehicle is travelling at the same speed as a subject vehicle

$$D_1 = V_1 \times T \quad (\text{A.2})$$

A.2.2 Preceding vehicle is a stationary obstacle

$$D_2 = V_1 \times T + V_1^2 / 2a_1 \quad (\text{A.3})$$

When the subject vehicle is approaching to the preceding vehicle travelling at a constant, V_1 means the relative speed between the subject vehicle and the preceding vehicle.

A.2.3 Preceding vehicle is decelerating with relative speed, $V_{\text{Rel}} = (V_1 - V_2)$

$$D = (T + V_{\text{rel}} / a) \times V_1 - V_{\text{Rel}}^2 / 2a \quad (\text{A.4})$$

A.3 Evaluation results of T and a

A.3.1 Free running (driver's brake reaction) time, T

Values for T were based on the reference report.^[4]

Tests for free running (driver's brake reaction) time T fell within 0,3 approximately 2,0 s. The average value of T was 0,66 s. The test was put into effect by 321 persons and measured the delay time of brake operation after indication by the horn. The distribution of values was scattered very widely. However 98 % of all subject persons were under 1,5 s.

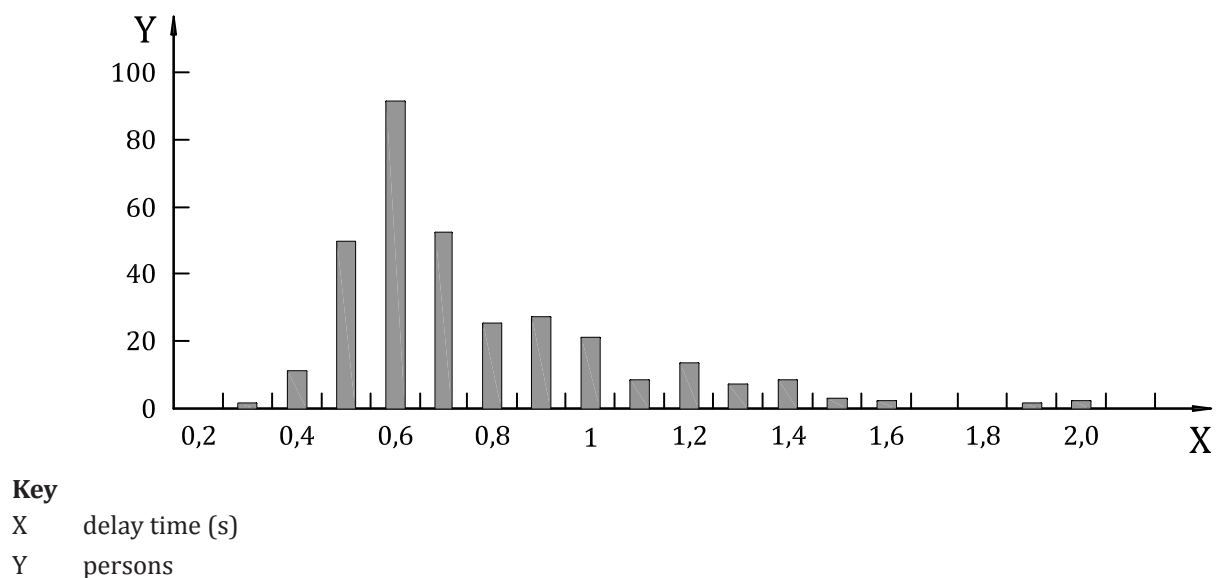

Figure A.2 — Distribution of driver's brake reaction time, T

A.3.2 Deceleration, a

Values for 'a' were measured through evaluating emergency brake performance on a dry, flat road surface.

Tests for deceleration a indicate that values fell within 3,6 approximately 7,9 m/s². The average value of a for passenger cars was 7,0 m/s² and the average was 5,3 m/s² for commercial vehicles. The distribution of values was scattered very widely and depended on vehicle type, laden condition, driver reaction characteristics.

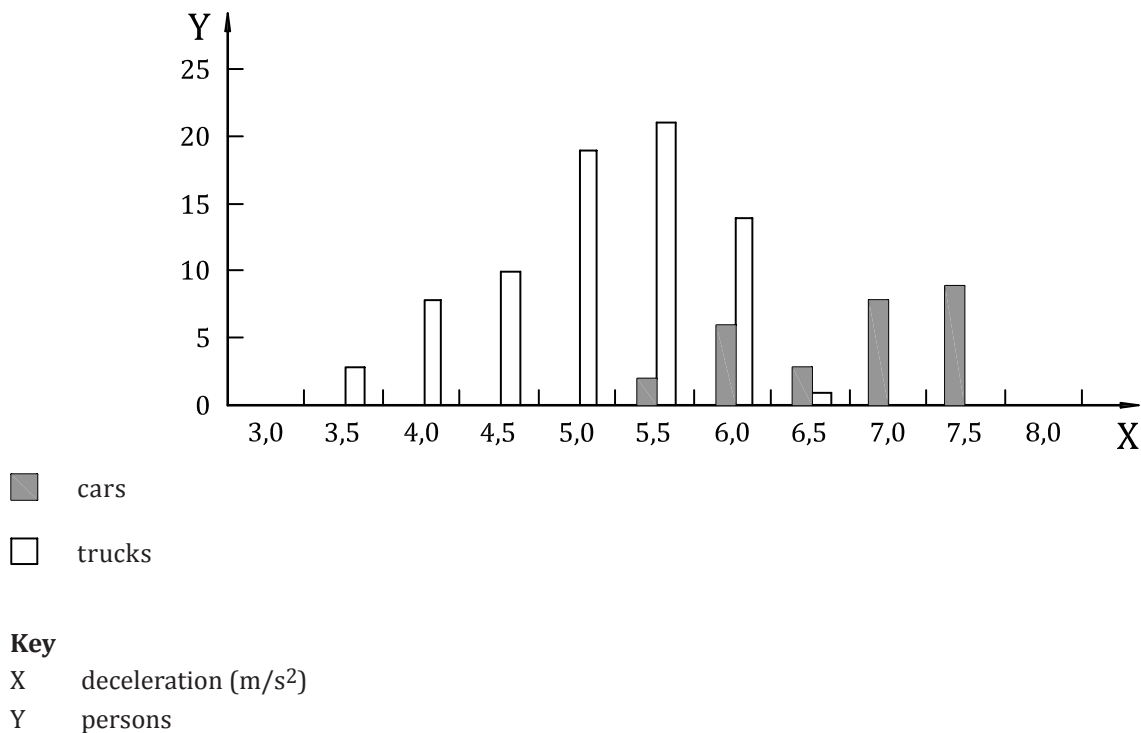

Figure A.3 — Distribution of deceleration, a

A.4 Calculation examples of the warning distance

A.4.1 Preceding vehicle is travelling at ordinary speed

For the case of the subject vehicle travelling at ordinary speed slightly higher than that of a preceding vehicle assuming a free running (driver's brake reaction) time of 1,5, 0,66, 0,4 s the warning distance [Formula (2)] is as [Figure A.4](#).

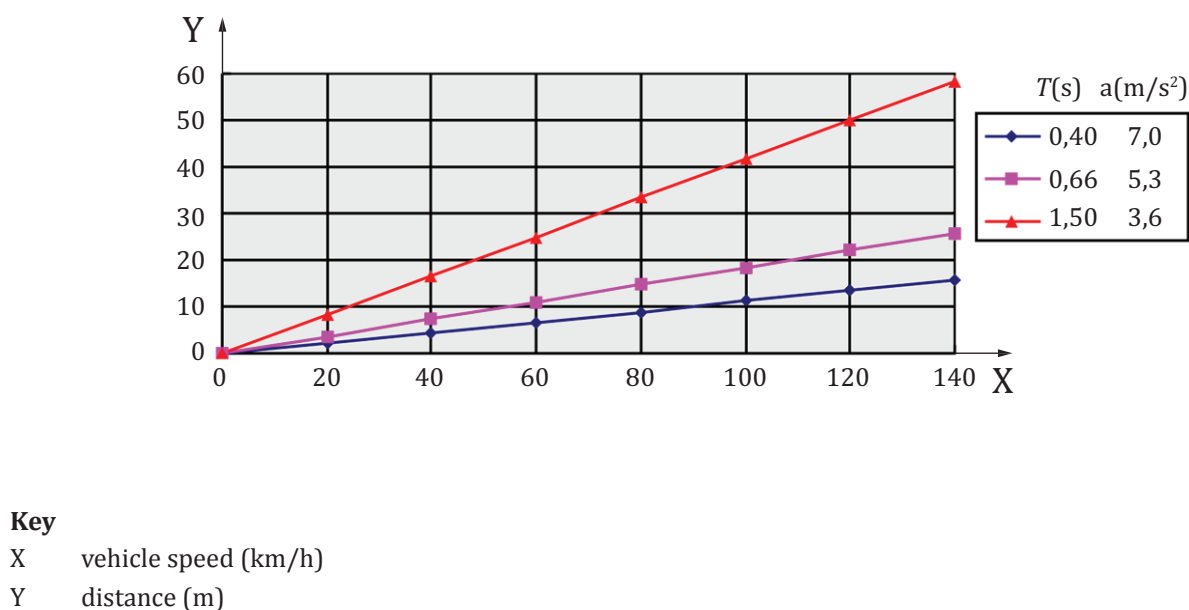
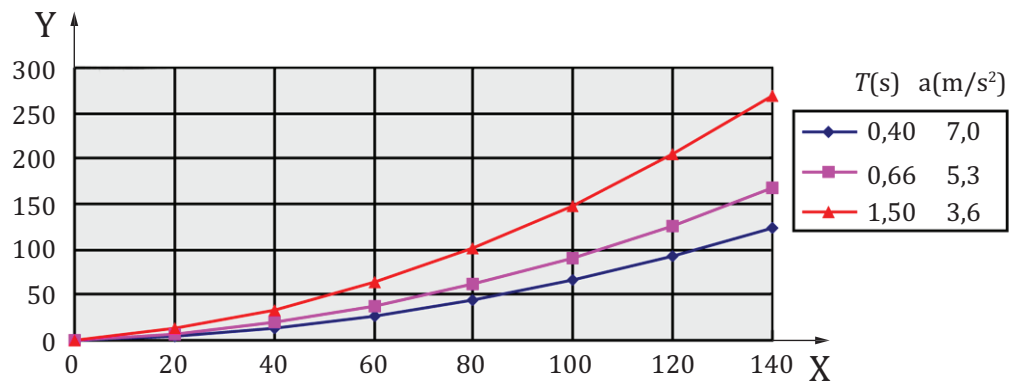

Figure A.4 — Relationship between vehicle speed and warning distance for preceding vehicle at ordinary speed

A.4.2 Preceding vehicle is a stationary obstacle vehicle

For the case of subject vehicle encountering a stationary obstacle vehicle and assuming a free running (driver's brake reaction) time of 1,5, 0,66, 0,4 s and deceleration of 3,6, 5,3, 7,0 m/s², the relationship between subject vehicle speed and stop distance is as indicated in [Figure A.5](#).



Key

X vehicle speed (km/h)
Y distance (m)

Figure A.5 — Relationship between Vehicle speed and stopping distance for stationary obstacle

A.4.3 Preceding vehicle is decelerating with relative speed, $V_{Rel} = (V_1 - V_2)$

Also from Formula (4), the relationship between relative speed and Inter-vehicle distance can be determined and is as shown in [Figure A.6](#) for the case of subject vehicle speed of 100 km/h, a free running (driver's brake reaction) time of 1,5, 0,66, 0,4 s and deceleration of 3,6, 5,3, 7,0 m/s².

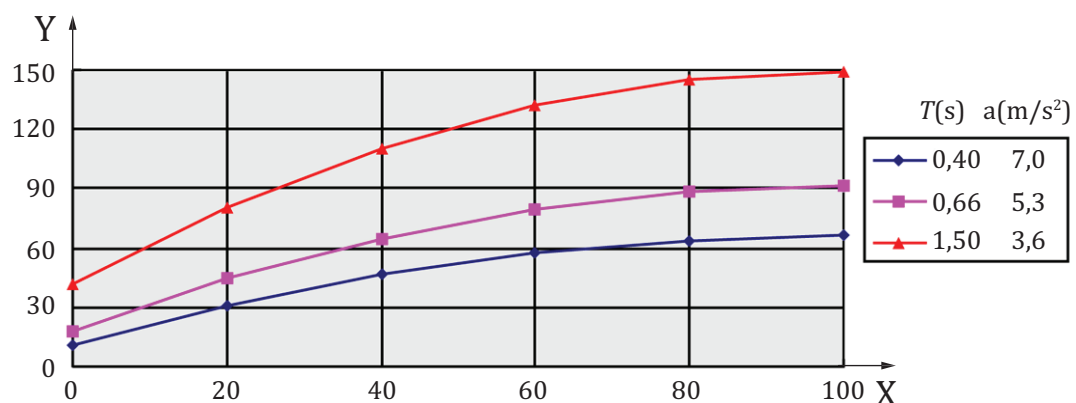

Key

X relative speed (km/h)
Y distance (m)

Figure A.6 — Relationship between relative speed and inter-vehicle distance

A.5 Design parameter

The following values should be used to calculate the D_{\max} and d_1 :

$$T_{\max} = 1,5 \text{ s};$$

$$T_{\min} = 0,4 \text{ s};$$

$$a_{\min} = 3,6 \text{ m/s}^2.$$

Annex B (informative)

Obstacle detection along curves

Systems with curve recognition shall require a coverage of obstacle detection as shown in [Figure B.1](#).

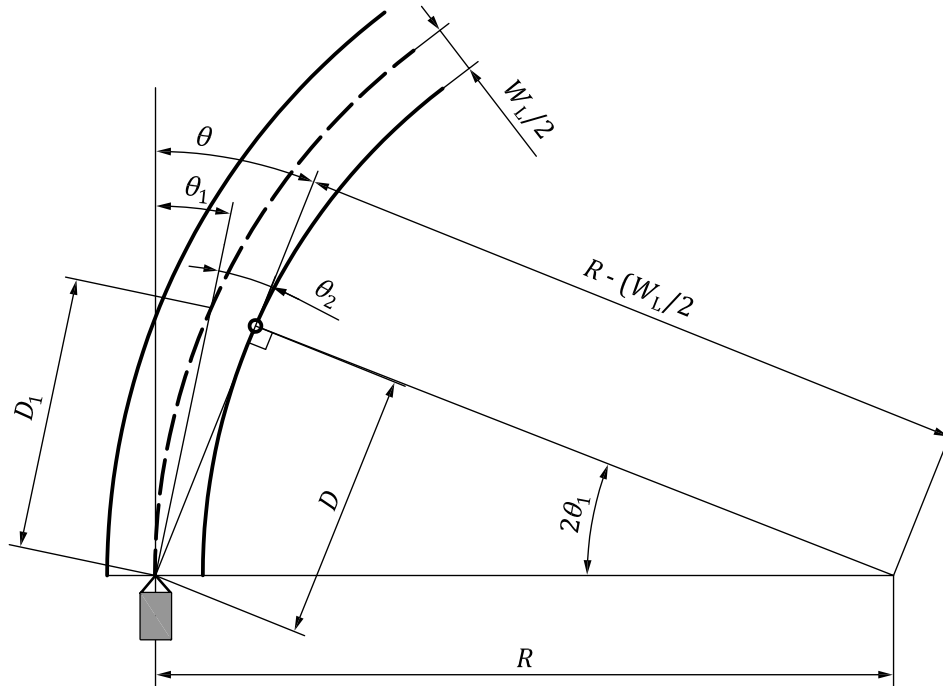

Key

- R curve radius (m)
- D distance to obstacle (m)
- θ detection angle ($^{\circ}$)
- W_L lane width (m)

Figure B.1 — Coverage of Class I, II and III systems

From [Figure B.1](#), D is given by the following equation.

$$D = (R \times W_L - W_L^2 / 4)^{0,5} \quad (\text{B.1})$$

$$D_1 = (D^2 + W_L^2 / 4)^{0,5} \quad (\text{B.2})$$

$$\text{Then } \theta_1 = 90 \times D_1 / (\pi \times R) \quad (\text{B.3})$$

From [Figure B.1](#), θ_2 is given by the following equation.

$$\theta_2 = \tan^{-1}(W_L / 2D) \quad (\text{B.4})$$

Then maximum detection angle θ is given by the following equation.

$$\theta = \theta_1 + \theta_2 \quad (\text{B.5})$$

Table — B. 1 — Maximum detection angle θ

| | Curve radius (m) | | | | | | |
|------------------------------|------------------|-------|-------|-------|-------|-------|-------|
| | 100 | 200 | 300 | 400 | 500 | 600 | 700 |
| maximum detect range D (m) | 19,27 | 27,32 | 33,49 | 38,68 | 43,26 | 47,40 | 51,20 |
| D_1 (m) | 19,36 | 27,39 | 33,54 | 38,73 | 43,30 | 47,43 | 51,23 |
| θ_1 (°) | 5,55 | 3,92 | 3,20 | 2,78 | 2,48 | 2,27 | 2,10 |
| θ_2 (°) | 5,56 | 3,93 | 3,21 | 2,78 | 2,48 | 2,27 | 2,10 |
| θ (°) | 11,11 | 7,85 | 6,41 | 5,55 | 4,97 | 4,53 | 4,20 |

Annex C (informative)

Laser radar — Coefficient of test target

C.1 Solid angle, Ω

The solid angle [Ω] is the ratio of the irradiated portion of the surface of light to the square of the radius of the sphere.

$$\Omega = (A/d_A^2) \times \Omega_0 \quad (\text{C.1})$$

where

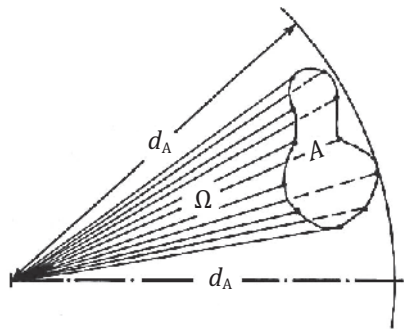

Ω is the solid angle, unit steradians [sr];

A is the utilized area;

d_A is the distance between source and projected area A ;

Ω_0 is the solid angle of the source [1 sr].

Figure C.1 — Solid angle

C.2 Radiated intensity, I

The radiated intensity I is given by the radiated power Φ out of a radiation source, inside an area Ω .

$$I_{\text{ref}} = d\Phi_{\text{ref}}/d\Omega_1 \quad (\text{C.2})$$

where

I_{ref} is the radiated intensity in a given direction, out of the reflector, measured in front of the receiver surface. [W/sr];

Φ_{ref} is the radiated power [W];

Ω_1 is the illuminated solid angle [sr].

C.3 Intensity of irradiation, E

Intensity of irradiation is the ratio of the incident radiated power to the area of illuminated surface. E is the density by surface of the illumination.

$$E_t = d\Phi_t / dA_t \quad (\text{C.3})$$

where

E_t is the intensity of irradiation, received from the transmitter at target level [W/m²];

Φ_t is the radiated power [W];

A_t is the illuminated surface [m²].

C.4 Reflection Coefficient of Test Target (RCTT)

$$RCTT = I_{\text{ref}} / E_t \quad (\text{C.4})$$

where

I_{ref} is the radiated intensity in a given direction, out of the reflector, measured at a target level [W/sr];

E_t is the intensity of irradiation, received from the transmitter at target level [W/m²];

$RCTT$ is the Coefficient of Test Target [m²/sr].

The reflector with the defined RCTT shall have a weighting of the reflection $\geq 8 \times 10^{-3}$ sr.

The RCTT (Coefficient of Test Target) only describes the quality of a reflector (damping). For the test procedure it is sufficient to have a corner reflector (reduction of the surface to 'a point'). But it is also possible to have a larger surface of reflection, if the whole reflectivity of the reflector surface does not exceed the mentioned value.

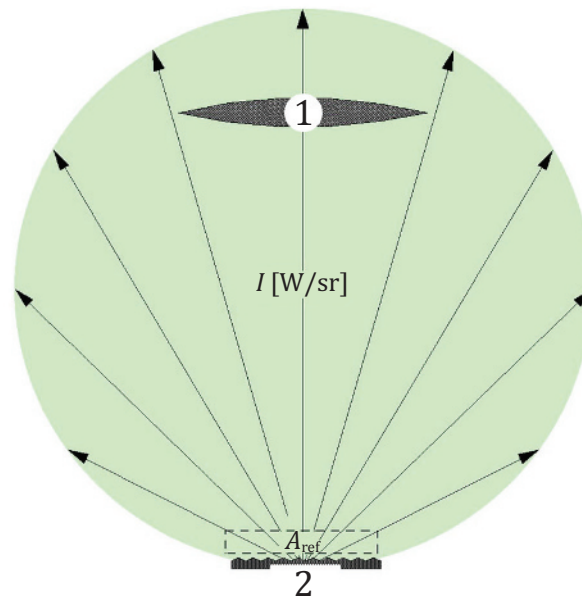

Key

- 1 receiver
- 2 reflector

Figure C.2 — Receiver scenario

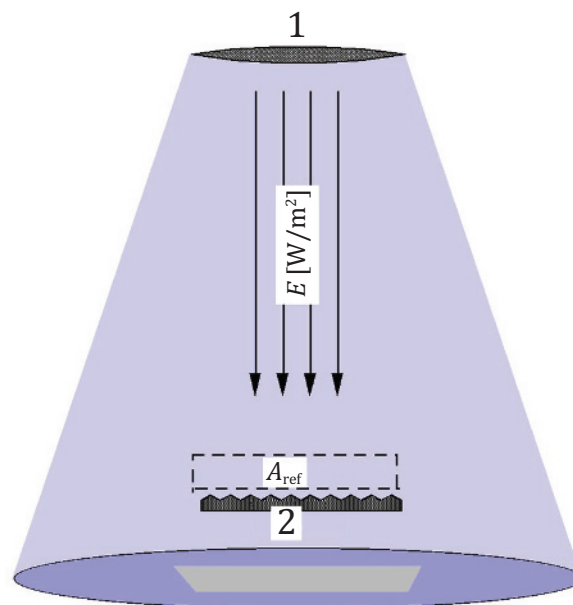

Key

- 1 transmitter
- 2 reflector

Figure C.3 — Transmitter scenario

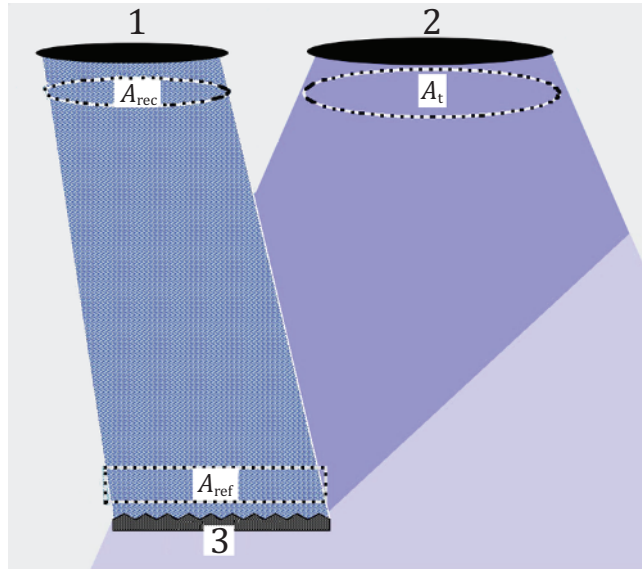

Key

- 1 receiver
- 2 transmitter
- 3 reflector

Figure C.4 — Reflector scenario

Annex D (informative)

Radio wave radar test target geometry

Typical test targets are corner cube reflectors and metal spheres. The metal sphere has the advantage of measurement stability, but, the shape makes it difficult to handle. Corner cube reflectors on the other hand are compact and easy to set up at the measuring points, therefore the standard test target may be a corner cube reflector. The shape of the test target is shown in [Figure D.1](#).

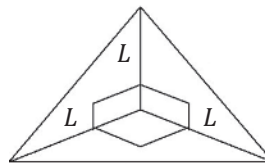

Figure D.1 — Geometry of a corner cube reflector type test target

The general formula for calculating RCS:

$$\text{RCS} = (4 \times \pi \times L^4) / (3 \times \lambda^2)$$

where

L is the length of each side;

λ is the Centre transmit wavelength.

Bibliography

- [1] JOHANSSON G., & RUMAR K "Driver's Brake Reaction Times". *Hum. Factors*. 1971, **13** (1) pp. 23–27
- [2] ISO 22839, *Intelligent transport systems — Forward vehicle collision mitigation systems — Operation, performance, and verification requirements*
- [3] ISO 15622:2002, *Transport Information and Control Systems — Adaptive Cruise Control Systems — Performance requirements and test procedures*
- [4] ISO 22179, *Intelligent transport systems — Full speed range adaptive cruise control (FSRA) systems — Performance requirements and test procedures*
- [5] ISO 22178, *Intelligent transport systems — Low speed following (LSF) systems — Performance requirements and test procedures*
- [6] ISO 2575, *Road vehicles — Symbols for controls, indicators and tell-tales*
- [7] ISO 6161:1981, *Personal eye-protectors — Filters and eye-protectors against laser radiation*
- [8] ISO 15006, *Road vehicles — Ergonomic aspects of transport information and control systems — Specifications for in-vehicle auditory presentation*
- [9] ISO 15008, *Road vehicles — Ergonomic aspects of transport information and control systems — Specifications and test procedures for in-vehicle visual presentation*

British Standards Institution (BSI)

BSI is the national body responsible for preparing British Standards and other standards-related publications, information and services.

BSI is incorporated by Royal Charter. British Standards and other standardization products are published by BSI Standards Limited.

About us

We bring together business, industry, government, consumers, innovators and others to shape their combined experience and expertise into standards-based solutions.

The knowledge embodied in our standards has been carefully assembled in a dependable format and refined through our open consultation process. Organizations of all sizes and across all sectors choose standards to help them achieve their goals.

Information on standards

We can provide you with the knowledge that your organization needs to succeed. Find out more about British Standards by visiting our website at bsigroup.com/standards or contacting our Customer Services team or Knowledge Centre.

Buying standards

You can buy and download PDF versions of BSI publications, including British and adopted European and international standards, through our website at bsigroup.com/shop, where hard copies can also be purchased.

If you need international and foreign standards from other Standards Development Organizations, hard copies can be ordered from our Customer Services team.

Subscriptions

Our range of subscription services are designed to make using standards easier for you. For further information on our subscription products go to bsigroup.com/subscriptions.

With **British Standards Online (BSOL)** you'll have instant access to over 55,000 British and adopted European and international standards from your desktop. It's available 24/7 and is refreshed daily so you'll always be up to date.

You can keep in touch with standards developments and receive substantial discounts on the purchase price of standards, both in single copy and subscription format, by becoming a **BSI Subscribing Member**.

PLUS is an updating service exclusive to BSI Subscribing Members. You will automatically receive the latest hard copy of your standards when they're revised or replaced.

To find out more about becoming a BSI Subscribing Member and the benefits of membership, please visit bsigroup.com/shop.

With a **Multi-User Network Licence (MUNL)** you are able to host standards publications on your intranet. Licences can cover as few or as many users as you wish. With updates supplied as soon as they're available, you can be sure your documentation is current. For further information, email bsmusales@bsigroup.com.

BSI Group Headquarters

389 Chiswick High Road London W4 4AL UK

Revisions

Our British Standards and other publications are updated by amendment or revision.

We continually improve the quality of our products and services to benefit your business. If you find an inaccuracy or ambiguity within a British Standard or other BSI publication please inform the Knowledge Centre.

Copyright

All the data, software and documentation set out in all British Standards and other BSI publications are the property of and copyrighted by BSI, or some person or entity that owns copyright in the information used (such as the international standardization bodies) and has formally licensed such information to BSI for commercial publication and use. Except as permitted under the Copyright, Designs and Patents Act 1988 no extract may be reproduced, stored in a retrieval system or transmitted in any form or by any means – electronic, photocopying, recording or otherwise – without prior written permission from BSI. Details and advice can be obtained from the Copyright & Licensing Department.

Useful Contacts:

Customer Services

Tel: +44 845 086 9001

Email (orders): orders@bsigroup.com

Email (enquiries): cservices@bsigroup.com

Subscriptions

Tel: +44 845 086 9001

Email: subscriptions@bsigroup.com

Knowledge Centre

Tel: +44 20 8996 7004

Email: knowledgecentre@bsigroup.com

Copyright & Licensing

Tel: +44 20 8996 7070

Email: copyright@bsigroup.com



...making excellence a habit.™