

BS ISO 12480-3:2016



BSI Standards Publication

Cranes — Safe use

Part 3: Tower cranes

National foreword

This British Standard is the UK implementation of ISO 12480-3:2016.

The UK participation in its preparation was entrusted to Technical Committee MHE/3/5, Mobile cranes.

A list of organizations represented on this committee can be obtained on request to its secretary.

This publication does not purport to include all the necessary provisions of a contract. Users are responsible for its correct application.

© The British Standards Institution 2016.
Published by BSI Standards Limited 2016

ISBN 978 0 580 92757 7

ICS 53.020.20

Compliance with a British Standard cannot confer immunity from legal obligations.

This British Standard was published under the authority of the Standards Policy and Strategy Committee on 31 August 2016.

Amendments/corrigenda issued since publication

Date	Text affected
------	---------------

INTERNATIONAL
STANDARD

BS ISO 12480-3:2016

ISO
12480-3

Second edition
2016-08-15

Cranes — Safe use —

Part 3:
Tower cranes

Appareils de levage à charge suspendue — Sécurité d'emploi —
Partie 3: Grues à tour



Reference number
ISO 12480-3:2016(E)

© ISO 2016



COPYRIGHT PROTECTED DOCUMENT

© ISO 2016, Published in Switzerland

All rights reserved. Unless otherwise specified, no part of this publication may be reproduced or utilized otherwise in any form or by any means, electronic or mechanical, including photocopying, or posting on the internet or an intranet, without prior written permission. Permission can be requested from either ISO at the address below or ISO's member body in the country of the requester.

ISO copyright office
Ch. de Blandonnet 8 • CP 401
CH-1214 Vernier, Geneva, Switzerland
Tel. +41 22 749 01 11
Fax +41 22 749 09 47
copyright@iso.org
www.iso.org

Contents

	Page
Foreword	vi
1 Scope	1
2 Normative references	1
3 Terms and definitions	1
4 Management of the lifting operation	2
4.1 Safety system work.....	2
4.2 Control of the crane operation.....	2
4.3 Contractual considerations.....	2
5 Selection, responsibilities and minimum requirements of personnel	2
5.1 General.....	2
5.2 Duties of the person appointed to control the crane operation (the appointed person).....	2
5.3 Crane operator.....	2
5.4 Slinger.....	3
5.5 Signaller.....	3
5.6 Crane erector.....	3
5.7 Maintenance personnel.....	3
5.8 Inspection personnel/crane inspector (for “routine periodic inspection”).....	3
5.8.1 Duties.....	3
5.8.2 Minimum requirements.....	4
5.9 Crane co-ordinator.....	4
5.9.1 Duties.....	4
5.9.2 Minimum provisions.....	4
5.10 Crane erection supervisor.....	4
5.10.1 Duties.....	4
5.10.2 Minimum provisions.....	5
5.11 Other particulars.....	5
6 Safety	5
6.1 General.....	5
6.2 Identification of person directing crane movements.....	5
6.3 Personal safety equipment.....	5
6.4 Use of personal safety equipment.....	5
6.5 Access.....	6
6.5.1 General.....	6
6.5.2 Boarding and leaving the crane.....	6
6.5.3 Instruction of personnel.....	6
6.5.4 Jib and counter jib access.....	6
6.5.5 Cab safety.....	6
6.6 Fire extinguishers.....	7
6.7 Documentation.....	7
6.8 Crane operator’s aids.....	7
6.9 Other safety provisions.....	7
6.9.1 Lightning protection.....	7
6.9.2 Ballast.....	8
6.9.3 Alarms.....	8
6.9.4 Signboards.....	8
7 Selection of tower cranes	8
8 Siting of cranes	9
8.1 General.....	9
8.2 Crane standing or support conditions.....	9
8.2.1 General.....	9
8.2.2 Tower crane foundations.....	9
8.3 Proximity hazards.....	10

9	Erecting, dismantling and alteration of height	10
9.1	Planning	10
9.2	Identification of components	11
9.3	Electrical supply	11
9.4	Personnel	11
9.5	Control	12
9.6	Inspection before erection	12
9.7	Weather	12
9.8	Manufacturer's erection, alteration of height and dismantling instructions	12
9.9	Tower crane climbing	12
9.9.1	General	12
9.9.2	Planning the climbing operation	13
9.9.3	Appointed person	13
9.9.4	Erection supervisor	13
9.9.5	Re-commissioning the crane upon completion of the climbing operation	14
9.10	Components and materials	14
9.10.1	Interchangeability of components	14
9.10.2	Materials	14
10	Procedures and precautions	15
10.1	Crane operation	15
10.2	Working on cranes	15
10.2.1	General	15
10.2.2	Permit to work system	15
10.2.3	Periodic checks	15
10.2.4	Regular inspections	15
10.2.5	Condition monitoring	15
10.3	Reporting of defects and incidents	15
10.4	Leaving the crane	15
10.5	Working at heights	16
11	Operating conditions	16
11.1	Rated capacity	16
11.2	Operation and control	16
11.3	Handling of loads near persons	16
11.4	Multiple lifting	16
11.5	Special duties	16
11.5.1	General	16
11.5.2	Grabbing and magnet crane service	16
11.5.3	Demolition and other special operations	16
11.6	Weather conditions	17
11.6.1	General	17
11.6.2	Wind	17
11.6.3	Visibility	17
11.6.4	Rain, snow or ice	17
11.6.5	Inspection following adverse weather conditions	17
12	Slinging and handling of loads	17
13	Raising and lowering of persons	17
14	Tests, inspections and condition monitoring	18
14.1	General	18
14.2	Age and utilization	18
14.3	Personnel safety	18
15	Signalling systems	18
15.1	General	18
15.2	Radio communications	19
Annex A (normative) Requirements for provision of working space limiters and anti-collision devices		20

Annex B (informative) Tower crane climbing operations24

Foreword

ISO (the International Organization for Standardization) is a worldwide federation of national standards bodies (ISO member bodies). The work of preparing International Standards is normally carried out through ISO technical committees. Each member body interested in a subject for which a technical committee has been established has the right to be represented on that committee. International organizations, governmental and non-governmental, in liaison with ISO, also take part in the work. ISO collaborates closely with the International Electrotechnical Commission (IEC) on all matters of electrotechnical standardization.

The procedures used to develop this document and those intended for its further maintenance are described in the ISO/IEC Directives, Part 1. In particular the different approval criteria needed for the different types of ISO documents should be noted. This document was drafted in accordance with the editorial rules of the ISO/IEC Directives, Part 2 (see www.iso.org/directives).

Attention is drawn to the possibility that some of the elements of this document may be the subject of patent rights. ISO shall not be held responsible for identifying any or all such patent rights. Details of any patent rights identified during the development of the document will be in the Introduction and/or on the ISO list of patent declarations received (see www.iso.org/patents).

Any trade name used in this document is information given for the convenience of users and does not constitute an endorsement.

For an explanation on the meaning of ISO specific terms and expressions related to conformity assessment, as well as information about ISO's adherence to the World Trade Organization (WTO) principles in the Technical Barriers to Trade (TBT) see the following URL: www.iso.org/iso/foreword.html

The committee responsible for this document is ISO/TC 96, *Cranes*, Subcommittee SC 7, *Tower cranes*.

This second edition cancels and replaces the first edition (ISO 12480-3:2005), of which it constitutes a minor revision. Notably, "driver" has been replaced by "operator" throughout the text.

ISO 12480 consists of the following parts, under the general title *Cranes — Safe use*:

- *Part 1: General*
- *Part 3: Tower cranes*

Cranes — Safe use —

Part 3: Tower cranes

1 Scope

This part of ISO 12480 establishes required practices for the safe use of tower cranes. It is intended to be used in conjunction with ISO 12480-1.

Subjects covered include safe systems of work, management, planning, selection, erection and dismantling, special base, operation and maintenance of cranes and the selection of operators, slingers and signallers.

It does not cover manually (non-powered) operated cranes, or cranes in which at least one of its motions is manually operated.

2 Normative references

The following documents, in whole or in part, are normatively referenced in this document and are indispensable for its application. For dated references, only the edition cited applies. For undated references, the latest edition of the referenced document (including any amendments) applies.

ISO 4306-1, *Cranes — Vocabulary — Part 1: General*

ISO 4306-3, *Cranes — Vocabulary — Part 3: Tower cranes*

ISO 9926-1, *Cranes — Training of drivers — Part 1: General*

ISO 9926-3, *Cranes — Training of operators — Part 3: Tower cranes*

ISO 9927-1, *Cranes — Inspections — Part 1: General*

ISO 9927-3:2005, *Cranes — Inspections — Part 3: Tower cranes*

ISO 11660-3, *Cranes — Access, guards and restraints — Part 3: Tower cranes*

ISO 12480-1:1997, *Cranes — Safe use — Part 1: General*

ISO 12482, *Cranes — Monitoring for crane design working period*

3 Terms and definitions

For the purposes of this document, the terms and definitions given in ISO 12480-1, ISO 4306-1, ISO 4306-3 and the following apply.

3.1

working space limiter

device to prevent a fixed load lifting attachment and/or parts of the crane from entering a prohibited space

Note 1 to entry: Working space limitation is often achieved by a combination of different limiters.

4 Management of the lifting operation

4.1 Safety system work

ISO 12480-1 shall apply.

In addition, the following considerations shall be taken into account.

On sites where there is more than one tower crane, which are not equipped with anti-collision devices, and there is a possibility of collision between cranes, a person, designated as the crane co-ordinator (see [5.9](#)), and the crane operator shall coordinate the sequence of crane movements to prevent collisions. Any corresponding instructions from the crane co-ordinator to the crane operators shall be via the respective signallers. In such circumstances the signallers shall obtain the agreement of the crane co-ordinator before carrying out any operation.

Where tower cranes inter-arc, a vertical distance shall be maintained to prevent collisions. This distance shall be either

- a) a minimum clearance of 3 m, or
- b) a minimum clearance of 600 mm when taking into account the manufacturer's deflections, only when full details are available from the manufacturer.

The positioning of the crane and components in the out-of-service condition, as specified by the manufacturer's instructions, shall be such that no collisions can take place [see [10.4 b](#)]).

Cranes should, where possible, be sited such that collision hazards are eliminated or minimised.

4.2 Control of the crane operation

ISO 12480-1:1997, 4.2, shall apply.

4.3 Contractual considerations

It is unlikely that tower cranes will be used in "contract operation" (i.e. where an "employing organisation" enters into a contract with a "user organisation" that will undertake the work on their behalf).

If required, ISO 12480-1:1997, 4.3, shall apply.

5 Selection, responsibilities and minimum requirements of personnel

5.1 General

ISO 12480-1:1997, 5.1, shall apply.

5.2 Duties of the person appointed to control the crane operation (the appointed person)

ISO 12480-1:1997, 5.2, shall apply.

In the interests of safety the appointed person shall arrange the lifting programme such that no operator has to be in attendance at the control station or actually operating the crane for an unreasonably long period, taking into account environmental conditions. The operator shall have breaks from the working activity in line with other personnel on the site.

5.3 Crane operator

ISO 12480-1:1997, 5.3.1 and 5.3.2, shall apply.

When selecting tower crane operators, it shall be borne in mind that they may be required to climb to considerable heights and to spend long periods of time in isolation.

ISO 9926-1 and ISO 9926-3 specify the minimum training to be given to trainee tower cranes operators in order to develop the operational basic skill in driving and to impart the requisite knowledge for the correct use of these skills.

5.4 Slinger

ISO 12480-1:1997, 5.4, shall apply.

5.5 Signaller

ISO 12480-1:1997, 5.5, shall apply.

5.6 Crane erector

ISO 12480-1:1997, 5.6, shall apply.

In addition, the crane erectors should be

- a) fully conversant with the appropriate sections of the manufacturer's instruction manual, and
- b) familiar with all aspects of their personal protective equipment and capable of using it correctly.

5.7 Maintenance personnel

ISO 12480-1:1997, 5.7, shall apply.

In addition, the maintenance personnel shall be

- a) fully conversant with the appropriate sections of the manufacturer's instruction manual,
- b) familiar with the "permit to work" system where it is required by the safe system of work (see ISO 12480-1:1997, 10.2.2), and able to operate it correctly;
- c) familiar with all aspects of their personal protective equipment and capable of using it correctly.

5.8 Inspection personnel/crane inspector (for "routine periodic inspection")

5.8.1 Duties

The inspection personnel/crane inspector shall

- a) verify that
 - the documentation is available,
 - the crane is erected according to manufacturer's instructions,
 - there is no defect or deterioration on
 - the steel structure,
 - mechanisms (brakes), or
 - the control system,
 - all mechanisms (brakes) are functioning properly
 - all limiting and indicating devices are functioning properly, and

- b) give a report of the inspection to the appointed person.

5.8.2 Minimum requirements

The inspection personnel/crane inspector shall be

- a) competent for the type of inspection being carried out,
- b) able to work confidently and safely at heights,
- c) conversant with the legislation relative to the crane,
- d) conversant with the use of a crane, and
- e) capable of verifying and recognizing the importance of defects.

For non-routine inspection (e.g. first use inspection, inspection after major repair or modification, special assessment) an expert engineer is required. See ISO 9927-1, ISO 12482.

5.9 Crane co-ordinator

5.9.1 Duties

The crane co-ordinator should coordinate the sequence of operations of tower cranes on sites having more than one crane, to prevent the collision of the cranes, components and/or loads.

5.9.2 Minimum provisions

The crane co-ordinator should be

- a) competent,
- b) over 21 years of age unless under the direct supervision of a person competent for the purposes of training,
- c) fit, with particular regard to eyesight, hearing, reflexes and agility,
- d) experienced for at least five years in the use of tower cranes,
- e) trained in the techniques of signalling and with a good understanding of hand signals for cranes,
- f) capable of giving precise and clear instructions, (e.g. verbal, non-verbal, audio),
- g) where audio equipment (e.g. radio) is employed, capable of operating such equipment, and
- h) capable of producing a crane coordinator's plan [see [5.10.1 b\)](#)].

5.10 Crane erection supervisor

5.10.1 Duties

The crane erection supervisor is the "erector in charge", as detailed in ISO 12480-1:1997, 5.6.1.

The crane erection supervisor should have the responsibilities of a crane erector and in addition

- a) be in control of all crane erectors and of any additional cranes and lifting equipment which may be used in the erection/dismantling operation,
- b) provide a means for ensuring that the operation is carried out in accordance with the crane co-ordinator's plan,

- c) ensure that additional cranes and equipment are in accordance with that specified and properly certified;
- d) verify that all erectors are equipped with the necessary tools and personal protective equipment.

The appointed person (see 5.2) retains overall responsibility for the erection/dismantling operation, including the planning.

If the crane erection supervisor has to leave the site of the operation, even for a few minutes, he or she should appoint another suitably qualified member of his/her team to be in charge during the period of absence, in order to prevent any ambiguity as to the control of the operation. However, the crane erection supervisor shall be present during all critical parts of the operation.

The crane erection supervisor should attempt to remain on site throughout the whole of the erection/dismantling operation.

5.10.2 Minimum provisions

The crane erection supervisor should have the same attributes as the crane erector and in addition

- a) have at least five years' experience in the erection and dismantling of tower cranes or similar equipment, and be trained in the supervision of such operations;
- b) be in possession of the manufacturer's instruction manual for the particular crane and be fully conversant with this manual,
- c) be trained in the control of personnel carrying out the duties of erecting and dismantling tower cranes, and in ensuring that all persons use their personal protective equipment correctly, and
- d) be able to confirm the suitability of the equipment used in the erection process.

5.11 Other particulars

If the slinger or signaller is required to carry out a lifting operation which is outside the crane coordinator's plan, the appointed person shall be alerted.

6 Safety

6.1 General

ISO 12480-1:1997, 6.1, shall apply.

6.2 Identification of person directing crane movements

ISO 12480-1:1997, 6.2, shall apply.

6.3 Personal safety equipment

ISO 12480-1:1997, 6.3 shall apply.

6.4 Use of personal safety equipment

ISO 12480-1:1997, 6.4, shall apply.

Helmets with chin straps should be used when working at heights.

A safety harness with dual lanyard should be used where appropriate.

Personnel working on tower cranes should wear suitable footwear for climbing structures.

6.5 Access

6.5.1 General

ISO 12480-1:1997, 6.5.1, shall apply.

If personnel need to be present on the crane while the machine is in use, the crane operator shall always be informed in advance.

It is recommended that access to tower cranes is prohibited to personnel whose presence is not essential, wherever possible.

6.5.2 Boarding and leaving the crane

ISO 12480-1:1997, 6.5.2, shall apply.

The appointed person should verify that ladders, rest platforms and other means of access are in accordance with manufacturer's instructions.

The erection supervisor shall verify that access equipment is correctly installed progressively as erection proceeds, so that the erection team have the benefit of their use. Particular attention should be paid to

- a) ladder joint bolts,
- b) guard rails, particularly on rest platforms and inspection platforms,
- c) access from ground to the foot of the lowest ladder or to the chassis of the crane,
- d) access from levels of the construction to the crane.

Where the crane cab level is in excess of 30 m from the ground and there is no access from a supporting building, it is recommended to have a crane lift or an elevating control station.

6.5.3 Instruction of personnel

ISO 12480-1:1997, 6.5.3, shall apply.

6.5.4 Jib and counter jib access

Access to and along jibs and counter jibs for inspection and servicing shall be made safe. Catwalks shall be provided with handrails or safety line in accordance with ISO 11660-3. Where lifelines are provided, a suitable device shall be used in conjunction with the harness to permit full passage along the jib without detachment.

NOTE Personal carrying cages attached to the trolley may provide suitable alternative safe access along the jib.

6.5.5 Cab safety

The appointed person should verify that

- a) vision panels in the floor of cabs or at the operator's feet are maintained to ensure that they are able to withstand all or part of the operator's weight, are guarded, for example, by a mesh of adequate strength to carry a person's weight over the area concerned,
- b) window panels in walls of cabs are maintained to ensure that they protect against being knocked outwards to prevent persons falling through the aperture, and
- c) panoramic and similar cabs of which the top part may be opened conform to national requirements as appropriate.

6.6 Fire extinguishers

ISO 12480-1:1997, 6.6, shall apply.

Tower cranes shall be equipped with appropriate types and quantities of fire extinguishers, which shall be easily accessible to the operator.

The operator and any other personnel likely to be in the cab should be adequately trained in the use of such fire extinguishers.

6.7 Documentation

For rated capacity charts, instruction manuals and test and examination certificates and reports ISO 12480-1 shall apply.

The plan or method details for the erection of tower cranes should be retained throughout the duration of a crane's service on any one contract, together with calculations and plans for the tower crane base.

NOTE It may be necessary to refer to these in the event of a change of construction in the course of the contract requiring alterations to be made to the crane.

6.8 Crane operator's aids

Tower cranes should be provided with the following as applicable:

- a) rated capacity limiter;
- b) load radius indicator;
- c) motion limiting devices;
- d) overload cut-out devices;
- e) level indicator;
- f) anemometer;
- g) working space limiters.

Working space limiters may be applied to a single tower crane where there is an area which it shall not oversail during operation, or over which it shall not carry loads. The principal use of working space limiters, however, is where there are two or more cranes which may interfere with each other's freedom of movement. Such devices shall limit the slew, the trolley motion, or the travel motion of the crane to prevent collision, between the structure of one crane and the rope or load of another crane (see [Annex A](#)).

NOTE It may be considered preferable to have these devices equipped to warn or give information to the operator, rather than interfere with the operation of the crane.

Where trailing cables are used for communication between one crane and another, consideration shall be given to the means required to protect them adequately against interference or accidental damage.

6.9 Other safety provisions

6.9.1 Lightning protection

Tower cranes should be effectively earthed.

6.9.2 Ballast

When base or counterweight concrete ballast needs to be provided, it is important that the ballast shall either:

- a) have been constructed in accordance with the crane manufacturer's design and specification; or
- b) be of a design which has been approved by the crane manufacturer or competent engineer, and effectively secured to prevent accidental displacement or removal.

Only ballast blocks having markings showing their correct weight shall be used.

Since the counterweight ballast is at height and the blocks have a tendency to rub together during crane operation, precautions shall be taken to prevent concrete from falling.

6.9.3 Alarms

Rail mounted tower cranes should be fitted with an audible travel alarm, activated when the crane starts to travel.

6.9.4 Signboards

Signboards, decorations, outline lights, etc. can impose additional loading on the crane and shall not be fitted unless approved by the crane manufacturer.

Electrical supplies to such equipment shall be restricted to 55 V max. Wiring shall be protected against damage and shall not create a hazard to personnel.

7 Selection of tower cranes

Selection of a tower crane should be considered by taking the following into account:

- a) ISO 12480-1:1997, Clause 7;
- b) prevailing wind speeds, which can restrict the use of tower cranes in certain locations and may require limiting tower height or jib length;
- c) principal features of the common types of tower crane, as described in ISO 4306-3.

With a horizontal trolley jib, a suitable allowance needs to be made for deflection when calculating the clearance between adjacent cranes (see [4.1](#)).

With a luffing jib, due to the varying out-of-service conditions, particular care shall be taken to observe the manufacturer's instructions.

Consideration shall also be given to the dismantling of the crane once the structure is completed, especially for climbing cranes.

A mobile tower crane is particularly suitable when considerable inter-site mobility is required. Extra care shall be taken in ensuring that outriggers, jacks, etc., are adequately supported for their imposed loads.

Some very small capacity tower cranes are available on trailer mounts with pneumatic tyres. These machines need to be towed into position and shall be properly mounted on their outriggers or jacks before erection or use. The manufacturer's erection instructions shall be scrupulously observed and if the operator is to erect and dismantle this type of crane, he or she shall be specifically trained and have the attributes of an erector (see [5.6](#)).

Crawler mounted tower cranes without self-levelling shall be moved only in strict accordance with the manufacturer's instructions (within the slope tolerances specified). Particular care shall be taken to avoid collisions and to satisfy wind limitations.

Where cranes are available with remote controls, care shall be taken in their selection for the following reasons:

- a) the crane operator has no “feel” for the machine and could, under certain circumstances, be tempted to handle the machine more dangerously than if the crane were operated via a cabin control;
- b) infrared remote control may be unreliable on tower cranes if the receiving sensor rotates with the crane and thus loses alignment with the transmitter.

8 Siting of cranes

8.1 General

ISO 12480-1:1997, 8.1, shall apply. Attention is drawn to [4.1](#).

8.2 Crane standing or support conditions

8.2.1 General

ISO 12480-1:1997, 8.2, shall apply.

Where tower cranes are to be erected close to the foundations of existing buildings or buildings to be constructed, the appointed person shall ensure that the ground is consolidated as required by the designer.

Where disturbance to the ground has occurred in the construction of adjacent foundations, the designer shall be consulted to ensure that the integrity of the crane foundations are maintained.

When the crane is mounted on

- rails,
- special foundation anchors, or
- an expendable tower section, cast into a concrete foundation block,

It is important that this base is installed within the manufacturer’s tolerance of accuracy to ensure that the erected crane is within operational limits.

In certain circumstances a crane shall be tied to the structure it is constructing, or held by guy ropes for any one of the following reasons:

- a) to obtain a height in excess of the available free-standing height;
- b) to restrict the movement of the tower when available space is limited;
- c) to comply with the requirements of the occupiers of adjacent properties, e.g. railways.

In any of these cases the tying/guying arrangements should be in accordance with either the manufacturer’s approval or calculations carried out by a competent engineer, and shall be attached to a structure capable of withstanding the imposed loads.

8.2.2 Tower crane foundations

8.2.2.1 Expendable base blocks

Minimum dimensions for any expendable base block together with the overturning moment and other loading during operation and out-of-service conditions shall be as specified by the crane manufacturer.

Having obtained from the crane manufacturer the loads imposed by the crane (noting that these may be net and exclusive of any impact of safety factors), the foundation shall be designed by a competent engineer so that the ground bearing capacity is not exceeded.

Where the base design limits the free standing height of the crane, the maximum permitted free standing height shall be clearly stated.

8.2.2.2 Rail tracks for tower cranes

Rail track shall be made of suitable materials and strict control shall be exercised to ensure that it is not in any way abused.

Rail track requires expertise in its design, layout and installation, particularly if it is to be curved.

The area between the tracks shall never be used for the storage of materials or for access to, from or across the site. The total area of the rail tracks shall preferably be fenced off to prevent access by unauthorised persons.

If there needs to be a point at which vehicles cross the rail track, this shall be carefully controlled to prevent accidental collision, and precautions shall be taken to ensure that the track is not overloaded by the vehicles crossing it.

The gauge of rail tracks shall be maintained by suitable means, e.g. tie bars.

Rail tracks shall not be welded or subjected to heating unless authorized by a competent metallurgist.

End stops or buffers shall be positively fixed to the rail and precisely adjusted to ensure that the crane makes contact with both sides simultaneously. These end stops shall be shock absorbing or sprung, and shall be moved hard against the crane chassis if the machine is to be used in a static position for any period of time. Rail stops shall not be taken into account when calculating the stability of the machine.

Rail clamps which the crane manufacturer may provide to prevent the crane from rolling along the track in storm conditions shall be fitted whenever the machine is out-of-service. If clamps are not supplied, adequate means shall be adopted to achieve the same result.

Rail tracks of all types require periodic inspection (according to the manufacturer's recommendations, if available), and, should any defect or out-of-level become apparent, corrective action shall be instigated immediately.

8.2.2.3 Special base

Where the particular application calls for a special base arrangement, e.g. structural steelworks, then the appointed person shall ensure that the base is designed by a competent engineer, allowing for the loads imposed by the crane, as advised by the manufacturer.

8.3 Proximity hazards

ISO 12480-1:1997, 8.3, shall apply.

9 Erecting, dismantling and alteration of height

9.1 Planning

ISO 12480-1:1997, 9.1, shall apply.

The plan for the erection, alteration of height and particularly the dismantling of tower cranes requires careful consideration. Most organisations that erect tower cranes, either for themselves or for others, utilize some form of pro forma or check list to ensure that nothing has been overlooked at the planning stage.

A plan for the erection or dismantling of tower cranes shall be drawn up by a person or persons having actual experience of these operations. It is desirable that this information is available in advance of the operation so that the personnel concerned may familiarise themselves with the content. It is advisable to conduct a pre-operational meeting of the personnel concerned in order to review planned procedures and to assign duties. The plan shall deal with the following:

- a) the format in which the crane is to be transported to or from the site;
- b) the selection of cranes that will be required to assist in the erection/dismantling process, especially considering the removal of components from a height. For example, when removing a section such as a jib from an erected tower crane, the assisting crane will be carrying the entire load with no opportunity for safely replacing it once the attachment pins have been removed. In this case it may be desirable for the crane to have some excess capacity to allow for any error resulting in the sudden release of a component. Under no circumstances shall the crane used in the dismantling operation be used to break a load free. When required, a method of jacking or other means shall be used to prise the load free after the initial tension is taken by the crane.
- c) the availability of access to the site for the vehicles involved in transportation as well as the crane(s) used for erection;
- d) the ground conditions for the erecting crane;
- e) the free standing height to which the crane will be erected and the length of the jib;
- f) proximity hazards (attention is drawn to of ISO 12480-1:1997, 8.3);
- g) any specialized lifting gear that will be required in the course of this erection;
- h) liaison with occupiers of neighbouring properties;
- i) contact with local authorities or other bodies requiring statutory notification;
- j) arrangements for any necessary road closures;
- k) the provision of a radio licence where required, available from the appropriate authorities;
- l) the availability on site of a comprehensive maker's erection/dismantling/operation manual, in the language understood by the erection team.

The area in which a tower crane is to be erected, altered in height or dismantled shall be roped or fenced off and all personnel not immediately connected with this duty shall be excluded. It is advisable to conduct a pre-operational meeting of the personnel concerned to review planned procedures and to assign duties.

9.2 Identification of components

ISO 12480-1:1997, 9.2, shall apply.

9.3 Electrical supply

ISO 12480-1:1997, 9.3, shall apply.

9.4 Personnel

The erection, dismantling and alteration of the height of tower cranes shall be carried out by specialist personnel under the continuous control of the crane erection supervisor and in accordance with the manufacturer's instructions. This supervisor shall be given the authority to stop the operation if he or she considers such action is warranted by ground conditions, weather, obstruction or any other cause.

The crane erection supervisor shall be in close liaison with the site management and shall carefully consider any comments or warnings that management, any members of the site team, or any other appropriate person or body may make.

9.5 Control

In the case of erection, dismantling or alteration of height of tower cranes, the person appointed to control the lifting operation shall also take control of any additional crane which may be used in the course of such an operation, and be familiar with details of that crane, to facilitate the carrying out of the duties, as detailed in ISO 12480-1:1997, 4.2 and 4.3.

The appointed person shall also ensure that the operation is under the constant supervision of the crane erection supervisor.

9.6 Inspection before erection

All parts shall be inspected prior to erection to verify they belong to the crane being erected and are in good condition, free from defect.

Slinging points shall be identified for all components.

NOTE Under certain circumstances it may be advantageous to carry out an inspection of the tower crane before it is delivered from the supplier to the user, but an on-site inspection is still required.

9.7 Weather

Tower cranes shall not be erected altered in height or dismantled in weather conditions likely to affect the stability of the crane or its components, e.g. high winds (reference shall be made to the manufacturer's instructions for, the maximum permissible wind speed for these particular operations) or under conditions of impaired visibility, e.g. fog.

More stringent restrictions on wind speed apply to heightened cranes.

This type of work shall be avoided if the conditions (e.g. ice on component parts, walkways) are likely to endanger the erectors.

9.8 Manufacturer's erection, alteration of height and dismantling instructions

The crane manufacturer's instructions shall be closely followed. Any departures from the specified sequential procedure shall be approved by the designer or another competent engineer, to ensure stability of the crane and to ensure that structural and mechanical parts are not subjected to excessive loading. This is particularly important when a climbing frame is utilized to alter the working height of the crane.

NOTE Many tower crane manufacturers lay down specific inspections and checks to be carried out in their erection and dismantling manual. For example, it is important to ensure that the lubrication requirements of tower joint bolts with the specified grease/oil are met before applying torque.

9.9 Tower crane climbing

9.9.1 General

Tower crane climbing is the activity of altering the height of a tower crane using purpose built jacking equipment. The term "climbing" means increasing or decreasing the tower height.

For reasons of clarity, the two main methods of tower crane climbing are described in [Annex B](#).

It shall be noted that while most tower crane climbing systems utilize similar principles, as described in [Annex B](#), details vary between makes, types and models of tower cranes, crane towers and climbing frames. The specific manufacturer's instructions shall be taken into account under all circumstances.

9.9.2 Planning the climbing operation

A safe system of work shall be established and be followed when undertaking a tower crane climbing operation.

A safe system of work shall be drawn up and agreed by those persons involved in the climbing operation, e.g. those involved in planning, those undertaking the climbing operation, those who may be affected by the operation and those appointed to re-commission the re-configured crane upon completion of the climbing operation.

Under all circumstances the operation shall be properly planned and undertaken by competent persons, appropriately supervised. This operation shall be carried out in a safe manner.

9.9.3 Appointed person

The appointed person shall maintain overall control of the planning and delivery of the climbing operation. The appointed person shall be competent to undertake such responsibilities and be fully conversant with the relevant manufacturer's instructions.

The appointed person shall consider all the risks associated with the climbing operation, draw up an effective operational plan and ensure that

- a) the crane support foundations or structures are of adequate strength to support the new crane configuration and, in all circumstances, in accordance with the crane manufacturer's instructions,
- b) the climbing operation will be phased effectively and not be affected by any other construction activity,
- c) the requirements of adjacent occupiers, e.g. railways, airports, others in the vicinity, are accommodated, and that these occupiers are kept informed,
- d) the crane coordinator is consulted when other cranes are being operated in the vicinity,
- e) the crane to be reconfigured is maintained in an efficient state, in efficient working order and in good repair,
- f) any equipment to be used during the operation will be made readily available and maintained in an efficient state, in efficient working order and in good repair,
- g) an erection supervisor is appointed who is competent to undertake the operation, is fully conversant with the safe system of work/operational plan and the manufacturer's instructions for the specific type and model of crane, crane tower and climbing frame involved in the operation,
- h) special emergency or rescue services that may be required are made available, and
- i) the current manufacturer's manuals for the specific crane, crane tower and climbing frame involved in the operation are available to the erection team for the duration of the climbing operation.

9.9.4 Erection supervisor

The erection supervisor is the person appointed to be in control of the team of tower crane erectors who will undertake the operation. The erection supervisor shall have sufficient experience and additional skills to enable him to supervise, and take responsibility for, the team.

The erection supervisor shall carry out the following:

- a) ensure, prior to commencing the operation, that the erection team members are competent to undertake the operation in a safe manner, are fully conversant with the safe system of work/operational plan and with specific manufacturer's instructions for the specific type and model of crane and climbing frame involved in the operation;
- b) ensure, prior to commencing the operation, that all equipment to be used in the operation is checked and is in good order;
- c) confirm, prior to commencing the operation, that the crane to be reconfigured is in good order and free from any defect that may affect the operation. Specific attention should be paid to the condition of the climbing frame mounting arrangements and to ensuring that the tower is vertical and within manufacturer's accepted tolerances;
- d) confirm, prior to commencing the operation, that the weather conditions are not likely to affect the stability of the crane during the operation;
- e) ensure that effective levels of communication between all those involved in the operation are checked prior to the commencement and maintained at all times during the operation;
- f) ensure that the crane is maintained in the balanced state required by the manufacturer and the jib correctly aligned at all times during the operation;
- g) ensure that weather conditions are monitored during the operation. (In general terms, and not withstanding manufacturer's recommendations, climbing should not be undertaken when wind speeds exceed 12m/s).

9.9.5 Re-commissioning the crane upon completion of the climbing operation

When the climbing operation has been completed, and prior to returning the crane to service, an inspection by a competent person shall be undertaken. The inspection should include verification of all indicating and limiting devices. The inspection should confirm, if such be the case, that the crane has been re-configured correctly, is free from any defect which may affect its safe operation and is in fact safe to use. The results of the inspection should be detailed in a formal written report.

9.10 Components and materials

9.10.1 Interchangeability of components

The interchange of structural components between one tower crane type and another shall only be permitted if the manufacturer has given approval.

Having carried out such an interchange, a tower crane type shall be re-tested in its new combination, and the interchanged parts shall be specified on the test certificate.

9.10.2 Materials

Most tower crane parts are made from special steels and no repair or replacements other than manufacturer's specification shall be permitted.

Welding or other heat treatments shall be carried out under the manufacturer's specified conditions.

The re-use of high tensile bolts shall be strictly in accordance with the manufacturer's conditions.

High strength friction grip bolts shall not be re-used, except in accordance with the manufacturer's instructions.

Bolts used to secure slew races shall be renewed whenever they are removed except in accordance with the manufacturer's instructions. They shall only be tightened in accordance with the manufacturer's instructions.

10 Procedures and precautions

10.1 Crane operation

ISO 12480-1:1997, 10.1, shall apply.

10.2 Working on cranes

10.2.1 General

ISO 12480-1:1997, 10.2.1, shall apply.

For tower cranes likely to sway or slew in the wind, appropriate precautions shall be taken to prevent people from being displaced from their place of work, injured or trapped by such movement.

10.2.2 Permit to work system

ISO 12480-1:1997, 10.2.2, shall apply.

10.2.3 Periodic checks

Periodic checks should be carried out in accordance with ISO 9927-1.

10.2.4 Regular inspections

ISO 12480-1:1997, 10.2.4, shall apply.

10.2.5 Condition monitoring

ISO 12482 shall apply.

10.3 Reporting of defects and incidents

ISO 12480-1:1997, 10.3, shall apply.

10.4 Leaving the crane

When a tower crane is to be left unattended for even a short period, it is essential that the following precautions are carried out.

- a) No load shall be left on the hook, and all chains, slings, etc. shall be removed.
- b) The crane shall be put out of service in accordance with the manufacturer's instructions.

NOTE 1 In nearly every case, this will involve turning the jib downwind and taking some action to ensure that the slew brake is left off, so that the crane is free to slew in the wind.

NOTE 2 In the case of saddle jib cranes, it is usual practice to bring the trolley or carriage to a minimum radius position, when permitted by local authorities.

- c) In the case of luffing jib and similar cranes, the manufacturer's instructions concerning the angle of the jib for out-of-service purposes shall be strictly observed.

- d) Rail travelling cranes shall be well secured to the rails, to ensure that in the event of a high wind the crane cannot be blown accidentally along the rails. When left for long periods (e.g. overnight), the power supply to the crane shall be cut off and the door of the cab secured and locked;
- e) When a power supply is required to be maintained overnight for cab or control cabinet heaters, lights etc., separate arrangements shall be made for the isolation of the power supply to the machinery.

10.5 Working at heights

A safe system of work shall be used, in accordance with the relevant sections of ISO 12480-1:1997, 4.1.

11 Operating conditions

11.1 Rated capacity

ISO 12480-1:1997, 11.1, shall apply.

11.2 Operation and control

ISO 12480-1:1997, 11.2, shall apply.

As the most common variation in operation and control encountered between different makes and models of tower cranes is the procedure for stopping the slewing motion, it is essential that the crane operator is made aware of which method of carrying out this duty is applicable.

NOTE Failure to use the correct method can result in excessive structural stress on the crane as well as causing failure in the electrical systems.

It is strongly recommended that the largest practicable bold notice is displayed in the cab (in addition to the manufacturer's instruction book) detailing the method of stopping the slew.

11.3 Handling of loads near persons

ISO 12480-1:1997, 11.3, shall apply.

11.4 Multiple lifting

Tower cranes should not be used for multiple crane lifts, except as engineered lifts under special control procedures as set out by the manufacturer.

11.5 Special duties

11.5.1 General

ISO 12480-1:1997, 11.5.1, shall apply.

11.5.2 Grabbing and magnet crane service

Tower cranes should not be used for carrying out special duties such as grabbing or lifting by magnet, except as approved by the manufacturer.

NOTE The manufacturer may recommend some de-rating of cranes for this duty.

11.5.3 Demolition and other special operations

Tower cranes should not be used for balling operations, pile driving, or extracting.

11.6 Weather conditions

11.6.1 General

ISO 12480-1:1997, 11.6.1, shall apply.

See also [9.7](#).

More stringent restrictions on wind speed apply to heightened cranes. This type of work shall be avoided if the conditions (e.g. ice on component parts, walkways) are likely to endanger the erectors.

11.6.2 Wind

ISO 12480-1:1997, 11.6.2, shall apply.

11.6.3 Visibility

ISO 12480-1:1997, 11.6.3, shall apply.

11.6.4 Rain, snow or ice

ISO 12480-1:1997, 11.6.3, shall apply.

Heavy accumulations of ice can make access along the jib extremely hazardous, and under these conditions consideration shall be given to not starting work with the crane until the temperature has risen sufficiently to cause a natural thaw. Personnel in the vicinity shall be warned of the likelihood of large lumps of ice falling during the thawing.

NOTE Horizontal jib tower cranes are more prone to excessive loading from snow and ice than most other types of crane.

When there has been an excessively heavy fall of snow this shall be carefully removed from the jib and counterweight jib before putting the crane into service.

11.6.5 Inspection following adverse weather conditions

After exposure to weather conditions in excess of manufacturer's published limitations for a crane, the anchorage arrangements and ballast shall be examined by a competent person as soon as practicable and before the crane is used, and any necessary steps taken to ensure the stability of the crane.

While the above inspection is being carried out the whole structure shall be adequately thoroughly inspected to ensure that it has not suffered any damage or condition likely to lead to failure in the course of bad weather.

ISO 9927-3:2005, Clause 7, shall apply.

12 Slinging and handling of loads

ISO 12480-1:1997, Clause 12, shall apply.

13 Raising and lowering of persons

ISO 12480-1:1997, Clause 13, shall apply.

Due to the extra height often involved, special care shall be taken to prevent the swing of the cradle carrying personnel, which could, in turn, cause the cradle to spin. It is not generally practicable to attach a tag line or similar equipment to such a cradle, and it is suggested that a cradle which is rectangular or

square in plan would be easier to control when bringing it alongside a structure or building on which the occupants may be required to work.

Care shall be taken to ensure that the cradle is kept clean and in good condition and is not used to carry any tools, loads or equipment which may make a foothold difficult for the occupants.

14 Tests, inspections and condition monitoring

14.1 General

ISO 12480-1:1997, Clause 14, shall apply.

14.2 Age and utilization

Tower cranes are not designed for a high intensity of usage. If a tower crane has been subjected to such usage, consideration shall be given to the use of non-destructive testing to detect possible fatigue cracking. The assistance of the manufacturer or design authority shall be sought to determine the vulnerable parts of the structure.

Usage or storage of the crane in a corrosive environment may also cause deterioration of the crane structure and this may require more extensive examination.

Fatigue damage and corrosion are also likely to be present on older tower cranes, which may require more detailed examination and testing as described above.

Older cranes may remain serviceable, but particular attention shall be given to these aspects on cranes more than 10 years old.

14.3 Personnel safety

Attention is drawn to the fact that a test may fail and all personnel not essential for the test shall be kept away from the area. Where a crane is equipped with a remote control, the test shall be carried out using the remote control, with the operator outside the danger zone.

A clamp or similar device shall be attached to the jib to limit the radius of the trolley when carrying out a maximum load test. Where safe access is not available to fit or remove the clamping device alternative safe means of limiting the radius of the trolley shall be adopted.

15 Signalling systems

15.1 General

Copies of the hand signals to be used shall be issued to all crane operators, slingers and other personnel involved in the carrying out of a lifting operation to ensure that a universal signalling code is used.

In situations where special lifts are involved or where hand signals alone are inadequate, other forms of communication shall be used, by means of either radio or telephone, to supplement the hand signal.

When radio is used as a means of signalling, the channel selected shall be kept clear of all other communications. All personnel involved in the signalling shall be given a clear and unique call sign and all communications shall be preceded by this call sign.

During the carrying out of the lifting operation, hand signals and any voice instruction to the crane operator shall only be given by one person at a time.

Due to the distance between tower cranes and other personnel it is important that clear systems of identification and communication are used.

Attention is drawn to ISO 12480-1:1997, 6.2.

15.2 Radio communications

Radio installation and operation in tower crane activities calls for the observance of special requirements.

It is recommended that reference is made to the appropriate local or national body responsible for radio communication to ensure compliance with any regulations, licensing requirements and the use of safe radio techniques by signalling systems, special techniques, call signs, frequencies, etc.

Annex A (normative)

Requirements for provision of working space limiters and anti-collision devices

A.1 General

This annex specifies the requirements concerning the installation on a tower crane of working space limiters (e.g. forbidden overlying, fixed obstacles) as well as anti-collision devices (overlapping cranes).

A.2 Power supply

A.2.1 Working -space limiter

As the working space limiter is not to be operated independently from the crane, when the crane power supply is cut the supply to the working space limiter shall be automatically cut at the same time.

A.2.2 Anti-collision device

As the anti-collision device shall function when the crane is not in use, its power supply shall allow the anti-collision device to operate when the supply to the mechanisms and crane controls has been cut.

A.3 Requirement

Tower cranes shall be designed and constructed such that they can be equipped with working space limiters and/or anti-collision devices. However, for tower cranes with automatic erection, of small capacity (lower than or equal to 30 m.t), this requirement is limited to the possibility of fitting slewing and trolleying limiters (these limiters allow prohibition of an access area to the hook).

Therefore, the tower cranes will be either

- a) equipped in order to receive a device available as an option,
- b) equipped with sensors delivering the information necessary for the functioning of the device, or
- c) provided with reference points or pick-up points for the sensors as in b).

The crane manufacturer shall determine the connection points necessary for the action of the device on the movements or function of the crane.

The choice of these points of connection shall be such that the actions of the device are compatible with the normal use of the crane mechanisms (decelerating before stopping the movement with high inertia, application of the mechanical brakes). In particular, it shall use the starting and stopping procedures provided by the crane manufacturer so as not to introduce excessive transient operation.

All the connection points necessary for the action of the device on the movement of the crane shall be assembled in a specific control box or on a special terminal strip. This control box or terminal strip is not required for tower cranes initially equipped with an anti-collision device.

A.4 Signalling

The space for the signal display shall be within the crane operator's field of vision. This signalling can be carried out by means of the signal lamps, display on dial or screen.

A.5 Instructions

A.5.1 Installation of the cranes (see [Figure A.1](#))

These instructions shall

- a) remind the crane erector/operator to install the crane such that the following hazards are avoided:
 - risks of collision between the moving crane and the fixed obstacles;
 - risks of overflying critical or forbidden areas;
 - risks of collision between various cranes in motion due to
 - contact between the hoist rope of a high crane and the counter-jib of the crane overflown,
 - contact between the hoist rope of a high crane and the jib of the crane overflown,
 - contact between the jib and/or the counter-jib of the lower crane and the tower of a high crane in the case of cranes travelling on the same track or on tracks which are very close to each other.
- b) otherwise remind the crane erector/operator that it is necessary to mitigate these hazards by the installation of working -space limiter and/or anti-collision devices,
- c) recommend that in the case of contact between the hoist rope of a high crane and the counter-jib of a crane over flown, the volume over flown by the counter-jib should be considered as a forbidden zone.

A.5.2 Information necessary for the correct installation of the device

Specify, in particular, the following.

- Power supply of the device: if provided by the crane manufacturer, the characteristics of this supply (voltage, power, earthing, etc.)
- Information required for the functioning of the device:
 - 1) if the information required by the device is available on the crane, indicate their characteristics and possibly the connecting points [see [A.3 b](#)];
 - 2) if the information required by the device is *not* available on the crane, indicate the possibilities for fixing the sensors and the characteristics of reference or pick-up points (kind and characteristics of the signals emitted by the sensors and kind and characteristics of the pick-off of the movements and corresponding characteristics) [see [A.3 c](#)].
- Action of the device on the crane: indicate the connecting points, the characteristics of the connections which are necessary for the action of the device on the movements or functions of the crane.

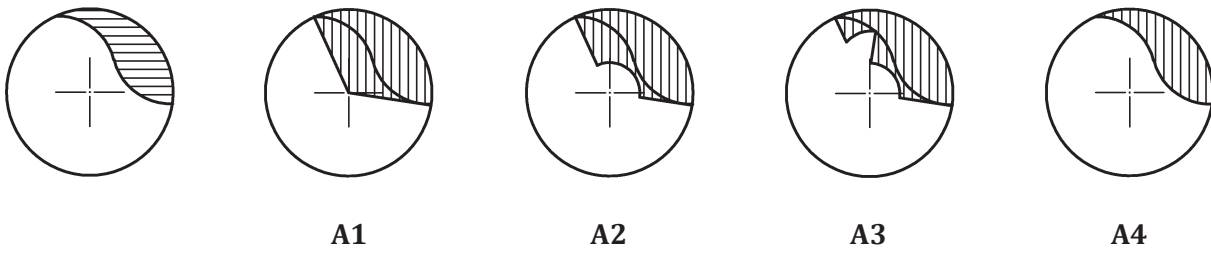

A: prohibited area

Prohibition of access to

- A1 a sector
- A2 an annular sector
- A3 several annular sectors
- A4 an equivalent profile area

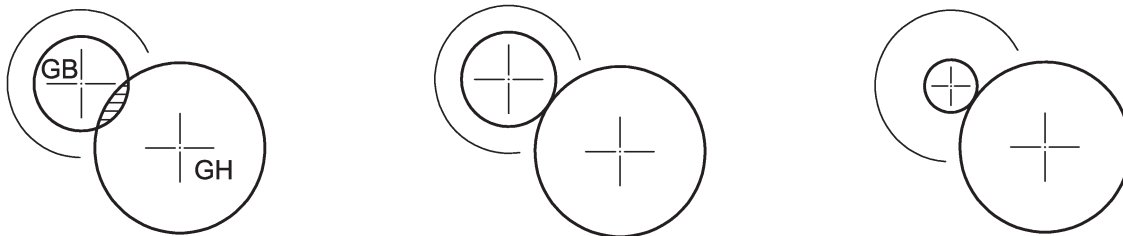

B: counter jib/rope

To be avoided by

- B1 modification of layout
- B2 selection of equipment

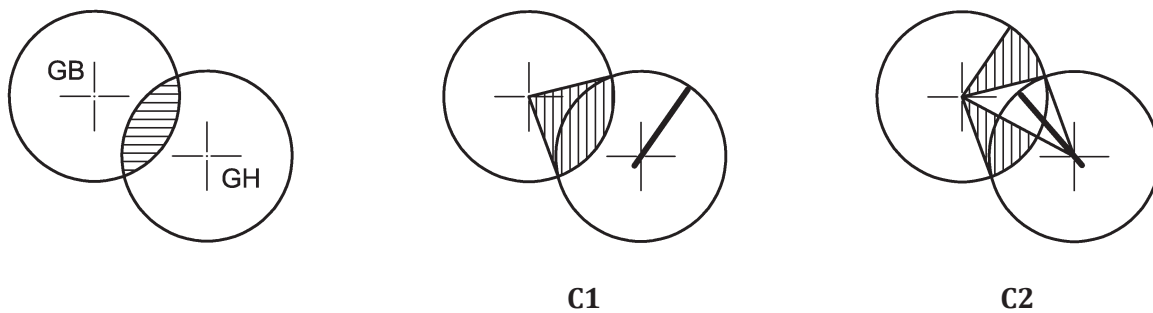

By prohibited access for the lower crane (as in A1):

- C1 whatever the position of the upper crane
- C2 taking into account the position of the jib of the upper crane

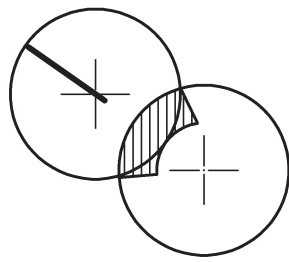

C3

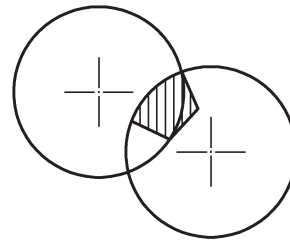

C4

By prohibited access for the upper crane:

C3 whatever the position of the lower jib crane

C4 taking into account the tie position of the jib of the lower crane

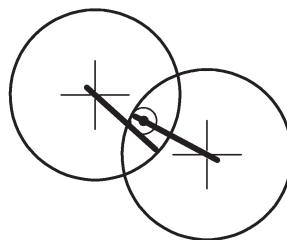

C5

By monitoring of the relative position of jib of the lower crane and cable of the upper crane:

C5 tracking device

Key



overlapping area

GH upper crane



neutralized area

GB lower crane

Figure A.1 — Examples of overlapping situations and possible solutions

Annex B (informative)

Tower crane climbing operations

B.1 General

“Tower crane climbing” is the activity of altering the height of a tower crane using purpose built jacking equipment. The term “climbing” means increasing or decreasing the tower height.

The two main methods of tower crane climbing are defined as

- **external:** where the tower of a crane is extended by the use of a climbing frame jacking system to allow additional tower sections to be inserted (see [B.2](#)), and
- **internal:** where the tower crane is raised or lowered by the use of a jacking system acting directly onto the building on which the crane is supported (see [B.3](#)).

For reasons of clarity, the two main methods are described in general terms below.

It shall be noted that while most tower crane climbing systems utilize the principles described, details vary between makes, types and models of tower cranes. The manufacturer’s instructions for a specific crane shall be taken into account under all circumstances.

B.2 External climbing operation

A typical climbing frame consists of a lattice steel frame with one open side, a tower section transfer device and a jacking rig in the form of a lifting cylinder assembly. The frame surrounds three sides of the crane tower and incorporates, on the open side, means of holding a new tower section prior to installation [[Figure B.1 a](#)].

At the start of a typical climbing operation, the climbing frame is secured to the underside of the crane slew section and the foot of the lifting cylinder assembly is located on the reaction points on the crane tower [[Figure B.1 b](#)].

A new tower section is then lifted by the crane and transferred onto the climbing frame [[Figure B.1 c](#)]. The crane shall then be configured to ensure that the turning moment on the climbing frame is kept to a minimum in so far as the superstructure of the crane is balanced about the centre line of the lifting cylinder and the jib correctly aligned.

The lifting cylinder is then pressurized to take the weight of the crane superstructure, allowing the fastenings connecting the superstructure of the crane to the uppermost tower section to be removed. The lifting cylinder is then extended to lift the crane superstructure a sufficient distance to accommodate the new tower section [[Figure B.1 d](#)]. With the lifting cylinder and climbing frame sufficiently extended, the new tower section is transferred into the frame and aligned with the crane tower [[Figure B.1 e](#)]. The lifting cylinder and frame is then lowered until the fixings on the crane superstructure engage and are secured to the top of the new tower section. The transfer device is withdrawn [[Figure B.1 f](#)] and the crane superstructure with new tower section is further lowered in order to allow the lower fixings to engage and be secured to the existing tower [[Figure B.1 g](#)].

Further tower sections may be added by realigning the climbing frame and repeating the operation in a similar manner [[Figures B.1 h](#) and [i](#)].

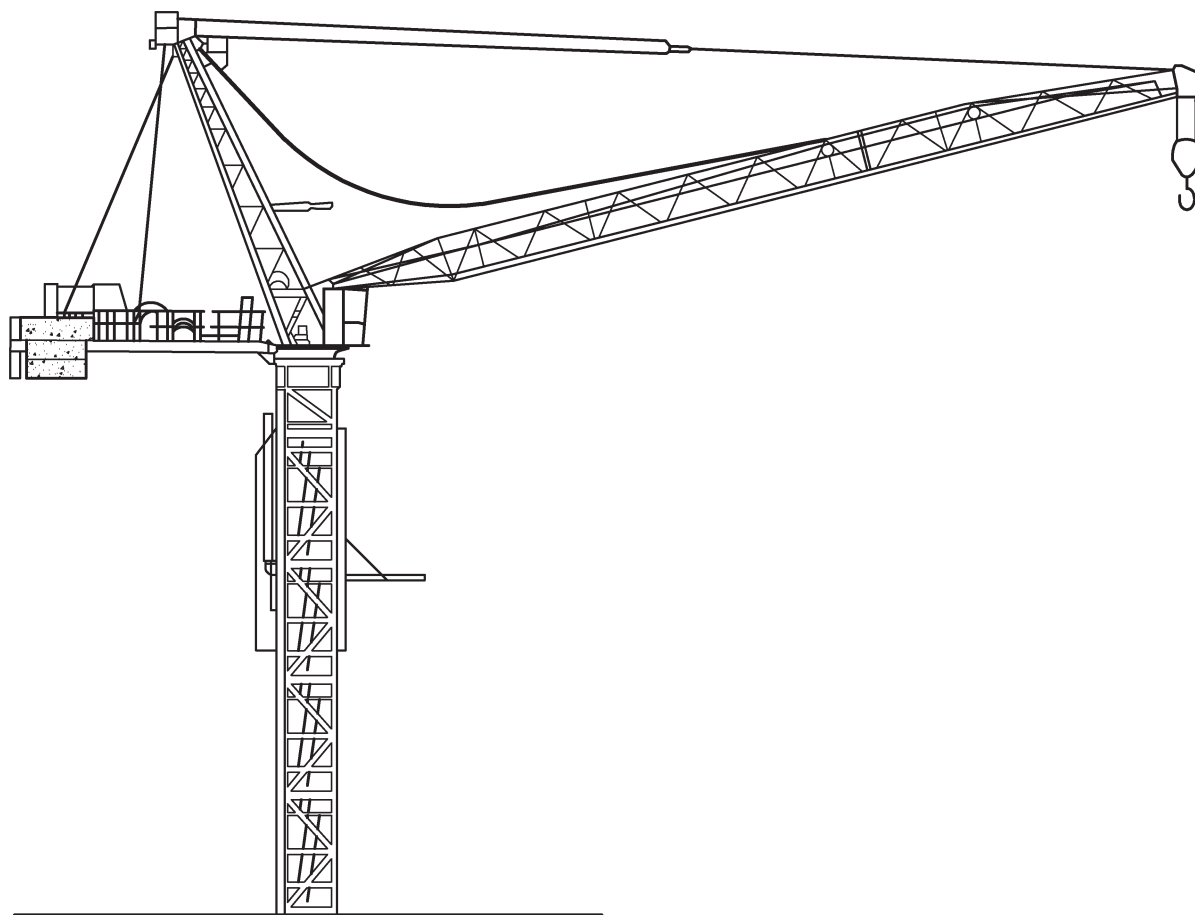

a)

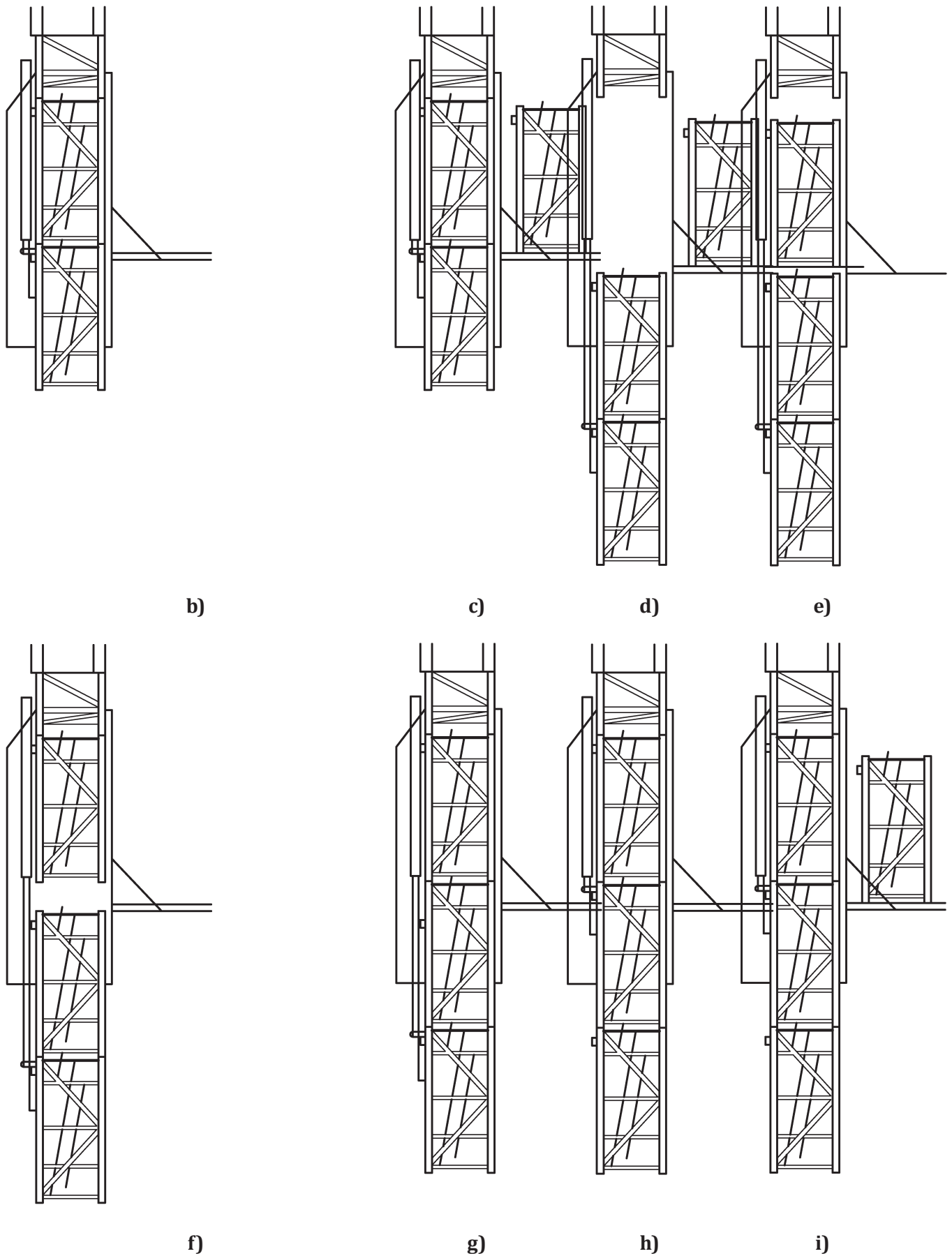
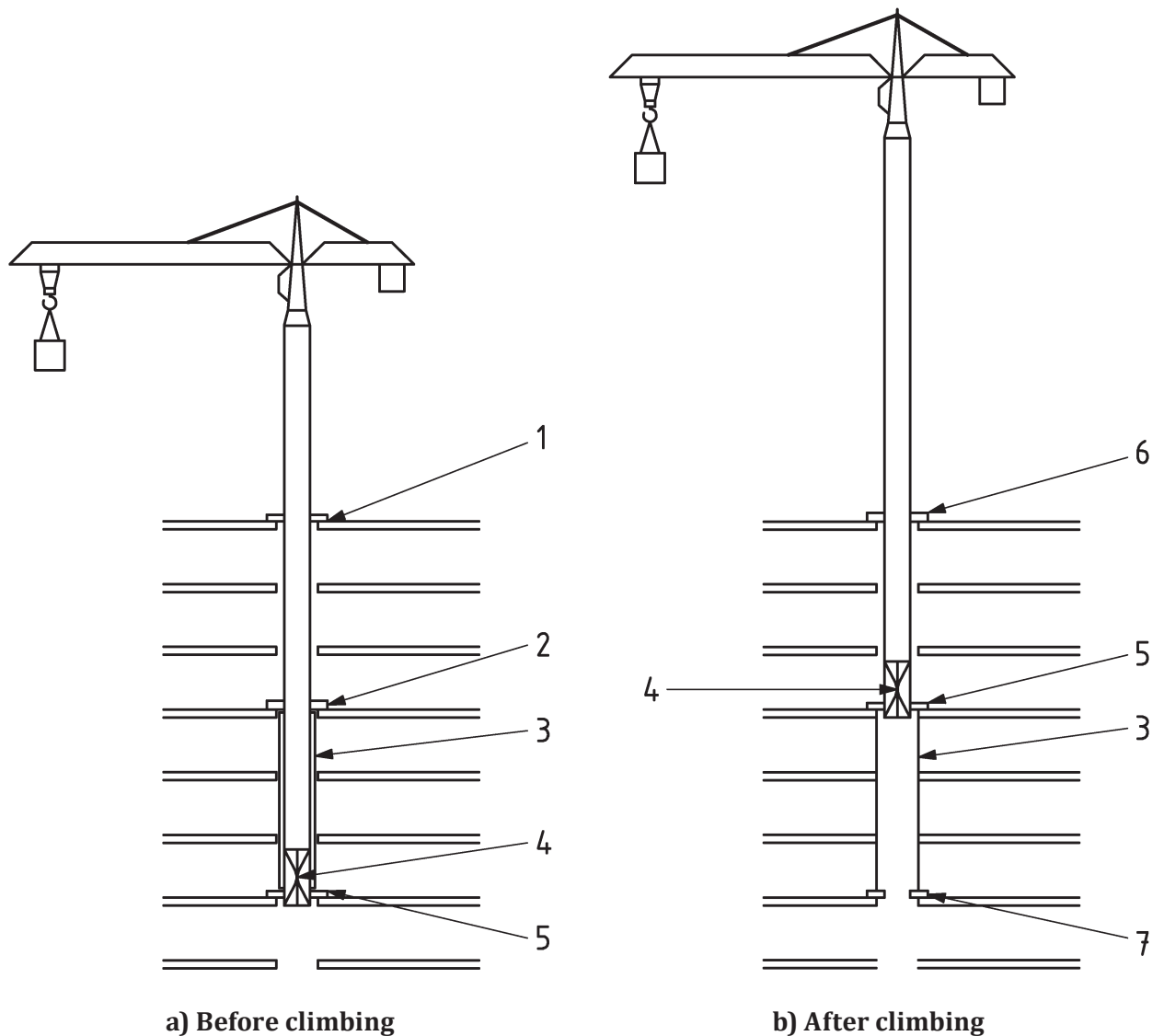

Figure B.1 — Typical climbing sequence

B.3 Internal climbing operation

When a tower crane is located and supported inside a building under construction it may be climbed up inside the structure as construction progresses. This process is known as “internal climbing”. See [Figure B.2](#).



Key

- 1 new top collar (installed before climbing)
- 2 middle (previously top) collar
- 3 climbing support
- 4 climbing section and hydraulic device
- 5 bottom collar
- 6 top collar
- 7 old bottom collar (for removal)

Figure B.2 — Internal climbing

The tower crane is supported by two collars. When the crane is installed the tower is clamped to both collars allowing the working forces generated by the crane to be transferred through the collars and into the building structure.

To “climb” the crane up to the next level an additional collar is assembled around the crane tower at a suitable distance above the top collar. The crane is then configured to ensure that the turning moment imparted by the crane superstructure is kept to a minimum after which the devices clamping the tower to the collars are released and the crane raised using a climbing section and a hydraulic device at the bottom of the tower. Once the tower has reached the middle collar, the tower is clamped to the middle and top collars. The bottom collar may then be removed and used for the next climbing operation

British Standards Institution (BSI)

BSI is the national body responsible for preparing British Standards and other standards-related publications, information and services.

BSI is incorporated by Royal Charter. British Standards and other standardization products are published by BSI Standards Limited.

About us

We bring together business, industry, government, consumers, innovators and others to shape their combined experience and expertise into standards-based solutions.

The knowledge embodied in our standards has been carefully assembled in a dependable format and refined through our open consultation process. Organizations of all sizes and across all sectors choose standards to help them achieve their goals.

Information on standards

We can provide you with the knowledge that your organization needs to succeed. Find out more about British Standards by visiting our website at bsigroup.com/standards or contacting our Customer Services team or Knowledge Centre.

Buying standards

You can buy and download PDF versions of BSI publications, including British and adopted European and international standards, through our website at bsigroup.com/shop, where hard copies can also be purchased.

If you need international and foreign standards from other Standards Development Organizations, hard copies can be ordered from our Customer Services team.

Copyright in BSI publications

All the content in BSI publications, including British Standards, is the property of and copyrighted by BSI or some person or entity that owns copyright in the information used (such as the international standardization bodies) and has formally licensed such information to BSI for commercial publication and use.

Save for the provisions below, you may not transfer, share or disseminate any portion of the standard to any other person. You may not adapt, distribute, commercially exploit, or publicly display the standard or any portion thereof in any manner whatsoever without BSI's prior written consent.

Storing and using standards

Standards purchased in soft copy format:

- A British Standard purchased in soft copy format is licensed to a sole named user for personal or internal company use only.
- The standard may be stored on more than 1 device provided that it is accessible by the sole named user only and that only 1 copy is accessed at any one time.
- A single paper copy may be printed for personal or internal company use only.

Standards purchased in hard copy format:

- A British Standard purchased in hard copy format is for personal or internal company use only.
- It may not be further reproduced – in any format – to create an additional copy. This includes scanning of the document.

If you need more than 1 copy of the document, or if you wish to share the document on an internal network, you can save money by choosing a subscription product (see 'Subscriptions').

Reproducing extracts

For permission to reproduce content from BSI publications contact the BSI Copyright & Licensing team.

Subscriptions

Our range of subscription services are designed to make using standards easier for you. For further information on our subscription products go to bsigroup.com/subscriptions.

With **British Standards Online (BSOL)** you'll have instant access to over 55,000 British and adopted European and international standards from your desktop. It's available 24/7 and is refreshed daily so you'll always be up to date.

You can keep in touch with standards developments and receive substantial discounts on the purchase price of standards, both in single copy and subscription format, by becoming a **BSI Subscribing Member**.

PLUS is an updating service exclusive to BSI Subscribing Members. You will automatically receive the latest hard copy of your standards when they're revised or replaced.

To find out more about becoming a BSI Subscribing Member and the benefits of membership, please visit bsigroup.com/shop.

With a **Multi-User Network Licence (MUNL)** you are able to host standards publications on your intranet. Licences can cover as few or as many users as you wish. With updates supplied as soon as they're available, you can be sure your documentation is current. For further information, email subscriptions@bsigroup.com.

Revisions

Our British Standards and other publications are updated by amendment or revision.

We continually improve the quality of our products and services to benefit your business. If you find an inaccuracy or ambiguity within a British Standard or other BSI publication please inform the Knowledge Centre.

Useful Contacts

Customer Services

Tel: +44 345 086 9001

Email (orders): orders@bsigroup.com

Email (enquiries): cservices@bsigroup.com

Subscriptions

Tel: +44 345 086 9001

Email: subscriptions@bsigroup.com

Knowledge Centre

Tel: +44 20 8996 7004

Email: knowledgecentre@bsigroup.com

Copyright & Licensing

Tel: +44 20 8996 7070

Email: copyright@bsigroup.com

BSI Group Headquarters

389 Chiswick High Road London W4 4AL UK