



BSI Standards Publication

# Tractors, machinery for agriculture and forestry, powered lawn and garden equipment — Safety signs and hazard pictorials — General principles

AS PERMITTED BY COPYRIGHT LAW



TM

**National foreword**

This British Standard is the UK implementation of ISO 11684:1995.

The UK participation in its preparation was entrusted to Technical Committee AGE/6, Agricultural tractors and forestry machinery.

A list of organizations represented on this committee can be obtained on request to its secretary.

This publication does not purport to include all the necessary provisions of a contract. Users are responsible for its correct application.

© BSI 2010

ISBN 978 0 580 71623 2

ICS 65.060.01; 65.060.70

**Compliance with a British Standard cannot confer immunity from legal obligations.**

This British Standard was published under the authority of the Standards Policy and Strategy Committee on 31 July 2010.

**Amendments issued since publication**

Date	Text affected
------	---------------

---



INTERNATIONAL  
STANDARD

**ISO**  
**11684**

First edition  
1995-01-15

---

---

**Tractors, machinery for agriculture and  
forestry, powered lawn and garden  
equipment — Safety signs and hazard  
pictorials — General principles**

*Tracteurs et matériels agricoles et forestiers, matériels à moteur pour  
jardins et pelouses— Signaux de sécurité et de danger — Principes  
généraux*



Reference number  
ISO 11684:1995(E)



## Foreword

ISO (the International Organization for Standardization) is a worldwide federation of national standards bodies (ISO member bodies). The work of preparing International Standards is normally carried out through ISO technical committees. Each member body interested in a subject for which a technical committee has been established has the right to be represented on that committee. International organizations, governmental and non-governmental, in liaison with ISO, also take part in the work. ISO collaborates closely with the International Electrotechnical Commission (IEC) on all matters of electrotechnical standardization.

Draft International Standards adopted by the technical committees are circulated to the member bodies for voting. Publication as an International Standard requires approval by at least 75 % of the member bodies casting a vote.

International Standard ISO 11684 was prepared by Technical Committee ISO/TC 23, *Tractors and machinery for agriculture and forestry*, Subcommittee SC 14, *Operator controls, operator symbols and other displays, operator manuals*.

© ISO 1995

All rights reserved. Unless otherwise specified, no part of this publication may be reproduced, stored in a retrieval system, or transmitted, in any form or by any means, electronic or mechanical, including photocopying and recording, or by any information storage or retrieval system, without the prior written permission of the publisher.

International  
Switzerland

This document is now  
**POOBLIC**

# Tractors, machinery for agriculture and forestry, powered lawn and garden equipment — Safety signs and hazard pictorials — General principles

## 1 Scope

This International Standard establishes general principles for the design and application of safety signs and hazard pictorials permanently affixed to tractors, machinery for agriculture and forestry, and powered lawn and garden equipment as defined in ISO 3339-0 and ISO 5395. This International Standard outlines safety sign objectives, describes the basic safety sign formats and colours, and provides guidance on developing the various panels that together constitute a safety sign.

## 2 Normative references

The following standards contain provisions which, through reference in this text, constitute provisions of this International Standard. At the time of publication, the editions indicated were valid. All standards are subject to revision, and parties to agreements based on this International Standard are encouraged to investigate the possibility of applying the most recent editions of the standards indicated below. Members of IEC and ISO maintain registers of currently valid International Standards.

ISO 3339-0:1986, *Tractors and machinery for agriculture and forestry — Part 0: Classification system and classification*

ISO 5395:1990, *Power lawn-mowers, lawn tractors, lawn and garden tractors, professional mowers, and lawn and garden tractors with mowing attachments — Definitions, safety requirements, and test procedures*

## 3 Risk reduction through design

**3.1** Safety should be integrated into machine design, manufacture, operation, instruction, and supervision. Risks should be reduced or eliminated so far as possible without unreasonable impairment of product function by

- eliminating or reducing hazards by suitable choice of design features and construction materials;
- limiting exposure of persons to hazards by reducing the need for operator intervention in hazardous areas;
- providing guards or other safety devices to protect persons from the hazards which cannot reasonably be eliminated or sufficiently limited by design.

**3.2** Even when appropriate design features and safety devices are incorporated into machinery, some residual risks may remain. Safety signs warn operators or other exposed persons about such residual risks.



## 4 Objectives of safety signs

4.1 The objectives of a safety sign are to

- Alert persons to an existing or potential hazard
- Identify the hazard
- Describe the nature of the hazard
- Explain the consequences of potential injury from the hazard
- Instruct persons about how to avoid the hazard

4.2 In achieving these objectives, a safety sign should be distinctive on the equipment, should be in a clearly visible location, should be protected to the greatest extent practicable from damage and obliteration, and should have a reasonably long life expectancy.

## 5 Formats for safety signs

5.1 A safety sign is composed of a border surrounding two or more rectangular panels that convey information about hazards associated with operation of a product.

5.2 There are four standard formats for safety signs:

- two-panel safety sign: signal panel, message panel (see 5.4);
- three-panel safety sign: signal panel, pictorial panel, message panel (see 5.5);
- two-panel safety sign: pictorial panel, message panel (see 5.6);
- two-panel safety sign: two pictorial panels (see 5.7).

5.3 A vertical configuration is usually preferred, although a horizontal configuration is acceptable. Final choice of safety sign format and configuration should be determined by whichever alternative is judged to communicate most effectively, by the geographical and language areas where the product will be marketed, by legal requirements, and by the space available for the safety sign.

5.4 **Two-panel safety signs: signal panel, message panel.** See figure 1. The signal panel contains the safety alert symbol and one of the three signal words (CAUTION, WARNING, DANGER). The message panel contains a text message that describes the hazard, explains the consequences of exposure to the hazard, and instructs how to avoid the hazard.

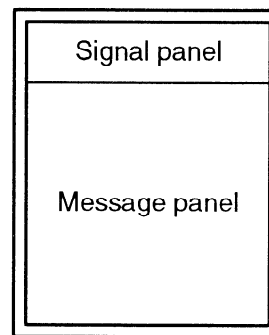

Vertical configuration

Figure 1 — Two-panel safety signs: signal panel, message panel



**5.5 Three-panel safety signs: signal panel, pictorial panel, message panel.** See figure 2. The signal panel contains the safety alert symbol and one of the three signal words. The pictorial panel contains a hazard description pictorial or, in some cases, a combined hazard description and hazard avoidance pictorial. The message panel contains a text message that describes the hazard, explains the consequences of exposure to the hazard, and instructs how to avoid the hazard.

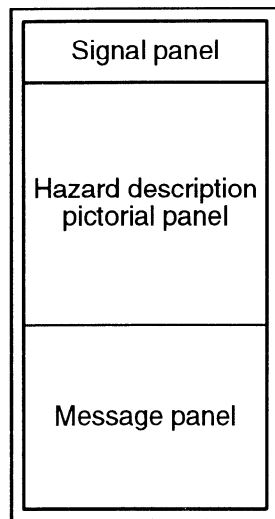

**Vertical configuration**

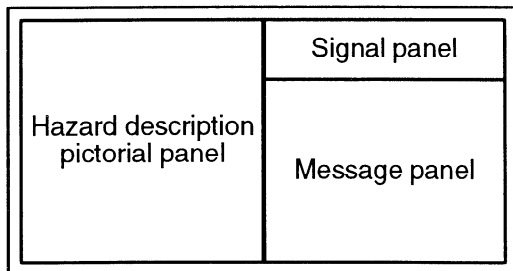

**Horizontal configuration**

**Figure 2 — Three-panel safety signs: signal panel, pictorial panel, message panel**

**5.6 Two-panel safety signs: pictorial panel, message panel.** See figure 3. The pictorial panel contains either a hazard description pictorial enclosed by the safety alert triangle or the safety alert symbol alone. The message panel contains a text message that describes the hazard, explains the consequences of exposure to the hazard, and instructs how to avoid the hazard.

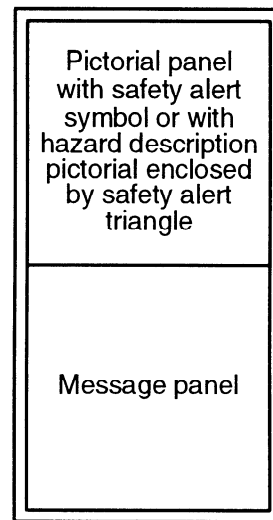

**Vertical configuration**

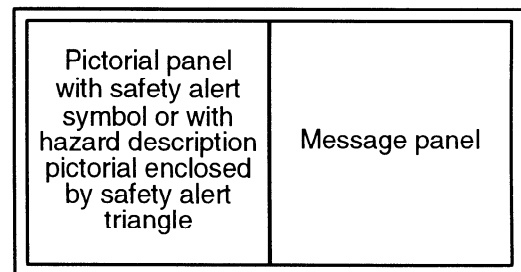

**Horizontal configuration**

**Figure 3 — Two-panel safety signs: pictorial panel, message panel**



**5.7 Two-panel safety signs: two pictorial panels.** See figure 4. The first pictorial panel is the hazard description pictorial panel and contains either a hazard description pictorial enclosed by the safety alert triangle or the safety alert symbol alone. The second pictorial panel is the hazard avoidance pictorial panel and contains a hazard avoidance pictorial.

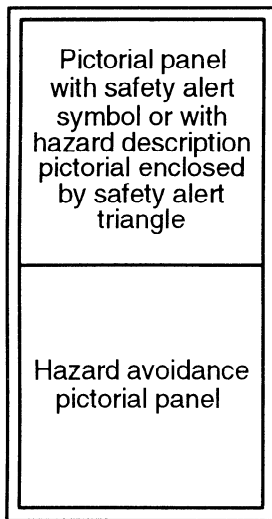

**Vertical configuration**

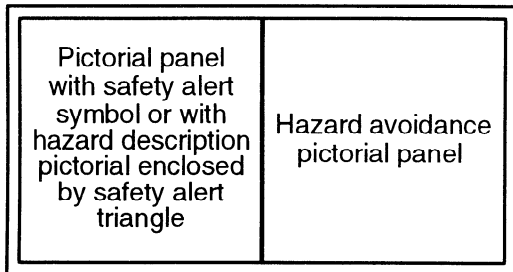

**Horizontal configuration**

**Figure 4 — Two-panel safety signs: two pictorial panels**

**5.8** Variations on these standard formats may be appropriate for some situations.

## 6 Signal panel

**6.1** The signal panel of a safety sign contains the safety alert symbol and one of the three signal words.

**6.2** The safety alert symbol for safety signs that contain one of the signal words shall be as shown in figure 5 and shall be used for safety signs that contain one of the three signal words.



**Figure 5 — Safety alert symbol for safety signs that contain a signal word**

**6.3** Safety signs may be classified according to the relative seriousness of the hazard situation by use of the signal word.

**6.3.1** There are three signal words: DANGER, WARNING, and CAUTION. The signal word alerts viewers to the existence and relative seriousness of a hazard.

**6.3.2** The three signal words are reserved for personal injury hazards. Choice of the signal word is based upon an estimate of the likelihood of exposure to the hazard and of the probable consequences of exposure to the hazard.

— **DANGER.** The signal word DANGER indicates an imminently hazardous situation which, if not avoided, will result in death or serious injury. Safety signs identified by the signal word DANGER should be used sparingly and only for those situations presenting the most serious hazards.





- **WARNING.** The signal word WARNING indicates a potentially hazardous situation which, if not avoided, could result in death or serious injury. Hazards identified by the signal word WARNING present a lesser degree of risk of injury or death than those identified by the signal word DANGER.
- **CAUTION.** The signal word CAUTION indicates a potentially hazardous situation which, if not avoided, may result in minor or moderate injury. CAUTION may also be used to alert against unsafe practices associated with events that could lead to personal injury.

## 7 Pictorial panels

7.1 A pictorial panel of a safety sign contains a hazard description pictorial, a hazard avoidance pictorial, or the safety alert symbol alone.

7.2 There are two basic types of pictorials for use on safety signs: hazard description and hazard avoidance.

- **Hazard description pictorial.** A hazard description pictorial presents a visual description of the hazard and, in general, the consequences of not avoiding the hazard.
- **Hazard avoidance pictorial.** A hazard avoidance pictorial presents visual instructions on how the hazard should be avoided.

7.2.1 A well developed hazard description pictorial should clearly identify the hazard and portray the potential consequences of a failure to follow instructions. A well developed hazard avoidance pictorial should clearly identify the actions necessary to avoid interaction of persons with the hazard.

7.2.2 It is possible that both types of pictorial may be combined into a single pictorial, although this generally is quite difficult. Most often, a hazard description pictorial is used. A hazard avoidance pictorial may be used to supplement or to replace the text message.

7.2.3 In a few cases, a pictorial may address more than one hazard. In general, however, avoid addressing more than one hazard by a single pictorial unless the hazards are closely related.

7.3 On two-panel safety signs, the hazard description pictorial shall be enclosed by the safety alert triangle to identify the sign as a safety sign. The safety alert triangle is shown in figure 6.

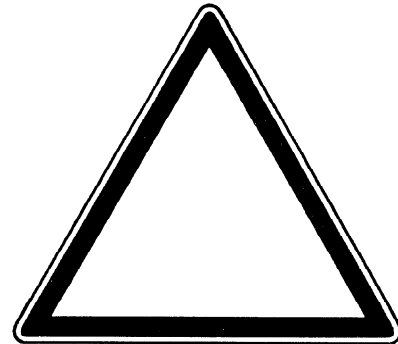

Figure 6 — Safety alert triangle

7.4 If no hazard description pictorial is used inside the safety alert triangle, an exclamation mark is placed within the triangle to create the outline safety alert symbol shown in figure 7.



Figure 7 — Outline safety alert symbol

## 8 Message panel

**8.1** The message panel of a safety sign contains a text message that, either alone or in combination with a pictorial panel, describes the hazard, explains the potential consequences of exposure to the hazard, and instructs how to avoid the hazard.

**8.2** If a hazard description pictorial adequately portrays the hazard and its potential consequences, one or both of these elements may be deleted from the message panel. If a hazard avoidance pictorial adequately portrays how to avoid the hazard, that element may be deleted from the message panel. If no pictorial is used, the message panel must convey all three elements. When possible, the message should be written in simple sentences not exceeding a few lines.

## 9 Languages, translations, and multi-language safety signs

**9.1** Safety signs that contain a signal word or a text message should be in one of the languages of the country where the product is to be used. Safety signs without text obviously require no language translation. However, products that use no-text safety signs require both of the following:

- A special safety sign that instructs the operator to consult the operator’s manual for an explanation of the safety signs applicable to that product.
- Appropriate text messages, corresponding to the no-text safety signs, printed in the operator’s manual in the appropriate language.

**9.2** Figure 8 shows, as an example, a four-language “Read operator’s manual” safety sign in German, French, English, and Dutch. Other language combinations, or a single language, are also permitted, so long as the safety sign includes the language of the geographical area where the product is to be used.

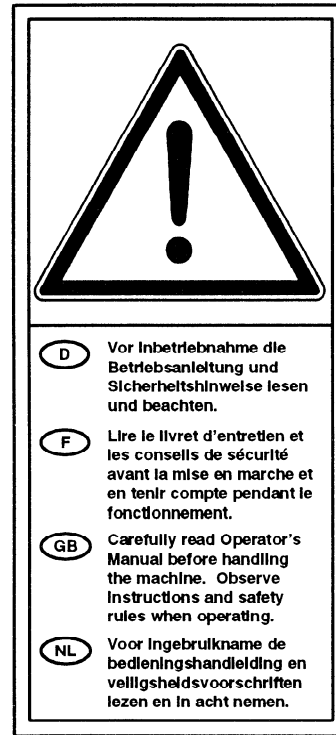

**Figure 8 — Example of four-language “Read operator’s manual” safety sign for use on products with no-text safety signs**



**9.3** Figure 9 shows the no-text “Read operator’s manual” safety sign. This safety sign may be used as an alternative to a single or multiple language safety sign of the type shown in figure 8.

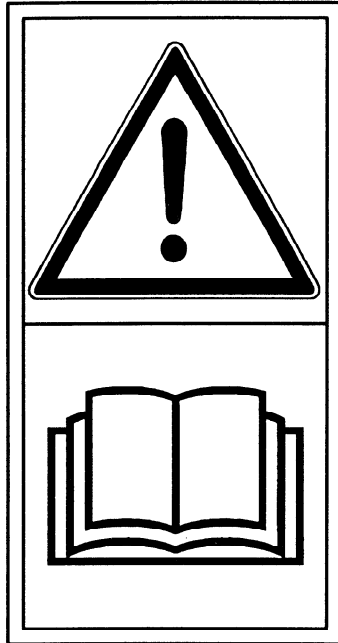

**Figure 9 — No-text “Read operator’s manual” safety sign for use on products with no-text safety signs**

## 10 Colours of safety signs

### 10.1 Colours of signal panel

The colour of the signal panel depends on the selection of the signal word.

**10.1.1** The signal panel of DANGER signs shall have a white signal word on a red background. The safety alert symbol shall have a red exclamation mark on a white background triangle (see figure 5).

**10.1.2** The signal panel of WARNING signs shall have a black signal word on an orange background. The safety alert symbol shall have an orange exclamation mark on a black background triangle (see figure 5).

**10.1.3** The signal panel of CAUTION signs shall have a black signal word on a yellow background. The safety alert symbol shall have a yellow exclamation mark on a black background (see figure 5).

### 10.2 Colours of pictorial panel

The colours of the pictorial panels depend on whether the safety sign contains one of the three signal words.

**10.2.1** Pictorial panels of safety signs that contain one of the three signal words shall have a black pictorial on a white background.

**10.2.2** Pictorial panels of safety signs that contain the safety alert triangle or the outline safety alert symbol shall have a black pictorial and triangle on a yellow background.

**10.2.3** Other colours (for example, red to indicate fire) may be used to emphasize specific aspects of the pictorial.

**10.2.4** If prohibition of an activity is indicated by **X** or **⊘** or the word **STOP** (see Annex D, clause D.9), the prohibition indicator shall be red.

### 10.3 Colours of message panel

The colours of the message panel depend on whether the safety sign contains one of the three signal words.

**10.3.1** The message panel of safety signs that contain a signal word shall have white letters on a black background or black letters on a white background.

**10.3.2** The message panel of safety signs that do not contain a signal word shall have black letters on a yellow background or black letters on a white background.

**10.4 Colour of border**

The colour of the border depends on the selection of the signal word and whether the safety sign contains the safety alert triangle.

**10.4.1** The border of DANGER signs shall be red. If necessary to differentiate the safety sign from the colour of the surface on which it is affixed, an additional outside border of white may be used.

**10.4.2** The border of WARNING signs shall be orange. If necessary to differentiate the safety sign from the colour of the surface on which it is affixed, an additional outside border of white or black may be used.

**10.4.3** The border of CAUTION signs shall be yellow. If necessary to differentiate the safety sign from the colour of the surface on which it is affixed, an additional outside border of white or black may be used.

**10.4.4** The border of safety signs that contain the safety alert triangle shall be yellow. If necessary to differentiate the safety sign from the colour of the surface on which it is affixed, an additional outside border of white or black may be used.

**10.5 Colour of panel separation lines**

Any panel separation lines shall be black.

**11 Dimensions**

Recommended dimensions in millimetres of safety signs are shown in figures 10 through 13. Smaller or larger sizes may be used as required. Proportions may be varied as necessary to provide a sufficiently large signal panel or to provide adequate space for the message panel to be set in a legible typesize.

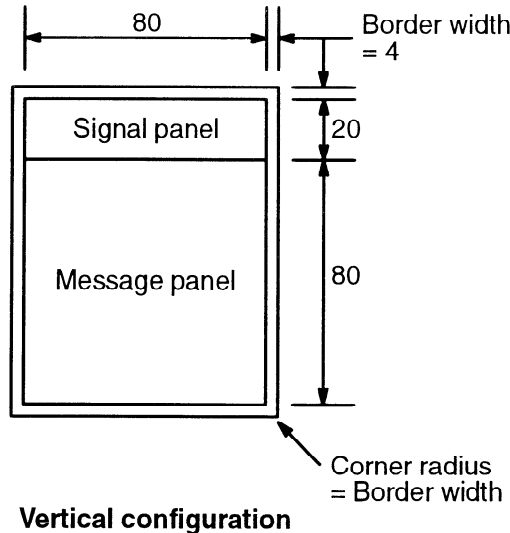

**Figure 10 — Recommended dimensions: two-panel format: signal panel, message panel**



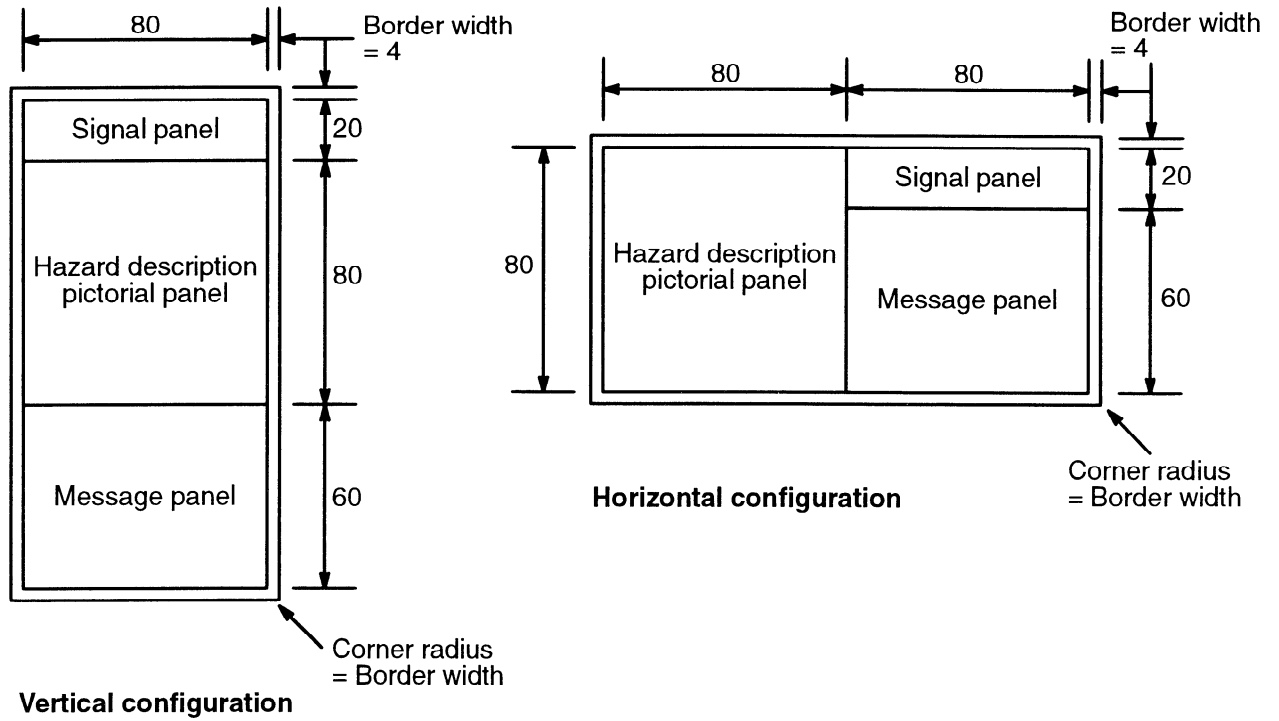

Figure 11 — Recommended dimensions: three-panel format: signal panel, pictorial panel, message panel

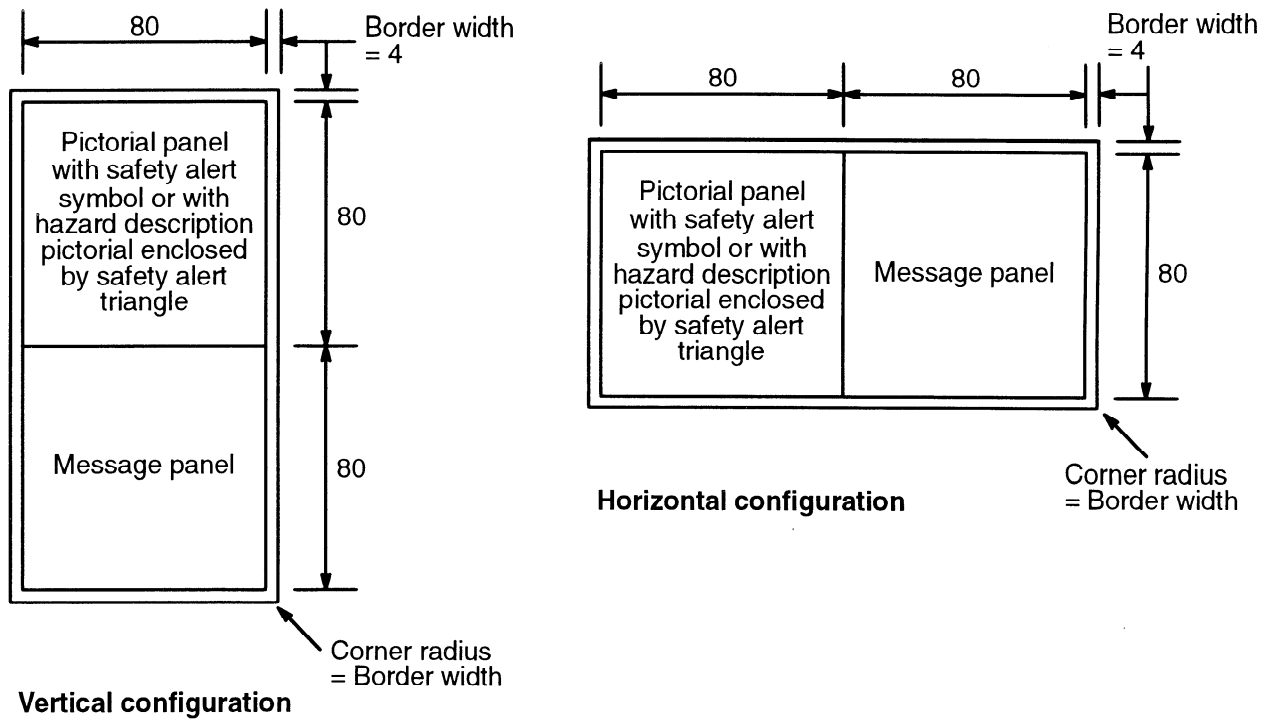

Figure 12 — Recommended dimensions: two-panel format: pictorial panel, message panel



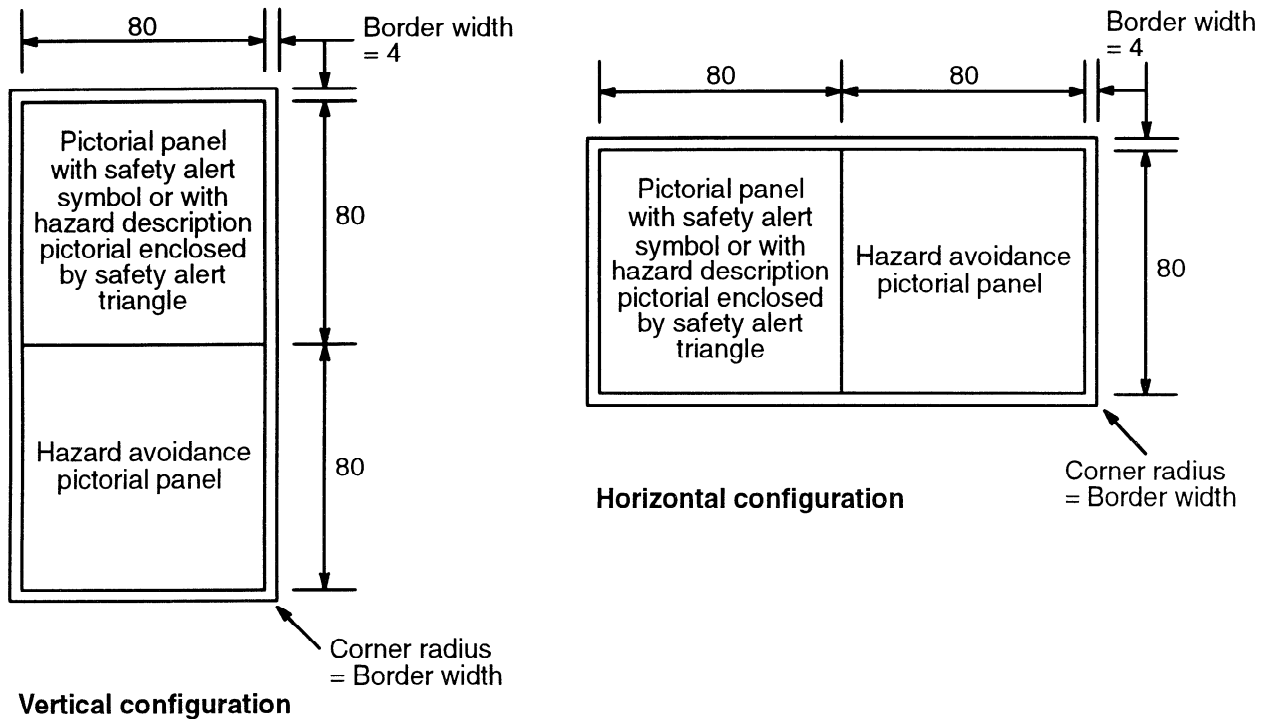

Figure 13 — Recommended dimensions: two-panel format: two pictorial panels

## 12 Hazard description pictorials

Annex A presents examples of hazard description pictorials intended for use on safety signs. Alternative hazard description pictorials may be used as appropriate, and additional hazard description pictorials may need to be developed.

## 13 Hazard avoidance pictorials

Annex B presents examples of hazard avoidance pictorials intended for use on safety signs. Alternative hazard avoidance pictorials may be used as appropriate, and additional hazard avoidance pictorials may need to be developed.

## 14 Examples of safety signs

### 14.1 Examples of safety signs with text

The signal word and text message appropriate to a hazard depend upon a combination of highly variable factors, including legal precedents. No detailed examples of safety signs with text are presented in this International Standard. Safety signs with text should be developed as necessary in conformance to the objectives and principles explained in preceding clauses of this International Standard.

### 14.2 Examples of safety signs without text

Annex C presents examples of no-text safety signs for a number of hazards. Additional safety signs may need to be developed for other hazards.

Uncontrolled Copy, (c) The British Standards Institution 2012





## 15 Principles and guidelines for graphical design of hazard pictorials

Annex D provides principles and guidelines for good graphical design of hazard pictorials as well as instructions for drawing the human figure and other pictorial elements. Good consistent visual design is important to conveying the meaning of both hazard description and hazard avoidance pictorials.



## Annex A

### Hazard description pictorials (informative)

#### A.1 Scope

This annex presents examples of hazard description pictorials intended for use on safety signs. Alternative hazard description pictorials may be used as appropriate, and additional hazard description pictorials may need to be developed.

#### A.2 Chemical (ingestion/burn) hazards

**A.2.1** Caustic liquids  
— Chemical burns to fingers or hand

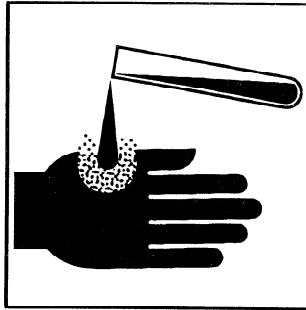

**A.2.2** Poisonous fumes or toxic gases  
— Asphyxiation

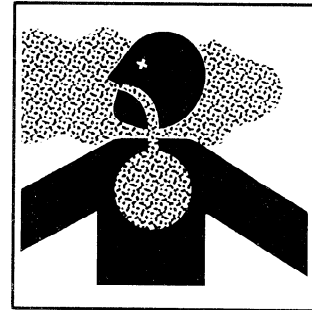

#### A.3 Electrical (shock/burn) hazards

**A.3.1** Electrical shock/electrocution

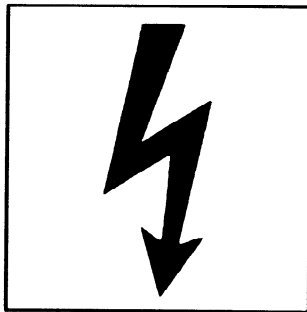

**A.3.3** Electrical shock/electrocution



**A.3.2** Electrical shock/electrocution

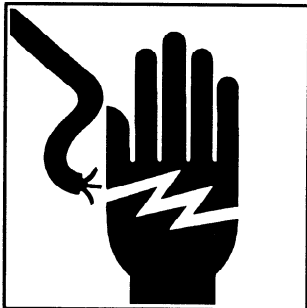

**A.3.4** Electrical shock/electrocution  
— Row marker

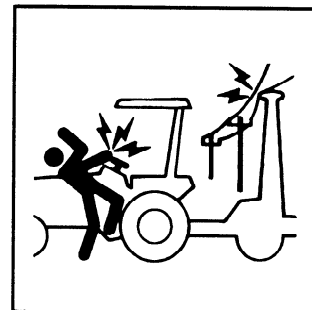

**A.3.5** Electrical shock/electrocution  
— High clearance sprayer

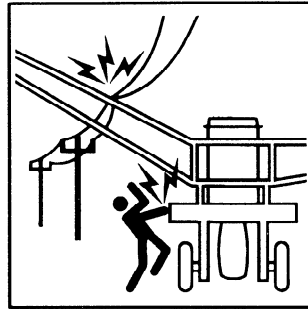

**A.3.7** Electrical shock/electrocution  
— Loader

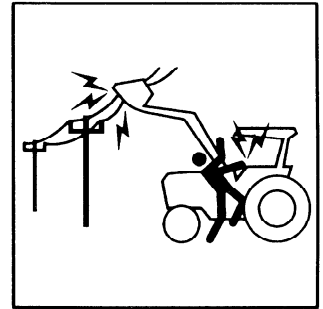

**A.3.6** Electrical shock/electrocution  
— Cotton harvester

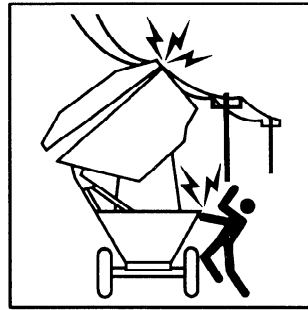

**A.3.8** Electrical shock/electrocution  
— Combine unloader auger

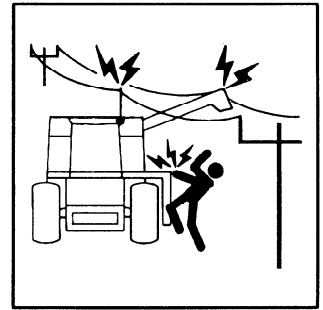

**A.4** Falling hazards

**A.4.1** Falling from high place

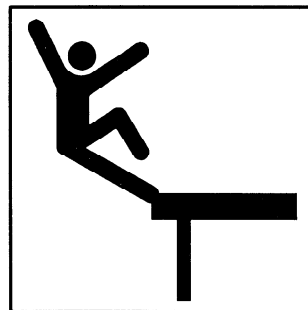

**A.4.4** Falling into machinery — Rotating gears



**A.4.2** Falling into machinery — Auger

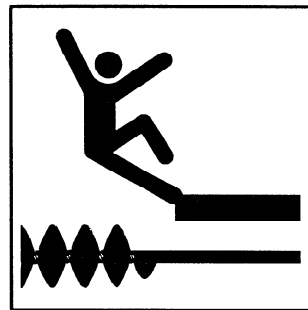

**A.4.5** Falling into machinery — Rollers



**A.4.3** Falling into machinery — Sharp edges



**A.4.6** Falling or slipping on wet area



This document is now  
**POOBLIC**

**A.4.7** Falling from raised loader bucket

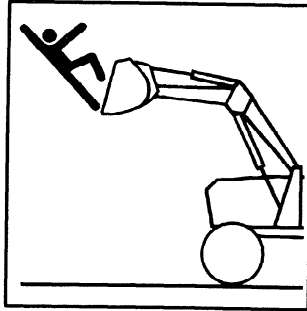

**A.5 Fluid (injection, leak/spray) hazards**

**A.5.1** High pressure fluid — Injection into body

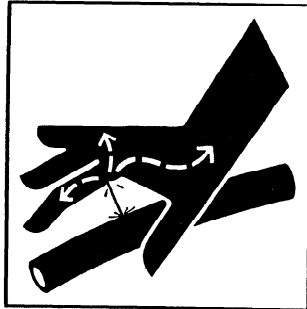

**A.5.2** High pressure spray — Erosion of flesh

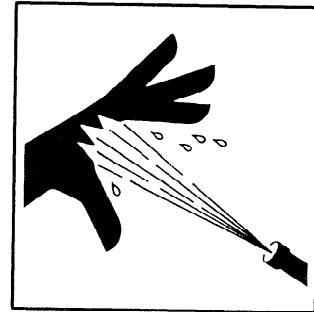

**A.6 Mechanical — Crushing hazards**

**A.6.1** Crushing of fingers or hand — Force applied from above

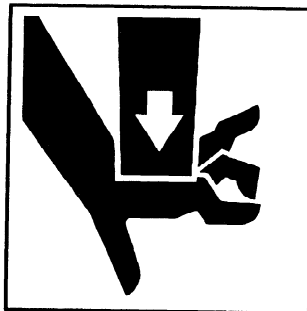

**A.6.3** Crushing of whole body — Force applied from above



**A.6.2** Crushing of toes or foot — Force applied from above

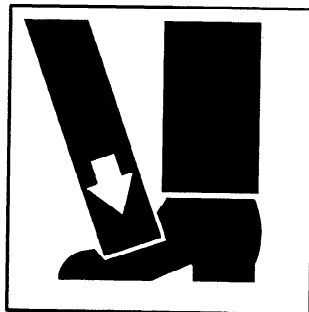

**A.6.4** Crushing of torso — Force applied from above

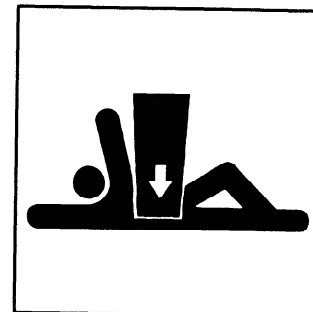

**A.6.5** Crushing of torso — Force applied from side

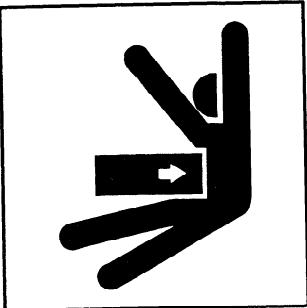

**A.6.6** Crushing of fingers or hands — Force applied from side

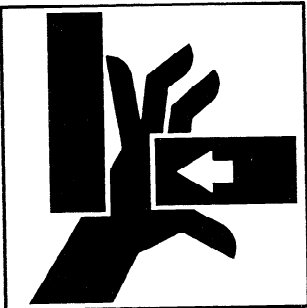

**A.6.7** Crushing of leg — Force applied from side

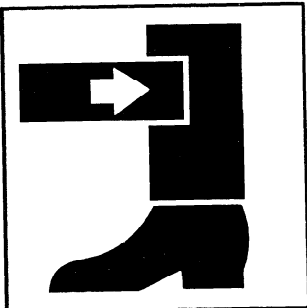

**A.6.8** Crushing — Round baler gate raising

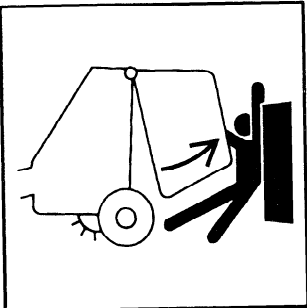

**A.6.9** Crushing — Round baler gate falling

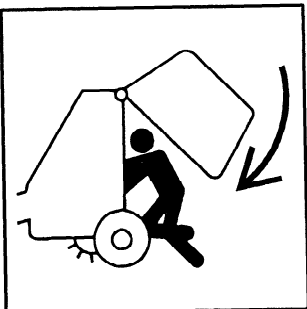

**A.6.10** Crushing of hand and arm — Tractor blade

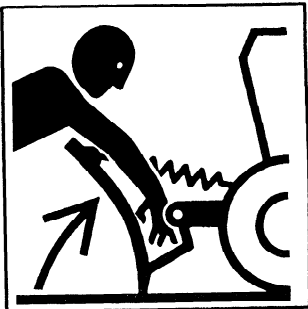

**A.6.11** Crushing of head, torso, and arms — Spreader

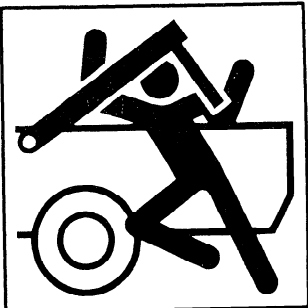

**A.6.12** Crushing — Planter or grain drill wing



**A.6.13** Crushing — Marker arm



**A.6.14** Crushing — Cultivator outrigger



Uncontrolled Copy, (c) The British Standards Institution 2012

This document is now  
**POUBLIC**

**A.6.15** Crushing —  
Rotary cutter



**A.6.17** Crushing —  
Round baler push bar

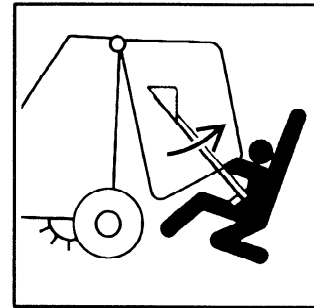

**A.6.16** Crushing —  
Runaway bale

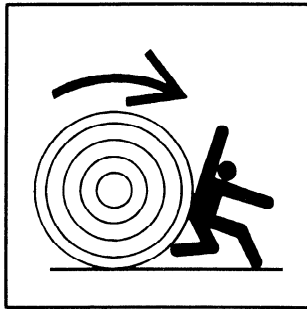

**A.6.18** Crushing —  
Loader bucket

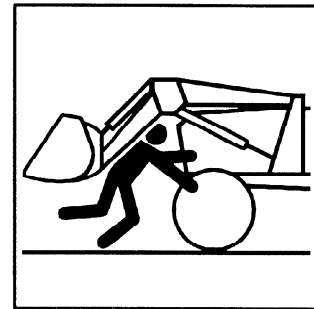

**A.7 Mechanical — Cutting hazards**

**A.7.1** Cutting of  
fingers or hand



**A.7.4** Severing of  
toes or foot — Mower  
blade

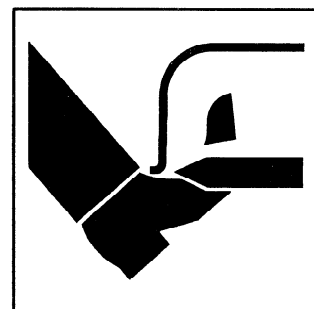

**A.7.2** Cutting of foot

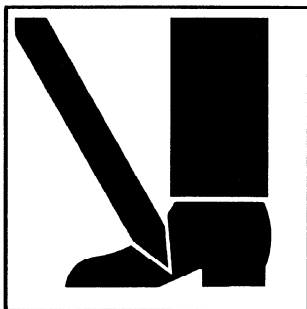

**A.7.5** Severing of  
toes or fingers —  
Rotary mower blade

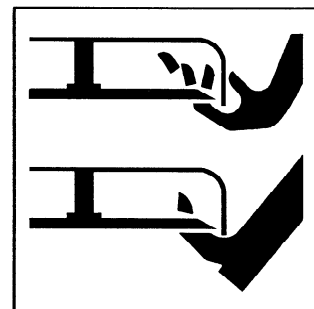

**A.7.3** Severing of  
fingers or hand —  
Mower blade

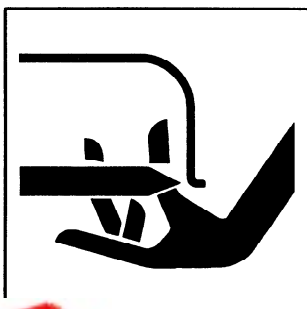

**A.7.6** Cutting or  
entanglement of foot  
— Rotating auger

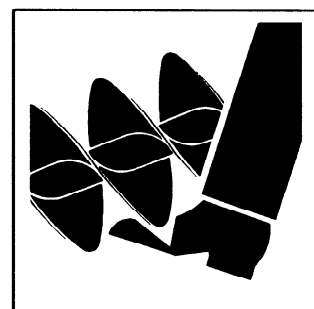



**A.7.7** Severing of foot — Rotating knives

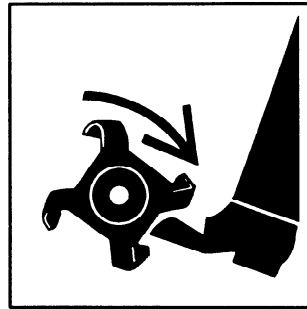

**A.7.8** Severing of fingers or hand — Impeller blade

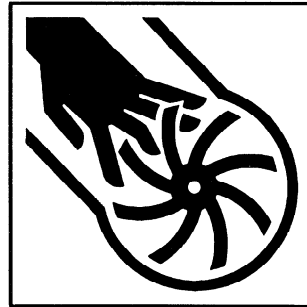

**A.7.9** Dismemberment — Rear engine mower in forward motion



**A.7.10** Dismemberment — Rear engine mower in rearward motion



**A.7.11** Dismemberment — Front engine mower or lawn and garden tractor in forward motion

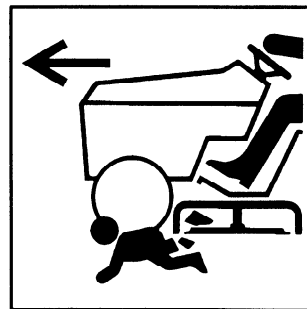

**A.7.12** Dismemberment — Front engine mower or lawn and garden tractor in rearward motion



**A.7.13** Severing of fingers or hand — Engine fan

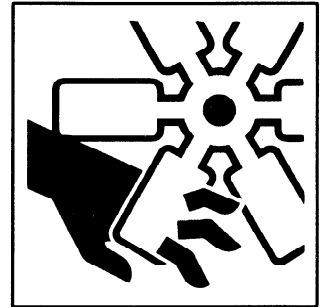

**A.7.14** Puncture of hand or fingers

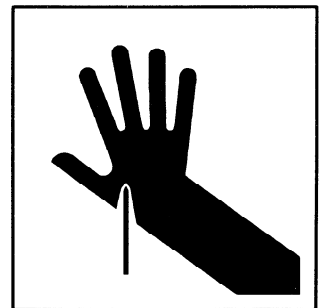

**A.7.15** Severing of toes or foot — Mower blade with flexible guard

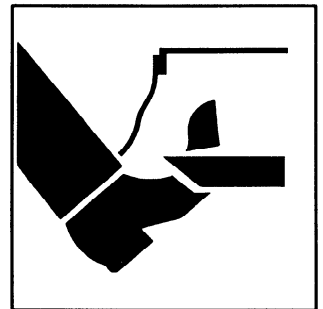

**A.7.16** Cutting of leg — Trimmer



## A.8 Mechanical — Entanglement hazards

**A.8.1** Arm entanglement in machinery



**A.8.2** Leg entanglement in machinery



**A.8.3** Leg entanglement in machinery



**A.8.4** Arm entanglement — Rotating gears



**A.8.5** Fingers or hand entanglement — Rotating gears

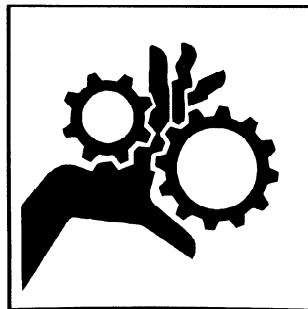

**A.8.6** Fingers or hand entanglement — Rotating rollers

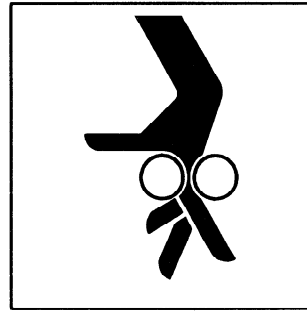

**A.8.7** Entanglement — Round baler or self-loading wagon

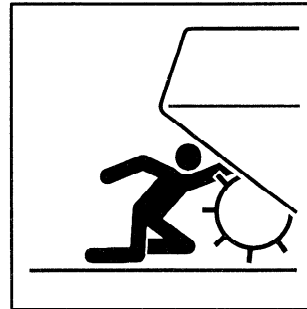

**A.8.8** Entanglement — Cotton picker spindles

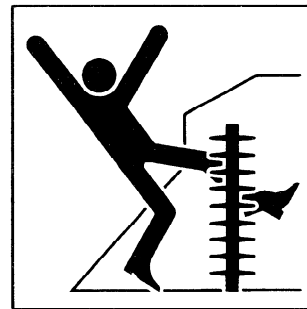

**A.8.9** Whole body entanglement — Implement input drive line



**A.8.10** Entanglement — Combine header



**A.8.11** Arm entanglement — Feed rolls

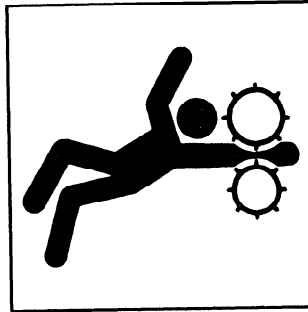

**A.8.16** Leg entanglement — Tedder rake

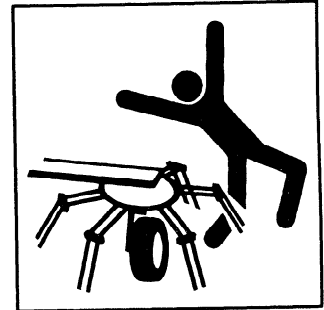

**A.8.12** Arm or upper torso entanglement — Rotating auger



**A.8.17** Arms and upper torso entanglement — Spreader beater

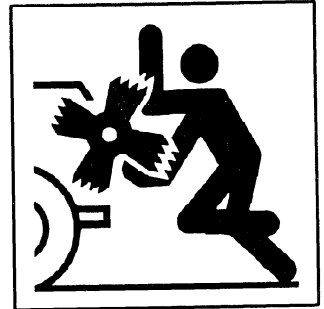

**A.8.13** Fingers or hand entanglement — Cotton stripper cleaner drive



**A.8.18** Arm entanglement — Broom reel

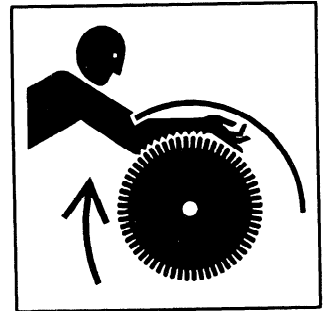

**A.8.14** Hand and arm entanglement — Chain or toothed belt drive

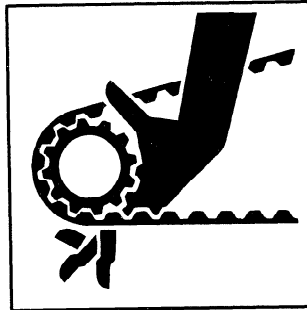

**A.8.19** Hand and arm entanglement — Belt drive

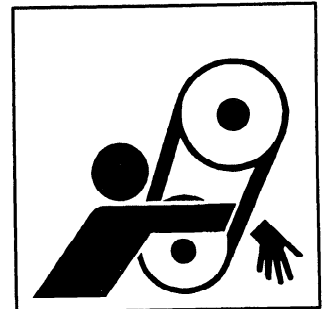

**A.8.15** Arm entanglement — Post hole digger

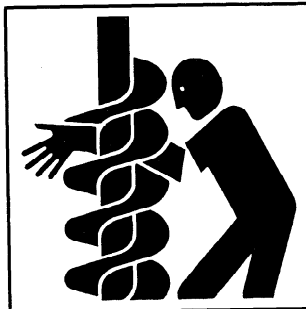

**A.8.20** Entanglement — Cotton picker conveyor drive

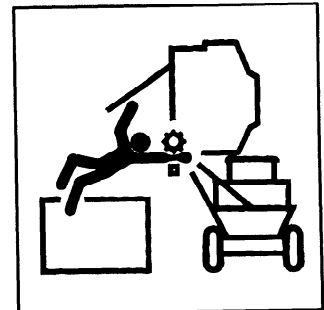

**A.8.21**

Entanglement — Crop feeder



**A.9 Mechanical — Thrown or flying object hazards**

**A.9.1** Large thrown or flying object



**A.9.4** Thrown or flying objects — Rotary cutter

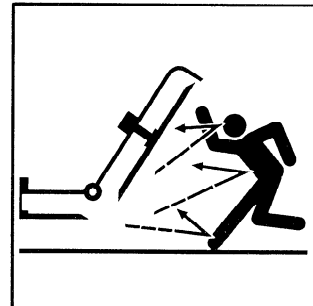

**A.9.2** Thrown or flying objects — Whole body exposure

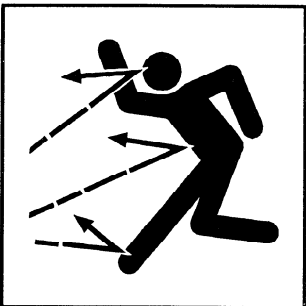

**A.9.5** Thrown or flying objects — Side-mounted rotary mower

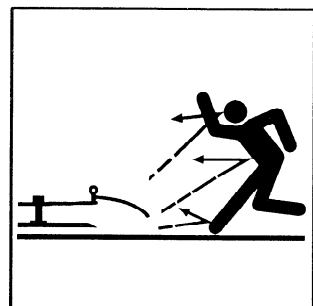

**A.9.3** Thrown or flying objects — Face exposure

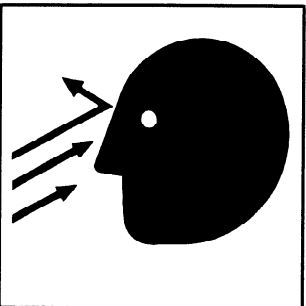

**A.10 Runover/backover/strike hazards**

**A.10.1** Runover/  
backover — Tractor

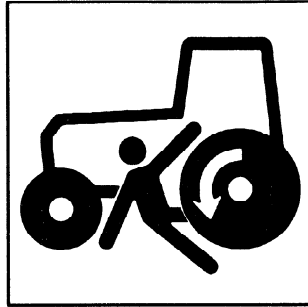

**A.11 Stability (overturn/tip, slide/fall) hazards**

**A.11.1** Machine  
tipping — Riding  
mower

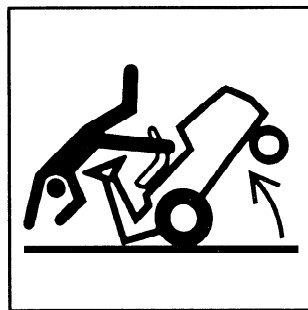

**A.11.2** Machine  
rollover — ROPS

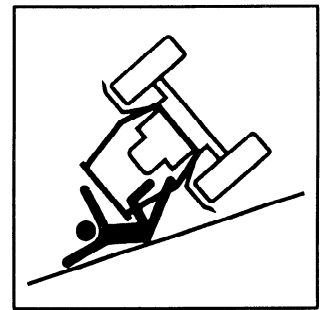

**A.12 Stored energy release hazards**

**A.12.1** Kickback or  
upward motion —  
Round baler wrap arm  
handle



**A.13 Thermal (burn/contact) hazards**

**A.13.1** Hot surfaces  
— Burns to fingers or  
hands

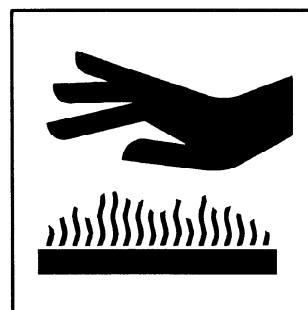

**A.14 Thermal (combustion/explosion) hazards**

**A.14.1** Explosion

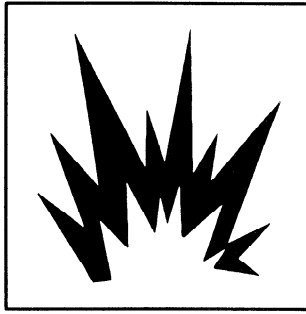

**A.14.2** Fire or open flame

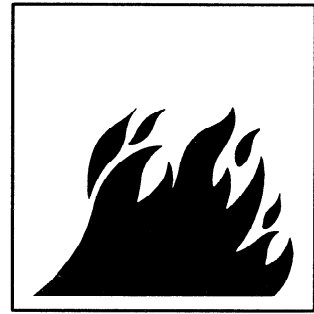



## Annex B

Hazard avoidance pictorials  
(informative)

## B.1 Scope

This annex presents examples of hazard avoidance pictorials intended for use on safety signs. Alternative hazard avoidance pictorials may be used as appropriate, and additional hazard avoidance pictorials may need to be developed.

## B.2 Hazard avoidance pictorials

**B.2.1** Stay clear of raised boom and bucket.

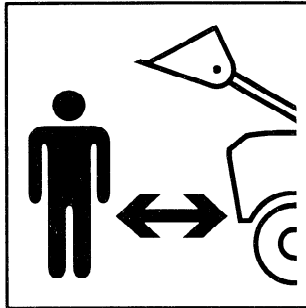

**B.2.4** Insert safety lock before getting in hazardous area.

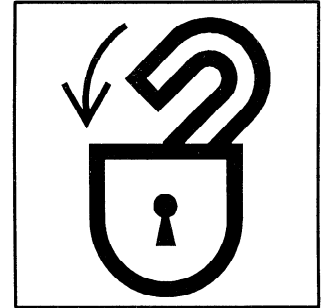

**B.2.2** Secure lifting cylinder with locking device before getting in hazardous area.

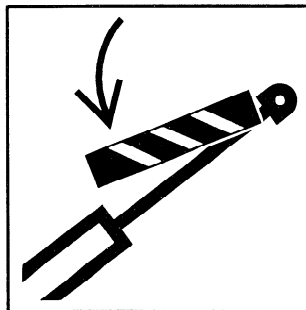

**B.2.5** Never tip trailer on soft ground or on a slope.

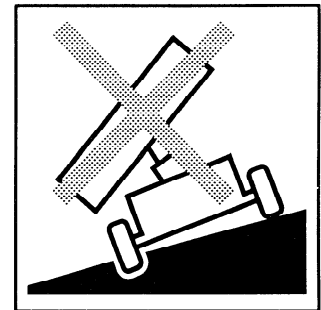

**B.2.3** Attach support before getting in hazardous area.

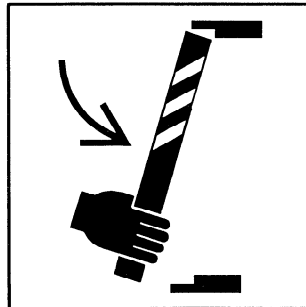

**B.2.6** Stay a safe distance from the machine.

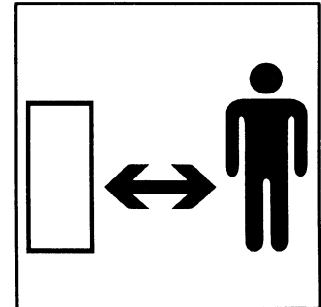

ISO 11684:1995(E)

**B.2.7** Stay clear of draft link lifting range while operating rockshaft controls.

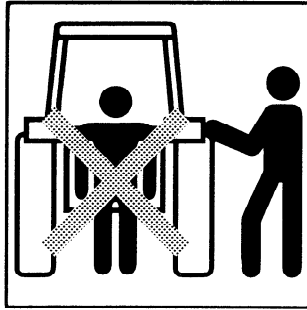

**B.2.12** Never reach or climb into grain tank while engine is running.

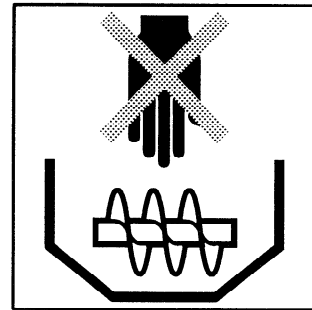

**B.2.8** Stay clear of baler gate swing area while tractor engine is running.

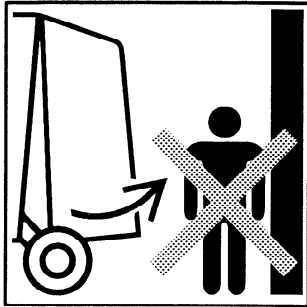

**B.2.13** Put safety shield in place while grinding knives.

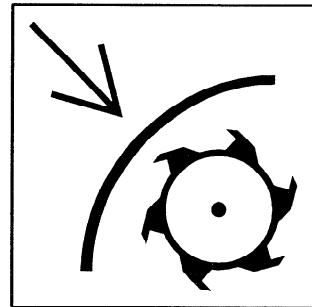

**B.2.9** Stay clear of raised gate unless safety lock is applied.

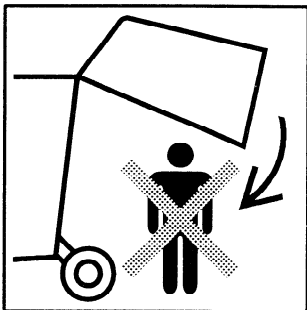

**B.2.14** Do not step on loading platform if PTO is connected to tractor and engine is running.

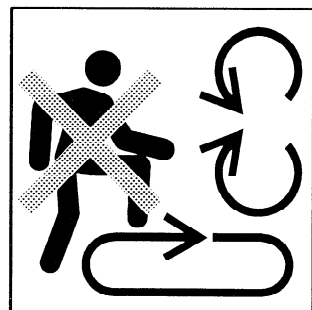

**B.2.10** Stay clear of articulation area while engine is running.

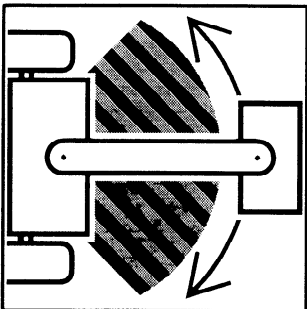

**B.2.15** Wait until all machine components have completely stopped before touching them.

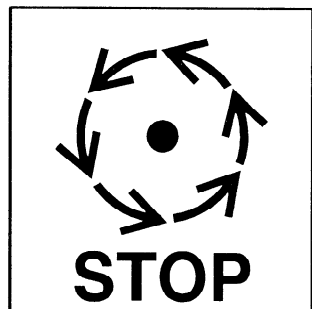

**B.2.11** Do not open or remove safety shields while engine is running.

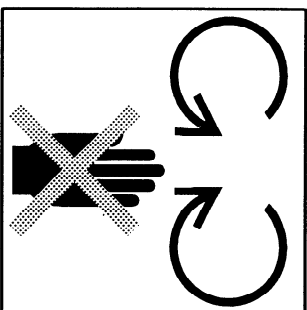

**B.2.16** Start engine from operator's seat only.

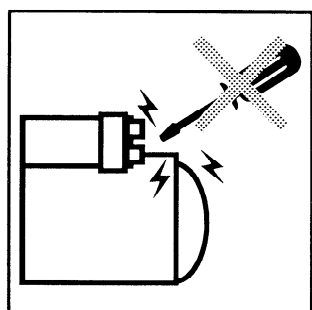

**B.2.17** Shut off engine and remove key before performing maintenance or repair work.

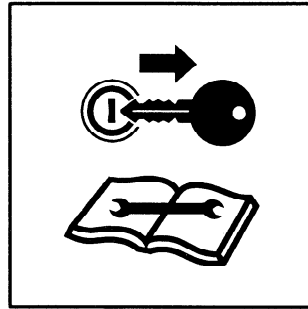

**B.2.22** Never reach into the crushing area as long as parts may move.

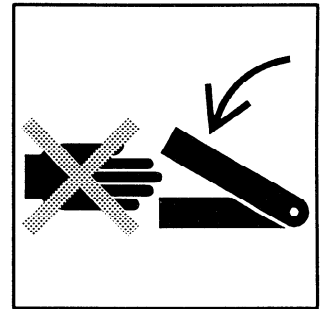

**B.2.18** Do not ride on platform or ladder.



**B.2.23** Put safety shield in place while grinding knives.

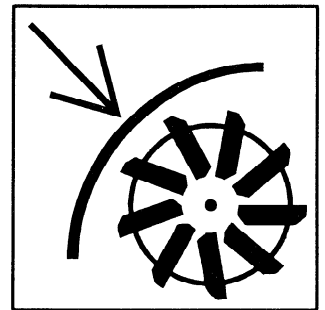

**B.2.19** Riding on this machine is allowed only on a passenger seat and only if the driver's view is not hindered.



**B.2.24** Consult Technical Manual for proper service procedures.

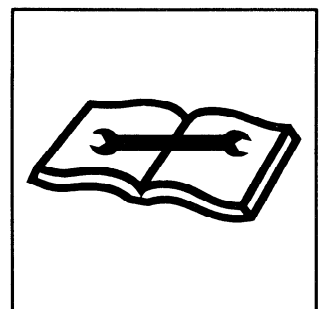

**B.2.20** Always lock ROPS in upright position unless it must be folded down to allow operation underneath trees and bushes.

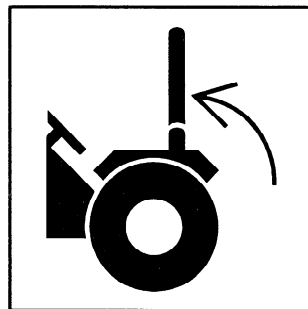

**B.2.25** Shut off engine and remove spark plug connector before performing maintenance or repair work.

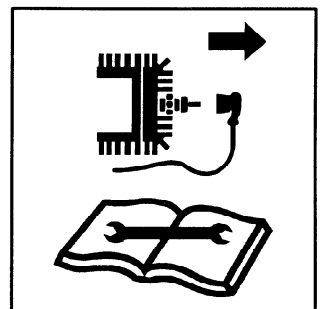

**B.2.21** Keep sufficient distance away from electrical power lines.

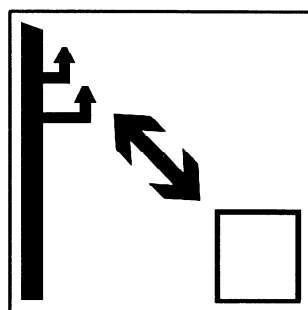

**B.2.26** Never reach into pick-up area as long as tractor is running with PTO connected.

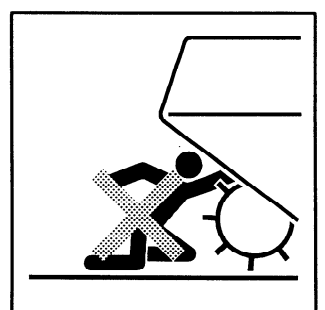

## Annex C

### Examples of safety signs without text (informative)

#### C.1 Scope

This annex presents examples of no-text safety signs for a number of hazards. These sample safety signs are shown in the vertical configuration two-panel format (no signal panel, two pictorial panels, no message panel). Additional safety signs may need to be developed for other hazards.

The text description for each safety sign provides a sample of explanatory text appropriate for inclusion in the operator's manual. This operator's manual text may be expanded or otherwise adapted as required for the specific use of the safety sign.

#### C.2 Examples of no-text safety signs

**C.2.1** Stay clear of raised boom and bucket.

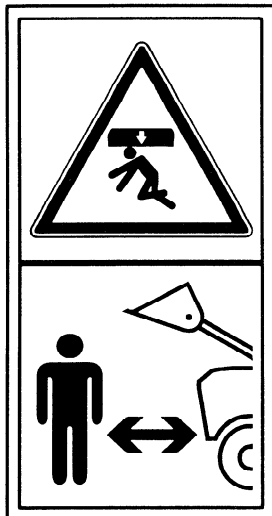

**C.2.3** Attach support before getting into hazardous area.

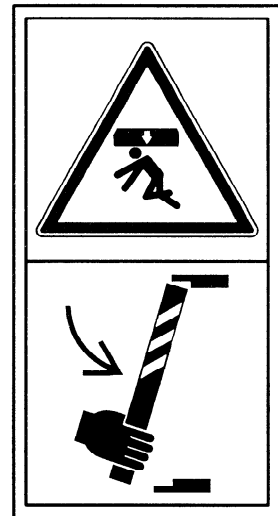

**C.2.2** Secure lifting cylinder with locking device before getting in hazardous area.

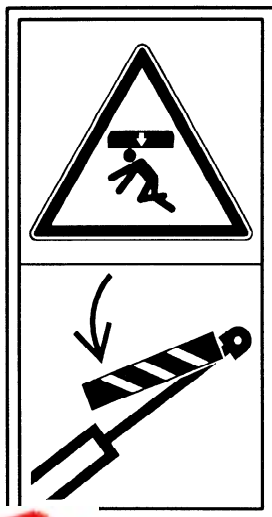

**C.2.4** Insert safety lock before getting in hazardous area.



**C.2.5** Never tip trailer on soft ground or on a slope.

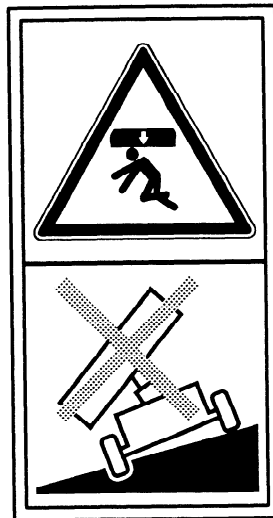

**C.2.8** Stay clear of gate swinging area while tractor engine is running.

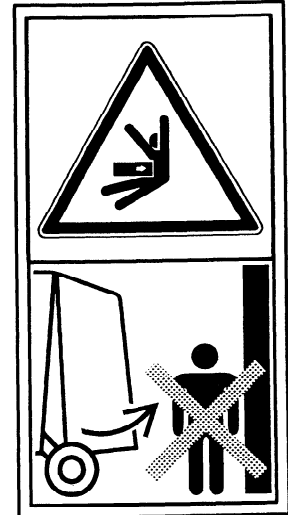

**C.2.6** Stay a safe distance from the machine.



**C.2.9** Stay clear of raised gate unless safety lock is applied.



**C.2.7** Stay clear of draft link lifting range while operating rockshaft controls.



**C.2.10** Stay clear of articulation area while engine is running.

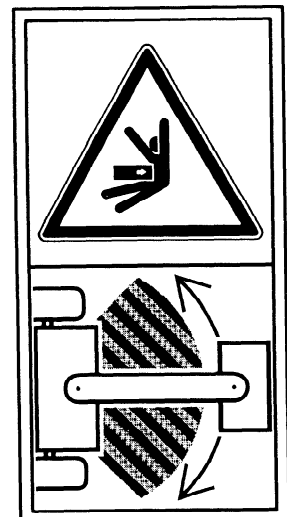

ISO 11684:1995(E)

**C.2.11** Do not open or remove safety shields while engine is running.

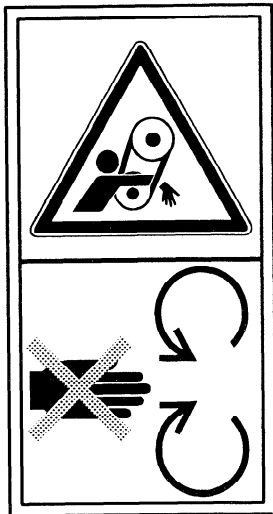

**C.2.14** Do not open or remove safety shields while engine is running.

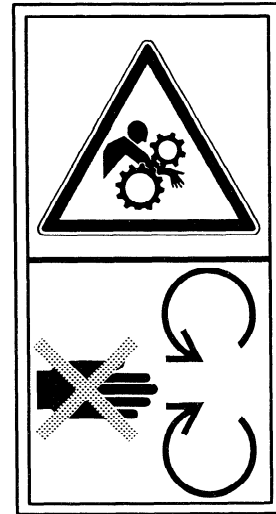

**C.2.12** Do not open or remove safety shields while engine is running.

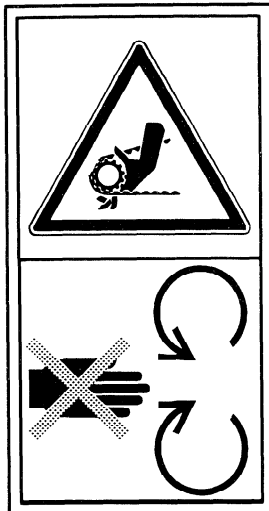

**C.2.15** Do not open or remove safety shields while engine is running.

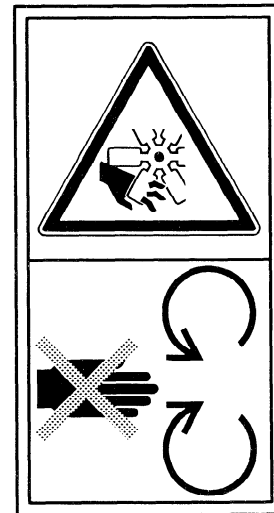

**C.2.13** Do not open or remove safety shields while engine is running.

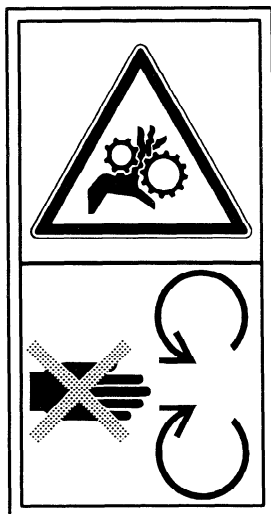

**C.2.16** Never reach or climb into grain tank while engine is running.





**C.2.17** Put safety shield in place while grinding knives.

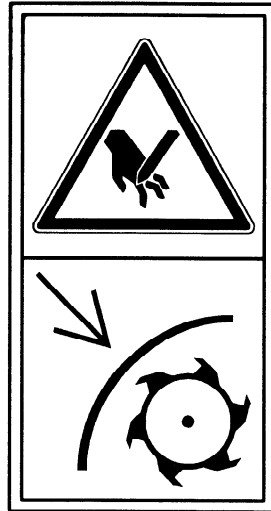

**C.2.20** Do not open or remove safety shields while engine is running.



**C.2.18** Do not open or remove safety shields while engine is running.

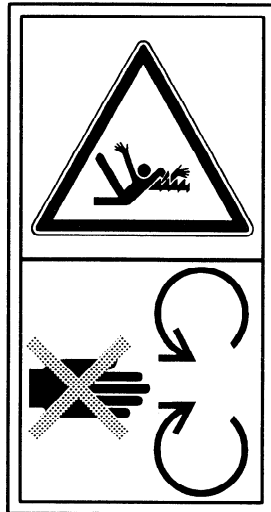

**C.2.21** Do not open or remove safety shields while engine is running.

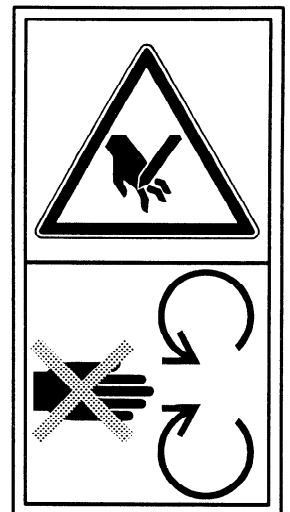

**C.2.19** Do not open or remove safety shields while engine is running.

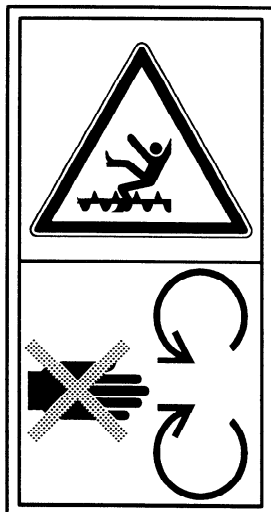

**C.2.22** Do not step on loading platform if PTO is connected to tractor and engine is running.

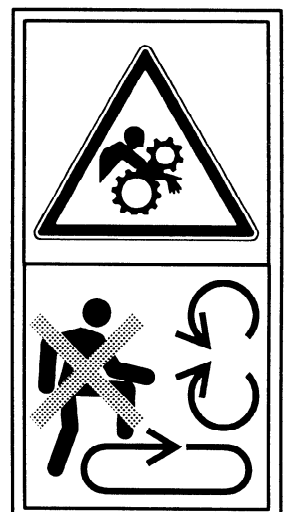

**C.2.23** Wait until all machine components have completely stopped before touching them.

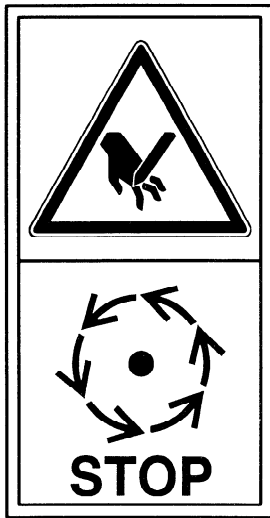

**C.2.24** Keep a safe distance from the machine.



**C.2.25** Start engine from operator's seat only.

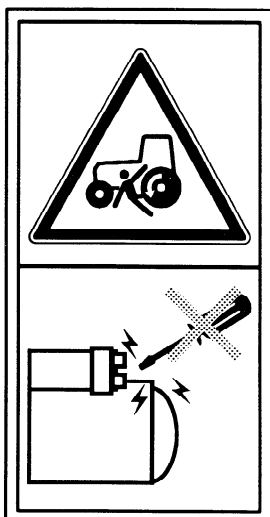

**C.2.26** Shut off engine and remove key before performing maintenance or repair work.

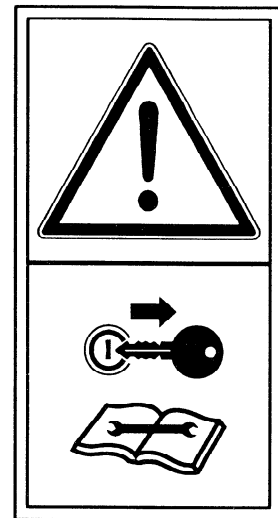

**C.2.27** Do not ride on platform or ladder.

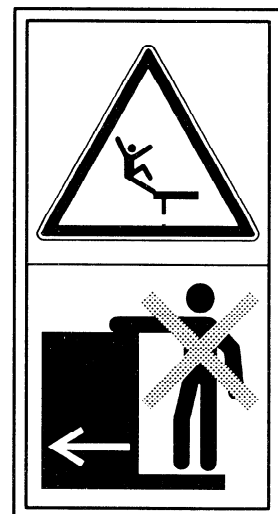

**C.2.28** Do not ride on machine except in supplied seat.

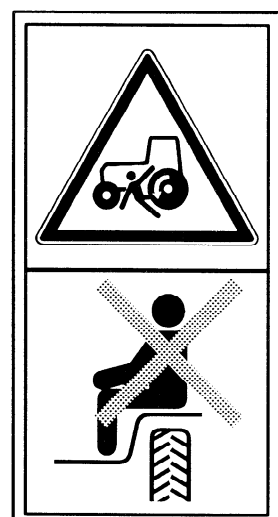

**C.2.29** Always lock ROPS in upright position unless it has to be folded down to allow operation underneath trees or bushes.

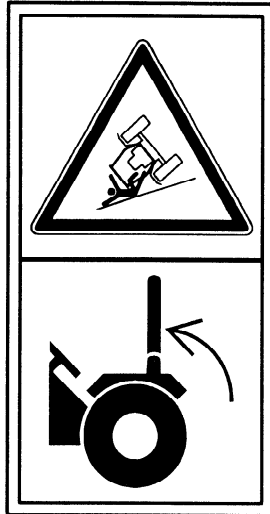

**C.2.32** Lever is spring loaded. Stay clear while actuating it.



**C.2.30** Keep sufficient distance away from electrical power lines.

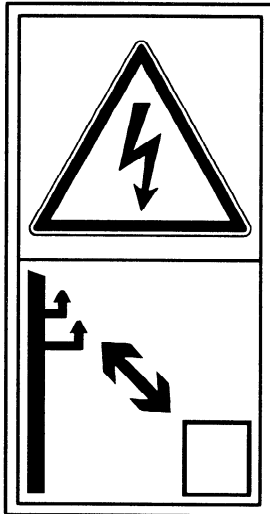

**C.2.33** Stay clear of rotating machine parts.



**C.2.31** Never reach into the needle and knotter area as long as tractor engine is running with PTO connected.

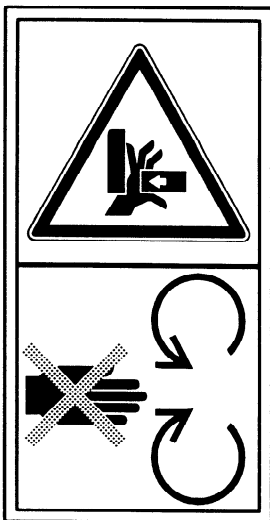

**C.2.34** Stay clear of mower blade as long as engine is running.

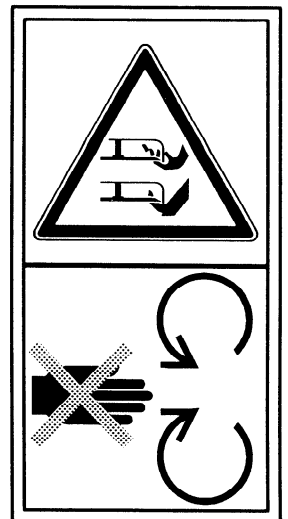

**C.2.35** Never reach into the crushing danger area as long as parts may move.

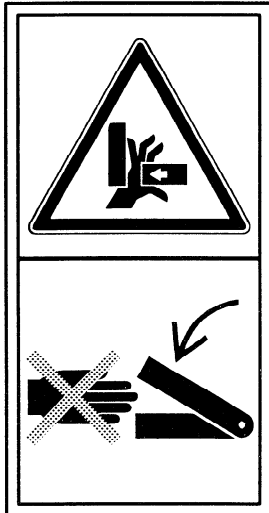

**C.2.38** Stay clear of header. Disengage header drive, shut off engine, and remove key before servicing or unclogging header.



**C.2.36** Stay clear of rotating auger.



**C.2.39** Make sure that children stay clear of mower all the time when engine is running.



**C.2.37** Stay clear of mower knife area as long as tractor engine is running with PTO connected.

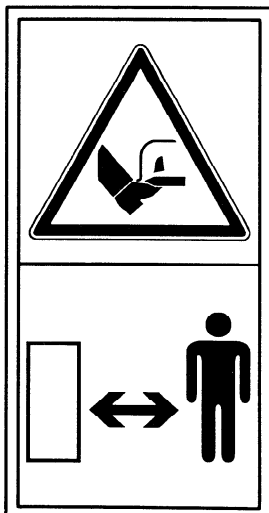

**C.2.40** Put safety shield in place while grinding knives.

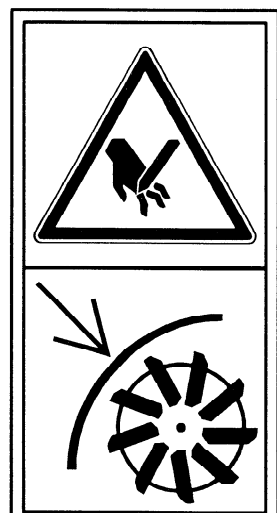

**C.2.41** Never reach into rotating auger.

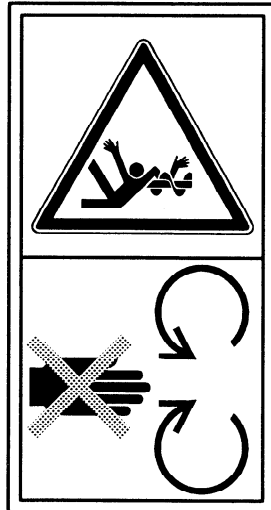

**C.2.44** Avoid fluid escaping under pressure. Consult technical manual for service procedures.

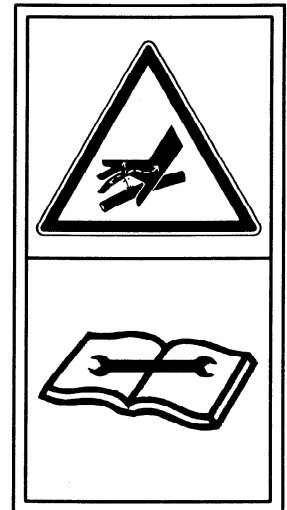

**C.2.42** Stay clear of hot surface.

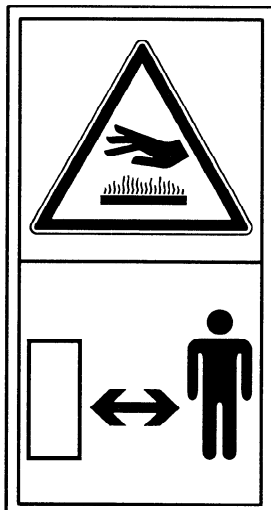

**C.2.45** Shut off engine and remove spark plug wire before performing maintenance or repair work.

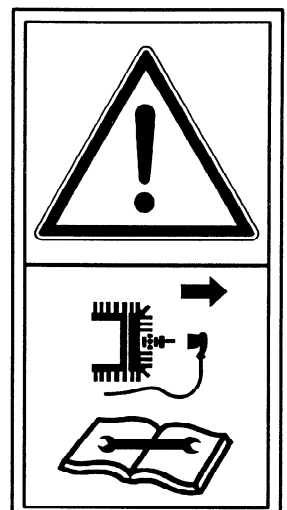

**C.2.43** To avoid possible eye injury, do not look directly into face of radar sensor while it is in operation.

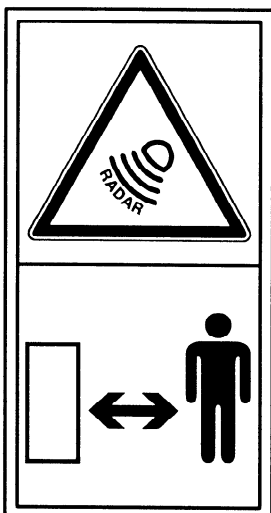

**C.2.46** Never reach into pick-up area as long as tractor is running with PTO connected.

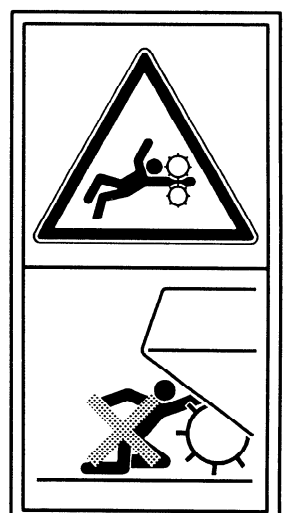

## Annex D

# Principles and guidelines for graphical design of hazard pictorials (informative)

### D.1 Scope

This annex provides principles and guidelines for good graphical design of hazard pictorials as well as instructions for drawing the human figure and other pictorial elements. Good consistent visual design is important to conveying the meaning of both hazard description and hazard avoidance pictorials.

### D.2 Guidelines for creating pictorials

Although each safety sign and each safety sign pictorial must be considered on its own terms, a number of general guidelines for good pictorial design may be articulated.

- Use representational pictorials rather than abstract symbols.
- Use a solid graphical representation of human body elements or the full human figure. An outline representation may be used when depicting a person whose presence is necessary to complete the pictorial but who is not directly involved with the hazard.
- When objects, faces, or the full human body are shown, use the view (generally front or side) that is most easily recognized.
- Use pictorials depicting dramatic action and showing the involvement of the human figure or body elements with the hazard.
- Use a simplified graphical representation of the machine elements that create the hazard. Use filled (solid) graphics of the hazardous machine elements unless these filled areas detract from easy recognition of the human figure. Use outline graphics of complete machines or of substantial portions of machines to locate hazardous areas or machine elements in context.
- Be specific in depicting hazards, especially when the nature or location of the hazard is not readily apparent. Be generic in depicting hazards and hazardous situations only when generality is possible and adequately communicates the necessary information.
- Use arrows where necessary to show actual or potential movement. In some cases, movement of a machine component is implicit in the pictorial graphics and arrows need not be added. Be consistent in selecting and using alternative arrow graphics to represent different types of movement or spatial relationships: falling or flying objects, direction of motion of machine components, direction of motion of entire machines, the exertion of pressure or force, and keeping a safe distance away from a hazard.
- Avoid using the prohibition symbols (diagonal cross, circle with diagonal slash) where the symbol would obscure identification of the prohibited action or where the meaning of the prohibition symbol is not explicitly clear.
- Do not use red to represent blood.





## D.3 Human figure

### D.3.1 Drawing basic human figure

The human figure is frequently the main component in the pictorial and must be depicted in a simple but believable form. For the greatest long-range benefit, it should always be pictured consistently. Interpretation must be instant and not require the viewer to study the pictorial to determine what part of the body is involved or in what way. The human figure presented here was designed to satisfy these specific requirements. Therefore, it should not be distorted or reportioned, except as noted in D.3.5. Its purpose is to **alert persons** who see the safety sign and to **prevent accidents**, not to be an artistic presentation.

### D.3.2 Human figure unit system

The standard pictorial figure is based on a grid system of uniform sized squares, or units. The full human figure is 12 units tall, 2 units wide at the trunk, and has a circular head 1,75 units in diameter. The precise unit measurements for drawing the figure are shown in figure D.1. The hands and feet end in semicircles.

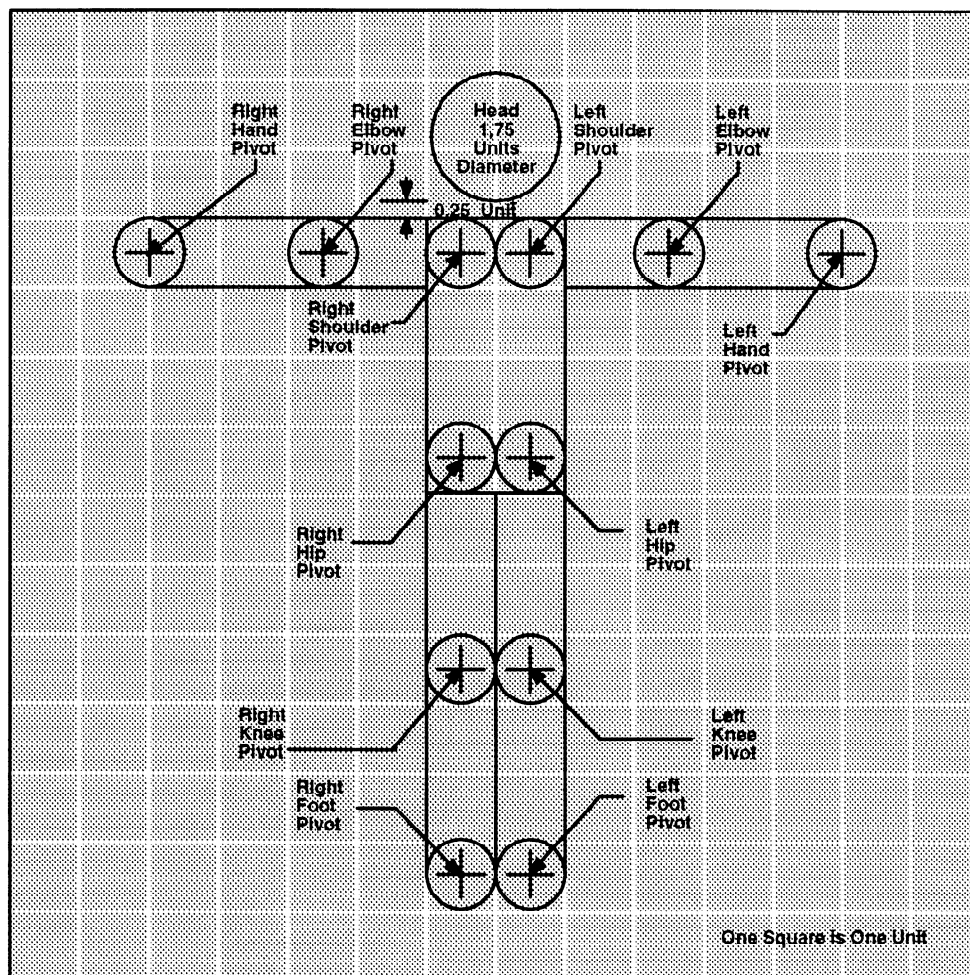

Figure D.1 — Human figure unit system



### D.3.3 Human figure animation

By using pivot points on the figure, action or movement of the figure can be depicted. The unit proportions remain the same, except in situations where the overlapping of limbs causes a visual foreshortening of the limbs. When foreshortening occurs, it is compensated for by adding 0,5 unit to the limb. Figure D.2 shows the human figure in various positions. The position the figure will assume in the pictorial is usually determined by:

- The nature of the hazard
- The direction or orientation of the hazard
- Movements or positions resulting from involvement with the hazard
- The type of injury caused by the hazard
- Movements or positions involved in the operation of equipment



Figure D.2 — Drawing human figure

### D.3.4 Bold representation versus outline drawing of human figure

This bold representation of the human form is more effective than a line drawing of the same human form in focusing the observer's attention on the person whose potentially hazardous situation is the subject of the pictorial. However, if more than one human figure appears in the pictorial, a person not directly exposed to the hazard may be a line drawing: for example, the driver of a machine in a runover hazard pictorial or a falling rider hazard pictorial. The line drawing of a human figure may be used:

- only for representing persons not directly at risk in the hazardous situation, **and**
- only when, by being combined with the bold human form, the combination results in a pictorial that is easier to understand and communicates better.

Figure D.3 shows a pictorial in which both the bold and line drawing human forms are used.

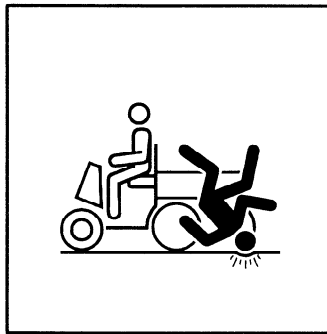
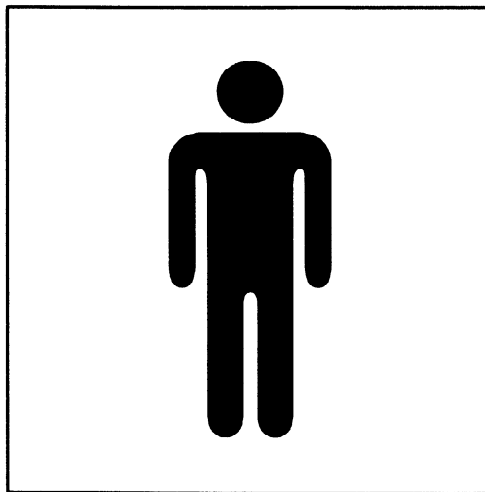

Figure D.3 — Example of pictorial using both bold and line drawing human forms

### D.3.5 Stationary, free-standing human figure (viewed from front or rear)

The standard pictorial human figure is modified when the person is depicted in a stationary, free-standing position. The IEC symbol denoting "Heavy (obese) patient — For use on medical equipment" (symbol number 5391 from IEC 417:1973) is used as the pictorial human figure in hazard avoidance pictorials that communicate the idea of keeping a safe distance away from a hazard (see D.8.6) and in some hazard avoidance pictorials that communicate the idea of keeping away from a hazardous location (see D.9.2). Figure D.4 shows this stationary, free-standing human figure.



Stationary, free-standing human figure (viewed from front or rear)

This document is now  
**POOBLIC**

### D.3.6 Profile head

Whenever the head is involved with the hazard, the profile version is used facing either left or right. The profile head can also be used whenever the full figure or upper torso is to appear in profile to create an impression that the figure or torso itself is in the profile position. Figure D.5 gives examples of hazard pictorials that use the profile head.

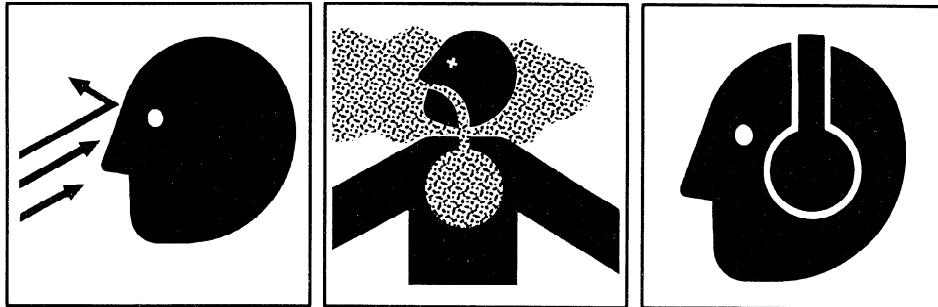

Figure D.5 — Examples of pictorials using profile head

### D.4 Upper torso

Hazards that involve the arms, hands, or head may best be dramatized by using the upper torso rather than the full torso. In most cases the upper torso would appear in profile and the profile head would be used rather than the frontal or circular head. When depicted in a profile position, the upper torso can also be effective in conveying directional movement with the hazard. If hands are involved in the hazard, or if the depiction of hands would aid in visual dramatization, they should be added to the figure, as shown in D.5.2. Figure D.6 gives examples of hazard pictorials that use the upper torso.

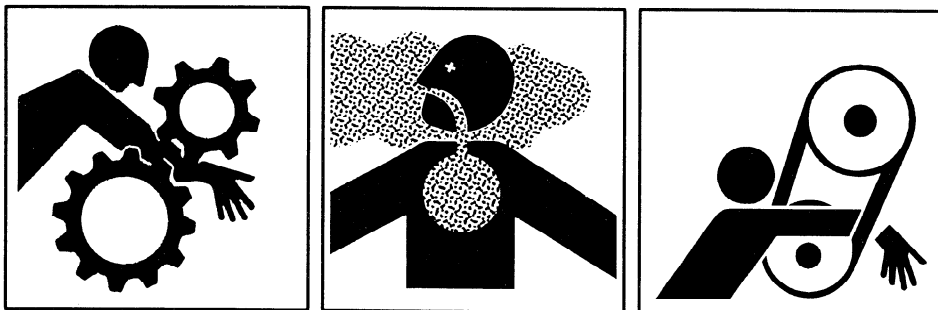

Figure D.6 — Examples of pictorials using upper torso



## D.5 Hands

### D.5.1 Drawing the human hand and fingers

The complexity of the human hand and the many possible finger movements, make hands one of the most difficult pictorial elements to work with. The design shown in figure D.7 was given careful attention to simplify shape and form for easy recognition. In the full palm view, the fingers and thumb do not move to other positions. In other full hand views, fingers may be spread. Figure D.8 gives examples of hazard pictorials that use the full-view hand.

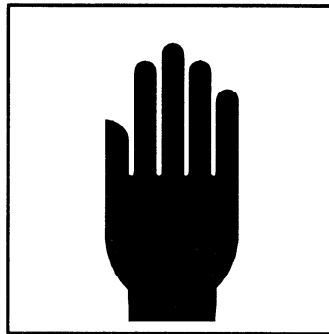

Figure D.7 — Full palm view hand

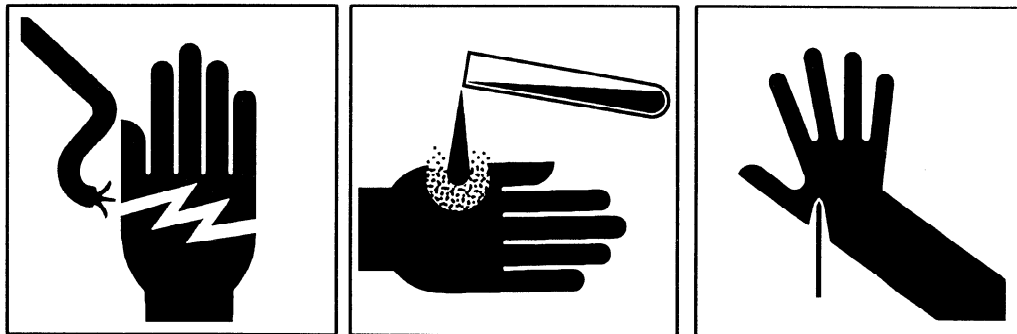
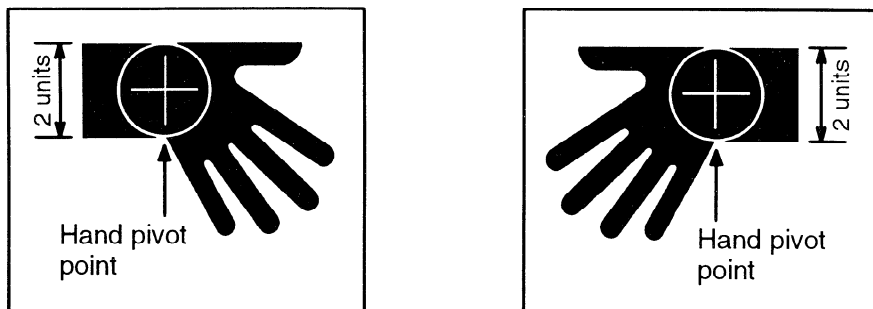

Figure D.8 — Examples of pictorials using the full-view hand

**D.5.2 Adding hands to human figure.**

When hazards involve the hands or arms, hands are added to the figure to increase recognition value of the limb elements. Two basic hand positions are shown in figure D.9.

- Position A shows the thumb extended along the same axis as the arm.
- Position B shows the hand rotated several degrees around the hand pivot point.



Position A — Hand with thumb extended along arm axis

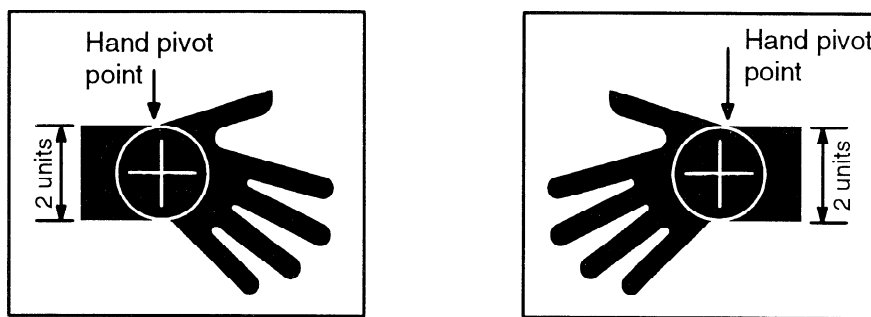

Position B — Hand rotated around hand pivot point

**Figure D.9 — Adding hands to the human figure**

Selection of Position A versus Position B should be based on which position is judged to best dramatize the involvement with the hazard. For design consistency, hands are added to both arms (when both arms are shown) even when only one arm is involved with the hazard. Figure D.10 gives examples of hazard pictorials where hands have been added to the human figure.



**Figure D.10 — Examples of pictorials using human figure with hands**

Uncontrolled Copy, (c) The British Standards Institution 2012

This document is now  
PUBLIC

**D.5.3 Hand Profiles**

Hand profiles are best used to convey a feeling of depth, which can add realism, dramatization, and understandability to the pictorial. Although the hand is not actually drawn in perspective, the positioning of the fingers can create a three-dimensional impression.

Hand profiles are the most difficult elements of the human figure to design. The hand profiles shown in figure D.11 represent the design style to be used in pictorials to maintain visual consistency. Valuable time can be saved when creating hand profiles by taking existing pictorials and modifying or repositioning elements of the hand as necessary. Situations that require various finger movements can be depicted by selecting the hand closest to the desired position and modifying it. Note the finger treatment. The fingers are not tapered, although they may appear to be. Fingertips are created using a 0,25 circle. The profile view uses only three fingers plus the thumb.

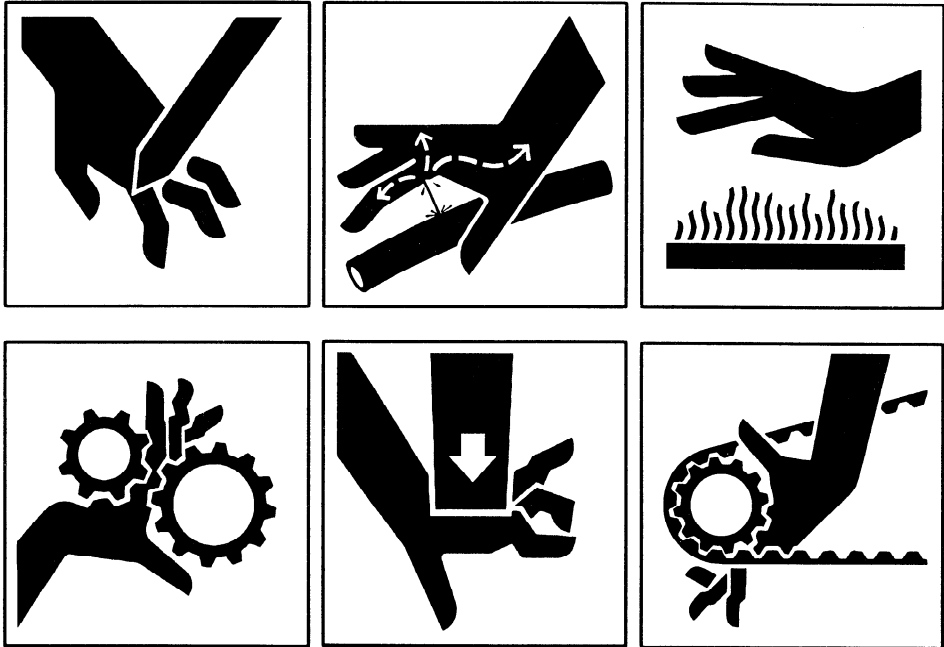

Figure D.11 — Examples of pictorials using hand profiles

Uncontrolled Copy, (c) The British Standards Institution 2012

This document is now  
**POOBLIC**

## D.6 Feet

### D.6.1 Foot Development

When a pictorial illustrates just the lower leg or foot, the stylized shoe or boot (foot) shown in figure D.12 should be used. It can be used facing either left or right. Figure D.13 gives examples of hazard pictorials that use a foot.

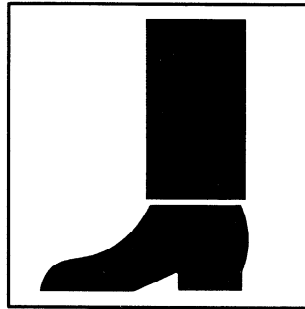

Figure D.12 — Foot development

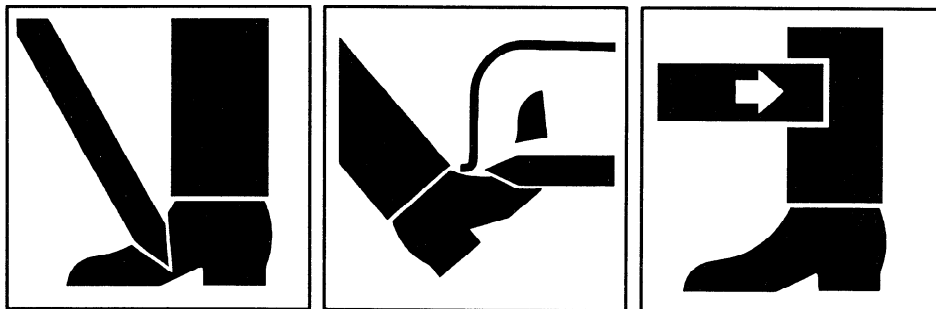

Figure D.13 — Examples of pictorials using feet





### D.6.2 Adding feet to the human figure

Some hazards which involve the feet or lower limbs are most effectively dramatized by using the full human figure; adding feet to the figure increases recognition value of the limb elements. For such pictorials, the feet shown in figure D.14 should be added to the foot pivot points. For design consistency, they should not be altered or distorted. Figure D.15 gives examples of hazard pictorials where feet have been added to the human figure.

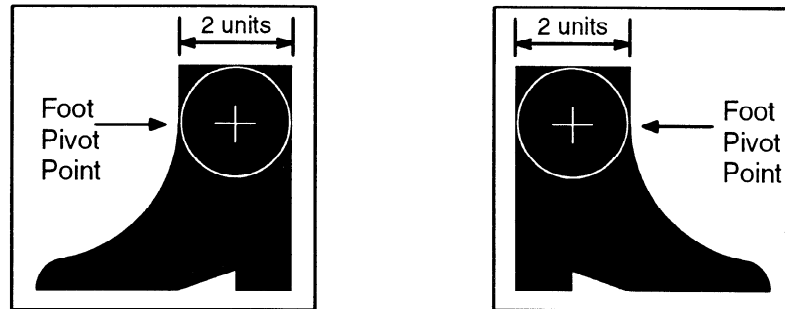

Figure D.14 — Adding feet to the human figure



Figure D.15 — Examples of pictorials showing the human figure with feet

## D.7 Representation of machines, equipment and components

**D.7.1** In general, use outline representations for whole machines or substantial portions of machines. The reason is to avoid large filled (black) areas that may detract from recognition of the human figure relative to the machine or the hazard-creating component or equipment on the machine. This is especially true when the human figure is depicted in close proximity to the machine representation. Representations of individual components may be outline or filled, depending upon which alternative provides better visual recognition and graphical clarity. In general, filled areas result in the perception of greater mass and solidity; however, outlines of machines often encourage inclusion of enough graphical detail that the identity of actual components and the nature of the hazards they present may be discerned more easily. Smaller filled areas, or outlines using a wider line thickness, can assist in highlighting the hazard-creating component or equipment on a machine.

D.7.2 Figure D.16 gives examples of pictorials that use whole machines or major components of machines in their graphical description of hazards. Figure D.17 gives examples of pictorials that use individual hazard-creating machine components, not in the context of their machine location, in their graphical description of hazards.

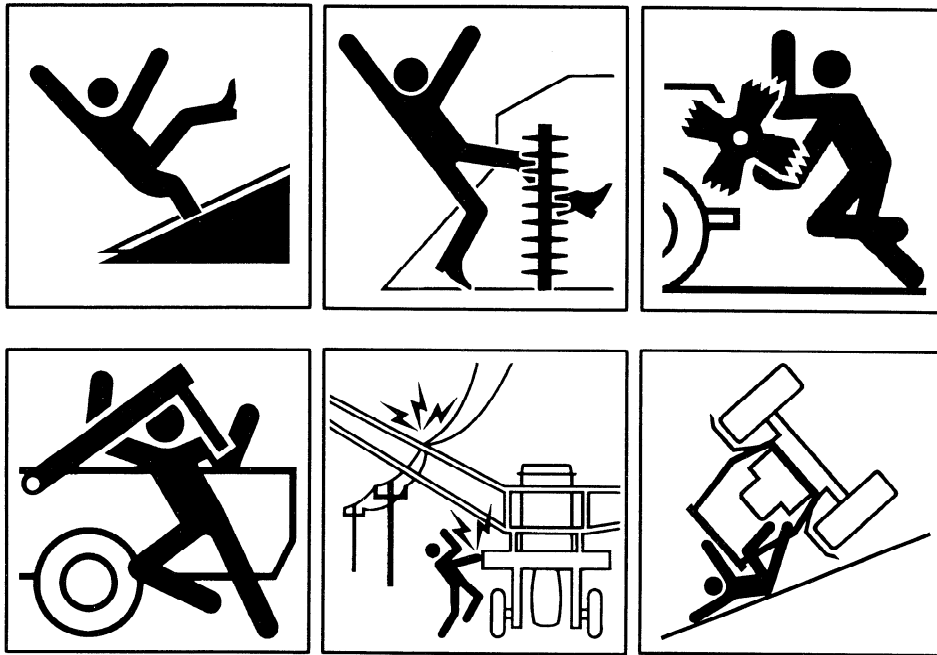

Figure D.16 — Examples of pictorials showing machines and hazard-creating major components



Figure D.17 — Examples of pictorials showing individual hazard-creating components



## D.8 Arrows

### D.8.1 Using arrows

To communicate basic safety sign information, pictorials must use visual elements to represent a variety of things, conditions, and ideas. Important among these things, conditions and ideas are: flying or falling objects and their direction of motion, the direction of motion of machine components, the direction of motion of entire machines, the exertion of pressure or force, and the idea of keeping a safe distance away from a hazard. Five types of arrow design are used to denote these elements of pictorial communication.

### D.8.2 Arrows representing falling or flying objects and their direction of motion

This arrow is generally used as a black arrow on a white background. It can be straight, angled or curved. The tail of the arrow should appear solid when a single object or a few objects are involved; the tail should be broken when a continuous barrage of objects or particles is involved. See figure D.18 for arrow dimensions. This arrow is normally sized in proportion to the size of the falling or flying object that it represents in a given pictorial. Figure D.19 gives examples of hazard pictorials that use this arrow to represent falling or flying objects and their direction of motion.

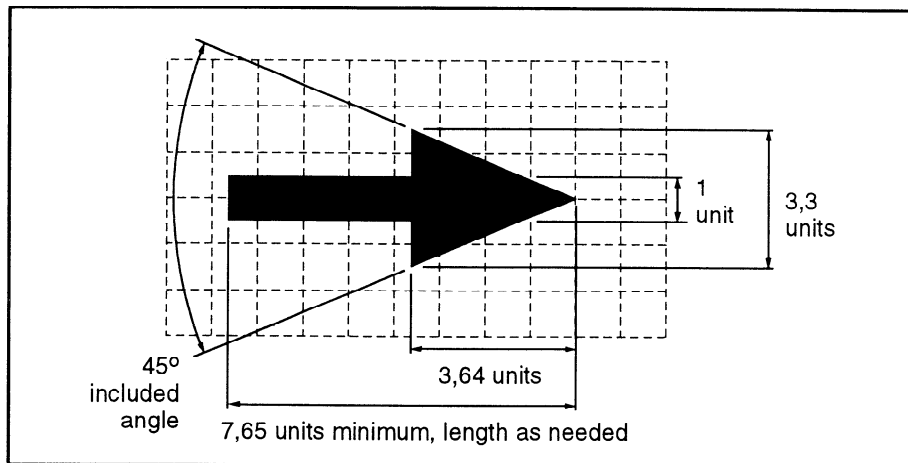

Figure D.18 — Arrow to represent falling or flying objects and their direction of motion

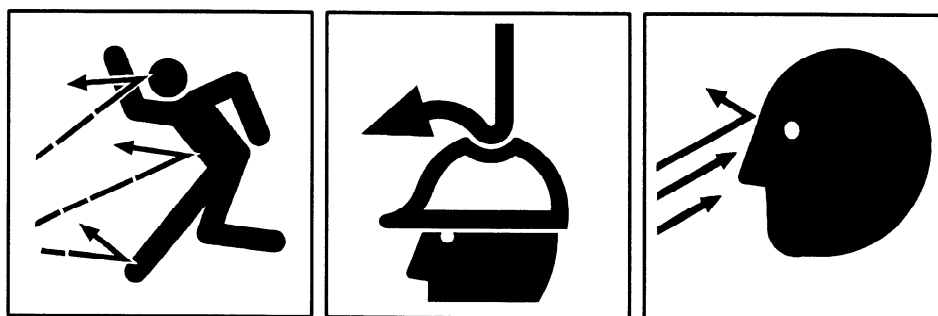
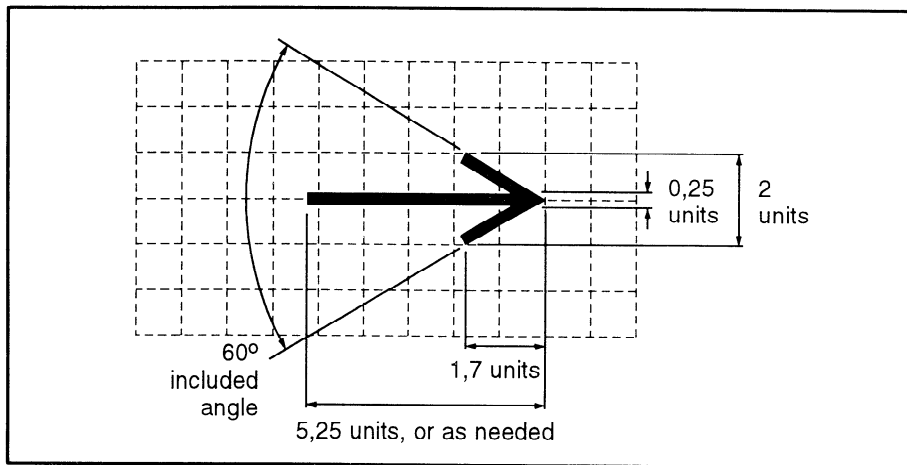

Figure D.19 — Examples of pictorials using arrows to represent falling or flying objects and their direction of motion

**D.8.3 Arrows representing direction of motion of machine components**

This arrow is generally used as a black arrow on a white background. It can be straight, angled or curved. See figure D.20 for arrow dimensions. This arrow is normally used at 100% of actual size shown in figure D.20, although it may be sized differently as appropriate to individual pictorials. This arrow conforms to the direction of movement arrow from ISO 4196, with a 60° included angle for the arrowhead. Figure D.21 gives examples of hazard pictorials that use this arrow to represent the direction of motion of machine components. Because relative line thickness is the only significant difference between the arrows in figure D.20 and figure D.22, situations may arise when the two arrows appear almost identical. When possible, however, use the arrow in figure D.20 to represent the direction of motion of machine components and the the arrow in figure D.22 to represent the direction of motion of entire machines.



**Figure D.20 — Arrow to represent direction of motion of machine components**



**Figure D.21 — Examples of pictorials using arrows to represent direction of motion of machine components**

Uncontrolled Copy, (c) The British Standards Institution 2012  
 Loughborough University, 19/04/2012 09:32, Athens, Loughborough University, 19/04/2012 09:32, Uncontrolled Copy, (c) The British Standards Institution 2012



**D.8.4 Arrows representing direction of motion of entire machines**

This arrow is generally used as a black arrow on a white background. It can be straight, angled or curved. See figure D.22 for arrow dimensions. This arrow is normally used at 100% of actual size shown in figure D.22, although it may be sized differently as appropriate to individual pictorials. This arrow conforms to the direction of movement arrow from ISO 4196, with a 60° included angle for the arrowhead. Figure D.23 gives examples of hazard pictorials that use this arrow to represent the direction of motion of entire machines. Because relative line thickness is the only significant difference between the arrow in figure D.20 and the arrow in figure D.22, situations may arise when the two arrows appear almost identical. When possible, however, use the arrow in figure D.20 to represent the direction of motion of machine components and the the arrow in figure D.22 to represent the direction of motion of entire machines.

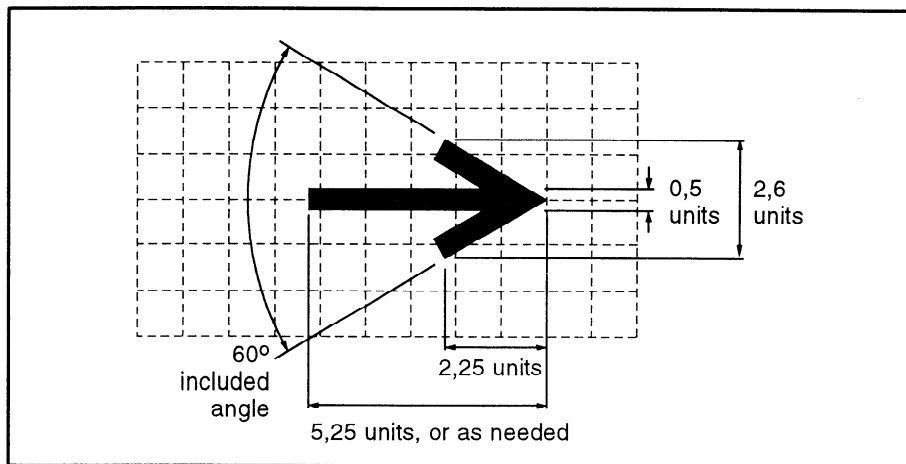

**Figure D.22 — Arrow to represent direction of motion of entire machines**



**Figure D.23 — Examples of pictorials using arrows to represent direction of motion of entire machines**

D.8.5 Arrows representing exertion of pressure or force

This arrow is generally used as a white arrow in a black silhouette representing the source of the force or pressure. It may also appear as a black arrow on a white background when the specific source of the force or pressure is depicted. See figure D.24 for arrow dimensions. This arrow is normally used at 100% of actual size shown in figure D.24, although it may be sized differently as appropriate to individual pictorials. This arrow conforms to the force arrow from ISO 4196, with an 84° included angle for the arrowhead. Figure D.25 gives examples of hazard pictorials that use a pressure or force arrow.

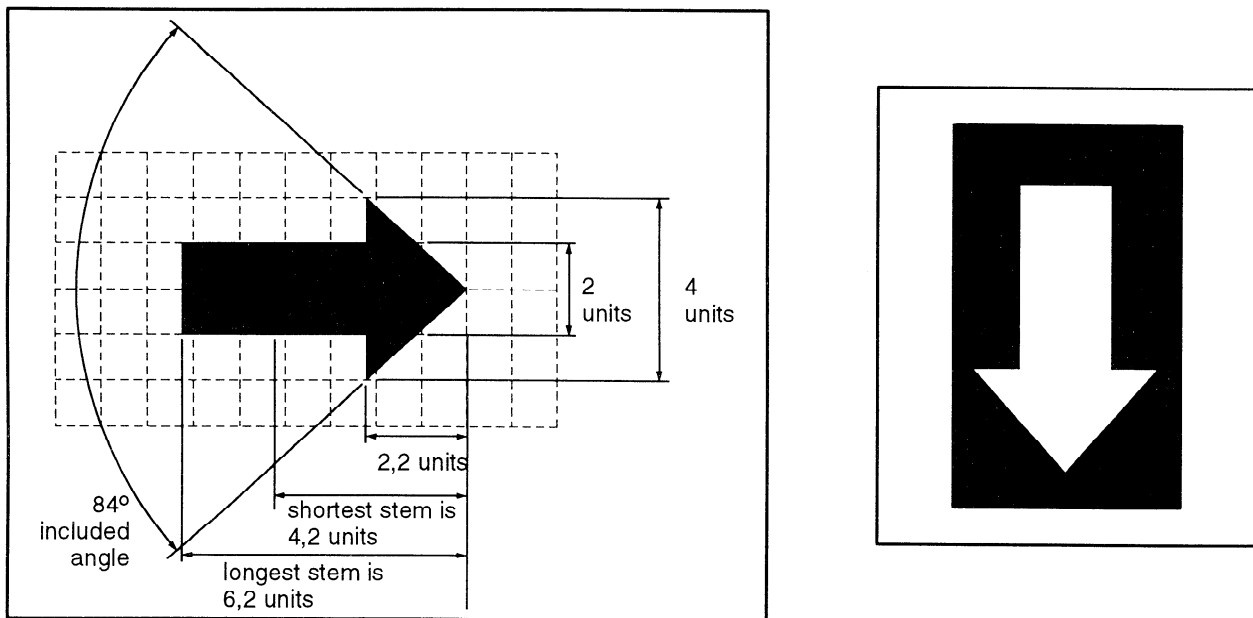

Figure D.24 — Arrow to represent exertion of pressure or force

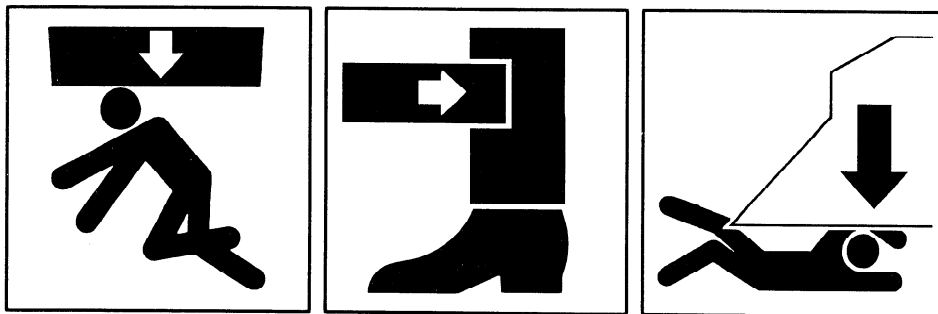

Figure D.25 — Examples of pictorials using arrows to represent exertion of pressure or force

Uncontrolled Copy, (c) The British Standards Institution 2012

This document is now  
**POOBLIC**

**D.8.6 Arrows representing idea of keeping safe distance away from hazard**

This arrow is generally used on hazard avoidance pictorials as a black arrow on a white background (for safety signs with text) or as a black arrow on a yellow background (for safety signs without text). See figure D.26 for arrow dimensions. This arrow is normally used at 60% of actual size shown in figure D.26, although it may be sized differently as appropriate to individual pictorials. This arrow conforms to the direction of movement arrow in ISO 4196 for public information symbols that direct persons, except that two arrows are combined tail-to-tail. Figure D.27 gives examples of pictorials that use this arrow to represent the idea of keeping a safe distance away from a hazard.

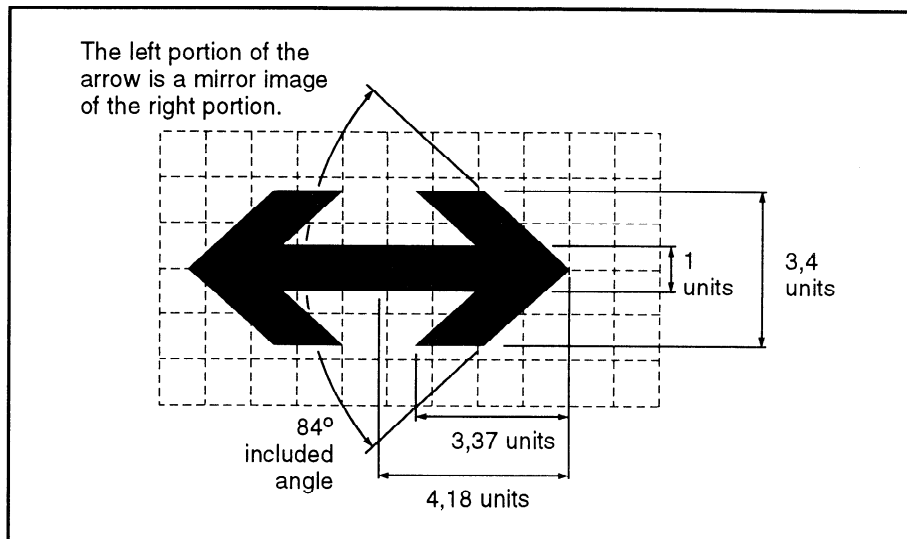

**Figure D.26 — Arrow to represent idea of keeping safe distance away from hazard**

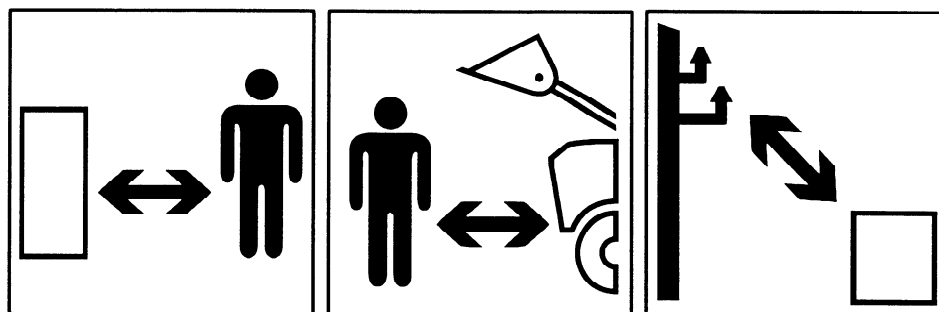

**Figure D.27 — Examples of pictorials using arrows to represent idea of keeping safe distance away from hazard**

Uncontrolled Copy, (c) The British Standards Institution 2012

This document is now  
**POOBLIC**



## D.9 Communicating idea of prohibited action or hazardous location

**D.9.1** Hazard avoidance pictorials often communicate the idea that an action is prohibited or that a person's presence in a specified location may be hazardous. In general, use a red diagonal cross **X** to communicate the idea of a hazardous location. Use either a red **X** or a red circle with diagonal slash **⊘** to communicate the idea of a prohibited action; the red **X** is generally preferred. These graphical elements are shown in figure D.28. Sizing of the **X** and **⊘** depends on how they are used in a particular pictorial. It is important that they are sufficiently large as to be easily recognized, but care must be taken to avoid obscuring any important portion of the pictorial.

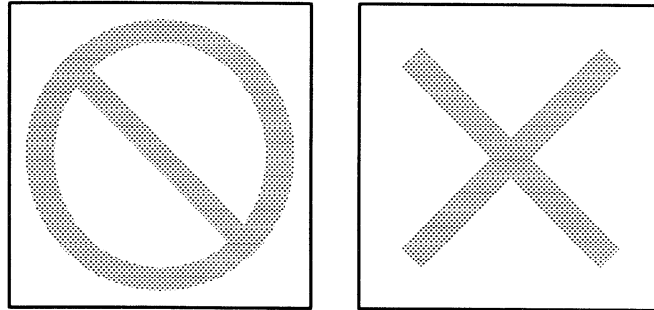





**Figure D.28 — Red circle with diagonal slash and diagonal cross to communicate idea of prohibited action or hazardous location**

**D.9.2** A red diagonal cross is used to communicate the idea of prohibited action or hazardous location: a red **X** may be placed across a human figure who is engaged in the prohibited action or who is present in a hazardous location; the red **X** communicates the negative message that the depicted action is prohibited or that the indicated location may be hazardous and should be avoided. The arms of the diagonal cross are perpendicular to each other and at a 45° angle to the pictorial frame. Figure D.29 gives examples of hazard pictorials that use a red **X** to communicate the idea of a prohibited action or a hazardous location.



**Figure D.29 — Examples of pictorials using red diagonal cross to communicate idea of prohibited action or hazardous location**

**D.9.3 A red circle with diagonal slash is used to communicate the idea of prohibited action:** a red  may be placed across pictorial elements that depict the prohibited action; the  communicates the negative message that the depicted action is prohibited. The slash is always oriented from the upper left to the lower right of the circle; a 45° angle from the horizontal is standard, although this may be adjusted a few degrees more or less to avoid obscuring important pictorial information. Use  only when its pictorial meaning is clear. Figure D.30 gives examples of hazard pictorials that use a red  to communicate the idea of a prohibited action.

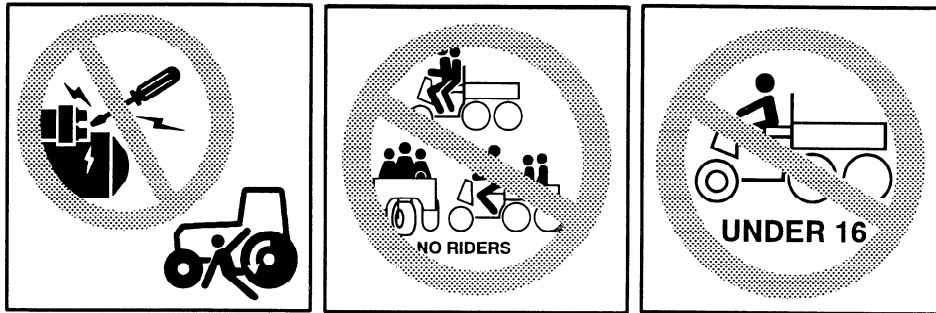

Figure D.30 — Examples of pictorials using red circle with diagonal slash to communicate idea of prohibited action

## Annex E

### Bibliography (informative)

- [1] ISO 3461-1:1988, *General principles for the creation of graphical symbols — Part 1: Graphical symbols for use on equipment*
- [2] ISO 3864:1984, *Safety colours and safety signs*
- [3] ISO 4196:1984, *Graphical symbols — Use of arrows*
- [4] ISO 7000:1989, *Graphical symbols for use on equipment — Index and synopsis*
- [5] ISO/TR 12100-1:1992, *Safety of machinery — Basic concepts, general principles for design — Part 1: Basic terminology, methodology*
- [6] ISO/TR 12100-2:1992, *Safety of machinery — Basic concepts, general principles for design — Part 2: Technical principles and specifications*
- [7] IEC 417:1973, *Graphical symbols for use on equipment — Index, survey and compilation of the single sheets, and its supplements* (IEC 417A:1974, IEC 417B:1975, IEC 417C:1977, IEC 417D:1978, IEC 417E:1980, IEC 417F:1982, IEC 417G:1985, IEC 417H:1987, IEC 417J:1990, IEC 417K:1991, IEC 417L:1993)



This page intentionally left blank



Uncontrolled Copy, (c) The British Standards Institution 2012



---

---

cultural tractors, forest equipment, horticultural machinery, power horticultural machinery, lawn machines, safety measures, signs, graphic symbols, formats, colour, generalities.

---

---



# British Standards Institution (BSI)

BSI is the independent national body responsible for preparing British Standards and other standards-related publications, information and services.

It presents the UK view on standards in Europe and at the international level.

It is incorporated by Royal Charter.

## Revisions

British Standards are updated by amendment or revision. Users of British Standards should make sure that they possess the latest amendments or editions.

It is the constant aim of BSI to improve the quality of our products and services. We would be grateful if anyone finding an inaccuracy or ambiguity while using this British Standard would inform the Secretary of the technical committee responsible, the identity of which can be found on the inside front cover.

**Tel: +44 (0)20 8996 9001 Fax: +44 (0)20 8996 7001**

BSI offers Members an individual updating service called PLUS which ensures that subscribers automatically receive the latest editions of standards.

**Tel: +44 (0)20 8996 7669 Fax: +44 (0)20 8996 7001**

**Email: [plus@bsigroup.com](mailto:plus@bsigroup.com)**

## Buying standards

You may buy PDF and hard copy versions of standards directly using a credit card from the BSI Shop on the website [www.bsigroup.com/shop](http://www.bsigroup.com/shop). In addition all orders for BSI, international and foreign standards publications can be addressed to BSI Customer Services.

**Tel: +44 (0)20 8996 9001 Fax: +44 (0)20 8996 7001**

**Email: [orders@bsigroup.com](mailto:orders@bsigroup.com)**

In response to orders for international standards, it is BSI policy to supply the BSI implementation of those that have been published as British Standards, unless otherwise requested.

## Information on standards

BSI provides a wide range of information on national, European and international standards through its Knowledge Centre.

**Tel: +44 (0)20 8996 7004 Fax: +44 (0)20 8996 7005**

**Email: [knowledgecentre@bsigroup.com](mailto:knowledgecentre@bsigroup.com)**

Various BSI electronic information services are also available which give details on all its products and services.

**Tel: +44 (0)20 8996 7111 Fax: +44 (0)20 8996 7048**

**Email: [info@bsigroup.com](mailto:info@bsigroup.com)**

BSI Subscribing Members are kept up to date with standards developments and receive substantial discounts on the purchase price of standards. For details of these and other benefits contact Membership Administration.

**Tel: +44 (0)20 8996 7002 Fax: +44 (0)20 8996 7001**

**Email: [membership@bsigroup.com](mailto:membership@bsigroup.com)**

Information regarding online access to British Standards via British Standards Online can be found at [www.bsigroup.com/BSOL](http://www.bsigroup.com/BSOL)

Further information about BSI is available on the BSI website at [www.bsigroup.com/standards](http://www.bsigroup.com/standards)

## Copyright

Copyright subsists in all BSI publications. BSI also holds the copyright, in the UK, of the publications of the international standardization bodies. Except as permitted under the Copyright, Designs and Patents Act 1988 no extract may be reproduced, stored in a retrieval system or transmitted in any form or by any means – electronic, photocopying, recording or otherwise – without prior written permission from BSI. This does not preclude the free use, in the course of implementing the standard of necessary details such as symbols, and size, type or grade designations. If these details are to be used for any other purpose than implementation then the prior written permission of BSI must be obtained. Details and advice can be obtained from the Copyright & Licensing Manager.

**Tel: +44 (0)20 8996 7070**

**Email: [copyright@bsigroup.com](mailto:copyright@bsigroup.com)**

### BSI Group Headquarters

389 Chiswick High Road London W4 4AL UK

Tel +44 (0)20 8996 9001

Fax +44 (0)20 8996 7001

[www.bsigroup.com/standards](http://www.bsigroup.com/standards)

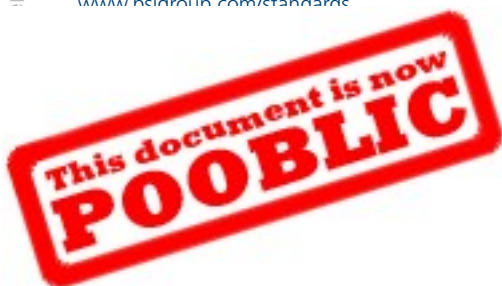

TM

