

Optics and photonics — Preparation of drawings for optical elements and systems —

Part 1: General

ICS 01.100.20; 37.020

National foreword

This British Standard reproduces verbatim ISO 10110-1:2006 and implements it as the UK national standard. It supersedes BS ISO 10110-1:1996 which is withdrawn.

The UK participation in its preparation was entrusted to Technical Committee CPW/172, Optics and optical instruments, which has the responsibility to:

- aid enquirers to understand the text;
- present to the responsible international/European committee any enquiries on the interpretation, or proposals for change, and keep UK interests informed;
- monitor related international and European developments and promulgate them in the UK.

A list of organizations represented on this committee can be obtained on request to its secretary.

Cross-references

The British Standards which implement international publications referred to in this document may be found in the *BSI Catalogue* under the section entitled “International Standards Correspondence Index”, or by using the “Search” facility of the *BSI Electronic Catalogue* or of British Standards Online.

This publication does not purport to include all the necessary provisions of a contract. Users are responsible for its correct application.

Compliance with a British Standard does not of itself confer immunity from legal obligations.

Summary of pages

This document comprises a front cover, an inside front cover, the ISO title page, pages ii to iv, pages 1 to 24, an inside back cover and a back cover.

The BSI copyright notice displayed in this document indicates when the document was last issued.

This British Standard was published under the authority of the Standards Policy and Strategy Committee on 31 July 2006

© BSI 2006

ISBN 0 580 48482 3

Amendments issued since publication

Amd. No.	Date	Comments

INTERNATIONAL
STANDARD

ISO
10110-1

Second edition
2006-07-01

**Optics and photonics — Preparation
of drawings for optical elements and
systems —**

Part 1:
General

*Optique et photonique — Indications sur les dessins pour éléments et
systèmes optiques —*

Partie 1: Généralités



Reference number
ISO 10110-1:2006(E)

Contents

Page

Foreword	iv
1 Scope	1
2 Normative references	1
3 Fundamental stipulations	2
4 Presentation and dimensioning	2
4.1 Views	2
4.2 Axes	4
4.3 Leader lines	5
4.4 Test regions	5
4.5 Test volumes	6
4.6 Dimensioning	8
4.7 Material specification	14
4.8 Indication of tolerances and various properties	14
5 Additional indications for optical layout drawings	16
5.1 General	16
5.2 Axial separations	17
5.3 Images, pupils, field stops and other apertures	19
Annex A (informative) Examples of drawings of optical elements	21
Bibliography	24

Foreword

ISO (the International Organization for Standardization) is a worldwide federation of national standards bodies (ISO member bodies). The work of preparing International Standards is normally carried out through ISO technical committees. Each member body interested in a subject for which a technical committee has been established has the right to be represented on that committee. International organizations, governmental and non-governmental, in liaison with ISO, also take part in the work. ISO collaborates closely with the International Electrotechnical Commission (IEC) on all matters of electrotechnical standardization.

International Standards are drafted in accordance with the rules given in the ISO/IEC Directives, Part 2.

The main task of technical committees is to prepare International Standards. Draft International Standards adopted by the technical committees are circulated to the member bodies for voting. Publication as an International Standard requires approval by at least 75 % of the member bodies casting a vote.

Attention is drawn to the possibility that some of the elements of this document may be the subject of patent rights. ISO shall not be held responsible for identifying any or all such patent rights.

ISO 10110-1 was prepared by Technical Committee ISO/TC 172, *Optics and photonics*, Subcommittee SC 1, *Fundamental standards*.

This second edition cancels and replaces the first edition (ISO 10110-1:1996) which has been technically revised.

ISO 10110 consists of the following parts, under the general title *Optics and photonics — Preparation of drawings for optical elements and systems*:

- *Part 1: General*
- *Part 2: Material imperfections — Stress birefringence*
- *Part 3: Material imperfections — Bubbles and inclusions*
- *Part 4: Material imperfections — Inhomogeneity and striae*
- *Part 5: Surface form tolerances*
- *Part 6: Centring tolerances*
- *Part 7: Surface imperfection tolerances*
- *Part 8: Surface texture*
- *Part 9: Surface treatment and coating*
- *Part 10: Table representing data of optical elements and cemented assemblies*
- *Part 11: Non-toleranced data*
- *Part 12: Aspheric surfaces*
- *Part 14: Wavefront deformation tolerance*
- *Part 17: Laser irradiation damage threshold*

Optics and photonics — Preparation of drawings for optical elements and systems —

Part 1: General

1 Scope

ISO 10110 specifies the presentation of design and functional requirements for optical elements and systems in technical drawings used for manufacturing and inspection.

This part of ISO 10110 specifies the presentation in drawings of the characteristics, especially the tolerances, of optical elements and systems.

Rules for preparation of technical drawings as well as for dimensioning and tolerancing are given in various International Standards. These general standards apply to optical elements and systems only if the necessary rules are not given in the various parts of ISO 10110.

2 Normative references

The following referenced documents are indispensable for the application of this document. For dated references, only the edition cited applies. For undated references, the latest edition of the referenced document (including any amendments) applies.

ISO 128-24, *Technical drawings — General principles of presentation — Part 24: Lines on mechanical engineering drawings*

ISO 406, *Technical drawings — Tolerancing of linear and angular dimensions*

ISO 7944, *Optics and optical instruments — Reference wavelengths*

ISO 8015, *Technical drawings — Fundamental tolerancing principle*

ISO 10110-2, *Optics and optical instruments — Preparation of drawings for optical elements and systems — Part 2: Material imperfections — Stress birefringence*

ISO 10110-3, *Optics and optical instruments — Preparation of drawings for optical elements and systems — Part 3: Material imperfections — Bubbles and inclusions*

ISO 10110-4, *Optics and optical instruments — Preparation of drawings for optical elements and systems — Part 4: Material imperfections — Inhomogeneity and striae*

ISO 10110-5:1996, *Optics and optical instruments — Preparation of drawings for optical elements and systems — Part 5: Surface form tolerances*

ISO 10110-6:1996, *Optics and optical instruments — Preparation of drawings for optical elements and systems — Part 6: Centring tolerances*

ISO 10110-7, *Optics and optical instruments — Preparation of drawings for optical elements and systems — Part 7: Surface imperfection tolerances*

ISO 10110-10:2004, *Optics and optical instruments — Preparation of drawings for optical elements and systems — Part 10: Table representing data of optical elements and cemented assemblies*

ISO 10110-11, *Optics and optical instruments — Preparation of drawings for optical elements and systems — Part 11: Non-toleranced data*

ISO 10110-12, *Optics and optical instruments — Preparation of drawings for optical elements and systems — Part 12: Aspheric surfaces*

ISO 13715, *Technical drawings — Edges of undefined shape — Vocabulary and indications*

3 Fundamental stipulations

All indications in drawings for optical elements and systems shall apply to the finished product, i.e., to its final form, except where other parts of ISO 10110 stipulate otherwise, as for example in ISO 10110-8.

Whenever details or symbols specified in this International Standard are found to be inadequate to clearly define the requirement, the information should be supplemented by a note or special instruction.

All linear dimensions are in millimetres, unless otherwise stated.

All optical data refer to the reference wavelength given in ISO 7944, and to the reference temperature of 20 °C ¹⁾, unless specified otherwise.

Unless specified elsewhere, the omission of a requirement from the drawing shall indicate that the provisions of ISO 10110-11 apply.

Because of the existence of older (national) standards for optical drawings, a possibility of incorrect interpretation of data may exist. For this reason, a reference to ISO 10110 shall appear on each drawing in the form

“Indications in accordance with ISO 10110”

or

“Ind. acc. ISO 10110”

These indications should preferably be associated with the title of the drawing (see Annex A and ISO 10110-10:2004, Figures 1 to 7).

4 Presentation and dimensioning

4.1 Views

Optical elements shall be shown with incident light entering from the left and the optical axis horizontal, unless otherwise specified.

The preferred method is that components be drawn in cross-section and hatched with short-long-short strokes. Back edges and hidden lines should normally be omitted (see Figure 1). However, for the sake of clarity, it may be necessary to include such lines in the case of non-rotationally symmetric elements.

1) 20 °C is the reference temperature in accordance with ISO 1. In the 1996 edition of ISO 10110-1, the default value for the reference temperature was 22 °C.

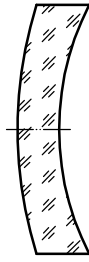

Figure 1 — Hatching

Components of sub-assemblies, such as cemented components, shall be hatched in alternate directions.

For the purpose of simplification, optical parts may be drawn without hatching (see Figure 2). Mixing of hatched and unhatched parts in one drawing shall not be used.

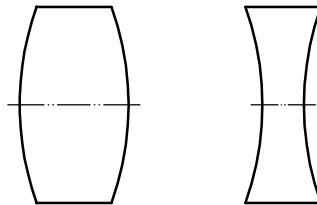

Figure 2 — Simplified drawings of lens elements

Lens elements with surfaces having two meridians of symmetry, such as cylindrical and toric surfaces, shall be drawn in two cross-sections corresponding to these meridians (see Figures 3 and 4). For the presentation of toric surfaces see ISO 10110-12.

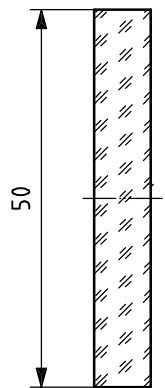
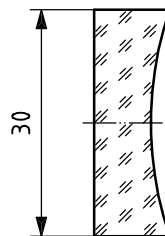

Figure 3 — Rectangular cylindrical lens element

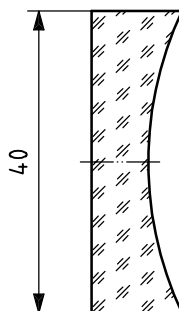
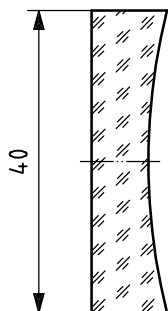

Figure 4 — Square toric lens element

4.2 Axes

Axes shall be drawn as follows:

Rotation axes and centre lines: Line type 04.1, ISO 128-24

Optical axes: Line type 05.1, ISO 128-24

If an optical axis coincides with a rotation axis or centre line, the optical axis shall be drawn. An intentional displacement or tilt of axes (e.g. of the centre line of an element with respect to the optical axis) shall be indicated and dimensioned (see Figure 5). Very small shifts shall be drawn out of scale to exaggerate the displacement.

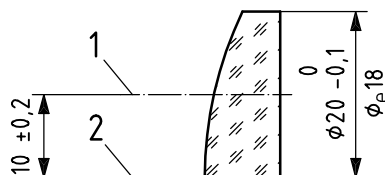

Key

- 1 centre line
- 2 optical axis

Figure 5 — Axes

4.3 Leader lines

Leader lines shall have a dot at the end for leaders terminating within the outline of a part (see Figure 6), and an arrowhead for leaders terminating on the outline (see Figure 7).

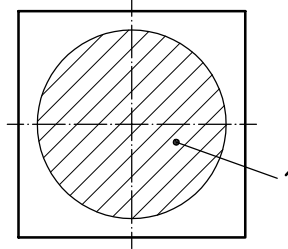

Key

1 test region

Figure 6 — Leader line to an area

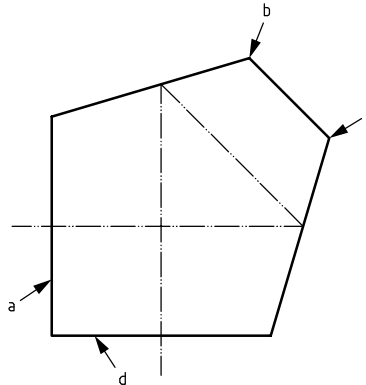

Figure 7 — Leader lines to edges and surfaces

4.4 Test regions

If testing of a complete surface or space is not required, the test regions or optically effective surfaces shall be shown on the drawings. The diameter of circular test regions, the “effective diameter”, shall be indicated by “ \varnothing_e ” (see Figures 8, 18, A.1 and A.2). It defines the region of the component surface which has optical significance.²⁾

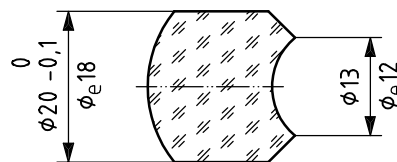

Figure 8 — Test regions

²⁾ Former practice (and specification of the 1996 edition of ISO 10110-1) has been to assign the effective diameter to a surface by a leader line. This is no longer recommended, because it could be misinterpreted as an indication for the radius of curvature.

The boundaries of test regions shall be drawn in continuous narrow lines (line type 01.1, ISO 128-24) and the regions themselves shall be hatched in continuous lines of the same type. They may be subdivided into zones to which different tolerances apply, if required. In such cases, the zones shall be numbered to clarify their relationship. The zone number shall be indicated by a leader to the appropriate area (see Figure 9).

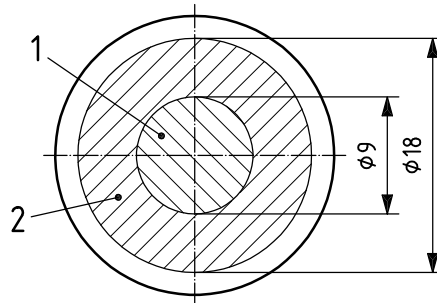

Figure 9 — View showing test regions

Where necessary, special views entitled “test regions” shall be added showing optically effective regions and provided with appropriate dimensional data. If symmetrical components have different test regions (e.g. due to the path of the rays being divergent or convergent) then the regions in question shall be suitably identified to prevent wrong assembly. The same requirement applies if dissimilar test specifications are to be applied to similar test areas. The method of identification should be explained in the drawing (see Figure 10).

If the test regions are not shown, the surfaces count in their full extent as test regions.

A circular test field may be shown in any position within the test region as a dimensioned area bounded by a thin continuous line. Appropriate requirements indicated by a leader to this test field shall apply to all possible positions of the test field within the test region. In this case the diameter of the test field shall be appended to the appropriate tolerance indication as follows: “... (all ϕ ...)” (see Figure 11).

4.5 Test volumes

A test volume shall be indicated if a volume of defined extent must fulfil higher requirements than the rest of the optical element (see Figure 12).

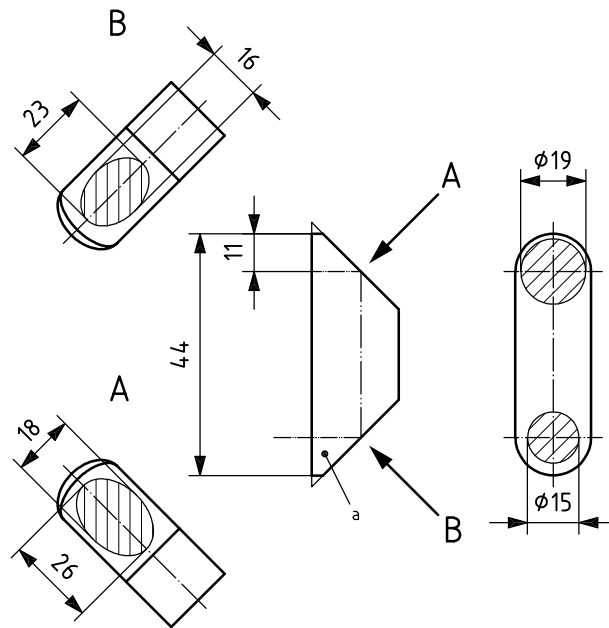

a Mark for identification.

Figure 10 — Different test regions for a prism

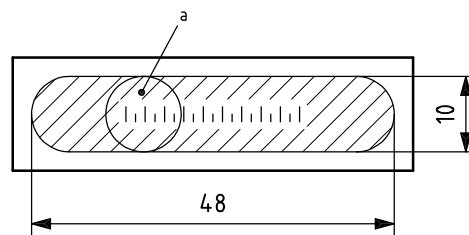

a Tolerance (all $\phi 10$ mm).

Figure 11 — Test field within a test region

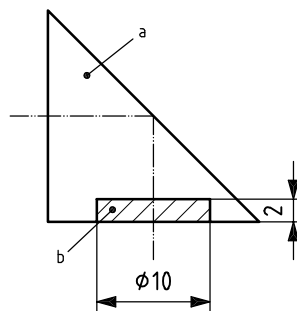

a Normal tolerance for bubbles.
 b Special tolerance for bubbles.

Figure 12 — Test volume

4.6 Dimensioning

4.6.1 General

Fundamentally, the dimensions for optical elements relate to the finished state and therefore include surface treatment such as painting and/or coating. However, in certain cases the dimensions of a part before the application of surface treatments are important. In such cases it shall be explicitly indicated in the drawing that these dimensions refer to the untreated part.

4.6.2 Radius of curvature

Spherical surfaces are defined by stating the radius of curvature with a dimensional tolerance (see Figures 13 to 15).

This tolerance shall indicate the range within which the actual surface shall be contained.

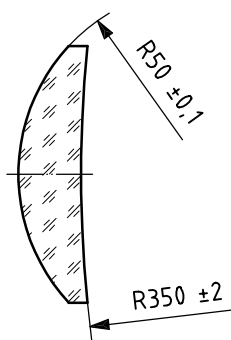

Figure 13 — Radii for a meniscus lens element

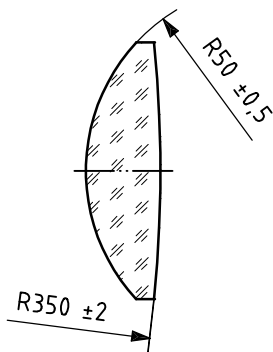

Figure 14 — Radii for a biconvex lens element

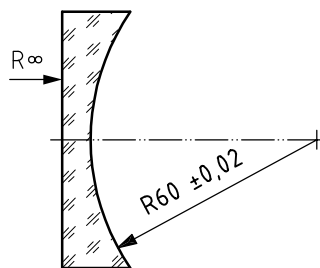

Figure 15 — Radii for a plano-concave lens element

Alternatively, the radius of curvature tolerance may be given in the whole or in part in interferometric terms as defined in ISO 10110-5:1996, Clause 8.

If the total permissible variation of the radius of curvature is given in interferometric terms, the dimensional tolerance of the radius is zero and need not be included in the indication of the radius of curvature.

Plane surfaces (i.e. infinite radius of curvature) shall be indicated by the symbol R_{∞} . The tolerance on flatness shall be indicated in interferometric terms (see ISO 10110-5).

To distinguish between a convex and a concave surface, especially in the case of a weak curvature, the arrow on the leader for the radius indication shall always appear to start from the centre of curvature. Alternatively, a convex surface may be indicated by the letters CX following the radius of curvature indication, and a concave surface by the letters CC.

For toric and cylindrical surfaces, the requirements given in 4.1 apply.

For cylindrical surfaces, the radius shall be indicated by the term "Rcyl".

For aspheric and toric surfaces, see ISO 10110-12.

4.6.3 Thickness

The thickness shall be indicated as a nominal size with a (preferably symmetrical) tolerance. In the case of lens elements having concave surfaces, the overall thickness should be indicated within brackets in addition to the axial thickness (see Figures 16 and 17).

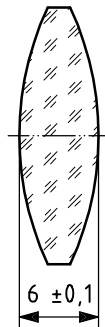

Figure 16 — Thickness indication for a biconvex lens element

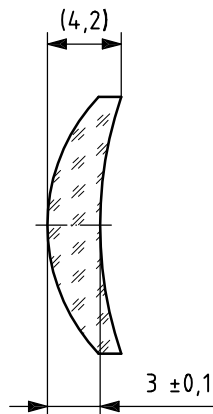

Figure 17 — Thickness indications for a meniscus lens element

4.6.4 Diameter

The diameter of optical parts shall be indicated together with tolerances. The optically effective diameter “ ϕ_e ” shall be added, if required (see Figure 18).

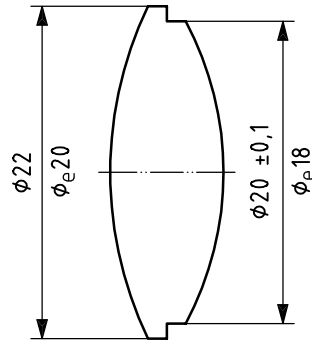

Figure 18 — Diameters and optically effective diameters

4.6.5 Presentation of shapes of edges, bevels and chamfers

4.6.5.1 General

The shape of edges, bevels and chamfers is either determined for design (functional) reasons, or for protective purposes to prevent chipping of sharp edges and corners during production and handling.

4.6.5.2 Functional edges and bevels

Sharp edges: for an edge that must remain sharp for functional reasons, the symbol “0” shall be used (see Figure 19).

Bevels: a bevel is a functional surface replacing a sharp edge, and shall be completely specified with respect to dimension, tolerance, inclination and, if necessary, centring (see Figure 20).

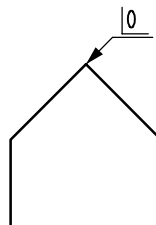

Figure 19 — Sharp edge

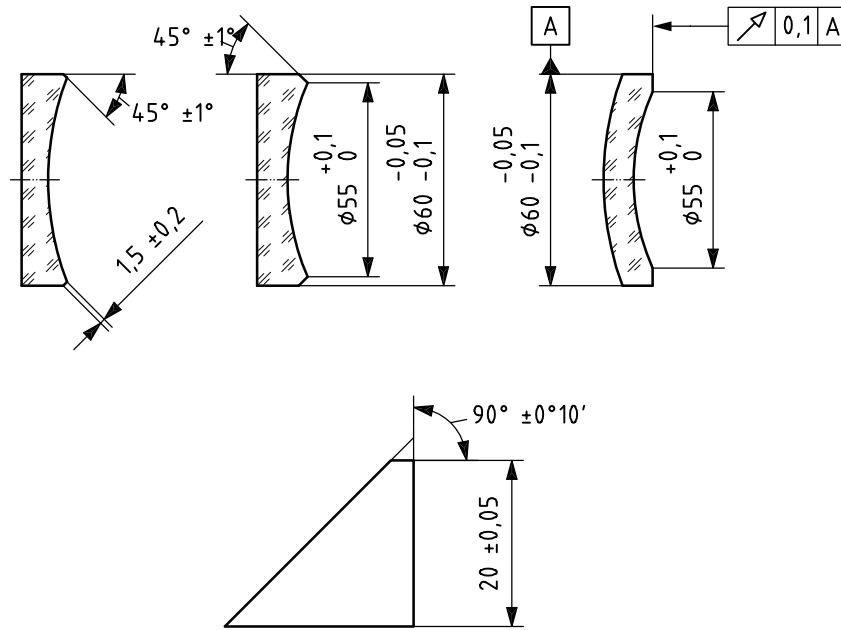

Figure 20 — Dimensioning of bevels

4.6.5.3 Non-functional edges and corners

Protective chamfers: a protective chamfer is a small surface replacing an edge or corner, approximately equally inclined to the surfaces forming the edge or corner. This surface does not need to be individually drawn.

The indication “protective chamfers” shall be included as a note on the drawing to cover all edges and corners that are not individually specified. The width, W , of a chamfer is shown in Figure 21. The minimum and maximum permissible widths of the chamfers shall be indicated in a note; exceptions shall be indicated on the drawing, e.g. using the symbol, defined in ISO 13715 (see Figure 22).

Inside edges: because a perfectly sharp inside edge cannot be produced, it is often necessary to specify the maximum (and occasionally the minimum) permissible width of the edge surface (see Figures 23 to 25). If only one value is indicated, it shall be interpreted as the maximum permissible width.

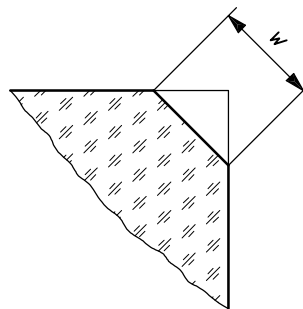
Figure 21 — Width, W , of a protective chamfer

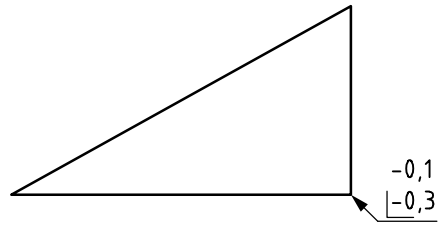

NOTE Protective chamfers 0,2 - 0,5.

Figure 22 — Indication of protective chamfers

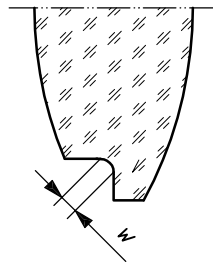

Figure 23 — Width, W , of inside edge

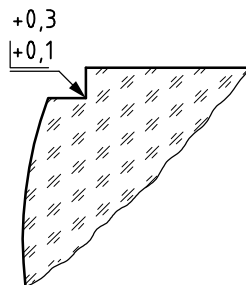

Figure 24 — Lens element step

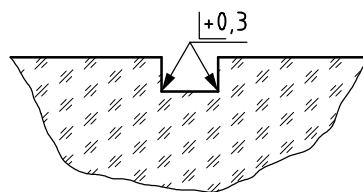

Figure 25 — Prism groove

4.6.6 Linear dimensions

The nominal dimensions for length, width and height (diameter and thickness) of a part, shall be stated with permissible tolerances.

Parts specified to have protective chamfers or small bevels shall be dimensioned without regard to the chamfers or bevels, i.e. the dimensions refer to the theoretical intersection of the surfaces (“sharp edge condition”). Such dimensions shall be identified by appending “theor” to the indication (see Figure 26).

4.6.7 Angles

The nominal values with tolerances shall be stated in the drawing. The surfaces in question shall be indicated by capital Roman letters (see Figure 27).

Figure 27 shows an example of the indication of angles and their tolerances. The angles between surface E and the surfaces A, B, C and D are called “pyramidal angles”.

For prisms, the optical ray path and deflection angle may be shown. The deflection angle is the angle between the directions of the incident and emergent rays. Unless otherwise specified, the incident ray shall be perpendicular to the entrance surface. If specified, the deflection angle shall be given with a \pm tolerance (see Figure 28).

An error in the ray deviation in the directions perpendicular to the plane of the drawing is known as “pyramidal deviation error” [see Figure 28 b)].

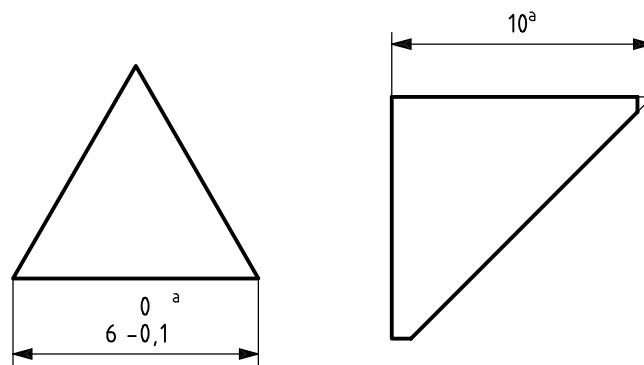

^a Theor.

Figure 26 — Linear dimensions for prisms

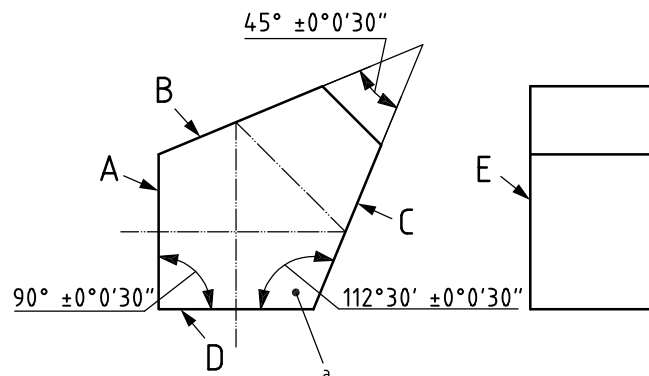

∠ A, E = 90° ± 0° 10'

∠ B, E = 90° ± 0° 3'

∠ D, E = 90° ± 0° 10'

∠ C, E = 90° ± 0° 3'

^a Mark for identification.

Figure 27 — Angles with tolerances

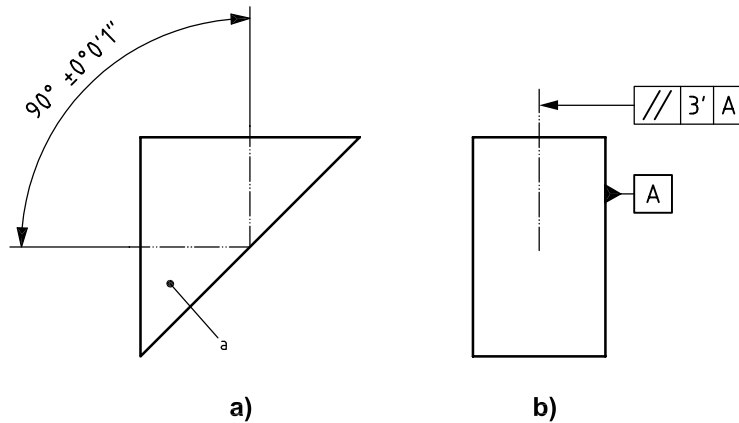

a Mark for identification.

Figure 28 — Prism deflection angles

4.7 Material specification

The information required for the acquisition of the material shall be entered in a box on the drawing.

The following information shall be given, as appropriate:

a) Indication of material, e.g.:

manufacturer, glass type

or international glass code number

or refractive index and Abbe number, including an indication of the reference wavelength

or chemical description (for example for crystalline material);

b) special properties of the material, such as:

tolerances for refractive index, dispersion, transmission, homogeneity class, striae class, crystal properties (e.g. mono- or polycrystalline).

Material properties and tolerances which refer to the individual optical element shall be specified in accordance with ISO 10110-2, ISO 10110-3 and ISO 10110-4.

4.8 Indication of tolerances and various properties

4.8.1 Tolerances for linear and angular dimensions

General rules for indicating tolerances for linear and angular dimensions are given in ISO 406.

If necessary, ISO 8015, which specifies the principle of the relationship between dimensions and geometrical tolerances, shall be observed.

4.8.2 Optical properties and tolerances

Instructions for the indication of numerous properties and tolerances specific for optical parts are given in the various parts of ISO 10110.

4.8.3 Optical sub-assembly

An optical sub-assembly drawing shall include, as appropriate, the following items (see Figure 29):

- element part numbers (or parts list reference numbers);
- details of cement or other method of bonding;
- dimensions and tolerances that are additional to those given in the detail drawings (e.g. centring);
- focal length and/or other requirements;
- special notes regarding assembly and test procedures.

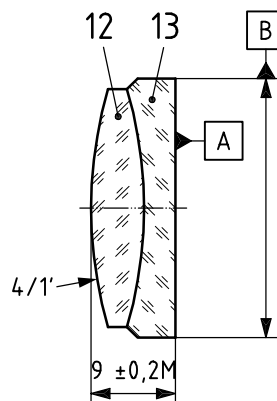

NOTE 1 Cement, according to specification # XXXX.

NOTE 2 Focal length $100 \pm 0,5$.

Figure 29 — Optical sub-assembly

The drawings of parts of sub-assemblies shall contain references to the assembling process, e.g. “to be cemented”.

If a sub-assembly drawing does not contain tolerances for surface form (in accordance with ISO 10110-5) or surface imperfections (in accordance with ISO 10110-7), the tolerances given in the respective element drawings apply after cementing (or optical contacting), where appropriate ³⁾.

If the thickness tolerance of a compound (e.g. cemented) sub-assembly is smaller than the sum of the thickness tolerances of the elements forming the sub-assembly, so that the elements must be matched, the thickness tolerance of the sub-assembly shall be identified with the capital letter “M” (see Figure 29).

4.8.4 Notes

Notes, instructions and additional information shall always be grouped together in one field of the drawing. Each note shall have a number for ease of reference.

3) Imperfection tolerances for cemented surfaces taken from the element drawings may need adjustment to consider the enlarged or reduced view of the imperfections through an optical element.

5 Additional indications for optical layout drawings

5.1 General

An optical layout drawing shall show the relative positions of all components of a complete optical system and shall specify, as appropriate, the following items (see Figure 30):

- a) item references (or parts list reference numbers);
- b) datum (reference) axis (see ISO 10110-6);
- c) separations, including tolerances;
- d) magnification (total and/or partial, as applicable);
- e) object distance, or range of object distances;
- f) full field of view in object space;
- g) numerical aperture or f -number;
- h) position and sizes of field stops;
- i) position(s) and size(s) of image plane(s);
- j) position and sizes of pupils;
- k) dimensions of clear apertures and physical sizes of parts;
- l) position(s) and size(s) of focal plane(s);
- m) spectral passband;
- n) movements required for magnification and focus adjustment;
- o) mounting interface data;
- p) centring data (see ISO 10110-6);
- q) special notes regarding assembly and test procedures;
- r) other performance requirements.

If no datum axis for centring tolerances (see ISO 10110-6) is indicated in a layout-drawing, all centring tolerances refer to the theoretical optical axis.

NOTE 1 For the sake of clarity, it is sometimes useful to indicate certain data in tabular form.

NOTE 2 In cases where optical systems have complex, folded paths it may be necessary to show isometric views.

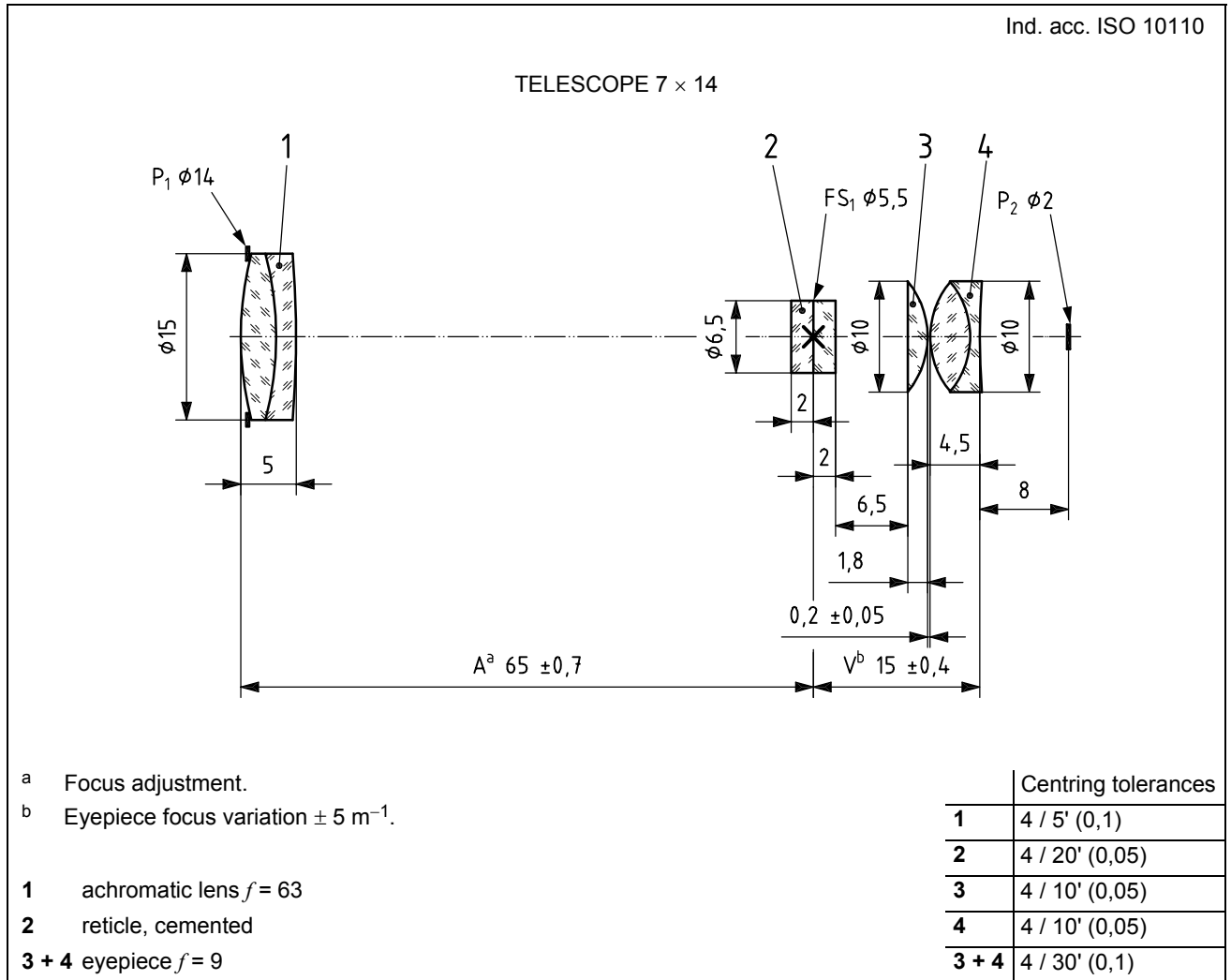

Figure 30 — Optical layout drawing

5.2 Axial separations

5.2.1 General

Separations between the elements shall be indicated along the datum axis (see ISO 10110-6:1996, 3.3). For axially symmetric systems this axis is the centre line.

Distances which are to be adjusted during assembly, or varied during use, shall be indicated on the optical layout drawing, together with a short explanatory note giving the reasons for the adjustment or variation.

5.2.2 Fixed axial separations

Fixed separation distances shall be shown by the nominal design dimension with the permitted tolerance (see Figure 31).

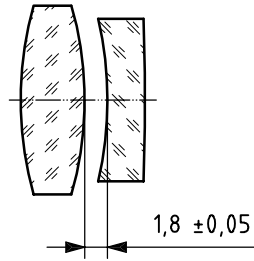
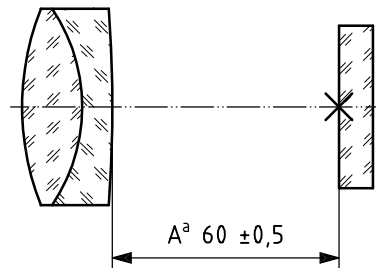

Figure 31 — Air space between lens elements

5.2.3 Adjustable axial separations

During assembly, some axial separations may be varied within pre-determined limits in order to achieve a specific condition or requirement. Such adjustable distances shall be identified with the capital letter “A”, and the reason for the adjustment shall be given in a note. If necessary, the required accuracy of adjustment shall also be given. The dimensional information shall be shown on the drawing in the following order (see Figure 32):

- a) the letter “A” to identify that the distance is to be adjusted;
- b) the nominal distance;
- c) the permissible limits of adjustment from the nominal value.



^a Adjust for best focus, accuracy of adjustment $\pm 0,02$.

Figure 32 — Adjustable axial separation

5.2.4 Variable axial separations

Some axial distances may need to be varied by the user of the complete system. These shall be identified by the letter “V”. The extent of variation together with the reason for the variation shall be shown in the drawing (see Figure 33). If necessary, the required accuracy shall also be given.

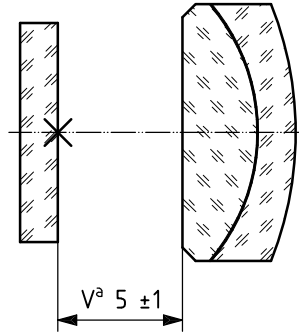

^a Eyepiece focus variation $\pm 3 \text{ m}^{-1}$.

Figure 33 — Variable axial separation

5.3 Images, pupils, field stops and other apertures

Positions and sizes of images, pupils, field stops and other apertures in optical layout drawings shall be drawn as follows:

- the position of an image shall be drawn as a cross on the optical axis (see Figures 34 and 35);
- the position of a pupil shall be drawn as a short continuous thick line (line type 01.2, ISO 128-24) across the optical axis (see Figure 36);
- physical apertures shall be drawn as continuous thick lines (line type 01.2, ISO 128-24) defining position; sizes should be drawn as continuous narrow lines (line type 01.1, ISO 128-24) parallel to the axis (see Figures 37 and 38); other apertures shall be drawn in a similar manner, but in dashed thick lines (line type 02.2, ISO 128-24) (see Figure 39).

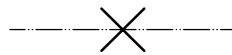

Figure 34 — Indication of image position (in space)

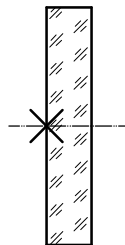

Figure 35 — Indication of image position (on a surface)

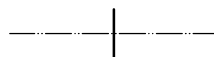

Figure 36 — Pupil position

If required, field stops shall be marked FS_1 , FS_2 , etc., pupils shall be marked P_1 , P_2 , etc., following the path of the incident light (see Figures 37 and 38).

Dimensions of field stops, pupils and images shall be shown adjacent to the stop, pupil or image (see examples in Figures 37 to 39).

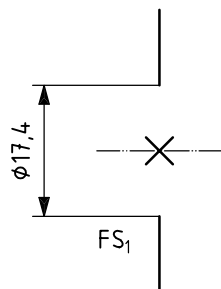

Figure 37 — Physical aperture (field stop)

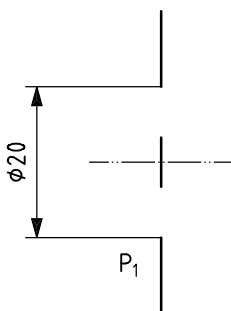

Figure 38 — Physical aperture located at the pupil P_1

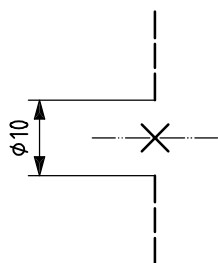

Figure 39 — Image without physical aperture

Annex A
(informative)

Examples of drawings of optical elements

Figures A.1 to A.3 are drawn in accordance with ISO 10110-1 to ISO 10110-9 and ISO 10110-17.

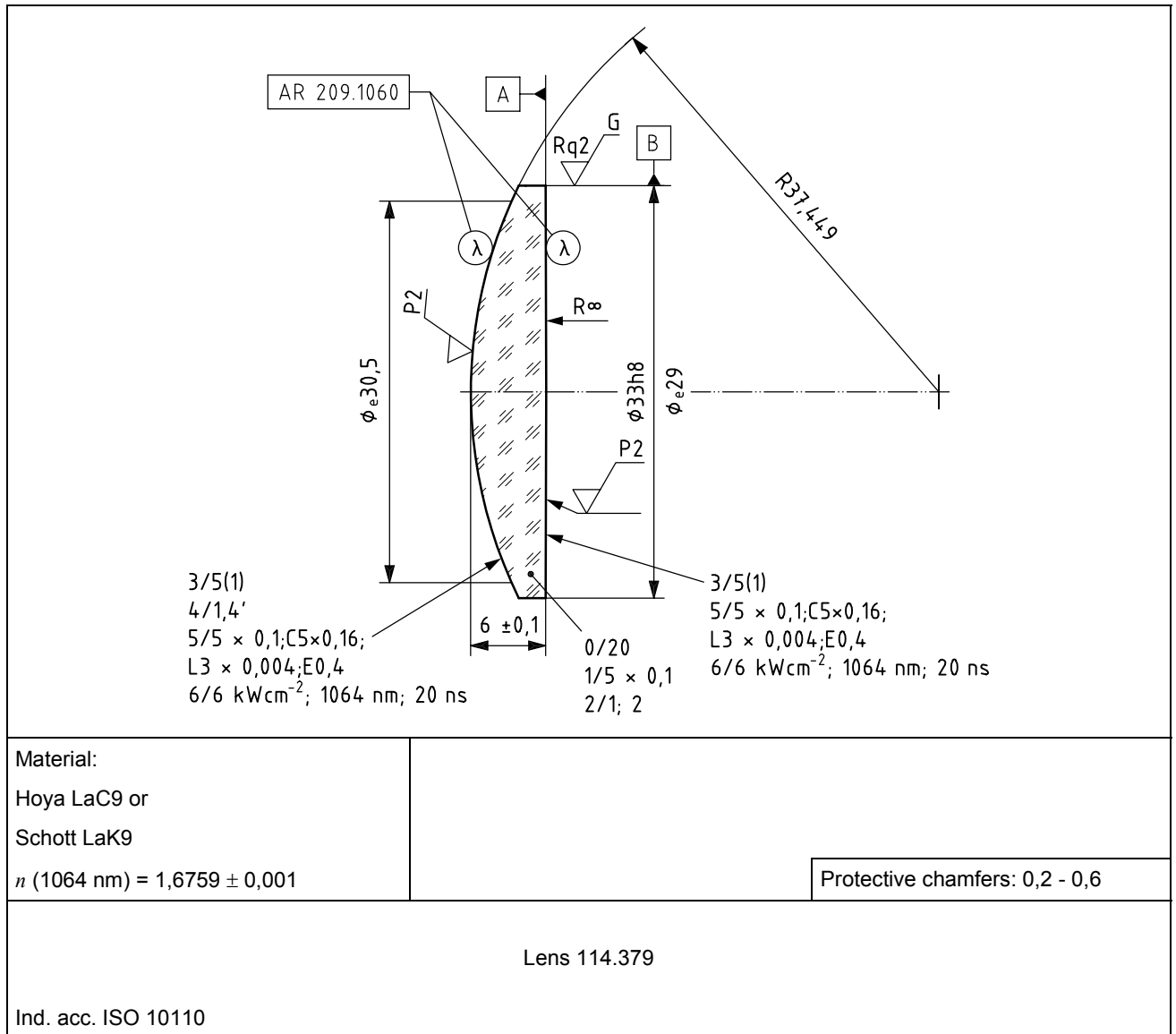

Figure A.1 — Example of a lens element drawing

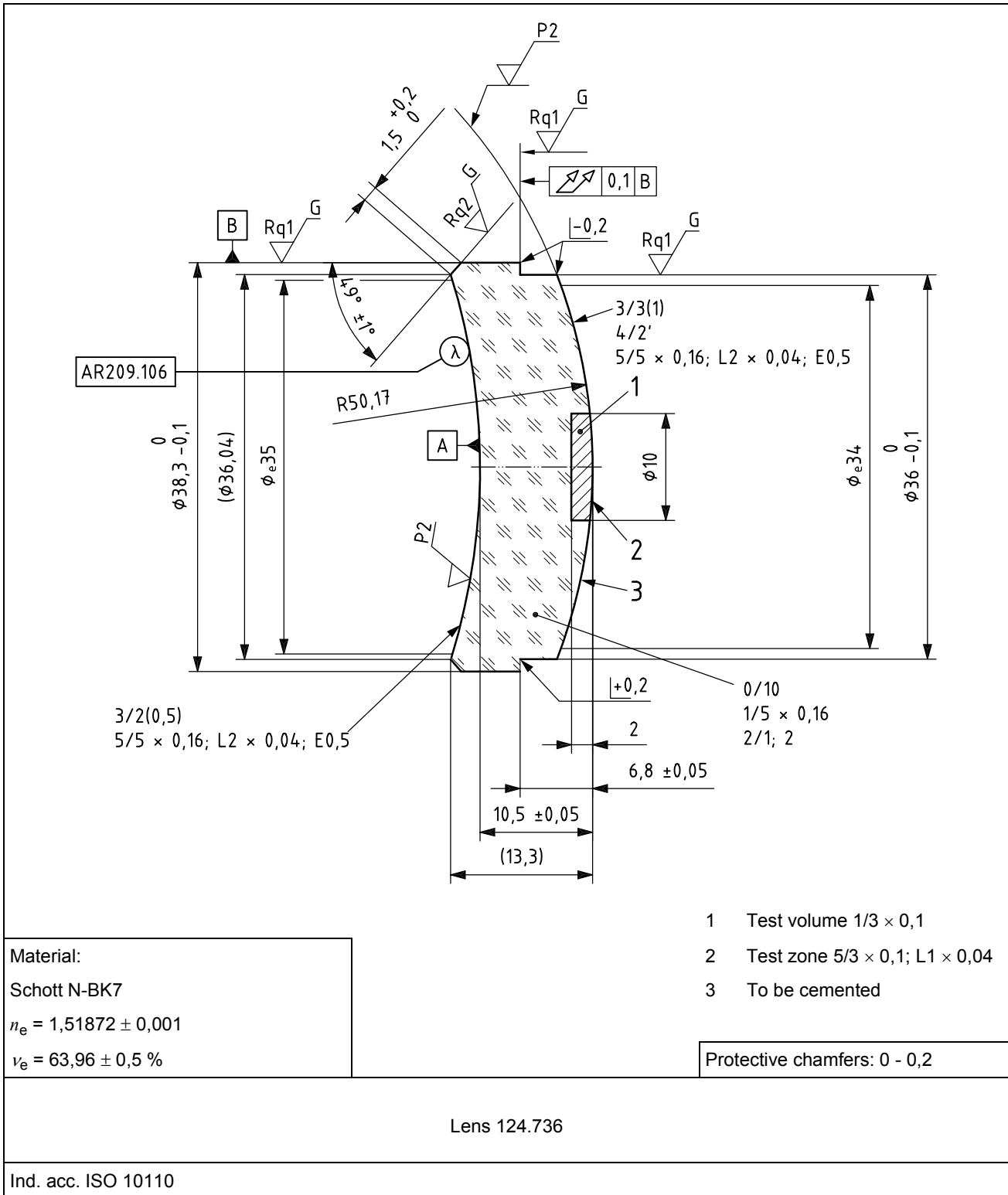

Figure A.2 — Example of a lens element drawing

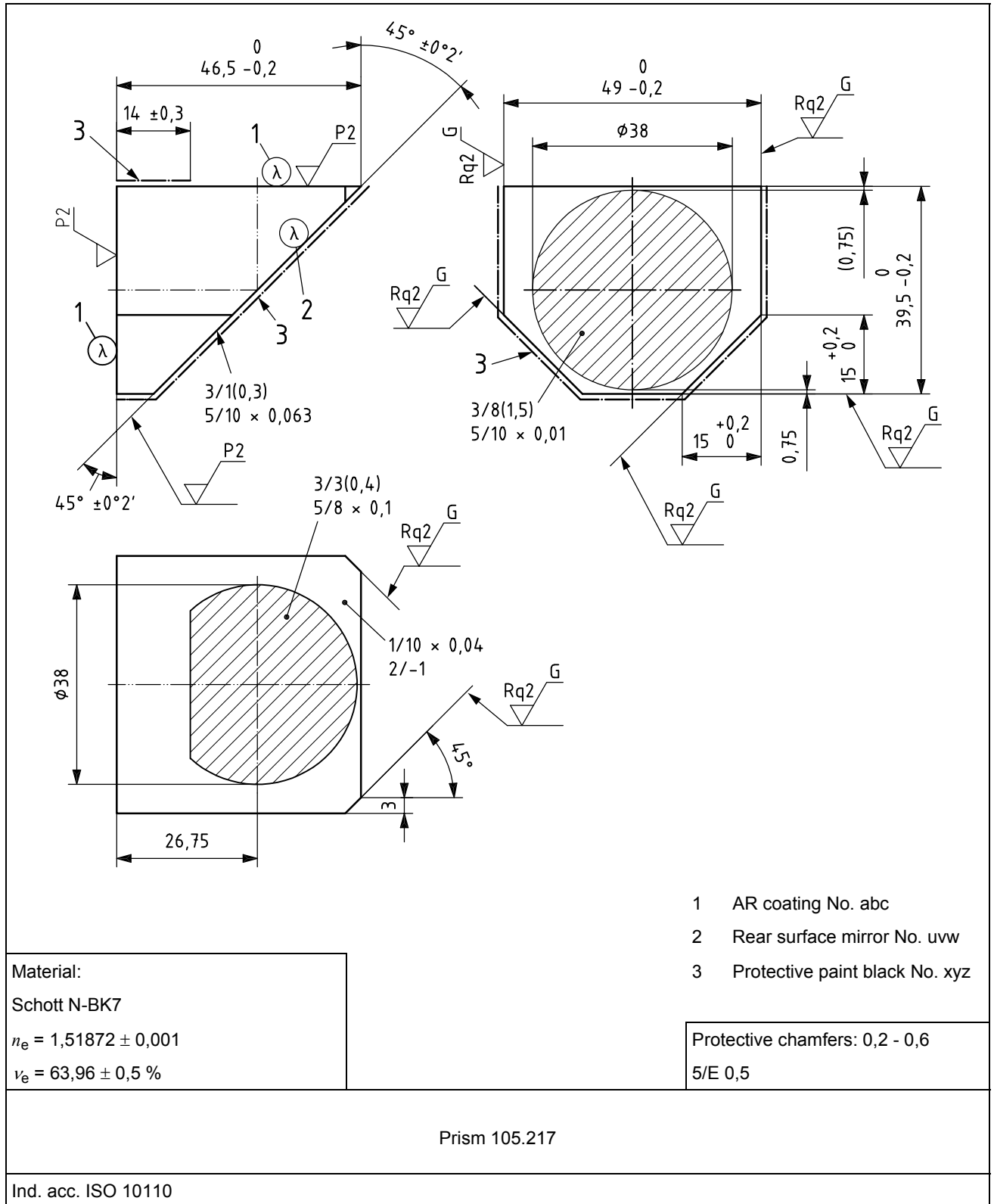

Figure A.3 — Example of a prism drawing

Bibliography

- [1] ISO 1, *Geometrical Product Specifications (GPS) — Standard reference temperature for geometrical product specification and verification*
- [2] ISO 10110-8, *Optics and optical instruments — Preparation of drawings for optical elements and systems — Part 8: Surface texture*
- [3] ISO 10110-9, *Optics and optical instruments — Preparation of drawings for optical elements and systems — Part 9: Surface treatment and coating*
- [4] ISO 10110-17, *Optics and photonics — Preparation of drawings for optical elements and systems — Part 17: Laser irradiation damage threshold*

BSI — British Standards Institution

BSI is the independent national body responsible for preparing British Standards. It presents the UK view on standards in Europe and at the international level. It is incorporated by Royal Charter.

Revisions

British Standards are updated by amendment or revision. Users of British Standards should make sure that they possess the latest amendments or editions.

It is the constant aim of BSI to improve the quality of our products and services. We would be grateful if anyone finding an inaccuracy or ambiguity while using this British Standard would inform the Secretary of the technical committee responsible, the identity of which can be found on the inside front cover.
Tel: +44 (0)20 8996 9000. Fax: +44 (0)20 8996 7400.

BSI offers members an individual updating service called PLUS which ensures that subscribers automatically receive the latest editions of standards.

Buying standards

Orders for all BSI, international and foreign standards publications should be addressed to Customer Services. Tel: +44 (0)20 8996 9001.
Fax: +44 (0)20 8996 7001. Email: orders@bsi-global.com. Standards are also available from the BSI website at <http://www.bsi-global.com>.

In response to orders for international standards, it is BSI policy to supply the BSI implementation of those that have been published as British Standards, unless otherwise requested.

Information on standards

BSI provides a wide range of information on national, European and international standards through its Library and its Technical Help to Exporters Service. Various BSI electronic information services are also available which give details on all its products and services. Contact the Information Centre.
Tel: +44 (0)20 8996 7111. Fax: +44 (0)20 8996 7048. Email: info@bsi-global.com.

Subscribing members of BSI are kept up to date with standards developments and receive substantial discounts on the purchase price of standards. For details of these and other benefits contact Membership Administration.
Tel: +44 (0)20 8996 7002. Fax: +44 (0)20 8996 7001.
Email: membership@bsi-global.com.

Information regarding online access to British Standards via British Standards Online can be found at <http://www.bsi-global.com/bsonline>.

Further information about BSI is available on the BSI website at <http://www.bsi-global.com>.

Copyright

Copyright subsists in all BSI publications. BSI also holds the copyright, in the UK, of the publications of the international standardization bodies. Except as permitted under the Copyright, Designs and Patents Act 1988 no extract may be reproduced, stored in a retrieval system or transmitted in any form or by any means – electronic, photocopying, recording or otherwise – without prior written permission from BSI.

This does not preclude the free use, in the course of implementing the standard, of necessary details such as symbols, and size, type or grade designations. If these details are to be used for any other purpose than implementation then the prior written permission of BSI must be obtained.

Details and advice can be obtained from the Copyright & Licensing Manager.
Tel: +44 (0)20 8996 7070. Fax: +44 (0)20 8996 7553.
Email: copyright@bsi-global.com.