

BS ISO 9459-4:2013



BSI Standards Publication

Solar heating — Domestic water heating systems

Part 4: System performance characterization by means of component tests and computer simulation

bsi.

...making excellence a habit.™

National foreword

This British Standard is the UK implementation of ISO 9459-4:2013.

The UK participation in its preparation was entrusted to Technical Committee RHE/25, Solar Heating.

A list of organizations represented on this committee can be obtained on request to its secretary.

This publication does not purport to include all the necessary provisions of a contract. Users are responsible for its correct application.

© The British Standards Institution 2013. Published by BSI Standards Limited 2013

ISBN 978 0 580 66360 4

ICS 27.160; 97.100.99

Compliance with a British Standard cannot confer immunity from legal obligations.

This British Standard was published under the authority of the Standards Policy and Strategy Committee on 28 February 2013.

Amendments issued since publication

Date	Text affected
------	---------------

**Solar heating — Domestic water heating
systems —**

Part 4:

**System performance characterization by
means of component tests and computer
simulation**

Chauffage solaire — Systèmes de chauffage de l'eau sanitaire —

*Partie 4: Caractérisation de la performance des systèmes au moyen
d'essais effectués sur les composants et par simulation sur ordinateur*





COPYRIGHT PROTECTED DOCUMENT

© ISO 2013

All rights reserved. Unless otherwise specified, no part of this publication may be reproduced or utilized in any form or by any means, electronic or mechanical, including photocopying and microfilm, without permission in writing from either ISO at the address below or ISO's member body in the country of the requester.

ISO copyright office
Case postale 56 • CH-1211 Geneva 20
Tel. + 41 22 749 01 11
Fax + 41 22 749 09 47
E-mail copyright@iso.org
Web www.iso.org

Published in Switzerland

Contents

Page

Foreword	iv
0 Introduction.....	v
1 Scope	1
2 Normative references	1
3 Terms and definitions	1
4 Symbols, units and nomenclature	3
5 Application	6
6 Test method	7
6.1 Introduction.....	7
6.2 Component testing.....	7
6.3 Water heater configuration for modelling.....	9
7 Performance evaluation.....	10
7.1 Annual task performance	10
7.2 Weather data	10
7.3 Thermal energy loads	11
7.4 Thermostat set temperature	11
7.5 Cold water inlet temperature	11
7.6 Pump circulation control	11
7.7 Simulation deck setup for modelling thermal stratification in storage tanks.....	12
7.8 Piping configuration for solar water heaters.....	13
7.9 Controllers	14
7.10 Energy consumed for freeze protection	14
7.11 Over-temperature control	15
7.12 Modelling gas storage water heaters	15
7.13 Modelling instantaneous gas water heaters.....	16
7.14 Presentation of results.....	17
7.15 Extension of simulation model for new products.....	19
Annex A (normative) Water heater parameters	20
Annex B (normative) Storage vessel performance	34
Annex C (normative) Integral collector storage unit test method	37
Annex D (normative) Corrections for effect of hail guards on solar collector efficiency	41
Annex E (normative) PV powered DC pumps in solar water heating systems	43
Annex F (normative) Heat exchanger test methods.....	50
Annex G (normative) Reference conditions for testing and performance prediction	58
Annex H (informative) Example simulation models	63
Annex I (informative) Guidelines for equipment suppliers.....	67
Annex J (informative) Guidelines for Certification Bodies	68
Bibliography.....	70

Foreword

ISO (the International Organization for Standardization) is a worldwide federation of national standards bodies (ISO member bodies). The work of preparing International Standards is normally carried out through ISO technical committees. Each member body interested in a subject for which a technical committee has been established has the right to be represented on that committee. International organizations, governmental and non-governmental, in liaison with ISO, also take part in the work. ISO collaborates closely with the International Electrotechnical Commission (IEC) on all matters of electrotechnical standardization.

International Standards are drafted in accordance with the rules given in the ISO/IEC Directives, Part 2.

The main task of technical committees is to prepare International Standards. Draft International Standards adopted by the technical committees are circulated to the member bodies for voting. Publication as an International Standard requires approval by at least 75 % of the member bodies casting a vote.

Attention is drawn to the possibility that some of the elements of this document may be the subject of patent rights. ISO shall not be held responsible for identifying any or all such patent rights.

ISO 9459-4 was prepared by Technical Committee ISO/TC 180, *Solar energy*, Subcommittee SC 4, *Systems — Thermal performance, reliability and durability*.

ISO 9459 consists of the following parts, under the general title *Solar heating — Domestic water heating systems*:

- *Part 1: Performance rating procedure using indoor test methods*
- *Part 2: Outdoor test methods for system performance characterization and yearly performance prediction of solar-only systems*
- *Part 4: System performance characterization by means of component tests and computer simulation*
- *Part 5: System performance characterization by means of whole-system tests and computer simulation*

0 Introduction

ISO 9459 has been developed to help facilitate the international comparison of solar domestic water heating systems. Because a generalized performance model which is applicable to all systems has not yet been developed, it has not been possible to obtain an international consensus for one test method and one standard set of test conditions. It has therefore been decided to promulgate the currently available simple test methods while work continues to finalize the more broadly applicable procedures. The advantage of this approach is that each part can proceed on its own.

0.1 General

ISO 9459 is divided into four parts within three broad categories, as described below.

0.2 Rating test

ISO 9459-1, *Solar heating — Domestic water heating systems — Part 1: Performance rating procedure using indoor test methods*, involves testing for periods of one day for a standardized set of reference conditions. The results, therefore, allow systems to be compared under identical solar, ambient and load conditions.

0.3 Black box correlation procedures

ISO 9459-2, *Solar heating — Domestic water heating systems — Part 2: Outdoor test methods for system performance characterization and yearly performance prediction of solar-only systems*, is applicable to solar-only systems and solar-preheat systems. The performance test for solar-only systems is a “black box” procedure which produces a family of “input-output” characteristics for a system. The test results may be used directly with daily mean values of local solar irradiation, ambient air temperature and cold water temperature data to predict annual system performance.

0.4 Testing and computer simulation

ISO 9459-4, *Solar heating — Domestic water heating systems — Part 4: System performance characterization by means of component tests and computer simulation*, a procedure for characterizing annual system performance, uses measured component characteristics in a computer simulation program. Procedures for characterizing the performance of system components other than collectors are also presented in this part of ISO 9459. Procedures for characterizing the performance of collectors are given in other International Standards.

ISO 9459-5, *Solar heating — Domestic water heating systems — Part 5: System performance characterization by means of whole-system tests and computer simulation*, presents a procedure for dynamic testing of complete systems to determine system parameters for use in the “Dynamic System Testing Program”. This software has been validated on a range of systems; however, it is a proprietary product and cannot be modified by the user. Implementation of the software requires training from a test facility experienced with the application of the product. This model may be used with hourly values of local solar irradiation, ambient air temperature and cold water temperature data to predict annual system performance.

The procedures defined in ISO 9459-2, ISO 9459-4 and ISO 9459-5 for predicting yearly performance allow the output of a system to be determined for a range of climatic conditions.

The results of tests performed in accordance with ISO 9459-1 provide a rating for a standard day.

The results of tests performed in accordance with ISO 9459-2 permit performance predictions for a range of system loads and operating conditions, but only for an evening draw-off.

0.5 Introduction to ISO 9459-4

ISO 9459-4 presents a procedure predicting the annual performance of a solar thermal system using a numerical simulation programme. The parameters of the characterisation of the thermal behaviour of the key components such as solar collector, store and controller are derived from physical tests of the components.

Because testing of the complete system as a whole is especially expensive and time consuming for system families, this approach offers the opportunity to determine the annual performance of a family of systems with limited effort.

NOTE A system family is characterised by a series of hot water systems that are identical with regard to their construction and only differ in their collector and storage dimension. An identical construction is given if the set-up of the system is similar (pipes, electrical pump, hydraulic connections, type but not mandatorily size of the heat exchanger), the insulation concept is similar (material, thickness) and the collectors installed are from the same type.

Procedures exist for testing most solar thermal system components. Where they exist, they are referenced. In case no standardised component test procedures are available appropriate procedures have to be used to determine the thermal characteristics of the components.

The intention of this International Standard is to determine the thermal performance of the system. Therefore, it is assumed that all key components (e.g., collectors, stores, heat exchangers, etc.) used in the system are subjected to relevant durability tests (e.g., collector qualification tests, pressurization of the collector side of the heat exchanger, etc.) before they are tested for thermal performance.

In order to ensure a proper operation of the entire system additional durability tests may be required of the complete system to determine operation under extreme conditions such as freezing or overheating based on corresponding standards.

The performance evaluation procedure defined in this International Standard has been designed to provide a means of evaluating the annual task performance of heated water systems.

This International Standard sets out a method of evaluating the annual energy performance of heated water systems using a combination of test results for component performance and a mathematical model to determine an annual load cycle task performance. This International Standard defines a procedure for evaluating the task performance of conventional electric and gas domestic water heaters so that the energy savings of solar and heat pump water heaters can be evaluated relative to conventional water heaters operated under the same annual task load.

The performance evaluations are based on modelling annual performance in a range of climatic conditions using a simulation program. The chosen simulation program shall have flexibility and the capacity to model the wide range of renewable energy water heaters used worldwide.

The procedure for using this International Standard is illustrated in the figure below. The general concept is to develop computer models that describe the performance of every component of the solar water heating system. These models can be based on specific tests (listed herein and in EN 12977-2 and AS/NZS 4234). These models are then combined in a system simulation that can be used to estimate the performance of the complete solar heating system under specified hot water usage and weather conditions. Information for users of this International Standard is presented in Annexes I and J.

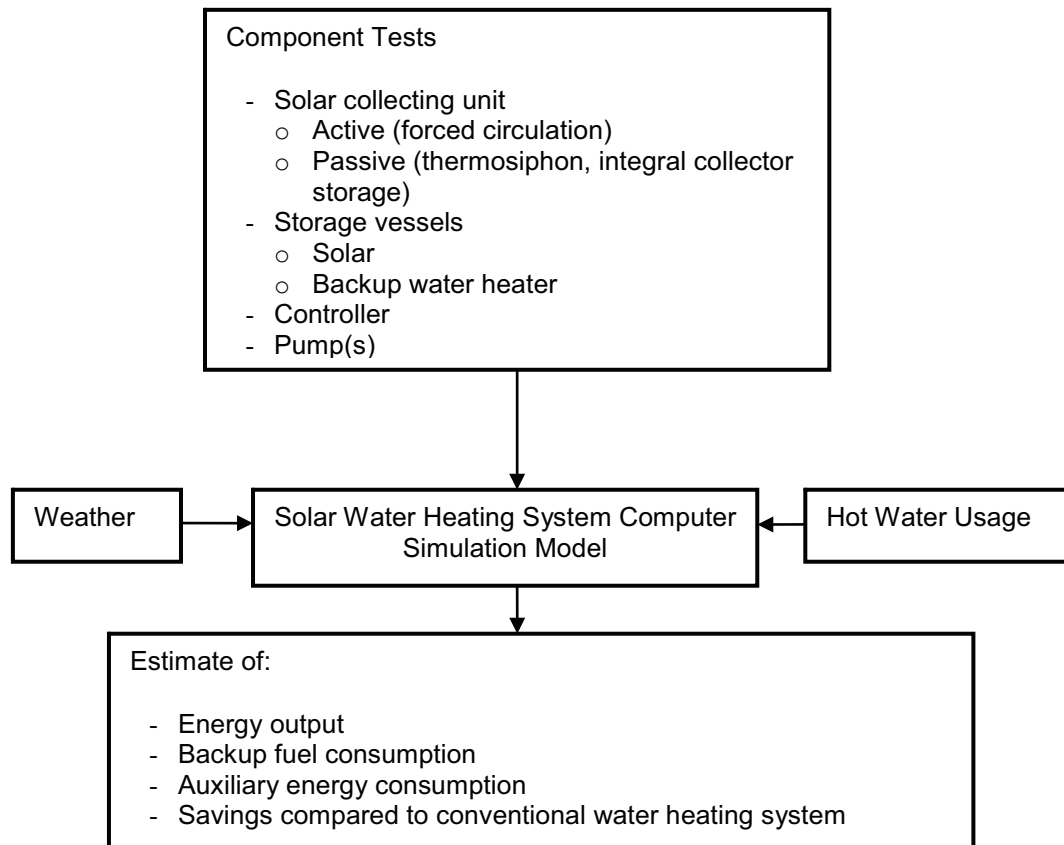

It is the intent of this part of ISO 9459 to be compatible with EN 12977-2, "Thermal solar systems and components, Custom built systems, Test methods" such that tests conducted for use by certification bodies can be done in accordance with either one interchangeably.

The terms "normative" and "informative" have been used in this International Standard to define the application of the annex to which they apply. A "normative" annex is an integral part of an International Standard, whereas an "informative" annex is only for information and guidance.

Solar heating — Domestic water heating systems —

Part 4:

System performance characterization by means of component tests and computer simulation

1 Scope

This International Standard specifies a method of evaluating the annual energy performance of solar water heaters using a combination of test results for component performance and a mathematical model to determine an annual load cycle task performance under specified weather and load conditions. The procedure is applicable to solar water heaters with integral backup or preheating into a conventional storage or instantaneous water heater and to integral collector storage water heaters.

System operating requirements specified in this International Standard are for the purpose of determining an annual performance rating for domestic water heaters. There are no product design or operation requirements in this International Standard.

2 Normative references

The following referenced documents are indispensable for the application of this document. For dated references, only the edition cited applies. For undated references, the latest edition of the referenced document (including any amendments) applies.

ISO 9488:1999, *Solar energy — Vocabulary*

ISO 9806 (all parts), *Test methods for solar collectors*

EN 12977 (all parts):2012, *Thermal solar systems and components — Custom built systems*

EN 12975 (all parts):2006, *Thermal solar systems and components — Solar collectors*

EN 12976 (all parts):2006, *Thermal solar systems and components — Factory made systems*

AS 1056.1:1991, *Storage water heaters — General requirements*

AS/NZS 2712:2007, *Solar and heat pump water heaters — Design and construction*

AS/NZS 2535:2007, *Test methods for solar collectors*

3 Terms and definitions

For the purposes of this document, the terms and definitions given in ISO 9488 and the following apply.

There are two differences with ISO 9488-1999:

- auxiliary energy is used here to represent energy consumed by pumps, fans, and controls in a solar heating system
- backup energy refers to energy contributed by a source other than solar

**3.1
tilt angle**

angle between the absorbing surface of the collector and the horizontal

**3.2
container**

vessel including fittings, in which the heated water is stored; sometimes referred to as a store, storage container, cylinder, storage vessel, or tank

**3.3
electricity supply options**

**3.3.1
continuous**

continuously available electricity supply

**3.3.2
limited time of supply**

electric supply available at limited times, as follows:

**3.3.2.1
night rate**

electricity supply at restricted night hours (see Annexes A and B for typical availability times)

**3.3.2.2
extended off-peak**

electricity supply during extended hours (see Annexes A and B for typical availability times)

**3.4
dual element tanks**

tanks incorporating dual electric elements at different levels in the tank

Note: Each element may be connected to a different electric supply or be operated under local control.

**3.5
heat pump water heater, solar assisted**

a system incorporating a compressor (vapour compression), an evaporator exposed to ambient air or solar radiation, or both, a condenser and a water container heated either directly or indirectly by the condenser

**3.6
one-shot backup**

operation of a backup heat source for one heating cycle

Note: The heater is returned to normal control after one heating cycle.

**3.7
factory-made solar water heater**

package systems are batch products, sold as complete and ready to install kits with fixed configurations

Note: Systems of this category are considered as a single product and assessed as a whole.

3.8

reference water heater

a conventional water heater used to define annual purchased energy use for the purpose of computing energy savings of other products

3.9

tank nodes

horizontal sections of a storage tank

Note: Used in the simulation program to model thermal stratification in the storage tank.

3.10

tank modelling options

3.10.1

fixed inlet positions

fluid flows into the storage tank are considered to mix with the contents of the tank node at the same level with the inlet fitting

3.10.2

variable inlet positions

fluid flows into the storage tank are considered to rise or fall to the level of the tank node with the closest temperature to the inlet flow

3.11

computer simulation model

TRNSYS or equivalent computer program used to simulate the performance of solar water heating components and systems

4 Symbols, units and nomenclature

Symbol	Units	Meaning
a, b, c	[-]	correlation coefficients for solar collector efficiency
B_c	[MJ/year]	annual energy used by a conventional water heater
B_e	[MJ/year]	annual electrical energy used by water heater
B_g	[MJ/year]	annual gas energy used by water heater
B_s	[MJ/year]	annual backup energy for a solar or heat pump water heater
C_p	[kJ/(kg C)]	heat capacity
C_{rmod}	[-]	modified capacity ratio
DE	[MJ]	difference in energy content of a tank between the start and the end of a heat loss or warm-up test
d	[m]	diameter
e_n	[W]	electrical power use during burner operation
e_{sb}	[W]	electrical power use during standby
E	[%]	thermal efficiency of gas water heater

E_g	[MJ/year]	integrated energy added to tank from gas combustion
f_R	[-]	purchased energy savings relative to a conventional water heater $(B_c - B_s)/B_c$
G_b	[Wm ⁻²]	beam irradiance on the collector aperture
G_L	[Wm ⁻²]	net long wave irradiance ($\lambda > 3\mu\text{m}$) ($G_s - \sigma T_a^4$)
G_o	[Wm ⁻²]	extraterrestrial solar irradiance
G_r	[-]	Grashoff number
G_S	[Wm ⁻²]	long wave thermal irradiance ($\lambda > 3\mu\text{m}$)
G_T	[Wm ⁻²]	hemispherical solar irradiance on the collector aperture
h	[W/m ² K]	heat loss coefficient
K_{Ta}	[-]	solar collector angle modifier
K_{NS}, K_{EW}	[-]	bi-axial incidence angle modifiers
K_T	[-]	average clearness index for specified test
M	[MJ/h]	maintenance rate [standing or stand-by heat loss rate from a heated water tank]
M_{drawn}	[kg]	mass withdrawn from the storage vessel
M_{rate}	[kg/s]	mass flow rate
M_{sys}	[kg/s]	mass flow rate through a system
$M_{\text{tank}} * C_p$	[kJ/K]	capacitance
n	[-]	Julian day of the year (1-365) N [-] number of events
ΔP	[Pa]	pressure drop
Pr	[-]	Prandtl number
Q_{del}	[kJ]	energy purged from the system after the wait or irradiance period
Q_{initial}	[Lj]	initial charge energy of a tank or system when subjected to an instantaneous purge between two set temperatures.
R	[MJ/h]	determined gas consumption
Re	[-]	Reynolds number
t	[h:min:s]	duration of test
$\text{Time}_{\text{decay}}$	[s]	decay test duration
T	[°C]	temperature
\bar{T}	[°C]	mean collector fluid temperature

T_a	[°C]	ambient temperature
$\bar{T}_{a, \text{avg}}$	[°C]	annual average ambient outdoor air temperature T_{db} [K] thermostat dead band
T_{del}	[°C]	temperature of the water delivered from the DHW system at the outlet of the system
T_i	[°C]	collector inlet fluid temperature
\bar{T}_W	[°C]	mean temperature of water in the storage tank
T_{env}	[°C]	environment temperature (ie. temperature of air surrounding the storage vessel)
$T_{env \text{ ave}}$	[°C]	average environment temperature
T_{high}	[°C]	temperature of the water in a test system at the beginning of a high-temperature test (typically 55 – 60 °C)
T_{in}	[°C]	temperature of the liquid entering the storage vessel
$T_{initial}$	[°C]	temperature of the water in the test system at the beginning of a test (heat loss or warm-up)
T_{low}	[°C]	temperature of the water in a test system at the beginning of a low-temperature test (preferably near ambient temperature)
$T_{tank \text{ ave}}$	[°C]	average tank fluid temperature
$T_{tank \text{ ave final}}$	[°C]	final average tank fluid temperature after the decay or irradiation, period
$T_{tank \text{ ave ini}}$	[°C]	initial average tank fluid temperature before the decay or irradiation period
$T_{tank \text{ ave purge}}$	[°C]	final average tank fluid temperature after the purge period. This value is usually estimated by averaging the tank inlet temperature and T_{del} .
Δt	[s]	change in time
T_{set}	[°C]	manufacturer's recommended thermostat setting
T_{sky}	[°C]	sky temperature
u	[ms ⁻¹]	surrounding air speed over the solar collector (or evaporator)
U	[W/m ² K]	heat loss coefficient
UA	[W/K]	heat loss coefficient × area product for the tank
$UA_{isolated \text{ loss total}}$		total UA loss of the storage tank from a decay test with the system piping installed
$UA_{installed \text{ loss total}}$		installed total UA loss of the storage tank from a decay test
α	[-]	unglazed collector hemispherical absorber absorptance, short wave

β	[-]	slope or tilt, the angle between the plane of the collector and the horizontal
ε	[-]	unglazed collector hemispherical absorber emittance, long wave
ε_{mod}	[-]	modified effectiveness
η	[-]	solar collector efficiency
ϕ	[-]	latitude, the angular location north or south of the equator
θ	[rad]	incidence angle relative to the collector aperture normal
γ	[-]	orientation angle, the direction which a collector faces, expressed as the azimuth angle of the horizontal projection of the surface normal
λ	[W/mK]	thermal conductivity

5 Application

The procedure in this International Standard uses a mathematical model to assess annual energy task performance; hence the application of the procedure is restricted only by the availability of suitable mathematical models. Weather data and typical modelling data files are specified in Annex G. The operating conditions and product configurations to be used for evaluating the energy performance of a water heater are specific to certification or incentive programs and are not defined in this International Standard.

This International Standard can be applied to solar water heaters with the following:

- a) flat plate, concentrating or evacuated tubular solar collectors,
- b) thermosiphon or forced fluid circulation through the solar collectors,
- c) collector loop heat exchangers,
- d) systems for combined domestic hot water preparation and space heating (combisystems),
- e) integral collector storage,
- f) horizontal or vertical water storage tanks,
- g) storage with one or more electrical heating elements,
- h) storage tanks with internal gas backup heaters,
- i) solar preheat systems in series with instantaneous water heaters,
- j) solar thermal systems combined with heat pumps (e.g., solar collectors acting as the refrigerant evaporator).

Other water heater configurations incorporating the above components may also be modelled.

For limited time-of-supply electric storage water heaters, the temperature stratification in the storage tank is evaluated throughout the day and used to quantify the variation of tank heat loss with time, due to cooling of the bottom of the tank. Mixing during load draw off and conduction between the hot and cold layers in the tank is also included. All storage tanks shall be rated for standing heat loss and maintenance rate. The operational heat loss accounting for non-uniform insulation around the tank and thermal stratification in the tank is determined by the annual load cycle performance model.

6 Test method

6.1 Introduction

This International Standard defines a means of evaluating the purchased energy use of water heaters operating under specified weather and load conditions.

For solar water heaters, this standard can be used for any system type that can be reasonably modelled in a computer simulation model. The performance of individual components is evaluated under ISO 9806, AS 4552, AS/NZS 4692.1, AS 1056.1, EN 12975, EN 12976, and EN 12977. The performance of heat pump water heaters with evaporators exposed directly to solar radiation is evaluated using test results for the evaporator evaluated under ISO 9806 and performance of the compressor is evaluated under ASHRAE Standard 23-93.

The purchased energy use calculated is only representative of the product model described in Annex A.

6.2 Component testing

6.2.1 Storage vessels

There are a wide variety of storage vessels available. They range from simple single-wall tanks to double-wall (mantle) vessels with multiple integral heat exchangers and backup energy input. As the complexity of the vessel increases, so does the complexity of the method necessary for adequately characterizing the vessel.

6.2.1.1 Simple storage tanks

The standing heat loss of simple storage vessels without a heat exchanger and/or backup energy input may be evaluated in accordance with Annex B or in accordance to 6.3.1.4.1 of EN 12977-3.

6.2.1.2 Complex storage vessels

6.2.1.2.1 Storage vessels with electric backup heating

The standing heat loss of complex storage vessels may be evaluated using EN 12977-3.

NOTE Electric backup heaters in solar water heater storage tanks may be located above the bottom of the tank to separate the functions of solar and backup heating. Evaluation of the standing loss and rated delivery of such tanks requires a test with a special electric element fitted in the bottom of the tank to minimize thermal stratification in the tank during the standing heat loss test.

6.2.1.2.2 Storage vessels with gas backup

The following performance factors may be evaluated using the test methods in AS 4552.

- a) thermal efficiency (%),
- b) determined gas consumption (MJ/h),
- c) maintenance rate (MJ/h),
- d) electric power usage during standby (W),
- e) electric power usage during burner operation (W).

6.2.1.2.3 Storage vessels with raised level gas backup heating

Heat loss from storage tanks incorporating raised level gas backup heating from either an internal or external burner shall be determined by direct measurement using a specially configured tank that is maintained at uniform temperature during heat loss testing.

6.2.1.2.4 Instantaneous gas water heaters

The following performance factors may be evaluated using the test methods in AS 4552.

- a) thermal efficiency (%),
- b) output (kW),
- c) pilot gas consumption (MJ/h),
- d) start-up heat capacity (MJ/event),
- e) electric power usage during standby (W),
- f) electric power usage during burner operation (W).

6.2.1.2.5 Solar assisted heat pump storage water heaters

The heat pump compressor thermal capacity and power consumption shall be evaluated for evaporator refrigerant temperatures from $-5\text{ }^{\circ}\text{C}$ to $30\text{ }^{\circ}\text{C}$ (at least four temperatures) and condenser refrigerant temperatures from $30\text{ }^{\circ}\text{C}$ to $70\text{ }^{\circ}\text{C}$ (at least four temperatures) using the test procedure in ASHRAE 23-93. The standing heat loss of the storage vessel in a heat pump water heater shall be evaluated using AS/NZS 4692.1, EN 12977-3, or the procedure described in Annex B.

6.2.2 Flow rate in pumped collector-loops

The flow rate in forced circulation systems shall be determined using one of the following. The length of pipe shall be the longest length allowed by the manufacturer's published installation instructions for the system. In absence of such specifications, the total pipe length should be set according to Annex G, Reference conditions.

6.2.2.1 Constant speed pumps

6.2.2.1.1 Measurement

A system shall be assembled with a specified length of pipe of the manufacturer's specified diameter each way between the tank and the collector array. For systems with site specific flow adjustment, the flow control device specified by the manufacturer for this piping length shall be installed. Flow rate shall be measured under normal operating conditions.

6.2.2.1.2 Calculation

The flow rate may be calculated using analytical functions for the pressure drop of each fitting normally used in the system, a specified length of pipe of the manufacturer's specified diameter each way between the tank and the collector array, and the published head-flow characteristics of the pump.

6.2.2.2 Variable speed pumps

6.2.2.2.1 Measurement

A system shall be assembled with a specified length of pipe of the manufacturer's specified diameter each way between the tank and the collector array. For systems with site specific flow adjustment, the flow control device specified by the manufacturer for this piping length shall be installed. Flow rate shall be measured under normal operating conditions and characterized as a function of a control variable. This control variable could be a temperature difference, solar radiation, or any other parameter specified in the system design.

6.2.2.2.2 Calculation

The flow rate may be calculated using analytical functions for the pressure drop of each fitting normally used in the system, a specified length of pipe of the manufacturer's specified diameter each way between the tank and the collector array, and the characteristics of the pump speed controller. Flow rate shall be calculated under the rating conditions and characterized as a function of a control variable. This control variable could be a temperature difference, solar radiation, or any other parameter specified in the system design. Refer to Annex E for a method to evaluate DC pumps powered by a photovoltaic module.

6.2.3 Solar collectors

6.2.3.1 Solar collector efficiency

The efficiency of solar collectors shall be evaluated using ISO 9806.

6.2.3.2 Collector efficiency correction for shadowing due to impact guard

If an impact guard is added to a collector after the collector efficiency test then the collector efficiency shall be corrected for

- a) normal incidence shadowing due to the hail guard,
- b) incidence angle modifier of hail guard as specified in Annex D.

6.2.3.3 Integral collector storage units and other designs not addressed above

The efficiency of integral storage units (including non-separable thermosiphon) and other designs not addressed above shall be evaluated using EN 12976 or Annex C.

6.2.4 Heat Exchangers

All heat exchangers shall be tested in accordance with one of the methods given in Annex F or the system parameter identification method included in the storage vessel test described in EN 12977-3, chapter 6.3.1.5.

6.2.5 Controllers

All controllers shall be tested in accordance with the method given in EN 12977-5.

6.3 Water heater configuration for modelling

The system configuration data listed in Annex A shall be used in the modelling; additional data may be needed for some systems.

The solar collector tilt angle and azimuth shall be set according to Annex G, Reference conditions.

One of the following backup supply and control options shall be specified in the performance model:

- a) Single or dual electric elements with each element operated on different electric supply options.
- b) Gas in-tank backup heating.
- c) Gas or electric storage water heater in series with solar or heat pump preheater.
- d) Series instantaneous backup with the solar heater operating as a preheater.
- e) In-tank heat exchanger connected to an external water heater.

The timing of electrical backup heating may be set to night rate tariff times, extended off-peak times, continuous backup or set by a local controller. The backup heater controller may vary backup input to the tank in response to solar radiation conditions, stored energy level in the tank, load demand and other conditions.

If the electric supply utility allows user activation of one-shot backup heating in time limited electric tanks then the effect of this may be modelled as part of the annual performance evaluation.

User over-ride of backup heating shall not be included in the modelling.

7 Performance evaluation

7.1 Annual task performance

The mathematical model to be used for the annual task performance evaluation shall be a validated simulation program suitable for the product type being modelled. See Annex G for validation requirements.

The annual load cycle performance of water heaters shall be determined with a computational time step of 0.1 hours or less to determine the annual backup energy needed for the specified load and environmental conditions.

For components whose modelling parameters were derived from computer modelling, the same computer model that was used to derive the modelling parameters from the original component test data shall be used when evaluating annual task performance. Note that modelling parameters can also be defined directly from test data without computer modelling.

7.2 Weather data

The weather data used for the simulation shall include records for the locations specified in 7.14. The performance shall be based on hourly values for the following variables:

Table 1 — Hourly value variables

Variable	Applicability
Ambient temperature	All systems
Global irradiation	Solar water heaters and solar-assisted heat pumps
Beam irradiation	Solar water heaters and solar-assisted heat pumps
Wet bulb temperature	Heat pumps only
Wind speed	Solar-assisted heat pumps and solar water heaters incorporating unglazed collectors
Cloud cover	Solar-assisted heat pumps and solar water heaters incorporating unglazed collectors
Infrared radiation or sky temperature (if available)	Solar-assisted heat pumps and solar water heaters incorporating unglazed collectors

7.3 Thermal energy loads

The peak daily thermal energy loads and seasonal and daily variations of load specified in Annex G shall be used for the annual task performance evaluation. The load is distributed within each day using a daily load pattern and the load is varied each month using a seasonal load pattern. The simulation input deck shall be configured so that the load is specified in terms of energy withdrawn after the tempering valve in the manner shown in the example simulation deck files.

7.4 Thermostat set temperature

7.4.1 Storage water heaters

For the purpose of determining annual performance rating, the model shall simulate heating of water above the lowest thermostat to the temperature specified in Annex G.

7.4.2 Instantaneous supplementary heaters

The set temperature of instantaneous backup heaters in series with solar or heat pump storage preheaters shall be as specified in Annex G.

7.4.3 Minimum delivery temperature

The system shall be capable of satisfying a minimum delivery temperature of 45 °C under peak winter load conditions for the specified no-solar operating conditions.

To quantify the backup heater capacity, the delivery temperature under no-solar conditions shall be checked by monitoring (recording) the delivery temperature calculated during each load draw-off for peak-winter load conditions. The no-solar simulation shall be continued over a period of ten or more days until stable operation is obtained under the no-solar conditions specified in Annex G. A minimum delivery temperature of 45 °C shall be achieved for every delivery.

If a system fails to meet the minimum delivery temperature of 45 °C then it may be rated for a lower load provided it can satisfy the minimum delivery temperature requirement for the lower load. The load used for rating shall be stated in the report.

7.5 Cold water inlet temperature

The cold-water inlet temperature profile specified in Annex G shall be used.

7.6 Pump circulation control

If the stored potable water is pumped through the solar collector or an external heat exchanger then the circulation flow rate may have a significant effect on thermal stratification in the storage tank. The effect of a high flow-rate may be particularly significant in single tank systems where a backup heater heats the top section of the tank. If the pumped loop return level to the tank is below the level of the in-tank backup heater then disturbance of thermal stratification due to forced circulation through the storage tank can be minimized by using a low flow rate.

7.6.1 Low-flow criteria

Under low-flow operation the collector flow into the tank may be considered to promote thermal stratification in the tank. To satisfy the low-flow criteria, the pump control or pressure drop in the collector-loop shall be adjusted to suit the collector array size and pipe lengths and fittings of each installation. Low-flow shall not be included in the system model unless the system design includes specific flow control(s).

The criteria for modelling the potential for thermal stratification in a forced circulation solar water heater are

- a) flow rate less than 0.75 l/(min m² aperture),
- b) collector flow return level to the tank is below the level of the backup heater.

7.6.2 Controlled-flow pumped-circulation

Forced circulation solar water heaters that use collector loop flow rate control to set a flow rate less than 0,75 l/(min m² aperture) for each installation shall use the controlled-flow thermal stratification requirements in 7.7.1 for load cycle performance rating.

7.6.3 Uncontrolled-flow forced circulation

Forced circulation solar water heaters that do not have site specific adjustment or control of collector loop flow rate shall use the uncontrolled-flow thermal stratification requirements in Clause 7.7.3 for load cycle performance rating.

7.6.4 External collector loop heat exchanger systems

Solar water heaters using a pumped collector loop working through an external heat exchanger (sidearm heat exchanger) with a thermosiphon loop on the tank side of the heat exchanger shall be modelled as for thermosiphon systems or with natural convection loop routines.

7.6.5 Pump controllers

The simulation deck shall model the operation of pump controllers that sense flow rate, collector temperature rise or other real-time variables in order to set the flow rate in the collector-loop or sidearm-loop.

7.7 Simulation deck setup for modelling thermal stratification in storage tanks

Thermal stratification in a solar heated storage tank depends on the flow rate between the tank and the solar collector or collector loop heat exchanger. Thermal stratification in the storage tank shall be modelled as mixed flow or stratified flow using the following system classifications:

7.7.1.1 Controlled flow-rate forced circulation

Thermal stratification in the storage tank of products that satisfy the low-flow collector-loop criteria and have collector-loop flow rate adjustment for each installation shall be modelled using the following options in the simulation model:

- a) site specific flow rate specified by the manufacturer or set by the controller,
- b) variable inlet position mixing option for the tank,
- c) 20 or more tank nodes in a fixed node tank model or an automatic node model or the Kleinbach^[14] method of determining the number of nodes.

7.7.2 Thermosiphon circulation

Thermal stratification in the storage tank of thermosiphon collector loop or thermosiphon sidearm heat exchanger products shall be modelled using the following options in the simulation model:

- a) variable inlet position mixing option for the tank,
- b) 20 or more tank nodes in a fixed node tank model or an automatic node thermosiphon system model or the Kleinbach^[14] method of determining the number of nodes.

7.7.3 Uncontrolled flow-rate forced circulation

Mixing in a storage tank due to forced circulation from the solar collector array (either direct connection or through a double pumped heat exchanger) shall be modelled using the following options in the simulation model:

- a) measured collector loop flow rate, flow rate calculated in accordance with 6.2.2.1.2 or 1.0 L/min per m² of collector aperture area, whichever is larger,
- b) fixed inlet position mixing option for the tank,
- c) maximum of 10 tank nodes in a fixed node tank model or an automatic node simulation model or the Kleinbach^[14] method of determining the number of nodes.

7.7.4 Heat exchanger tanks

Thermal stratification in storage tanks with internal, wrap-around or mantle heat exchangers shall be modelled using the following options in the simulation model:

- a) variable inlet position mixing option for the tank,
- b) 20 or more tank nodes in a fixed node tank model or an automatic node tank model or the Kleinbach^[14] method of determining the number of nodes.

7.8 Piping configuration for solar water heaters

The following piping configurations shall be used in the performance modelling.

7.8.1 Collector loop piping

The length of piping between the storage tank and solar collectors shall be determined by 7.8.1.1 or 7.8.1.2.

7.8.1.1 *Forced circulation system or remote thermosiphon system*

Pipe diameter and length shall be set to the diameter and longest length allowed by the manufacturer's published installation instructions for the system. In the absence of such specifications, the total pipe length should be set according to Annex G, Reference conditions.

7.8.1.2 *Close-coupled thermosiphon circulation system*

The manufacturer's pipe length and diameter specifications shall be used.

7.8.2 Collector loop piping insulation

Heat loss from the piping shall be computed for

- a) manufacturers specified insulation jacket diameter,
- b) thermal conductivity of specified insulation material,
- c) external convective heat transfer coefficient (h_o) of 10 W/(m² K) or as calculated for the specific system's insulation outside diameter,
- d) internal convective heat transfer coefficient (h_i) of 1 000 W/(m² K), or as calculated for the specific system's pipe material and inside diameter.

The pipe heat loss coefficient (U_{pipe}) for an insulated pipe, based on the pipe diameter, is given by Equation 1:

$$U_{\text{pipe}} = \frac{1}{\frac{1}{h_i} + \frac{d_i}{2\lambda} \ln(d_o / d_i) + \frac{1}{h_o} \frac{d_i}{d_o}} \quad (\text{W/m}^2\text{K}) \quad (1)$$

where

d_i is the pipe diameter

d_o is the outer diameter of the insulation and

λ is the thermal conductivity of the insulation material

For a metal pipe without insulation the pipe heat loss coefficient is given by Equation 2:

$$U_{\text{pipe}} = \frac{1}{\frac{1}{h_i} + \frac{1}{h_o}} = 10 \quad (\text{W/m}^2\text{K}) \quad (2)$$

7.8.3 Piping between primary storage tank and a series backup heater

7.8.3.1 Forced-circulation system

If a series supplementary heater is not integral with the primary storage tank the piping between a forced circulation solar preheat tank and a separate series connected backup heater shall be modelled as

- a) manufacturer's maximum length specification or 5 m, whichever is larger,
- b) manufacturer's maximum pipe diameter specification,
- c) manufacturer's specified insulation thickness and material.

7.8.3.2 Thermosiphon system

If the series backup heater is not integral with the thermosiphon tank then the length of piping between the thermosiphon solar preheater and a separate series backup heater shall be modelled as

- a) pipe length: maximum pipe length specified by the manufacturer in published installation instructions. In the absence of this information, the pipe length is to be set according to Annex G, Reference conditions,
- b) manufacturer's maximum pipe diameter specification,
- c) manufacturer's specified insulation thickness and material.

7.9 Controllers

The simulation deck shall model the logic map of controllers used for collector flow rate control and backup heating.

7.10 Energy consumed for freeze protection

7.10.1 Active pumped freeze protection

Energy removed from the tank and energy used by the pump for forced circulation freeze protection of solar collectors in direct coupled systems shall be included in the task performance analysis. The night time

effective air temperature shall be taken as the average of the ground level air temperature (T_a) and the sky temperature T_{sky} given in Equation 3 (reference 6)

$$T_{sky} = \left(0.711 + 0.0056T_{dp} + 0.73 * 10^{-4} T_{dp}^2 \right)^{0.25} T_a \quad (3)$$

where T_{dp} = dew point temperature (°C)

7.10.2 Electric heater freeze protection

Energy used by electric heaters in the collector loop circuit for freeze protection of the solar collectors shall be included in the task performance analysis.

7.10.3 Freeze dump valve

Energy removed when a freeze dump valve opens to flush water through the collector(s) in a direct system shall be included in the task analysis.

7.11 Over-temperature control

The annual task performance program shall model stagnation control devices with temperature settings used to satisfy the no-load water dumping requirement of AS/NZS 2712.

7.11.1 Hot water discharge due to over temperature

Temperature-pressure relief valve settings shall be modelled as 88 °C and 1 034 kPa.

7.11.2 Low pressure system energy dumping

Energy loss due to boil-off in low pressure systems shall be modelled as energy dumping at 100 °C.

7.12 Modelling gas storage water heaters

The efficiency and heat loss from a conventional gas storage water heater shall be modelled using the following parameters determined such as under AS 4552:

- a) thermal efficiency E (%),
- b) determined gas consumption R (MJ/h),
- c) maintenance gas consumption M (MJ/h),
- d) electrical power consumed during standby e_{sb} (W),
- e) electrical power consumed when the burner is operating e_n , (W).

The factors required for annual task performance simulation shall be computed as follows:

Backup power input to tank

$$P = R \frac{E}{100} \quad (\text{MJ/h}) \quad (4)$$

Tank heat loss coefficient * tank surface area (UA)

$$= M \frac{E}{100} \frac{1}{\Delta T} \frac{1}{0.0036} \text{ W/K} \quad (5)$$

where ΔT is the temperature difference during maintenance rate measurement (= 45 K in AS 4552 maintenance rate test)

The following energy output factors shall be computed:

Annual gas energy consumption

$$= E_g \frac{100}{E} + M_{\text{adj}} \times \left(8760 - E_g \frac{100}{E} \frac{1}{R} \right) \text{ (MJ)} \quad (6)$$

where

E_g is the integrated energy added to tank from gas combustion (MJ/year)

M_{adj} is the maintenance rate adjusted for operating temperature of stored water

The term $\left(8760 - E_g \frac{100}{E} \frac{1}{R} \right)$ is the standby time (h)

Annual electrical energy consumed:

Integral of electrical power used during burner operation and during standby periods.

$$= e_n * E_g \frac{100}{E} \frac{1}{R} + e_{\text{sb}} * \left(8760 - E_g \frac{100}{E} \frac{1}{R} \right) \text{ MJ} \quad (7)$$

7.13 Modelling instantaneous gas water heaters

The efficiency and heat loss from instantaneous gas water heaters shall be modelled using the following parameters determined under AS 4552

- thermal efficiency E (%),
- determined gas consumption R (MJ/h),
- start-up heat capacity S (MJ/event),
- pilot rate P (MJ/h),
- electrical power consumed during standby e_{sm} (W),
- electrical power consumed when the burner is operating e_n , (W).

The factors required for annual task performance simulation in simulation deck shall be computed as follows:

Heat input rate to water during burner operation

$$= R \frac{E}{100} \text{ (MJ/h)} \quad (8)$$

The performance of instantaneous gas water heaters is influenced by start-up capacity. The number of start-up events (N) to be used each day for load cycle performance evaluation shall be according to Table 2:

Table 2 — START-UP HEAT CAPACITY — NUMBER OF EVENTS

System type	N
Small load system	13
Medium load system	19
Large load system	26

An instantaneous gas backup heater in series with a solar preheater tank that is fitted with a backup heater bypass valve controlled by the preheat tank temperature will not have start-up loss at a particular load event if the preheat tank temperature is greater than the instantaneous backup heater set temperature.

The number of start-up events to be included at each load event shall be N divided by the number of load events each day as specified by Annex G, Reference conditions.

The following annual energy consumption factors shall be computed:

Gas energy consumption

$$= Eg \frac{100}{E} + N_{\text{adj}} \times S + P \times \left(8760 - Eg \frac{100}{E} \frac{1}{R} \right) \text{ MJ} \quad (9)$$

where

Eg is the integrated energy added to tank from gas combustion (MJ/year)

N_{adj} is the number of start-up events, adjusted for bypass valve operation

The term $\left(8760 - Eg \frac{100}{E} \frac{1}{R} \right)$ is the standby time (h)

Electrical energy consumption

= electrical energy used during burner operation and during standby

$$= e_n * Eg \frac{100}{E} \frac{1}{R} + e_{\text{sb}} * \left(8760 - Eg \frac{100}{E} \frac{1}{R} \right) \text{ MJ} \quad (10)$$

7.14 Presentation of results

The product characteristics and component test results shall be reported using the appropriate tables in Annex A. Test reports for the solar collector efficiency, tank standing heat loss and pump flow rate shall be available for inspection. The annual system performance shall be reported in the manner shown in the following forms. Also see the section “Long-term performance prediction” in EN 12977-2.

7.14.1 Purchased energy savings relative to reference water heaters

The water heater purchased energy saving relative to a reference conventional water heater is:

$$f_R = \frac{(Bc - Bs)}{Bc} \quad (11)$$

where

B_c is the annual purchased energy use of a reference conventional water heater specified in Annex G, Reference conditions.

B_s is the annual purchased energy use (sum of all energy inputs) of the heater being rated.

The annual saved purchased energy ($B_c - B_s$) and the fractional energy savings (f_R) shall be reported as shown in Table 3.

Table 3 — PERFORMANCE RESULT SUMMARY

Manufacturer:

Model No:

Collector tilt angle/azimuth	Location	Annual water heating load MJ/year	Annual energy used by backup heater		Annual electrical energy used by pump and controls MJ/year
			Electricity	Gas	
	Select from the reference locations in Table G.1				

Table 4 — NO-SOLAR DELIVERY TEMPERATURE

Manufacturer:

Model No:

Location	Peak winter load applied MJ/day	Backup heating mode Continuous (C) or Night Rate (NR) or Time Controlled (TC)	Minimum delivery temperature under no-solar conditions °C
Select from the reference locations in Table G.1			

Table 5 — PURCHASED ENERGY SAVINGS

Manufacturer:

Model No:

Location	Reference system energy use B_c MJ/year	Backup energy use B_s MJ/year	Energy savings $B_c - B_s$ MJ/year	Energy savings f_R %
Select from the reference locations in Table G.1				

7.14.2 Documentation of simulation model inputs

The report of the simulation results shall include an electronic copy of the simulation deck file, output file and any component data files (such as incidence angle modifier data) used in the simulation. Traceable documentation for solar collector efficiency, storage tank standing heat loss, collector loop flow rate, flow controller settings and backup heater characteristics and the appropriate data sheets in Annex A shall be listed in the performance report.

7.15 Extension of simulation model for new products

Application of the annual task simulation rating to new products will be added to this International Standard in later revisions. Interim test procedures for these products may be accepted by certification bodies.

Annex A (normative)

Water heater parameters

The system parameters required as inputs to the simulation deck are outlined below for thermosiphon, integral collector storage, pumped solar water heaters and solar assisted heat pump water heaters. Some systems may require other parameters to be specified.

A.1 Thermosiphon water heaters

Company	
Phone No	
E-mail address	
Company officer reporting system characteristics	
Date	

PARAMETER	VALUE	UNITS
Water heater model number		

TANK		
Tank model		
Tank inner diameter		mm
Tank volume (physical not delivery)		L
Tank configuration		Vertical or horizontal
Tank wall thickness		mm
Tank wall material		
Ratio of insulation thickness at top to bottom of horizontal tank		
Ratio of insulation thickness at the top of the tank to the side of the tank for a vertical tank		
Volume of water above collector flow input to tank		

Tank heat loss (electric)		
Tank standing heat loss		kWhr/day for $\Delta T = 55K$
Test laboratory		test report to be available for auditing
Date of test		
Test report number		

Tank heat loss (gas storage)		
Tank maintenance rate		MJ/hr
Temperature difference during maintenance rate testing		K
Test laboratory		test report to be available for auditing
Date of test		
Test report number		

BACKUP HEATING		
Electric Backup		
Volume of water above the electric element		L
Volume of water above the thermostat		L
Element heating capacity		KW

Gas backup (in primary tank)		
Gas burner capacity (gas input)		MJ/h
Burner efficiency		%
Pilot gas consumption		MJ/h
Position of gas burner in the tank		Provide sketch if not in bottom of tank

Instantaneous gas backup heating		
Determined gas capacity (maximum gas input)		MJ/hr
Efficiency		%
Electrical power consumption during standby		W
Electrical power consumption during burner operation		W
Start up heat capacity		MJ
Test laboratory		
Date of test		Test report to be available for auditing
Test report number		

Backup energy control		
Backup supply time		Night rate or continuous
Thermostat set temperature (minimum of 50 °C)		°C
Thermostat dead band		K

Pipe between solar preheat tank and gas backup heater		
Inner diameter (ID)		mm
Pipe length (minimum 5 m)		m
Pipe insulation material		
Pipe insulation thickness		mm

Solar collector efficiency		
Model No		
Type of collector		Flat plate or evacuated tube or CPC or other
Collector efficiency parameters (ISO 9806), specify "a" or "b" coefficients		
$\text{Efficiency} = a_1 - a_2 \frac{(\bar{T} - T_a)}{G} - a_3 \frac{(\bar{T} - T_a)^2}{G}$		
a ₁ =		-
a ₂ =		W/(m ² K)
a ₃ =		W/(m ² K ²)
Collector efficiency parameters (AS/NZS 2535)		
$\text{Efficiency} = b_1 - b_2 \frac{(\bar{T} - T_a)}{G} - b_3 \frac{\left((\bar{T} + 273)^4 - (T_a + 273)^4 \right)^2}{G}$		
b ₁ =		-
b ₂ =		W/(m ² K)
b ₃ =		W/(m ² K ⁴)
Collector area used by test laboratory to define efficiency		m ²
Test laboratory		test report to be available for auditing
Date of test		
Test report number		
Number of collectors used in water heater		
Number of risers in each collector		
Riser inner diameter		mm
Riser length		m
Header length (one header only)		m
Header inner diameter		mm

PLUMBING BETWEEN TANK AND COLLECTOR		
Direct connection to tank or via mantle heat exchanger		Direct or heat exchanger
If collector loop heat exchanger then provide details of heat exchanger location and construction		Provide diagram
Vertical separation between the centreline of the collector upper header and the collector cold line out of the tank		m
Vertical separation between the hot collector return line into the tank and the cold outlet line to the collector		m
Inlet pipe inner diameter		mm
Inlet pipe length		m
Inlet pipe insulation thickness		mm
Inlet pipe insulation material		
Outlet pipe inner diameter		mm
Outlet pipe length		m
Outlet pipe insulation thickness		mm
Outlet pipe insulation material		

A.2 Forced circulation water heaters

Company	
Address	
Phone No	
E-mail address	
Company officer reporting system characteristics	
Date	

PARAMETER	VALUE	UNITS
Water heater model number		

TANK		
Tank model		
Tank inner diameter		mm
Tank volume (physical not delivery)		L
Tank wall thickness		mm
Tank wall material		
Glass lining thickness (if used)		mm

Tank heat loss (electric)		
Tank standing heat loss		kWhr/day for $\Delta T = 55K$
Test laboratory		
Test report number and date		

Tank heat loss (gas storage)		
Tank maintenance rate		MJ/hr
Temperature difference during maintenance rate testing		K
Test laboratory		

BACKUP HEATING

Electric Backup		
Volume of water above the electric element		L
Volume of water above the thermostat		L
Element heating capacity		KW

Gas backup (in primary tank)		
Determined gas capacity (gas input)		MJ/h
Thermal efficiency		%
Test laboratory		
Date of test		test report to be available for auditing
Pilot gas use		MJ/h
Position of gas burner in the tank		Provide sketch if not in bottom of tank

Series gas tank		
Tank maintenance gas rate		MJ/hr
Temperature difference during maintenance rate testing		K
Test laboratory		
Date of test		test report to be available for auditing
Series tank volume (physical volume)		L

Instantaneous gas backup heater		
Determined gas capacity (maximum gas input)		MJ/hr
Efficiency		%
Electric power consumption during standby		W
Electric power consumption during burner operation		W
Start up heat capacity		MJ
Thermostat set temperature		°C
Test laboratory		
Date of test		Test report to be available for auditing

Backup energy control		
Supplementary supply time		Night rate or continuous
Thermostat set temperature (minimum of 50 °C)		°C
Thermostat dead band		K

Pipe between solar preheat tank and gas backup heater		
Inner diameter (ID)		mm
Pipe length (minimum 5 m)		m
Pipe insulation material		
Pipe insulation thickness		mm

SOLAR COLLECTOR		
Model No		
Type of collector		Flat plate or evacuated tube or CPC or other
Collector efficiency parameters (ISO 9806) specify "a" or "b" coefficients		
$\text{Efficiency} = a_1 - a_2 \frac{(\bar{T} - T_a)}{G} - a_3 \frac{(\bar{T} - T_a)^2}{G}$		
$a_1 =$		-
$a_2 =$		W/(m ² K)
$a_3 =$		W/(m ² K ²)
Collector efficiency parameters (AS/NZS 2535)		
$\text{Efficiency} = b_1 - b_2 \frac{(\bar{T} - T_a)}{G} - b_3 \frac{\left((\bar{T} + 273)^4 - (T_a + 273)^4 \right)^2}{G}$		
$b_1 =$		-
$b_2 =$		W/(m ² K)
$b_3 =$		W/(m ² K ⁴)
Collector area used by test laboratory to define efficiency		m ²
Test laboratory		test report to be available for auditing
Date of test		
Test report number		
Number of collectors used in water heater		
Number of risers in each collector		
Riser inner diameter		mm
Riser length		m
Header length (one header only)		m
Header inner diameter		mm

PUMP AND COLLECTOR		
Pump supplier and model number		
Pump controller differential temperature settings (ON/OFF)		K
Volume of water above cold sensor in tank		L
Maximum temperature in the tank at location of cold sensor		°C

PUMP FLOW RATE

UNCONTROLLED FLOW RATE SYSTEMS

For uncontrolled flow systems the collector loop flow rate and pump power shall be measured in a typical installed system with the specified length of interconnecting piping in each of the flow and return lines (minimum 10 m each way).

Flow rate		L/hr
Pump power		W
Test laboratory		Test report to be available for auditing
Date of test report		

CONTROLLED FLOW RATE SYSTEMS

For controlled flow rate systems (flow rate set for each installation or varied by controller) the flow control logic shall be detailed.

COLLECTOR LOOP HEAT EXCHANGER (if used)

In-tank coil heat exchanger		
Inner diameter of coil tubing		mm
Length of coil inside the tank		m
Wall thickness of tubing		mm
Wall material of tubing		
Thermal conductivity of tubing		W/m-K
Volume of water above top of heat exchanger		L
Volume of water above bottom of heat exchanger		L

External collector loop heat exchanger with pumped tank side circulation		
Flow rate on tank side of heat exchanger		L/hr
UA value of heat exchanger at specified collector loop and tank loop flow rates		W/m ² K
Test laboratory		Test report to be available for auditing
Date of test		

Mantle collector loop heat exchanger		
Volume of water in tank above top of mantle		L
Volume of water in tank above bottom of mantle		L
Mantle gap		mm
Circumferential width of mantle		

PLUMBING BETWEEN SOLAR TANK AND SOLAR COLLECTOR

Direct connection to tank or via heat exchanger		Direct or heat exchanger If heat exchanger is used provide dimensions and heat transfer characteristics
Volume of water above flow input to tank		L
Collector supply (inlet) pipe inner diameter		mm
Inlet pipe length (default of 10 m for domestic system)		m
Inlet pipe insulation material		
Inlet pipe insulation thickness		mm
Collector outlet pipe inner diameter		mm
Outlet pipe length (default of 10 m for domestic system)		m
Outlet pipe insulation material		
Outlet pipe insulation thickness		mm

LOAD FLOW HEAT EXCHANGER (if used)

Inner diameter of heat exchanger tubing		mm
Length of each heat exchanger flow path in the tank		m
Number of parallel heat exchanger paths		
Wall thickness of heat exchanger tubing		mm
Wall material of heat exchanger tubing		
Volume of water above top of heat exchanger		L
Volume of water above bottom of heat exchanger		L

A.3 Solar assisted heat pump water heater

Company	
Address	
Phone No	
E-mail address	
Company officer reporting system characteristics	
Date	

PARAMETER	VALUE	UNITS
Water heater model number		

TANK		
Tank model		
Tank inner diameter		mm
Tank volume (physical not delivery)		L
Tank wall thickness		mm
Tank wall material		
Glass lining thickness (if used)		mm

Tank heat loss		
Tank standing heat loss		KW/hr/day for $\Delta T = 55$ K
Test laboratory		
Test report number and date		

BACKUP HEATING

Electric Backup		
Volume of water above the electric element.		L
Volume of water above the thermostat.		L
Element heating capacity		kW
Thermostat set temperature		°C
Thermostat dead band		K
Electric backup heat times		Night rate or continuous

SOLAR ASSISTED EVAPORATOR

SOLAR COLLECTOR		
Model No		
Type of collector		Flat plate, evacuated tube, concentrating or other
Collector efficiency parameters (ISO 9806)		
$\text{Efficiency} = c_1 - (c_2 + c_3V) \frac{(\bar{T} - T_a)}{G''}$		
$c_1 =$		
$c_2 =$		W/(m ² K)
$c_3 =$		W/(m ² Km/s)
Collector area used by test laboratory to define efficiency		m ²
Test laboratory		ISO 9806-3 test report to be available for auditing
Date of test		
Test report number		
Number of collectors		

CONDENSER — Wrap-around

Inner diameter of coil tubing (m)		m
Length of coil (m)		m
Bonding between coil and tank		

Heat pump compressor

The heat pump electric power consumption and thermal capacity is required for at least four evaporator and four condenser temperatures.

Refrigerant condensing temperature	Refrigerant evaporating temperature							
	-5 °C or lower		Te2		Te3		30 °C or higher	
	Power	Capacity	Power	Capacity	Power	Capacity	Power	Capacity
30 °C or lower								
Tc2								
Tc3								
70 °C or higher								
NOTE 1 Te2, Te3, evaporating test temperatures at approximately 10 °C and 20 °C.								
NOTE 2 Tc2, Tc3, condensing test temperatures at approximately 40 °C and 55 °C.								

A.4 Integral Collector Storage

Company	
Address	
Phone No	
E-mail address	
Company officer reporting system characteristics	
Date	

PARAMETER	VALUE	UNITS
Water heater model number		

TANK		
Tank model		
Tank inner diameter		mm
Tank volume (physical not delivery)		L
Tank configuration		Vertical or horizontal
Tank wall thickness		mm
Tank wall material		
Ratio of insulation thickness at top to bottom of horizontal tank		
Ratio of insulation thickness at the top of the tank to the side of the tank for a vertical tank		

Tank heat loss (electric)		
Tank standing heat loss		kWhr/day for $\Delta T = 55 \text{ K}$
Test laboratory		test report to be available for auditing
Date of test		
Test report number		

Tank heat loss (gas storage)		
Tank maintenance rate		MJ/hr
Temperature difference during maintenance rate testing		K
Test laboratory		test report to be available for auditing
Date of test		
Test report number		

BACKUP HEATING		
Electric Backup		
Volume of water above the electric element		L
Volume of water above the thermostat		L
Element heating capacity		KW

Gas backup (in primary tank)		
Gas burner capacity (gas input)		MJ/h
Burner efficiency		%
Pilot gas consumption		MJ/h
Position of gas burner in the tank		Provide sketch if not in bottom of tank

Instantaneous gas backup heating		
Determined gas capacity (maximum gas input)		MJ/hr
Efficiency		%
Electrical power consumption during standby		W
Electrical power consumption during burner operation		W
Start up heat capacity		MJ
Test laboratory		
Date of test		Test report to be available for auditing
Test report number		

Pipe between integral collector storage unit and backup heater		
Inner diameter (ID)		Mm
Pipe length (minimum 5 m)		M
Pipe insulation material		
Pipe insulation thickness		Mm

Annex B (normative)

Storage vessel performance

B.1 Tank charge

B.1.1 Fill method

- a) The fill may occur at any rate up to the manufacturer's recommended maximum flow rate.
- b) Heat and fully mix the tank to T_{initial} , where $T_{\text{initial}} = T_{\text{low}}$ or T_{high} .
- c) Charge the tank until $|T_{\text{in}} - T_{\text{del}}| \leq 0.2 \text{ K}$ or $\frac{\partial |T_{\text{in}} - T_{\text{del}}|}{\partial t} \leq 0.05 \text{ K}$ for a 10-minute period. Tank shall be maintained at this temperature for a minimum of the tank dwell (fill) time.

B.2 Tank purge

B.2.1 Test method

- a) Purge the energy in the system by circulating water through the system.
- b) The purge shall occur at 0.125 – 0.189 l/s (2-3 gpm) until $|T_{\text{in}} - T_{\text{del}}| \leq 0.2^\circ\text{K}$ (0.4°R) or $\frac{\partial |T_{\text{in}} - T_{\text{del}}|}{\partial t} \leq 0.05^\circ\text{C}$ (0.09°F) for a 10-minute period.
- c) Conduct real time measurement of M_{drawn} , T_{in} , T_{del} and T_{env} .

B.2.2 Analysis method

The analysis of all tank energy purges shall utilize the following:

$$Q_{\text{del}} = \int \text{Rho}(t) * C_p(t) * V_{\text{rate}} * [T_{\text{del}}(t) - T_{\text{mains}}(t)] dt$$

B.3 Capacitance and draw stratification test

B.3.1 Test method

This test is to be performed indoors, preferably in an environment with a nearly constant temperature. The unit is to be installed in a manner consistent with the intended system design. Piping connections are to be made, but isolated via valving. This test is typically performed before the loss tests (see B.4) so that a baseline tank capacitance can be determined.

- a) Charge tank to T_{high} (see B.1).
- b) Measure environment temperature during the entire test period.

- c) Purge the energy in the tank (see B.2) with $T_{in} = T_{env}$
- d) $Q_{initial} = Q_{del}$

The resulting capacitance energy calculation from this test is used as the basis for the initial tank energy value in test B.4 when the construction characteristics of the tank make the analytical determination of this value difficult.

B.3.2 Analysis method

Determine the tank thermal capacitance from either $Q_{initial}$ or a theoretical calculation:

- a) Experimental Method (preferred)

$$M_{\text{tank}} * C_P (T_{\text{high}}) = \frac{Q_{\text{initial}}}{T_{\text{tank ave ini}} - T_{\text{tank ave final}}}$$

- b) Theoretical Method

$$M_{\text{tank}} * C_P = \sum M_i * C_{pi} (T_{\text{high}}) |_{\text{all components}}$$

The mass and specific heat of all components (tanks shell, insulation, fluid, piping, etc.) shall be known.

B.4 Heat loss test

B.4.1 Test method

This is the standard decay method of determining heat loss rate. The test is to be performed indoors, preferably in an environment with a nearly constant temperature. If the environmental temperature variation is greater than 10 % (approximately 3,5 K for these conditions using a 22 °C environment) of the estimated difference between the tank and environment temperatures, then the use of internal probes shall be used for determining a run-time UA value. If significant stratification is anticipated, the use of internal tank temperature probe(s) is required.

- a) Charge the tank (see B.1) until $T_{\text{initial}} = T_{\text{high}}$.
- b) Wait until:

$$\frac{T_{\text{tank ave ini}} - T_{\text{amb ave}}}{3} \leq (T_{\text{tank ave final}} - T_{\text{amb ave}}) \leq \frac{2 * (T_{\text{tank ave ini}} - T_{\text{amb ave}})}{3}$$

This will be estimated before the test is run using the known tank volume and estimated environmental temperatures. Measure the environment temperature during the entire test period.

- c) Purge the energy remaining in the tank (see B.2) with $T_{in} = T_{env}$

B.4.2 Analysis method

Two methods are available. The first is used when internal tank temperature sensors are available.

- a) A real time numerical loss calculation is to be used if the variation in the environment temperature exceeds 10 % of the initial average tank to environment temperature difference during the test or if the tank is not fully mixed due to varying or large insulation levels. This requires the use of internal tank temperature measurements and is the preferred calculation method when this instrumentation can be installed.

$$1) Q_{\text{loss}} = Q_{\text{initial}} - Q_{\text{del}}$$

$$2) \text{ Numerically solve for UA, } Q_{\text{loss}} = \sum UA * (T_{\text{tank ave}} - T_{\text{amb}}) * \Delta t$$

b) If the variation in the environment temperature is below the 10 % level, the following calculations, which assume an ideal exponential temperature decay, can be used.

$$1) T_{\text{tank ave final}} = T_{\text{tank ave purge}} + \frac{Q_{\text{del}}}{M_{\text{tank}} * C_p}$$

$$2) UA = \frac{M_{\text{tank}} * C_p}{\text{Time decay}} * \ln \left[\frac{(T_{\text{tank ave ini}} - T_{\text{amb ave}})}{(T_{\text{tank ave final}} - T_{\text{amb ave}})} \right]$$

Data from this test can be used to determine the $UA_{\text{installed loss total}}$. Since the value of $UA_{\text{isolated loss total}}$ is used in the TRNSYS tank model, $UA_{\text{installed loss total}}$ is input as the other UA in the TRNSYS tank models. Care should be exercised when specifying tank loss coefficients in all computer simulation models. For systems such as ICS where this value is implicit in the overall re-normalization of the model, this test is not required. A calculated value is used instead of this test due to the variability of this value as a function of the temperature difference between the tank and environment temperatures. Note the availability of the experimentally determined Q_{initial} value in test B.3.

B.5 Night-time decay tank loss test

Perform this test on all systems that have a tank exposed to the sky without opaque insulation between the tank and the sky. Perform the heat loss test (see B.4) on installed system outdoors and uncovered. The test shall be started within 1 hour of dusk and completed within 1 hour of dawn. Constraints regarding constant temperature and length of decay period are not considered for this version of the test. However, one test shall be conducted when the average outdoor sky temperature is at least 10 °K below the average environment temperature. The other test shall be conducted when the average outdoor sky temperature is within 2 °K of the average ambient temperature.

B.6 Required experimental data

The minimum real time data to be collected for the comprehensive tests shall consist of the following. For ease of modelling, all data channels shall be reported on a regular interval, even if not used. A log indicating such things as draw, purge, and irradiation start and stop times shall be included. Other data including site elevation, longitude, latitude, and test sample orientation shall also be supplied.

- 1) Data collection time (both local and solar) and date (YYYYdddhh.hhhhh = year, Julian day, decimal hours)
- 2) Inlet temperature (T_{in}) [°C]
- 3) Outlet temperature (T_{del}) [°C]
- 4) Environment temperature (T_{env}) [°C]
- 5) Liquid Flows (M_{drawn}) [kg/hr]

Annex C (normative)

Integral collector storage unit test method

An implicit consideration in these protocols is that the units are sized on the order of 60-80 l/m² (1.5-2 gal/ft²) of storage per collector area, which is typical of residential solar DHW systems. If a particular unit's design falls outside of this range, the test exposure times and temperature rises (see C.1 and C.2) shall be adjusted with respect to this ratio.

C.1 Qualification tests

Conduct the initial (measurements, pressure, etc.) and qualification (stagnation, shock, etc.) tests as specified by ISO 9806.

C.2 Heat loss tests

Conduct a capacitance test (see B.3).

Conduct a heat loss test (see B.4). This test is not required if the integral storage vessel is surrounded by opaque insulation.

Conduct a night-time decay loss test (see B.5) on units where the integral storage vessel is exposed to the sky, either directly or through a glazing.

C.3 Warm-up tests

If the unit contains a storage vessel with an integral heater, an additional set of tests shall be performed. The tests shall be identical to the set in C.1, except that for the first hour of the warm up test, the heating element shall be activated to allow for stratified operation due to the integral heater:

Test C.2 does not need to be repeated because the same data is used for the fitting process. These tests are to be performed on the actual solar collection unit installed in a conventional manner (with added instrumentation and bypass loop(s) for preconditioning the fluid). The tests can be performed outdoors or under a solar simulator. If the unit is a one-tank system with an integral heating element, then the unit will be tested with and without the element in operation. In the test with the element, set $T_{\text{set}} = 50\text{ }^{\circ}\text{C}$ and energize the element for the first hour of each test.

For units containing a forced circulation loop within the unit, an additional constraint is that the pump shall be activated during purges to extract any uncaptured energy within the hydronic system. This shall occur normally in most cases. For units with a PV pump driven pump, the PV panel shall not be covered during the purge period, so that all of the collected energy can be purged.

Because of the variability of these tests, it may be necessary to extract summary information from a previous test in order to set the operating conditions of a succeeding test. This is necessary so that the minimum temperature and/or radiation requirements are met. If the criteria are not met, it will be necessary to perform additional test(s) in order to satisfy the diversity of data. In general, the Clear, Low Temperature tests (see C.4) are designed to give the "high" performance when the system is run at "cool" temperatures (T_{low}), and the Cloudy, High Temperature tests (see C.5) are designed to give the "low" performance when the system is run at "high" temperatures. In the low temperature tests, the initial temperature is typically near the ambient temperature, while the high temperature test uses an elevated starting temperature (T_{high}). In addition to

meeting the specified solar radiation requirements, each individual test also shall have a minimum of 5 K tank temperature rise to minimize the effect of errors in the experimental data.

In tests utilizing an end of period purge, a cover shall be placed on the thermal collector at the beginning of the purge process. The cover shall consist of 0.04 m thick insulation board, preferably with foil-covered surfaces. The cover shall extend at least 0.1 m beyond the gross horizontal collector aperture and cover any vertically exposed optical components. The exposed side of the cover shall be backed with any appropriate material required for structural rigidity and exposure to the weather (e.g. plywood or plastic).

Before starting the warm up tests, pre-heat the entire unit to a uniform temperature. This is accomplished by fully mixing all heat transfer fluid within the unit. In units utilizing a heat exchanger between the collector and storage components, it may be necessary to take additional steps to ensure that the collector is pre-heated to the tank temperature. For units with integral forced circulation, the pump(s) shall be activated manually in order to fully mix the heat transfer fluid(s).

The unit shall be positioned and fixed facing the equator. The recommended tilt for the unit is such that the collection portion of the system be within 4° of normal to the sun at solar noon on the day of the test, unless this contradicts the manufacturer's recommended tilt limits. In these cases, use the manufacturer's recommended tilt that is nearest the normal tilt value at solar noon. For units with integral forced circulation, the operation of any controllers and pumps shall be automatic once the manual mixing has been completed.

These procedures assume that T_{mains} is relatively constant during the test period(s) and close to ambient temperature. With the exception of units containing tubular optics, warm-up tests can be performed 1 to 2 times per day as meteorological and experimental conditions allow. Units containing tubular optics shall be tested such that solar noon occurs about the middle of the exposure period.

To conduct the warm-up tests indoors under a solar simulator, the following irradiance profiles shall be used:

- a) The clear day is a constant 800 W/m² for 4 hours.
- b) The first cloudy day is a constant 400 W/m² for 6 hours.
- c) The second cloudy day is 4 hours long consisting of alternating 30-minute periods of 200 W/m² and 600 W/m².

The warm-up tests are expected to yield a minimum of 4 data points (2 each Clear, Low Temperature and 2 each Cloudy, High Temperature). A data point (test) is considered to meet the criteria if the radiation condition is met and the minimum 5 K tank temperature rise is achieved. The goal of the tests is to expose the collector to approximately 13 000 kJ/m² of radiation in each test to equalize relative experimental errors and to equally weight the various conditions. T_{initial} shall be selected so that T_{high} does not exceed the manufacturer's recommended maximum temperature. (Cloudy test length shall be adjusted to not exceed this value.)

The clearness index, K_T , is used to classify clear versus cloudy test conditions:

$$K_T = \frac{\text{Irradiance measured in the plane of the collector}}{\text{Extraterrestrial irradiance in the plane of the collector}}$$

where the extra-terrestrial irradiance is given by:

$$G_o = (I_o * [1 + 0.033 \cos(D)]) \cos \theta$$

where $D = 2\pi n / 365$ radians

Measure insolation and infrared irradiance in the plane of the collector, and ambient temperature during the test.

C.4 Clear, Low Temperature

This test is to be performed on a minimum of 2 clear ($K_T > 0.65$) days. If testing indoors under a solar simulator, only one test needs to be performed.

- a) Charge the system (see B.1) until $T_{\text{initial}} = T_{\text{low}}$. T_{low} needs to be low enough that the T_{high} requirement (see C.2) can be met.
- b) Expose the collector until the collector has been exposed to approximately $13,000 \text{ kJ/m}^2$ ($12,322 \text{ Btu/ft}^2$).
- c) At the conclusion of the irradiation period, cover the collector (or turn off the simulator lamp) and purge (see B.2) the gathered energy from the tank with $T_{\text{in}} = T_{\text{low}}$.

C.5 Cloudy, High Temperature

This test is to be performed on a minimum of 2 cloudy ($K_T < 0.65$) days.

- a) Charge the system (see B.1) until $T_{\text{initial}} = T_{\text{high}}$, where $T_{\text{high}} = T_{\text{low}} + 30 \text{ K}$.
- b) Expose the collector until the collector has been exposed to approximately $13,000 \text{ kJ/m}^2$ ($12,322 \text{ Btu/ft}^2$).
- c) At the conclusion of the irradiation period, cover the collector (or turn off the simulator lamp) and purge (see B.2) the gathered energy from the tank with $T_{\text{in}} = T_{\text{high}}$.

C.6 Required Experimental Data

The minimum real time data to be collected for the comprehensive tests shall consist of the following (in order) in SI units. For ease of modelling, all data channels shall be reported on a regular interval, even if not used. A log indicating such things as draw, purge, and irradiation start and stop times shall be included. Other data including site elevation, longitude, latitude, and test sample orientation shall also be supplied.

- a) Data collection time (both local and solar) and date (YYYYdddhh.hhhhh = year, julian day, decimal hours)
- b) Inlet temperature ($^{\circ}\text{C}$)
- c) Outlet temperature ($^{\circ}\text{C}$)
- d) Ambient temperature (i.e. "Outdoor", if applicable) ($^{\circ}\text{C}$)
- e) Environmental temperature (i.e. "Indoor", if applicable) ($^{\circ}\text{C}$)
- f) Liquid Flow Rate(s) (kg/hr)
- g) Wind velocity (m/s)
- h) Backup energy usage (if applicable) (kWh)
- i) Radiation measurements (if applicable) (W/m^2)
 - 1) Total surface
 - 2) Total horizontal
 - 3) Horizontal diffuse
 - 4) Horizontal infrared

C.7 Analysis

The analysis is implicit in the fitting process for the test data. This is accomplished by the means of a least squares fit (using the simplex method) to a set of data based upon minimizing the residual difference between the Q_{net} experimental and the Q_{net} modelled. The resulting fit shall reproduce the experimentally measured Q_{net} within 10%. In this case, Q_{net} is defined as the sum of the draw, estimated tank losses during the draw period, and the change in energy in the storage vessel that occurs during the test. As a default the following weighting of data is used:

- a) Two low temperature warm-up tests and two high temperature warm-up tests (Typical). Each test is weighted equally. More tests can be used, but the weighting shall maintain an equal balance of low and high temperature tests.
- b) For units with exposed integral storage vessel(s) only: two low temperature warm-up tests, two night-time decay tests, and two high temperature warm-up tests. Each test is weighted equally. More tests can be used, but there shall be a 1/3 weighting of each type of test.

The results of this analysis are the FR_{TC} and FR_{UL} multipliers that are used for modelling these units for a given set of design parameters.

Annex D (normative)

Corrections for effect of hail guards on solar collector efficiency

Warm-up test method if an impact guard is added to a collector after the collector efficiency test then the collector efficiency shall be corrected for

- a) normal incidence shadowing due to the hail guard
- b) incidence angle modifier of hail guard

D.1 Normal incidence shadowing

D.1.1 Cylindrical mesh guard

For an impact guard made of a square mesh of cylinders or wires with pitch W the optical efficiency coefficient shall be reduced by a factor F_N where

$$F_N = 1 - 4 \frac{d_w}{W} \quad (\text{D.1})$$

where

d_w is the diameter of impact guard mesh

W is the pitch of impact guard mesh

D.1.2 Flat cover guard

For a guard consisting of a flat transparent cover placed over the collector the optical efficiency coefficient shall be reduced by a factor equal to the normal incidence transmission of the cover. The transmission of the cover shall be measured to the requirements given in AS/NZS 2712.

D.2 Incidence angle modifier correction

The incidence angle modifier of the collector determined without an impact guard shall be corrected for the incidence angle characteristic of the guard. The guard incidence angle correction shall be applied to both the transverse and longitudinal incidence angle modifier if a bi-axial modifier is used.

The incidence angle modifier for the collector with an impact guard shall be the product of the incidence angle modifier without the hail guard times the guard incidence angle modifier. The product of the incidence angle modifiers shall be evaluated at 10° increments of incidence angle from 0° to 90°.

D.2.1 Cylindrical mesh guard - incidence angle modifier

For an impact guard made of a square mesh of wires of pitch W the guard incidence angle modifier factor in both the transverse and longitudinal planes IAM_g is given by

$$IAM_g = \frac{1 - \frac{d_w}{W \cos \theta}}{1 - \frac{d_w}{W}} \quad (D.2)$$

where θ is the incidence angle in the appropriate plane.

D.2.2 Flat cover guard - incidence angle modifier

For a flat cover guard the guard incidence angle modifier is equal to the angular dependent transmission of the cover. The angular transmission of the cover shall be measured to the requirements given in AS/NZS 2712.

Annex E (normative)

PV powered DC pumps in solar water heating systems

To model the performance of solar water heating system (SWHS) using photovoltaic PV driven pumps it is necessary to characterize the operation of the fluid circulation system. Outlined below is a method to mathematically combine measured and modelled performance of individual components in a PV forced-circulation system to predict the collector loop flow rate as a function of solar irradiance. The fits are set up to discard any data that is not interpolated, so the data sets shall have ranges exceeding the desired system operation. This method assumes the pump and PV module are directly connected. If any controls are integrated into either component, the pair shall be tested together under varying levels of irradiance and under varying pump heads.

E.1 Analysis method for evaluating the system

The performance of a system comprised of multiple components can be predicted if the performance of the individual components is known and there is no active control done by any component. A PV forced-circulation system has three main components. These components are the pump, the system piping, and the PV panel. The variables associated with each component are:

- Pump – current (I), voltage (V), flow (F), and head (H)
- System piping – flow (F) and head (H)
- PV Panel – current (I), voltage (V), irradiance (G), PV panel temperature (T_{pv})

The performance of each component can be empirically described as functions of these variables. The form of the equations representing the functions varies with the specific components. Some can be represented by simple quadratics while others are more complex. The attached figures illustrate one specific example.

Pump performance can be measured directly under various conditions in a test stand (see E.2). All four pump variables can be measured simultaneously. Surface fitting the data yields two functions:

{1} H as a function of F and V:

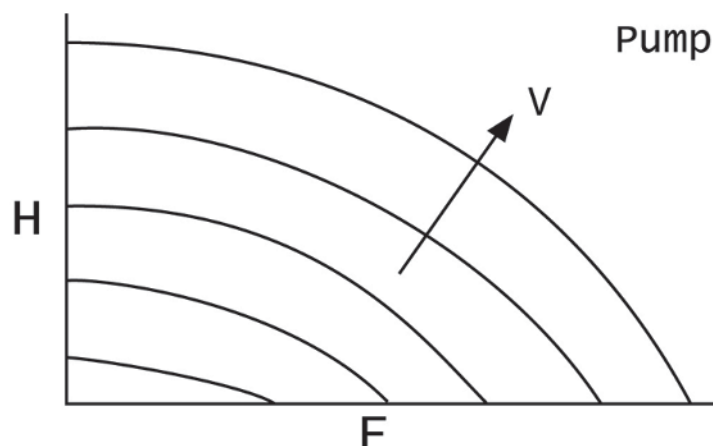

Figure E.1

{2} H as a function of F and I:

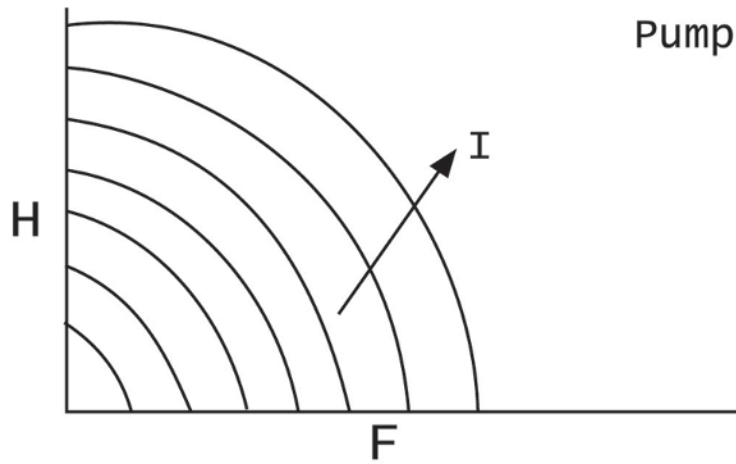

Figure E.2

The system piping performance can be predicted using a pipe distribution analysis program^[15]. However, most commercial programs are not well suited for laminar flow applications, because of the relative differences in fitting losses and the correlations used to predict them. Curve fitting the data yields one function:

{3} H as a function of F:

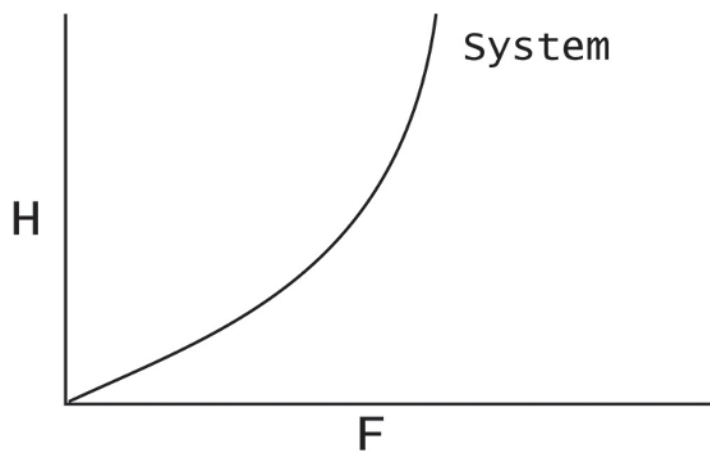

Figure E.3

The PV panel parameters can be measured at various reference conditions (see E.3). A modelling program can predict parameters under other conditions^[15]. This yields one function:

{4} I as a function of V , G , and T_{pv} :

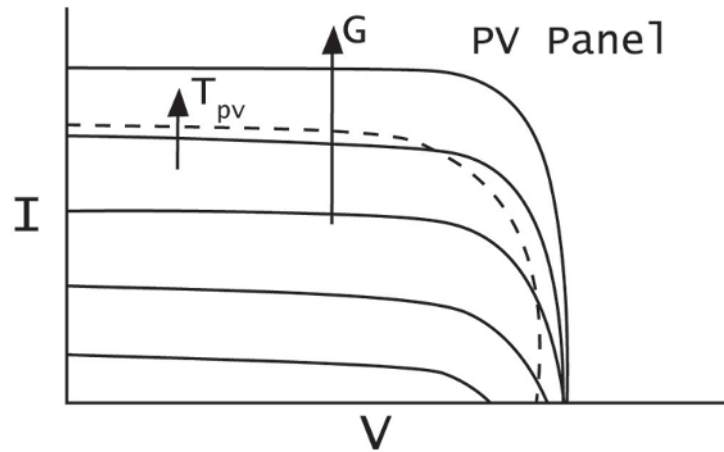

Figure E.4

Note that T_{pv} is currently not being evaluated.

With each component's curve fit known, the functions can be combined to eliminate unnecessary variables. The steps used in the analysis are outlined below.

Pump function {1} combined with system function {3} eliminates H as a variable leaving:

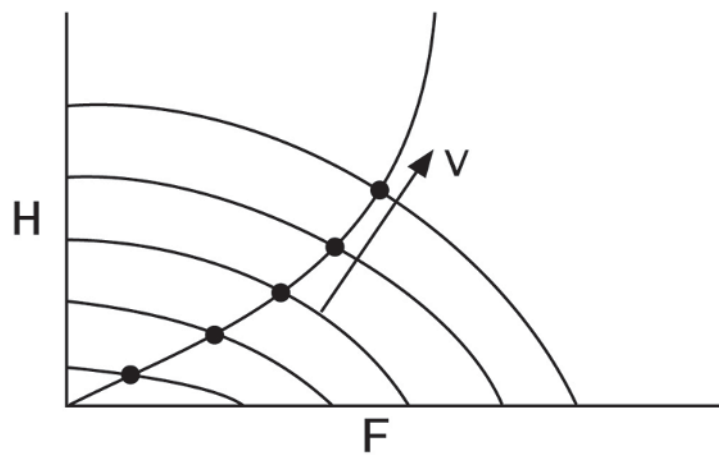

Figure E.5 a)

{5} F as a function of V:

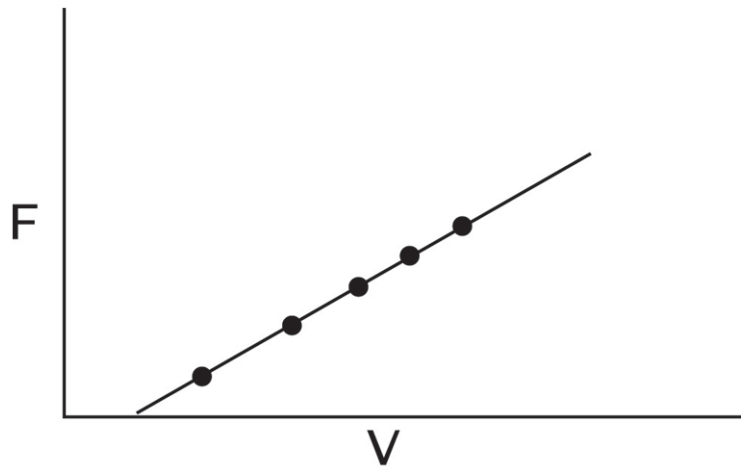

Figure E.5 b)

Pump function {2} combined with system function {3} eliminates H as a variable leaving:

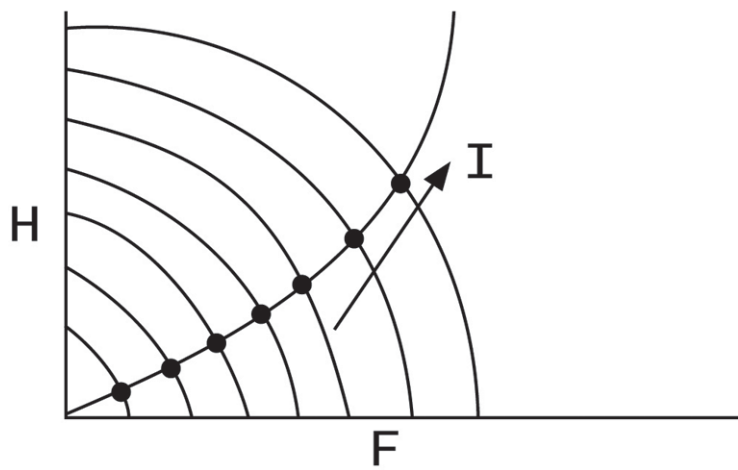

Figure E.6 a)

{6} F as a function of I:

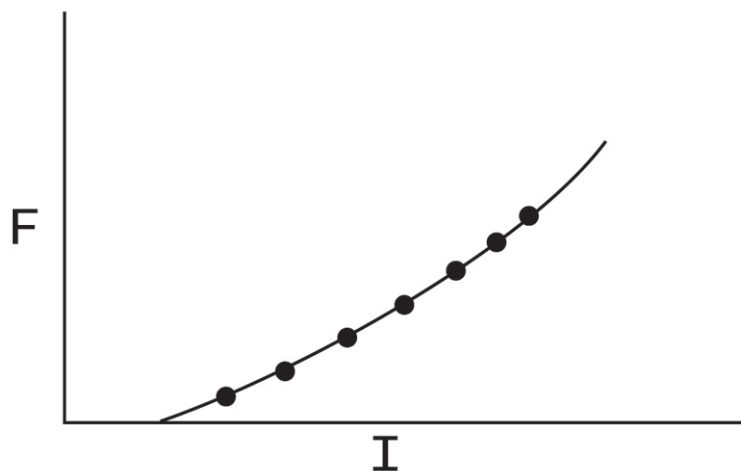

Figure E.6 b)

Pump/system function {5} combined with pump/system function {6} eliminates F as a variable leaving:

{7} I as a function of V:

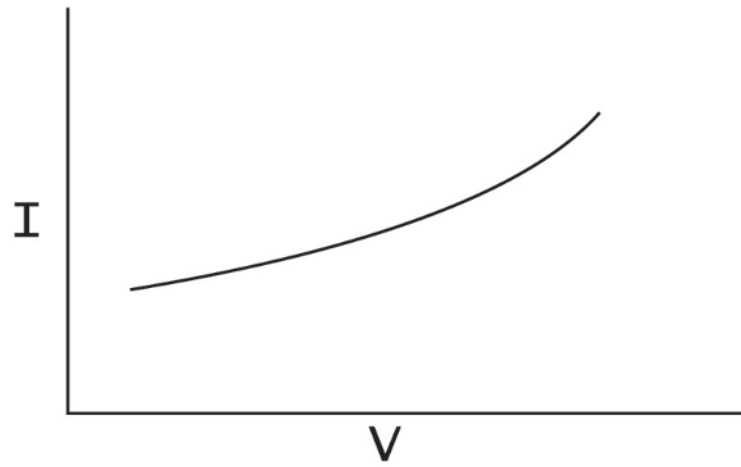

Figure E.7

PV function {4} combined with pump/system function {7} eliminates I as a variable leaving:

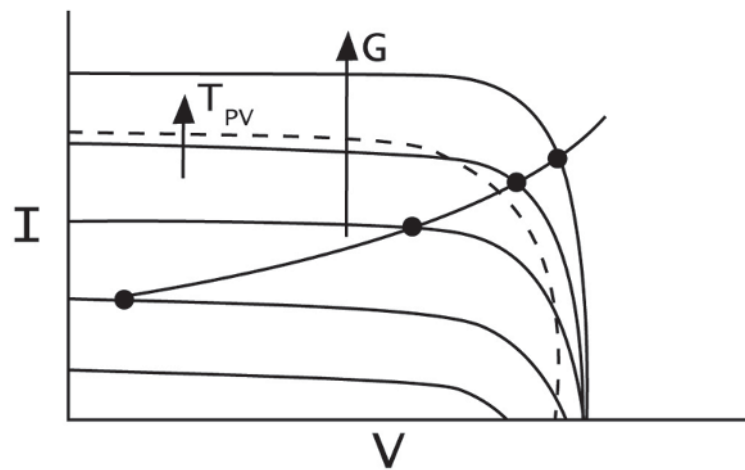

Figure E.8 a)

{8} V as a function of G and T_{pv}

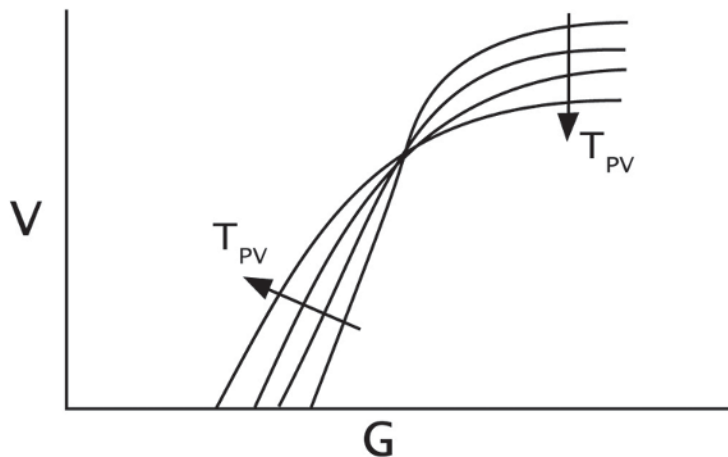

Figure E.8 b)

Pump/system function {5} combined with PV/pump/system function {8} changes the dependent variable from voltage to flow leaving:

{9} F as a function of G and T_{pv}

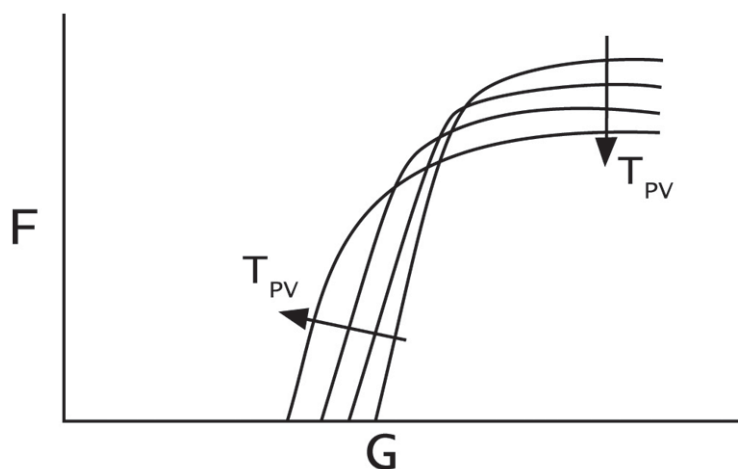

Figure E.9

An empirical formula exists^[16] which relates T_{pv} to both T_{amb} and G. This formula together with above function {9} describes the flow through the collector loop as a function of solar irradiance and ambient air temperature, although this has not been implemented.

Combining {1} and {2} yields dynamic pump power:

{10} P as a function of F

An empirical formula exists which relates P as a function of F. This formula describes the power used by the pump.

Integrating this curve fit into a computer simulation model requires the determination of several values from the fit:

The start-up radiation is usually read from the F versus G graph. Average flow (for stratification) is usually taken from the F vs. G graph. A total of six parameters for the flow and power are input into the computer simulation model from fits {9} and {10}. In some cases, the minimum pump current or voltage must be manually adjusted for a specific system. The likely cause is that there are multiple solutions to the empirical fits, one of which is not desired.

E.2 DC Pump Performance Map (P_{pump} versus H_{pump})

E.2.1 Test method

- a) Subject the pump to a series of system pressure drops by adjusting the throttle on the system loop containing the pump.
- b) For each throttle adjustment, subject the pump to varying voltages by using a variable power supply.
- c) Measure the observed flow rate, pressure increase across the pump, pump voltage and current draw.

E.2.2 Analysis method

- a) Generate empirical curve fits relating pump head to flow and voltage.
- b) Generate empirical curve fits relating pump head to flow and current.
- c) Determine the system pressure drop curve based on the certification program assumptions for plumbing.
- d) Generate an empirical curve fit relating pump flow to irradiance for the specified PV module and DC pump combination for the system.
- e) In order to model PV pumping, the plots of flow versus irradiance and power versus flow are used in the computer simulation model, along with the starting radiation and average pump flow rate.

E.3 Photovoltaic Panel Performance Map (I and V versus G curves and T_{pv})

E.3.1 Test method

The current analysis method does not integrate the panel temperature into the empirical curve fit. Therefore, it is required that the panel temperatures be maintained within the range of 35-45 °C (95-113 °F).

- a) Expose the panel to varying amounts of solar radiation between 100-1 000 W/m² (32-317 Btu/h-ft²) by varying the azimuth and tilt of the collector or the irradiance level if tested indoors. Obtain data at irradiance levels no greater than 150 W/m² apart.
- b) For each irradiance level, ramp the panel through a series of voltages from open circuit to short circuit using a controllable load.
- c) Measure the observed current, voltage, irradiance, panel temperature, and ambient temperature for each set of data.

E.3.2 Analysis Method

For each set of irradiance data, generate empirical curve fits relating current to voltage. (Note that the panel temperature relationship is not currently fit).

Annex F (normative)

Heat exchanger test methods

These tests are to be performed with the heat transfer fluid(s) to be used in the actual installation. If multiple fluids are to be used, multiple tests will be required. A minimum of 10 minutes shall be allowed for the stabilization of fluid flows and temperatures for each set of data points collected in the thermal performance tests. Data during the thermal performance tests shall be reported in 30-second or less intervals. The preferred testing conditions are indoors, although outdoor tests may be performed if the system is covered during the test. For systems that incorporate a collector-side heat exchanger, the explicit heat exchanger test is not usually required as these affects will be measured in the system testing. However, a load side heat exchanger shall be tested under a variety of temperatures and flows expected in normal operation independent of the system testing.

F.1 Pressure integrity tests

If no test pressure is specified by the manufacturer, a hydraulic pressure equal to 1.5 times the manufacturer's stated maximum individual working pressures should be applied.

As applicable, both the supply and load sides of the heat exchanger shall be tested following this procedure:

- a) A pressure gauge is attached to the exit port of the heat exchanger and the outlet is sealed.
- b) The supply side is filled with unheated water.
- c) Hydraulic pressure is applied to the inlet port until the gauge indicates the test pressure has been reached.
- d) The inlet pressure port is then closed and the pressure is monitored for 15 minutes.
- e) The final pressure is recorded.

The result of this test is "pass" if no observable pressure change has occurred.

F.2 Pressure drop test

These tests shall be conducted at 25 °C +/- 5 K. The flow rates used for testing the heat exchanger shall adequately represent the anticipated laminar, transition, and turbulent flow regimes experienced during operation. When testing a natural convection loop heat exchanger, the unit shall be oriented horizontally.

The temperatures and heat transfer fluids used in the heat exchanger shall represent what is expected during actual system use. A minimum of three valid data points shall be collected for each specified temperature/fluid combination. As applicable, both the supply and load sides of the heat exchanger shall be tested following this procedure:

- a) Heat the fluid to a specified operating temperature at the specified flow rate.
- b) Allow the pressure transducers to stabilize and measure the pressure drop.
- c) Repeat steps 1 and 2 for each specified flow rate.

Report all measurements in a consistent set of units. A second order pressure drop curve shall be generated for both the supply side and load side coils. When a natural convection loop heat exchanger is tested, the flow shall be reported in mass units.

F.3 Performance tests

The flow rates used for testing the heat exchanger shall adequately represent the anticipated laminar, transition, and turbulent flow regimes experienced during system operation.

The temperatures and heat transfer fluids used in the heat exchanger shall represent what is expected during actual system use. A minimum of ten minutes of data (30 minutes for natural convection loop exchangers) shall be collected for each specified temperature/flow/fluid combination.

For heat exchangers tested under low flow operating conditions (natural convection), special care shall be taken to ensure the accuracy of flow and temperature measurements. The use of a thermopile is required for measuring the temperature difference between inlet and outlet ports. The preferred method is to operate the heat exchanger with the natural convection loop in operation. In these cases, the flow rate will have to be backed out of the energy balance of the "tank" and "collector" loops. No flow meter shall be used in the natural convection test loop in these cases. When the energy balance technique cannot be used to measure the flow, use forced flow and a low-flow meter.

F.3.1 External doubly pumped heat exchangers

F.3.1.1 Test method

- a) Stabilize flows to within $\pm 0,006$ l/s and temperature to $\pm 0,1$ K.
- b) Commence data collection at 15-second intervals. The rate of data collection and/or stabilization time shall be increased for any flows at or below 0,031 5 l/s. The data will include the two inlet and outlet temperatures, ambient temperature, and the two flow rates. Additional temperature measurements may be required because of the non-linear nature of the heat transfer in long heat exchangers. If necessary, this can be accomplished by using three surface probes (assumed to be on the outer surface) and two internal probes at the inlet and outlet ports.
- c) Adjust the temperatures and/or flow rates and proceed to step a) above until the proper number of valid data points have been collected.

F.3.1.2 Analysis method

- a) Only data collected from the first portion of the test (approximately 1 hour) shall be selected. The goal is to obtain data prior to the energy purge.
- b) The data from each of the data point sets in the test will be used to calibrate the computer simulation model using the UA parameter(s) in the selected heat exchanger model. A linear regression routine will be used to fit the observed net energy deliveries to the observed data points (one per data point). If additional temperature probes are used, then the form of the curve fit from the three surface mounted probes shall be used to interpolate the corresponding internal temperature from the inlet and outlet temperature probes.
- c) The UA parameter(s) shall be used for modelling the heat exchanger in the computer simulation model.

F.3.2 External natural convection loop heat exchangers — Empirical parameter method

F.3.2.1 Test method

- a) Connect heat exchanger, tank and piping together, allowing for the external control of tank and collector temperatures.
- b) Start data collection in 15-second intervals. The data will include the two inlet and outlet temperatures, ambient temperature, the collector-side flow rate, and the flow rate through the tank (not between the tank and the heat exchanger). Additional temperature measurements may be needed because of the non-linear nature of the heat transfer in long heat exchangers. If necessary, this can be accomplished by using three surface probes (assumed to be on the outer surface) and two internal probes at the natural convection loop inlet and outlet ports.
- c) Maintain the tank at a constant temperature near the ambient temperature by using a measured flow of tempered water.
- d) Stabilize collector flow to within +/- 0,006 l/s and temperature to +/- 0,1 K of that specified.
- e) Measure all heat exchanger temperatures, heat exchanger hot side flow rate, and energy required to maintain the tank at a constant temperature.
- f) Every 15 minutes, raise the heat exchanger inlet temperature by 15 °K until it reaches 95 °C.
- g) Stop flow to the tank.
- h) Maintain heat exchanger inlet temperature at 95 °C.
- i) Measure all heat exchanger temperatures and collector-side flow rate.
- j) Stop the test when the tank is within 1 K of the temperature of the fluid entering the collector side of the heat exchanger. This may take up to 1 day.

F.3.2.2 Analysis method

- a) The use of regression software is necessary to analyze this data.
- b) Use the data from both portions of the test along with material properties to generate a fit in the following form: $UA = (P1)Gr^{P2}Re^{P3}Pr^{P4}$

Where P1 through P4 are coefficients from the fit and Gr, Re, and Pr are calculated dimensionless values. UA is calculated using standard heat transfer forms for the geometry of the heat exchanger and its plumbing connections. The thermosiphon flow rate is calculated from an energy balance on the system. (This may require that other losses be quantified first).

F.3.3 External natural convection loop heat exchangers — Modified effectiveness method

F.3.3.1 Test method

- a) Connect the heat exchanger, tank and piping together, allowing for external control of tank and heat exchanger hot side temperatures. The collector loop will be supplied with a controllable hot water loop.
- b) Measure the heat loss coefficient of the heat exchanger.
- c) Start data collection at 60-second intervals. The data will include the two heat exchanger inlet and outlet temperatures, ambient temperature, the collector loop flow rate, tank inlet and outlet temperatures and flow rate through the tank.

- d) Stabilize collector flow to within +/- 0,006 l/s and temperature to +/- 0,1 K of that specified.
- e) Set the collector and tank loop temperatures for each of the following sample cases. Additional cases may be required for different fluids, flow rates, etc. Collect data for the indicated periods.

Table F.1 — Collector and tank loop temperatures

Sample Case	Collector	Tank	Length (hr)
1	80	15	2
2	65	40	2

F.3.3.2 Analysis method

- a) Thermosiphon flow rates shall be calculated from an energy balance on the heat exchanger, using measured temperatures and collector flow rates. Allowances shall be made for thermal losses from the heat exchanger. Plot thermosiphon flow versus time for the various tests.

Calculate the driving pressure using average tank and heat exchanger (NCL loop) temperatures, along with the density of the fluids as a function of temperature. Fit the flow to:

$$M_{sys} = C_1 * \Delta P^{C2} \quad (F.1)$$

Plot M_{sys} vs ΔP for the test period.

- b) Generate plots and fits of heat exchanger performance in terms of modified effectiveness versus flow rate and modified capacity ratio. Calculations will be based upon Equations 2 and 4 of the Lin/Harrison analysis.

$$\text{Equation 2: } \epsilon_{mod} = \frac{(M_{tank} * CP_{tank}) * (T_{tankout} - T_{tankin})}{(M_{coll} * CP_{coll}) * (T_{tankin} - T_{tankout})}$$

$$\text{Equation 4: } Cr_{mod} = \frac{M_{rate-tank} * Cp_{tank}}{M_{rate-coll} * Cp_{coll}}$$

Using these values, calculate a fit for Cr_{mod} as in Equation 5:

$$\text{Equation 5: } \epsilon_{mod} = C_1 * Cr_{mod}^2 + C_2 * Cr_{mod}$$

Plot ϵ_{mod} as a function of Cr_{mod} for the test period.

F.3.4 Immersed heat exchanger — Internal, Load Side

F.3.4.1 Test method

- a) Charge the tank to the specified temperature $T_{initial}$ (see B.1). Two tests are typically conducted. One with the tank slightly above ambient and one with the tank near T_{high} .
- b) Stabilize heat exchanger flow to within +/- 0,006 l/s and temperature to +/- 0,1 K.
- c) Start data collection at 15-second intervals. The rate of data collection and/or stabilization time shall be increased for any flows at or below 0,0315 l/s. The data will include the inlet and outlet temperatures, ambient temperature, and the flow rate.

- d) Run the test for approximately 15 minutes, so that there is only a small change in tank temperature.
- e) Purge the energy in the tank with $T_{in} = T_{initial}$ (see B.2).
- f) Repeat steps a through e for various flow rates (laminar, transition, and turbulent) and tank temperatures.

F.3.4.2 Analysis method

- a) The data from each of the data point sets in the test will be used to calibrate the computer simulation model using the UA value and exponent in the tank coil heat exchanger model. A fitting routine will be used to fit the observed energy deliveries to the observed data points (one per data point).
- b) The UA parameter(s) shall be used for modelling the heat exchanger in computer simulation model.

F.3.5 Immersed heat exchanger — Internal, Supply Side

F.3.5.1 Test Method

- a) Charge the tank to the specified temperature ($T_{initial}$), typically above ambient (see B.1).
- b) Stabilize heat exchanger flow to within +/- 0,006 l/s and temperature (T_{high}) to +/- 0,1K.
- c) Commence data collection at 15-second intervals. The rate of data collection and/or stabilization time shall be increased for any flows at or below 0,0315 l/s (0,5 gpm). The data will include the inlet and outlet temperatures, ambient temperature, and the flow rate.
- d) Run the test for approximately 60 minutes, so that there is a significant change in tank temperature. Ideally, the time period shall be set so that the amount of input energy is the same for each test and enough energy (2000 kJ minimum) is input to avoid experimental error.
- e) Purge the energy in the tank with $T_{in} = T_{initial}$ (see B.2).
- f) Repeat steps a) through e) for various flow rates (laminar, transition, and turbulent) and tank temperatures ($T_{initial}$).

F.3.5.2 Analysis method

- a) The data from each of the data point sets in the test will be used to calibrate the computer simulation model using the UA value and exponent in the tank coil heat exchanger model. A fitting routine will be used to fit the observed energy input to the observed data points (one per data point)
- b) The UA parameter(s) shall be used for modelling the heat exchanger in the computer simulation model.

F.3.6 Immersed heat exchanger

F.3.6.1 Test method

This test procedure is based on a transient 2-sensor method using sensors at the inlet and outlet of the thermal energy storage device. An abrupt and erratic temperature change is applied to the heat exchanger under test. The measurement of the thermal energy storage temperature is based on the temperature of the heat exchanger before the abrupt change of the fluid temperature. The heat transfer capacity rate of the heat exchanger is determined just after the end of the transient phase.

The storage device shall be connected to the testing stand. Connections which enable a complete discharge of the storage vessel shall be connected to the discharge circuit of the testing stand. In order to reach a complete mixture and uniform storage vessel temperatures, the connection shall be carried out in such a way that hot water is drawn from the top of the storage vessel and supplied to its bottom. The connections of the

heat exchanger for which the heat transfer capacity rate is to be determined, shall be connected to the charge circuit of the testing stand. The fluid shall flow through the heat exchanger as specified by the manufacturer. The heat transfer fluid during the test shall be that specified by the manufacturer of the solar heating system. If no heat transfer fluid is specified by the manufacturer, water shall be used.

The following test conditions apply.

The flow rate in the heat exchanger shall be as specified by the manufacturer. If no flow rate is specified by the manufacturer, the flow rate in the heat exchanger shall be 1,2 times the nominal flow rate specified by the manufacturer. The heat transfer power applied to the heat exchanger during the test shall first be identical with the nominal one specified by the manufacturer +/- 10 %. Additional measurements shall be performed with half this power. If no heat transfer power is specified by the manufacturer, the power levels shall be the nominal volume of the storage vessel (in liters) multiplied by 10 W/l and 5 W/l. The temperature of the storage device close by the heat exchanger shall be uniform and successively adjusted to 60 °C, 50 °C, 40 °C, 30 °C, 20 °C, 10 °C with an uncertainty not greater than 1 °C.

F.3.6.1.1 Test phase 1: Initial conditioning

Heat up the whole storage device to 60 °C by means of the charge circuit with the discharge loop being operated as a mixing device. The heating up of the storage vessel may be accomplished with any heating power. However, at the end of the conditioning, the heating power shall be adjusted to the nominal heating power and the corresponding temperature at the outlet of the charge circuit, $T_{C,o,1}$ shall be noted for further reference (see F.3.6.1.2). For the monitoring of the conditioning, $T_{D,o}$ shall be applied as temperature of the storage vessel. In the final stage of conditioning, the heating/cooling unit of the discharge circuit may also be used to adjust the storage vessel temperature more precisely to 60 °C.

F.3.6.1.2 Test phase 2: Measurement of the heat transfer capacity rate of nominal heating power

Change the charge circuit flow pattern to circulate fluid through only the heat exchanger. Stop flow in the discharge circuit to stop mixing in the storage vessel. Wait for steady-state conditions in the storage vessel, defined (only for this purpose) as a difference between $T_{C,i}$ and $T_{C,o}$ of less than 0,05 K and $T_{C,i}$ constant for the last 5 minutes with an uncertainty not exceeding 0,1 K.

Operate the charge circuit in the bypass mode at the temperature of $T_{C,o,1}$ determined under test phase 1 and wait for steady state conditions in the charge circuit.

Perform the temperature change by steps in the heat exchanger as follows:

- Assure that $T_{C,i}$ and $T_{C,o}$ are recorded with a time resolution of at least 1 s during the transient.
- Quickly change the charge circuit flow pattern to circulate fluid at $T_{C,o,1}$ through the heat exchanger.
- After the end of the transient, the measured data may be recorded slower again.

NOTE A typical duration of the transient is approximately 3 min.

To get a second independent measurement result, perform a second temperature step under the same conditions.

F.3.6.1.3 Test phase 3: Measurement of the heat transfer capacity rate at halved nominal heating power

Repeat the complete test phase 2 (two independent measurements) with a reduced temperature of the charge circuit (instead of $T_{C,o,1}$) in order to operate the heat exchanger at half nominal power.

F.3.6.1.4 Test phase 4: Conditioning at the next storage vessel temperature

Discharge the storage device in order to reduce its temperature by 10 K. Mix the storage vessel thoroughly by means of the discharge circuit.

F.3.6.1.5 Test phase 5: Measurement of the heat transfer capacity rate at the new storage vessel temperature

Repeat test phases 2 and 3 (four independent measurements, two at nominal and two at half nominal power).

NOTE The temperature of the charge circuit which is necessary for the transmission of the required power is determined by trial and error based on the values used at the previous measurement steps. The overtemperature needed in the charge circuit is increasing when the storage vessel temperature decreases, as the increasing water viscosity leads to a decrease of the heat transfer capacity rates.

F.3.6.1.6 Test phases 6 - 9: Completion of the entire measurement sequence

Repeat test phases 4 and 5 down to a storage vessel temperature of 10 °C.

F.3.6.2 Analysis method

Figure F.1 shows the temperature variations $T_{C,i}$ and $T_{C,o}$ observed before, during and after the transient described in test phase 2 (see F.3.6.1.2). Two characteristic times are of importance: t_0 , just before the transient, and t_1 , as soon as a quasi-steady state with slow increase of all temperatures can be determined.

NOTE Typically, $t_1 - t_0$ is approximately 1,5 min and the temperature increase of the heated storage vessel in this time interval is less than 2% of the mean logarithmic temperature difference. The mean logarithmic temperature difference is defined according to Equation (F.2). For the smallest storage devices which are equipped with heat exchangers of high nominal power, the temperature increase is greater than 2 % of the mean logarithmic temperature difference which restricts the accuracy of this test procedure.

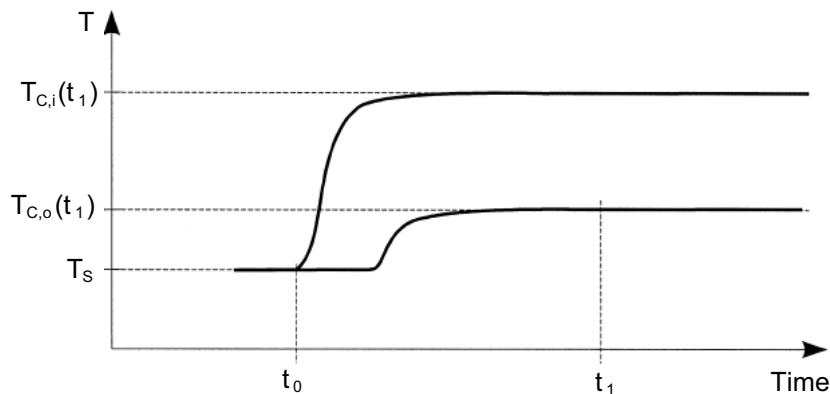

Figure F.1 — Temperatures $T_{C,i}(t)$ and $T_{C,o}(t)$ observed before, during and after the transient described in test phase 2

The storage vessel temperature near to the heat exchanger T_s is $T_{C,i}(t_0)$. This temperature is also equal to $T_{C,o}(t_0)$.

$$\Delta T_m = \frac{T_{C,i}(t_1) - T_{C,o}(t_1)}{\ln\left(\frac{T_{C,i}(t_1) - T_{C,i}(t_0)}{T_{C,o}(t_1) - T_{C,i}(t_0)}\right)} \quad (F.2)$$

The heat transfer capacity rate of the heat exchanger is then

$$(UA)_{hx,s} = \frac{\dot{m}_C x C_{Px} (T_{C,i}(t_1) - T_{C,o}(t_1))}{\Delta T_m} = \dot{m}_C x C_{Px} \ln \left(\frac{T_{C,i}(t_1) - T_{C,i}(t_0)}{T_{C,o}(t_1) - T_{C,i}(t_0)} \right) \quad (F.3)$$

Annex G (normative)

Reference conditions for testing and performance prediction

G.1 Reference conditions

The conditions given in Table G.1 shall be used when calculating, reporting, or comparing the performance of a system from a computer simulation.

Table G.1 — Reference conditions for performance presentation

Reference condition	Value	Remarks
SYSTEM		
Collector orientation	Facing the equator	
Collector tilt angle	Equal to the local latitude	If not fixed for the system or specified by the manufacturer
Total length of collector circuit	20m = 10m + 10m	If piping is not delivered with the system or specified by the manufacturer
Pipe diameter and insulation thickness of collector circuit	See G.2	If piping is not delivered with the system or specified by the manufacturer
Location of the collector circuit pipes	Indoors, for systems with the storage vessel located indoors; outdoors, for systems with the storage vessel located outdoors	As far as possible at the test rig
Storage vessel ambient temperature	15 °C	For systems where the storage vessel is located outside, the ambient temperature from the climate data shall be used
For systems with indirect (hydraulic) backup heating: Power to be applied on backup heat exchanger	(100 ± 30) W per liter of storage vessel volume above the lowest end of heat exchanger	If the auxiliary heater is not delivered with the system and no restrictions have been given in the documentation; the auxiliary heater shall be modelled as an ideal heat source with no heat capacity and constant heating power.
Flow rate through backup heat exchanger	The flow rate through the heat exchanger shall be chosen such that the temperature difference between the inlet and outlet of the auxiliary heat exchanger is (10 ± 2) K under steady state conditions, unless specified otherwise by the manufacturer	
For systems with electrical backup heating: power of electrical element	If an electrical element is normally delivered with the system or specified by the manufacturer, this element shall be used	
For solar-plus-supplementary systems: status of the backup heater	Permanently activated	
Temperature of integrated backup heating	50 °C (maximum temperature of hysteresis)	

Table G.2 — Reference locations for performance presentation

Climate zones Referenced climate zones are from Troll-Pfaffen, 1963 ^[18]	Example cities
Cold (cold-temperature boreal, continental: II, 2)	Edmonton, Alberta, Canada Murmansk, Russia Halifax, Nova Scotia, Canada
Temperate (cool temperate, oceanic: III, 2)	London, England Vancouver, British Columbia, Canada Melbourne, Australia Wellington, New Zealand Valdivia, Chile
Alpine (temperate alpine: III, 3)	Davos, Switzerland Denver, Colorado, USA
Mediterranean (warm temperature subtropical: IV, 1)	Rome, Italy Istanbul, Turkey Lisbon, Portugal San Francisco, California, USA Capetown, South Africa Santiago, Chile
Dry (warm temperature subtropical, semi-desert: IV, 5)	Cairo, Egypt Monterey, Mexico Mendoza, Argentine Republic Iquique, Chile Kalgoorlie, Australia Medina, Saudi Arabia In Salah, Algeria
Tropical (warm temperature subtropical, humid, hot summers: IV, 7)	New Orleans, Louisiana, USA Tampa, FL Tokyo, Japan Shanghai, China Atlanta, Georgia, USA Durban, Australia
Wet (tropical, rainy climate: V, 1)	Manaus, Brazil Tombuktu, Mali Miami, Florida, USA Stanleyville, Democratic Republic of the Congo Manus, Papua New Guinea San Juan, Puerto Rico Colombo, Sri Lanka Djakarta, Indonesia Panama City, Panama
Subtropical (tropical wet and dry: V, 3)	Madaras, India Darwin, Australia Majunga, Madagascar Lusaka, Zambia Fortalez, Brazil Kingston, Jamaica
Hot (tropical semi-desert: V, 5)	Alice Springs, Australia Trujillo, Peru Mazatlan, Mexico
Climate data	Available at http://standards.iso.org/iso

Table G.3 — Heat load

HEAT LOAD		
Daily load pattern	For all systems: See G.4	Load pattern is from ASHRAE 90.2
Cold water supply temperature	See G.3	
Desired (mixing valve) temperature	45 °C	
Daily load volume	<p>The load volumes in litres per day shall be chosen from the following series: 50 l/d, 80 l/d, 110 l/d, 140 l/d, 170 l/d, 200 l/d, 250 l/d, 300 l/d, 400 l/d, 600 l/d. If larger loads are required, the series may be extended by repeatedly multiplying by the square root of 2 and rounding to the nearest multiple of 10.</p> <p>The manufacturer shall give a design load for the system. The nearest value given in the above series shall be used, as well as the next lower and higher values. It is recommended to use all lower and higher values from the series, which lie between 0,5 and 1,5 times the design load.</p> <p>NOTE Fixed load volumes have been chosen to facilitate comparison of the performance of different systems.</p>	
Draw-off flow rate	10 l/min	If the maximal design draw-off flow rate of the system is less than 10 l min^{-1} , the maximum design draw-off rate of the system shall be used.

G.2 Pipe diameter and insulation thickness

If the pipe and insulation for the collector circuit are delivered with the system, or the pipe diameter and the insulation thickness to be used for the collector circuit are clearly specified in the installation manual for the system, the delivered hardware or the specified values shall be used.

When piping and insulation are not delivered with the system or clearly specified, the pipe diameter, the pipe thickness and the insulation thickness given in Table A.2 shall be used for forced-circulation systems.

The material for the collector circuit piping shall be copper, unless specified otherwise in the installation manual.

Table G.4 — External pipe diameter and insulation thickness for forced-circulation systems

Flow rate in collector circuit l/h	External pipe diameter ^a mm	Pipe thickness mm	Thickness of one layer insulation ^b mm
< 90	10	1	20
90 - 140	12	1	20
140 - 235	15	1	20
235 - 405	18	1	20
405 - 565	22	1	20
565 - 880	28	1,5	30
880 - 1 445	35	1,5	30
1 445 - 1 500	42	1,5	39
> 1 500	Such that the flow velocity is approximately 0,5 m/s	1,5	as the internal pipe diameter

^a Tolerance 1 mm.
^b Tolerance 2 mm.

G.3 Calculation of cold water temperature at reference location

The cold water temperature shall be calculated according to Reference [19]:

$$T_{CW} = \bar{T}_{a, avg} + \text{offset} + \text{ratio} * 0.5 * (T_{a, avg, max} - T_{a, avg, min}) * \sin\left(\frac{0.986 * (n - 15 - \text{lag} - \text{hemisphere}) * 180}{\pi}\right)$$

where

offset is 3.3 °C

ratio = $0.4 + 0.01 * ((\bar{T}_{a, avg} * 1.8 + 32) - 44)$

$T_{a, avg, max}$ is the maximum monthly average ambient temperature (e.g. July in the northern hemisphere)

$T_{a, avg, min}$ is the minimum monthly average ambient temperature (e.g. January in the northern hemisphere)

0.986 = degrees/day (360/365)

lag = $35 - ((\bar{T}_{a, avg} * 1.8 + 32) - 44)$

hemisphere is 90 in the Northern hemisphere, 270 in the Southern hemisphere

G.4 Daily load pattern

The hot water load for each hour is the daily load volume multiplied by the factor for that hour from Table G.5.

Table G.5 — Daily Domestic Hot water Load Profile^[20]

Time of day	Factor
0000-0100	0.0085
0100-0200	0.0085
0200-0300	0.0085
0300-0400	0.0085
0400-0500	0.0085
0500-0600	0.0100
0600-0700	0.0750
0700-0800	0.0750
0800-0900	0.0650
0900-1000	0.0650
1000-1100	0.0650
1100-1200	0.4600
1200-1300	0.4600
1300-1400	0.0370
1400-1500	0.0370
1500-1600	0.0370
1600-0700	0.0370
1700-1800	0.0630
1800-1900	0.0630
1900-2000	0.0630
2000-2100	0.0630
2100-2200	0.0510
2200-2300	0.0510
2300-0000	0.00085

Annex H (informative)

Example simulation models

The task performance simulation for this International Standard can use the TRNSYS simulation program (version 15 or later) and extensions developed for new product features. TRNSYS is a transient system simulation program developed by the Solar Energy Laboratory at The University of Wisconsin. TRNSYS has gained worldwide acceptance as a result of its modular configuration and the availability of the FORTRAN source code in the public domain. The modular nature of the code means that it can be readily extended to include new energy devices and systems. The software required for the implementation of this International Standard is available from The University of Wisconsin^[7].

Extensions to TRNSYS for thermosiphon solar water heaters, specialized heat exchangers and controllers have been developed by the Solar Thermal Energy Laboratory at The University of New South Wales^[8] and others.

H.1 TRNSYS DECK EXAMPLES

Example TRNSYS input files (deck files) for thermosiphon and pumped solar water heaters are available from MechLab^[9].

Table H.1 — Example TRNSYS input files

Input files	Description
Thermosiphon1.dck	Horizontal tank thermosiphon solar water heater with in-tank electric backup heater
Thermosiphon2.dck	Horizontal tank thermosiphon solar water heater with series instantaneous gas backup heater
Pump1.dck	Forced circulation solar water heater with in-tank electric backup heater
Pump2.dck	Forced circulation solar water heater with series instantaneous gas backup heater

The weather data reader (Unit 9), radiation processor (Unit 16) and thermal energy delivery mixing valve (Unit 25) given in the example files shall be retained in user constructed TRNSYS deck files.

H.2 SOURCE CODE

FORTRAN source code of the component models used to generate the simulation program is supplied with the TRNSYS and TRNAUS packages. Features of the TRNAUS extensions include:

H.3 NONLINEAR SOLAR COLLECTOR EFFICIENCY CHARACTERIZATION

The solar collector test AS/NZS 2535 defines a wide range of functions that can be used to describe the performance of solar collectors. The solar collector module in TRNSYS has been extended to include some of the nonlinear efficiency functions recommended in AS/NZS 2535. The thermosiphon routine has also been extended to include nonlinear solar collector characterization.

The solar collector routine in TRNAUS includes the following collector efficiency characterizing functions:

$$\eta = a_1 - a_2 \frac{\bar{T} - T_a}{G_T} - a_3 \frac{(\bar{T} - T_a)^2}{G_T} \quad (\text{H.1})$$

Equation H.1 is applicable to flat plate collectors with a temperature-dependent heat loss coefficient:

$$\eta = b_1 - b_2 \frac{\bar{T} - T_a}{G_T} - a_3 \frac{(\bar{T}^4 - T_a^4)}{G_T} \quad (\text{H.2})$$

Equation H.2 is applicable to evacuated tubular collectors.

$$\eta = c_1 - (c_2 + c_3 u) \frac{\bar{T} - T_a}{G_T + \frac{\varepsilon}{\alpha} G_L} \quad (\text{H.3})$$

Equation H.3 is applicable to flat plate unglazed collectors or heat pump evaporators with a wind speed dependent heat loss coefficient, the effect of long wave radiation exchange with the sky is included.

TRNAUS Type101 (2) can be used to model non-linear collector functions in pumped and thermosiphon solar water heaters and heat pump water heaters.

H.4 INCIDENCE ANGLE MODIFIER

The solar collector routine has been extended to allow the optical response of collectors to be specified via a map of incidence angle modifiers. If detailed optical data is available from tests prescribed in AS/NZS 2535, this extension allows a more accurate specification of optical effects than the standard bi-axial optical response product function. This feature requires the extended DATA function available in TRNAUS. The solar collector incidence angle modifier ($K_{\tau\alpha}$) features the following options.

H.4.1 Symmetric collectors

Both TRNSYS and TRNAUS include the ASHRAE 93-77 [10] function for the incidence angle response of flat plate collectors given by Equation (H.4).

$$K_{\tau\alpha} = 1 - d \times (1 / \cos(\theta) - 1) \quad (\text{H.4})$$

H.4.2 Data table of incidence angle modifier values

A table of up to 50 values of incidence angle modifier data as a function of incidence angle can be specified in TRNAUS extended collector function.

H.4.3 Collectors with North-South and East-West symmetry

Bi-axial incidence angle modifiers may be specified as a table of values for North-South (KNS) and East-West planes (KEW) as a function of transverse and longitudinal incidence angles. The overall incidence angle modifier is computed from the product of the two orthogonal modifiers.

$$K_{\tau\alpha} = K_{NS} \times K_{EW} \quad (\text{H.5})$$

H.4.4 Incidence angle modifier map

Incidence angle modifiers may be specified as a two-dimensional table of values with up to 50 points in the North-South plane and up to 25 points in East-West incidence plane.

H.4.5 Collectors with East-West symmetry only

An incidence angle modifier map with up to 50 points of positive and negative North-South angles, and up to 25 values of positive only East-West incidence angles may be specified. Non-symmetric response in the North-South plane is defined for negative North-South incidence angles when the sun is above the collector normal and positive North-South angles when the sun is below the collector normal. The extended optical response functions are available in TRNAUS Type101.

H.5 COLLECTOR CONFIGURATION

Modelling of the collector interconnection with the tank has been extended to include the following configurations available in TRNAUS Type138.

H.5.1 Collector heat removal via heat pipe

Direct coupling of a horizontal storage tank to a collector array via heat pipes inserted in the bottom of the storage tank may be evaluated.

H.5.2 Thermosiphon systems with collector loop heat exchanger

Thermosiphon systems with heat exchangers between the collector and the storage tank can be analyzed. Heat exchangers in the form of a wrap-around coil outside a vertical tank, an immersed coil or a horizontal tank in tank heat exchanger can be evaluated.

H.5.3 Serpentine riser solar collector

A thermosiphon circuit with a serpentine riser collector plate can be evaluated.

H.5.4 Thermal cut-off valve in the thermosiphon loop

A thermal cut-off valve in the thermosiphon collector loop can be evaluated. Flow cut-off valves are used in some products to minimize the effect of collector overheating in summer. The valve stops thermosiphoning through the collector when the temperature in the bottom of the tank reaches a specified value. This feature is available in TRNAUS Type145.

H.6 STORAGE TANK CONFIGURATION

H.6.1 Over-temperature relief valve

Energy dumping through a temperature relief valve in a stratified storage tank can be evaluated in the TYPE138 tank model. The energy lost through the dump valve is listed as a separate output. In the Type60 TRNSYS tank model (and the TYPE160 TRNAUS extensions of this model) dumped energy is lumped with the load energy. Energy dumping can be a significant problem in summer for a system that incorporates high-efficiency collectors without an over temperature control device. AS/NZS 2712 specifies a test for assessing the potential for water dumping due to over temperature conditions in the storage tank.

H.6.2 One-shot backup heating

This is a control module to model time limited or one-shot user control of a backup heater. The module has two possible operation modes.

Model of the behaviour of a user who switches a night rate backup element to continuous backup for a fixed time. TYPE176 sets a logic signal to 1 for a specified time after the input signal (temperature) drops below a set value. This can be used to simulate the user initiated change of the backup heating mode.

or

Model of one-shot backup of night rate water heaters initiated by the user. This mode has a lock-out feature that allows only one user initiated backup cycle to occur each day. The reset of the TYPE176 lockout occurs at midnight after the one-shot backup.

Annex I (informative)

Guidelines for equipment suppliers

I.1 Introduction

An equipment supplier desiring to have a solar water heating system characterized using this International Standard shall do the following.

I.2 Procedure

- Contact the Certification Body whose certification is required for the areas where the system is to be installed to obtain design and installation requirements specific to that area
- Design a solar water heating system to meet the requirements of the customer and the requirements of the Certification Body
- Determine which tests are required for each component of the solar water heating system by referring to these paragraphs of this International Standard:
 - Storage vessels: 6.2.1
 - Pumps: 6.2.2
 - Solar collector: 6.2.3
 - Heat exchangers: 6.2.4
- Submit the solar water heating system to a laboratory accredited to perform the tests specified in this International Standard
- Submit the results of the test to the Certification Body

Annex J (informative)

Guidelines for Certification Bodies

J.1 Introduction

Since this International Standard gives different options with respect to use of component test standards, a Certification Body desiring to use the methods described in this part of ISO 9459 to determine ratings for solar water heating systems must specify in the certification scheme exactly which standards, test methods, and conditions are to be used to fulfil the requirements of the certification scheme.

J.2 Procedure

The Certification Body shall:

- Set requirements for design and installation of solar water heating systems
- Specify allowable methods of taking data:
 - a) Manufacturers declaration
 - b) Calculation based on sub-component data
 - c) Simple testing
 - d) Detailed testing
- Specify which standard/test method will be acceptable for the certification scheme. The available component standards are listed in Table J.1.

Table J.1 — List of standards / test methods

Component	Applicable standards/test methods
Storage tanks	EN 12977-3, ISO 9459-4, Annex B
Collectors	ISO 9806
Controllers	EN 12977-5

- Select the conditions to be used to calculate ratings:
 - hot water load type: volume or energy based
 - usage quantity volume(s) or energy
 - hot water usage profile(s) (how much hot water is drawn at what times)
 - desired delivery temperature (set point and dead band) and minimum allowable delivery temperature
 - flow rate at which hot water is drawn

- solar collector orientation (tilt and azimuth)
- length of piping between the solar collector and the storage vessel
- weather conditions (cities)
- temperature of the environment around the solar storage vessel and backup heater
- temperature of the water coming into the solar water heating system from the main water supply
- conventional water heating system(s) to be used for calculating purchased energy savings
- Select the computer model(s) to be used to calculate ratings
- Select who will develop and run the computer model
- Determine how the ratings will be published.

Bibliography

- [1] AS 4552:2005, *Gas fired water heaters for hot water supply and/or central heating*
- [2] AS/NZS 4692:2005, *Electric water heaters*
- [3] AS/NZS 4692.1, *Electric water heaters — Part 1: Energy consumption, performance and general requirements*
- [4] ISO 9806 (all parts), *Test methods for solar collectors*
- [5] ASHRAE 23-93, *Methods of testing for rating positive displacement refrigerant compressors and condensing units*
- [6] KLEIN, S.A. et al. *TRNSYS A Transient System Simulation Program User's Manual*. The University of Wisconsin Solar Energy Lab, 2004. <http://sel.me.wisc.edu/trnsys/default.htm>
- [7] MORRISON, G.L. *TRNSYS Extensions for Australian Solar Water Heating Systems (TRNAUS)*, Solar Thermal Energy Laboratory, The University of NSW, Sydney, 2007 <http://solar1.mech.unsw.edu.au/glm/trnaus/TRNAUS.pdf>
- [8] MechLab@unsw.edu.au (Mechanical Engineering, University of NSW Sydney 2052 Australia)
- [9] ASHRAE 93-77, *Methods of testing to determine the thermal performance of solar collector*
- [10] ACADS-BSG <http://members.ozemail.com.au/~acadsbsg/>
- [11] MARTIN, M. and BERDAHL, P., "Characteristics of Infrared Sky Radiation in the United States", *Solar Energy* V33, 321-336, 1984
- [12] MORRISON, G.L. and LITVAK, A. *Condensed Solar Radiation Data Base for Australia*, Solar Thermal Energy Laboratory, The University of NSW, Report FMT/1/1999. <http://solar1.mech.unsw.edu.au/glm/trnaus/tmy99.pdf>
- [13] KLEINBACH, E.M., (M.S., 1990), "Performance Study of One-Dimensional Models for Stratified Thermal Storage Tank", University of Wisconsin at Madison.
- [14] Cybernet, Waterbury, CT: Haestad Methods, Inc. 199210 Buresch, Matthew, Photovoltaic Energy Systems, New York: McGraw-Hill, Inc. 1993, p. 87
- [15] Ibid, p.76
- [16] DUFFIE, J.A. and BECKMAN, W.A., 1980, *Solar Engineering of Thermal Processes*, John Wiley & Sons.
- [17] TROLL, C. and PFAFFEN, K.H. 1963, Seasonal climate of the earth, *Erdkunde* 18, 5-28
- [18] HENDRON, R., "Building America Research Benchmark Definition, Updated December 15, 2006," NREL/TP-550-40968, Golden, Colorado, National Renewable Energy Laboratory, 2006
- [19] ASHRAE 90.2 *Energy-Efficient Design of Low-Rise Residential Buildings*
- [20] AS/NZS 4234:2008, *Heated water systems — Calculation of energy consumption*

British Standards Institution (BSI)

BSI is the national body responsible for preparing British Standards and other standards-related publications, information and services.

BSI is incorporated by Royal Charter. British Standards and other standardization products are published by BSI Standards Limited.

About us

We bring together business, industry, government, consumers, innovators and others to shape their combined experience and expertise into standards-based solutions.

The knowledge embodied in our standards has been carefully assembled in a dependable format and refined through our open consultation process. Organizations of all sizes and across all sectors choose standards to help them achieve their goals.

Information on standards

We can provide you with the knowledge that your organization needs to succeed. Find out more about British Standards by visiting our website at bsigroup.com/standards or contacting our Customer Services team or Knowledge Centre.

Buying standards

You can buy and download PDF versions of BSI publications, including British and adopted European and international standards, through our website at bsigroup.com/shop, where hard copies can also be purchased.

If you need international and foreign standards from other Standards Development Organizations, hard copies can be ordered from our Customer Services team.

Subscriptions

Our range of subscription services are designed to make using standards easier for you. For further information on our subscription products go to bsigroup.com/subscriptions.

With **British Standards Online (BSOL)** you'll have instant access to over 55,000 British and adopted European and international standards from your desktop. It's available 24/7 and is refreshed daily so you'll always be up to date.

You can keep in touch with standards developments and receive substantial discounts on the purchase price of standards, both in single copy and subscription format, by becoming a **BSI Subscribing Member**.

PLUS is an updating service exclusive to BSI Subscribing Members. You will automatically receive the latest hard copy of your standards when they're revised or replaced.

To find out more about becoming a BSI Subscribing Member and the benefits of membership, please visit bsigroup.com/shop.

With a **Multi-User Network Licence (MUNL)** you are able to host standards publications on your intranet. Licences can cover as few or as many users as you wish. With updates supplied as soon as they're available, you can be sure your documentation is current. For further information, email bsmusales@bsigroup.com.

BSI Group Headquarters

389 Chiswick High Road London W4 4AL UK

Revisions

Our British Standards and other publications are updated by amendment or revision.

We continually improve the quality of our products and services to benefit your business. If you find an inaccuracy or ambiguity within a British Standard or other BSI publication please inform the Knowledge Centre.

Copyright

All the data, software and documentation set out in all British Standards and other BSI publications are the property of and copyrighted by BSI, or some person or entity that owns copyright in the information used (such as the international standardization bodies) and has formally licensed such information to BSI for commercial publication and use. Except as permitted under the Copyright, Designs and Patents Act 1988 no extract may be reproduced, stored in a retrieval system or transmitted in any form or by any means – electronic, photocopying, recording or otherwise – without prior written permission from BSI. Details and advice can be obtained from the Copyright & Licensing Department.

Useful Contacts:

Customer Services

Tel: +44 845 086 9001

Email (orders): orders@bsigroup.com

Email (enquiries): cservices@bsigroup.com

Subscriptions

Tel: +44 845 086 9001

Email: subscriptions@bsigroup.com

Knowledge Centre

Tel: +44 20 8996 7004

Email: knowledgecentre@bsigroup.com

Copyright & Licensing

Tel: +44 20 8996 7070

Email: copyright@bsigroup.com



...making excellence a habit.™