

BS ISO 7800:2012



BSI Standards Publication

Metallic materials — Wire — Simple torsion test

bsi.

...making excellence a habit.™

National foreword

This British Standard is the UK implementation of ISO 7800:2012. It supersedes BS ISO 7800:2003 which is withdrawn.

The UK participation in its preparation was entrusted to Technical Committee ISE/101/2, Ductility testing.

A list of organizations represented on this committee can be obtained on request to its secretary.

This publication does not purport to include all the necessary provisions of a contract. Users are responsible for its correct application.

© The British Standards Institution 2012. Published by BSI Standards Limited 2012

ISBN 978 0 580 68835 5

ICS 77.040.10

Compliance with a British Standard cannot confer immunity from legal obligations.

This British Standard was published under the authority of the Standards Policy and Strategy Committee on 31 March 2012.

Amendments issued since publication

Date	Text affected
------	---------------

INTERNATIONAL
STANDARD

BS ISO 7800:2012

ISO
7800

Third edition
2012-03-15

**Metallic materials — Wire — Simple
torsion test**

Matériaux métalliques — Fils — Essai de torsion simple



Reference number
ISO 7800:2012(E)

© ISO 2012



COPYRIGHT PROTECTED DOCUMENT

© ISO 2012

All rights reserved. Unless otherwise specified, no part of this publication may be reproduced or utilized in any form or by any means, electronic or mechanical, including photocopying and microfilm, without permission in writing from either ISO at the address below or ISO's member body in the country of the requester.

ISO copyright office
Case postale 56 • CH-1211 Geneva 20
Tel. + 41 22 749 01 11
Fax + 41 22 749 09 47
E-mail copyright@iso.org
Web www.iso.org

Published in Switzerland

Contents

Page

Foreword	iv
1 Scope	1
2 Symbols and designations	1
3 Principle	2
4 Testing equipment	2
5 Test piece	2
6 Testing conditions	3
7 Procedure	3
8 Test report	4
Annex A (informative) Recommended types of jaws depending on the diameter d or characteristic dimension h of the wire	5
Annex B (informative) Evaluation of fractures occurring during simple torsion test	6

Foreword

ISO (the International Organization for Standardization) is a worldwide federation of national standards bodies (ISO member bodies). The work of preparing International Standards is normally carried out through ISO technical committees. Each member body interested in a subject for which a technical committee has been established has the right to be represented on that committee. International organizations, governmental and non-governmental, in liaison with ISO, also take part in the work. ISO collaborates closely with the International Electrotechnical Commission (IEC) on all matters of electrotechnical standardization.

International Standards are drafted in accordance with the rules given in the ISO/IEC Directives, Part 2.

The main task of technical committees is to prepare International Standards. Draft International Standards adopted by the technical committees are circulated to the member bodies for voting. Publication as an International Standard requires approval by at least 75 % of the member bodies casting a vote.

Attention is drawn to the possibility that some of the elements of this document may be the subject of patent rights. ISO shall not be held responsible for identifying any or all such patent rights.

ISO 7800 was prepared by Technical Committee ISO/TC 164, *Mechanical testing of metals*, Subcommittee SC 2, *Ductility testing*.

This third edition cancels and replaces the second edition (ISO 7800:2003), which has been technically revised.

Metallic materials — Wire — Simple torsion test

1 Scope

This International Standard specifies a method for determining the ability of metallic wire of diameter or characteristic dimension from 0,1 mm to 14 mm to undergo plastic deformation during simple torsion in one direction.

2 Symbols and designations

The symbols and designations used in the simple torsion test of round wire and shaped wire are shown in Figure 1 and Figure 2, respectively, and listed in Table 1.

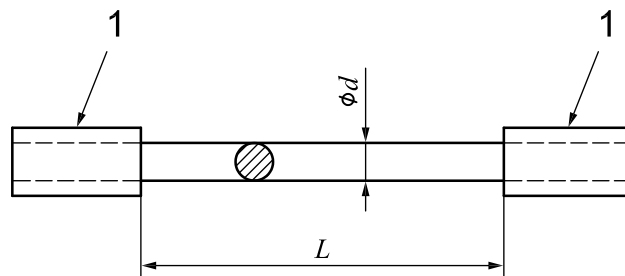

Key

1 grip

Figure 1 — Round wire

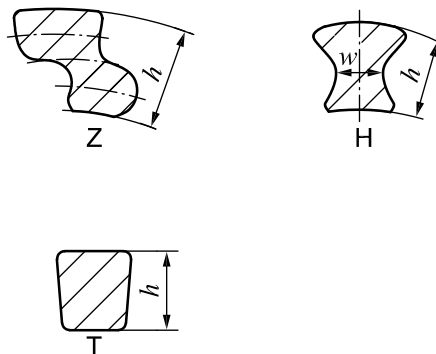

Figure 2 — Typical shaped wire section

Table 1 — Symbols and designations

Symbol	Designation	Unit
d	Diameter of a round wire	mm
h	Characteristic dimension for a shaped wire ^a	mm
w	Minimum narrowing width for a shaped wire	mm
L	Free length between grips	mm
N_t	Number of turns	—

^a For example, the characteristic dimension for some shaped wires is the height of the cross-section and is usually specified in the relevant standard, as shown in Figure 2.

3 Principle

The test consists of twisting a test piece of wire around its own axis in one direction.

4 Testing equipment

4.1 The jaws shall have a minimum hardness of 55 HRC in jaws, and parallel faces.

The recommended types of jaws are given in Annex A.

4.2 The testing machine shall be constructed so that a change of length between the grips, caused by contraction of the test piece during the test, is not prevented and that an appropriate tensile stress (see 7.1) may be applied to the test piece.

The grips shall be placed in the testing machine in such a way that during testing they remain on the same axis and do not apply any bending force to the test piece.

One of the grips shall be capable of being rotated around the axis of the test piece while the other shall not be subject to any angular deflection, except for such deflection as may be necessary to measure the torque.

The distance between the grips shall be capable of adjustment and measurement for different test piece lengths.

The testing speed shall be adjusted and controlled within 10 % of its nominal value, and the number of turns shall be recorded.

A protective shield shall be provided to protect the operator from flying fragments in cases when the wire breaks into more than two pieces.

5 Test piece

5.1 The length of wire to be used as the test piece shall be as straight as possible.

5.2 If straightening is necessary, it shall be done by a suitable method.

During straightening, the surface of the wire shall not be damaged and the test piece shall not be subjected to any twisting.

Wire with sudden sharp curvature towards the longitudinal neutral axis of cross-section shall not be tested.

Unless otherwise specified, the nominal free length between the grips of round wire and shaped wire shall be as given in Table 2 and Table 3, respectively.

Table 2 — Free length between the grips depending on the nominal diameter of the round wire

Nominal diameter, d , mm	Free length between grips mm, (nominal) ^a
$0,1 \leq d < 1$	$200 d$
$1 \leq d < 5$	$100 d$
$5 \leq d \leq 10$	$50 d$
$10 < d \leq 14$	$25 d^b$

^a The free length between the grips shall be a maximum of 500 mm.

^b Only for steel wires.

Table 3 — Free length between the grips depending on the nominal characteristic dimension of the shaped wire^a

Type of profile of typical shaped wires	Nominal dimension, h , mm	Free length between grips mm, (nominal)
Z	$2 \leq h < 5$	$100 h$
	$5 \leq h < 8$	500
H	$2 \leq h < 5$	$100 h$
	$5 \leq h < 8$	500
T	$2 \leq h < 5$	$100 h$
	$5 \leq h < 6$	500

^a Only for steel wires.

6 Testing conditions

In general, the test is carried out at ambient temperature between 10 °C and 35 °C. Tests carried out under controlled conditions, where required, shall be made at a temperature of (23 ± 5) °C.

7 Procedure

7.1 Place the test piece in the testing machine in such a way that its longitudinal axis coincides with the axis of the grips and so that it remains straight during the test. Unless otherwise specified, this may be ensured by applying to the test piece a constant tensile stress not exceeding 2 % of the nominal tensile strength of the wire. For steel wire over 10 mm diameter, the application of tensile stress is not necessary.

7.2 After placing the test piece in the testing machine, rotate one grip at the nominal value of testing speed ± 10 % until the test piece breaks or until a specified number of turns is reached. Count the number of complete turns imparted to the wire by the rotating grip.

For the verification of number of turns, a coloured surface line should be drawn.

7.3 Unless otherwise specified in the relevant standard, the nominal values of the testing speed shall be as given in Table 4 for steel, copper and copper alloys, aluminium and aluminium alloys of the diameters given.

Because the simple torsion test is an isothermal test, an essential increasing of temperature of the test piece should be avoided. For wires sensitive to strain rate and wires for which there is a little knowledge of its strain rate behaviour, the temperature increase should be controlled, for example, it should not be higher than 60 °C. For some steel wires which are not sensitive to strain rate, a higher testing speed can be used to increase testing efficiency.

Table 4 — Nominal testing speed for round and shaped wire

Diameter, d , or characteristic dimension, h mm	Number of turns per second		
	Steel	Copper and copper alloys	Aluminium and aluminium alloys
$0,1 \leq d (h) < 1$	1 or 3 ^a	5	1
$1 \leq d (h) < 1,5$	0,5 or 1 ^a	2	
$1,5 \leq d (h) < 3$		1,5	
$3 \leq d (h) < 3,6$		1	
$3,6 \leq d (h) < 5$		0,5	
$5 \leq d (h) \leq 10$	0,25 or 0,5 ^a	0,5	
$10 < d (h) \leq 14$	0,1	—	—

^a Only for steel wires which are not sensitive to strain rate.

7.4 If the number of turns, N_t , meets the requirements of the relevant standard, the test piece shall be considered as having passed the test, irrespective of the position of failure. If the number of turns, N_t , reached does not meet the requirements of the relevant standard and the failure is within a distance of $2d$ or $2h$ from the grips, the test shall be considered invalid and shall be repeated.

NOTE A tested wire often breaks into more than two parts, subsequent fractures resulting from the rapid springback of the twisted wire following the initial fracture. In many cases, the initial fracture will have a smooth surface perpendicular to the wire axis. The above criterion for the test validity only applies to the location of this initial break. The evaluation of fractures occurring during the test in 7.5, if required, is only for the initial fracture.

7.5 Where the fracture in the torsion test is required to be characterized, it should be done on the basis of Annex B.

NOTE 1 Round wire is used to demonstrate the evaluation of fracture type in Annex B, but it applies to both round and shaped wires.

NOTE 2 For wires of smaller diameter or characteristic dimension, it may not be possible to make a distinction between some of the classes in Annex B (e.g. 2b versus 3b).

8 Test report

The test report shall include the following information:

- a) reference to this International Standard;
- b) identification of the test piece (type of the material, heat number, etc.);
- c) diameter, d , or characteristic dimension, h , of the test piece;
- d) details regarding the test piece preparation (method of straightening, etc.);
- e) testing conditions (free length between the grips, testing speed, application of tensile stress, etc.);
- f) number of turns.

The test report may include an evaluation of the fracture.

Annex A
 (informative)









**Recommended types of jaws depending on the diameter d or
 characteristic dimension h of the wire**

d (h) mm	Type of jaws
$0,1 \leq d$ (h) $< 0,3$	Smooth
$0,3 \leq d$ (h) ≤ 3	Lightly serrated
$3 < d$ (h) ≤ 10	V-grooved
$10 < d$ (h) ≤ 14	Smooth ^a or other types of jaws

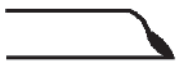
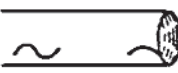
^a Only for steel wires.

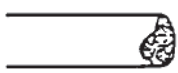
Annex B (informative)

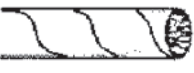
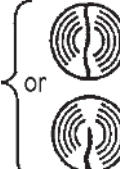
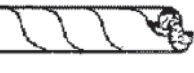
Evaluation of fractures occurring during simple torsion test

Type of fracture	Type no.	Aspect	Description and characteristics	Fracture plane
Normal torsion fracture	1a		<p>Smooth: - fracture plane perpendicular to wire axis (or slightly oblique). - no cracks in fracture plane.</p> <p>Brittle: - fracture plane at an angle of 45° to wire axis. - no cracks in fracture plane.</p>	
	1b			
Fracture with local cracks or Irregular fracture (material defects)	2a		<p>Smooth: - fracture plane perpendicular to wire axis and partially cracked.</p> <p>Stepped: - a part of the fracture plane is still smooth partially cracked.</p>	
	2b			
	2c		<p>Irregular fracture plane: - no cracks in fracture plane.</p>	
Fracture with spiral cracks over the whole length (or large part of it) Crack formation already occurs after a low number (3 to 5) of torsions and is best visible at that moment	3a		<p>Smooth: - fracture plane perpendicular to wire axis and partially or entirely cracked.</p> <p>Stepped: - a part of the fracture plane is still smooth and partially or entirely cracked.</p>	
	3b			
	3c	 	<p>Brittle: - fracture plane at an angle of 45° and partially or entirely cracked</p> <p>or</p> <p>Irregular fracture plane: - partially or entirely cracked</p>	

British Standards Institution (BSI)

BSI is the national body responsible for preparing British Standards and other standards-related publications, information and services.

BSI is incorporated by Royal Charter. British Standards and other standardization products are published by BSI Standards Limited.

About us

We bring together business, industry, government, consumers, innovators and others to shape their combined experience and expertise into standards-based solutions.

The knowledge embodied in our standards has been carefully assembled in a dependable format and refined through our open consultation process. Organizations of all sizes and across all sectors choose standards to help them achieve their goals.

Information on standards

We can provide you with the knowledge that your organization needs to succeed. Find out more about British Standards by visiting our website at bsigroup.com/standards or contacting our Customer Services team or Knowledge Centre.

Buying standards

You can buy and download PDF versions of BSI publications, including British and adopted European and international standards, through our website at bsigroup.com/shop, where hard copies can also be purchased.

If you need international and foreign standards from other Standards Development Organizations, hard copies can be ordered from our Customer Services team.

Subscriptions

Our range of subscription services are designed to make using standards easier for you. For further information on our subscription products go to bsigroup.com/subscriptions.

With **British Standards Online (BSOL)** you'll have instant access to over 55,000 British and adopted European and international standards from your desktop. It's available 24/7 and is refreshed daily so you'll always be up to date.

You can keep in touch with standards developments and receive substantial discounts on the purchase price of standards, both in single copy and subscription format, by becoming a **BSI Subscribing Member**.

PLUS is an updating service exclusive to BSI Subscribing Members. You will automatically receive the latest hard copy of your standards when they're revised or replaced.

To find out more about becoming a BSI Subscribing Member and the benefits of membership, please visit bsigroup.com/shop.

With a **Multi-User Network Licence (MUNL)** you are able to host standards publications on your intranet. Licences can cover as few or as many users as you wish. With updates supplied as soon as they're available, you can be sure your documentation is current. For further information, email bsmusales@bsigroup.com.

BSI Group Headquarters

389 Chiswick High Road London W4 4AL UK

Revisions

Our British Standards and other publications are updated by amendment or revision.

We continually improve the quality of our products and services to benefit your business. If you find an inaccuracy or ambiguity within a British Standard or other BSI publication please inform the Knowledge Centre.

Copyright

All the data, software and documentation set out in all British Standards and other BSI publications are the property of and copyrighted by BSI, or some person or entity that owns copyright in the information used (such as the international standardization bodies) and has formally licensed such information to BSI for commercial publication and use. Except as permitted under the Copyright, Designs and Patents Act 1988 no extract may be reproduced, stored in a retrieval system or transmitted in any form or by any means – electronic, photocopying, recording or otherwise – without prior written permission from BSI. Details and advice can be obtained from the Copyright & Licensing Department.

Useful Contacts:

Customer Services

Tel: +44 845 086 9001

Email (orders): orders@bsigroup.com

Email (enquiries): cservices@bsigroup.com

Subscriptions

Tel: +44 845 086 9001

Email: subscriptions@bsigroup.com

Knowledge Centre

Tel: +44 20 8996 7004

Email: knowledgecentre@bsigroup.com

Copyright & Licensing

Tel: +44 20 8996 7070

Email: copyright@bsigroup.com



...making excellence a habit.™