

BS ISO 6344-3:2013



BSI Standards Publication

## Coated abrasives — Grain size analysis

Part 3: Determination of grain size distribution of microgrits P240 to P2500

**bsi.**

...making excellence a habit.™

**National foreword**

This British Standard is the UK implementation of ISO 6344-3:2013. It supersedes BS ISO 6344-3:1998 which is withdrawn.

The UK participation in its preparation was entrusted to Technical Committee MTE/13, Grinding wheels, abrasive tools, paper and cloths, and powders.

A list of organizations represented on this committee can be obtained on request to its secretary.

This publication does not purport to include all the necessary provisions of a contract. Users are responsible for its correct application.

© The British Standards Institution 2013. Published by BSI Standards Limited 2013

ISBN 978 0 580 70616 5

ICS 25.100.70

**Compliance with a British Standard cannot confer immunity from legal obligations.**

This British Standard was published under the authority of the Standards Policy and Strategy Committee on 31 May 2013.

**Amendments issued since publication**

Date	Text affected
------	---------------

---

INTERNATIONAL  
STANDARD

**ISO**  
**6344-3**

Second edition  
2013-05-01

---

---

**Coated abrasives — Grain size  
analysis —**

Part 3:

**Determination of grain size distribution  
of microgrits P240 to P2500**

*Abrasifs appliqués — Granulométrie —*

*Partie 3: Détermination de la distribution granulométrique des  
micrograins P240 à P2500*



Reference number  
ISO 6344-3:2013(E)

© ISO 2013



**COPYRIGHT PROTECTED DOCUMENT**

© ISO 2013

All rights reserved. Unless otherwise specified, no part of this publication may be reproduced or utilized otherwise in any form or by any means, electronic or mechanical, including photocopying, or posting on the internet or an intranet, without prior written permission. Permission can be requested from either ISO at the address below or ISO's member body in the country of the requester.

ISO copyright office  
Case postale 56 • CH-1211 Geneva 20  
Tel. + 41 22 749 01 11  
Fax + 41 22 749 09 47  
E-mail [copyright@iso.org](mailto:copyright@iso.org)  
Web [www.iso.org](http://www.iso.org)

Published in Switzerland

# Contents

	Page
Foreword .....	iv
<b>1 Scope .....</b>	<b>1</b>
<b>2 Normative references .....</b>	<b>1</b>
<b>3 Terms and definitions .....</b>	<b>1</b>
<b>4 Testing of microgrits P240 to P1200 .....</b>	<b>1</b>
4.1 General .....	1
4.2 Designation of the test method .....	2
4.3 Test procedure using the US sedimentation tube .....	2
<b>5 Testing of microgrits P1500 to P2500 .....</b>	<b>17</b>
5.1 General .....	17
5.2 Designation of the test method .....	18
5.3 Test procedure .....	18
<b>6 Designation .....</b>	<b>20</b>
<b>7 Marking .....</b>	<b>20</b>
<b>Annex A (informative) Form for recording results of a sedimentation analysis of microgrits of the P series using the US sedimentometer .....</b>	<b>21</b>
<b>Annex B (informative) Example of the presentation of the test data for the grain size distribution of fused aluminium oxide .....</b>	<b>23</b>
<b>Bibliography .....</b>	<b>25</b>

## Foreword

ISO (the International Organization for Standardization) is a worldwide federation of national standards bodies (ISO member bodies). The work of preparing International Standards is normally carried out through ISO technical committees. Each member body interested in a subject for which a technical committee has been established has the right to be represented on that committee. International organizations, governmental and non-governmental, in liaison with ISO, also take part in the work. ISO collaborates closely with the International Electrotechnical Commission (IEC) on all matters of electrotechnical standardization.

International Standards are drafted in accordance with the rules given in the ISO/IEC Directives, Part 2.

The main task of technical committees is to prepare International Standards. Draft International Standards adopted by the technical committees are circulated to the member bodies for voting. Publication as an International Standard requires approval by at least 75 % of the member bodies casting a vote.

Attention is drawn to the possibility that some of the elements of this document may be the subject of patent rights. ISO shall not be held responsible for identifying any or all such patent rights.

ISO 6344-3 was prepared by Technical Committee ISO/TC 29, *Small tools*, Subcommittee SC 5, *Grinding wheels and abrasives*.

This second edition cancels and replaces the first edition (ISO 6344-3:1998). It also incorporates the Technical Corrigendum ISO 6344-3:1998/Corr.1:1999. The significant changes against ISO 6344-3:1998 are the following:

- a) new definitions have been included in [Clause 3](#);
- b) the test procedure in [4.3](#) has been completely updated; requirements for the use of the US sedimentation tube have replaced the reference to ISO 8486-2, in order to facilitate the use of this part of ISO 6344;
- c) Bibliography has been added.

ISO 6344 consists of the following parts, under the general title *Coated abrasives — Grain size analysis*:

- *Part 1: Grain size distribution test*
- *Part 2: Determination of grain size distribution of macrogrits P12 to P220*
- *Part 3: Determination of grain size distribution of microgrits P240 to P2500*

# Coated abrasives — Grain size analysis —

## Part 3:

# Determination of grain size distribution of microgrits P240 to P2500

## 1 Scope

This part of ISO 6344 specifies a method for determining or testing the grain size distribution of electro-fused aluminium oxide and silicon carbide microgrits P240 to P2500 for coated abrasives as defined in ISO 6344-1.

It applies both to those grits used in the manufacture of coated abrasive products and to those grits taken from products for testing purposes.

## 2 Normative references

The following documents, in whole or in part, are normatively referenced in this document and are indispensable for its application. For dated references, only the edition cited applies. For undated references, the latest edition of the referenced document (including any amendments) applies.

ISO 6344-1:1998, *Coated abrasives — Grain size analysis — Part 1: Grain size distribution test*

## 3 Terms and definitions

For the purposes of this document, the following terms and definitions apply.

### 3.1

#### **microgrit**

abrasive grit having a median equivalent diameter of 58,5  $\mu\text{m}$  to 8,4  $\mu\text{m}$ , whose grain size distribution is determined by sedimentation

### 3.2

#### **grain size distribution**

percentage of grains of different sizes composing the macrogrit or microgrit

## 4 Testing of microgrits P240 to P1200

### 4.1 General

The testing of microgrits P240 to P1200 by sedimentation shall be carried out using the US sedimentometer whereby the grain size distribution is determined; see [4.3.1](#).

The limits are specified in ISO 6344-1:1998, Table 2, which is reproduced as (the following) [Table 1](#).

**Table 1 — Grain size distribution of microgrits P240 to P1200  $d_s$ -values for testing with the US sedimentometer**

Grit designation	$d_{s0}$ value	$d_{s3}$ value	Median grain size		$d_{s95}$ value
	max. $\mu\text{m}$	max. $\mu\text{m}$	$d_{s50}$ values $\mu\text{m}$		min. $\mu\text{m}$
P240	110	81,7	58,5	$\pm 2,0$	44,5
P280	101	74,0	52,2	$\pm 2,0$	39,2
P320	94	66,8	46,2	$\pm 1,5$	34,2
P360	87	60,3	40,5	$\pm 1,5$	29,6
P400	81	53,9	35,0	$\pm 1,5$	25,2
P500	77	48,3	30,2	$\pm 1,5$	21,5
P600	72	43,0	25,8	$\pm 1,0$	18,0
P800	67	38,1	21,8	$\pm 1,0$	15,1
P1000	63	33,7	18,3	$\pm 1,0$	12,4
P1200	58	29,7	15,3	$\pm 1,0$	10,2

The permissible deviations are given in [Table 2](#).

**Table 2 — Permissible deviations resulting from the variations due to the measuring technique (US sedimentometer)**

Grit designation	Permissible deviation for		
	$d_{s3}$ $\mu\text{m}$	$d_{s50}$ $\mu\text{m}$	$d_{s95}$ $\mu\text{m}$
P240	+1,5	$\pm 1,5$	-1,5
P280			
P320			
P360	+1,5	$\pm 1,0$	-1,5
P400			
P500			
P600	+1,5	$\pm 0,8$	-1,5
P800			
P1000			
P1200			

## 4.2 Designation of the test method

The designation of the test method by means of the US sedimentometer for microgrits P240 to P1200 is as follows: **Test method – Micro P**

## 4.3 Test procedure using the US sedimentation tube

### 4.3.1 Testing by sedimentation

The testing of microgrits P240 to P1200 by sedimentation shall be carried out using the US sedimentation tube whereby the grain size distribution is determined.

The principle of measurement is to determine the volumes of a suspension of the grit sample settled in the collecting tube as a function of time, and to calculate the equivalent grain diameter using Stokes' law.



The grain size distribution of microgrits P240 to P1200 is determined using the following criteria:

- a) the maximum grains diameter (theoretical grain diameter) of the first sedimented grain ( $d_{s0}$  value) shall not exceed the maximum permissible  $d_{s0}$  value;
- b) the grain diameter (theoretical grain diameter) shall not exceed the maximum permissible  $d_{s3}$  value at the 3 % point of the grain size distribution curve;
- c) the median grain diameter (theoretical grain diameter) shall be within the specified tolerances of the  $d_{s50}$  value at the 50 % point of the grain size distribution curve;
- d) the grain diameter (theoretical grain diameter) shall at least attain the  $d_{s95}$  value at the 95 % point of the grain size distribution curve.

The four criteria shall be met at the same time. The values are specified in [Table 1](#).

The permissible deviations are given in [Table 2](#).

#### 4.3.2 Test apparatus

The US sedimentation tube consists of a vertical sedimentation tube of 940 mm in length and of 20 mm inside diameter. It is surrounded by a water jacket in which the water temperature is maintained at a constant level.

A graduated collecting tube is fixed at the bottom of the sedimentation tube. The whole assembly is mounted on a frame, the base plate of which is fitted with level adjusting screws for keeping the tube vertical (see [Figure 1](#)).

For the design and dimensions of the collecting tube, see [Figure 2](#).

To improve the accuracy of sedimentation volume readings, it is recommended that a horizontal beam light source and a magnifying glass be used. A time printer renders the recording of the sedimentation times easier.

Dimensions in millimetres

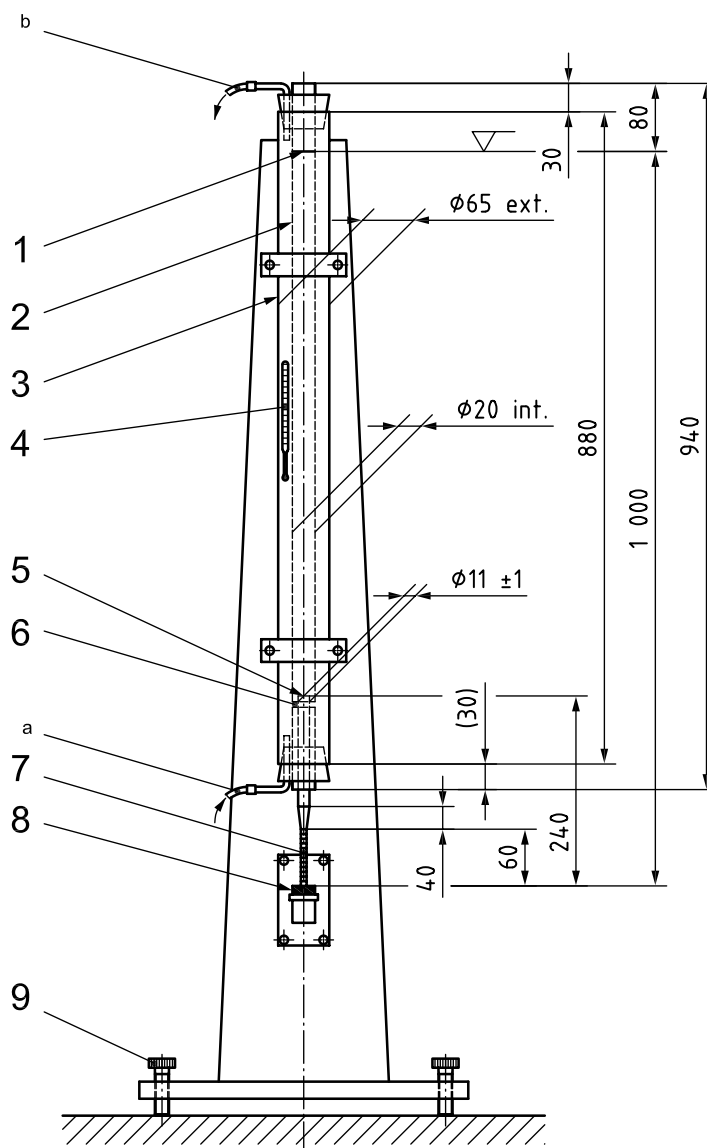

**Key**

- 1 methyl alcohol level (initial)
- 2 sedimentation tube
- 3 water jacket
- 4 thermometer
- 5 collecting tube (see [Figure 5](#))
- 6 rubber centring spacer
- 7 scale for height of sedimentation
- 8 rubber gasket
- 9 vertical adjusting screws
- a Water inlet.
- b Water outlet.

**Figure 1 — US sedimentation tube**

Dimensions in millimetres

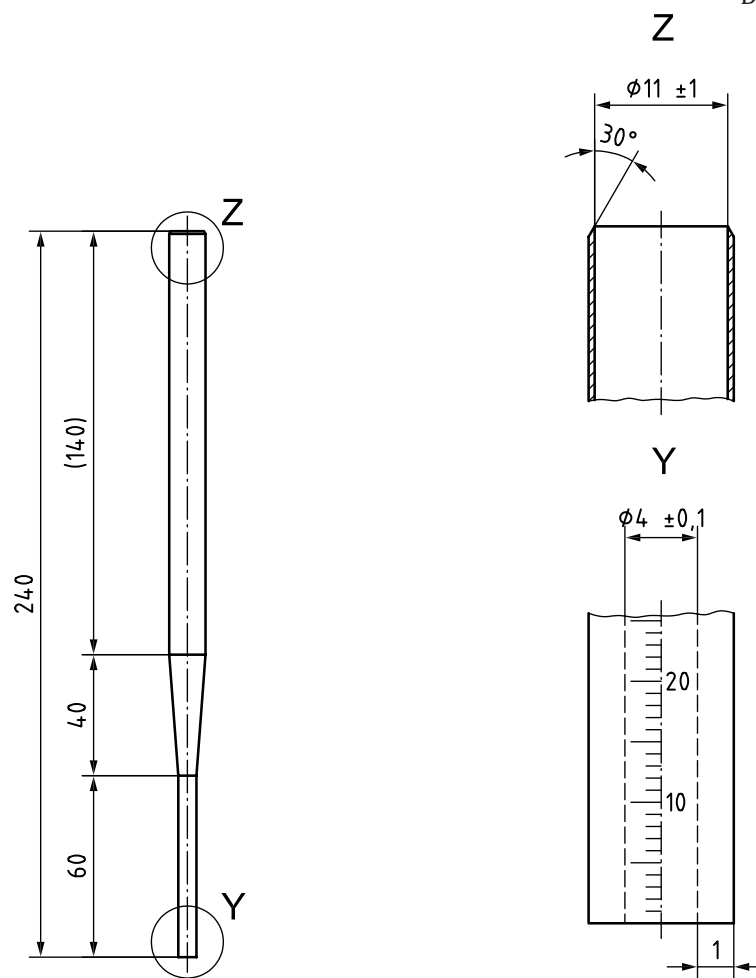

**Key**

Dial graduation and figures shall be in white.

50 division marks at equal intervals (graduation about 1 mm).

Length of division mark: 3 mm

Every fifth division mark: 4 mm

Thickness of division mark: 0,25 mm

**Figure 2 — Collecting tube**

**4.3.3 Test equipment**

**4.3.3.1 Sedimentation medium**

Use methyl alcohol of 95 % up to 99 % purity as the sedimentation medium.

Adjust the sedimentation medium using the checking minerals specified in [4.3.4.1.3](#).

**4.3.3.2 Dispersing agent**

In order to avoid grain agglomeration, a dispersing agent, such as EDTA (tetrasodium salt of ethylenediamine tetra-acetic acid), shall be added to the methyl alcohol, i.e. 4 ml of a 1 % aqueous EDTA-solution per litre of methyl alcohol.

### 4.3.3.3 Checking minerals

The adjustment of the whole measuring procedure should be controlled by means of checking minerals 280 and 320. Each supply of checking minerals is accompanied by a cumulative volume grain size distribution curve (see [Figure 3](#)). The 10 %, 20 %, 30 %, 40 % and 50 % points shall not deviate by more than  $\pm 0,5$  micrometres ( $\mu\text{m}$ ) from the sizes indicated in [Table 3](#).

NOTE The grain size distributions of the checking minerals do not correspond to identical grain sizes of this part of ISO 6344.

**Table 3 — Grain diameter of checking minerals**

Volume fraction of the settled checking minerals %	Grain diameter $d$ $\mu\text{m}$ Checking mineral	
	280	320
0	74,7	75,1
3	62,1	58,7
10	$52,9 \pm 1,06$	$49,8 \pm 1$
20	$47,9 \pm 0,96$	$44,2 \pm 0,88$
30	$44,7 \pm 0,89$	$40,5 \pm 0,81$
40	$42 \pm 0,84$	$37,5 \pm 0,75$
50	$39,7 \pm 0,79$	$34,9 \pm 0,7$
60	37,4	32,5
70	35	30,1
80	32,3	27,5
90	28,8	24,4
100	20	16,5

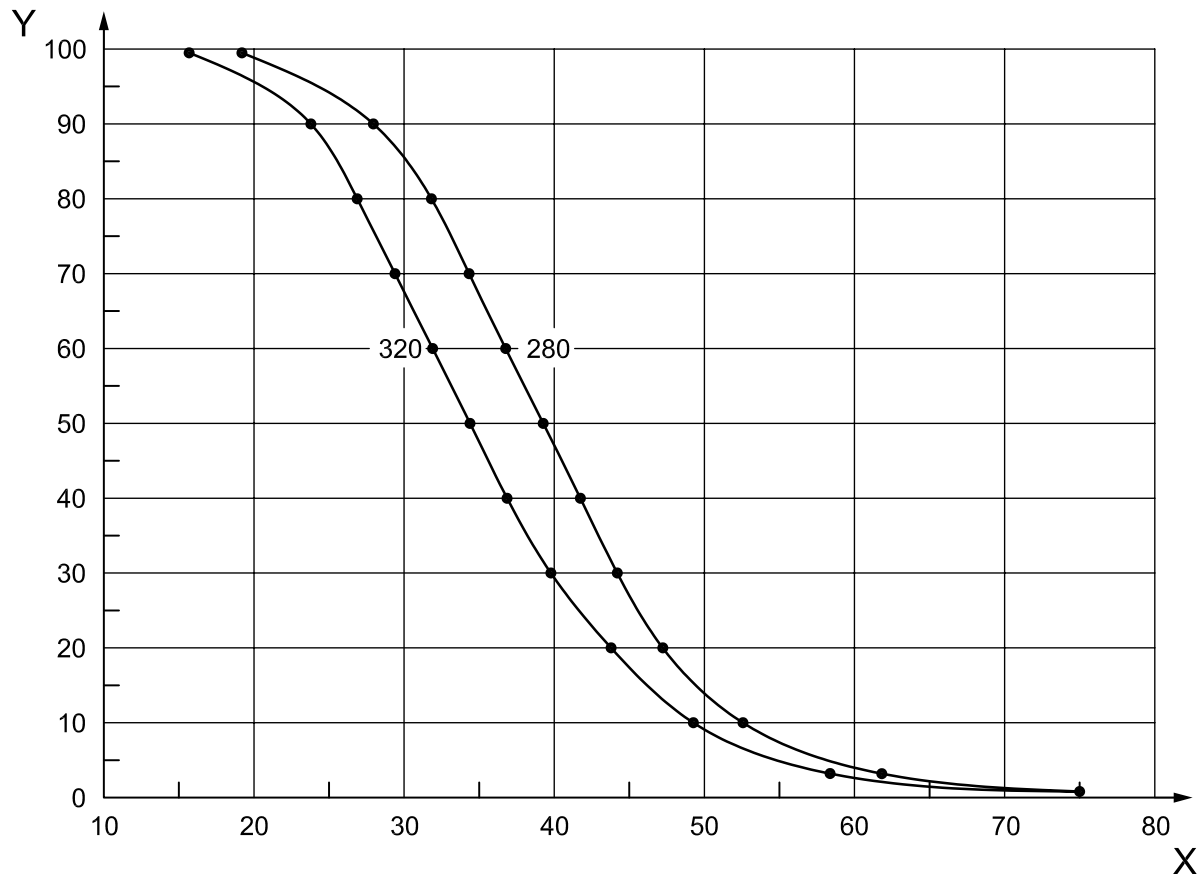

**Key**

Y volume fraction, %  
 X grain diameter,  $d$ ,  $\mu\text{m}$

**Figure 3 — Cumulative volume grain size distribution curve of checking minerals 280 and 320**

**4.3.4 Testing**

**4.3.4.1 Preparation for testing**

**4.3.4.1.1 Setting up test device**

When setting up the US sedimentometer for use as the test device, check that the collecting tube is positioned centrally in the sedimentation tube. It is held in the vertical position by a rubber spacer located about 30 mm from the top of the collecting tube. Check this using a plumb line suspended from the top of the sedimentation tube and the collecting tube. The plumb line shall pass centrally through both the sedimentation tube and the collecting tube. The device is adjusted by means of the adjusting screws on the base plate.

After adjustment, fill the water jacket and connect it to a thermostat.

**4.3.4.1.2 Test temperature**

The testing of the grain size shall be carried out under constant temperature with a permissible deviation of  $\pm 0,1$  °C.

It is convenient to use a test temperature of 25 °C. The grain diameters indicated in [Tables 4](#) and [5](#) for the respective times of sedimentation apply to this temperature only.

For the determination of the grain diameters for other test temperatures, see [4.3.5.1](#).

#### **4.3.4.1.3 Adjustment of the sedimentation medium**

The methyl alcohol used for the test shall be adjusted by means of one of the two checking minerals, 280 or 320.

The grain sizes corresponding to 10 %, 20 %, 30 %, 40 % and 50 % points shall not deviate by more than  $\pm 0,5 \mu\text{m}$  from the values specified on the curves supplied with the checking minerals. The average of the algebraic sum of the deviations shall not exceed  $\pm 0,3 \mu\text{m}$ .

If agreement with the accompanying curves is not reached within the permissible tolerances, then the density and viscosity of the sedimentation medium shall be changed in such a way so that agreement is obtained.

#### **4.3.4.2 Test procedure**

##### **4.3.4.2.1 Filling of sedimentation tube**

Fill the sedimentation tube with the previously adjusted sedimentation liquid to a height of  $1\ 000 \text{ mm} \pm 2 \text{ mm}$  (measured from the bottom of the collecting tube). Then, allow it to stand until equilibrium is reached between the water jacket connected to the thermostat and the sedimentation tube temperatures.

##### **4.3.4.2.2 Preparation of the sample**

Prior to the test, the sample shall be heated to a temperature of  $600 \text{ }^\circ\text{C} \pm 20 \text{ }^\circ\text{C}$  for at least 10 min.

##### **4.3.4.2.3 Dispersion of the sample**

Place a sufficient amount of the sample in a test tube such that a height of 20 to 25 divisions in the collecting tube after sedimentation is obtained. For silicon carbide, this will be about 1,6 g; while for fused aluminium oxide it will be about 2,2 g.

It is recommended that the dispersed sample be submitted to ultrasonic treatment to remove agglomerates.

Transfer 15 ml of sedimentation medium containing the specified quantity of dispersing agent and the sample to be settled to a test tube and shake the test tube to achieve complete dispersion. Allow the grit to stand in the sedimentation medium for at least 30 min and then again shake the test tube vigorously several times during this period. The temperature of the medium shall be the same as the temperature of the medium in the sedimentation tube.

##### **4.3.4.2.4 Transfer to sedimentation tube**

Place a suitable funnel in the sedimentation tube. Shake the test-tube containing the sample and the sedimentation liquid vigorously for at least 30 s. Then, pour its contents onto the sedimentation liquid, down the slope of the funnel.

Subsequently, quickly remove the funnel from the sedimentation tube in order to prevent any residue from dropping into the tube as this would distort the results.

##### **4.3.4.2.5 Start of measurement**

Measurement shall begin at the time of transfer.

**Table 4 — Theoretical grain diameter,  $d$ , for grits of fused aluminium oxide as a function of time of sedimentation,  $t$ , when using methyl alcohol as sedimentation medium at test temperature 25 °C**

$t$	$d$	$t$	$d$	$T$	$d$	$t$	$d$	$t$	$d$
min	µm	min	µm	min	µm	min	µm	min	µm
0,50	112,7	2,50	50,4	4,50	37,6	8,00	28,2	23,00	16,6
0,55	107,5	2,55	49,9	4,55	37,4	8,20	27,8	24,00	16,3
0,60	102,9	2,60	49,4	4,60	37,2	8,40	27,5	25,00	15,9
0,65	98,9	2,65	49	4,65	37	8,60	27,2	26,00	15,6
0,70	95,3	2,70	48,5	4,70	36,8	8,80	26,9	27,00	15,3
0,75	92	2,75	48,1	4,75	36,6	9,00	26,6	28,00	15,1
0,80	89,1	2,80	47,6	4,80	36,4	9,20	26,3	29,00	14,8
0,85	86,4	2,85	47,2	4,85	36,2	9,40	26	30,00	14,6
0,90	84	2,90	46,8	4,90	36	9,60	25,7	32,00	14,1
0,95	81,8	2,95	46,4	4,95	35,8	9,80	25,5	34,00	13,7
1,00	79,7	3,00	46	5,00	35,6	10,00	25,2	36,00	13,3
1,05	77,8	3,05	45,6	5,10	35,3	10,20	25	38,00	12,9
1,10	76	3,10	45,3	5,20	35	10,40	24,7	40,00	12,6
1,15	74,3	3,15	44,9	5,30	34,6	10,60	24,5	42,00	12,3
1,20	72,8	3,20	44,6	5,40	34,3	10,80	24,2	44,00	12
1,25	71,3	3,25	44,2	5,50	34	11,00	24	46,00	11,8
1,30	69,9	3,30	43,9	5,60	33,7	11,20	23,8	48,00	11,5
1,35	68,6	3,35	43,5	5,70	33,4	11,40	23,6	50,00	11,3
1,40	67,4	3,40	43,2	5,80	33,1	11,60	23,4	55,00	10,8
1,45	66,2	3,45	42,9	5,90	32,8	11,80	23,2	60,00	10,3
1,50	65,1	3,50	42,6	6,00	32,5	12,00	23	65,00	9,9
1,55	64	3,55	42,3	6,10	32,3	12,50	22,5	70,00	9,5
1,60	63	3,60	42	6,20	32	13,00	22,1	75,00	9,2
1,65	62,9	3,65	41,7	6,30	31,8	13,50	21,7	80,00	8,9
1,70	61,1	3,70	41,4	6,40	31,5	14,00	21,3	85,00	8,6
1,75	60,2	3,75	41,2	6,50	31,3	14,50	20,9	90,00	8,4
1,80	59,4	3,80	40,9	6,60	31	15,00	20,6	95,00	8,2
1,85	58,6	3,85	40,6	6,70	30,8	15,50	20,2	100,00	8
1,90	57,8	3,90	40,4	6,80	30,6	16,00	19,9	105,00	7,8
1,95	57,1	3,95	40,1	6,90	30,3	16,50	19,6	110,00	7,6
2,00	56,4	4,00	39,9	7,00	30,1	17,00	19,3	115,00	7,4
2,05	55,7	4,05	39,6	7,10	29,9	17,50	19,1	120,00	7,3
2,10	55	4,10	39,4	7,20	29,7	18,00	18,8	130,00	7
2,15	54,4	4,15	39,1	7,30	29,5	18,50	18,5	140,00	6,7
2,20	53,7	4,20	38,9	7,40	29,3	19,00	18,3	150,00	6,5
2,25	60,1	4,25	38,7	7,50	29,1	19,50	18	160,00	6,3
2,30	52,6	4,30	38,4	7,60	28,9	20,00	17,8	170,00	6,1
2,35	52	4,35	38,2	7,70	28,7	20,50	17,6	180,00	5,9
2,40	51,4	4,40	38	7,80	28,5	21,00	17,4	190,00	5,8
2,45	50,9	4,45	37,8	7,90	28,4	22,00	17	200,00	5,6

**Table 5 — Theoretical grain diameter,  $d$ , for grits of silicon carbide as a function of time of sedimentation,  $t$ , when using methyl alcohol as sedimentation medium at test temperature 25 °C**

$t$	$d$		$t$	$d$		$t$	$d$		$t$	$d$		$t$	$d$
min	µm		min	µm		min	µm		min	µm		min	µm
0,50	128,8		2,50	57,6		4,50	42,9		8,00	32,2		23,00	19
0,55	122,8		2,55	57		4,55	42,7		8,20	31,8		24,00	18,6
0,60	117,6		2,60	56,5		4,60	42,5		8,40	31,4		25,00	18,2
0,65	112,9		2,65	56		4,65	42,2		8,60	31,1		26,00	17,9
0,70	108,8		2,70	55,4		4,70	42		8,80	30,7		27,00	17,5
0,75	105,1		2,75	54,9		4,75	41,8		9,00	30,4		28,00	17,2
0,80	101,8		2,80	54,4		4,80	41,6		9,20	30		29,00	16,9
0,85	98,8		2,85	54		4,85	41,4		9,40	29,7		30,00	16,6
0,90	96		2,90	53,5		4,90	41,2		9,60	29,4		32,00	16,1
0,95	93,4		2,95	53		4,95	40,9		9,80	29,1		34,00	15,6
1,00	91,1		3,00	52,6		5,00	40,7		10,00	28,8		36,00	15,2
1,05	88,9		3,05	52,2		5,10	40,3		10,20	28,5		38,00	14,8
1,10	86,9		3,10	51,7		5,20	40		10,40	28,2		40,00	14,4
1,15	85		3,15	51,3		5,30	39,6		10,60	28		42,00	14
1,20	83,2		3,20	50,9		5,40	39,2		10,80	27,7		44,00	13,7
1,25	81,5		3,25	50,5		5,50	38,8		11,00	27,5		46,00	13,4
1,30	79,9		3,30	50,2		5,60	38,5		11,20	27,2		48,00	13,1
1,35	78,4		3,35	49,8		5,70	38,2		11,40	27		50,00	12,9
1,40	77		3,40	49,4		5,80	37,8		11,60	26,7		55,00	12,3
1,45	75,7		3,45	49		5,90	37,5		11,80	26,5		60,00	11,8
1,50	74,4		3,50	48,7		6,00	37,2		12,00	26,3		65,00	11,3
1,55	73,2		3,55	48,4		6,10	36,9		12,50	25,8		70,00	10,9
1,60	72		3,60	48		6,20	36,6		13,00	25,3		75,00	10,5
1,65	70,9		3,65	47,7		6,30	36,3		13,50	24,8		80,00	10,2
1,70	69,9		3,70	47,4		6,40	36		14,00	24,3		85,00	9,9
1,75	68,9		3,75	47		6,50	35,7		14,50	23,9		90,00	9,6
1,80	67,9		3,80	46,7		6,60	35,5		15,00	23,5		95,00	9,4
1,85	67		3,85	46,4		6,70	35,2		15,50	23,1		100,00	9,1
1,90	66,1		3,90	46,1		6,80	34,9		16,00	22,8		105,00	8,9
1,95	65,2		3,95	45,8		6,90	34,7		16,50	22,4		110,00	8,7
2,00	64,4		4,00	45,6		7,00	34,4		17,00	22,1		115,00	8,5
2,05	63,6		4,05	45,3		7,10	34,2		17,50	21,8		120,00	8,3
2,10	62,9		4,10	45		7,20	34		18,00	21,5		130,00	8
2,15	62,1		4,15	44,7		7,30	33,7		18,50	21,2		140,00	7,7
2,20	61,4		4,20	44,5		7,40	33,5		19,00	20,9		150,00	7,4
2,25	60,7		4,25	44,2		7,50	33,3		19,50	20,6		160,00	7,2
2,30	60,1		4,30	43,9		7,60	33		20,00	20,4		170,00	7
2,35	59,4		4,35	43,7		7,70	32,8		20,50	20,1		180,00	6,8
2,40	58,8		4,40	43,4		7,80	32,6		21,00	19,9		190,00	6,6
2,45	58,2		4,45	43,2		7,90	32,4		22,00	19,4		200,00	6,4



#### 4.3.4.2.6 Determination of the maximum grain size

For the determination of the maximum grain size, the period of time is measured between the transfer of sample to the tube (start of measurement) and the moment when the first grain reaches the bottom of the collecting tube.

The grain size of fused aluminium oxide is determined according to [Table 4](#) and the grain size for silicon carbide according to [Table 5](#).

The diameter of the “first grain” is called  $d_{s0}$  value.

If the permissible  $d_{s0}$  value is exceeded, the test shall be repeated with one or more new samples. Check for agglomeration.

#### 4.3.4.2.7 Recording measurement values

The initial point of the grain size distribution curve is the time when the first continuous flow of particles reaches the bottom of the collecting tube. Check for agglomeration.

Observe the falling particles and record, successively, the times when the surfaces of the settled grains reach a division line of the collecting tube (reading without parallax).

The end point of measurement is that time when all the particles have settled, i.e. when the height of sedimentation is no longer changing.

During sedimentation, the rubber gasket at the bottom of the collecting tube shall be tapped gently but continuously. This may be carried out by means of a tapper. It shall, however, not be tapped on the pressing lever supporting the tube or on the tube itself.

If agglomerations of abrasive grits can be observed during the sedimentation, this is a sign of insufficient pretreatment of the sample. In such cases, the analysis shall be repeated.

### 4.3.5 Evaluation

#### 4.3.5.1 Determination of grain diameter, $d$

The determination of the grain size distribution according to this test method is based on Stokes' law. Since all conditions, except the time of sedimentation, and the grain size are constant for a given microgrit, the Stokes' formula can be simplified as follows:

$$d = \frac{K}{\sqrt{t}}$$

where

$d$  is the equivalent grain diameter, in micrometres;

$K$  is the constant whose value is dependent upon temperature, material to be tested and sedimentation medium;

$t$  is the time of sedimentation, in minutes.

When the test temperature is 25 °C, the  $K$  values for methyl alcohol are 79,7 for fused aluminium oxide and 91,1 for silicon carbide.

These values represent a basis for the determination of the equivalent grain diameters in [Tables 4](#) and [5](#). For other test temperatures, the grain diameters are also to be calculated according to Stokes' law.

The  $K$  values for the temperatures between 18 °C and 30 °C are given in [Table 6](#).

Table 6 — *K* values

Test temperature $\theta$ °C	<i>K</i> values	
	Fused aluminium oxide	Silicon carbide
18	84,3	96,3
19	83,7	95,5
20	83,0	94,8
21	82,3	94,1
22	81,7	93,3
23	81,0	92,6
24	80,4	91,8
25	79,7	91,1
26	79,1	90,3
27	78,4	89,6
28	77,8	88,9
29	77,1	88,1
30	76,5	87,4

The formulae for the determination of the *K* values as follows:

— for fused aluminium oxide:  $K = 96,16 - 0,657 \theta$

— for silicon carbide:  $K = 109,6 - 0,741 \theta$

where  $\theta$  is the temperature of medium in the sedimentation tube, in degrees Celsius.

NOTE Concerning the case of application described in this subclause, Stokes' Law states that grit reaching the bottom of the collecting tube (or the surface of the grits already settled at the bottom of the collecting tube) after a time, *t*, in minutes, has an equivalent diameter, *d*, in micrometres.

#### 4.3.5.2 Determination of the grain size

A form of the type given in [Annex A](#) may be used for the recording and interpretation of the data, showing:

- column 1: height of sedimentation, *h*, in division lines as marked on the collecting tube;
- column 2: time of sedimentation *t*;
- column 3: volume fraction of the settled sample determined according to [Table 7](#);
- column 4: grain diameter, *d*, for fused aluminium oxide determined according to [Table 4](#) and for silicon carbide according to [Table 5](#).

Table 7 — Volume fractions of settled sample as function of height of sedimentation, *h*, related to total height of sedimentation, *h*<sub>tot</sub>, of sample

Height of sedimentation <i>h</i> in division marks	Total height of sedimentation, <i>h</i> <sub>tot</sub> , of sample in division marks										
	20,0	20,5	21,0	21,5	22,0	22,5	23,0	23,5	24,0	24,5	25,0
	Volume fraction of settled sample (%)										
1	5,0	4,9	4,8	4,7	4,5	4,4	4,3	4,3	4,2	4,1	4,0
2	10,0	9,8	9,5	9,3	9,1	8,9	8,7	8,3	8,3	8,2	8,0
3	15,0	14,6	14,3	14,0	13,6	13,3	13,0	12,8	12,5	12,3	12,0

Table 7 (continued)

Height of sedimentation $h$ in division marks	Total height of sedimentation, $h_{\text{tot}}$ , of sample in division marks										
	20,0	20,5	21,0	21,5	22,0	22,5	23,0	23,5	24,0	24,5	25,0
	Volume fraction of settled sample (%)										
4	20,0	19,5	19,0	18,6	18,2	17,8	17,4	17,0	16,7	16,7	16,0
5	25,0	24,4	23,8	23,3	22,7	22,2	21,7	21,3	20,8	20,4	20,0
6	30,0	29,3	28,6	27,9	27,3	26,7	26,1	25,5	25,0	24,5	24,0
7	35,0	34,1	33,3	32,6	31,8	31,1	30,4	29,8	29,2	28,6	28,0
8	40,0	39,0	38,1	37,2	36,4	35,6	34,8	34,0	33,3	32,7	32,0
9	45,0	43,9	42,9	41,9	40,9	40,0	39,1	38,3	37,5	36,7	36,0
10	50,0	48,8	47,6	46,5	45,5	44,4	43,5	42,6	41,7	40,8	40,0
11	55,0	53,7	52,4	51,2	50,0	48,9	47,8	46,8	45,8	44,9	44,0
12	60,0	58,5	57,1	55,8	54,5	53,3	52,2	51,1	50,0	49,0	48,0
13	65,0	63,4	61,9	60,5	59,1	57,8	56,5	55,3	54,2	53,1	52,0
14	70,0	68,3	66,7	65,1	63,3	62,2	60,9	59,6	58,3	57,1	56,0
15	75,0	73,2	71,4	69,8	68,2	66,7	65,2	63,8	62,5	61,2	60,0
16	80,0	78,0	76,2	74,4	72,7	71,1	69,6	68,1	66,7	65,3	64,0
17	85,0	83,0	81,0	79,1	77,3	75,6	73,9	72,3	70,8	69,4	68,0
18	90,0	87,8	85,7	83,7	81,8	80,0	78,3	76,6	75,0	73,5	72,0
19	95,0	92,7	90,5	88,4	86,4	84,4	82,6	80,8	79,2	77,6	76,0
20	100,0	97,6	95,2	93,0	90,9	88,9	87,0	85,1	83,3	81,6	80,0
21	—	100,0	100,0	97,7	95,5	93,3	91,3	89,4	87,5	85,7	84,0
22	—	—	—	100,0	100,0	97,8	95,7	93,6	91,7	89,8	88,0
23	—	—	—	—	—	100,0	100,0	97,9	95,8	93,9	92,0
24	—	—	—	—	—	—	—	100,0	100,0	98,0	96,0
25	—	—	—	—	—	—	—	—	—	100,0	100,0

#### 4.3.5.3 Plotting the grain size distribution curve

In the grain size distribution curve, the volume fractions of the sedimented sample are plotted on the ordinate against the grain equivalent diameters,  $d$ , on the abscissa, determined according to 4.3.5.2 (see [Figures 4, 5 and 6](#)).

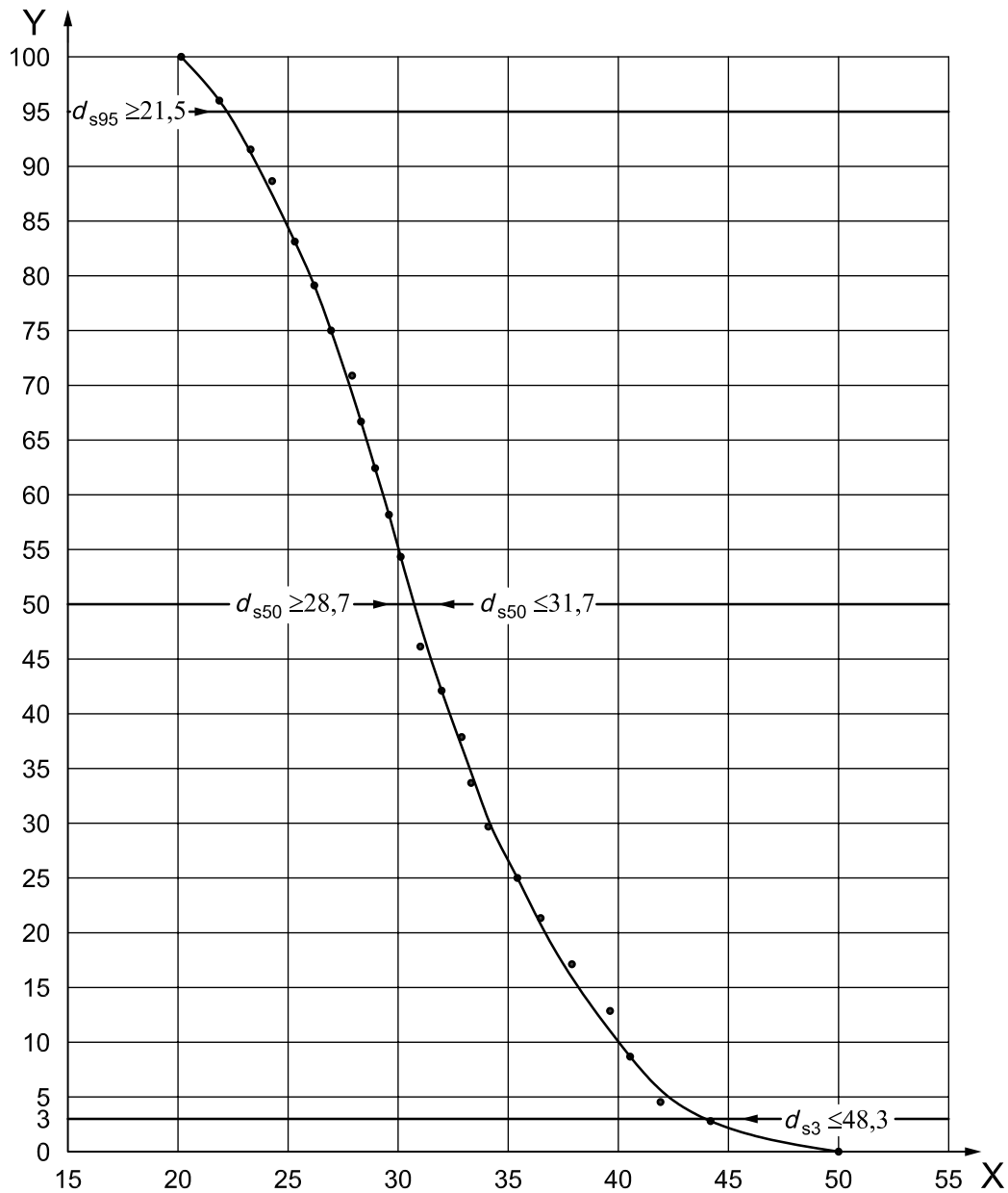

**Key**

X grain diameter,  $d$ ,  $\mu\text{m}$   
 Y settled volume fraction, %

Analysis readings:

$d_{s3}$  = 44  $\mu\text{m}$   
 $d_{s50}$  = 30,8  $\mu\text{m}$   
 $d_{s95}$  = 22  $\mu\text{m}$

**Figure 4 — Grain size distribution curve, represented on linear graph paper — Measuring values and permissible limiting values**

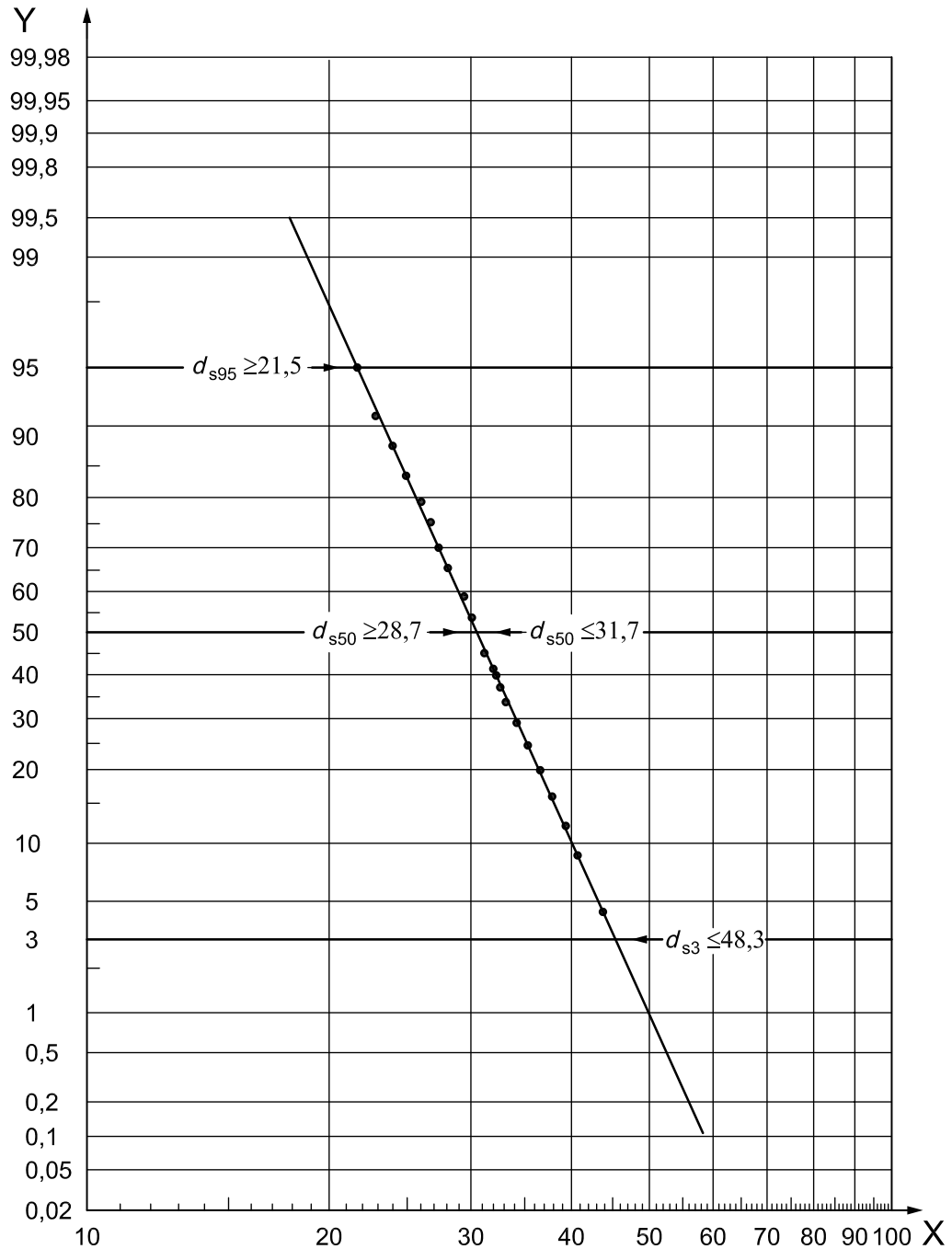

**Key**

X grain diameter,  $d$ ,  $\mu\text{m}$   
 Y settled volume fraction, %

Analysis readings:

$d_{s3}$  = 45,2  $\mu\text{m}$   
 $d_{s50}$  = 30,8  $\mu\text{m}$   
 $d_{s95}$  = 22  $\mu\text{m}$

**Figure 5 — Grain size distribution curve, represented on logarithmic probability graph paper (example as in Figure 4) — Measuring values and permissible limiting values (see also Figure 6)**

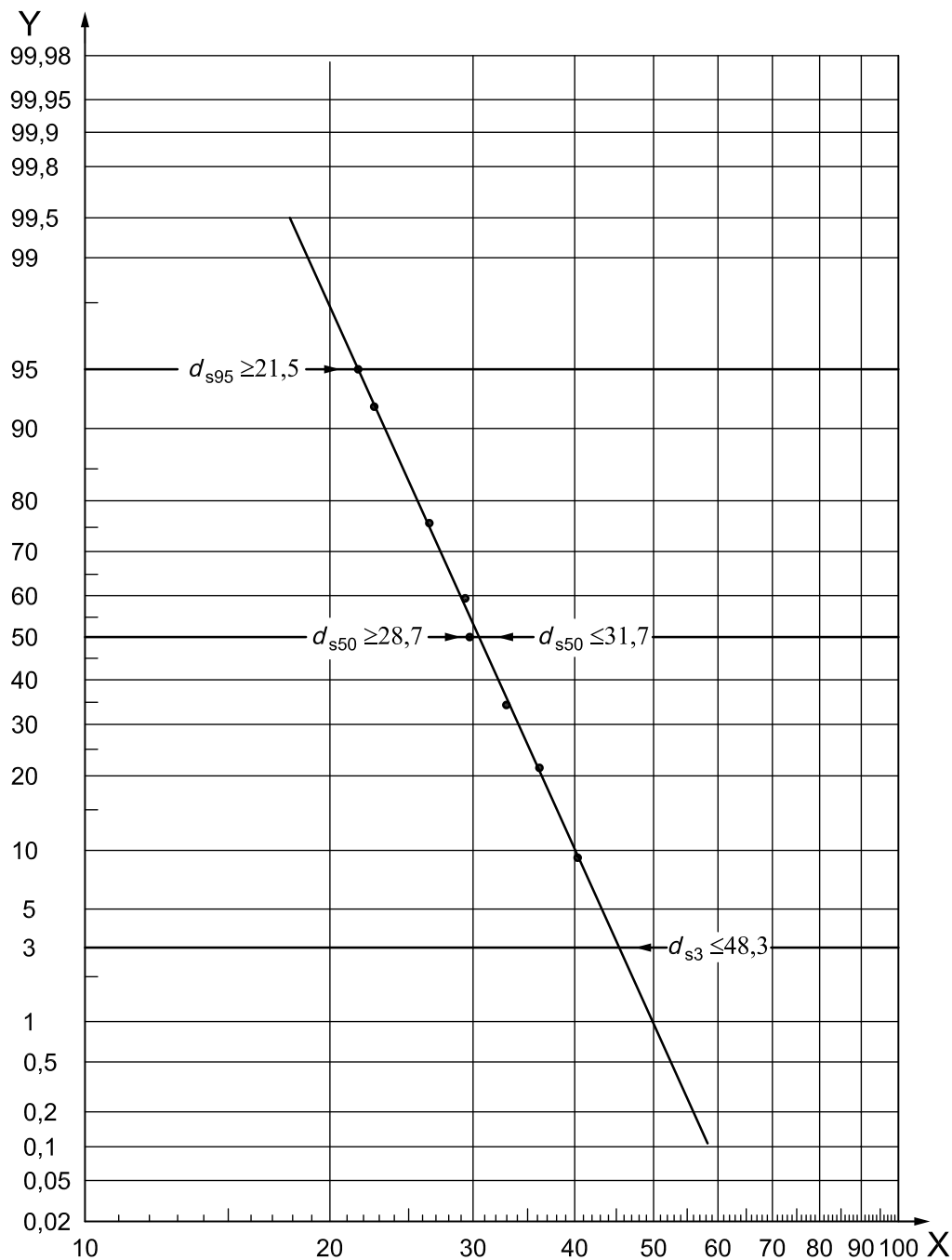

**Key**

X grain diameter,  $d$ ,  $\mu\text{m}$   
 Y settled volume fraction, %

Analysis readings:

$d_{s3}$  = 45,2  $\mu\text{m}$   
 $d_{s50}$  = 30,8  $\mu\text{m}$   
 $d_{s95}$  = 22  $\mu\text{m}$

**Figure 6 — Grain size distribution curve, represented on logarithmic probability graph paper (example as in Figure 4 but with reduced number of measuring points) — Measured values and deviations**

Millimetre graph paper may be used for the grain size distribution curve (see [Figure 4](#)). However, it is more helpful to use logarithmic probability graph paper (see [Figures 5](#) and [6](#)). With this type of graph paper, it is possible to interpret results from only a few measuring points (see [Figure 6](#)).

The volume fractions of the settled sample can be read off [Table 7](#) for the respective heights of sedimentation,  $h$ . If the height of sedimentation of the total sample,  $h_{\text{tot}}$ , is, for example, 24 division marks, then [Table 7](#) results in a volume fraction of the total sample of 45,8 % for a height of sedimentation of 11 division lines.

#### 4.3.5.4 Evaluation of the grain distribution curve

In the grain size distribution curve, the  $d_s$  values for 0 %, 3 %, 50 % and 95 % volume fractions of the sample are read and compared with the permissible values according to [Table 1](#).

The sample is in accordance with this part of ISO 6344 when the values for  $d_{s0}$ ,  $d_{s3}$ ,  $d_{s50}$  and  $d_{s95}$  are within the permissible limits.

When checking the measured results, allowance shall be made for variations due to the measuring technique. These permissible deviations, given in [Table 2](#), have been determined on the basis of the standard deviations resulting from a round robin test. The tolerances for production microgrits given in [Table 1](#) shall be increased by these values.

#### 4.3.5.5 Example of testing a sample of fused aluminium oxide

A grit made of fused aluminium oxide is tested in the sedimentation medium at a temperature of 25 °C.

The time is measured and recorded when the first continuous flow of particles reaches the bottom of the collecting tube.

After this, the times are recorded when the sedimentation heights,  $h$ , have reached one division mark each. At the end of the measurement, the total sedimentation height,  $h_{\text{tot}}$ , reaches 24 division marks. The established times are entered in column 2 of the form shown in [Annex A](#).

The volume fractions of the sample can only be determined after the termination of the measurement, when the total height of sedimentation,  $h_{\text{tot}}$ , is established. They are determined on the basis of [Table 7](#) and entered in the form shown in [Annex B](#).

For the times of sedimentation,  $t$ , given in column 2, the grain diameter,  $d$ , shall be determined from [Table 4](#) and entered in column 4 of the form shown in [Annex A](#).

For drawing up the grain size distribution curve, the volume fractions of the sample (column 3 of the form) are plotted against the corresponding grain size (column 4 of the form); see [Figures 4](#), [5](#) and [6](#).

[Figure 6](#) shows that when using the probability grid, a much lower number of points of measurement (6 points of measurement instead of 24 in [Figure 4](#)) can lead to a usable result. Only the points of measurement at the division lines 1, 2, 5, 10, 15 and 20 are entered. The established values shall be compared with the permissible deviations according to [Table 2](#).

## 5 Testing of microgrits P1500 to P2500

### 5.1 General

The testing of microgrits P1500 to P2500 by sedimentation is based on the micro-P-mastergrits P1500, P2000 and P2500 (of fused aluminium oxide).

The limits are specified in ISO 6344-1:1998, Table 3, which is reproduced as (the following) [Table 8](#).

**Table 8 — Grain size distribution of the microgrits P1500 to P2500**

Grit designation	$d_{s0}$ value <sup>a</sup> max.	$d_{s3}$ value max.	Median grain diameter $d_{s50}$ -value	$d_{s95}$ value min.
	µm	µm	µm	µm
<b>P1500</b>	58	25,8	12,6 ± 1,0	8,3
<b>P2000</b>	58	22,4	10,3 ± 0,8	6,7
<b>P2500</b>	58	19,3	8,4 ± 0,5	5,4

These values apply only to measurement by means of the US-sedimentometer according to [4.3](#).

<sup>a</sup> Determined on the basis of the standard deviations resulting from a round robin test.

## 5.2 Designation of the test method

The designation of the test method for microgrits P1500 to P2500 with indication of the measuring instrument used is for example:

**Test-Micro P – US sedimentometer**

or

**Test-Micro P – other methods**

## 5.3 Test procedure

### 5.3.1 General

The test method is based on the micro-P-mastergrits P1500, P2000 and P2500 (of fused aluminium oxide).

Each micro-P-mastergrit shall be accompanied by a certificate, for example from the Staatliche Materialprüfungsanstalt Darmstadt (MPA) indicating the  $d_{s0}$  and  $d_{s50}$  values determined by the US sedimentometer. The value measured shall be corrected on the basis of the mastergrit values.

The determination of grain sizes with measuring instruments other than the US sedimentometer, for example with the electrical resistance method (e.g. Coulter Multisizer III), with the different types of sedigraphs or with instruments using other principles of measurement may give deviating results.

The test shall be carried out in accordance with the instructions for the measuring instrument used.

### 5.3.2 Preparation of the sample

It is recommended that the sample be dispersed by means of ultrasonics for instance.

### 5.3.3 Determination of grain size distribution

The principle of this part of ISO 6344 upon which the evaluation of the test results obtained by sedimentation for the 3 %, 50 % and 95 % points is based, is the comparison of the median (50 %) size determined in a round robin test on the micro-P-mastergrits P1500, P2000 and P2500 of MPA Darmstadt with that determined by the testing laboratory on its own instruments.

The difference between these two values shall also be added algebraically to the 3 %, 50 % and 95 % values of the sample.

For the  $d_{s0}$  value calculate the difference between the measured values of the micro-P-mastergrit and the sample.



The following method applies.

- Determine the  $d_{s0}$  value of the micro-P-mastergrit and calculate the difference between this value and the corresponding value shown on the MPA Darmstadt certificate.
- Measure the  $d_{s0}$  value of the sample and add algebraically the mastergrit difference as determined above for the  $d_{s0}$ -value.
- Determine the  $d_{s50}$  value of the micro-P-mastergrit and calculate the difference between this value and the corresponding value shown on the MPA Darmstadt certificate.
- Measure the  $d_{s3}$ ,  $d_{s50}$ ,  $d_{s95}$  values of the sample and add, algebraically, the mastergrit difference as determined above for the  $d_{s50}$  value.
- The corrected measured results shall be compared with the values in [Table 8](#).

EXAMPLE SIC P2000, for  $d_{s50}$  value

Mastergrit (MG):

MG- $d_{s50}$ value according to MPA certificate	10,0 $\mu\text{m}$
MG value measured	9,5 $\mu\text{m}$
Difference	+0,5 $\mu\text{m}$
Sample	
$d_{s50}$ value measured	9,4 $\mu\text{m}$
To be added	+0,5 $\mu\text{m}$
Corrected $d_{s50}$ value of the sample	9,9 $\mu\text{m}$

According to [Table 8](#), this is within the tolerances of the  $d_{s50}$  value for grit P2000.

### 5.3.4 Evaluation of the test results

A sample complies with the standard, if the  $d_{s0}$ ,  $d_{s3}$ ,  $d_{s50}$  and  $d_{s95}$  values corrected, as described in [5.3.3](#), are within the permissible limits given in [Table 8](#).

When checking the measured results, allowance shall be made for the variations due to the measuring technique. These permissible deviations given in [Table 9](#) were determined on the basis of the standard deviations resulting from a round robin test. The tolerances for production microgrits given in [Table 8](#) shall be increased by these values. It is helpful if a form of the type shown in [Annex A](#) is used for the recording and interpretation of the data. An example of test results is given in [Annex B](#).

**Table 9 — Permissible deviations resulting from the variations due to the measuring technique**

Grit designation	Permissible deviations for values			
	$d_{s0}$ $\mu\text{m}$	$d_{s3}$ $\mu\text{m}$	$d_{s50}$ $\mu\text{m}$	$d_{s95}$ value $\mu\text{m}$
<b>P1500</b>	+5,0	+2,0	$\pm 1,0$	-0,5
<b>P2000</b>	+5,0	+1,5	$\pm 0,5$	-0,4
<b>P2500</b>	+5,0	+1,5	$\pm 0,5$	-0,4

## 6 Designation

The designation of microgrits for fused aluminium oxide or silicon carbide complying with the requirements of this part of ISO 6344 shall comprise:

- a) the type of abrasive;
- b) the designation of the grit, including the letter "P" for a coated abrasive, followed by a characteristic number representing the grit size.

EXAMPLE A microgrits designation is as follows:

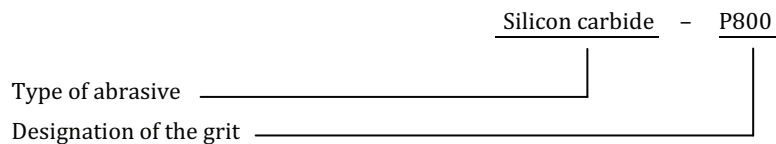

## 7 Marking

When packing grits of fused aluminium oxide and silicon carbide for coated abrasive products, the grit designation, i.e. P240, shall be marked on each of the smallest packing units.

## Annex A (informative)

### Form for recording results of a sedimentation analysis of microgrits of the P series using the US sedimentometer

Testing of microgrits P240 to P1200 – ISO 6344-3: .....

Abrasive:

Supplier or purchaser:

Grit designation: .....

Delivery date: .....

1	2	3	4	5
Height of sedimentation	Time of sedimentation	Volume fraction of the sample	Grain diameter	Remarks
<i>h</i>	<i>t</i>	%	<i>d</i>	
in division lines	min.		µm	
–		–		First grain ( $d_{50}$ )
0				First continuous flow of particles
1				
2				
3				
4				
5				
6				
7				
8				
9				
10				
11				
12				
13				
14				
15				
16				
17				
18				
19				
20				
21				
22				
23				

1	2	3	4	5
Height of sedimentation	Time of sedimentation	Volume fraction of the sample	Grain diameter	Remarks
<i>h</i>	<i>t</i>	%	<i>d</i>	
in division lines	min.		μm	
24				
25				

Date of testing: .....

Tested by: .....

## Annex B (informative)

### Example of the presentation of the test data for the grain size distribution of fused aluminium oxide

Testing of microgrits P240 to P1200 – ISO 6344-3: .....

Abrasive: Fused aluminium oxide

Supplier or purchaser: Braun

Grit designation: P500 .....

Delivery date: 2009-09-30 .....

1	2	3	4	5
Height of sedimentation	Time of sedimentation	Volume fraction of the sample	Grain diameter	Remarks
<i>h</i>	<i>t</i>	%	<i>d</i>	
in division lines	min.		µm	
–	1,10	–	76,0	First grain ( $d_{50}$ )
0	2,56	0	50	First continuous flow of particles
0,5	...	...	...	
1	3,28	4,2	44	
2	3,78	8,3	41	
3	4,03	12,5	39,7	
4	4,40	16,7	38	
5	4,74	20,8	36,6	
6	5,10	25,0	35,3	
7	5,43	29,2	34,2	
8	5,67	33,3	33,5	
9	5,90	37,5	32,8	
10	6,20	41,7	32	
11	6,52	45,8	31,2	
12	6,70	50,0	30,8	
13	6,97	54,2	30,2	
14	7,25	58,3	29,6	
15	7,55	62,5	29	
16	7,87	66,7	28,4	
17	8,08	70,8	28	
18	8,69	75,0	27,1	
19	9,25	79,2	26,2	
20	9,85	83,3	25,4	
21	10,67	87,5	24,4	
22	11,80	91,7	23,2	

1	2	3	4	5
Height of sedimentation	Time of sedimentation	Volume fraction of the sample	Grain diameter	Remarks
<i>h</i>	<i>t</i>	%	<i>d</i>	
in division lines	min.		µm	
23	13,24	95,8	21,9	
24	15,26	100,0	20,4	
25	-	-	-	

Date of testing: 2009-09-30 .....

Tested by: P. Durand .....

## Bibliography

- [1] ISO 8486-1, *Bonded abrasives — Determination and designation of grain size distribution — Part 1: Macrogrits F4 to F220*
- [2] ISO 8486-2, *Bonded abrasives — Determination and designation of grain size distribution — Part 2: Microgrits F230 to F2000*
- [3] ISO 9138, *Abrasive grains — Sampling and splitting*







# British Standards Institution (BSI)

BSI is the national body responsible for preparing British Standards and other standards-related publications, information and services.

BSI is incorporated by Royal Charter. British Standards and other standardization products are published by BSI Standards Limited.

## About us

We bring together business, industry, government, consumers, innovators and others to shape their combined experience and expertise into standards-based solutions.

The knowledge embodied in our standards has been carefully assembled in a dependable format and refined through our open consultation process. Organizations of all sizes and across all sectors choose standards to help them achieve their goals.

## Information on standards

We can provide you with the knowledge that your organization needs to succeed. Find out more about British Standards by visiting our website at [bsigroup.com/standards](http://bsigroup.com/standards) or contacting our Customer Services team or Knowledge Centre.

## Buying standards

You can buy and download PDF versions of BSI publications, including British and adopted European and international standards, through our website at [bsigroup.com/shop](http://bsigroup.com/shop), where hard copies can also be purchased.

If you need international and foreign standards from other Standards Development Organizations, hard copies can be ordered from our Customer Services team.

## Subscriptions

Our range of subscription services are designed to make using standards easier for you. For further information on our subscription products go to [bsigroup.com/subscriptions](http://bsigroup.com/subscriptions).

With **British Standards Online (BSOL)** you'll have instant access to over 55,000 British and adopted European and international standards from your desktop. It's available 24/7 and is refreshed daily so you'll always be up to date.

You can keep in touch with standards developments and receive substantial discounts on the purchase price of standards, both in single copy and subscription format, by becoming a **BSI Subscribing Member**.

**PLUS** is an updating service exclusive to BSI Subscribing Members. You will automatically receive the latest hard copy of your standards when they're revised or replaced.

To find out more about becoming a BSI Subscribing Member and the benefits of membership, please visit [bsigroup.com/shop](http://bsigroup.com/shop).

With a **Multi-User Network Licence (MUNL)** you are able to host standards publications on your intranet. Licences can cover as few or as many users as you wish. With updates supplied as soon as they're available, you can be sure your documentation is current. For further information, email [bsmusales@bsigroup.com](mailto:bsmusales@bsigroup.com).

## BSI Group Headquarters

389 Chiswick High Road London W4 4AL UK

## Revisions

Our British Standards and other publications are updated by amendment or revision.

We continually improve the quality of our products and services to benefit your business. If you find an inaccuracy or ambiguity within a British Standard or other BSI publication please inform the Knowledge Centre.

## Copyright

All the data, software and documentation set out in all British Standards and other BSI publications are the property of and copyrighted by BSI, or some person or entity that owns copyright in the information used (such as the international standardization bodies) and has formally licensed such information to BSI for commercial publication and use. Except as permitted under the Copyright, Designs and Patents Act 1988 no extract may be reproduced, stored in a retrieval system or transmitted in any form or by any means – electronic, photocopying, recording or otherwise – without prior written permission from BSI. Details and advice can be obtained from the Copyright & Licensing Department.

## Useful Contacts:

### Customer Services

**Tel:** +44 845 086 9001

**Email (orders):** [orders@bsigroup.com](mailto:orders@bsigroup.com)

**Email (enquiries):** [cservices@bsigroup.com](mailto:cservices@bsigroup.com)

### Subscriptions

**Tel:** +44 845 086 9001

**Email:** [subscriptions@bsigroup.com](mailto:subscriptions@bsigroup.com)

### Knowledge Centre

**Tel:** +44 20 8996 7004

**Email:** [knowledgecentre@bsigroup.com](mailto:knowledgecentre@bsigroup.com)

### Copyright & Licensing

**Tel:** +44 20 8996 7070

**Email:** [copyright@bsigroup.com](mailto:copyright@bsigroup.com)



...making excellence a habit.™