

# Steel castings — Ultrasonic examination —

## Part 2: Steel castings for highly stressed components

ICS 77.040.20; 77.140.80

## National foreword

This British Standard was published by BSI. It is the UK implementation of ISO 4992-2:2006.

The UK participation in its preparation was entrusted to Technical Committee ISE/6, Steel castings.

A list of organizations represented on ISE/6 can be obtained on request to its secretary.

This publication does not purport to include all the necessary provisions of a contract. Users are responsible for its correct application.

**Compliance with a British Standard cannot confer immunity from legal obligations.**

This British Standard was published under the authority of the Standards Policy and Strategy Committee on 30 November 2006

© BSI 2006

ISBN 0 580 49669 4

### Amendments issued since publication

Amd. No.	Date	Comments

# INTERNATIONAL STANDARD

**ISO**  
**4992-2**

First edition  
2006-02-15

---

---

## **Steel castings — Ultrasonic examination —**

### **Part 2: Steel castings for highly stressed components**

*Pièces moulées en acier — Contrôle aux ultrasons —*

*Partie 2: Pièces moulées en acier pour composants fortement sollicités*



Reference number  
ISO 4992-2:2006(E)



## Contents

Page

Foreword.....	iv
<b>1 Scope .....</b>	<b>1</b>
<b>2 Normative references .....</b>	<b>1</b>
<b>3 Terms and definitions.....</b>	<b>2</b>
<b>4 Requirements .....</b>	<b>2</b>
4.1 Order information .....	2
4.2 Extent of examination.....	3
4.3 Maximum permissible size of discontinuities .....	3
4.4 Personnel qualification .....	3
4.5 Wall-section zones.....	4
4.6 Severity levels .....	4
<b>5 Examination.....</b>	<b>4</b>
5.1 Principles.....	4
5.2 Material .....	4
5.3 Equipment, coupling medium, sensitivity and resolution of detection .....	5
5.4 Preparation of casting surfaces for testing .....	6
5.5 Examination procedure .....	6
5.6 Examination report .....	9
<b>Annex A (normative) Resolution of detection of the instrument/probe combination.....</b>	<b>16</b>
<b>Annex B (informative) Sound-beam diameters .....</b>	<b>17</b>
<b>Annex C (informative) Types of indications .....</b>	<b>19</b>
<b>Bibliography .....</b>	<b>31</b>

## Foreword

ISO (the International Organization for Standardization) is a worldwide federation of national standards bodies (ISO member bodies). The work of preparing International Standards is normally carried out through ISO technical committees. Each member body interested in a subject for which a technical committee has been established has the right to be represented on that committee. International organizations, governmental and non-governmental, in liaison with ISO, also take part in the work. ISO collaborates closely with the International Electrotechnical Commission (IEC) on all matters of electrotechnical standardization.

International Standards are drafted in accordance with the rules given in the ISO/IEC Directives, Part 2.

The main task of technical committees is to prepare International Standards. Draft International Standards adopted by the technical committees are circulated to the member bodies for voting. Publication as an International Standard requires approval by at least 75 % of the member bodies casting a vote.

Attention is drawn to the possibility that some of the elements of this document may be the subject of patent rights. ISO shall not be held responsible for identifying any or all such patent rights.

ISO 4992-2 was prepared by Technical Committee ISO/TC 17, *Steel*, Subcommittee SC 11, *Steel castings*.

ISO 4992 consists of the following parts, under the general title *Steel castings — Ultrasonic examination*:

- *Part 1: Steel castings for general purposes*
- *Part 2: Steel castings for highly stressed components*

# Steel castings — Ultrasonic examination —

## Part 2: Steel castings for highly stressed components

### 1 Scope

This part of ISO 4992 specifies the requirements for the ultrasonic examination of steel castings (with ferritic structure) for highly stressed components, and the methods for determining internal discontinuities by the pulse echo technique.

This part of ISO 4992 applies to the ultrasonic examination of steel castings which have usually received a grain-refining heat treatment and which have wall thicknesses up to and including 600 mm. For greater wall thicknesses, special agreements apply with respect to the test procedure and recording levels.

This part of ISO 4992 does not apply to austenitic steels and joint welds.

### 2 Normative references

The following referenced documents are indispensable for the application of this document. For dated references, only the edition cited applies. For undated references, the latest edition of the referenced document (including any amendments) applies.

ISO 5577, *Non-destructive testing — Ultrasonic inspection — Vocabulary*

ISO 7963, *Non-destructive testing — Ultrasonic testing — Specification for calibration block No. 2*

EN 583-1, *Non-destructive testing — Ultrasonic examination — Part 1: General principles*

EN 583-2, *Non-destructive testing — Ultrasonic examination — Part 2: Sensitivity and range setting*

EN 583-5,2005, *Non-destructive testing — Ultrasonic examination — Part 5: Characterization and sizing of discontinuities*

EN 1330-4, *Non-destructive testing — Terminology — Part 4: Terms used in ultrasonic testing*

EN 12223, *Non-destructive testing — Ultrasonic examination — Specification for calibration block No. 1*

EN 12668-1, *Non-destructive testing — Characterization and verification of ultrasonic examination equipment — Part 1: Instruments*

EN 12668-2, *Non-destructive testing — Characterization and verification of ultrasonic examination equipment — Part 2: Probes*

EN 12668-3, *Non-destructive testing — Characterization and verification of ultrasonic examination equipment — Part 3: Combined equipment*

### 3 Terms and definitions

For the purposes of this document, the terms and definitions given in ISO 5577, EN 583-1, EN 583-2, EN 583-5 and EN 1330-4, and the following, apply.

**3.1 reference discontinuity echo size**  
smallest indication to be recorded during the assessment phase of an ultrasonic examination, usually expressed as an equivalent flat-bottomed hole diameter

**3.2 point discontinuity**  
discontinuity, the dimensions of which are smaller than or equal to the sound-beam diameter

NOTE Dimensions in this part of ISO 4992 relate to length, width and/or dimension in the through-wall direction.

**3.3 complex discontinuity**  
discontinuity, the dimensions of which are larger than the sound-beam diameter

NOTE Dimensions in this part of ISO 4992 relate to length, width and/or dimension in the through-wall direction.

**3.4 planar discontinuity**  
discontinuity having two measurable dimensions

**3.5 volumetric discontinuity**  
discontinuity having three measurable dimensions

**3.6 special rim zone**  
outer rim-zone part with special requirements

NOTE Examples of special requirements are machined surfaces, higher stresses and sealing surfaces.

**3.7 production welding**  
any welding carried out during manufacturing before final delivery to the purchaser

**3.7.1 joint welding**  
production welding used to assemble components together to obtain an integral unit

**3.7.2 finishing welding**  
production welding carried out in order to ensure the agreed quality of the casting

## 4 Requirements

### 4.1 Order information

The following information shall be available at the time of enquiry and order (see also EN 583-1):

- the areas of the casting and the number or percentage of castings to which the ultrasonic examination requirements apply;
- the severity level to be applied to the various zones or areas of the casting;



- requirements for a written examination procedure;
- whether there are any additional requirements for the examination procedure, see also 5.5.1.

## 4.2 Extent of examination

The casting shall be examined so that the agreed areas are totally covered (insofar as this is possible from the shape of the casting) by the use of the best applicable examination technique.

For wall thicknesses greater than 600 mm, agreement shall be made between the parties concerned on the test procedure and also on the recording and acceptance levels.

## 4.3 Maximum permissible size of discontinuities

### 4.3.1 General

The purchaser shall specify the acceptance level according to the required severity level for planar and volumetric discontinuities within each zone and in each specified area of the casting.

The wall section shall be divided into zones as shown in Figure 1. These sections relate to the sizes of castings ready for assembly (finish machined).

### 4.3.2 Indications without measurable dimensions

In special rim zones and at weld preparation ends, indications without measurable dimensions are limited to a maximum number of indications.

These indications shall not exceed the limits given in Table 1.

### 4.3.3 Indications with measurable dimensions

#### 4.3.3.1 Planar discontinuities

Planar discontinuities shall not exceed the limits given in Figure 2.

The area of indication with measurable length, but with a non-measurable dimension in the through-wall direction, shall be calculated in accordance with the formula given in Figure 2.

The sizing of small planar discontinuities, as given in Figure 2, becomes more difficult with increasing beam-path length and sound-beam diameter. As a guide, these sizings are normally applied to a rim zone of 30 mm. This makes the use of probes with focussed beams, such as twin-crystal probes, necessary.

#### 4.3.3.2 Volumetric discontinuities

Volumetric discontinuities shall not exceed the sizes given in Figure 3 for the rim zone and Figure 4 for the core zone. Indications with measurable dimensions are not permissible in severity level 1. The area of an indication with measurable length but non-measurable width shall be calculated in accordance with the formula given in Figures 3 and 4.

## 4.4 Personnel qualification

It is assumed that ultrasonic examination is performed by qualified and capable personnel. In order to prove this qualification, it is recommended to certify personnel according to ISO 9712 or EN 473.

#### 4.5 Wall-section zones

The wall section shall be divided into zones as shown in Figure 1. These sections relate to the dimensions of the casting ready for assembly (finish machined).

#### 4.6 Severity levels

If the purchaser specifies different severity levels in different areas of the same casting, all of these areas shall be clearly identified on the purchaser's drawing and shall include:

- all necessary dimensions for accurate location of zones;
- the full extent of all weld preparations and the thickness of any special rim zone.

Severity level 1 is only applied to weld preparations and special rim zones.

Unless other requirements have been agreed by the time of acceptance of the order, for finishing welds, the requirements for the parent metal shall apply.

### 5 Examination

#### 5.1 Principles

The principles of ultrasonic examination given in EN 583-1, EN 583-2 and EN 583-5 shall apply.

#### 5.2 Material

The suitability of material for ultrasonic examination is assessed by comparison with the echo height of a reference reflector (usually the first backwall echo) and the noise signal. This assessment shall be carried out on selected casting areas which are representative of the surface finish and of the total thickness range. The assessment areas shall have parallel surfaces.

The reference echo height according to Table 2 shall be at least 6 dB above the noise signal.

If the echo height of this smallest detectable flat-bottomed or equivalent side-drilled hole diameter at the end of the test range to be assessed is less than 6 dB above the grass level, then the ultrasonic testability is reduced. In this case, the flat-bottomed or side-drilled hole diameter which can be detected with a signal-noise ratio of at least 6 dB shall be noted in the test report and the additional procedure shall be agreed between the manufacturer and the purchaser.

NOTE For the definition of an adequate flat-bottomed hole size, the distance gain size system (DGS) or a test block of identical material, heat treatment condition and section thickness containing flat-bottomed holes with a diameter according to Table 2 or equivalent side-drilled holes, can be used. The following formula is used for converting the flat-bottomed hole diameter into the side-drilled hole diameter:

$$D_Q = \frac{4,935 \times D_{FBH}^4}{\lambda^2 \times s} \quad (1)$$

where

- $D_Q$  is the side-drilled hole diameter, in millimetres;
- $D_{FBH}$  is the flat-bottomed hole diameter, in millimetres;
- $\lambda$  is the wave length, in millimetres;
- $s$  is the path length, in millimetres.

The formula is applicable for  $D_Q \geq 2\lambda$  and  $s \geq 5 \times$  near-field length and is only defined for single element probes.

### 5.3 Equipment, coupling medium, sensitivity and resolution of detection

#### 5.3.1 Ultrasonic instrument

The ultrasonic instrument shall meet the requirements given in EN 12668-1 and shall have the following characteristics:

- range setting, from at least 10 mm to 2 m continuously selectable, for longitudinal and transverse waves transmitted in steel;
- gain, adjustable in 2 dB maximum steps over a range of at least 80 dB with a measuring accuracy of 1 dB;
- time-base and vertical linearities less than 5 % of the adjustment range of the screen;
- suitability, at least for nominal frequencies from 1 MHz up to and including 6 MHz, in the pulse-echo technique with single-crystal and twin-crystal probes.

#### 5.3.2 Probes and transducer frequencies

The probes and transducer frequencies shall be as given in EN 12668-2 and EN 12668-3 with the following exceptions:

- nominal frequencies shall be in the range 1 MHz to 6 MHz;
- for oblique incidence, angle probes with angles between 35° and 70° shall be used.

NOTE Normal or angle probes can be used for the examination of steel castings for highly stressed components. The type of probe used depends on the geometry of the casting and the type of discontinuity to be detected.

For examining zones close to the surface, twin-crystal probes (normal or angle) should be preferred.

#### 5.3.3 Checking the ultrasonic examination equipment

The ultrasonic examination equipment shall be checked regularly by the operator in accordance with EN 12668-3.

#### 5.3.4 Coupling medium

A coupling medium in accordance with EN 583-1 shall be used. The coupling medium shall wet the examination area to ensure satisfactory sound transmission. The same coupling medium shall be used for calibration and all subsequent examination operations.

NOTE The sound transmission can be checked by ensuring one or more stable backwall echoes in areas with parallel surfaces.

#### 5.3.5 Sensitivity and resolution of detection

The detection sensitivity of the instrument shall allow at least the setting of the sensitivity in accordance with the requirements of 5.5.2.

The resolution of detection of the instrument/probe combination shall meet the requirements of Annex A.

## 5.4 Preparation of casting surfaces for testing

For the preparation of casting surfaces for examination, see EN 583-1.

The casting surfaces to be examined shall be such that satisfactory coupling with the probe can be achieved.

In the case of single-crystal probes, satisfactory coupling can be achieved if the condition of the surfaces to be examined corresponds at least to the limit comparator 4 S1 or 4 S2 according to EN 1370.

The roughness of any machined surface to be examined shall be  $R_a \leq 12,5 \mu\text{m}$ .

For special techniques, higher surface qualities such as 2 S1, 2 S2 (see EN 1370) and  $R_a \leq 6,3 \mu\text{m}$  can be necessary.

## 5.5 Examination procedure

### 5.5.1 General

Because the choice of both the direction of incidence and suitable probes largely depends on the shape of the casting, or on the possible casting discontinuities or on the possible discontinuities from finishing welding, the applicable examination procedure shall be specified by the manufacturer of the casting. In special cases, specific agreements can be made.

If possible, the areas to be tested shall be examined from both sides. When testing from one side only, short-range resolving probes shall be used additionally for the detection of discontinuities close to the surface. Testing with twin-crystal probes is only adequate for wall thicknesses up to 50 mm.

Additionally, when not otherwise agreed between the purchaser and the manufacturer, for all castings, twin-crystal normal and/or angle probes shall be used to examine the following areas up to a depth of 50 mm:

- critical areas, e.g. fillets, changes in cross-section, areas with external chills;
- finishing welds;
- weld preparation areas, as specified in the order;
- special rim zones, as specified in the order, critical for the performance of the casting.

Finishing welds which are deeper than 50 mm shall be subject to supplementary examination with other suitable angle probes.

For angle probes with angles over  $60^\circ$ , the sound beam path shall not exceed 150 mm.

Complete coverage of all areas specified for examination shall be conducted by carrying out systematically overlapping scans.

The scanning rate shall not exceed 150 mm/s.

### 5.5.2 Range setting

Range setting shall be carried out in accordance with EN 583-2 on the screen of the test instrument, using normal or angle probes in accordance with one of the three options given below:

- with the calibration block No. 1 in accordance with EN 12223, or No. 2 in accordance with ISO 7963;
- with an alternative calibration block made in a material exhibiting similar acoustic properties to those of the material to be examined;
- on the casting itself when using normal probes. In this case, the casting to be tested shall have parallel surfaces, the distance between which shall be measured.

### 5.5.3 Sensitivity setting

#### 5.5.3.1 General

Sensitivity setting shall be carried out after range setting (see 5.5.2) in accordance with EN 583-2. One of the following two techniques shall be used:

- Distance-amplitude correction curve technique (DAC)

The distance-amplitude correction curve technique makes use of the echo-heights of a series of identical reflectors (flat-bottomed holes FBH or side-drilled holes SDH), each reflector having a different sound-beam path.

NOTE A frequency of 2 MHz and a diameter of 6 mm for the flat-bottomed holes are most commonly used.

- Distance gain size technique (DGS)

The distance gain size technique makes use of a series of theoretically derived curves which link the sound-beam path, the apparatus gain and the diameter of a disc-shaped reflector which is perpendicular to the beam axis.

#### 5.5.3.2 Transfer correction

Transfer correction shall be determined in accordance with EN 583-2.

When calibration blocks are used, transfer correction can be necessary. When determining the transfer correction, consideration shall be given not only to the quality of the coupling surface but also to that of the opposite surface, because the opposite surface also influences the height of the backwall echo (used for calibration). If the opposite surface is machined or complies at least to the limit comparator 4 S1 or 4 S2 according to EN 1370, this surface has a quality which is sufficient for transfer correction measurements.

#### 5.5.3.3 Detection of discontinuities

For discontinuity detection, the gain shall be increased until the noise level becomes visible on the screen (search sensitivity).

The echo heights of the flat-bottomed holes given in Table 2, or of the equivalent side-drilled holes, shall be at least 40 % of the screen height at the end of the thickness range to be tested.

If, during testing, suspicion arises that the reduction of backwall-echo indication exceeds the recordable value (see Table 3), testing shall be repeated using locally reduced test sensitivity and the reduction of backwall-echo indication shall be determined quantitatively in decibels.

The sensitivity setting of angle-beam probes shall be such that the typical dynamic echo pattern of these reflectors (see Figure 3) is clearly visible on the screen.

It is recommended that the sensitivity setting of angle-beam probes is verified on real (not artificial) planar discontinuities (cracks with dimensions in the through-wall direction) or on walls perpendicular to the surface and infinite to the sound beam. In these circumstances, the probe shoe should be contoured to fit the casting shape (see EN 583-2).

### 5.5.4 Consideration of various types of indications

The following types of indications can occur separately or jointly during the examination of castings and shall be observed and evaluated:

- reductions of backwall echo which are not due to the casting shape or the coupling;
- echo indications of discontinuities.

The reduction of backwall echo is expressed in decibels as the drop of the backwall-echo height. The height of the echo indication is given as the flat-bottomed or side-drilled hole diameter.

### **5.5.5 Recording and recording limits**

#### **5.5.5.1 Reduction of backwall echo**

All backwall-echo reductions in excess of 12 dB (for a nominal test frequency of 2 MHz) shall be recorded. The backwall-echo reductions to be recorded shall be marked and measured as indication areas.

#### **5.5.5.2 Echo indications from discontinuities**

The recording limit of an echo indication is defined by its signal amplitude according to a reference discontinuity echo size.

All echo indications from discontinuities with measurable dimensions shall be recorded, when the signal amplitude exceeds both the levels given in Table 3 and the criteria given in Figures 3 and 4.

Distinction shall be made between the different types of indications given in Table 4.

To identify the type of indication, the test sensitivity can be changed according to the distance from the test surface, the geometrical shape and the surface finish of the test surface.

When using transverse wave probes, irrespective of amplitude, all indications which display travelling characteristics or have an apparent dimension in the through-wall direction shall be recorded for subsequent assessment in accordance with 5.5.7.3.

Each location, where indications to be recorded have been found, shall be marked and indicated in the test report. The location of reflection points shall be documented, e.g. by a sketch or photograph.

### **5.5.6 Investigation of indications to be recorded**

The locations where indications to be recorded have been found (see 5.5.5) shall be investigated more closely with respect to their type, shape, size and position. This investigation can be achieved by altering the ultrasonic test technique (e.g. changing the angle of incidence) or by additionally carrying out radiographic examination.

### **5.5.7 Characterization and sizing of discontinuities**

#### **5.5.7.1 General**

For characterization and sizing of discontinuities, see EN 583-5.

The ultrasonic determination of the dimensions of a discontinuity with an accuracy sufficient for engineering applications is only possible under certain preconditions (e.g. knowledge of the type of discontinuity, simple geometry of the discontinuity and optimum impact of the sound beam on the discontinuity).

The characterization of the type of discontinuities can be improved by using additional sound directions and angles of incidence. For a simplification of the procedure, the following categorizations of discontinuities are made:

- discontinuities without measurable dimensions (point discontinuities);
- discontinuities with measurable dimensions (complex discontinuities).

NOTE 1 Annex B gives information on sound-beam diameters in order to distinguish between discontinuities with or without measurable dimensions.

NOTE 2 Annex C gives information on types of indications and on the determination of their dimensions. It also gives information on range setting (see 5.5.2) and on sensitivity setting (see 5.5.3).

For the determination of the dimensions of discontinuities, it is recommended that probes having a sound-beam diameter as small as possible at the location of the discontinuity are used.

#### 5.5.7.2 Sizing of discontinuities mainly parallel to the test surface

The boundaries of any discontinuity shall be defined by the perimeter line at which the signal amplitude falls to 6 dB below the last maximum or at which, in the case of backwall-echo reduction, the echo is reduced by 6 dB (2 MHz probe) below the height of the undisturbed backwall echo.

The dimension in the through-wall direction of the discontinuity should be measured according to Figure 5.

#### 5.5.7.3 Sizing of discontinuities in the through-wall direction

The sizing of planar discontinuities and their assessment in relation to specified severity levels shall be carried out by the probe movement in accordance with 5.5.7.1, but in this case, the echo is reduced by 20 dB (see Figures C.7 and C.9).

### 5.6 Examination report

The examination report shall contain at least the following information:

- a reference to this International Standard;
- characteristic data of the examined casting;
- extent of examination;
- type of examination equipment used;
- probes used;
- the examination technique with reference to the examination area;
- all data necessary for sensitivity setting;
- information on all characteristic features of discontinuities to be recorded (e.g. backwall-echo reduction, position and dimension in the through-wall direction, length, area and flat-bottomed hole diameter) and the descriptions of their position (sketch or photograph);
- date of the examination and name of the responsible person.

**Table 1 — Acceptance limits for discontinuities without measurable dimensions in special rim zones and weld preparation ends (scanned by normal or angle probes)**

Severity level <sup>a</sup>	Smallest equivalent flat-bottomed or side-drilled hole diameter to be considered		Acceptance limits <sup>c</sup> for discontinuities in a frame 100 mm × 100 mm	
	FBH <sup>b</sup> mm	SDH <sup>b</sup> mm	number max.	distance min. mm
1	1,5	3 <sup>d, e</sup> (with – 6 db on DAC)	6	12
2	1,5	3 <sup>d, e</sup> (with – 6 db on DAC)	12	10
3	2	3 <sup>d</sup>	12	8

<sup>a</sup> Severity level 1 generally applies to the complete wall thickness of weld preparation ends. The severity level for special rim zones shall be specified by the purchaser.

<sup>b</sup> FBH = flat-bottomed hole, SDH = side-drilled hole.

<sup>c</sup> If the indications are more than 15 mm apart, they are acceptable, irrespective of their number.

<sup>d</sup> Applicable to angle probes (4 MHz, crystal diameter approx. 10 mm).

<sup>e</sup> A SDH of diameter 0,75 mm can be represented by a SDH of diameter 3 mm, if the distance-amplitude correction curve of a SDH of diameter 3 mm is reduced by 50 %.

**Table 2 — Ultrasonic testability requirements**

Dimensions in millimetres

Wall thickness	Tested area	Smallest flat-bottomed hole diameter detectable according to 5.2
≤ 100	—	2
> 100 to ≤ 300	—	3
> 300 to ≤ 600	—	4
—	Special rim zone, weld preparation ends	1,5

**Table 3 — Recording levels**

Wall thickness mm	Smallest equivalent flat-bottomed hole diameter mm	Reduction of backwall echo min. dB
≤ 100	2	12
> 100 to ≤ 300	3	
> 300 to ≤ 600	4	



Table 4 — Reference codes for types of indications

Reference code <sup>a</sup>	Type of indication	Figure
SDB	Reduction of backwall echo	C.2
II	Individual indication without measurable dimension	C.3, C.4
IIL	Individual indication with one measurable dimension	C.4, C.5
GIR	Group of resolvable indications	C.6
IIP/IID	Individual indication with two dimensions	C.5, C.7
NII	Numerous indications without measurable dimensions	C.8
NIP	Numerous indications with dimensions in the through-wall direction	C.9
GIN	Group of non-resolvable indications	C.10, C.11

<sup>a</sup> For characterization of indications see EN 583-5:2000, Annex B.

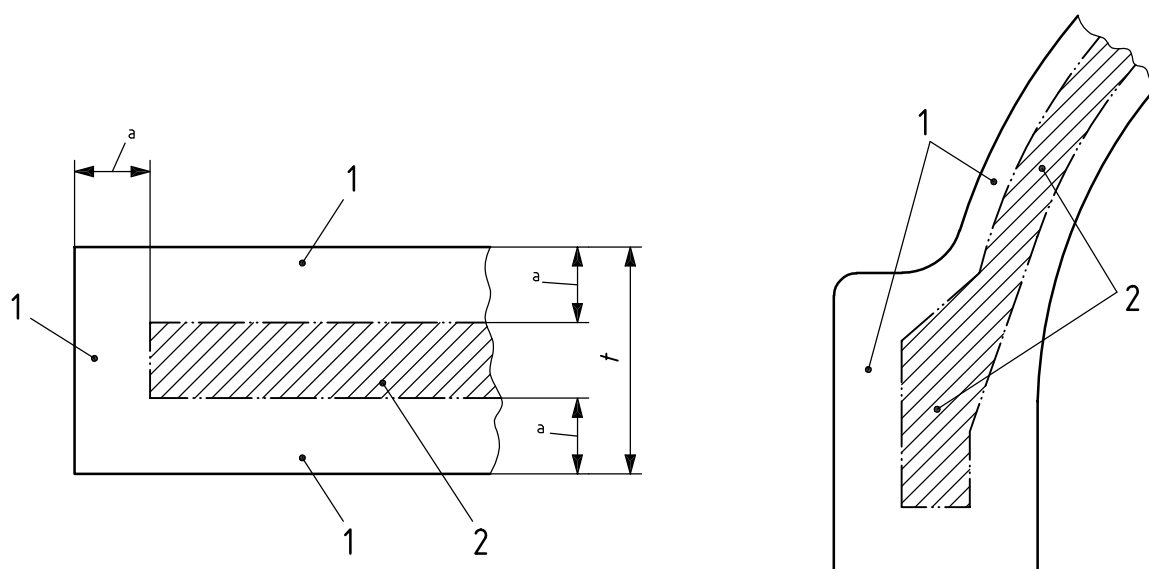
**Key**

- 1 Rim zone
- 2 Core zone
- $t$  Wall thickness
- $a$   $t/3 \times t$  (max. 30 mm)

Figure 1 — Division of wall section into zones

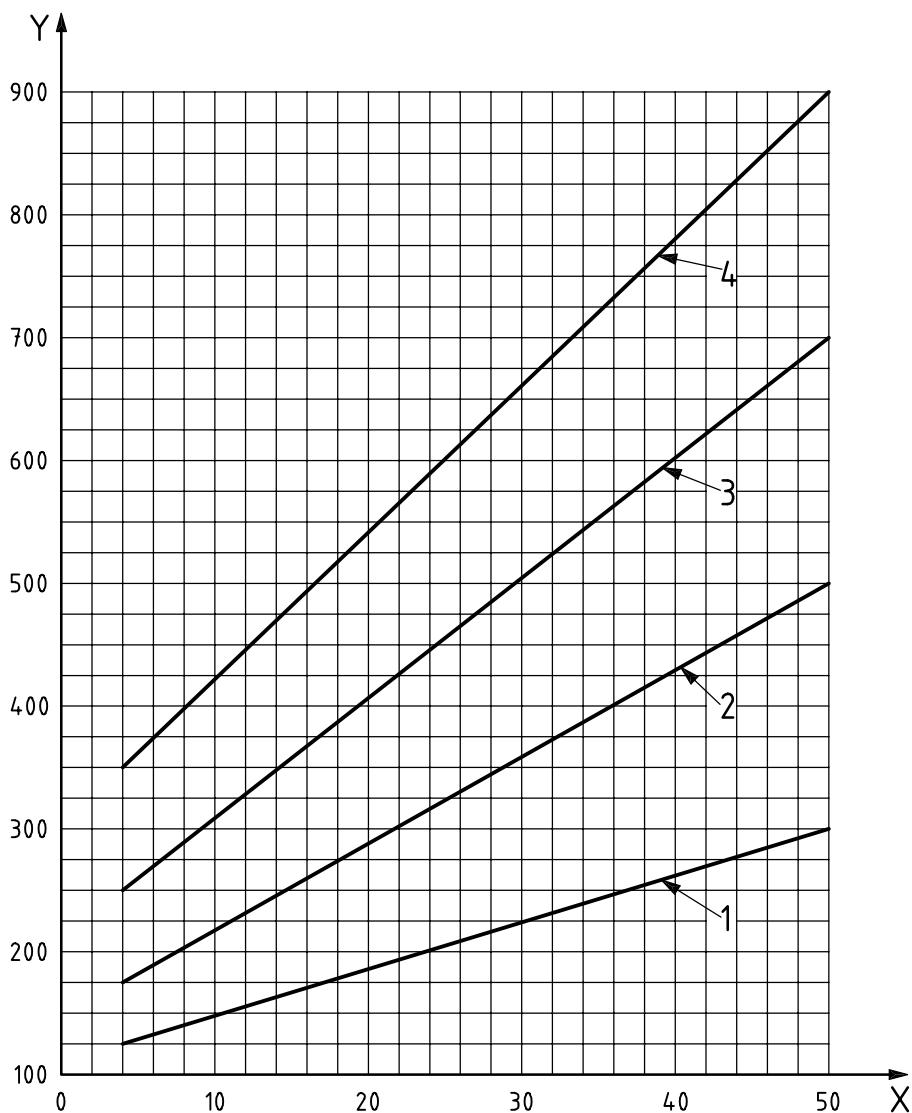
**Key**

- |   |  |   |                  |
|---|--|---|------------------|
| 1 | Severity level 2   | 3 | Severity level 4 |
| 2 | Severity level 3   | 4 | Severity level 5 |
| X | Distance from test surface, in millimetres                           |   |                  |
| Y | Largest acceptable individual indication area, in square millimetres |   |                  |

Indications with measurable dimensions are not permissible as severity level 1.

The maximum dimension in the through-wall direction shall not exceed 10 % of the wall thickness, except indications with a measurable length  $\leq 10$  mm. Such indications shall not exceed a dimension in the through-wall direction of 25 % of the wall thickness or 20 mm, whichever is the least.

The maximum distance between indications, as criterion for evaluation as an individual indication or indication area in the through-wall direction or lateral to the surface, shall be 10 mm.

For an area with measurable length and non-measurable dimension in the through-wall direction, this non-measurable dimension shall be taken as 3 mm and the area shall be calculated:  $A = 3 \times L$ , where  $A$  is the area of indication, in square millimetres; 3 is the defined width, in millimetres;  $L$  is the measurable length, in millimetres.

**Figure 2 — Acceptance limits for individual planar indications mainly orientated in the through-wall direction (see also Figures C.8, C.9 and C.11) detected with angle probes**

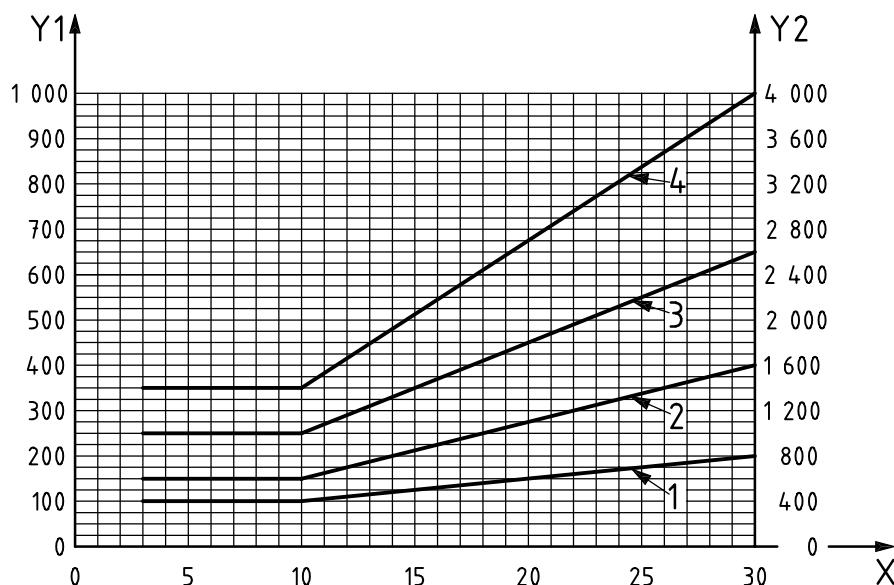

#### Key

- 1 Severity level 2
- 2 Severity level 3
- 3 Severity level 4
- 4 Severity level 5

X Shortest distance from test surface or from backwall, in millimetres

Y1 Smallest indication area to be recorded, in square millimetres

Y2 Largest acceptable individual indication area, in square millimetres

Indications with measurable dimensions are not permissible as severity level 1.

The maximum acceptable dimensions of discontinuities or indication areas in the through-wall direction shall be 15 % of the rim zone thickness.

The maximum distance between discontinuities, as a criterion for evaluation as an individual indication in the through-wall direction or lateral to the surface, shall be 10 mm.

For an area with measurable length and non-measurable dimension in the through-wall direction, this non-measurable dimension shall be taken as 3 mm and the area shall be calculated:  $A = 3 \times L$ , where  $A$  is the area of indication, in square millimetres; 3 is the defined width, in millimetres;  $L$  is the measurable length, in millimetres.

**Figure 3 — Recording and acceptance limits for volumetric indications with measurable dimensions in the rim zone (see also Figures C.2, C.5 and C.10) detected with normal probes**

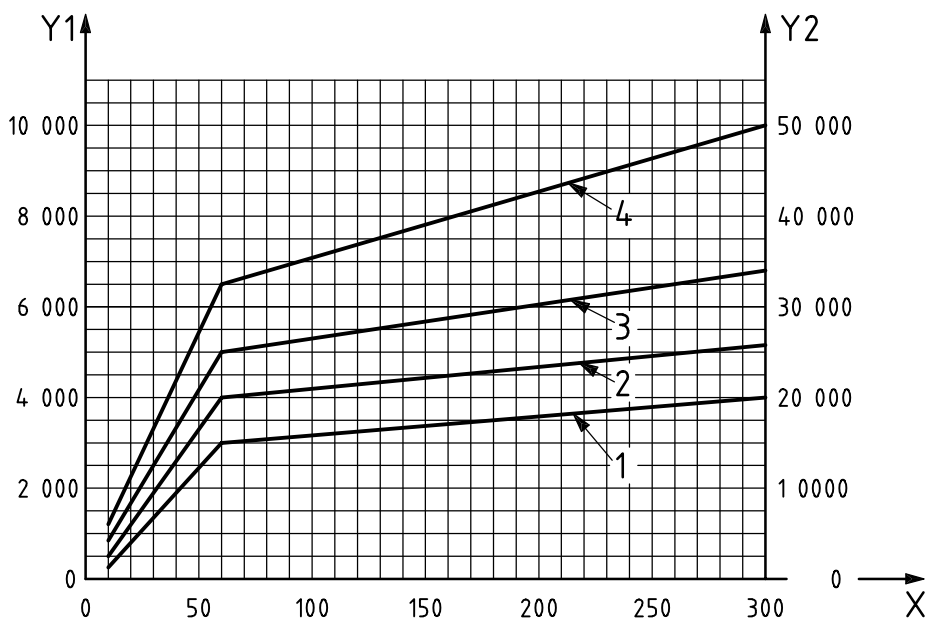

#### Key

- 1 Severity level 2
  - 2 Severity level 3
  - 3 Severity level 4
  - 4 Severity level 5
- X Shortest distance from test surface or from backwall, in millimetres  
 Y1 Smallest indication area to be recorded, in square millimetres  
 Y2 Largest acceptable individual indication area, in square millimetres

Indications with measurable dimensions are not permissible in severity level 1.

The maximum acceptable dimensions of discontinuities or indication areas in the through-wall direction shall be 15 % of the wall thickness.

The maximum distance between discontinuities, as a criterion for evaluation as an individual indication in the through-wall direction or lateral to the surface, shall be 20 mm.

For an area with measurable length and non-measurable dimension in the through-wall direction, this non-measurable dimension shall be taken as 3 mm and the area shall be calculated:  $A = 3 \times L$ , where  $A$  is the area of indication, in square millimetres; 3 is the defined width, in millimetres;  $L$  is the measurable length, in millimetres.

Unless otherwise agreed by the time of enquiry and order, when, after conducting the radiographic and the ultrasonic examination in combination, it has been demonstrated that a discontinuity is situated in the core zone, this additional information shall make the discontinuity acceptable at one level less severe, e.g. severity level 3 instead of severity level 2 for radiographic examination, see EN 1559-2.

**Figure 4 — Recording and acceptance limits for volumetric indications with measurable dimensions in the core zone (see also Figures C.2, C.5 and C.10) detected with normal probes**

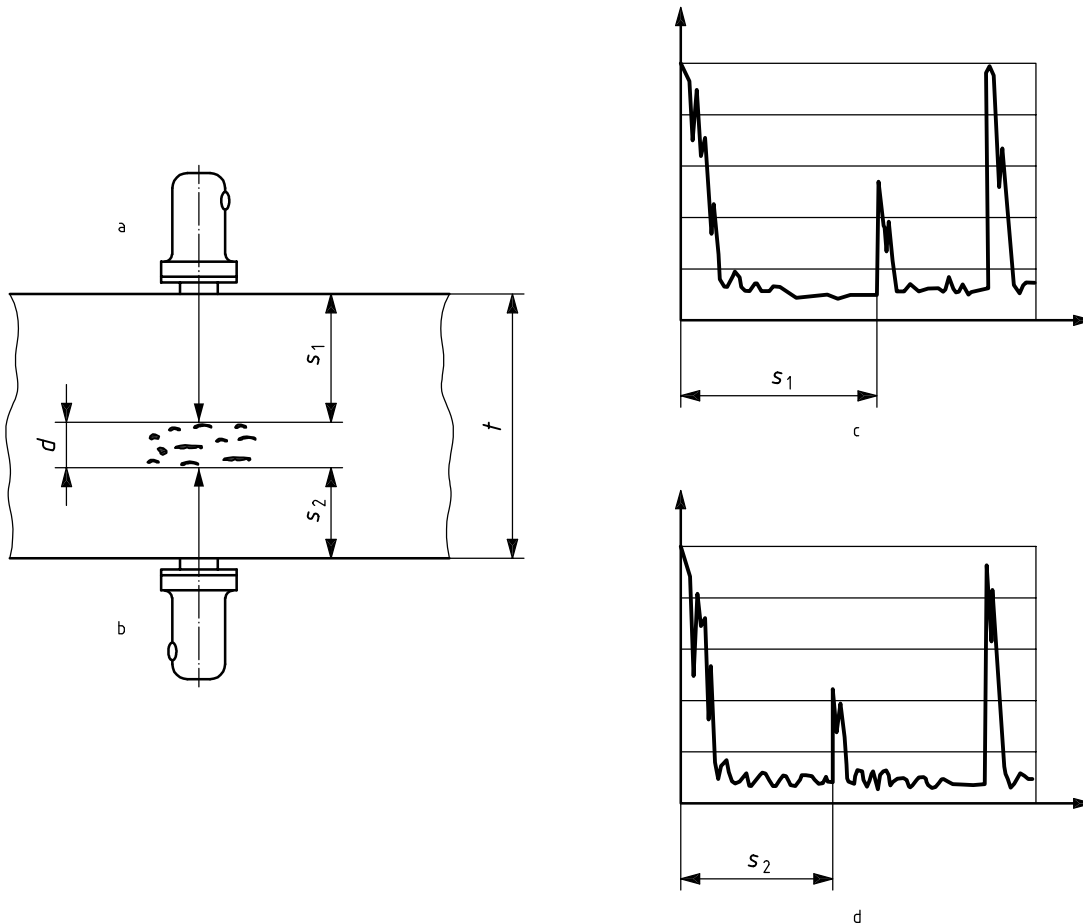

### Key

- a Scanning position "A"
- b Scanning position "B"
- c A-scan from scanning position "A"
- d A-scan from scanning position "B"

$$\text{Depth extension } d = t - (s_1 + s_2)$$

where

$t$  is the wall thickness;

$s_1, s_2$  are the lengths of the sound-beam paths.

**Figure 5 — Measurement of the dimension of discontinuities in the through-wall direction with normal probes**

## Annex A (normative)

### Resolution of detection of the instrument/probe combination

The resolution of detection of the instrument/probe combination shall be assessed by measuring the width of the first backwall echo using the 25 mm thick section of the IIW A 2 steel reference block in accordance with EN 12223. The echo amplitude shall be set at 80 % to 100 % of full screen height and the width of the echo measured in millimetres of steel at a level of 10 % of the echo height. Typical values are given in Table A.1.

**Table A.1 — Typical values of echo widths**

Frequency MHz	Echo width	
	longitudinal waves (L) mm	transverse waves (T) mm
1	15	—
2 or 2,25	9	5
4	5	3
5	4	2,5

## Annex B (informative)

### Sound-beam diameters

This Annex gives information on sound-beam diameters in order to distinguish between discontinuities with or without measurable dimensions.

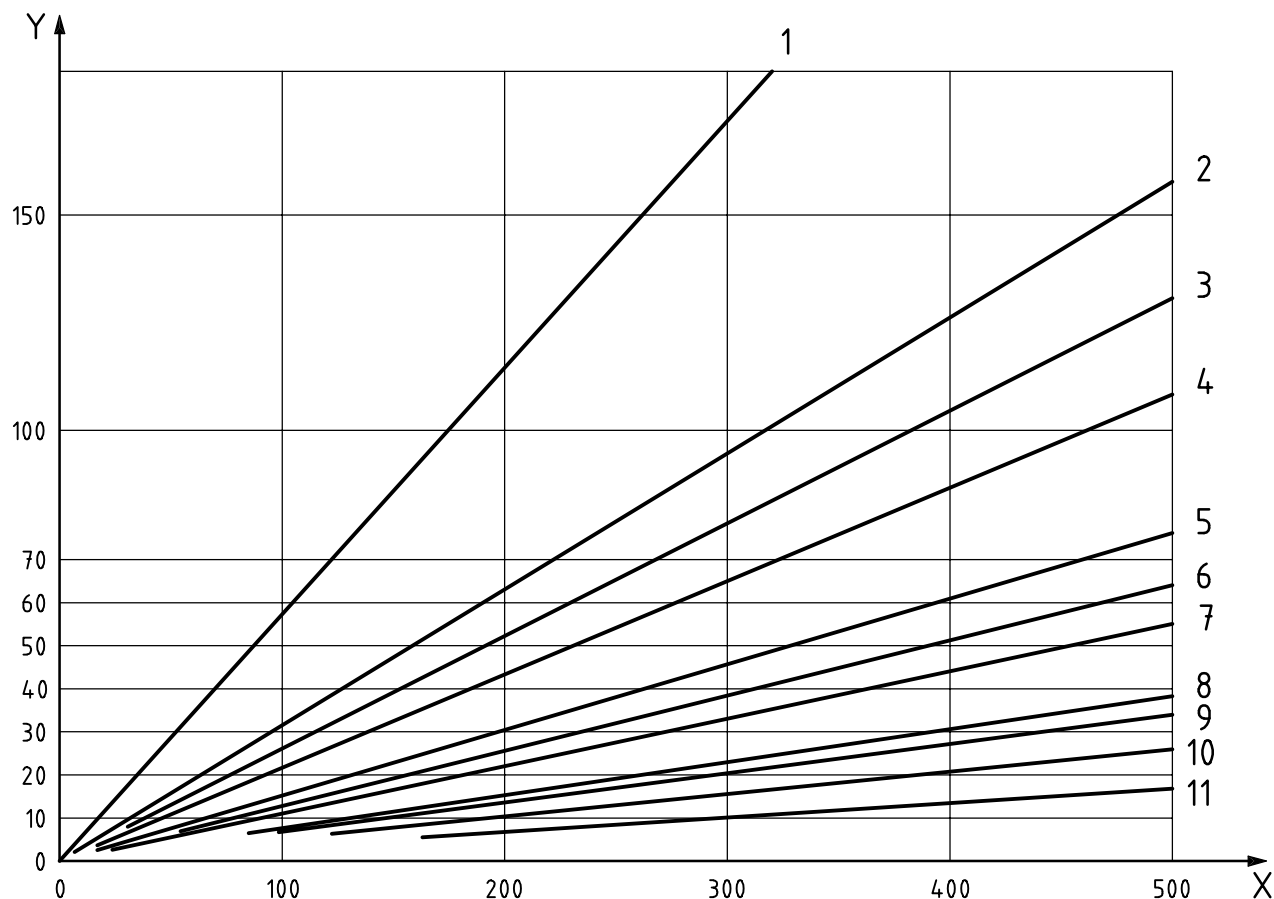

Near-field lengths

Probe crystal dimension mm	Near-field length in millimetres (approximate values)					
	longitudinal waves (L)				transverse waves (T)	
	1 MHz	2 MHz	4 MHz	5 MHz	2 MHz	4 MHz
∅ 10	4,2	8,0	15,6	—	—	—
∅ 24	22,7	45	88	115	—	—
8 × 9	—	—	—	—	14	28
20 × 22	—	—	—	—	75	150

#### Key

1	1 MHz, L, ∅ 10	4	2 MHz, T, 8 × 9	7	4 MHz, T, 8 × 9	10	5 MHz, L, ∅ 24
2	2 MHz, L, ∅ 10	5	4 MHz, L, ∅ 10	8	2 MHz, T, 8 × 9	11	4 MHz, T, 20 × 22
3	1 MHz, L, ∅ 24	6	2 MHz, L, ∅ 24	9	4 MHz, L, ∅ 24		

X Sound-beam path, in millimetres

Y Sound-beam diameter (– 6 dB), in millimetres

**Figure B.1 — Sound-beam diameters according to sound-beam path and near-field length for various probes**

## BS ISO 4992-2:2006

The near-field length and the sound-beam diameter can be calculated using the following formulae:

$$N = \frac{D_c^2}{4 \times \lambda} \quad (\text{B.1})$$

$$D_F = \frac{2 \times s}{D_c} \quad (\text{B.2})$$

where

$N$  is the near-field length, in millimetres;

$D_c$  is the crystal diameter, in millimetres;

$\lambda$  is the wave length, in millimetres;

$s$  is the sound-beam path, in millimetres;

$D_F$  is the sound-beam diameter, in millimetres, along the sound-beam path, where the decrease of the sound pressure perpendicular to the central beam is 6 dB.



## **Annex C** (informative)

### **Types of indications**

Figures C.1 to C.11 show possible distinctions between the different types of indications by echo-dynamics.

For the identification of the type of indication, the test sensitivities can be changed according to:

- the distance from the surface to be examined;
- the geometrical shape;
- the surface finish of the surface to be examined.

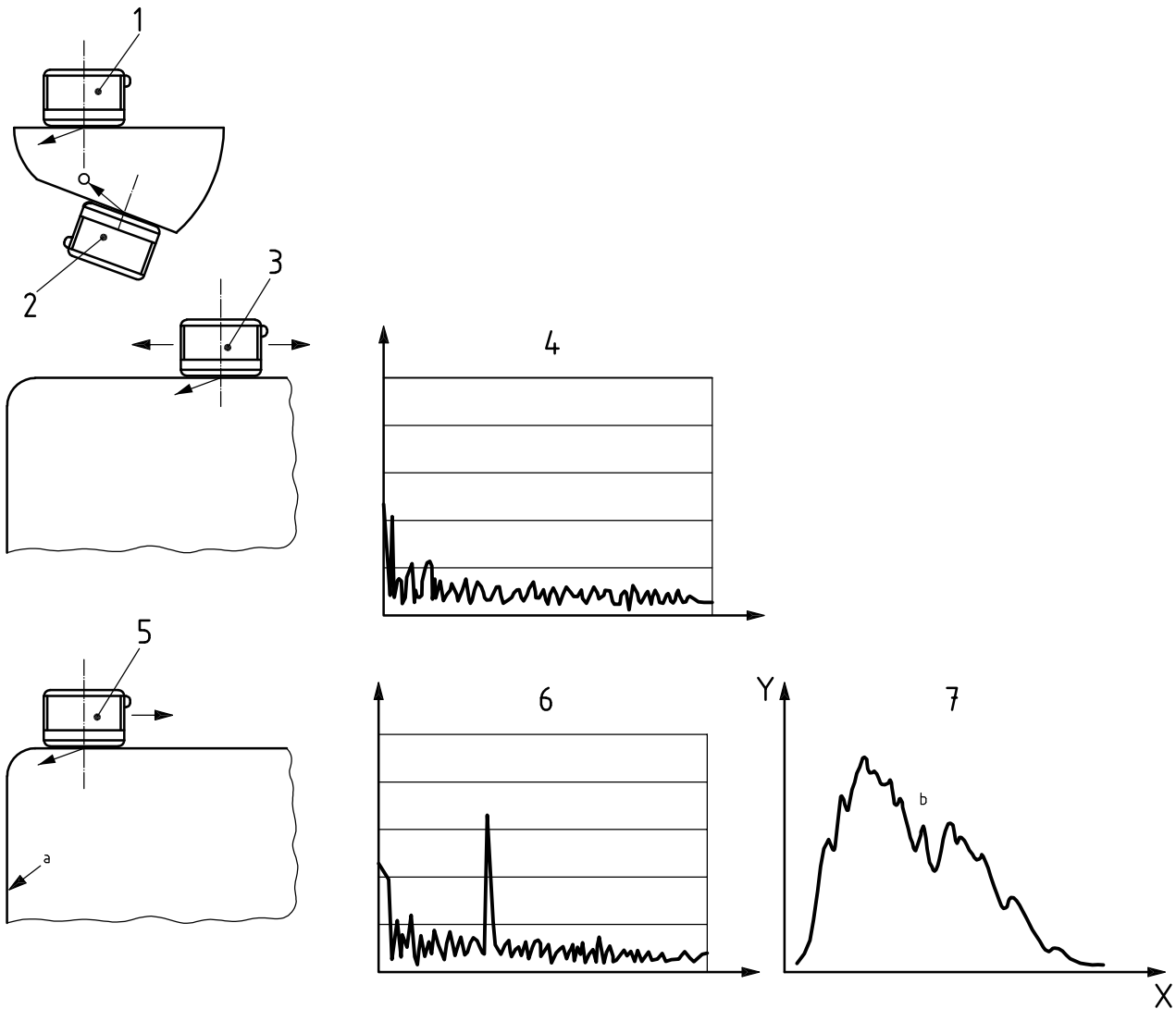

### Key

- 1 Range setting, e.g. with calibration block in accordance with EN 12223 or ISO 7963
  - 2 Check of test equipment on side-drilled hole of calibration block, echo height of side-drilled hole 100 % of screen height
  - 3 Sensitivity setting in an area of the casting to be examined, free from discontinuities without reference reflector
  - 4 Average height of noise level approximately 5 % to 10 % of screen height
  - 5 Check of test sensitivity and test equipment by observation of the echo-dynamics of an as-cast surface in the through-wall direction
  - 6 A-scan
  - 7 Typical echo dynamic
- X Probe movement  
Y Echo height
- a As-cast surface.  
b Echo dynamics.

**Figure C.1 — Range setting and sensitivity setting of ultrasonic instrument with a twin-crystal angle probe scan (4 MHz, 60° angle) to detect discontinuities mainly orientated in the through-wall direction with a measurable dimension in the region of the rim zone**

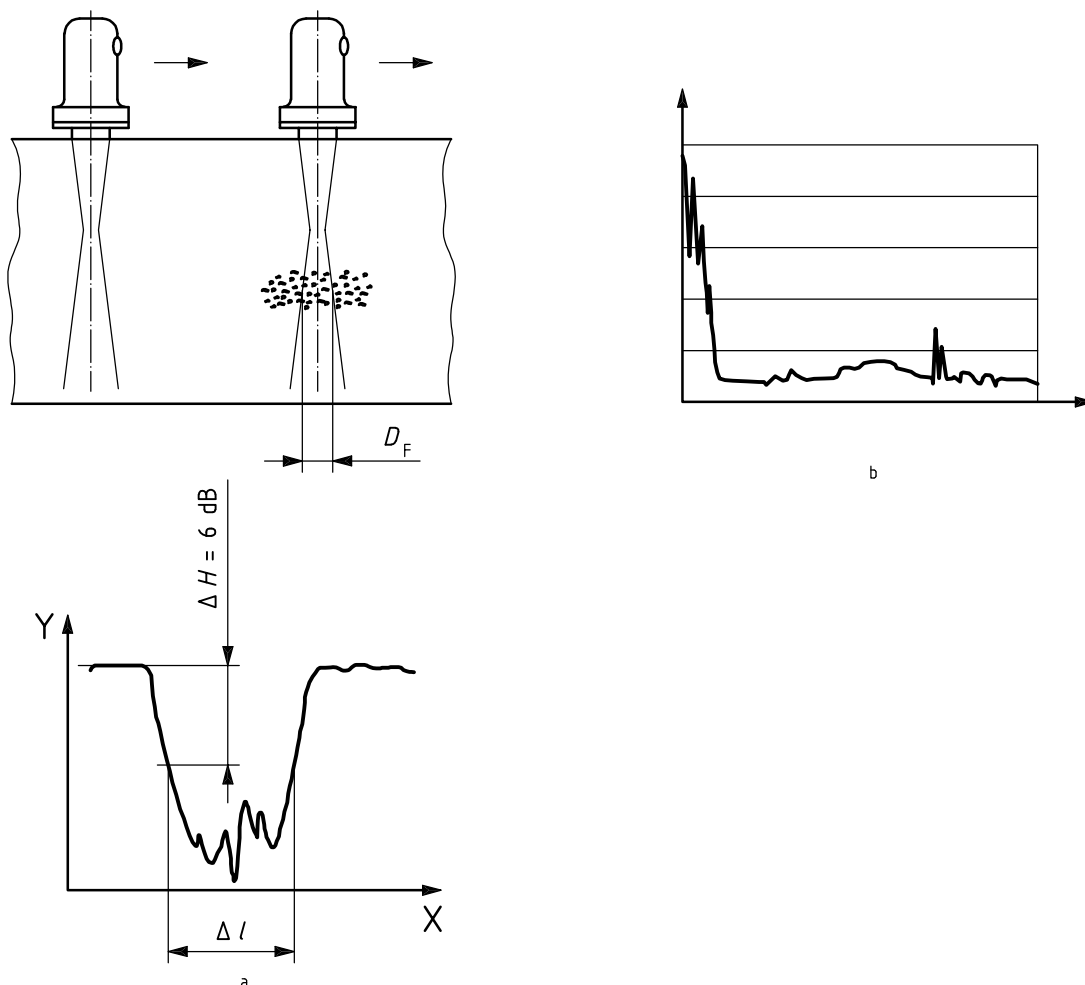

Typical indication:

Reduction of backwall echo by more than 12 dB. Indications from discontinuities frequently invisible.

Reason: spongy shrinkage, gas holes, inclusions or large inclined discontinuity.

$$\Delta l > D_F$$

where

$D_F$  is the sound-beam diameter;

$\Delta l$  is the dimension of the discontinuity.

#### Key

$\Delta H$  Reduction of backwall echo

X Probe movement

Y Echo height

a Echo dynamics.

b A-scan.

**Figure C.2 — Reduction of backwall echo by more than 12 dB, measurable dimension of indication range**

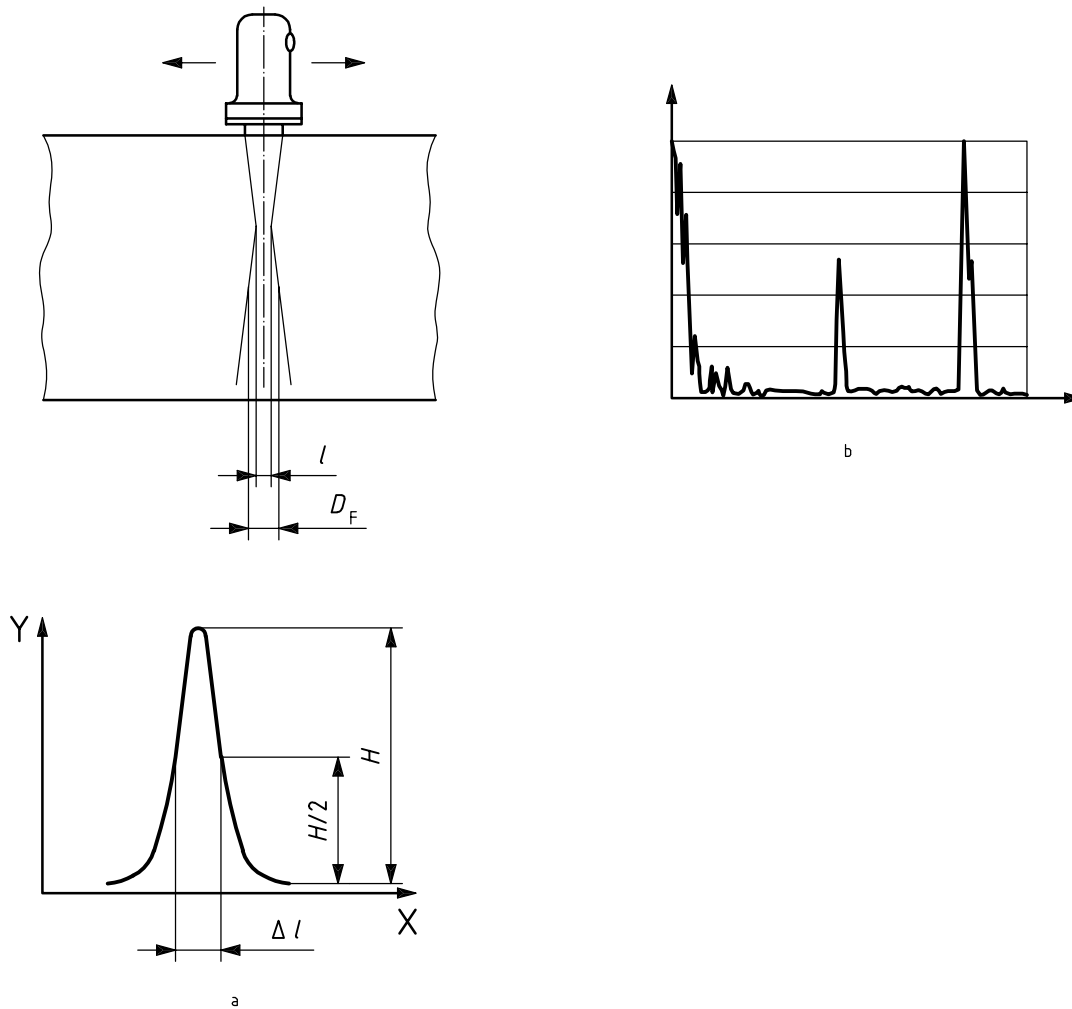

Typical indication:

Individual indication, half-value dimension  $\Delta l$  smaller than or equal to the sound-beam diameter  $D_F$ .

**Key**

- $l$  Lateral extension of indication
- $H$  Maximum echo height of individual indication
- $X$  Probe movement
- $Y$  Echo height
- a Echo dynamics.
- b A-scan.

**Figure C.3 — Individual indication without measurable dimensions**

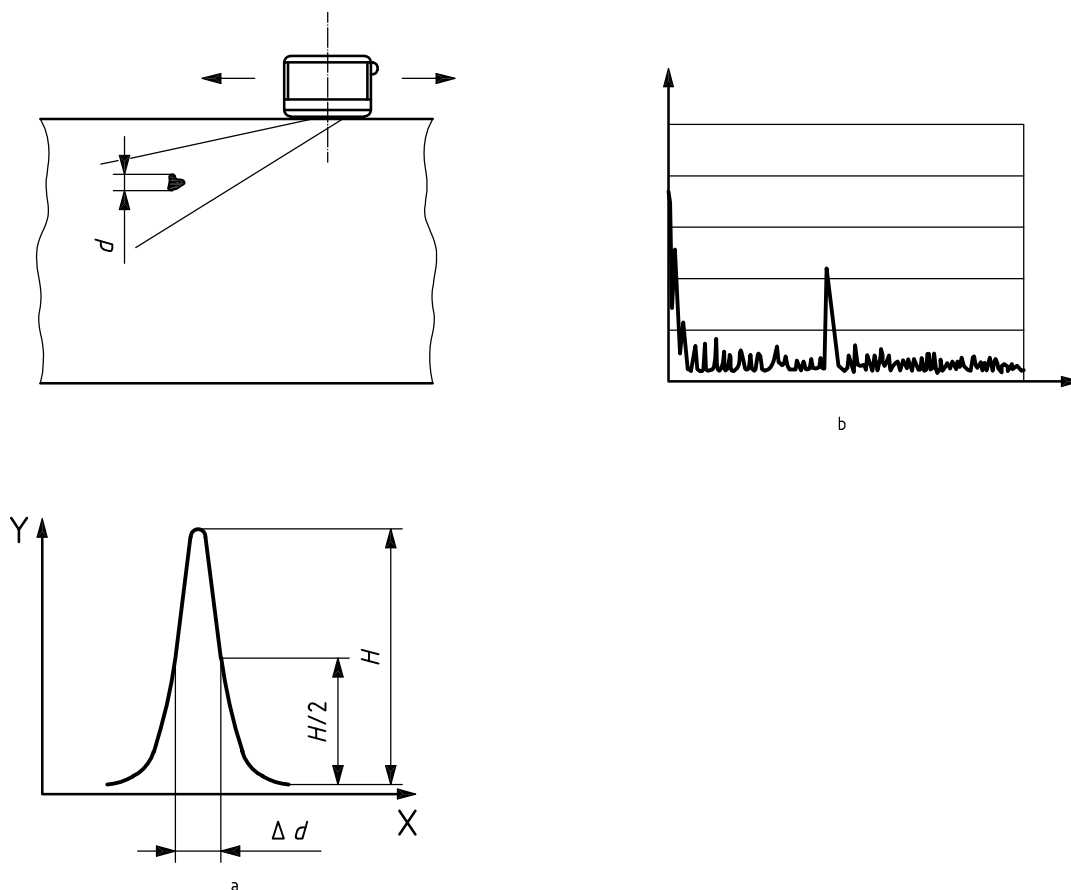

Typical indication:

Individual indication, half-value dimension  $\Delta d$  equal to or less than sound-beam diameter  $D_F$  at reflection point.

#### Key

- $d$  Dimension of indication in the through-wall direction
- $H$  Maximum echo height of individual indication
- $X$  Probe movement
- $Y$  Echo height
- a Echo dynamics.
- b A-scan.

**Figure C.4 — Individual indication without measurable dimensions; individual indication with one measurable dimension parallel to the test surface and without a measurable dimension in the through-wall direction**

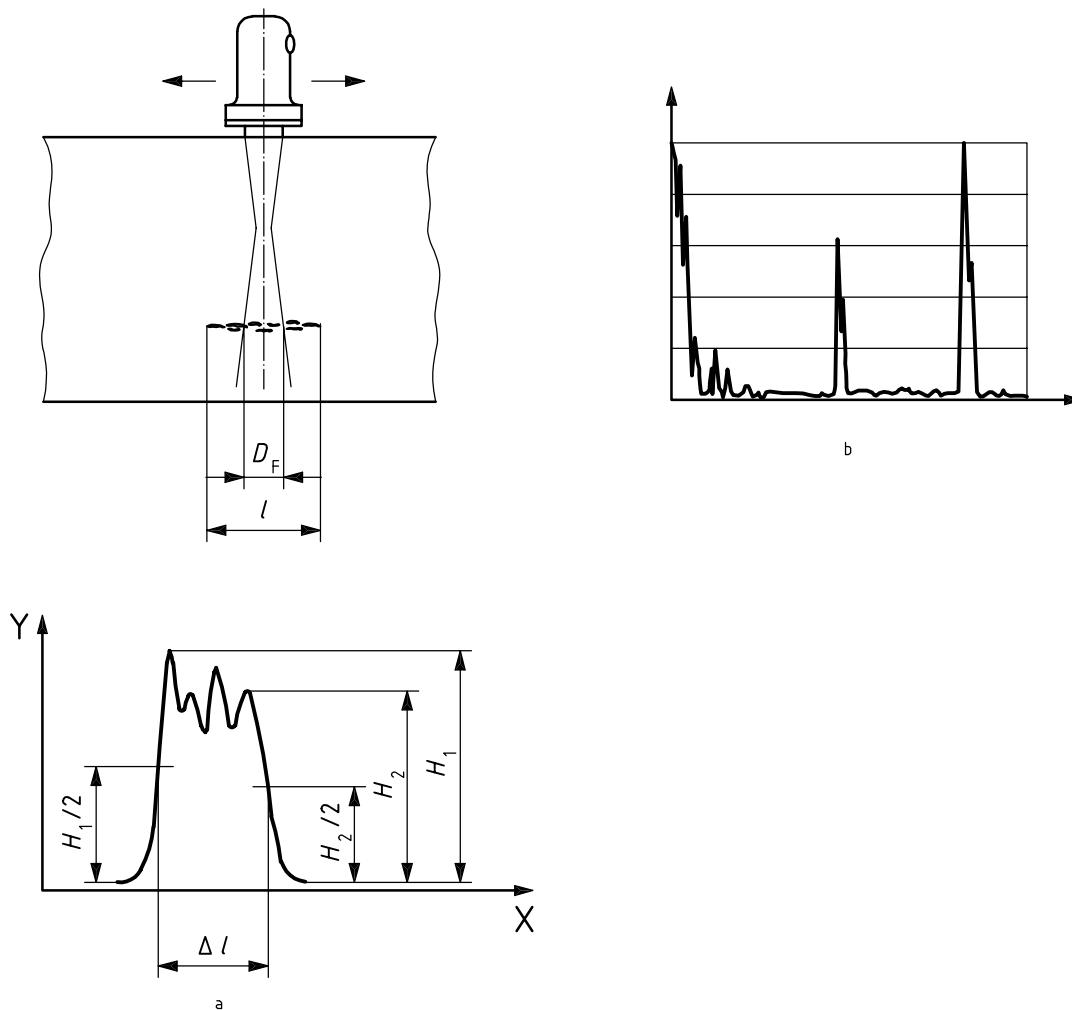

Typical indication:

Individual indication(s), mainly in the same position in the through-wall direction.

Dimension of indication range larger than the sound-beam diameter  $D_F$ .

**Key**

- $l$  Lateral extension of indication
- $\Delta l$  Half-value dimension of indication
- $H_1, H_2$  Last maximum echo heights on opposite sides of indication
- X Probe movement
- Y Echo height
- a Echo dynamics.
- b A-scan.

**Figure C.5 — Individual indication with measurable dimensions: measurable length, non-measurable width; measurable length, measurable width**

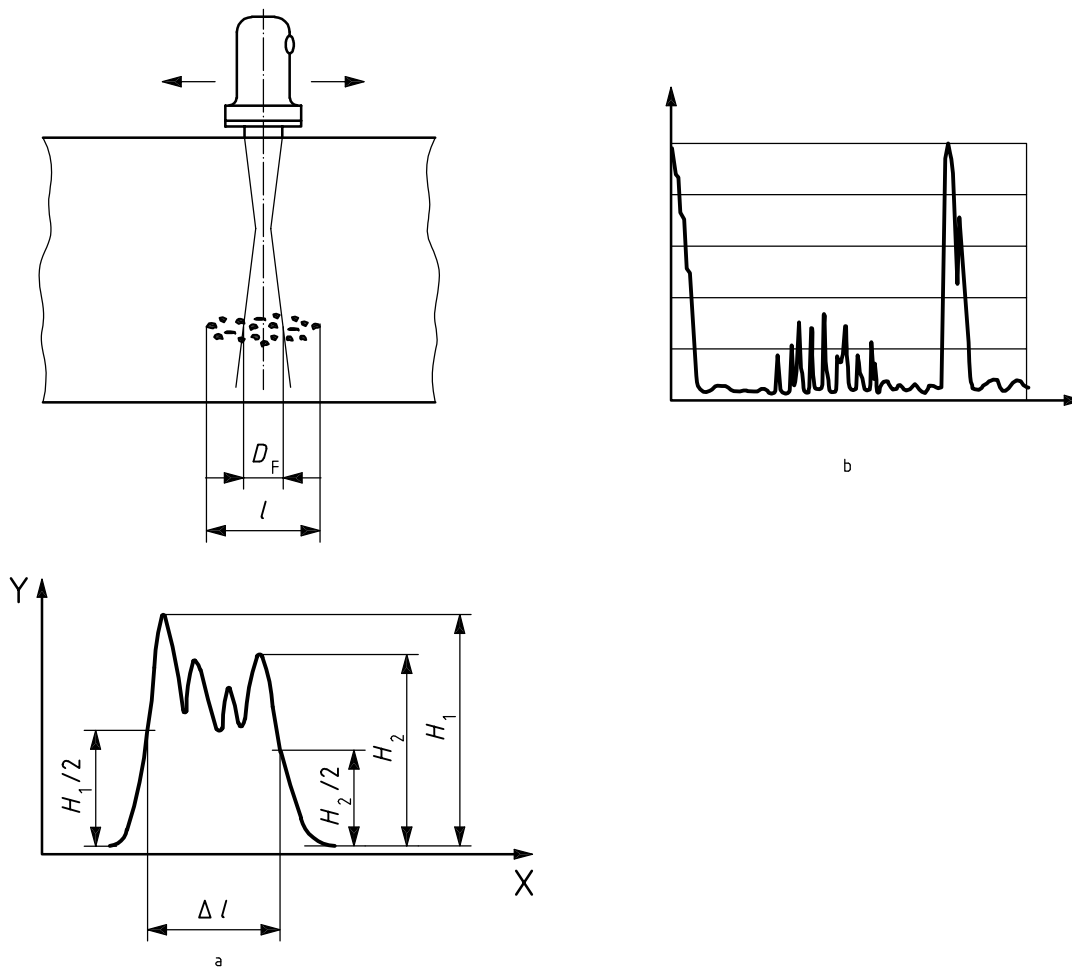

Typical indication:

Clustering of indications, mainly resolvable with non-measurable dimensions.

Dimension of indication range equal to or larger than the sound-beam diameter  $D_F$ .

**Key**

- $l$  Lateral extension of indication
- $\Delta l$  Half-value dimension of indication
- $H_1, H_2$  Last maximum echo heights on opposite sides of indication
- X Probe movement
- Y Echo height
- a Echo dynamics.
- b A-scan.

**Figure C.6 — Group of resolvable indications with measurable dimensions of the indication range**

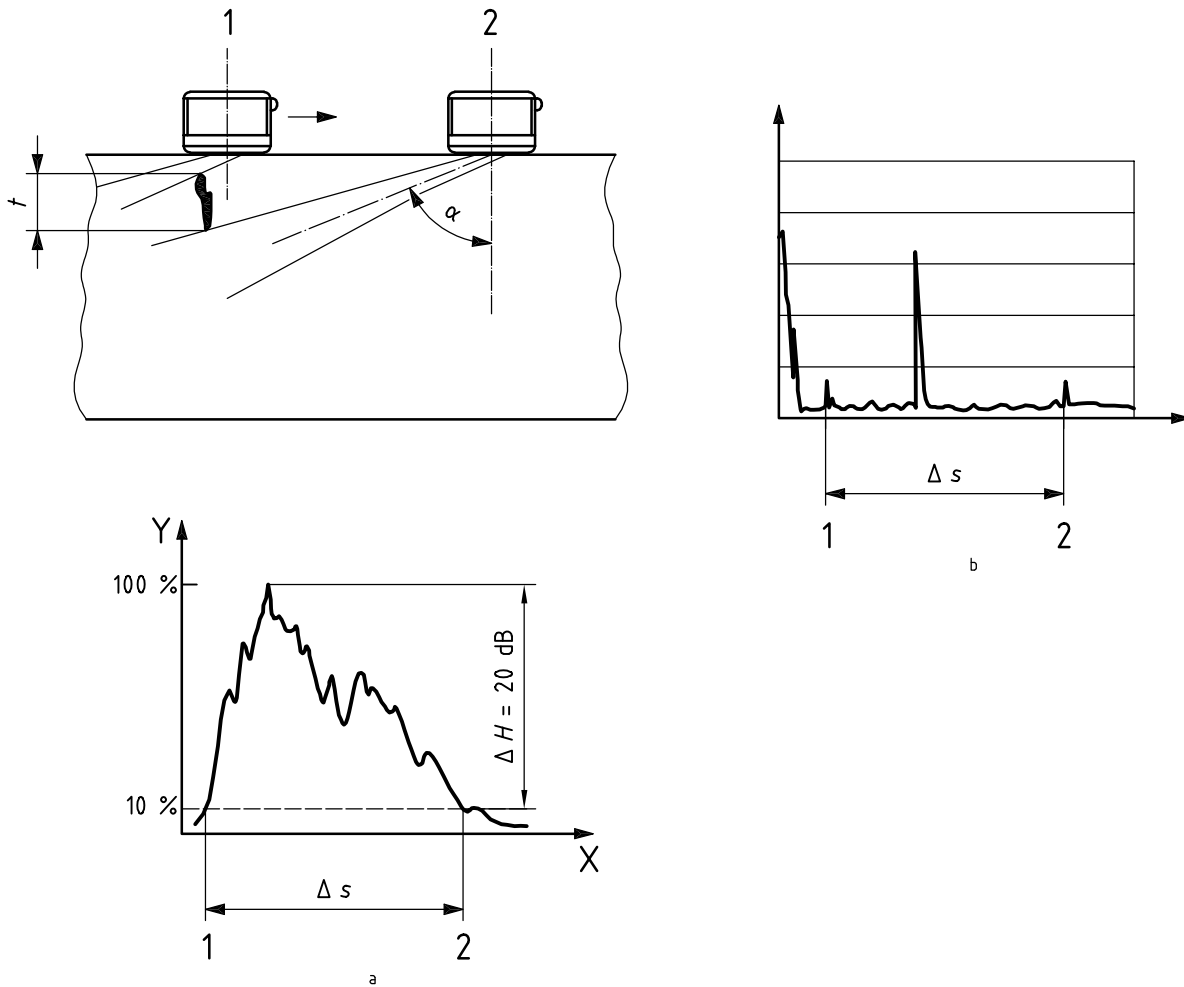

Typical indication:

Individual echo with pronounced echo dynamics only in the through-wall direction (travelling indication), or both in the through-wall direction and parallel to the test surface:

$$t = \Delta s \times \cos \alpha$$

where

$t$  is the dimension in the through-wall direction;

$\Delta s$  is the difference of sound paths from position 2 to position 1;

$\alpha$  is the angle of incidence.

**Key**

- 1 Probe position 1
- 2 Probe position 2
- $\Delta H$  Reduction of maximum echo height of indication
- X Probe movement
- Y Echo height
- a Echo dynamics.
- b A-scan.

**Figure C.7 — Individual indication with measurable dimensions in the through-wall direction**



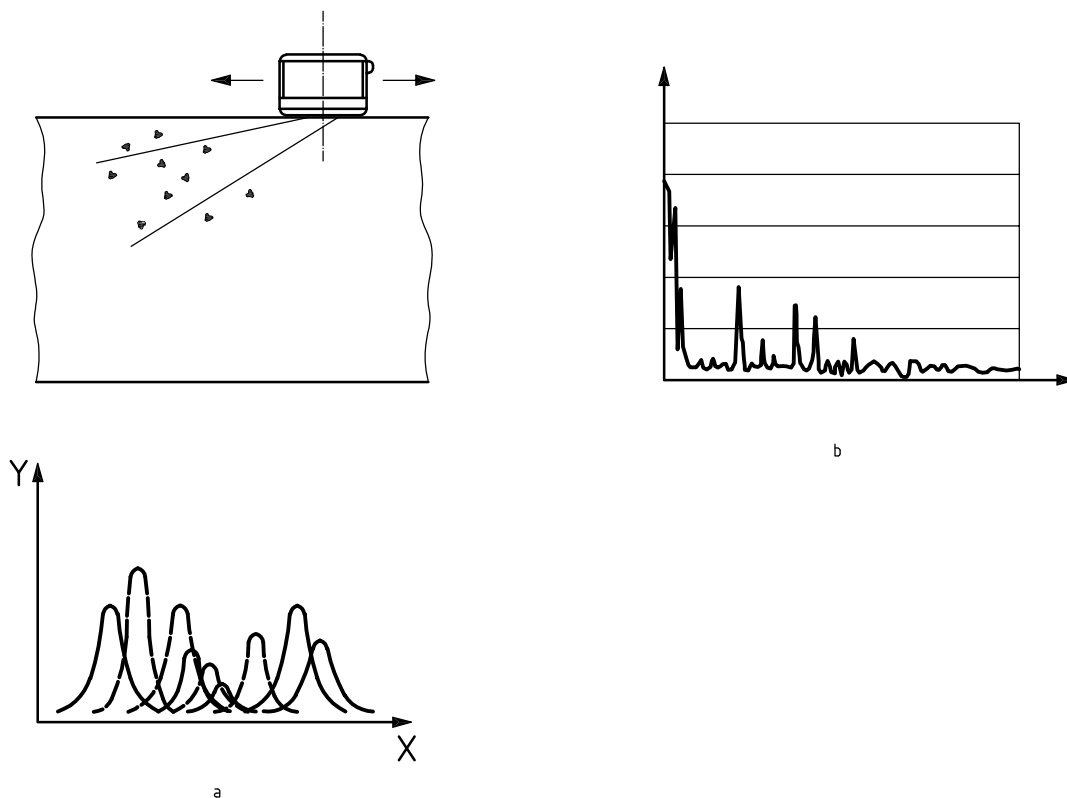

Typical indication:

Numerous individual indications.

During probe movement the sound paths change, but all indications remain without measurable dimensions.

**Key**

X Probe movement

Y Echo height

a Echo dynamics.

b A-scan.

**Figure C.8 — Numerous individual indications without measurable dimensions but with measurable dimensions of the indication range**

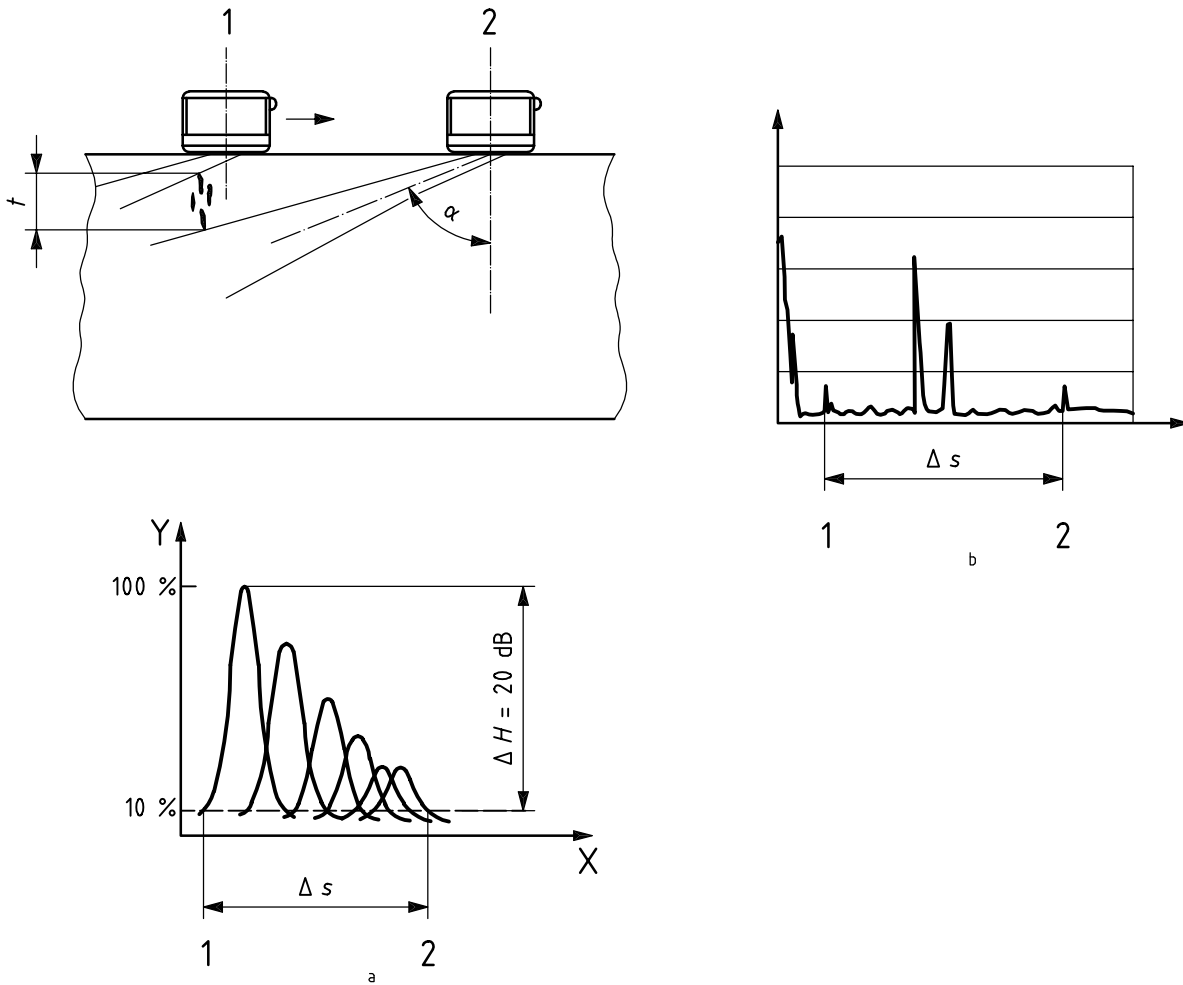

Typical indication:

Individual indications with measurable dimensions mainly in the through-wall direction:

$$t = \Delta s \times \cos \alpha$$

where

$t$  is the dimension of the indication range in the through-wall direction;

$\Delta s$  is the difference of sound paths from position 2 and position 1;

$\alpha$  is the angle of incidence.

**Key**

- 1 Probe position 1
- 2 Probe position 2
- $\Delta H$  Reduction of maximum echo height of indication
- X Probe movement
- Y Echo height
- a Echo dynamics.
- b A-scan.

**Figure C.9 — Numerous planar indications with measurable dimensions in the through-wall direction**

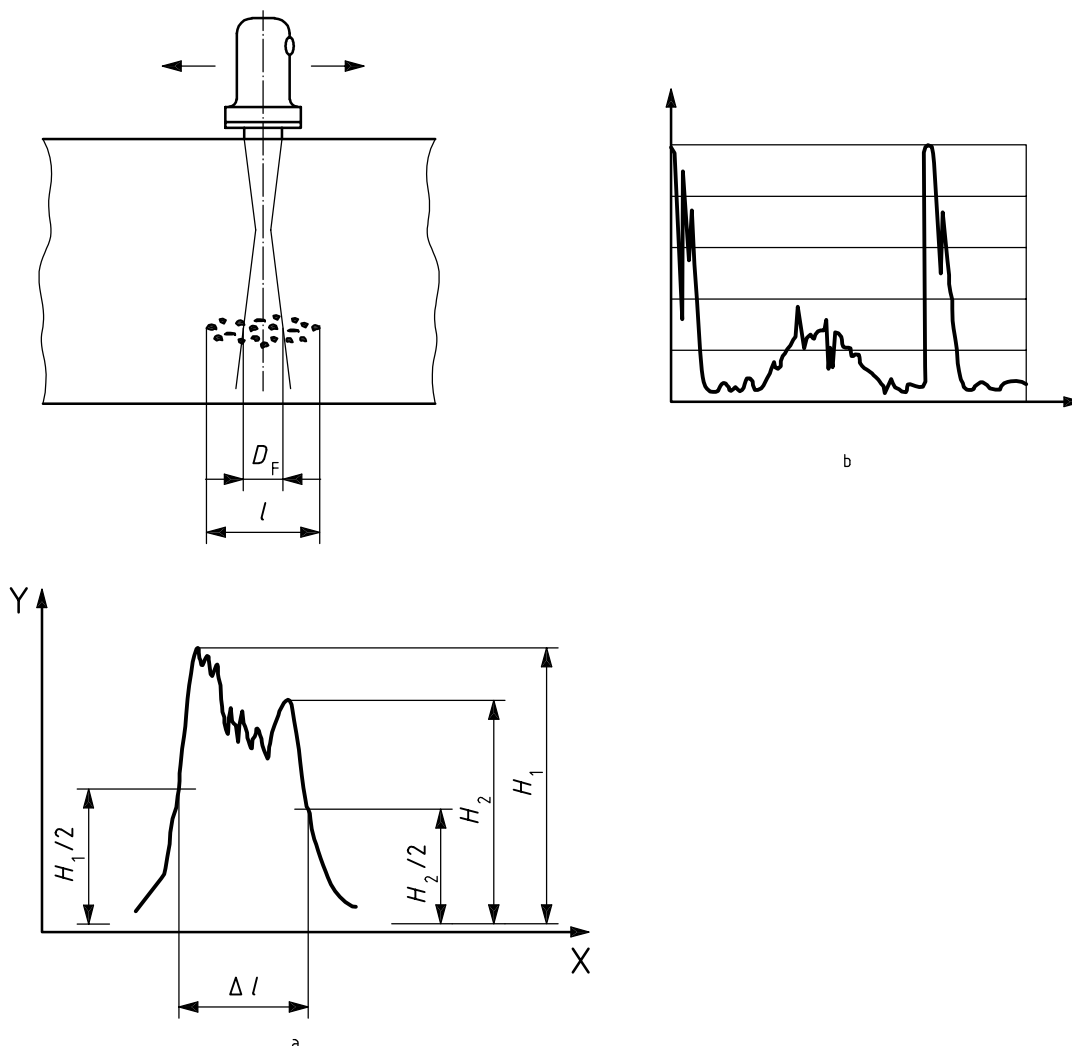

Typical indication:

Group of indications, mainly non-resolvable individual indication. Dimension of indication range equal to or larger than sound-beam diameter  $D_F$ .

This type of indication should only be evaluated if, due to geometrical reasons, a back-wall echo cannot be obtained.

A simultaneous reduction of backwall echo should be evaluated in accordance with Figure C.2.

#### Key

- $l$  Lateral extension of indication
- $\Delta l$  Half-value dimension of indication
- $H_1, H_2$  Last maximum echo heights on opposite sides of indication
- X Probe movement
- Y Echo height
- a Echo dynamics.
- b A-scan.

**Figure C.10 — Group of non-resolvable indications with measurable dimensions of indication range (normal probe)**

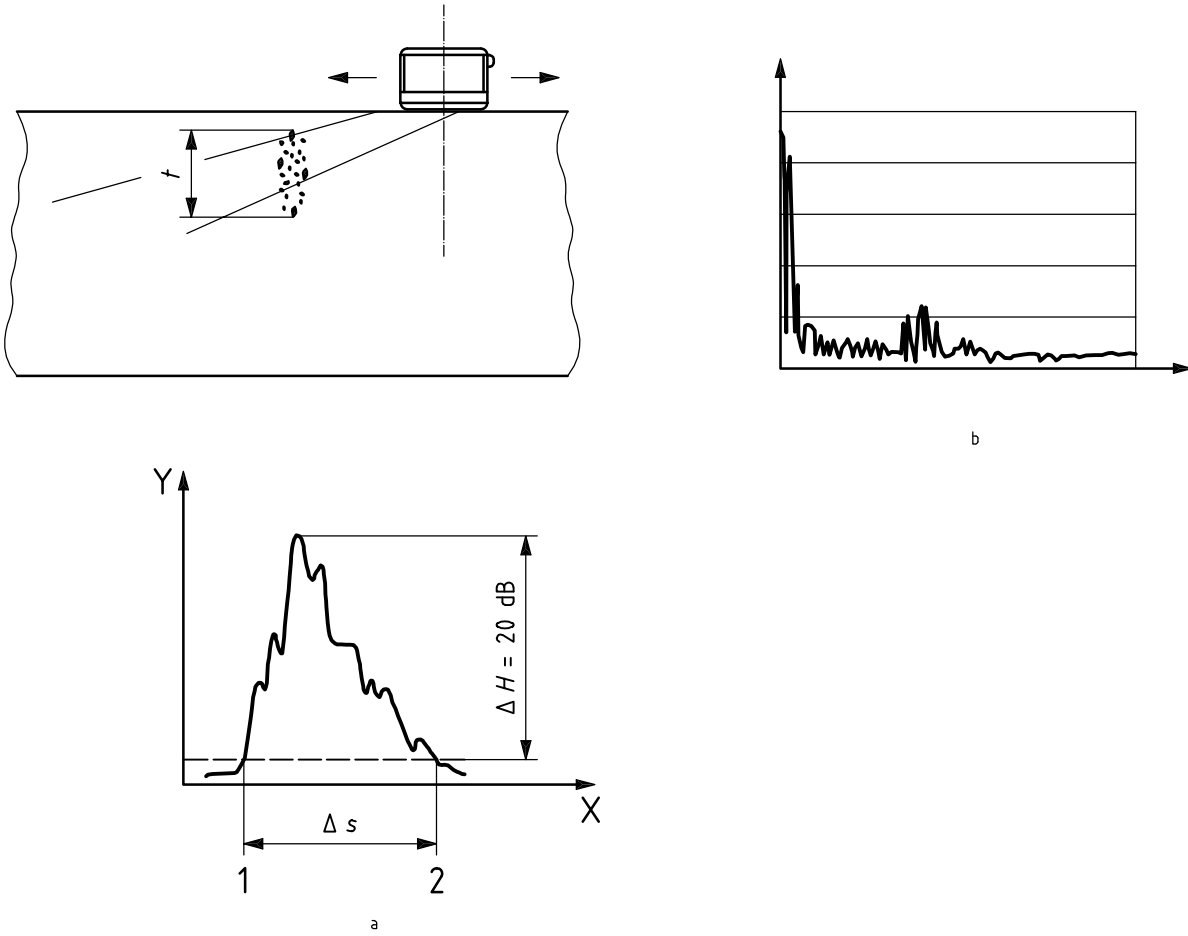

Typical indication:

Group of mainly non-resolvable indications:

$$t = \Delta s \times \cos \alpha$$

where

$t$  is the dimension of the indication range in the through-wall direction;

$\Delta s$  is the difference of sound paths from position 2 and position 1;

$\alpha$  is the angle of incidence.

**Key**

- 1 Probe position 1
- 2 Probe position 2
- $\Delta H$  Reduction of maximum echo height of indication
- X Probe movement
- Y Echo height
- a Echo dynamics.
- b A-scan.

**Figure C.11 — Group of non-resolvable indications with measurable dimensions of indication range (angle probe)**

## Bibliography

- [1] ISO 9712, *Non-destructive testing — Qualification and certification of personnel*
- [2] EN 473, *Non destructive testing — Qualification and certification of NDT personnel — General principles*
- [3] EN 1370, *Founding — Surface roughness inspection by visualtactile comparators*
- [4] EN 1559-2, *Founding — Technical conditions of delivery — Part 2: Additional requirements for steel castings*

---

---

# BSI — British Standards Institution

BSI is the independent national body responsible for preparing British Standards. It presents the UK view on standards in Europe and at the international level. It is incorporated by Royal Charter.

## Revisions

British Standards are updated by amendment or revision. Users of British Standards should make sure that they possess the latest amendments or editions.

It is the constant aim of BSI to improve the quality of our products and services. We would be grateful if anyone finding an inaccuracy or ambiguity while using this British Standard would inform the Secretary of the technical committee responsible, the identity of which can be found on the inside front cover.  
Tel: +44 (0)20 8996 9000. Fax: +44 (0)20 8996 7400.

BSI offers members an individual updating service called PLUS which ensures that subscribers automatically receive the latest editions of standards.

## Buying standards

Orders for all BSI, international and foreign standards publications should be addressed to Customer Services. Tel: +44 (0)20 8996 9001.  
Fax: +44 (0)20 8996 7001. Email: [orders@bsi-global.com](mailto:orders@bsi-global.com). Standards are also available from the BSI website at <http://www.bsi-global.com>.

In response to orders for international standards, it is BSI policy to supply the BSI implementation of those that have been published as British Standards, unless otherwise requested.

## Information on standards

BSI provides a wide range of information on national, European and international standards through its Library and its Technical Help to Exporters Service. Various BSI electronic information services are also available which give details on all its products and services. Contact the Information Centre.  
Tel: +44 (0)20 8996 7111. Fax: +44 (0)20 8996 7048. Email: [info@bsi-global.com](mailto:info@bsi-global.com).

Subscribing members of BSI are kept up to date with standards developments and receive substantial discounts on the purchase price of standards. For details of these and other benefits contact Membership Administration.  
Tel: +44 (0)20 8996 7002. Fax: +44 (0)20 8996 7001.  
Email: [membership@bsi-global.com](mailto:membership@bsi-global.com).

Information regarding online access to British Standards via British Standards Online can be found at <http://www.bsi-global.com/bsonline>.

Further information about BSI is available on the BSI website at <http://www.bsi-global.com>.

## Copyright

Copyright subsists in all BSI publications. BSI also holds the copyright, in the UK, of the publications of the international standardization bodies. Except as permitted under the Copyright, Designs and Patents Act 1988 no extract may be reproduced, stored in a retrieval system or transmitted in any form or by any means – electronic, photocopying, recording or otherwise – without prior written permission from BSI.

This does not preclude the free use, in the course of implementing the standard, of necessary details such as symbols, and size, type or grade designations. If these details are to be used for any other purpose than implementation then the prior written permission of BSI must be obtained.

Details and advice can be obtained from the Copyright & Licensing Manager.  
Tel: +44 (0)20 8996 7070. Fax: +44 (0)20 8996 7553.  
Email: [copyright@bsi-global.com](mailto:copyright@bsi-global.com).