

Mechanical vibration and shock — Vibration of fixed structures — Guidelines for the measurement of vibrations and evaluation of their effects on structures

ICS 17.160; 91.120.25

National foreword

This British Standard is the UK implementation of ISO 4866:2010. It supersedes BS 7385-1:1990 which is withdrawn.

The UK participation in its preparation was entrusted to Technical Committee GME/21/5, Mechanical Vibration, shock and condition monitoring - Vibration of machines.

A list of organizations represented on this committee can be obtained on request to its secretary.

This publication does not purport to include all the necessary provisions of a contract. Users are responsible for its correct application.

Compliance with a British Standard cannot confer immunity from legal obligations.

This British Standard was published under the authority of the Standards Policy and Strategy Committee on 30 April 2010

© BSI 2010

ISBN 978 0 580 64577 8

Amendments/corrigenda issued since publication

Date	Comments

INTERNATIONAL STANDARD

ISO
4866

Second edition
2010-03-15

Mechanical vibration and shock — Vibration of fixed structures — Guidelines for the measurement of vibrations and evaluation of their effects on structures

*Vibrations et chocs mécaniques — Vibrations des structures fixes —
Lignes directrices pour le mesurage des vibrations et l'évaluation de
leurs effets sur les structures*



Reference number
ISO 4866:2010(E)

© ISO 2010

PDF disclaimer

This PDF file may contain embedded typefaces. In accordance with Adobe's licensing policy, this file may be printed or viewed but shall not be edited unless the typefaces which are embedded are licensed to and installed on the computer performing the editing. In downloading this file, parties accept therein the responsibility of not infringing Adobe's licensing policy. The ISO Central Secretariat accepts no liability in this area.

Adobe is a trademark of Adobe Systems Incorporated.

Details of the software products used to create this PDF file can be found in the General Info relative to the file; the PDF-creation parameters were optimized for printing. Every care has been taken to ensure that the file is suitable for use by ISO member bodies. In the unlikely event that a problem relating to it is found, please inform the Central Secretariat at the address given below.



COPYRIGHT PROTECTED DOCUMENT

© ISO 2010

All rights reserved. Unless otherwise specified, no part of this publication may be reproduced or utilized in any form or by any means, electronic or mechanical, including photocopying and microfilm, without permission in writing from either ISO at the address below or ISO's member body in the country of the requester.

ISO copyright office
Case postale 56 • CH-1211 Geneva 20
Tel. + 41 22 749 01 11
Fax + 41 22 749 09 47
E-mail copyright@iso.org
Web www.iso.org

Published in Switzerland

Contents

Page

Foreword	iv
Introduction	v
1 Scope	1
2 Normative references	1
3 Terms and definitions	1
4 Source-related factors to be considered	2
5 Structure-related factors to be considered	3
6 Quantities to be measured	4
7 Frequency range and vibration amplitude	5
8 Instrumentation	5
9 Position and mounting of transducers	7
10 Data collection, analysis and assessment	10
11 Methods of measurement and reporting	12
12 Evaluation of vibration responses	14
Annex A (informative) Values of structural response	16
Annex B (informative) Classification of buildings	18
Annex C (informative) Random data	23
Annex D (informative) Predicting natural frequencies and damping of buildings	24
Annex E (informative) Vibrational interaction of the foundation of a structure and the soil	30
Bibliography	36

Foreword

ISO (the International Organization for Standardization) is a worldwide federation of national standards bodies (ISO member bodies). The work of preparing International Standards is normally carried out through ISO technical committees. Each member body interested in a subject for which a technical committee has been established has the right to be represented on that committee. International organizations, governmental and non-governmental, in liaison with ISO, also take part in the work. ISO collaborates closely with the International Electrotechnical Commission (IEC) on all matters of electrotechnical standardization.

International Standards are drafted in accordance with the rules given in the ISO/IEC Directives, Part 2.

The main task of technical committees is to prepare International Standards. Draft International Standards adopted by the technical committees are circulated to the member bodies for voting. Publication as an International Standard requires approval by at least 75 % of the member bodies casting a vote.

Attention is drawn to the possibility that some of the elements of this document may be the subject of patent rights. ISO shall not be held responsible for identifying any or all such patent rights.

ISO 4866 was prepared by Technical Committee ISO/TC 108, *Mechanical vibration, shock and condition monitoring*, Subcommittee SC 2, *Measurement and evaluation of mechanical vibration and shock as applied to machines, vehicles and structures*.

This second edition cancels and replaces the first edition (ISO 4866:1990), of which it constitutes a technical revision. It also incorporates the Amendments ISO 4866:1990/Amd.1:1994 and ISO 4866:1990/Amd.2:1996.

Introduction

The necessity for structures to sustain vibration is increasingly recognized, and requires consideration both in the design for structural integrity, serviceability and environmental acceptability, and in the preservation of historic structures.

Measurement of vibration in a structure is carried out for a variety of purposes:

- a) *problem recognition*, where it is reported that a structure is vibrating at such a level as to cause concern to occupants and equipment, possibly making it necessary to establish whether the levels warrant concern for structural integrity;
- b) *control monitoring*, where maximum permitted vibration levels have been established by an agency and those vibrations have to be measured and reported;
- c) *documentation*, where dynamic loading has been recognized in design, and measurements are made to verify the predictions of response and provide new design parameters (These may use ambient or imposed loading. Strong motion seismographs, for example, may be installed to indicate whether the responses to earthquake warrant changes on operating procedure in a structure.);
- d) *diagnosis*, where it has been established that vibration levels require further investigation, measurements are made in order to provide information for mitigation procedures (another diagnostic procedure is to use structural response to ambient or imposed loading to establish structural condition, e.g. after a severe loading, such as an earthquake).

Such diverse purposes call for a variety of measuring systems, ranging from simple to sophisticated, deployed in different types of investigations.

Technical guidance is needed by many interested parties on the most appropriate ways of measuring, characterizing and evaluating those vibrations that affect structures. This applies to both existing structures, which may be subjected to different types of excitation, and new structures erected in an environment where sources of excitation may be significant.

The effects of vibration may also be determined analytically.

Although the material in this International Standard may be used to evaluate the relative severity of structural vibration, it is not to be regarded as suggesting acceptable or non-acceptable levels. Nor does it consider economic and social aspects, which are dealt with as appropriate by national regulatory bodies.

Mechanical vibration and shock — Vibration of fixed structures — Guidelines for the measurement of vibrations and evaluation of their effects on structures

1 Scope

This International Standard establishes principles for carrying out vibration measurement and processing data with regard to evaluating vibration effects on structures. It does not cover the source of excitation except when the source dictates dynamic range, frequency or other relevant parameters. The evaluation of the effects of structural vibration is primarily obtained from the response of the structure, using appropriate analytical methods by which the frequency, duration and amplitude can be defined. This International Standard only deals with the measurement of structural vibration and excludes the measurement of airborne sound pressure and other pressure fluctuations, although response to such excitations is taken into consideration.

This International Standard applies to all structures built above or below ground. Such structures are used or maintained and include buildings, structures of archaeological and historical value (cultural heritage), bridges and tunnels, gas and liquid installations including pipelines, earth structures (e.g. dykes and embankments), and fixed marine installations (e.g. quays and wharfs).

This International Standard does not apply to some special structures, including nuclear plants and dams.

The response of structures depends upon the excitation. This International Standard examines the methods of measurement as affected by the source of excitation, i.e. frequency, duration, and amplitude as induced by any source (e.g. earthquake, hurricane, explosion, wind loading, airborne noise, sonic boom, internal machinery, traffic, and construction activities).

2 Normative references

The following referenced documents are indispensable for the application of this document. For dated references, only the edition cited applies. For undated references, the latest edition of the referenced document (including any amendments) applies.

ISO 2041, *Mechanical vibration, shock and condition monitoring — Vocabulary*

3 Terms and definitions

For the purpose of this document, the terms and definitions given in ISO 2041 and the following apply.

3.1

vibration source

simple or multiple solid, liquid or gaseous body causing vibration in its environment

[ISO 14964:2000^[8], 3.10]

3.2

vibration event

modification of existing ambient vibrations due to single or multiple sources

3.3 vibration receiver
all structures or elements of structures responding to vibration energy emitted by an internal or external source

[ISO 14964:2000^[8], 3.11]

3.4 work cycle
description and duration of a production operation used to manufacture a product or to fulfil an operation

NOTE Adapted from ISO 14964:2000^[8], 3.2.

3.5 measuring interval
(mechanical vibration and shock) minimum measurement duration that accurately represents the response of a structure excited by a known vibration

3.6 observation interval
time during which continuous or non-continuous measurements to characterize the vibration activities take place

3.7 reference interval
(mechanical vibration and shock) time period considered to include the vibration emission of interest as defined by regulation and contract

3.8 transducer sensitivity
ratio of transducer output to transducer input

3.9 measuring dynamic range
ratio, expressed in decibels, of the maximum measured amplitude to the minimum measurable amplitude of the instrument while measuring

3.10 operational dynamic range of measurement
ratio, expressed in decibels, of the contractual, regulatory or estimated maximum amplitude to the minimum measurable amplitude of the instrumentation system

3.11 dynamic range of measuring system
ratio, expressed in decibels, of the maximum amplitude to the minimum amplitude measured by a measuring instrument

4 Source-related factors to be considered

4.1 General

The source, which is the origin of the vibration event, shall be identified and described accurately to consider its characteristics when a measurement programme has to be established or when the results have to be compared to regulatory or contractual limits.

For this description, three classifications are necessary: one related to the duration of exposure; another related to the variation of amplitude with time; and a third comprising the category of the vibration signals.

4.2 Classification of events according to their duration

4.2.1 Permanent

The source emission is permanent or quasi-permanent during the selected reference interval.

4.2.2 Intermittent

A succession of events, each of relatively short duration, is separated by irregular intervals during which the vibration amplitude is equivalent to the background level.

4.2.3 Single occurrence

Sources generating vibration events, which are of short duration (a few seconds) and which can occur only once. Single occurrences do not exceed five per day.

4.3 Classification of events according to the variation of their amplitude with time

4.3.1 Stable

The variation of the amplitude with time does not exceed 10 %.

4.3.2 Cyclic

Repeated events with the same magnitude occur.

4.3.3 Other events

“Other” events cannot be classified as stable or cyclic.

4.4 Classification according to the category of signals emitted by the source

Source signal categories include:

- a) stationary (e.g. generators);
- b) non-stationary (e.g. trains);
- c) transient or impulsive vibrations with separated (e.g. blasting) or repeated impulses (e.g. forging hammers).

5 Structure-related factors to be considered

5.1 General

The reaction of structures and structural components to dynamic excitation depends upon their response characteristics (e.g. natural frequencies, mode shapes, and modal damping) and the spectral content of the excitation. Cumulative effects, especially at high response levels, and the extent of exposure where fatigue damage is possible should be considered.

5.2 Type and condition of structures

In order to describe and categorize the visible effects of vibration, a classification of the structures dealt with in this International Standard is needed. For the purposes of this International Standard, a classification of buildings is set out in Annex B.

NOTE For a classification of tunnels, see ISO 10815^[5].

5.3 Natural frequencies and damping

The fundamental natural frequency of a structure or of a part of the structure influences its response and shall be known to allow the several methods of analysis to be applied. This may be achieved by spectral analysis of low-level response to ambient excitation or by the use of artificial excitation, e.g. exciters.

Experimental studies have indicated the range of fundamental shear frequencies of low-rise structures, 3 m to 12 m high, to be from 15 Hz to 4 Hz (see Reference [26]). The damping content is generally amplitude dependent. The natural frequency and damping content of stationary structures is dealt with in Annex D.

5.4 Structure dimensions

Ground-borne vibration may have wavelengths of less than 1 m to several hundred metres. The response to excitations from shorter wavelengths is complex and the foundations may act as a filter. Smaller domestic structures generally have base dimensions that are smaller than the long wavelength which is typical for ground condition. Longer structures such as dams are more affected by larger wavelength excitations.

5.5 Influence of ground conditions

It is now common in engineering studies to take into account the influence of the soil.

An evaluation of soil-structure interaction is sometimes justified for man-made vibration; such an evaluation requires that the shear wave velocity or dynamic modulus of rigidity in an appropriate volume of ground material be determined (see Annex E). Empirical, numerical and analytical procedures may be obtained from the literature (e.g. Reference [28]).

Foundations on poor soils and fills may be subject to settlement or loss of bearing capacity due to ground vibration. The risk of such effects is a function of the particle size and shape of the soil, its uniformity of grading, compaction (which may be monitored by precise levelling), degree of saturation, internal stress state, as well as the peak multi-axial motion amplitude and duration of the ground vibration. Loose, cohesionless, saturated sands are especially vulnerable and, in extreme circumstances, may undergo liquefaction. This phenomenon shall be taken into consideration in evaluating vibrations and explaining their effects (see References [28], [29] and Annex B). For larger structures, fault line and associated differential ground conditions should be separately assessed.

The evaluation of vibration effects on a structure shall include:

- a) direct effects which result from the real-time response of a structure to induced vibrations;
- b) indirect effects which can be initiated by other factors and accelerated by vibration (construction activities, ground settlement, existing damage, water levels).

NOTE A construction activities example is an inadequately propped or braced basement excavation. This can lead to ground movement and thereby damage to the building, which is a mechanism that can be exacerbated by vibration.

6 Quantities to be measured

The characterization of both the nature of the vibration input and the response may be effected by a variety of displacement, velocity or acceleration transducers. Velocities and accelerations are kinematic quantities that are commonly measured. From knowledge of the appropriate transfer function of the sensing system, each quantity can be derived from another by integration or differentiation. It is recommended that the appropriate transducer be used to measure the required quantity directly, thus avoiding the processes of integration or differentiation. As long as the requirements on data collection, processing and presentation are met, any quantity may be measured. Experience suggests that there are preferred quantities for different situations.

CAUTION — Integration at lower frequencies calls for care and confidence in the amplitude-phase response of the transducer and measurement setup (see Clause 8) and care should be exercised when using the phase information from the velocity transducer at the lower frequencies.

Both the amplitude and phase responses of the system are critical when measuring peak quantities. In such cases, the linear performance of the entire measurement and analysis system should be validated. The signal of interest shall sufficiently exceed the electrical noise of the measuring system used, typically by a factor of 10. During measurement, the signal of interest should exceed the ambient vibration, but this is not always under the control of the investigator. If feasible, arrange for ambient vibration to be reduced where relevant (e.g. switch off mechanical plant unrelated to the source of interest).

7 Frequency range and vibration amplitude

The frequency range of interest depends upon the spectral content of the excitation and upon the mechanical response of the structure. For simplicity, this International Standard deals with frequencies ranging from 0,1 Hz to 500 Hz which cover a wide variety of structures subject to natural (winds and earthquakes) and man-made (construction, blasting, and traffic) sources of excitation. Internal machinery may require measurements over a wider frequency range.

Most structural damage from man-made sources occurs in the frequency range from 1 Hz to 150 Hz. Natural sources, such as earthquakes and wind excitation, usually contain damage-level energy at lower frequencies, in the range from 0,1 Hz to 30 Hz.

Vibration levels of interest, for analysis and characterization of structural responses, range from a few to several hundred millimetres per second depending on the frequency (Tables A.1 and A.2 show ranges of structural response for various sources and typical values and conditions of measurement).

8 Instrumentation

8.1 General requirements

Vibrations are measured for the purpose of evaluating, diagnosing or monitoring a structure. A single instrumentation system is not expected to meet all frequency and dynamic range requirements for the wide range of applications for which this International Standard can be used.

The measuring system includes:

- a) transducers (see 8.2);
- b) signal-conditioning equipment;
- c) data recording system.

The frequency response characteristics, amplitude, and phase shall be specified for the complete measurement system once it is connected as intended for use.

The accuracy of the measured vibration depends partly upon the characteristics of the equipment which shall be established by regular calibration on dates specified by the manufacturer or by regulation. Each device shall be accompanied by its calibration certificate.

At minimum, the vibration shall be characterized by a continuous measurement of the vibration amplitude, recorded over a sufficiently long time, and taken with sufficient accuracy to extract its spectral content.

8.2 Choice of transducers

The choice of transducers is important for the correct evaluation of vibratory motion. In general, transducers are divided into two groups: a) the so-called velocity transducer (geophone), widely used in structural vibration measurement, is typically of electromagnetic nature operating at frequencies above its natural frequency; and b) the piezoelectric accelerometer usually operates below its natural frequency. Other electromagnetic

transducers whose useful range is below their natural frequency, such as strong-motion seismographs, are also available.

When measuring signals of low frequencies and small amplitudes, the piezo-accelerometer output is so low that the integration result is affected by the integrator noise. In this case, use other (capacitive) types of accelerometers. It is better to use an appropriate transducer to measure the required quantity directly and avoid the process of integration or differentiation.

8.3 Signal-to-noise ratio

Generally, the signal-to-noise ratio should be not less than 5 dB. Background noise is defined as the sum of all the signals not due to the phenomenon under investigation.

8.4 Instrumentation classes

8.4.1 General

Data collection systems which are adequate for establishing even a single parameter index (e.g. peak particle velocity) may not be adequate for defining a more complex periodic motion over a specified frequency range.

For the applications dealt with in this International Standard, two main classes of measurement are considered:

- a) class 1 for engineering analysis;
- b) class 2 for field monitoring.

Instrumentation with particular parameters can be used for special applications and considered as subclasses of class 2.

8.4.2 Instrumentation class 1 for engineering analysis

The optimal parameters are:

- a) the storage capability of the instrument shall be at least 30 s per channel, at a minimum rate of 1 000 digital time samples/s — in certain cases, when the frequency of interest approaches the upper end of 500 Hz, the minimum sampling rate shall be 2 500 samples/s;
- b) the sampling shall be carried out at a frequency of at least five times the highest frequency to be analysed;
- c) for digital acquisition, the recording system shall comprise an analogue anti-aliasing filter having a minimum attenuation factor of 100 (40 dB) at half the sampling frequency;
- d) the digital data collection system shall include an indication device for observing the sampled time data as well as the processed data to help verify proper system operation;
- e) the frequency span of the entire digital data collection system shall extend from at least 1 Hz to 150 Hz (3 dB points) or wider as necessary to properly measure the frequency content of the vibration signal being encountered;
- f) the dynamic range of the measuring equipment shall be at least 72 dB;
- g) the minimum measurable amplitude of the recording system shall be at least 10 $\mu\text{m/s}$;
- h) the amplification ranges shall be such that the dynamic range of measurement (higher/lower amplitude) is more than 40 dB;
- i) the frequency response deviation of the measuring equipment in the range from 2 Hz to 80 Hz shall not exceed 8 % (0,7 dB) of the amplitude determined at the reference frequency.

8.4.3 Instrumentation class 2 for field monitoring

This category of instrumentation is used for vibration control after definition of major parameters by engineering analysis or to monitor known vibration phenomena. The frequency and amplitude characteristics are determined by the results obtained by the engineering analysis and, if necessary, by contractual or regulatory obligations. The optimal parameters are:

- a) the dynamic range of the measuring equipment shall be at least 66 dB;
- b) the operational dynamic range of the measurement shall be at least 20 dB;
- c) the frequency response deviation of the measuring equipment in the range from 2 Hz to 80 Hz shall not exceed 8 % (0,7 dB) of the amplitude determined at the reference frequency;
- d) the monitoring equipment shall record and report vibration events that exceed the designated threshold amplitude — the following recorded information shall be reported immediately after detection of an event:
 - 1) the maximum amplitude value,
 - 2) date and time of the starting event.

8.4.4 Instrumentation for special applications

For some special applications, alternative optimal required parameters can be used for class 2 only:

- a) lowering the sampling rate when monitoring tall buildings and bridges;
- b) reducing the length of each recording segment when monitoring brief events such as blasting;
- c) increasing the sampling rate and amplitude range when monitoring vibration waves propagating in concrete structures and hard rock.

9 Position and mounting of transducers

9.1 Position, number and orientation of transducers

9.1.1 General

The choice of number and position of transducers shall consider:

- a) any contractual or regulatory obligations;
- b) the object of measurement;
- c) the type of structure monitored, its state, its geometry, its dynamic response;
- d) the foundation system and soil-foundation interaction;
- e) the distance between the source and the measuring points;
- f) the energy and vibratory mode generated by the source.

9.1.2 Position of transducers

Transducer placement in a structure depends on the vibration response of concern. Assessment of the vibrations being input to a structure from ground-borne sources is best undertaken using measurements on or

near the foundation. The soil-foundation transfer function can be evaluated by adding measuring points on the ground.

Determination of structural racking or of shear deformation of the structure as a whole requires measurements directly on the load-bearing members. This usually means several components of measurement on foundation, substructure and superstructure corners, although other arrangements are possible.

Sometimes, specific motions are of concern (floor, wall, bridge, ceiling) with maximum amplitudes at mid-span locations. Although sometimes very severe, these mid-span vibrations are usually unrelated to structural integrity (see Reference [31]).

Where measurements related to equipment are to be made, the measurement should consider the incoming vibration. The point of measurement should be placed on the structure at the entrance point of vibration and on the frame of the equipment. In this case, the equipment should, if possible, be switched off for the measurement.

Vibration measurements made on or below the ground surface may be affected by the variation of the surface wave amplitude with depth. Structure foundations may then be exposed to a motion which is different from the one observed on the ground surface depending on the wavelengths, foundation depths, and geotechnical conditions (see E.4).

9.1.3 Number of transducers

The proper characterization of the vibration of a structure requires a number of measurement positions which depend upon the size and complexity of the structure.

Where the purpose is to monitor imposed vibration, the preferred position is at the foundation. When measurements on the foundation itself are not possible, it is normal to make the measurements at a low point on the main load-bearing external wall of the ground floor. The number of transducers depends upon the dimension of the structure.

Measurements of the vibration response due to sources at great distances (traffic, pile-driving and blasting) show that the vibration may be amplified within the structure in proportion to its height and depth (see Annex E). Therefore, it is necessary to carry out simultaneous measurements at several points within the structure.

Where a structure is taller than 12 m, additional measurement points should be used every 12 m or at the highest floor of the structure.

Where a structure is more than 10 m long, measuring points should be added at appropriate intermediate positions and at critical points on the structure (at least three: two at extremities and one at the centre).

Simultaneous measurements on the foundation and the ground outside allows a transfer function to be established.

Additional measurement points on floors are required to evaluate human response.

NOTE For investigations using an analytical approach, the point of evaluation depends upon the modes of deformation considered. For economic reasons, most practical cases are limited to the identification of the fundamental modes and the measurement of the maximum responses in the whole structure, together with observations on structural elements such as floors and walls.

9.1.4 Orientation of components

Where ground-transmitted vibration measurements are to be made, it is usual to orient the horizontal sensors along the direction defined as the line joining the source and the sensor. When studying structural response to ground vibration, it is more realistic to orient these horizontal sensors along the major and minor axes of the structure.

For wind-induced vibration, vertical motion components are often ignored and the vibration transducers should be oriented to sense horizontal and rotational motions.

9.2 Mounting of transducers

9.2.1 General

The aim should be to reproduce faithfully the motion of the element or substrate without introducing additional response.

9.2.2 Coupling to structural elements

The mounting of vibration transducers to vibrating elements or substrate should comply with ISO 5348^[3].

As the mass of the transducer and monitoring unit (if any) of up to 10 % of that of the structure element on which it is mounted leads to significant change of its modal behaviour, the mass of the measuring equipment shall not be greater than 1 % of that of the structure.

The transducer mounting can be secured to the frame of the structure by expansion bolts. Gypsum joints are preferred when taking measurements on lightweight concrete elements.

Measurements on floors having compliant coverings tend to give distorted results and should be avoided. Where it is not possible to relocate the transducers, comparative measurements with different mass and coupling conditions for the mounting block should be made to evaluate the effect of the compliant coverings, or special adaptors should be used (see DIN 45669-2^[16]).

Brackets shall be avoided. It is better to fix three uniaxial transducers to three faces of a metal cube rigidly mounted by means of studs or quick-setting, high-modulus resin. In special circumstances, it is acceptable to glue the transducer or attach it using magnetic attraction. For measurements on indoor horizontal surfaces, double-sided adhesive tape may be used on all hard surfaces for accelerations below 1 m/s², although mechanical fixtures are preferred.

9.2.3 Coupling to the ground

Where transducers have to be mounted in the ground, in order to minimize coupling distortion, they should be buried to a depth at least three times the main dimension of the transducer/mounting unit (see DIN 45669-2^[16]). Alternatively, they can be fixed to a rigid plate with a mass ratio,

$$\frac{m}{\rho r^3}$$

of not more than 2, where

m is the mass of the transducer and plate;

r is the equivalent radius of the plate;

ρ is the bulk density, in kilograms per cubic metre, of the soil.

The rigid plate may, for example, be a well-bedded paving slab. For most soils and rock, the bulk density, ρ , ranges from 1 500 kg/m³ to 2 600 kg/m³.

Soil conditions permitting, the transducer may be fixed to a stiff steel rod (having a diameter of not less than 10 mm), driven through a loose surface layer. This rod should not project more than a few millimetres above ground surface. Care should be taken to ensure close contact between the transducer and the ground. In cases where acceleration greater than 2 m/s² is expected, ensure that the ground mounting is firm to prevent slippage. In many cases, this coupling method is not reliable for measurement in the horizontal direction.

10 Data collection, analysis and assessment

10.1 General

The aim is to acquire sufficient information to enable the selected method of analysis to be carried out with a sufficient degree of confidence. The amount of information required to characterize vibration properly increases from simple periodic to non-stationary random and transient motion.

10.2 Description of data

Any data resulting from the observation of a physical process can broadly be described as deterministic or random. Deterministic data can be described by an explicit mathematical function, while random data are only evaluated through statistical functions.

Figure 1 illustrates categories of the types of data that may be encountered. Descriptions of the categories are given in ISO 2041.

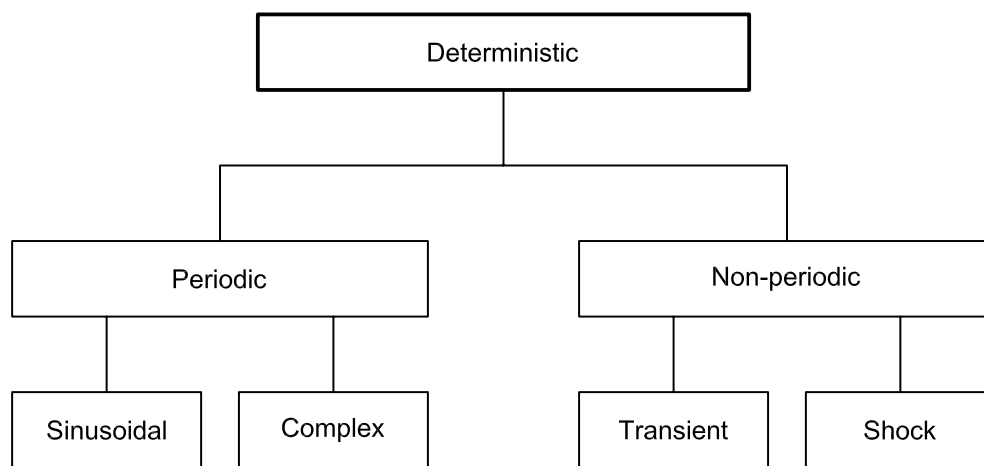

a) Deterministic data

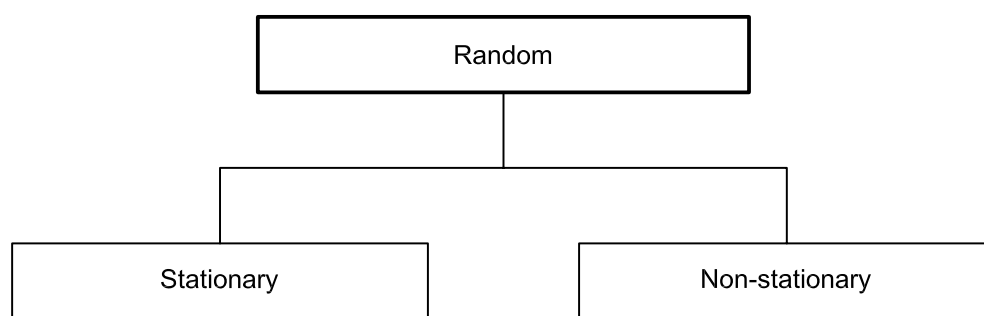

b) Random data

Figure 1 — Types of data

10.3 Measurement duration

The measurement duration depends on the category of the vibration event and the reference, observation and measurement time intervals. Observation and measurement intervals are given in Table 1.

Table 1 — Observation and measurement time intervals

Event type	Vibration source	Event category	Observation time interval	Measurement time interval	Examples of source
Permanent	known or unknown	stable	1 h	30 s	electric generator
		cyclic	three cycles	three cycles not adjacent	forging hammer
		other	one selected day	determined by amplitude-dependent triggering	heavy car traffic
Intermittent	unique	cyclic	at least three complete cycles	one complete cycle or maximum amplitude by triggering	piling
		stable	according to its working mode	one event or 30 s	refrigerating group
		other	according to its working mode	determined by amplitude-dependent triggering	crushing mill, compactor
	multiple	each type of source shall be treated according to the criteria defined for a unique source	one selected day	event duration	train traffic
Isolated or single	unique		one event	one event	blasting

EXAMPLE For intermittent sources, like piling, the reference interval is a typical day representing the source action and the observation interval is at least three complete work cycles (a cycle being the complete driving of a pile); the measurement intervals are determined by amplitude-dependent triggering, see Figure 2.

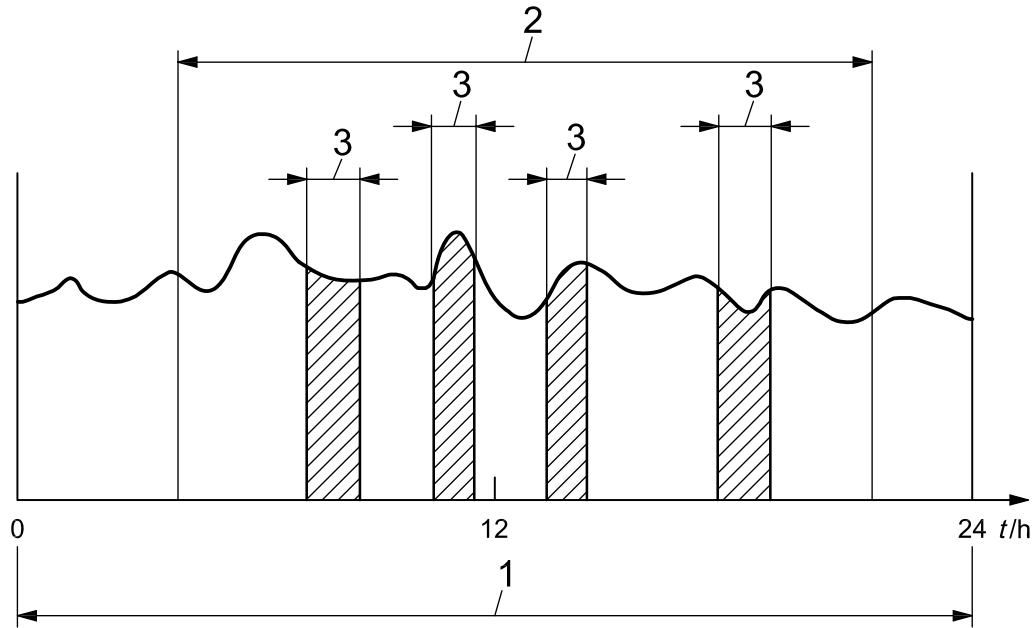

Key

- t time
- 1 reference interval
- 2 observation interval
- 3 measurement intervals

Figure 2 — Measurement intervals

11 Methods of measurement and reporting

11.1 General

The method of evaluation should reflect both the purpose of those measurements and the type of investigation.

A full response analysis for predictive purposes requires information on structural details and conditions not usually readily available. An investigator should, therefore, have an appropriate method of assessing the severity of vibration of a structure or a component with regard to the probability of damage. In such an assessment, the following factors shall be taken into account:

- a) natural frequencies of the basic structure and its components (walls, floors, windows);
- b) damping characteristics of the basic structure and its components;
- c) type of construction, its condition and material properties;
- d) characteristics of excitation;
- e) deflected form;
- f) non-linearity in amplitude response.

Two methods of measurement are defined, the first concerns engineering analysis and the second concerns field monitoring in the conditions fixed by the engineering analysis method or contractual and regulatory obligations.

11.2 Engineering analysis

When complex structures of vital importance are subjected to vibration magnitudes whose consequences are taken into serious consideration, the structural behaviour should be assessed in a more detailed way.

Instrumentation of class 1 should be mounted at a number of locations to ensure that specific values for that structure are not exceeded.

If the ground-to-foundation transfer function is of concern, simultaneous recording outside and on the foundation should be made. The recording on the foundation is made at a point in the basement or other key element of the structure.

The number of measurement points and their locations shall be defined and modified according to the characteristics of the structure and the observations made during the monitoring process.

The natural frequencies of structures should be determined, if possible.

In the case of vibration which can be reproduced for a sufficient amount of time, the same transducers can be used for the various points, keeping a reference point at the foundation level near the source.

For structures of vital importance, response analysis should be carried out as well as an estimate of structure loading. A full engineering analysis requires a system which would enable the frequency to be estimated within $\pm 0,5$ % and damping within ± 20 % due to the complexity in determination.

11.3 Field quality monitoring

A field quality monitoring system should consist of a limited number of the monitoring locations already used in the engineering analysis. The dominant vibration parameters are already established.

The survey is to assess the vibration severity in comparison with the values stipulated in codes and regulations or established during the engineering analysis.

11.4 Reporting of control activities

The report style should be consistent with the type of investigation, but the report should include at least the following:

- a) general information:
 - 1) description of the source,
 - 2) type and condition of the structure, in accordance with Annex B,
 - 3) purpose of the measurement,
 - 4) reference to the standard being used and type of investigation,
 - 5) ground conditions;
- b) measurements:
 - 1) position of transducer and manner of coupling,
 - 2) type and manufacturer of transducer, signal-conditioning and recording equipment,
 - 3) calibration methods and dates for the instrumentation system,
 - 4) frequency range and linearity,

- 5) assessment of the sources of error,
 - 6) for monitoring or survey investigation, it may be sufficient to make continuous registration of peak particle velocity values,
 - 7) for further investigation, time history records should be made available;
- c) structure inspection:
- 1) inspection of structures before exposure to vibration, with graphical and/or photographic reporting of cracks and other damage, including dilapidation survey,
 - 2) inspection of the same structures after exposure to vibration,
 - 3) evaluation of observed damage;
- d) reference to other relevant International Standards.

12 Evaluation of vibration responses

12.1 Evaluation for prediction

An existing structure may be exposed to a new source of vibration, external or internal, and some assessment of the expected vibration response is needed. Given sufficient information about the characteristics of the input and the properties of the structure, numerical analyses, using any of the well-known techniques of response spectra, Fourier spectrum or time-step integration (see Reference [35]), can be used. Alternatively, a characteristic index, such as the kinematic quantities displacement, velocity or acceleration (see 12.3), can be related to the expected performance using empirical data appropriate to the type of structure (see Reference [28]).

Vibrations are conveniently represented in the frequency domain by response spectra, widely used in engineering. In most cases, the response characteristics of the structure are ill defined although dynamic test procedures are now available (see Reference [27]).

12.2 Evaluation of the vibration in existing structures

The evaluation of vibration in existing structures may be carried out at different levels of sophistication consistent with the investigative procedures. Indications of vibration severity may be in terms of stresses or kinematic quantities. In some cases, the direct observation of crack opening or structure damage provide information on the response and may indicate progressive deterioration (see DIN 4150-3^[15] and Reference [35]).

12.3 Kinematic quantities as indices of vibration severity in structures

For several decades, studies have been carried out to relate the vibration severity in terms of a quantity, such as peak displacement, velocity or acceleration, related to visible effects on structures. Where measurements are made on a component, a kinematic quantity, such as peak velocity, can be expressed as a stress and, in turn, related in structural terms to the allowable value of the stress. When the kinematic quantity refers to rigid-body structural response, measured at some chosen position, the response frequency and damping of the structure as well as duration of the input affect the vibration severity. The kinematic quantity is then an empirical index and shall be qualified by the kind of structure to which it refers (see 4.4)

Some account of these factors is embodied in the use of the peak spectral acceleration or velocity as a damage index, applicable to low-rise structures (one to three storeys high) and whole-structure response (see DIN 4150-3^[15], References [26], [31]).

The dependence of severity rating upon both the spectral response of the structure and the frequency content of the excitation is also recognized in the empirical correlations which strictly apply to structures with a limited range of fundamental frequency in shear, and identify different severity ratings in different frequency bands. A broad guide to vibration values of interest is given in Table A.1.

12.4 Probabilistic aspects

There is increasing evidence that the criteria relating vibration to visible effects on structures (cosmetic, minor, and major damage) should be approached in a probabilistic way because of the uncertainty of modelling and measurement.

For possible combinations of age and condition of a structure, it may not be possible to establish an economical absolute lower limit.

Some national (e.g. DIN 4150-3^[15], NS 8141^[17], Reference [18]) and international (e.g. ISO 4356^[2]) documents offer guidance maximum limit values to ensure the safety of buildings. These limit values take into consideration:

- a) the category of the building;
- b) the category of the vibration events;
- c) the frequency range.

This is particularly the case where either a peak kinematic value (usually particle velocity) of ground motion within a specified frequency band, or a peak spectral acceleration or displacement, is being used as an index of damage potential. Minimal risk for a named effect is usually taken as a 95 % probability of no effect.

The evaluation of the response of a structure or component may be assisted by measurements of local strain or relative displacement (e.g. crack monitoring), although this would not constitute a measure of vibration status, because of other factors like settlement.

12.5 Fatigue factors

Repeated stress reversal over many cycles carries a risk of increasing fatigue failure. For steel, reference can be made to appropriate design codes. Such guidance is not available for concrete, masonry and other structural materials, for which reference is necessary to research work. Long-term, low-level vibration amounting to 10^{10} load reversals may have to be taken into account for special structures, monuments, etc. (see Reference [36]).

12.6 Description of damage

12.6.1 General. For the purposes of this International Standard, the damage is classified into the categories described in 12.6.2 to 12.6.4.

12.6.2 Cosmetic. The formation of hairline cracks on drywall surfaces (see ISO 4356^[2] and Reference [40]), or the growth of existing cracks in plaster or drywall surfaces; in addition, the formation of hairline cracks in mortar joints of brick/concrete block construction.

12.6.3 Minor. The formation of large cracks or loosening and falling of plaster or drywall surfaces, or cracks through bricks/concrete blocks.

12.6.4 Major. The damage to structural elements of the structure, cracks in support columns, loosening of joints, splaying of masonry cracks, etc.

NOTE The description of damage has its equivalent in the intensity scales used by seismologists.

Annex A (informative)

Values of structural response

Table A.1 — Ranges of structural response for various sources

Vibration source	Frequency range ^a Hz	Amplitude range µm	Particle velocity range mm/s	Particle acceleration range m/s ²	Time characteristic
Traffic road, rail, ground-borne	1 to 100	1 to 200	0,2 to 50	0,02 to 1	C ^b /T ^c
Blasting vibration ground-borne	1 to 300	100 to 2 500	0,2 to 100	0,02 to 50	T
Air over pressure	1 to 40	1 to 30	0,2 to 3	0,02 to 0,5	T
Pile driving ground-borne	1 to 100	10 to 50	0,2 to 100	0,02 to 2	T
Machinery outside ground-borne	1 to 100	10 to 1 000	0,2 to 100	0,02 to 1	C/T
Machinery inside	1 to 300	1 to 100	0,2 to 30	0,02 to 1	C/T
Human activities inside	0,1 to 30	5 to 500	0,2 to 20	0,02 to 0,2	T
Earthquakes	0,1 to 30	10 to 10 ⁵	0,2 to 400	0,02 to 20	T
Wind	0,1 to 10	10 to 10 ⁵	—	—	T
Acoustic (inside)	5 to 500	—	—	—	C/T
<p>NOTE 1 The ranges quoted are extreme, but they still indicate the values which may be experienced and which may have to be measured (see also Note 2). Extreme ranges of displacement amplitudes and frequencies have not been used to derive particle velocities and accelerations. Values lower than 0,2 mm/s can also be considered. For building security and human annoyance, these values may be insignificant, but for sensitive equipments they are significant.</p> <p>NOTE 2 Vibration values within the given ranges may cause concern. There are no standards which cover all varieties of structures, conditions and durations of exposure, but many national codes associate the threshold of visible (or otherwise noticeable) effects with peak particle velocities at the foundation of a structure of more than a few millimetres per second. A significant damage is linked to peak particle velocities of several hundred millimetres per second. Vibration levels below the threshold of human perception may be of concern in delicate and industrial processes.</p>					
<p>^a Ranges quoted refer to the response of structures and structural elements to a particular type of excitation and are indicative only.</p> <p>^b Continuous.</p> <p>^c Transient.</p>					

Table A.2 — Examples of values of structural responses for various sources
(according to French experience)

Vibration source	Frequency Hz	Amplitude mm/s	Measuring location	Distance m
Blasting demolition	75 to 120	2,7	main structure foundation	10 to 20
	5 to 11	4,3		
	5 to 7	2,5	main structure foundation	
	86	2,1	main structure foundation	
	6	4,8		
	89	2,1	main structure foundation	
	7	8,7		
	95 to 107	2,2	main structure foundation	
	9 to 14	13,4		
	7	3,5	main structure foundation	
	7	1,5	main structure foundation	
	8	0,7	main structure foundation	
	10	1,7	main structure foundation	
	10	1,4	main structure foundation	
	7	2,1	main structure foundation	
	7	1,8	main structure foundation	
	9	2,8	terrace	
	8	3,4	2nd basement	
	9	2,1	2nd basement	
	8	5,7	ground floor	
9	10,0	ground floor		
7	6,1	basement		
7	5,2	basement		
7	5,4	ground floor		
6	7,2	ground floor		
7	15,1	terrace		
8	7,2	ground floor		
Forging hammers	10 to 25	0,8	main structure foundation	30
	6 to 20	0,2	main structure foundation	
	8 to 10	2,5	main structure foundation	
Quarry blasting	28	3,3	main structure foundation	200
	36	3,7	main structure foundation	
	27	1,8	main structure foundation	
Petroleum vibrators	26	6,1	main structure foundation	6,5
Mass pile driving	10 to 20	1,6	foundation	14
	10 to 20	2,0	flooring tile	14
Vibrating pile driving	20	2,6	foundation	14
	20	4,3	flooring tile	14
Concrete cruncher	3	7,5	5th floor	10
Rock breaker	35	9,9	5th floor	15
Road traffic	10 to 15	0,2 to 1,0	main structure foundation	5 to 10
	12 to 20	0,4 to 0,6	floor	
	12 to 15	2,0 to 2,5	main structure foundation	
	12 to 15	2,5 to 3,5	floor	
	10	1,0 to 1,3	main structure foundation	
	17	3,5 to 5,3	floor	
	11 to 13	1,0	floor	
	3 to 4	1,0 to 1,4	main structure foundation	
	3 to 4	1,5 to 2,1	floor	
	9 to 12	0,5 to 1,2	main structure foundation	
	9 to 12	0,5 to 1,2	floor	
10 to 15	1,2 to 1,7	main structure foundation		
10 to 45	0,5 to 1,5	main structure foundation		
10 to 20	0,2	main structure foundation		
10 to 20	0,4 to 2,0	centre of paving stone		
Railway traffic	35	1,5 to 2,0	main structure foundation	10 to 20
	8 to 50	2,0 to 3,0	main structure foundation	
	60	2,0	main structure foundation	
	10	0,5	main structure foundation	
	51	1,9	main structure foundation	
	20	2,2	main structure foundation	
90 to 110	2,5	main structure foundation		

Annex B (informative)

Classification of buildings

B.1 General

This annex provides simplified guidelines for classifying buildings according to their probable reaction to mechanical vibration transmitted by the ground.

For the purposes of this classification, a dynamic system consists of the soil and strata on which the foundations are set, together with the building structure itself.

Table B.2 gives 14 simplified classes taking into consideration the following factors:

- a) type of construction (as ascertained from Table B.1);
- b) foundation (see B.5);
- c) soil (see B.6);
- d) political importance factor.

The frequency range is taken from 1 Hz to 150 Hz (see also Clause 7), which covers most events found in industrial practice, blasting, piling, and traffic. Shock directly introduced into the structure by industrial machinery is not included, though its effects at some distance are. Shocks produced by blasting, piling and other sources outside the strict confines of the structure are not included, but the effects on the structure are. The buildings referred to exclude structures with more than 10 storeys.

B.2 Structures involved

B.2.1 Structures included in the classification

These are:

- a) all buildings used for living and working (houses, offices, hospitals, schools, prisons, factories, etc.);
- b) publicly used buildings (town halls, churches, temples, mosques, heavier industrial mill-type buildings, etc.);
- c) ancient, historical and old buildings of architectural, archeological and historical value;
- d) lighter industrial structures, often designed to the codes of building practice.

B.2.2 Structures excluded from the classification

These are:

- a) heavier structures such as nuclear reactors and their adjuncts and other heavy power plants, rolling mills, heavier chemical engineering structures, all types of dams, and storage structures for fluids and granular materials, e.g. water towers and tanks, petroleum storage, grain and other silos;
- b) all underground structures;
- c) all marine structures.

B.3 Definition of classes

The classes are defined with reference to a building in good repair (see Table B.2). The reference building shall not have any constructional defects nor shall it have sustained accidental damage. If the construction does not fulfil these requirements, it shall be allocated to a lower class.

The order in which the structural types are classified depends on their resistance to vibration, and also on the tolerances that can be accepted for the vibrational effects on structures, given their architectural, archeological and historical value.

Three elements enter into the reaction of a structure under the effects of mechanical vibration:

- a) the category of the structure (Table B.1 gives a preliminary classification of the structure categories based on the groups defined in B.4);
- b) the foundation (see B.5);
- c) the nature of the soil (see B.6).

B.4 Categories of structures

B.4.1 Group 1: Ancient and historical buildings or traditionally built structures

The types of buildings considered in this group can be divided into the following two subgroups:

- a) ancient, historical or old buildings;
- b) modern buildings constructed in older, traditional style using traditional kinds of materials, methods and workmanship.

Generally, this group is of heavier construction and has a very high damping coefficient due, for example, to soft mortar or plaster. This group also includes traditionally resilient structures in earthquake zones. Buildings in this group seldom have more than six storeys.

B.4.2 Group 2: Modern buildings and structures

The types of buildings considered in this group are all of modern structure using relatively hard materials connected together in all directions, usually lightweight overall, and with a low damping coefficient.

This group includes frame buildings as well as calculated load-bearing wall types. Buildings vary from single to multistorey. All types of cladding are included.

B.5 Categories of foundations

B.5.1 Class A

Class A includes the following types:

- linked reinforced concrete and steel piles;
- stiff reinforced concrete raft;
- linked timber piles;
- gravity retaining wall.

B.5.2 Class B

Class B includes the following types:

- independent reinforced-concrete piles that are usually connected only at their pile caps;
- spread wall footing;
- timber piles and rafts.

B.5.3 Class C

Class C includes the following types:

- light retaining walls;
- large stone footing;
- strip foundation;
- plate foundation;
- no foundations (walls directly built on soil).

B.6 Types of soil

Soils are classified into:

- type a: unfissured rocks or fairly solid rocks, slightly fissured, or cemented sands;
- type b: horizontal bedded soils, very firm and compacted non-cohesive soils;
- type c: horizontal bedded soils, poorly compacted firm and moderately firm non-cohesive soils, firm cohesive soils;
- type d: all types of sloping surfaces with potential slip planes;
- type e: loose non-cohesive soils (sands, gravels, boulders), soft cohesive soils (clays), organic soils (peat);
- type f: fill.

Table B.1 — Categorization of structures according to the building group

Category of structure		Group of building (see B.4)	
		1	2
← Resistance to vibration decreasing	1	Heavy industrial multistorey buildings, five to seven storeys high, including earthquake-resistant forms Heavy structures, including bridges, fortresses, ramparts	Two- and three-storey industrial, heavy-frame buildings of reinforced concrete or structural steel, clad with sheeting and/or infilling panels of block work, brickwork, or precast units, and with steel, precast or <i>in situ</i> concrete floors Composite, structural steel and reinforced-concrete heavy industrial buildings
	2	Timber-frame, heavy, public buildings, including earthquake-resistant forms	Five- to nine-storey (and more) blocks of flats, offices, hospitals, light-frame industrial buildings of reinforced concrete or structural steel, with infilling panels of block work, brickwork, or precast units, not designed to resist earthquakes
	3	Timber-frame, single and two-storey houses and buildings of associated uses, with infilling and/or cladding, including “log cabin” and earthquake-resistant forms	Single storey moderately lightweight, open-type industrial buildings, braced by internal cross-walls, of steel or aluminium or timber, or concrete frame, with light sheet cladding, and light panel infilling, including earthquake-resistant types
	4	Fairly heavy multistorey buildings, used for medium warehousing or as living accommodation varying from five to seven storeys or more	Two-storey, domestic houses and buildings of associated uses, constructed of reinforced block work, brickwork or precast units, with reinforced floor and roof construction, or made wholly of reinforced concrete or similar, all of earthquake-resistant type
	5	Four- to six-storey houses and buildings of associated urban uses, made with block work or brickwork, load-bearing walls of heavier construction, including “stately homes” and small palace-style buildings	Four- to ten-storey domestic and similar buildings, constructed mainly of lightweight load-bearing block work and brickwork, calculated or uncalculated, braced mostly by internal walls of similar material, and by reinforced concrete, preformed or <i>in situ</i> floors at least on every other storey
	6	Two-storey houses and buildings of associated uses, made of block work or brickwork, with timber floors and roof Stone- or brick-built towers, including earthquake-resistant forms	Two-storey domestic houses and buildings of associated uses, including offices, constructed with walls of block work, brickwork, precast units, and with timber or precast or <i>in situ</i> floors and roof structures
	7	Lofty church, hall, and similar stone- or brick-built, arched or “articulated” structures, with or without vaulting, including arched smaller churches and similar buildings Low heavily constructed “open” (i.e. non-cross-braced) frame church and barn-type buildings including stables, garages, low industrial buildings, town halls, temples, mosques, and similar buildings with fairly heavy timber roofs and floors	Single- and two-storey houses and buildings of associated uses, made of lighter construction, using lightweight materials, prefabricated or <i>in situ</i> , separately or mixed
	8	Ruins and near-ruins and other buildings, all in a delicate state All class 7 constructions of historical importance	—

Table B.2 — Classification of buildings according to their resistance to vibration and the tolerance that can be accepted for vibrational effects

Class of building ^a	Category of structure (see Table B.1)								
	1	2	3	4	5	6	7	8	
Categories of foundations (upper case letter) and types of soil (lower case letter) (see B.5 and B.6)									
← Level of acceptable vibration decreasing	1	A a							
	2	A b	A a	A a	A a				
	3		A b B a	A b B a	A b	A a A b			
	4		A c B b	B b	A c	A c B a B b			
	5		B c	A c		B c	B a		
	6		A f		A d	B d	B b C a	B a	
	7			A f	A e	B e	B c C b	B b C a	
	8						B e C c	B c C b	
	9		B f				C d	B d C c	A a
	10			B f			C e	B e C d	A b
	11				C f	C f		C e	B a
	12						C f		B c C a
	13							C f	B d C b C c
	14								C d C e C f

^a High class number = high degree of protection required

Annex C (informative)

Random data

C.1 General

Random data may be encountered in practice (wind loading, crusher machinery). Spectral analysis techniques can be used to estimate response characteristics. The estimate may be more or less precise depending on the structural characteristics (frequency and damping of a selected mode) and the precision required of the analysis (see Reference [34]). With stationary data two kinds of error, bias and variance, are involved (see Reference [34]). The choice of recording duration depends on the permissible errors chosen. If bias error is to be 4 % and variance error 10 %, for example, the recording duration, t_r , in seconds, may be calculated using Equation (C.1) which does not include overlaps of the individual measurement samples and therefore gives the maximum recording duration:

$$t_r = \frac{200}{\eta f_n} \quad (\text{C.1})$$

where

η is the modal damping ratio;

f_n is the natural frequency, in hertz, of a given mode, n .

EXAMPLES If $\eta = 1\%$ of critical (i.e. 0,01) and $f_n = 1$ Hz, then a recording duration of 20 000 s is needed to estimate the bias and variance errors selected above. If $\eta = 2\%$ of critical and $f_n = 10$ Hz, a recording duration of 1 000 s is needed. Acceptance of higher errors reduces the required recording duration. These requirements are independent of the type of equipment used for analysis.

Structural damping is dealt with in Annex D.

Non-stationary random data present special problems and reference should be made to the literature (see, for example, References [33], [34]).

The analysis of random data is conducted in one of two domains, frequency or time, and these are considered in C.2 and C.3.

C.2 Frequency domain

In general vibration analysis, the quantity most often used is the power spectral density (PSD). In the analysis of structural vibration, the amplitude spectral density itself may be presented. Other types of analyses in this domain include transfer function, cross-PSD, coherence function, and quadratic spectral density. These results are presented as the physical quantity squared per hertz versus frequency, or as dimensionless numbers and ratios of physical quantities.

C.3 Time domain

In the time domain, covariance, autocorrelation, cross-correlation, and covariance analyses may be carried out. The autocorrelation function, which is the inverse transform of the power spectrum, is the most commonly used. Many of the quantities in the time domain can be used with deterministic data. However, the more complex functions are often used with random data. Time-domain analysis covers mean, root-mean-square, peak counting, zero crossing counting as well as probability density, probability distribution, skewness and kurtosis.

Annex D (informative)

Predicting natural frequencies and damping of buildings

D.1 Introduction

The main body of this International Standard specifies methods of measuring structure response including fundamental natural frequencies. When direct measurements cannot be made or are limited in usefulness by high damping, subcomponent resonances or other practical problems, it becomes necessary to estimate natural frequency and damping values.

This annex offers guidance on the ways in which the fundamental natural frequency and associated damping value may be assessed. It draws attention to the uncertainties involved, which should be taken into account wherever an estimation of fundamental natural frequencies of a structure is used in measuring or evaluation procedures.

D.2 Predicting natural frequencies of tall buildings using empirical methods

There are many empirical formulae for predicting the frequency, f , or period, T , of the fundamental translation mode; of these the simplest is $f = 10/n$ Hz (i.e. $T = 0,1 n$ s), where n is the number of storeys. Various other expressions for the period, T , in seconds, are given in the codes of different countries and these can be grouped into three categories:

$$T = k_1 h \quad (\text{D.1})$$

where

h is the height, in metres;

k_1 is a coefficient, which ranges from 0,014 to 0,03 (see References [42] to [45]).

$$T = \frac{k_2 h}{\sqrt{b}} \quad (\text{D.2})$$

where

b is the width, in metres, parallel to force;

h is the height, in metres;

k_2 is a coefficient, which ranges from 0,087 to 0,109 (see References [43] and [46]).

$$T = \frac{k_3 h}{\sqrt{b}} \sqrt{\frac{h}{h+b}} \quad (\text{D.3})$$

where

b is the width, in metres, parallel to force;

h is the height in metres;

k_3 is a coefficient, which ranges from 0,06 to 0,08 (see, for example, Reference [47]).

Reference [48], considering a sample of 163 rectangular-plan buildings, recommends $f = 46/h$ Hz (i.e. $T = 0,022 h$ s) for the fundamental translation mode.

Figure D.1 shows the resulting fit of the curve $f = 46/h$ Hz to the data and it can be appreciated that large errors are likely to be encountered. It can be seen that errors of $\pm 50\%$ are not uncommon, and this is typical of the accuracy which can be expected using empirical formulae.

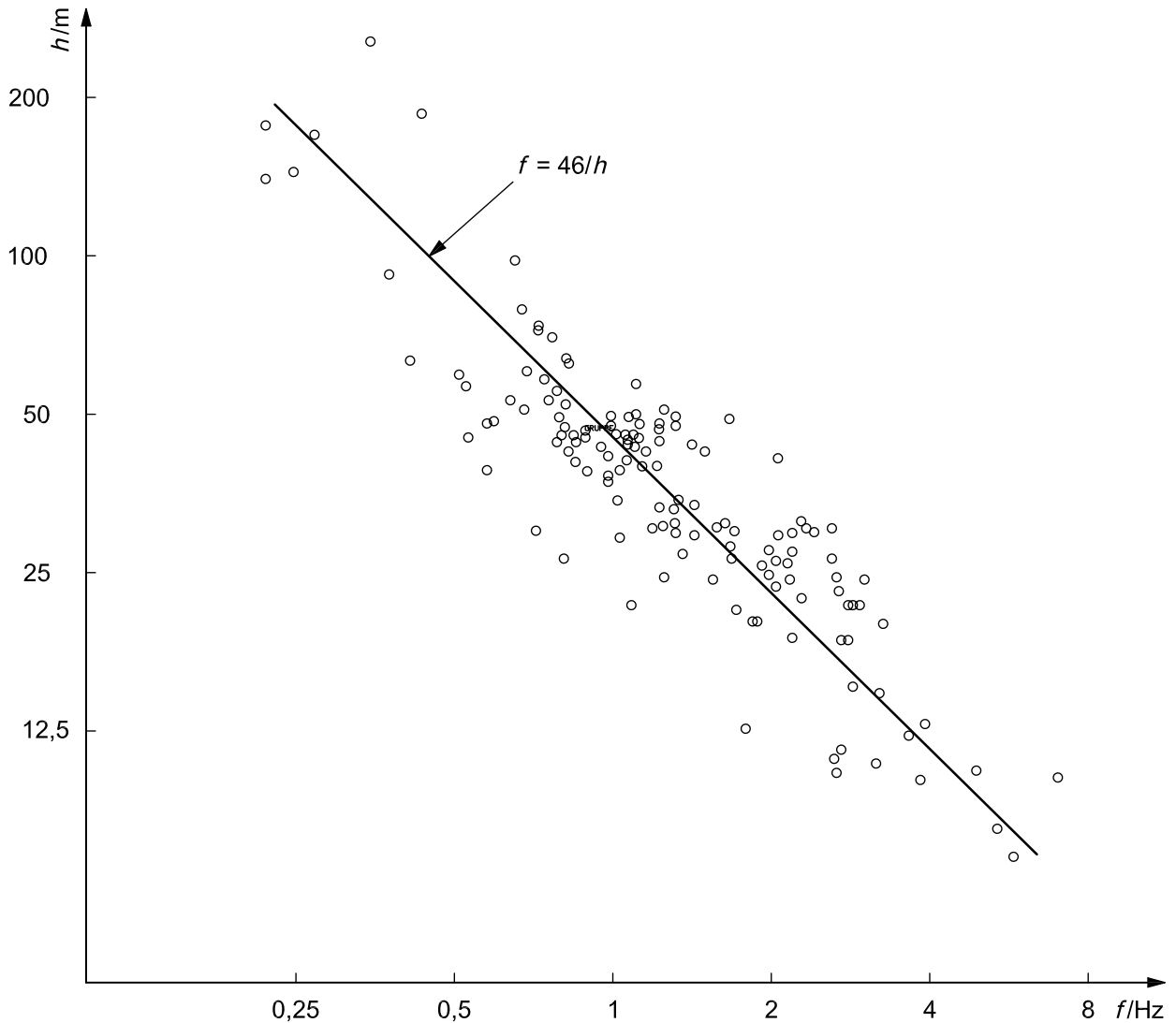

Key
f frequency
h building height

Figure D.1 — Plot of height versus fundamental frequency for 163 rectangular-plan buildings using logarithmic scales

D.3 Predicting natural frequencies of tall buildings using computer-based methods

It has long been realized that comparatively large errors are likely to occur using the simple empirical formulae, but it has also been generally accepted that a satisfactory estimate of frequency can be obtained using one of the standard computer-based methods. However, buildings are complicated structures and it is not a simple task to create an accurate mathematical model; consequently, note that these models only provide approximate predictions. Reference [48] examines published evidence, which indicates that the correlation between computed frequencies and measured frequencies is actually considerably worse than the correlation between the frequencies predicted using $f = 46/h$ Hz and the measured values. This discrepancy can be attributed to inadequacies in modelling the real properties of buildings. Predictions of fundamental frequencies should therefore be treated with caution.

Special methods have been developed for analysing core buildings (see ESDU 81036^[20]), shear buildings (see ESDU 79005^[19]) and sway frame and frame buildings (see ESDU 82019^[21]), but, as with any method, it is necessary to check whether the method has been calibrated using a range of reliable experimental data and to understand which errors are likely to be encountered. If the method has not been proven, then accuracies greater than those obtained for empirical predictors should not be assumed. Only the fundamental frequencies have been discussed, but the predicted frequencies of higher frequency modes are subject to similar or (more probably) greater errors. This means that, except for special cases where the mathematical model has been tuned to experimental results, it is necessary to regard predictions involving many calculated modes as unreliable.

D.4 Predicting damping values of tall buildings

The damping (or rate of energy dissipation) in any one mode limits the motion in that mode and, consequently to estimate the building response to a given load, it is necessary to estimate or measure the amount of damping. No proven methods of predicting damping exist and the measured data show that damping values between 0,5 % and 2,1 % critical can occur (see Figure D.2). Higher values may also be encountered in buildings where soil-structure interaction is significant. Simple steel frames are likely to have much lower damping. Methods of predicting damping have been developed (see ESDU 83009^[22] and Reference [49]) but, again, the expected accuracy is not quoted.

Figure D.2 shows a plot of damping versus building height for a selected sample of buildings (see Reference [50]). It can be seen that large differences in damping are obtained for orthogonal translation modes of the same building. Damping is partly a function of the construction procedures and workmanship involved and cannot be predicted accurately. Consequently, anticipate large errors in estimation.

NOTE Countries are encouraged to add their expertise to establish an actual synopsis of damping values.

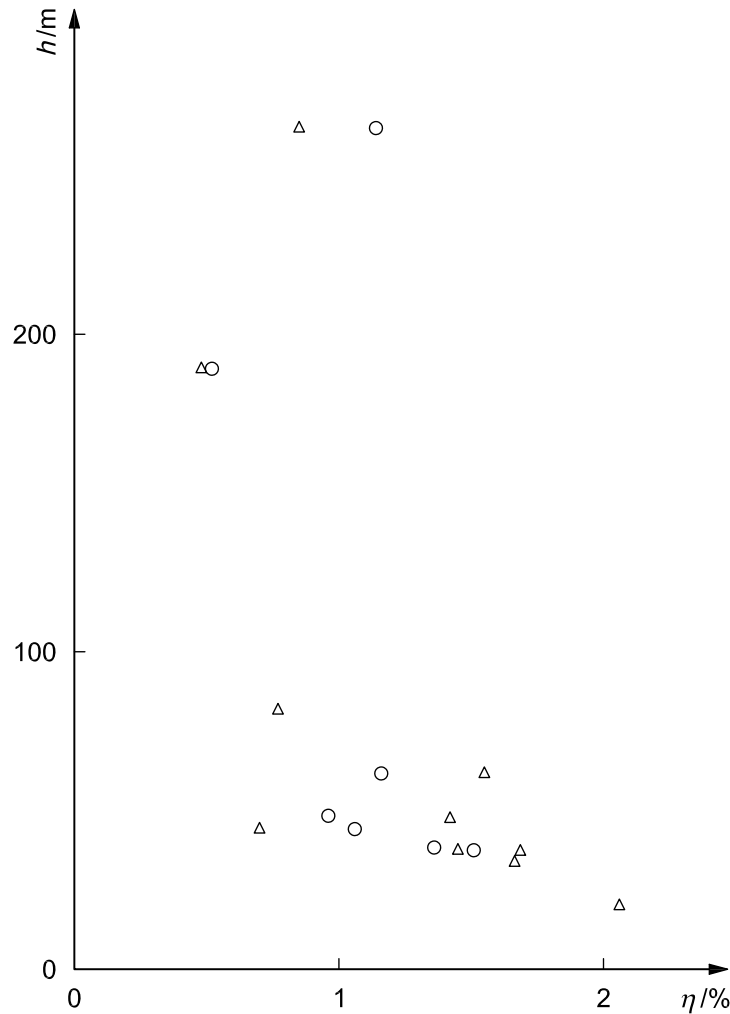

Key

- h building height
- η damping ratio, critical
- Δ lowest frequency mode
- \circ orthogonal mode

Figure D.2 — Building height versus damping ratio for the fundamental translation modes of ten buildings where soil-structure interaction was negligible (from decay measurement)

D.5 Natural frequencies and damping values in low-rise buildings

The characteristics of 96 low-rise buildings are presented in References [26] [31]. The buildings were located in the USA and are described as one-, one-and-a-half-, and two-storey buildings with basements, partial basements or crawl spaces. The data show that the average measured frequency decreases with building height (See Figure D.1).

Figure D.3 shows a histogram relating the number of buildings to their measured frequencies. Note the range of frequencies which is encountered and thus the error involved in using an empirical prediction. There is no obvious tendency for the frequencies to vary with the age or location of the houses, and there is no correlation of the frequencies with plan dimensions.

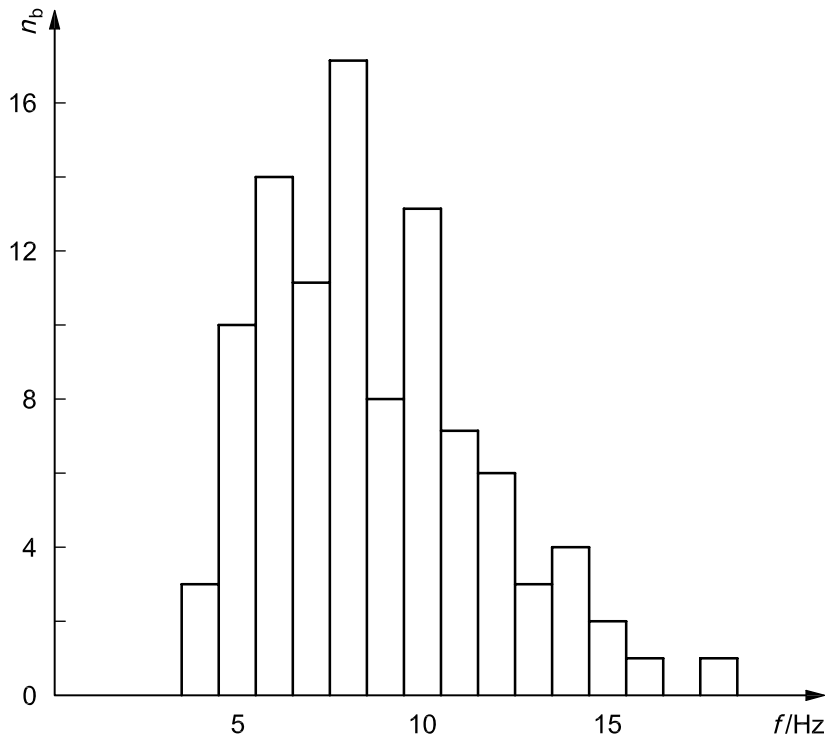

Key

- f frequency
- n_b number of buildings

Figure D.3 — Frequencies measured in 96 low-rise buildings

Figure D.4 shows a histogram relating the number of buildings to their damping ratios. This indicates generally higher damping ratios than for taller buildings and shows the range of damping values which may be encountered. No obvious relationship between damping and building geometry exists.

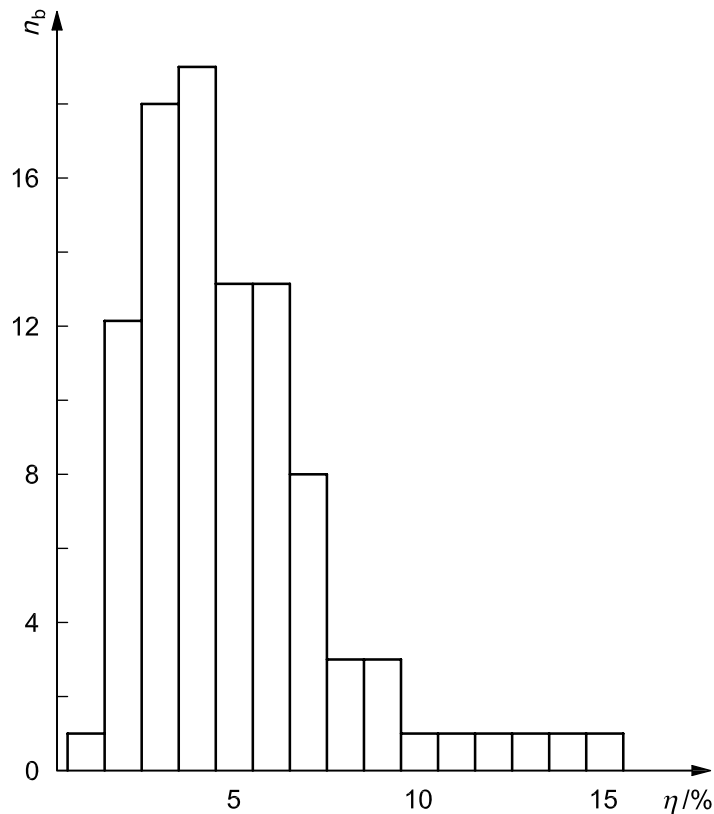

Key

- n_b number of buildings
- η damping ratio, critical

Figure D.4 — Damping ratios measured in 96 low-rise buildings

D.6 Non-linear behaviour

The previous clauses discuss the natural frequency and the damping of each mode and this might give the impression that these quantities are invariant. However, they do vary with amplitude of motion and for earthquake analyses this might be important (albeit difficult to quantify). In general, wind loading induces small-amplitude motion (in comparison with large earthquakes) and the changes in natural frequency and damping over the range of amplitudes normally encountered is small. In one building, which was subjected to forces equivalent to a range of winds from light to hurricane force, changes of 3 % in frequency and 30 % in damping were recorded (see Reference [50]). It can be appreciated that these changes are perhaps not significant and can be ignored for design purposes.

D.7 Final comment

The general conclusion which can be reached from this annex is that theoretical predictions are likely to involve considerable inaccuracies. Consequently, theoretical analyses should consider these possible inaccuracies by carrying out parametric variation and, for important structures, the design calculations should be verified using experimental measurements when the structure is complete.

Annex E (informative)

Vibrational interaction of the foundation of a structure and the soil

E.1 General

It may be necessary to predict the response of a proposed building to vibration. In this case, there is a need to understand the dynamic interaction of a building and the ground.

The response of the foundation of the building may be expected to follow closely the motion of the ground in contact with the foundation unless interaction is significant. This annex seeks to indicate the nature of such an interaction and suggests procedures which allow it to be taken into account.

Figure E.1 illustrates the notation used in this annex in terms of the peak amplitude, u , of a travelling wave passing across a foundation (u can be the displacement, velocity or acceleration amplitude of the sinusoidal wave). Free-field amplitude is denoted by u_0 , amplitude in the base of the foundation by u_F , amplitude at an arbitrary position in the structure by u_{st} , and on the soil surface near an existing building by u_N . Far from the structure, $u_N = u_0$. Soil-structure interaction analysis is concerned generally with the relationship between free-field motion and structure motion, i.e. u_{st}/u_0 and, in particular, $u_F/u_0 = r_0$. The important ratio, $u_F/u_N = r_N$, is given by the more sophisticated procedures which also address the problem of soil response involving the variation of vibration amplitude with depth.

E.2 Theoretical considerations

Soil-structure interaction influences the dynamic response of all structures to some degree. Only a rigid building bonded to rigid ground would respond in the same way as the ground. In reality, the ground does not have an infinite rigidity and may provide a mechanism for the radiation and dissipation of energy. Hence it can be thought of as acting as a spring and dashpot system or a series of such systems just below the foundation.

The degree to which soil-structure interaction is a significant aspect of structural response depends on the dynamic parameters of the structure and of the ground, in particular on the natural frequencies of the structure and the shear stiffness of the ground. When considering relatively stiff low-rise buildings (low rise means 6 m to 7 m high), the problem may be examined as the vertical response of a rigid mass on a spring and a dashpot adjusted to match the analytical solution with the ground as semi-infinite isotropic and homogeneous elastic half-space. Such simple concepts suggest that the maximum amplification to be expected in the vertical direction is not likely to exceed 2. Rocking and sliding modes can also be explored in a similar manner and suggest that somewhat higher magnifications can be theoretically achieved in most cases. However, vertical amplification is surely limited because energy captured by the structure from the passing wave is reradiated into the ground, thus damping the amplitude response.

Full consideration of soil-structure interaction should take account of the layering of the soil, the variation of shear stiffness with depth, the effects of building load on soil stiffness, the effect of shear strains on soil stiffness, the geometry of the foundation, and foundation embedment, as well as the frequency content of the excitation.

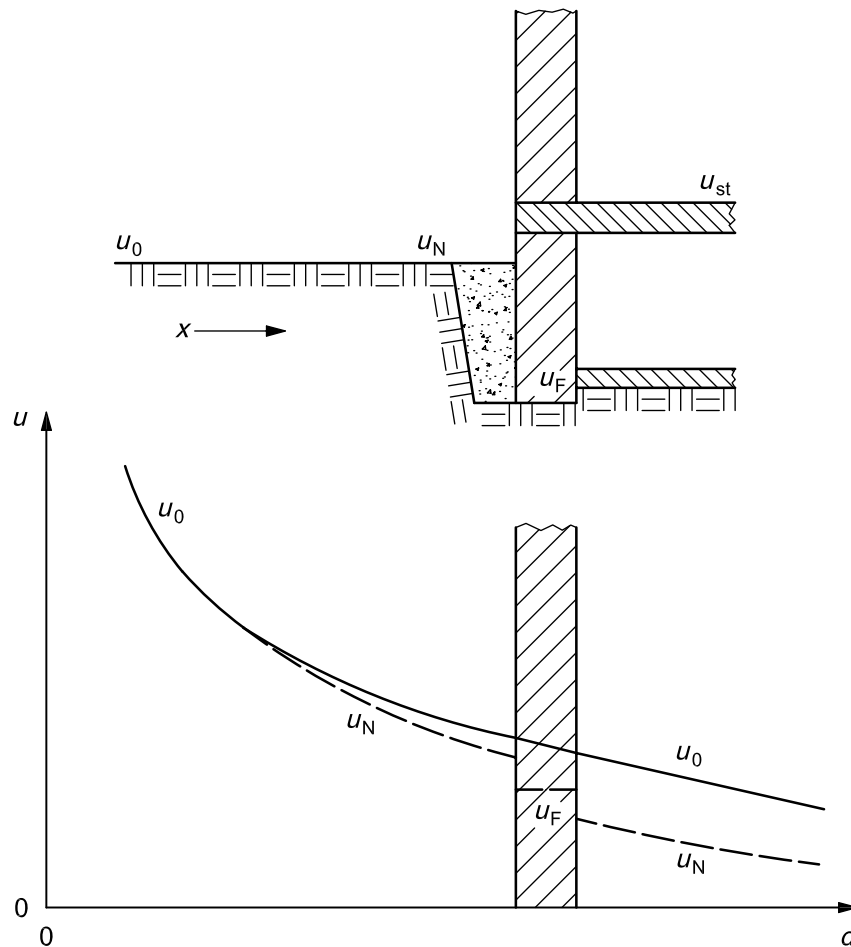

Key

- d distance
- r_0 ratio of the amplitude at the base of the foundation to the free-field amplitude, u_F/u_0
- r_N ratio of the amplitude at the base of the foundation to the amplitude on the soil surface near an existing building, u_F/u_N
- u displacement, velocity or acceleration amplitude of the sinusoidal wave
- u_0 free-field amplitude
- u_N amplitude on the soil surface near an existing building
- u_F amplitude at the base of the foundation
- u_{st} amplitude at an arbitrary position in the structure
- x direction of wave propagation
- 0 source

Figure E.1 — Notation illustrated by a horizontally propagating wave

Dynamic soil-structure interaction is one of the central problems in earthquake engineering and, over recent decades, methods of analysis have been developed giving rise to a vast literature (see References [27], [51] to [56]). Refined analysis has also been used for wind and man-made loading and some simplified rules have been derived (see References [50] [57]).

These advanced analytical methods can be grouped into two classes:

- a) the direct method, whereby the soil and structure are treated together; the ground being represented by finite elements, lumped parameters or both (hybrid models);

- b) the substructure method, whereby the response of the ground and structure are calculated as separate systems with a separation between ground and structure to which springs and dashpots or stiffness functions are applied.

Generally, the closer the frequency of the excitation is to the natural frequency of a building or building element, the greater is the response. Earthquakes, with low frequencies of 0,5 Hz to 8 Hz, tend to excite the lower natural frequencies of buildings; man-made excitation is generally at higher frequencies and tends to excite the structural elements of a building. Furthermore, the range of vertical frequencies of building elements (6 Hz to 40 Hz) lies in the range of man-made excitation, leading to the relatively large bending responses which have been observed in ceilings (see Reference [58]).

E.3 Relationship between vibration at the ground surface and at the foundation (transfer function of the soil-structure interaction)

When the soil vibrations are transferred to the building foundation, they are altered by the elasticity of the soil, the mass of the building, and wave passage effects. This soil-structure interaction can be approximately described by a single-degree-of-freedom (SDOF) system of which the eigenfrequency, f_{BS} , is determined by

$$f_{BS} = \frac{1}{2\pi} \sqrt{\frac{k_S}{m_B}} \quad (E.1)$$

where

k_S is the stiffness, in newtons per metre, of the soil;

m_B is the mass, in kilograms, of the building.

The following structure-soil eigenfrequencies are obtained for medium soft soil as an orientation:

1- to 2-storey buildings	≈ 15 Hz
3- to 6-storey buildings	≈ 8 Hz to 12 Hz
buildings with more than 6 storeys	< 8 Hz

The maximum transfer factor, V , at the soil-structure resonance is determined by the damping, D , of the soil structure system

$$V = \frac{1}{2D} \quad (E.2)$$

The damping can be set to $D = 0,25$ for soft and medium soil. The damping can be considerably reduced for stiff soil (rock) and clearly layered soil.

For frequencies higher than the structure-soil eigenfrequency, the amplitudes of the building are reduced. The amplitudes decrease with frequency down to a certain minimum. The SDOF-transfer function cannot be used beyond this minimum frequency. A transfer factor of 0,5 can be used as a general rule with the exception of rock soil where the transfer function is near to 1. Lower transfer factors are possible and should be proven.

The transfer function of soil-structure interaction is given in a simplified form. Real structures display elastic deformations of the building structure and foundation and the real excitation is more complex. The simplified transfer function is a conservative approximation of the real soil-structure interaction.

Both measurements (see DIN 4150-1^[14] and References [59] to [67]) and theoretical studies indicate that, for most man-made excitations, the value of r_N is likely to be unity or less. This has been supported by results of

a questionnaire which has indicated that for vertical motion without regard to frequency, r_N was in the range 0,3 to 0,6. Histograms of the replies to the questionnaire are given in Figures E.2 and E.3.

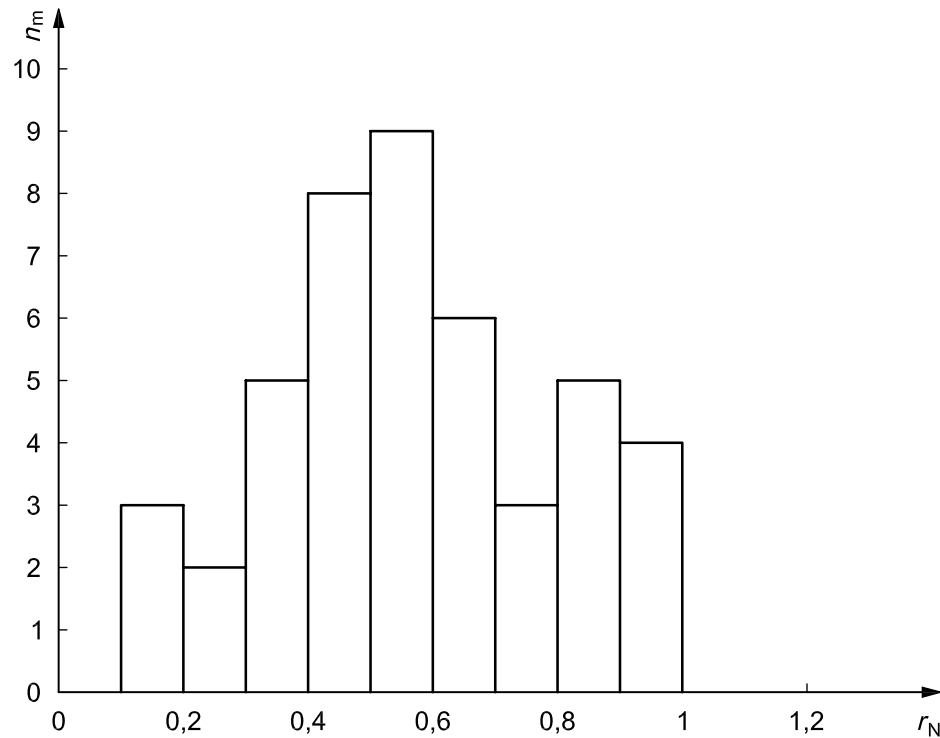

Key

n_m frequency (number of measurements)

r_N ratio of the amplitude at the base of the foundation to the amplitude on the soil surface near an existing building

Figure E.2 — Frequency distribution of r_N (vertical direction of vibration)

E.4 Practical considerations

When analysing, predicting or measuring the soil-structure transfer function, a number of difficulties require consideration.

There are difficulties associated with measurements on the ground near the building, for example:

- a) there are more uncertainties in coupling the transducer to the ground than in fixing it to a building part;
- b) the soil near a building is often disturbed.

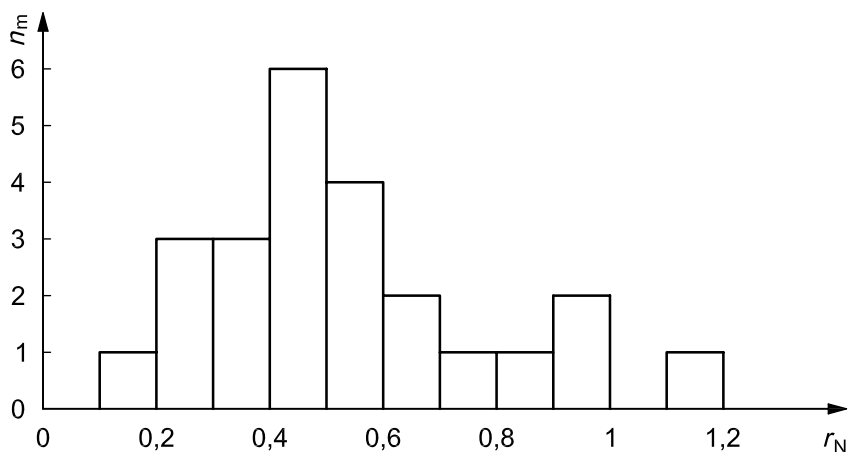

Key

n_m frequency (number of measurements)

r_N ratio of the amplitude at the base of the foundation to the amplitude on the soil surface near an existing building

Figure E.3 — Frequency distribution of r_N (horizontal direction of vibration)

An optimal position of the free-field point is difficult to obtain in urban areas. The measuring point may be too close to the excitation, e.g. a road or railway track, or too close to the building. The amplitude of vibration may be affected by reflection at the front of the foundation (with respect to the travelling wave) and decreased at the rear side by dissipation and front side reflection.

A number of additional effects of soil-structure interaction should be kept in mind.

Where the propagation behaves like a surface Rayleigh wave (which is usual for distant sources), amplitudes decrease with depth (see Figure E.4, for example), so deeper foundations pick up less motion.

The general reduction of vertical vibration on the foundation as compared with that on the soil surface near a building may not hold in cases where there is a marked rocking response.

The range of vertical frequencies of building elements (6 Hz to 40 Hz) lies in the range of man-made excitation, leading to the relatively large bending responses which have been observed in ceilings (see Reference [58]).

Besides the resonance effects, which may also have effects on the foundation amplitudes and the transfer function (see References [57] [62] [68]), the elastic behaviour of buildings determines the high-frequency soil-structure interaction. For frequencies higher than the resonance frequencies, a part of the building mass is decoupled from the rest. The remaining mass is not as effective in reducing the soil amplitudes as the rigid building with its total mass would be. Therefore, the elastic deformations of the building limit the reduction effect as stated in the foregoing section. These effects are more pronounced for taller and column-type structures (see References [57] [68]).

For man-made vibration, there are typically wave-passage effects on soil-structure interaction. For frequencies, f , in the range 5 Hz to 30 Hz and above, and wave speeds, v , in the soil in the range 100 m/s to 400 m/s (sand, clay, gravel), the wavelengths $\lambda = v/f$ are so small that one or more wavelength would fit into the foundation area of a building. The stiff building structure averages the wave-field excitation over the whole foundation area so that the resulting displacement of the foundation is always smaller than the free-field amplitudes of the soil. This averaging or integrating effect is strongest for rigid structures whereas elastic structures give smaller free-field reductions (higher amplitudes) which depend on the structural stiffness (wave resistance or impedance) of the structure. A stochastic spatial variation of the free-field excitation can also yield an averaging effect as well as the wave-passage, but the reduction of the free-field amplitudes is not as strong as for the deterministic wave-field excitation.

While the wave-passage effect reduces the soil amplitudes, the elastic decoupling of masses tends to higher amplitudes. These two effects compensate each other so that the simple formula for a rigid structure and a uniform excitation, as given in E.3, is a good approximation of the overall behaviour of a structure on the soil.

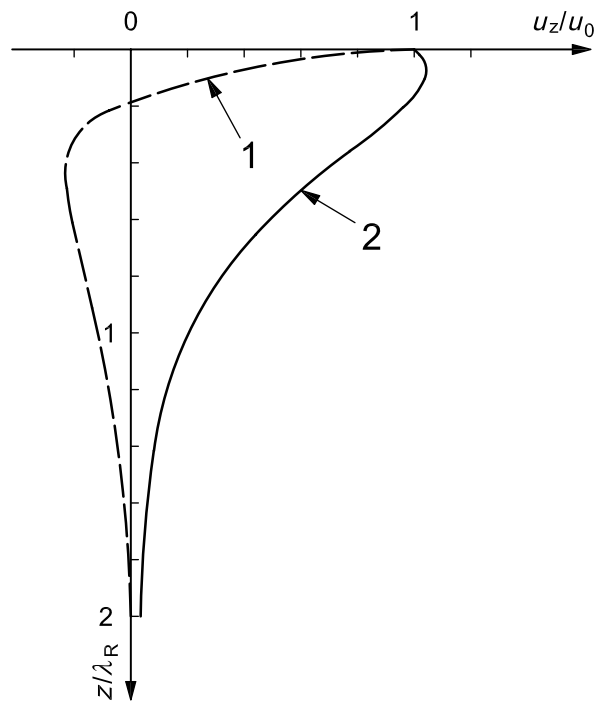

Key

- u_0 free-field amplitude
- u_z vibration amplitude
- z depth
- λ_R Rayleigh wavelength
- 1 horizontal
- 2 vertical

Figure E.4 — Variation of vibration amplitude, u_z , with depth, z , of a Rayleigh wave

- [21] ESDU 82019, *Undamped natural vibration of sway frame buildings and frame structures*
- [22] ESDU 83009, *Damping of structures — Part 1: Tall buildings*
- [23] SN 640312a, *Erschütterungen — Erschütterungseinwirkungen auf Bauwerke* [Vibrations — Vibration effects in buildings]
- [24] HEILAND, D. Base isolation for buildings by vibration control using spring units and viscodampers. International Workshop on Recent Developments in Base-Isolation Techniques for Buildings, Tokyo, 1992
- [25] MASSARSCH, K.R. Ground vibration isolation using gas cushions. Second International Conference on Recent Advances in Geotechnical Earthquake Engineering and Soil Dynamics, 1991
- [26] MEDEARIS, K. The development of rational damage criteria for low-rise structures subjected to blasting vibrations. In: WANG, F.-D., CLARK, G.B., editors. *Energy resources and excavation technology: proceedings, 18th U.S. Symposium on Rock Mechanics (USRMS)*, 1977-06-22/24, Keystone, CO. Colorado School of Mines, Golden, CO, 1977
- [27] NEWMARK, N.M., ROSENBLUETH, E. *Fundamentals of earthquake engineering*. Prentice Hall, Englewood Cliffs, NJ, 1971, 640 p.
- [28] SEED, H.B. Soil liquefaction and cyclic mobility evaluation for level ground during earthquakes. *J. Geotech. Eng. Div.* 1979, **105**, pp. 201-225
- [29] PYKE, R.M., CHAN, C.K., SEED, H.B. Settlement of sands under multidirectional shaking. *J. Geotech. Eng. Div.* 1975, **101**, pp. 379-398
- [30] SHARIF, A.K. Dynamic performance investigation of base isolated structures. PhD Thesis, Imperial College, London, 2000
- [31] SISKIND, D.E., STAGG, M.S., KOPP, J.W., DOWDING, C.H. *Structure response and damage produced by ground vibration from surface mine blasting*. US Dept. of Interior, Bureau of Mines, 1980. 84 p. (Report of Investigations 8507) Available (2009-10-13) at: <http://www.arblast.osmre.gov>
- [32] FULLER, C.R., ELLIOT, S.J., NELSON, P.A. *Active control of vibration*. London: Academic Press, 1996. 332 p.
- [33] BENDAT, J.S., PIERSOL, A.G. *Random data: Analysis and measurement procedures*, 3rd edition. Wiley, New York, NY, 2000. 594 p.
- [34] OPPENHEIM, A.V., SCHAFER, R.W. *Digital signal processing*. Prentice Hall, Englewood Cliffs, NJ, 1975. 585 p.
- [35] FANG, H.Y., KROENER, R.M. Soil-structure interaction during blasting. Paper presented at: International Symposium on Soil-Structure Interaction, University of Roorkee, India, 1977
- [36] CROCKETT, J.H.A. Piling vibrations and structures failure. In: *Recent developments in the design and construction of piles*, pp. 305-320. Institution of Civil Engineers, London, 1980
- [37] MUHR, A.H. A comparison of rubber and metal springs for vibration isolation. *Plast. Rub. Compos. Proc. Appl.* 1992, **18**, pp. 3-7
- [38] NELSON, J.T. Recent developments in ground-borne noise and vibration control. *J. Sound Vib.* 1996, **193**, pp. 367-376
- [39] NEWLAND, D.E., HUNT, H.E.M. Isolation of buildings from ground vibration: A review of recent progress. *Proc. Inst. Mech. Eng.* 1991, **205**, pp. 39-52

- [40] BRE. *Cracking in buildings*. Building Research Establishment, Watford, UK, 1995 (BRE report 292)
- [41] SMALL, A.B. *Techniques for the measurement of vibration in buildings*. Brüel and Kjær (UK), 1990
- [42] KAWECKI, J. Empirical formulae used for calculating the natural periods of vibrations of buildings. *Czasopismo Tech.* 1969, Z 7-B (129)
- [43] STEFFANS, R.J. *Structural vibration and damage*. Building Research Establishment, Watford, UK, 1974. (BRE Report 69)
- [44] BAKRADZE, E.I. Problems of determining the results of instrumental measurements of natural periods of buildings. *Soobs AN Gruz* 1962, **39**(6)
- [45] NAKA, T. Structural design of tall buildings in Japan. ASCE-IABSE Joint Committee Report: Planning and design of tall buildings, Proc. 3rd Regional Conference, Tokyo, 1971
- [46] ANDERSON, A.W., BLUME, J.A., DEGENKOLB, H.J., RINNE, J.E. Lateral forces of earthquake and wind. *Proc. Am. Soc. Civil Eng.* 1951, **77** (Separate No. 66)
- [47] Association Française du Génie Parasismique. *Recommandations AFPS 90 pour la rédaction de règles relatives aux ouvrages et installations à réaliser dans les régions sujettes aux séismes* [AFPS 90 recommendations for the drafting of rules relating to works and installations to be implemented in regions subject to earthquakes]. Presses Ponts et Chaussées, Paris, 1993. 183 p.
- [48] ELLIS, B.R. An assessment of the accuracy of predicting the fundamental natural frequencies of buildings and the implications concerning the dynamic analysis of structures. *Proc. Inst. Civil Eng.* 1980, **69**, pp. 763-776
- [49] JEARY, A.P. Damping in tall buildings — A mechanism and a predictor. *Earthquake Eng. Struc. Dynam.* 1986, **14**, pp. 733-750
- [50] ELLIS, B.R. The significance of dynamic soil-structure interaction in tall buildings. *Inst. Civil Eng. Proc.* 1986, **81**, pp. 221-242
- [51] RICHART, F.E., HALL, J.R., WOODS, R.D. *Vibrations of soils and foundations*. Prentice Hall, Englewood Cliffs, NJ, 1970. 414 p.
- [52] WOLF, J.P. *Dynamic soil-structure interaction*. Prentice Hall, Englewood Cliffs, NJ, 1985. 466 p.
- [53] CLOUGH, R.W., PENZIEN, J. *Dynamics of structures*. McGraw Hill, New York, NY, 1975. 634 p.
- [54] WARBURTON, G.B., RICHARDSON, J.D., WEBSTER, J.J. Forced vibrations of two masses on an elastic half space. *J. Appl. Mech. ASME*, 1971, **38**, pp. 148-156
- [55] HOLZLÖHNER, U. Dynamically loaded buildings on the soil. *Proc. X ICSMFE*, Vol. 3, Stockholm, 1981
- [56] ROESSET, J.M., GONZALES, J.J. Dynamic interaction between adjacent structures. In: PRANGE, B., editor. *Dynamic response and wave propagation in soils* (Proc. DMSR, Karlsruhe 1977), Vol. 1, pp. 127-166. Balkema, Rotterdam, 1978
- [57] AUERSCH, L. *Durch Bodenerschütterungen angeregte Gebäudeschwingungen — Ergebnisse von Modellrechnungen* [Vibration-induced building oscillations — Results of model calculations]. Wirtschaftsverlag NW, Bremerhaven, 1984. 24 p. (BAM Research Report 108)

- [58] AUERSCH, L., HEBENER, H., RÜCKER, W. Erschütterungen infolge Schienenverkehr: Theoretische und messtechnische Untersuchungen zur Emission, zur Ausbreitung durch den Boden und zur Übertragung im Gebäude [Vibrations due to rail traffic: Theoretical and instrumentation investigations into the emission, propagation through the ground and transmission in buildings]. STUVA Report Nr. 19 (Reihe Verminderung des Verkehrslärms in Städten und Gemeinden, Teilprogramm Schienennahverkehr), 1986
- [59] SISKIND, D.E., STAGG, M.S. *Blast vibration measurements near and on structure foundations*. US Department of the Interior, Bureau of Mines, Pittsburgh, PA, 1985. 24 p. (*Report of Investigations* RI 8969) Available (2009-10-14) from <http://www.arblast.osmre.gov>
- [60] NELSON, J.T., SAURENMAN, H.J. State of the art review: prediction and control of ground-borne vibration from rail transit trains. Report No. UMTA-MA-06-0049-83-4, US Department of Transportation, 1983
- [61] JAKOBSEN, J. Transmission of ground-borne vibration in buildings. *J. Low Freq. Noise Vib.* 1989, **8**, pp. 75-80
- [62] MÖSER, M., MÜLLER, G., editors. *Engineering acoustics: A handbook*. Springer, Berlin, 2009. 650 p. [German edition: MÜLLER, G., MÖSER, M., editors. *Taschenbuch der technischen Akustik* (Technical acoustics handbook), 3rd edition. Springer, Berlin, 2004. 821 p.]
- [63] HÖLZL, G., FISCHER, G. Körperschall- bzw. Erschütterungsausbreitung an oberirdischen Schienenverkehrswegen [Propagation of structure-borne sound and vibration on surface railways]. *Eisenbahntech. Rundschau* 1985, **34**, pp. 469-477
- [64] LÜDELING, R., HINZEN, K.-G. Erschütterungsprognose und Erschütterungskataster [Vibration prognosis and vibration land register]. In: Steinwachs, M., editor. *Ausbreitung von Erschütterungen im Boden und Bauwerk*, pp. 153-168. Clausthal-Zellerfeld: Trans Tech 1988
- [65] MELKE, J. *Erschütterungen und Körperschall des landgebundenen Verkehrs: Prognose und Schutzmaßnahmen* [Vibration and sound impact of landbound traffic: Prognosis and protection measures], Vol. 22. Landesumweltamt NRW, Essen, 1995. 658 p.
- [66] RÜCKER, W. Schwingungsmessungen beim Rammen von Stahlspundwänden [Vibration measurements when ramming steel sheet pile walls]. In: *Symposium Messtechnik im Erd- und Grundbau*, pp. 49-55. München 1983
- [67] AUERSCH, L., SCHMID, W., SAID, S. Erschütterungen im Bauwesen: Messergebnisse an verschiedenen Gebäuden und eine einfache Berechnung von Fundament-, Wand- und Deckenschwingungen [Vibrations in the building industry: Results of measurement in different building types and a simple computation of foundation, wall, and floor vibrations] — Teil 1 [Part 1]. *Bauingenieur* 2004, **79**, pp. 185-192; AUERSCH, L., SAID, S., SCHMID, W., RÜCKER, W. Erschütterungen im Bauwesen: Messergebnisse an verschiedenen Gebäuden und eine einfache Berechnung von Fundament-, Wand- und Deckenschwingungen. Teil 2 [Part 2]. *Bauingenieur* 2004, **79**, pp. 291-299
- [68] AUERSCH, L. Berechnung des Schwingungsverhaltens von Gebäuden bei Einwirkung von Erschütterungen [Computation of the vibration response of buildings during effect of vibrations]. *Bauingenieur* 1984, **59**, pp. 309-317
- [69] NORTHWOOD, T.D., CRAWFORD, R. *Blasting and building damage*. National Research Council Canada Publications, 1965. (*Canadian Building Digest* CBD-63.) Available (2009-10-14) at: <http://www.nrc-cnrc.gc.ca/eng/ibp/irc/cbd/building-digest-63.html>
- [70] ZHOU, Y., HAO, H., MA, G. Ground shock damage criteria for inhabited buildings. In: *Proceedings of the 28th DOD Explosive Safety Seminar*, Orlando, FL, 1998-08-18/20
- [71] RUNDQVIST, G. *Naturlig sprickbildning i nya småhus — Hjälpmedel för besiktning efter sprängning*. Statens råd för byggnadsforskning, Stockholm, 1988. 35 p. (Report SBUF project 2139)

- [72] BJØRKMAN, M., ODEBRANT, T., RUNDQVIST, G. *Byggtrafikinducerade vibrationer i byggnader*. Statens råd för byggnadsforskning, Stockholm, 2000 (Report SBUF project 9026)
- [73] DOWDING, C.H. *Construction vibrations*. Prentice Hall, Upper Saddle River, NJ, 1996. 610 p.
- [74] DOWDING, C.H., AIMONE-MARTIN, C.T. Micro-meter crack response to rock blast vibrations, wind gusts and weather effects. In: *Innovative Applications of Geophysics in Civil Engineering* (GSP 164), pp. 1-8. American Society of Civil Engineers, Reston, VA, 2007
- [75] DOWDING, C.H., SNIDER, M.L. New approach to control of vibrations generated by construction in rock and soil. In: *Proceedings of the Soil and Rock America Symposium, 12th Pan-American Conference on Soil Mechanics and Geotechnical Engineering and 39th US Rock Mechanics Symposium*, Massachusetts Institute of Technology, Cambridge, MA, 2003. Available (2009-10-14) at: http://www.iti.northwestern.edu/acm/publications/dowding/dowding_MIT_conf_article.pdf
- [76] WILLIAMS, M.S., WALDRON, P. Evaluation of methods for predicting occupant-induced vibrations in concrete floors. *Struct. Eng.* 1994, **72**, pp. 334-340

ICS 17.160; 91.120.25

Price based on 40 pages

BSI - British Standards Institution

BSI is the independent national body responsible for preparing British Standards. It presents the UK view on standards in Europe and at the international level. It is incorporated by Royal Charter.

Revisions

British Standards are updated by amendment or revision. Users of British Standards should make sure that they possess the latest amendments or editions.

It is the constant aim of BSI to improve the quality of our products and services. We would be grateful if anyone finding an inaccuracy or ambiguity while using this British Standard would inform the Secretary of the technical committee responsible, the identity of which can be found on the inside front cover. Tel: +44 (0)20 8996 9000. Fax: +44 (0)20 8996 7400.

BSI offers members an individual updating service called PLUS which ensures that subscribers automatically receive the latest editions of standards.

Buying standards

Orders for all BSI, international and foreign standards publications should be addressed to Customer Services. Tel: +44 (0)20 8996 9001. Fax: +44 (0)20 8996 7001 Email: orders@bsigroup.com You may also buy directly using a debit/credit card from the BSI Shop on the Website <http://www.bsigroup.com/shop>

In response to orders for international standards, it is BSI policy to supply the BSI implementation of those that have been published as British Standards, unless otherwise requested.

Information on standards

BSI provides a wide range of information on national, European and international standards through its Library and its Technical Help to Exporters Service. Various BSI electronic information services are also available which give details on all its products and services. Contact Information Centre. Tel: +44 (0)20 8996 7111 Fax: +44 (0)20 8996 7048 Email: info@bsigroup.com

Subscribing members of BSI are kept up to date with standards developments and receive substantial discounts on the purchase price of standards. For details of these and other benefits contact Membership Administration. Tel: +44 (0)20 8996 7002 Fax: +44 (0)20 8996 7001 Email: membership@bsigroup.com

Information regarding online access to British Standards via British Standards Online can be found at <http://www.bsigroup.com/BSOL>

Further information about BSI is available on the BSI website at <http://www.bsigroup.com>

Copyright

Copyright subsists in all BSI publications. BSI also holds the copyright, in the UK, of the publications of the international standardization bodies. Except as permitted under the Copyright, Designs and Patents Act 1988 no extract may be reproduced, stored in a retrieval system or transmitted in any form or by any means – electronic, photocopying, recording or otherwise – without prior written permission from BSI.

This does not preclude the free use, in the course of implementing the standard, of necessary details such as symbols, and size, type or grade designations. If these details are to be used for any other purpose than implementation then the prior written permission of BSI must be obtained.

Details and advice can be obtained from the Copyright and Licensing Manager. Tel: +44 (0)20 8996 7070 Email: copyright@bsigroup.com