

BS ISO 4664-1:2011



BSI Standards Publication

# Rubber, vulcanized or thermoplastic — Determination of dynamic properties

Part 1: General guidance

**bsi.**

...making excellence a habit.™

**National foreword**

This British Standard is the UK implementation of ISO 4664-1:2011. It supersedes BS ISO 4664-1:2005 which is withdrawn.

The UK participation in its preparation was entrusted to Technical Committee PRI/22, Physical testing of rubber.

A list of organizations represented on this committee can be obtained on request to its secretary.

This publication does not purport to include all the necessary provisions of a contract. Users are responsible for its correct application.

© BSI 2011

ISBN 978 0 580 66247 8

ICS 83.060

**Compliance with a British Standard cannot confer immunity from legal obligations.**

This British Standard was published under the authority of the Standards Policy and Strategy Committee on 30 November 2011.

**Amendments issued since publication**

Date	Text affected
------	---------------

---

# INTERNATIONAL STANDARD

BS ISO 4664-1:2011

**ISO**  
**4664-1**

Second edition  
2011-11-15

---

---

## **Rubber, vulcanized or thermoplastic — Determination of dynamic properties —**

### **Part 1: General guidance**

*Caoutchouc vulcanisé ou thermoplastique — Détermination des  
propriétés dynamiques —*

*Partie 1: Lignes directrices*



Reference number  
ISO 4664-1:2011(E)

© ISO 2011



**COPYRIGHT PROTECTED DOCUMENT**

© ISO 2011

All rights reserved. Unless otherwise specified, no part of this publication may be reproduced or utilized in any form or by any means, electronic or mechanical, including photocopying and microfilm, without permission in writing from either ISO at the address below or ISO's member body in the country of the requester.

ISO copyright office  
Case postale 56 • CH-1211 Geneva 20  
Tel. + 41 22 749 01 11  
Fax + 41 22 749 09 47  
E-mail [copyright@iso.org](mailto:copyright@iso.org)  
Web [www.iso.org](http://www.iso.org)

Published in Switzerland

## Contents

Page

Foreword .....	iv
<b>1</b> <b>Scope</b> .....	<b>1</b>
<b>2</b> <b>Normative references</b> .....	<b>1</b>
<b>3</b> <b>Terms and definitions</b> .....	<b>1</b>
<b>3.1</b> <b>Terms applying to any periodic deformation</b> .....	<b>1</b>
<b>3.2</b> <b>Terms applying to sinusoidal motion</b> .....	<b>4</b>
<b>3.3</b> <b>Other terms applying to periodic motion</b> .....	<b>6</b>
<b>4</b> <b>Symbols</b> .....	<b>7</b>
<b>5</b> <b>Principles</b> .....	<b>9</b>
<b>5.1</b> <b>Viscoelasticity</b> .....	<b>9</b>
<b>5.2</b> <b>Use of dynamic test data</b> .....	<b>10</b>
<b>5.3</b> <b>Classification of dynamic tests</b> .....	<b>10</b>
<b>5.4</b> <b>Factors affecting machine selection</b> .....	<b>11</b>
<b>5.5</b> <b>Dynamic motion</b> .....	<b>11</b>
<b>5.6</b> <b>Interdependence of frequency and temperature</b> .....	<b>14</b>
<b>6</b> <b>Apparatus</b> .....	<b>15</b>
<b>7</b> <b>Test conditions and test pieces</b> .....	<b>16</b>
<b>7.1</b> <b>Test piece preparation</b> .....	<b>16</b>
<b>7.2</b> <b>Test piece dimensions</b> .....	<b>16</b>
<b>7.3</b> <b>Number of test pieces</b> .....	<b>17</b>
<b>7.4</b> <b>Test conditions</b> .....	<b>17</b>
<b>7.5</b> <b>Small-sized test apparatus</b> .....	<b>18</b>
<b>7.6</b> <b>Large-sized test apparatus</b> .....	<b>19</b>
<b>7.7</b> <b>Dynamic testing using free vibration</b> .....	<b>20</b>
<b>8</b> <b>Conditioning</b> .....	<b>20</b>
<b>8.1</b> <b>Storage</b> .....	<b>20</b>
<b>8.2</b> <b>Temperature</b> .....	<b>20</b>
<b>8.3</b> <b>Mechanical conditioning</b> .....	<b>20</b>
<b>9</b> <b>Test procedure</b> .....	<b>21</b>
<b>10</b> <b>Expression of results</b> .....	<b>21</b>
<b>10.1</b> <b>Parameters required</b> .....	<b>21</b>
<b>10.2</b> <b>Forced vibration</b> .....	<b>21</b>
<b>10.3</b> <b>Free vibration</b> .....	<b>23</b>
<b>10.4</b> <b>Stress-strain relationships and shape factors</b> .....	<b>23</b>
<b>11</b> <b>Test report</b> .....	<b>24</b>

## Foreword

ISO (the International Organization for Standardization) is a worldwide federation of national standards bodies (ISO member bodies). The work of preparing International Standards is normally carried out through ISO technical committees. Each member body interested in a subject for which a technical committee has been established has the right to be represented on that committee. International organizations, governmental and non-governmental, in liaison with ISO, also take part in the work. ISO collaborates closely with the International Electrotechnical Commission (IEC) on all matters of electrotechnical standardization.

International Standards are drafted in accordance with the rules given in the ISO/IEC Directives, Part 2.

The main task of technical committees is to prepare International Standards. Draft International Standards adopted by the technical committees are circulated to the member bodies for voting. Publication as an International Standard requires approval by at least 75 % of the member bodies casting a vote.

Attention is drawn to the possibility that some of the elements of this document may be the subject of patent rights. ISO shall not be held responsible for identifying any or all such patent rights.

ISO 4664-1 was prepared by Technical Committee ISO/TC 45, *Rubber and rubber products*, Subcommittee SC 2, *Testing and analysis*.

This second edition cancels and replaces the first edition (ISO 4664-1:2005), which has been technically revised as follows:

- the test conditions given in Tables 2 and 3 have been modified;
- a number of equations and figures have been added for better comprehension of the text;
- the clause concerning calibration (Clause 7 in the previous edition) has been deleted.

ISO 4664 consists of the following parts, under the general title *Rubber, vulcanized or thermoplastic — Determination of dynamic properties*:

- *Part 1: General guidance*
- *Part 2: Torsion pendulum methods at low frequencies*

# Rubber, vulcanized or thermoplastic — Determination of dynamic properties —

## Part 1: General guidance

### 1 Scope

This part of ISO 4664 provides guidance on the determination of dynamic properties of vulcanized and thermoplastic rubbers. It includes both free- and forced-vibration methods carried out on both materials and products. It does not cover rebound resilience or cyclic tests in which the main objective is to fatigue the rubber.

### 2 Normative references

The following referenced documents are indispensable for the application of this document. For dated references, only the edition cited applies. For undated references, the latest edition of the referenced document (including any amendments) applies.

ISO 815-1, *Rubber, vulcanized or thermoplastic — Determination of compression set — Part 1: At ambient or elevated temperatures*

ISO 7743:2011, *Rubber, vulcanized or thermoplastic — Determination of compression stress-strain properties*

ISO 23529, *Rubber — General procedures for preparing and conditioning test pieces for physical test methods*

### 3 Terms and definitions

For the purposes of this document, the following terms and definitions apply.

#### 3.1 Terms applying to any periodic deformation

##### 3.1.1

##### **mechanical hysteresis loop**

closed curve representing successive stress-strain states of a material during a cyclic deformation

NOTE Loops can be centred around the origin of co-ordinates or more frequently displaced to various levels of strain or stress; in this case the shape of the loop becomes variously asymmetrical in more than one way, but this fact is frequently ignored.

##### 3.1.2

##### **energy loss**

energy per unit volume which is lost in each deformation cycle, i.e. the hysteresis loop area

NOTE It is expressed in  $\text{J/m}^3$ .

### 3.1.3

#### power loss

energy loss per unit time, per unit volume, which is transformed into heat through hysteresis, expressed as the product of energy loss and frequency

NOTE It is expressed in  $W/m^3$ .

### 3.1.4

#### mean load

average value of the load during a single complete hysteresis loop

NOTE It is expressed in N.

### 3.1.5

#### mean deflection

average value of the deflection during a single complete hysteresis loop (see Figure 1)

NOTE It is expressed in m.

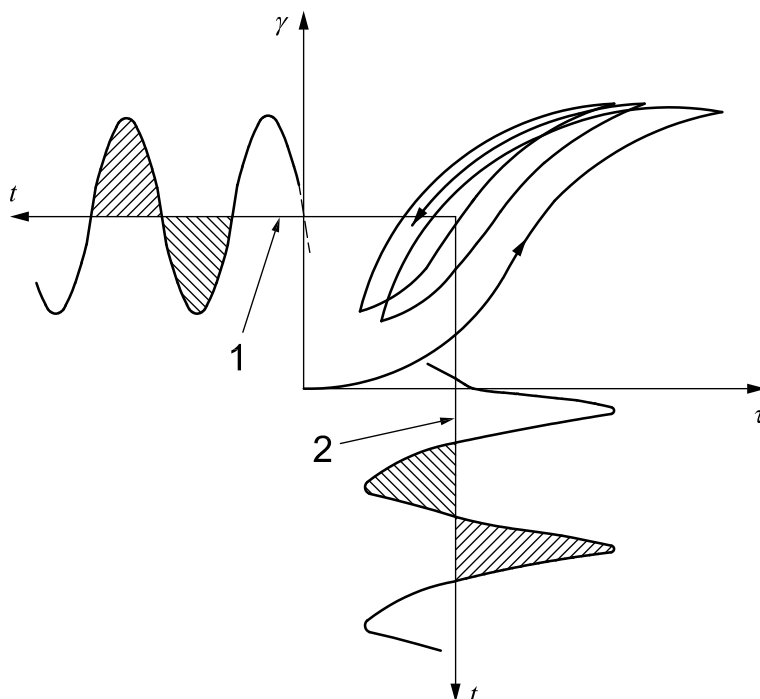

#### Key

- 1 mean strain
- 2 mean stress

NOTE 1 Open initial loops are shown, as well as equilibrium mean strain and mean stress as time-averages of instantaneous strain and stress.

NOTE 2 A sinusoidal response to a sinusoidal motion implies hysteresis loops which are or can be considered to be elliptical.

NOTE 3 For large sinusoidal deformations, the hysteresis loop will deviate from an ellipse since, for rubber, the stress-strain relationship is non-linear and the response is therefore not sinusoidal.

NOTE 4 The term "incremental" may be used to designate a dynamic response to sinusoidal deformation about various levels of mean stress or mean strain (for example, incremental spring constant, incremental elastic shear modulus).

**Figure 1 — Heavily distorted hysteresis loop obtained under forced pulsating sinusoidal strain**



### 3.1.6

#### mean stress

average value of the stress during a single complete hysteresis loop (see Figure 1)

NOTE It is expressed in Pa.

### 3.1.7

#### mean strain

average value of the strain during a single complete hysteresis loop (see Figure 1)

### 3.1.8

#### mean modulus

ratio of the mean stress to the mean strain

NOTE It is expressed in Pa.

### 3.1.9

#### maximum load amplitude

$F_0$   
maximum applied load, measured from the mean load (zero to peak on one side only)

NOTE It is expressed in N.

### 3.1.10

#### maximum stress amplitude

$\tau_0$   
ratio of the maximum applied force, measured from the mean force, to the cross-sectional area of the unstressed test piece (zero to peak on one side only)

NOTE It is expressed in Pa.

### 3.1.11

#### root-mean-square stress

square root of the mean value of the square of the stress averaged over one cycle of deformation

NOTE 1 For a symmetrical sinusoidal stress, the root-mean-square stress equals the stress amplitude divided by  $\sqrt{2}$ .

NOTE 2 It is expressed in Pa.

### 3.1.12

#### maximum deflection amplitude

$x_0$   
maximum deflection, measured from the mean deflection (zero to peak on one side only)

NOTE It is expressed in m.

### 3.1.13

#### maximum strain amplitude

$\gamma_0$   
maximum strain, measured from the mean strain (zero to peak on one side only)

### 3.1.14

#### root-mean-square strain

square root of the mean value of the square of the strain averaged over one cycle of deformation

NOTE For a symmetrical sinusoidal strain, the root-mean-square strain equals the strain amplitude divided by  $\sqrt{2}$ .

## 3.2 Terms applying to sinusoidal motion

### 3.2.1 spring constant

$K$   
component of the applied load which is in phase with the deflection, divided by the deflection

NOTE It is expressed in N/m.

### 3.2.2 elastic shear modulus storage shear modulus

$G'$   
component of the applied shear stress which is in phase with the shear strain, divided by the strain

$$G' = |G^*| \cos \delta$$

NOTE It is expressed in Pa.

### 3.2.3 loss shear modulus

$G''$   
component of the applied shear stress which is in quadrature with the shear strain, divided by the strain

$$G'' = |G^*| \sin \delta$$

NOTE It is expressed in Pa.

### 3.2.4 complex shear modulus

$G^*$   
ratio of the shear stress to the shear strain, where each is a vector which can be represented by a complex number

$$G^* = G' + iG''$$

NOTE It is expressed in Pa.

### 3.2.5 absolute complex shear modulus

$|G^*|$   
absolute value of the complex shear modulus

$$|G^*| = \sqrt{G'^2 + G''^2}$$

NOTE It is expressed in Pa.

### 3.2.6 elastic normal modulus storage normal modulus elastic Young's modulus

$E'$   
component of the applied normal stress which is in phase with the normal strain, divided by the strain

$$E' = |E^*| \cos \delta$$

NOTE It is expressed in Pa.

### 3.2.7

**loss normal modulus**  
**loss Young's modulus**

$E''$

component of the applied normal stress which is in quadrature with the normal strain, divided by the strain

$$E'' = |E^*| \sin \delta$$

NOTE It is expressed in Pa.

### 3.2.8

**complex normal modulus**  
**complex Young's modulus**

$E^*$

ratio of the normal stress to the normal strain, where each is a vector which can be represented by a complex number

$$E^* = E' + iE''$$

NOTE It is expressed in Pa.

### 3.2.9

**absolute normal modulus**

absolute value of the complex normal modulus

$$|E^*| = \sqrt{E'^2 + E''^2}$$

### 3.2.10

**storage spring constant**  
**dynamic spring constant**

$K'$

component of the applied load which is in phase with the deflection, divided by the deflection

$$K' = |K^*| \cos \delta$$

NOTE It is expressed in N/m.

### 3.2.11

**loss spring constant**

$K''$

component of the applied load which is in quadrature with the deflection, divided by the deflection

$$K'' = |K^*| \sin \delta$$

NOTE It is expressed in N/m.

### 3.2.12

**complex spring constant**

$K^*$

ratio of the load to the deflection, where each is a vector which can be represented by a complex number

$$K^* = K' + iK''$$

NOTE It is expressed in N/m.

**3.2.13**  
**absolute complex spring constant**

$|K^*|$   
absolute value of the complex spring constant

$$|K^*| = \sqrt{K'^2 + K''^2}$$

NOTE It is expressed in N/m.

**3.2.14**  
**tangent of the loss angle**

$\tan \delta$   
ratio of the loss modulus to the elastic modulus

NOTE For shear stresses,  $\tan \delta = \frac{G''}{G'}$  and for normal stresses  $\tan \delta = \frac{E''}{E'}$ .

**3.2.15**  
**loss factor**

$L_f$   
ratio of the loss spring constant to the storage spring constant

$$L_f = \frac{K''}{K'}$$

**3.2.16**  
**loss angle**

$\delta$   
phase angle between the stress and the strain

NOTE It is expressed in rad.

**3.3 Other terms applying to periodic motion**

**3.3.1**  
**logarithmic decrement**

natural (Napierian) logarithm of the ratio between successive amplitudes of the same sign of a damped oscillation

**3.3.2**  
**damping ratio**

$u$   
ratio of actual to critical damping, where critical damping is that required for the borderline condition between oscillatory and non-oscillatory behaviour

NOTE The damping ratio is a function of the logarithmic decrement:

$$u = \frac{\frac{\lambda}{2\pi}}{\sqrt{1 + \left(\frac{\lambda}{2\pi}\right)^2}} = \sin \tan^{-1} \left( \frac{\lambda}{2\pi} \right)$$

### 3.3.3 damping coefficient damping constant

$C$

$$C = \frac{1}{\omega} |K^*| \sin \delta$$

where  $\omega = 2\pi f$

NOTE It is expressed in N-s/m.

### 3.3.4 transmissibility

$V_\tau$

$$V_\tau = \sqrt{\frac{1 + (\tan \delta)^2}{\left[1 - \left(\frac{\omega}{\omega_n}\right)^2\right]^2 + (\tan \delta)^2}}$$

where  $\omega_n$  is the natural angular frequency of the undamped vibrator, given by

$$\omega_n = \sqrt{\frac{K'}{m}}$$

and

$$K' = |K^*| \cos \delta$$

## 4 Symbols

For the purposes of this document, the following symbols apply:

$A$	(m <sup>2</sup> )	test piece cross-sectional area
$a(T)$		Williams, Landel, Ferry (WLF) shift factor
$\alpha$	(rad)	angle of twist
$b$	(m)	test piece width
$C$		damping coefficient (damping constant)
$C_p$		heat capacity
$\gamma$		strain
$\gamma_0$		maximum strain amplitude
$\delta$	(rad)	loss angle
$E$	(Pa)	Young's modulus
$E_c$	(Pa)	effective Young's modulus
$E'$	(Pa)	elastic normal modulus (storage normal modulus)

$E''$	(Pa)	loss normal modulus
$E^*$	(Pa)	complex normal modulus (complex Young's modulus)
$ E^* $	(Pa)	absolute value of complex normal modulus
$F$	(N)	load
$F_0$	(N)	maximum load amplitude
$f$	(Hz)	frequency
$G$	(Pa)	shear modulus
$G'$	(Pa)	elastic shear modulus (storage shear modulus)
$G''$	(Pa)	loss shear modulus
$G^*$	(Pa)	complex shear modulus
$ G^* $	(Pa)	absolute value of complex shear modulus
$h$	(m)	test piece thickness
$K$	(N/m)	spring constant
$K'$	(N/m)	storage spring constant (dynamic spring constant)
$K''$	(N/m)	loss spring constant
$K^*$	(N/m)	complex spring constant
$ K^* $	(N/m)	absolute value of complex spring constant
$k$		numerical factor
$k_l$		shape factor in torsion
$L_f$		loss factor
$l$	(m)	test piece length
$\lambda$		extension ratio
$\Lambda$		logarithmic decrement
$M'$	(Pa)	in-phase or storage modulus
$M''$	(Pa)	loss modulus
$M^*$	(Pa)	complex modulus
$ M^* $	(Pa)	absolute value of complex modulus
$m$	(kg)	mass
$\rho$	(kg/m <sup>3</sup> )	rubber density
$Q$	(N·m)	torque
$S$		shape factor
$T$	(K)	temperature (in kelvins)
$T_g$	(K)	low-frequency glass transition temperature
$T_0$	(K)	reference temperature

$t$	(s)	time
$\tan \delta$		tangent of the loss angle
$\tau$	(Pa)	stress
$\tau_0$	(Pa)	maximum stress amplitude
$\tau'$	(Pa)	in-phase stress
$\tau''$	(Pa)	out-of-phase stress
$u$		damping ratio
$V_\tau$		transmissibility
$\omega$	(rad/s)	angular frequency
$x$	(m)	deflection
$x_0$	(m)	maximum deflection amplitude

## 5 Principles

### 5.1 Viscoelasticity

Matter cannot be deformed without applying force. Unlike elastic materials such as metals, rubber is a viscoelastic material, i.e. it shows both an elastic response and a viscous drag when deformed. Viscoelastic properties have been modeled as combinations of perfectly elastic springs and viscous dampers (dashpots), arranged in parallel (Voigt-Kelvin model) or in series (Maxwell model), giving a qualitative model of the time-dependent behaviour of rubber-like materials.

NOTE For the use of more elaborate models to describe the behaviour accurately, see *Viscoelastic Properties of Polymers*, by J. D. Ferry, published by John Wiley and Sons, 1983.

The dynamic properties of viscoelastic materials can be explained more conveniently by separating the two components elasticity (spring) and viscosity (damping), for example as in Figure 2. Analysis of the behaviour of this model, under a cyclic load or stress, shows that the resulting deformation lags in time behind the applied load or stress (i.e. shows a phase difference) (see 5.5). The dynamic properties of rubber can be thought of as physical properties quantitatively expressing the relationship of these inputs and responses.

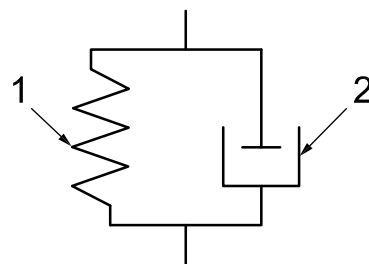

#### Key

- 1 elasticity
- 2 viscosity

Figure 2 — A dynamic model for rubber (Voigt-Kelvin model)

## 5.2 Use of dynamic test data

Measurements of dynamic properties are generally used for the following purposes:

- a) characterization of materials;
- b) production of design data;
- c) evaluation of products.

Viscoelastic behaviour of polymers is complex and the results can be very sensitive to test conditions such as frequency, amplitude of the applied force or deformation, test piece geometry and mode of deformation, so these conditions shall be controlled carefully if comparable results are to be obtained.

An important consequence is that it is essential that the conditions under which data are produced are suitable for the intended purpose of the data. In turn, this can mean that different types of test machine can produce test data suitable for different purposes. For instance, small dynamic analyser machines are especially suitable for material characterization, but might not have sufficient capacity for generating design data or measuring product performance.

## 5.3 Classification of dynamic tests

There are numerous types of dynamic test apparatus in use and several ways in which they can be classified:

### a) Classification by type of vibration

There are two basic classes of dynamic test, i.e. free vibration in which the test piece is set in oscillation and the amplitude allowed to decay due to damping in the system, and forced vibration in which the oscillation is maintained by external means. There are two types of test method using forced vibration, i.e. resonance type and non-resonance type.

### b) Classification by type of test apparatus

Forced-vibration machines can be conveniently divided into small-sized and large-sized test apparatuses (see Table 1). Although the division is somewhat arbitrary, there is seldom difficulty in assigning particular machines to one of these categories.

Other pieces of apparatus, such as the torsion pendulum, are usually dealt with individually.

**Table 1 — Classification of dynamic tests**

	Small-sized test apparatus	Large-sized test apparatus
Purpose of test	Comparison and evaluation of material properties	Comparison and evaluation of design and product performance
Vibration method	Forced-vibration non-resonance method Forced-vibration resonance method Free-vibration method	Forced-vibration non-resonance method Forced-vibration resonance method
Deformation mode	Tension, bending, compression and shear	Compression, tension, torsion and shear
Test piece shapes	Rectangular strip, cylinder, rectangular column	Cylinder, rectangular column, product

### c) Classification by mode of deformation

The deformation method can involve compression, shear, tension, bending or torsion of the test piece.



## 5.4 Factors affecting machine selection

The advantages and disadvantages of the various types of dynamic test machine can be summarized as follows:

Deformation in shear generally allows the most precise definition of strain and the stress-strain curve is linear to higher amplitudes than for other deformation modes, but the test pieces have to be fabricated with metal end pieces.

Deformation in compression can be useful in matching service conditions, particularly with products, but generally requires a higher force capacity and consideration of the shape factor of the test piece.

Deformation in bending, torsion or tension requires a lower force capacity and test pieces are easily produced, but it might be less satisfactory for measurements of absolute values of the modulus.

The preferred type of test machine for generating design data is a forced-vibration non-resonance machine operating in shear.

A large force capacity, and hence an expensive machine, is necessary for higher strain amplitudes in shear and compression and for testing products.

For material characterization, the mode of deformation is not, in principle, important and a large force capacity is not necessary.

Dynamic analysers of modest capacity but having automated scanning of frequency and temperature are particularly efficient for material characterization.

Free-vibration apparatus is restricted to low frequencies and amplitudes, normally in torsion.

Testing at resonance is generally restricted to bending and does not allow the effects of amplitude and frequency to be measured.

## 5.5 Dynamic motion

### 5.5.1 Forced-vibration method

Rubbers are viscoelastic materials and hence their response to dynamic stressing is a combination of an elastic response and a viscous response and energy is lost in each cycle.

For sinusoidal strain, the motion is described by

$$\gamma = \gamma_0 \sin \omega t \quad (\text{see Figure 3}) \quad (1)$$

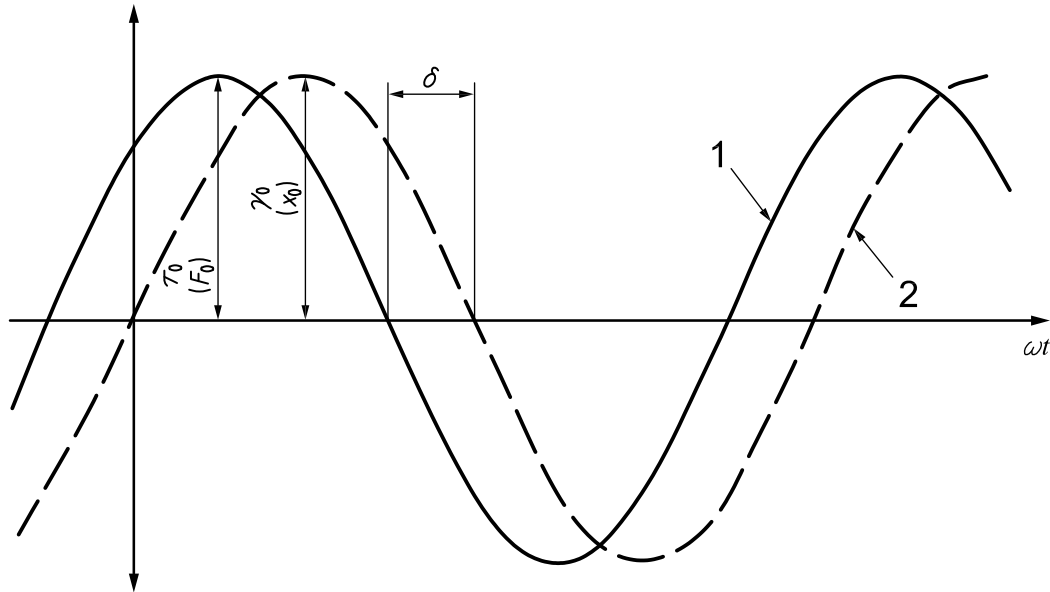

**Key**

- 1 stress (load)
- 2 strain (deflection)

**Figure 3 — Sinusoidal stress-strain time cycle**

The stress  $\tau$  will not be in phase with the strain and can be considered to precede it by the phase angle  $\delta$  so that:

$$\tau = \tau_0 \sin(\omega t + \delta) \quad (2)$$

Considering the stress as a vector having two components, one in phase ( $\tau'$ ) and the other  $90^\circ$  out of phase ( $\tau''$ ), and defining the corresponding in-phase modulus as  $M'$  and the corresponding out-of-phase modulus as  $M''$ , the complex modulus ( $M^*$ ) is given by the following equation:

$$M^* = M' + iM'' \quad (3)$$

Also

$$M' = \frac{\tau'}{\gamma_0} = \frac{\tau_0}{\gamma_0} \cos \delta = |M^*| \cos \delta \quad (4)$$

$$M'' = \frac{\tau''}{\gamma_0} = \frac{\tau_0}{\gamma_0} \sin \delta = |M^*| \sin \delta \quad (5)$$

The absolute value of the complex modulus is given by following equation:

$$|M^*| = \sqrt{M'^2 + M''^2} \quad (6)$$

The tangent of the loss angle is given by the following equation:

$$\tan \delta = \frac{M''}{M'} \quad (7)$$

### 5.5.2 Free-vibration method

For a freely vibrating rubber and mass system, the motion is described by the following equations:

$$m \frac{d^2x}{dt^2} + \frac{K''}{\omega} \frac{dx}{dt} + K'x = 0 \quad (8)$$

$$\Lambda = \log_e \left( \frac{x_n}{x_{n+1}} \right) \quad (9)$$

The solution of these equations gives

$$K' = m\omega^2 \left( 1 + \frac{\Lambda^2}{4\pi^2} \right) \quad (10)$$

$$K'' = \frac{m\omega^2 \Lambda}{\pi} \quad (11)$$

$$L_f = \frac{\Lambda}{\pi \left( 1 + \frac{\Lambda^2}{4\pi^2} \right)} \quad (12)$$

where

- $\Lambda$  is the logarithmic decrement;
- $n$  is the number of the cycle;
- $x_n$  is the amplitude of the  $n$ th cycle (m);
- $x_{n+1}$  is the amplitude of the  $(n+1)$ th cycle (m);
- $L_f$  is the loss factor.

See Figure 4.

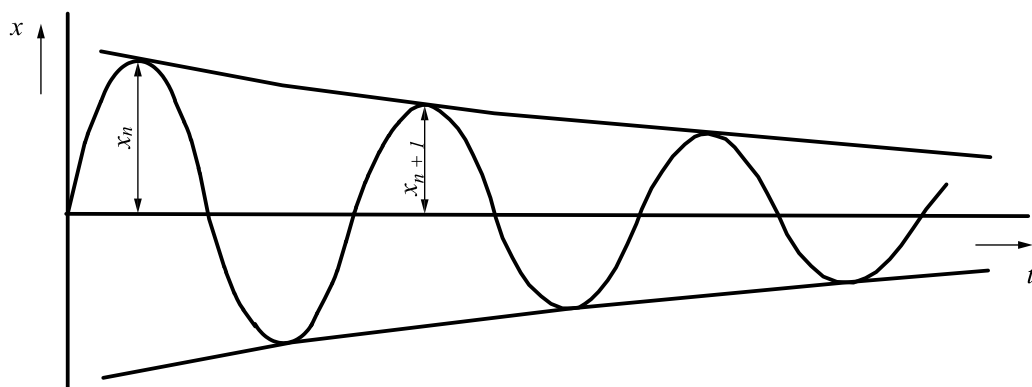

Figure 4 — Waveform for free-vibration method

## 5.6 Interdependence of frequency and temperature

The effects of frequency and temperature are interdependent, i.e. an increase in temperature can produce a similar change in modulus as a reduction in frequency, and *vice versa*. This can be used to make estimates of dynamic properties outside the measured range, for example at higher frequencies than an apparatus can achieve, by using results at lower temperatures.

Moduli  $M'(f, T)$  and  $M''(f, T)$  measured at a given frequency  $f$ , absolute temperature  $T$  and rubber density  $\rho$  can be transformed to "reduced" moduli  $M'(f \cdot a(T), T_0)$  and  $M''(f \cdot a(T), T_0)$  at standard laboratory temperature  $T_0$  and corresponding density  $\rho_0$  by using the relationships

$$M'(f, T) = \left( \frac{\rho \cdot T}{\rho_0 \cdot T_0} \right) \times M'(f \cdot a(T), T_0) \quad (13)$$

$$M''(f, T) = \left( \frac{\rho \cdot T}{\rho_0 \cdot T_0} \right) \times M''(f \cdot a(T), T_0) \quad (14)$$

where

- $a(T)$  is the Williams, Landel, Ferry (WLF) shift factor;
- $T$  is the test temperature (K);
- $T_0$  is the reference temperature (K);
- $f$  is the test frequency (Hz);
- $f \cdot a(T)$  is the reduced frequency (Hz);
- $\rho$  is the rubber density at the test temperature ( $\text{kg/m}^3$ );
- $\rho_0$  is the rubber density at standard laboratory temperature ( $\text{kg/m}^3$ ).

If these reduced moduli are plotted against log frequency, they group themselves in curves, one for each temperature. These curves can be reduced to a single composite curve by shifting each along the abscissa by a quantity  $a(T)$  given by the Williams, Landel, Ferry (WLF) equation:

$$\log_{10} [a(T)] = \frac{-c_1(T - T_0)}{c_2 + (T - T_0)} \quad (15)$$

The WLF equation can assume various forms of which the following is the most elegant, if not the most precise:

$$\log_{10} [a(T)] = \frac{-17,44(T - T_g)}{51,6 + (T - T_g)} \quad (16)$$

where  $T_g$  is the low-frequency (dilatometric) glass transition temperature.

Many refinements to the general procedures outlined here have been developed. Limitations arise especially due to fillers or crystalline zones and care shall be taken in applying the temperature/frequency transformation. It can be well suited to describing the large variations in a property observed when the temperature and frequency cover wide ranges, but is less applicable to the transformation of data obtained over limited ranges. Transformations greater than 1 decade from the measured data become less reliable.

## 6 Apparatus

All methods require the following basic elements:

- a) **Clamping or supporting arrangement** that permits the test piece to be held so that it acts as the elastic and viscous element in a mechanically oscillating system.
- b) **Device for applying an oscillatory load (stress) to the test piece.** The stress or strain can be applied as a single pulse, as in free-vibration apparatus, or can be continuously applied, as in forced-vibration apparatus. The preferred form of impressed strain is sinusoidal, and the strain shall be impressed on the test piece with a harmonic distortion which is as low as possible, and in no case greater than 10 %.
- c) **Detectors**, for determining dependent and independent experimental parameters such as force, deformation, frequency and temperature.
- d) **Oven and controller**, for maintaining the test piece at the required temperature.
- e) **Instruments for measuring test piece dimensions**, in accordance with ISO 23529.

Numerous forms of test machine have been developed and used successfully both by individual experimenters and commercial manufacturers. Figures 5 and 6 give typical examples of machines which have been used for testing small and large test pieces, respectively.

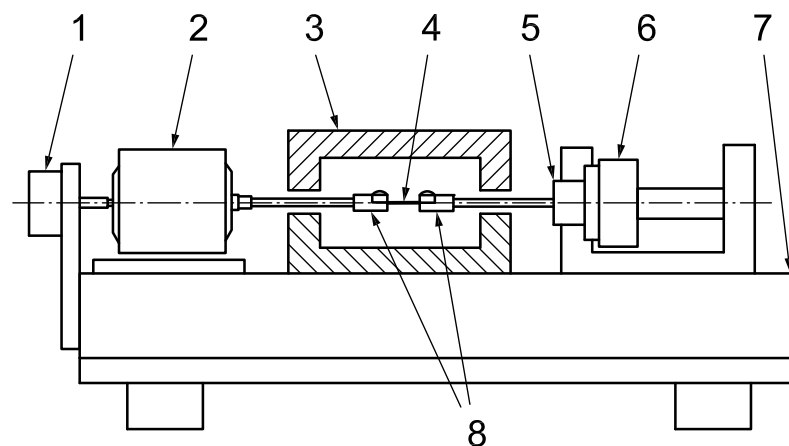

### Key

- |   |                       |   |                    |
|---|-----------------------|---|--------------------|
| 1 | displacement detector | 5 | load detector      |
| 2 | vibrator              | 6 | crosshead          |
| 3 | thermostatted chamber | 7 | main frame         |
| 4 | test piece            | 8 | test piece holders |

**Figure 5 — Example of small-sized test apparatus**

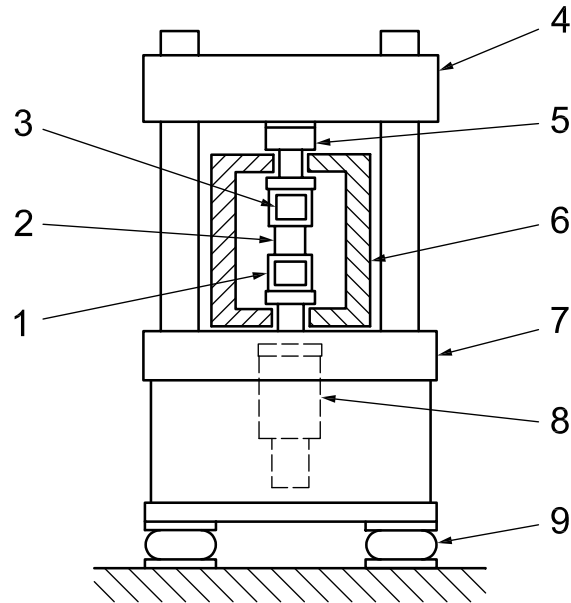

**Key**

- 1 lower test piece holder
- 2 test piece
- 3 upper test piece holder
- 4 crosshead
- 5 load detector
- 6 thermostatted chamber
- 7 main frame
- 8 actuator/displacement detector (velocity transducer, acceleration transducer)
- 9 air spring

**Figure 6 — Example of large-sized test apparatus**

## 7 Test conditions and test pieces

### 7.1 Test piece preparation

Test pieces can be moulded or cut from moulded sheet. Moulding is preferred for shear and compression test pieces. Metal plates for shear and compression test pieces can be bonded during moulding or bonded afterwards with a thin layer of suitable adhesive.

Test pieces can be obtained from some products by cutting and buffing. In other cases, it can be necessary or desired to test the complete product.

### 7.2 Test piece dimensions

Test piece shape and dimensions will vary according to the mode of deformation, the type of test machine and its capacity (see Tables 2 and 3).

The thickness of any metal plates which are bonded to the rubber during the vulcanization process shall be measured before moulding and the thickness of the rubber deduced by measurement of the overall thickness of the moulding.

### **7.3 Number of test pieces**

In order to obtain an indication of the variability of the material, it is recommended that a minimum of three test pieces or products be tested.

### **7.4 Test conditions**

#### **7.4.1 Strain**

Rubbers containing substantial quantities of fillers show viscoelastic behaviour that is dependent on the strain amplitude of the test. As a general principle, strain amplitudes shall be chosen to correspond to the strains experienced in service but, in practice, there can be restrictions because of machine capacity, the wish to operate in the linear part of the stress-strain curve and heat build-up.

Recommended values of strain amplitudes are given in Tables 2 and 3. Not all of these strain amplitudes will necessarily be required for a given series of tests. If one strain amplitude is used, it shall be the preferred value.

In practice, the lowest strain level achievable will be limited by machine sensitivity and the highest strain level by the machine, especially at higher frequencies and at temperatures near the glass transition.

In service, products can be subjected to a dynamic strain superimposed on a static strain, and the static strain does not necessarily give the same mode of deformation. To obtain data more relevant to such conditions, the dynamic strains recommended here can be superimposed on any level or form of static strain. This can be particularly relevant to testing products and is usually applied to compression test pieces.

In certain cases, a material can be characterized better by conducting the tests under an applied stress. In such cases, the test conditions shall be agreed on between the interested parties.

#### **7.4.2 Frequency and temperature**

Rubbers show viscoelastic behaviour which is frequency- and temperature-dependent. This dependence is very marked near transitions. As a consequence, frequencies and temperatures relevant to service shall be chosen or, particularly when characterizing materials, tests over a range of frequencies and temperatures carried out.

Recommended values are given in Tables 2 and 3.

### 7.5 Small-sized test apparatus

The basic principles of dynamic testing using a small-sized test apparatus and the forced-vibration non-resonance method are given in Table 2.

**Table 2 — Test conditions and test pieces for small-sized test apparatus**

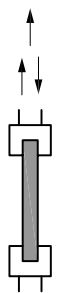
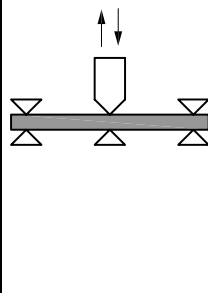
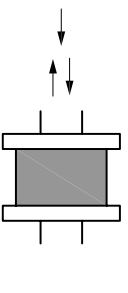
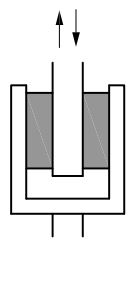
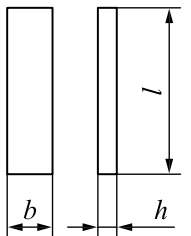
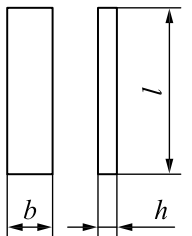
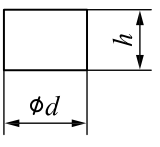
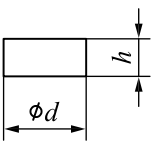
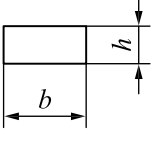
		Mode of deformation				Comments
		Tension	Bending	Compression	Shear	
Type of test piece and mode of deformation (strain) ↑ and ↓ = Mean static strain ↑ ↓ = Dynamic strain						The bending method is usually applied to relatively stiff and inextensible materials such as rubber/fibre composite materials.
Test piece shapes and dimensions		<b>Rectangular strip</b>  $h = 1 \text{ mm to } 3 \text{ mm}$ $b = 4 \text{ mm to } 12 \text{ mm}$ $l = 20 \text{ mm to } 60 \text{ mm}$ The distance between holders is preferably 2,5 to 5 times the width $b$ .	<b>Rectangular strip</b>  The distance between the bending support points is preferably 16 times the thickness $h$ . $h = 1 \text{ mm to } 3 \text{ mm}$	<b>Cylinder</b>  $h:d = \text{about } 1:1,5$ $h = 1 \text{ mm to } 5 \text{ mm}$	<b>Cylinder</b>  $d \geq 4h$ $h \leq 12 \text{ mm}$ <b>Rectangular column</b>  $b = \text{length of each side}$ $b \geq 4h$ $h \leq 12 \text{ mm}$	For the tension and bending methods, the measured dimensions of the test piece shall include the thickness, width, and distance between the grips or distance between the bending support points.  For the compression and shear methods, they shall include the thickness, width, and diameter or lengths of the sides.  Each dimensional tolerance shall be maintained to within $\pm 1 \%$ .
Test conditions	Mean strain, %	1 to 10	0	1 to 10	0	For bench analysis, values will depend on the machine parameters.
	Strain amplitude, %	$\pm 0,5, \pm 1, \pm 2$ Can also be a continuous scan				The maximum tolerance of the detector should preferably be within $\pm 1 \%$ .
	Frequency, Hz	1, 5, 10, 15, 30, 50, 100, 150, 200 Can also be a continuous scan				The maximum tolerance on the frequency shall be within $\pm 2 \%$ .
	Test temperature, °C	Select from ISO 23529, although smaller intervals can be necessary in transition regions where properties are changing rapidly. Can also be a continuous temperature scan. A rate of $1 \text{ }^\circ\text{C}/\text{min}$ is recommended.				The maximum tolerance of the detector should preferably be within $\pm 1 \text{ }^\circ\text{C}$ .
Parameters required		$ M^* , M', M'', \tan \delta$				For dynamic tests with small-sized apparatus, the effect of temperature is frequently depicted graphically.



## 7.6 Large-sized test apparatus

The basic principles of dynamic test using the large-sized test apparatus and the forced-vibration non-resonance method are given in Table 3.

Table 3 — Test conditions and test pieces for large-sized test apparatus

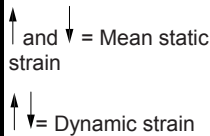
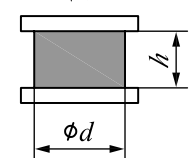
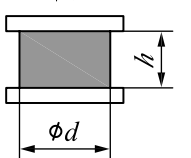
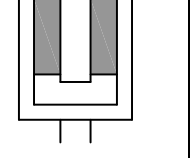
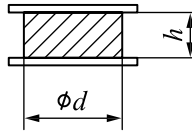
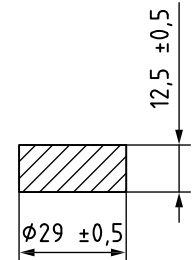
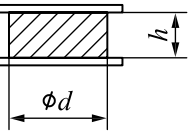
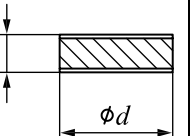
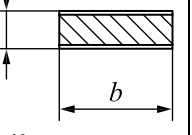
		Mode of deformation			Comments
		Compression	Tension	Shear	
Type of test piece and mode of deformation (strain) 					<p>For large-sized test apparatus, shear deformation is preferable to compression or tension because in shear the relation between stress and strain is more nearly linear and the hysteresis curve is nearly equal to an ellipse.</p> <p>Two test pieces are usually used in shear to give a symmetrical arrangement, which avoids bending moments.</p> <p>Alternatively, torsional shear can be used.</p>
Test piece shapes and dimensions		<p><b>Cylinder with metal fittings</b></p>  <p><math>h:d = \text{about } 1:1,5</math></p> <p><b>Cylinder</b></p>  <p>See ISO 7743</p> <p>For unbonded test pieces, the test pieces specified in ISO 815-1 are convenient and widely used.</p>	<p><b>Cylinder with metal fittings</b></p>  <p><math>h:d = \text{about } 1:1,5</math></p>	<p><b>Cylinder with metal fittings</b></p>  <p><math>d \geq 4h</math> <math>h \leq 12 \text{ mm}</math></p> <p><b>Rectangular column with metal fittings</b></p>  <p><math>b \geq 4h</math> <math>h \leq 12 \text{ mm}</math></p>	<p>The shapes and dimensions of the test pieces shall be selected to meet the requirements of the relevant type and capacity of test apparatus specified.</p> <p>The metal fittings for the test piece shall be vulcanized to the rubber. The cylindrical test piece for the compression method shall be as specified in ISO 7743.</p>
Test conditions	Mean strain, %	10	5 to 20	0	<p>The maximum tolerance of the detector should preferably be within <math>\pm 1</math> %.</p> <p>The average strain and strain amplitude used shall be determined by measuring the mean deflection and deflection amplitude with a test piece of suitable thickness.</p>
	Strain amplitude, %	$\pm 2, \pm 5$ Can also be a continuous scan	$\pm 0,2 \text{ to } \pm 10$	$\pm 1, \pm 3, \pm 6, \pm 10, \pm 15$	
	Frequency, Hz	1, 5, 10, 15, 30, 50, 100, 150, 200 Can also be a continuous scan			The maximum tolerance on the frequency shall be within $\pm 2$ %.
	Test temperature, °C	Select from ISO 23529			The maximum tolerance of the detector should preferably be within $\pm 1$ °C.
Parameters required		$ M^* , M', M'', \tan \delta$			For the compression test method using a cylindrical test piece, a spring constant (for example $ K^* , K', K'', L_t$ ) can be replaced by an elastic modulus.

## 7.7 Dynamic testing using free vibration

The basic principles of dynamic testing using the free-vibration method are as follows:

### a) Test piece dimensions

Rectangular strips of thickness between 1 mm and 3 mm, of width between 4 mm and 12 mm (subject to a maximum width to thickness ratio of 10) and of length between the clamps at least 10 times the width (subject to a maximum of 120 mm) are preferred. The thickness, width and distance between grips shall be measured to  $\pm 1$  %.

### b) Test conditions

Strain amplitude 0,5 % max.

Frequency 0,1 Hz to 10 Hz.

Temperature Continuous scans of properties against temperature may be obtained or temperatures selected from ISO 23529.

## 8 Conditioning

### 8.1 Storage

The time lapse between vulcanization and testing shall be in accordance with ISO 23529.

### 8.2 Temperature

Test pieces shall be conditioned at a standard laboratory temperature for not less than 3 h immediately before a sequence of tests. At each temperature, it is essential that the test piece be conditioned for sufficient time to reach equilibrium, but conditioning shall be no longer than is necessary, particularly at higher temperatures, to avoid ageing effects. The conditioning time depends on the test piece dimensions and the temperature. Guidance is given in ISO 23529.

### 8.3 Mechanical conditioning

Dynamic properties of filled rubbers are dependent on their strain history and temperature history, and it is necessary to pre-condition the test pieces to obtain consistent and reproducible results.

The test pieces shall be mechanically conditioned before being tested (sometimes referred to as "scragging") to remove irreversible "structure". The conditioning shall consist of at least six cycles at the maximum strain and temperature to be used in the test series.

A minimum of 12 h is recommended between mechanical conditioning and testing to allow reversible "structure" to equilibrate.

Where the dynamic test is to be superimposed on a static pre-strain, the test piece shall be held at the static strain during the rest period.

This mechanical conditioning can generally be omitted when only a single, very small, strain is used as, for example, in free vibration.

## 9 Test procedure

If a test piece is to be tested under more than one set of conditions, measurements shall begin with the least severe conditions and then proceed to larger amplitudes and higher frequencies. In the case of testing at different temperatures, the test chamber shall be adjusted to the lowest specified temperature and, after the test pieces have tested at that temperature, the chamber shall be raised to the next temperature required.

For forced-vibration tests, measurement shall be made after at least six cycles have been applied to reach near-equilibrium. At low amplitudes and frequencies, there is no need to restrict the length of time for which cycling is continued. However, at higher amplitudes and frequencies there is an increasing danger of heat build-up in the test piece, and the test time shall be as short as possible, especially at or near transitions.

The temperature rise can be estimated as follows:

The energy loss per unit volume per cycle is

$$\pi \sin \delta (|M^*| \gamma_0^2)$$

Thus the rate of rise in temperature when there are no heat losses from the test piece is as follows:

$$\pi \sin \delta (|M^*| \gamma_0^2 f / C_p)$$

where  $C_p$  is the heat capacity per unit volume [a typical value is 1,7 MJ/(m<sup>3</sup>·°C)].

If time-dependent changes which can be attributed to a temperature rise occur during the test, the results can be extrapolated to the nominal test temperature. Alternatively, in the case of products, there can be circumstances when it is more appropriate to continue testing until equilibrium is reached.

NOTE To determine the dynamic properties of a material under given experimental conditions (frequency and temperature), it is also possible to perform tests at different temperatures and frequencies and to use the WLF time-temperature interdependence principle (see 5.6).

## 10 Expression of results

### 10.1 Parameters required

Generally, the in-phase, out-of-phase and complex moduli (or complex spring constants) and  $\tan \delta$  (or  $L_f$ ) are required. Where appropriate, these are best presented in tables or graphically as a function of temperature, frequency and amplitude.

### 10.2 Forced vibration

The parameters can be derived from the load-deflection curve, an example of which is shown in Figure 7. This can be achieved by suitable electronic analysis techniques without the need to record the load-deflection loop. However, with filled rubbers and at higher amplitudes, non-linear behaviour can be exhibited and the hysteresis loop will deviate from a perfect ellipse, which complicates the derivation of the parameters.

Figure 7 shows a load-deflection loop obtained from a dynamic test on a double-shear test piece. The origin O represents the mean values of the load and deflection and, if a static deflection is imposed, will not be the zero values. The loads and deflections shown are thus the dynamic components.

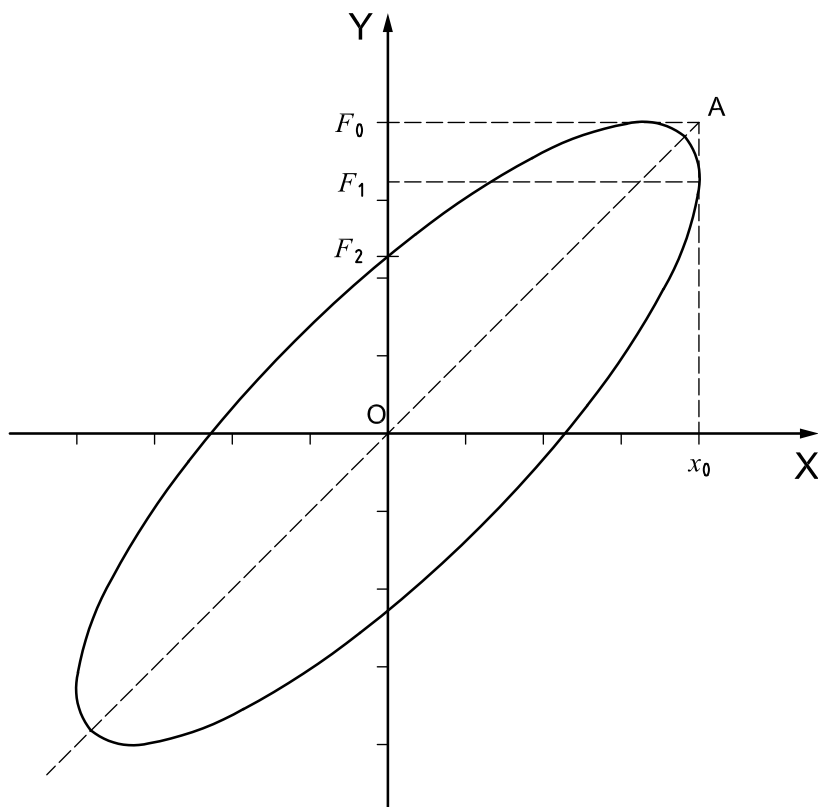

**Key**

X deflection

Y load

**Figure 7 — Load-deflection curve**

If the behaviour of the rubber is linear, the loop shown in Figure 7 will be an ellipse. In this case, for the double-shear test piece, the absolute value of the complex modulus is given by the following equation:

$$|G^*| = \frac{F_0 h}{2Ax_0} \quad (17)$$

where

$F_0$  and  $x_0$  are the maximum load amplitude and maximum deflection amplitude, respectively;

$A$  is the test piece cross-sectional area (m<sup>2</sup>);

$h$  is the test piece thickness (m).

Thus  $F_0/x_0$  is given (see Figure 7) by the slope of the line OA which is the diagonal of the circumscribed rectangle. The loss angle is given by

$$\tan \delta = \frac{G''}{G'} \quad (18)$$

The elastic shear modulus  $G'$  is given by

$$G' = |G^*| \cos \delta \quad (19)$$

and the loss shear modulus  $G''$  by

$$G'' = |G^*| \sin \delta \quad (20)$$

The loss angle is also given by

$$\sin \delta = \frac{\text{Area of ellipse}}{\pi F_0 x_0} \quad (21)$$

This latter relation can be particularly useful when there is some non-linearity and the ellipse is not perfect, as it will give an average value.

Similar expressions apply to other modes of deformation and other test piece geometries.

### 10.3 Free vibration

For rotational oscillation, the parameters required are obtained from the solution to the equations of motion [Equations (8) and (9)] given in 5.5.2 and the relationship for torsion [Equation (25)] given in 10.4.

The logarithmic decrement is obtained from a trace of displacement (or velocity) against time.

### 10.4 Stress-strain relationships and shape factors

In shear, stress can be taken as proportional to strain as follows:

$$\tau = G \gamma \quad (22)$$

With the recommended test piece, no shape factor correction is necessary.

In tension or compression, the stress-strain relationship is better represented by

$$\tau = \frac{E}{3} (\lambda - \lambda^{-2}) \quad (23)$$

where

$\tau$  is the stress with reference the to initial cross-section (Pa);

$E$  is Young's modulus (Pa);

$\lambda$  is the extension ratio.

For compression test pieces with bonded ends, a shape factor shall be applied:

$$E_c = E (1 + 2kS^2) \quad (\text{see ISO 7743:2011, Annex B}) \quad (24)$$

where

$E_c$  is the effective Young's modulus (Pa);

$k$  is a numerical factor;

$S$  is the shape factor in compression.

In torsion, with a rectangular strip,

$$Q = \frac{k_l b h^3 G \alpha}{l} \quad (25)$$

where

- $Q$  is the torque (N·m);
- $k_l$  is the shape factor in torsion;
- $\alpha$  is the angle of twist (rad);
- $b$  is the test piece width (m);
- $h$  is the test piece thickness (m);
- $G$  is the shear modulus (Pa);
- $l$  is the test piece length (m).

Because the relationship between dynamic stiffness and basic modulus can be complex and only approximate, it can be preferable, particularly for products, to work in stiffness.

## 11 Test report

The test report shall include the following information:

a) sample details:

- 1) a full description of the sample and its origin,
- 2) the method of preparation of the test pieces from the sample, for example moulded or cut;

b) test method:

- 1) a reference to the test method used, i.e. the number of this part of ISO 4664,
- 2) the test procedure used,
- 3) the type of test piece used;

c) test details:

- 1) the laboratory temperature,
- 2) the mode of deformation,
- 3) the mechanical and thermal conditioning procedures used,
- 4) details of the test machine, including type, drive, capacity and measurement systems,
- 5) the test conditions, including strain amplitude, frequency and temperature, as appropriate,
- 6) the number of test pieces used,
- 7) details of any procedures not specified in this part of ISO 4664;

- d) test results:
  - 1) details of the procedures used to calculate the results,
  - 2) the values of the properties determined;
- e) the date of testing.







# British Standards Institution (BSI)

BSI is the national body responsible for preparing British Standards and other standards-related publications, information and services.

BSI is incorporated by Royal Charter. British Standards and other standardization products are published by BSI Standards Limited.

## About us

We bring together business, industry, government, consumers, innovators and others to shape their combined experience and expertise into standards-based solutions.

The knowledge embodied in our standards has been carefully assembled in a dependable format and refined through our open consultation process. Organizations of all sizes and across all sectors choose standards to help them achieve their goals.

## Information on standards

We can provide you with the knowledge that your organization needs to succeed. Find out more about British Standards by visiting our website at [bsigroup.com/standards](http://bsigroup.com/standards) or contacting our Customer Services team or Knowledge Centre.

## Buying standards

You can buy and download PDF versions of BSI publications, including British and adopted European and international standards, through our website at [bsigroup.com/shop](http://bsigroup.com/shop), where hard copies can also be purchased.

If you need international and foreign standards from other Standards Development Organizations, hard copies can be ordered from our Customer Services team.

## Subscriptions

Our range of subscription services are designed to make using standards easier for you. For further information on our subscription products go to [bsigroup.com/subscriptions](http://bsigroup.com/subscriptions).

With **British Standards Online (BSOL)** you'll have instant access to over 55,000 British and adopted European and international standards from your desktop. It's available 24/7 and is refreshed daily so you'll always be up to date.

You can keep in touch with standards developments and receive substantial discounts on the purchase price of standards, both in single copy and subscription format, by becoming a **BSI Subscribing Member**.

**PLUS** is an updating service exclusive to BSI Subscribing Members. You will automatically receive the latest hard copy of your standards when they're revised or replaced.

To find out more about becoming a BSI Subscribing Member and the benefits of membership, please visit [bsigroup.com/shop](http://bsigroup.com/shop).

With a **Multi-User Network Licence (MUNL)** you are able to host standards publications on your intranet. Licences can cover as few or as many users as you wish. With updates supplied as soon as they're available, you can be sure your documentation is current. For further information, email [bsmusales@bsigroup.com](mailto:bsmusales@bsigroup.com).

## BSI Group Headquarters

389 Chiswick High Road London W4 4AL UK

## Revisions

Our British Standards and other publications are updated by amendment or revision.

We continually improve the quality of our products and services to benefit your business. If you find an inaccuracy or ambiguity within a British Standard or other BSI publication please inform the Knowledge Centre.

## Copyright

All the data, software and documentation set out in all British Standards and other BSI publications are the property of and copyrighted by BSI, or some person or entity that owns copyright in the information used (such as the international standardization bodies) and has formally licensed such information to BSI for commercial publication and use. Except as permitted under the Copyright, Designs and Patents Act 1988 no extract may be reproduced, stored in a retrieval system or transmitted in any form or by any means – electronic, photocopying, recording or otherwise – without prior written permission from BSI. Details and advice can be obtained from the Copyright & Licensing Department.

## Useful Contacts:

### Customer Services

**Tel:** +44 845 086 9001

**Email (orders):** [orders@bsigroup.com](mailto:orders@bsigroup.com)

**Email (enquiries):** [cservices@bsigroup.com](mailto:cservices@bsigroup.com)

### Subscriptions

**Tel:** +44 845 086 9001

**Email:** [subscriptions@bsigroup.com](mailto:subscriptions@bsigroup.com)

### Knowledge Centre

**Tel:** +44 20 8996 7004

**Email:** [knowledgecentre@bsigroup.com](mailto:knowledgecentre@bsigroup.com)

### Copyright & Licensing

**Tel:** +44 20 8996 7070

**Email:** [copyright@bsigroup.com](mailto:copyright@bsigroup.com)



...making excellence a habit.™