

BS ISO 4309:2010



BSI Standards Publication

Cranes — Wire ropes — Care and maintenance, inspection and discard

NO COPYING WITHOUT BSI PERMISSION EXCEPT AS PERMITTED BY COPYRIGHT LAW

raising standards worldwide™

Copyright British Standards Institution
Provided by IHS under license with BSI - Uncontrolled Copy
No reproduction or networking permitted without license from IHS

Not for Resale



National foreword

This British Standard is the UK implementation of ISO 4309:2010. It supersedes BS ISO 4309:2004+A1:2008 which is withdrawn.

The UK participation in its preparation was entrusted to Technical Committee MHE/3, Cranes and derricks.

A list of organizations represented on this committee can be obtained on request to its secretary.

This publication does not purport to include all the necessary provisions of a contract. Users are responsible for its correct application.

© BSI 2010

ISBN 978 0 580 59980 4

ICS 53.020.30

Compliance with a British Standard cannot confer immunity from legal obligations.

This British Standard was published under the authority of the Standards Policy and Strategy Committee on 31 August 2010.

Amendments issued since publication

Date	Text affected
------	---------------

INTERNATIONAL STANDARD

BS ISO 4309:2010

ISO
4309

Fourth edition
2010-08-01

Cranes — Wire ropes — Care and maintenance, inspection and discard

*Appareils de levage à charge suspendue — Câbles — Entretien
et maintenance, inspection et dépose*



Reference number
ISO 4309:2010(E)

© ISO 2010

PDF disclaimer

This PDF file may contain embedded typefaces. In accordance with Adobe's licensing policy, this file may be printed or viewed but shall not be edited unless the typefaces which are embedded are licensed to and installed on the computer performing the editing. In downloading this file, parties accept therein the responsibility of not infringing Adobe's licensing policy. The ISO Central Secretariat accepts no liability in this area.

Adobe is a trademark of Adobe Systems Incorporated.

Details of the software products used to create this PDF file can be found in the General Info relative to the file; the PDF-creation parameters were optimized for printing. Every care has been taken to ensure that the file is suitable for use by ISO member bodies. In the unlikely event that a problem relating to it is found, please inform the Central Secretariat at the address given below.



COPYRIGHT PROTECTED DOCUMENT

© ISO 2010

All rights reserved. Unless otherwise specified, no part of this publication may be reproduced or utilized in any form or by any means, electronic or mechanical, including photocopying and microfilm, without permission in writing from either ISO at the address below or ISO's member body in the country of the requester.

ISO copyright office
Case postale 56 • CH-1211 Geneva 20
Tel. + 41 22 749 01 11
Fax + 41 22 749 09 47
E-mail copyright@iso.org
Web www.iso.org

Published in Switzerland

Contents

Page

Foreword.....	iv
Introduction	v
1 Scope	1
2 Normative references	2
3 Terms and definitions.....	2
4 Care and maintenance.....	3
4.1 General.....	3
4.2 Rope replacement.....	3
4.3 Offloading and storing the rope	5
4.4 Condition of the rope prior to installation.....	5
4.5 Installing the rope	5
4.6 Running-in the new rope.....	8
4.7 Maintaining the rope.....	9
4.8 Maintenance of rope-related parts of the crane	9
5 Inspection	10
5.1 General.....	10
5.2 Daily visual inspection	10
5.3 Periodic inspection.....	10
5.4 Inspection following an incident.....	13
5.5 Inspection following period with crane out of operation.....	13
5.6 Non-destructive testing.....	13
6 Discard criteria	14
6.1 General.....	14
6.2 Visible broken wires	14
6.3 Decrease in rope diameter.....	17
6.4 Fracture of strands	19
6.5 Corrosion.....	19
6.6 Deformation and damage.....	20
Annex A (informative) Key areas requiring particular close inspection.....	23
Annex B (informative) Typical modes of deterioration.....	25
Annex C (informative) Internal examination of rope.....	34
Annex D (informative) Typical examples of inspection record.....	37
Annex E (informative) Useful information on rope deterioration and discard criteria.....	39
Annex F (informative) Combined effect assessment of rope condition and severity rating — One method	42
Annex G (informative) Examples of cross-sections of ropes and corresponding rope category number (RCN).....	45
Annex H (informative) Guidance on assessment and rating of external corrosion	51
Bibliography	53

Foreword

ISO (the International Organization for Standardization) is a worldwide federation of national standards bodies (ISO member bodies). The work of preparing International Standards is normally carried out through ISO technical committees. Each member body interested in a subject for which a technical committee has been established has the right to be represented on that committee. International organizations, governmental and non-governmental, in liaison with ISO, also take part in the work. ISO collaborates closely with the International Electrotechnical Commission (IEC) on all matters of electrotechnical standardization.

International Standards are drafted in accordance with the rules given in the ISO/IEC Directives, Part 2.

The main task of technical committees is to prepare International Standards. Draft International Standards adopted by the technical committees are circulated to the member bodies for voting. Publication as an International Standard requires approval by at least 75 % of the member bodies casting a vote.

Attention is drawn to the possibility that some of the elements of this document may be the subject of patent rights. ISO shall not be held responsible for identifying any or all such patent rights.

ISO 4309 was prepared by Technical Committee ISO/TC 96, *Cranes*, Subcommittee SC 3, *Selection of wire ropes*.

This fourth edition cancels and replaces the third edition (ISO 4309:2004), which has been technically revised. It also incorporates the Amendment ISO 4309:2004/Amd.1:2008.

Introduction

A wire rope on a crane is regarded as an expendable component, requiring replacement when the results of inspection indicate that its condition has diminished to the point where further use would be unwise from a safety standpoint.

By following well-established principles, such as those detailed in this International Standard, along with any additional specific instructions provided by the manufacturer of the crane or hoist and/or by the manufacturer of the rope, this point should never be exceeded.

In addition to encompassing the guidance on storage, handling, installation and maintenance, which was first introduced in the last revision, this International Standard also provides discard criteria for those running ropes which are subjected to multi-layer spooling, where both field experience and testing demonstrate that deterioration is significantly greater at the cross-over zones on the drum, than at any other section of rope in the system.

It also provides more realistic discard criteria covering decrease in rope diameter and corrosion, and gives one method for assessing the combined effect of deterioration at any position in the rope.

When correctly applied, the discard criteria given in this International Standard are aimed at retaining an adequate safety margin. Failure to recognize them can be extremely harmful, dangerous and damaging.

To assist those who are responsible for “care and maintenance” as distinct from those who are responsible for “inspection and discard”, the procedures are conveniently separated.

Cranes — Wire ropes — Care and maintenance, inspection and discard

1 Scope

This International Standard establishes general principles for the care and maintenance, and inspection and discard of steel wire ropes used on cranes and hoists.

This International Standard is applicable to those ropes used on the following types of cranes, the majority of which are defined in ISO 4306-1:

- a) cable and portal cable cranes;
- b) cantilever cranes (pillar jib, wall or walking);
- c) deck cranes;
- d) derrick and guy derrick cranes;
- e) derrick cranes with rigid bracing;
- f) floating cranes;
- g) mobile cranes;
- h) overhead travelling cranes;
- i) portal or semi-portal bridge cranes;
- j) portal or semi-portal cranes;
- k) railway cranes;
- l) tower cranes;
- m) offshore cranes, i.e. cranes mounted on a fixed structure supported by the sea bed or on a floating unit supported by buoyancy forces.

This International Standard applies to rope on cranes used for hook, grabbing, magnet, ladle, excavator or stacking duties, whether operated manually, electrically or hydraulically.

This International Standard also applies to rope used on hoists and hoist blocks.

In view of the fact that the exclusive use of synthetic sheaves or metal sheaves incorporating synthetic linings is not recommended when single-layer spooling at the drum, due to the inevitability of wire breaks occurring internally in large numbers before there is any visible evidence of any wire breaks or signs of substantial wear on the periphery of the rope, no discard criteria are given for this combination.

2 Normative references

The following referenced documents are indispensable for the application of this document. For dated references, only the edition cited applies. For undated references, the latest edition of the referenced document (including any amendments) applies.

ISO 17893, *Steel wire ropes — Vocabulary, designation and classification*

3 Terms and definitions

For the purposes of this document, the terms and definitions given in ISO 17893 and the following apply.

3.1 nominal diameter

d
diameter by which the rope is designated

3.2 measured diameter

actual diameter
 d_m
average of two measurements, taken at right angles to one another, of the diameter that circumscribes the rope cross-section

3.3 reference diameter

d_{ref}
measured diameter of a section of rope that is not subject to bending, taken directly after the rope has been broken in

NOTE This diameter is used as the baseline for uniform decrease in diameter.

3.4 cross-over zone

that portion of rope coincident with a crossing over of one wrap by another as the rope traverses the drum or rises from one layer to the next at the drum flange

3.5 wrap

one revolution of rope around a drum

3.6 reel

flanged spool on which rope is wound for shipment or storage

3.7 wire rope periodic inspection

in-depth visual inspection of the rope plus measurement of the rope and, if practicable, an assessment of its internal condition

NOTE This is sometimes referred to as a “thorough examination”.

3.8 competent person

(wire rope inspection) person having such knowledge and experience of wire ropes on cranes and hoists as is necessary for that person to assess the condition of the rope, make a judgement as to whether it may remain in service and stipulate the maximum time interval between inspections

3.9

valley wire break

wire break that occurs at the inter-strand contact point or valley area between two outer strands

NOTE Outer wire breaks that also occur within the rope anywhere between one valley area and the next, including any strand-core breaks, may also be regarded as valley wire breaks.

3.10

severity rating

amount of deterioration expressed as a per cent towards discard

NOTE The rating may relate to either an individual mode of deterioration, e.g. broken wires or decrease in diameter, or the combined effect of more than one mode of deterioration, e.g. broken wires and decrease in diameter.

4 Care and maintenance

4.1 General

In the absence of any instructions provided by the manufacturer of the crane in his manual and/or any provided by the manufacturer or supplier of the rope, the general principles given in 4.2 to 4.7 shall be followed.

4.2 Rope replacement

Unless an alternative rope has been approved of by the crane manufacturer, rope manufacturer or other competent person, only one of the correct length, diameter, construction, type and direction of lay and strength (i.e. minimum breaking force), as specified by the crane manufacturer, shall be installed on the crane. A record of the rope change shall be placed on file.

In the case of larger diameter rotation-resistant ropes, it may be necessary to apply additional means of securing the rope ends, e.g. through the use of steel straps, particularly when preparing samples for test.

If the length of rope required for use is to be cut from a longer length, such as a bulk manufactured reel of rope, servings shall be applied at both sides of the intended cutting point to prevent the rope from unlaying (i.e. unravelling) after the cut has been made.

Figure 1 is an example of how a single-layer rope should be served before cutting. For rotation-resistant and parallel-closed ropes, multiple length servings may be necessary. Ropes that are only lightly preformed are more likely to unlay (i.e. unravel) after cutting, if inadequate or insufficient servings are applied.

NOTE Serving is sometimes referred to as "seizing".

Unless an alternative rope termination has been approved of by the crane manufacturer, rope manufacturer or other competent person, only one of a type, as specified by the crane manufacturer in his manual, shall be used to attach a rope to a drum, hook block or anchor point on the machinery structure.

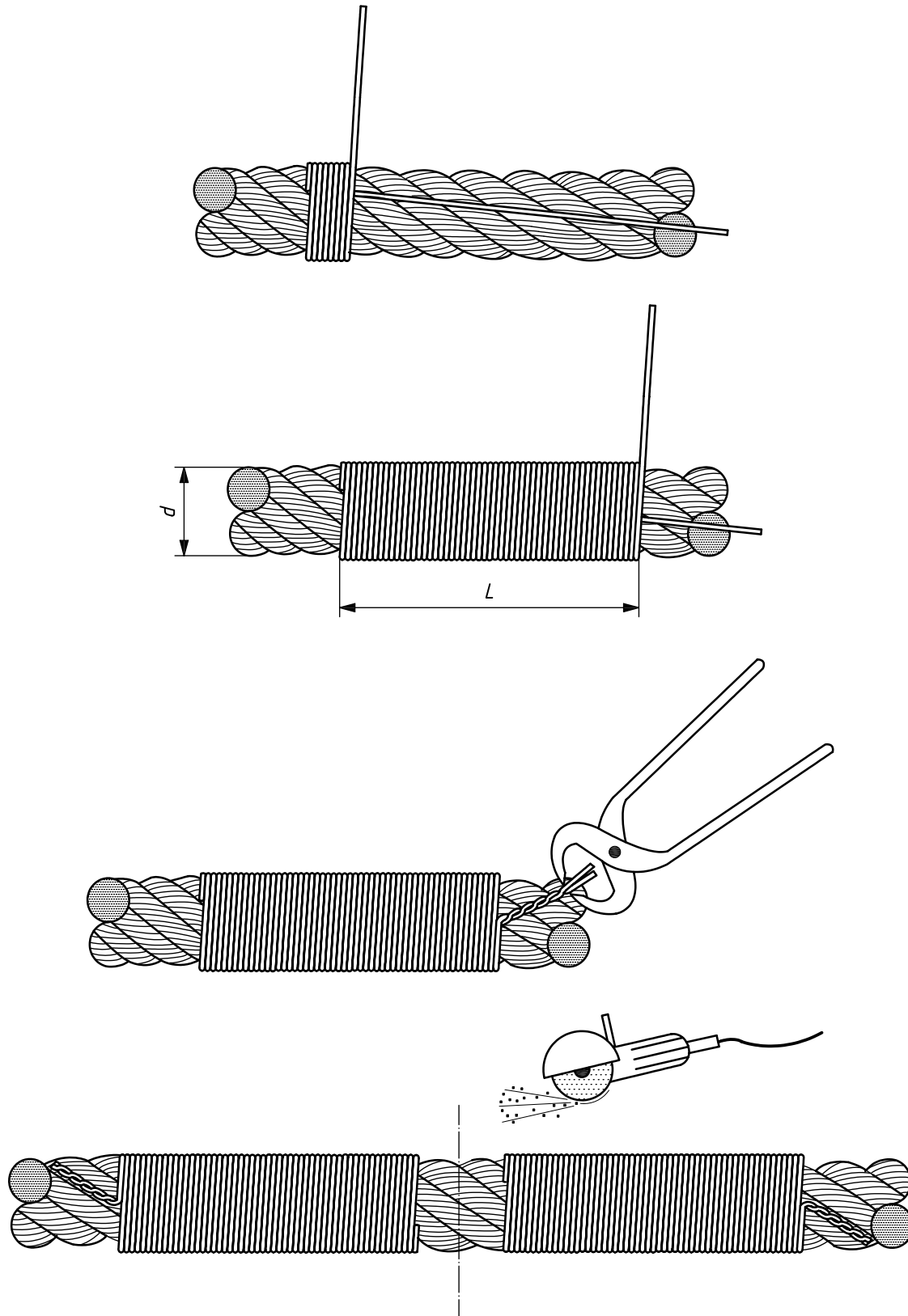

$L = 2d$ minimum

Figure 1 — Application of serving prior to cutting of single-layer type rope

4.3 Offloading and storing the rope

To avoid accidents and/or damage to the rope itself, ropes should be offloaded with care.

Reels or coils of rope shall not be dropped, neither shall they be struck by a metal hook or fork of a lift truck or any other external force that could damage or deform the rope.

Ropes should be stored in a cool, dry building and should not be allowed to be in contact with the floor. They should not be stored where they are likely to be affected by chemicals, chemical fumes, steam or other corrosive agents.

If outdoor storage cannot be avoided, ropes should be covered so that moisture cannot induce corrosion.

Ropes in storage shall be checked periodically for any signs of deterioration such as surface corrosion and, if deemed necessary by a competent person, dressed with a suitable preservative or lubricant which is compatible with the rope manufacturing lubricant.

In warm environments, the reel shall be periodically rotated one half-turn to prevent drainage of lubricant from the rope.

4.4 Condition of the rope prior to installation

Before installing the rope, and preferably on receipt, the rope and its certificate should be checked to ensure that the rope is in accordance with that ordered.

The strength of the rope to be installed shall not be lower than that specified by the crane manufacturer.

The diameter of the new rope shall be measured with the rope under no tension and the value recorded.

Check the condition of all sheave and drum grooves to ensure that they are capable of accepting the size of the new rope, do not contain any irregularities, such as corrugations, and have sufficient remaining thickness to safely support the rope.

For optimal performance, the effective sheave groove diameter should be larger than the nominal rope diameter by about 5 % to 10 %, and ideally, at least 1 % greater than the actual diameter of the new rope.

4.5 Installing the rope

When uncoiling and/or installing a wire rope, every precaution shall be taken to avoid inducing turn into, or out of, the rope. Allowing this to occur can result in the formation of loops, kinks or bends in the rope, rendering it unfit for use.

In order to prevent any of these developing, the rope should be paid out in a straight line with a minimum of slack being allowed to occur (see Figure 2).

Rope supplied in a coil should be placed on a turntable and paid out straight; however, where the coiled length is short, the outer rope end may be made free and the remainder of the rope rolled along the ground [see Figure 2 a)].

A rope shall never be paid out by throwing off wraps when the coil or reel is flat on the ground or by rolling the reel along the ground (see Figure 3).

For those lengths of rope supplied on a reel, place the supply reel and its supporting stand or cradle as far away from the crane or hoist as possible, in order to limit any fleet angle effects to an absolute minimum, thus avoiding any undesirable rotational effects.

Protect the rope from any potential ingress or grit or other contaminants by running it on suitable matting (e.g. used conveyor belting), rather than allowing it to run directly on the ground.

Be aware that a revolving reel of rope can have a high inertia, in which case it needs to be controlled in order to slowly pay out the rope. For smaller reels, this is usually achieved by employing a single brake (see Figure 4). Larger reels have significant inertia once they start to revolve and might need to be substantially braked.

As far as practically possible, ensure that the rope always bends in the same direction during installation, i.e. pay out the rope from the top of the supply reel to the top of the drum on the crane or hoist (referred to as “top to top”), or from the underneath of the supply reel to the underneath of the drum on the crane or hoist (referred to as “bottom to bottom”). For an example of “bottom to bottom”, see Figure 4.

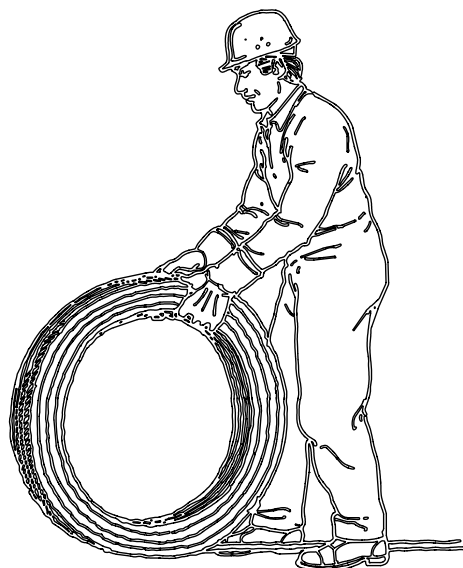

a) From a coil

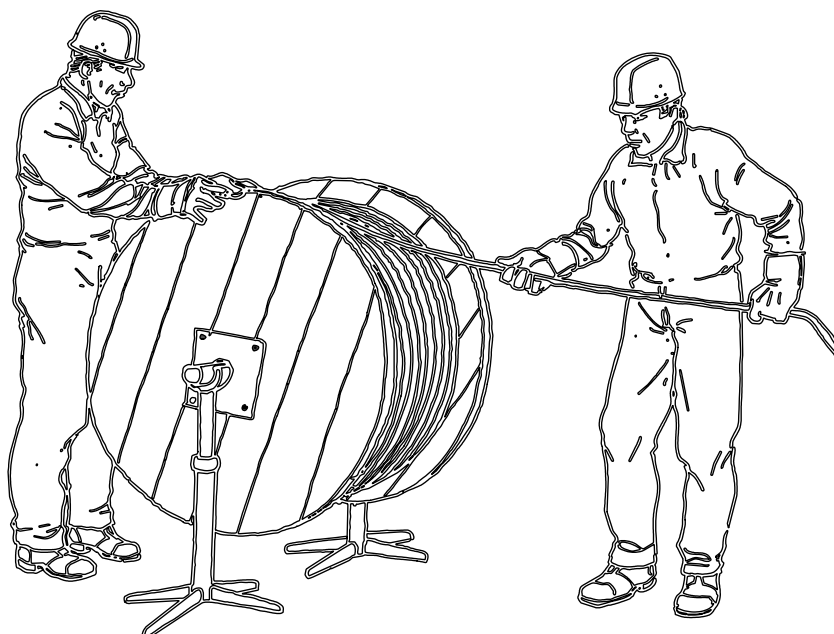

b) From a reel

Figure 2 — Correct procedures for uncoiling a wire rope

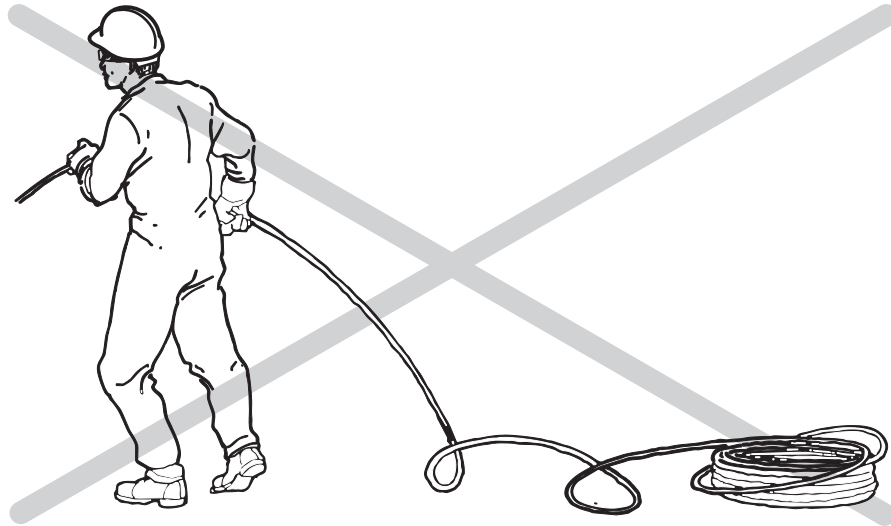

a) From a coil



b) From a reel

Figure 3 — Incorrect procedures for uncoiling a wire rope (continued)

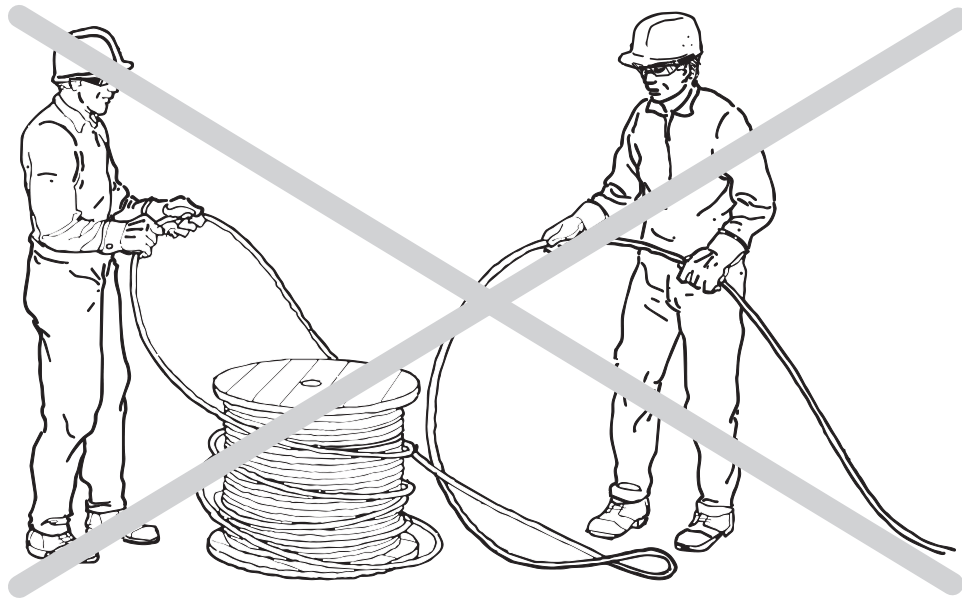

c) From the reel

Figure 3 — Incorrect procedures for uncoiling a wire rope

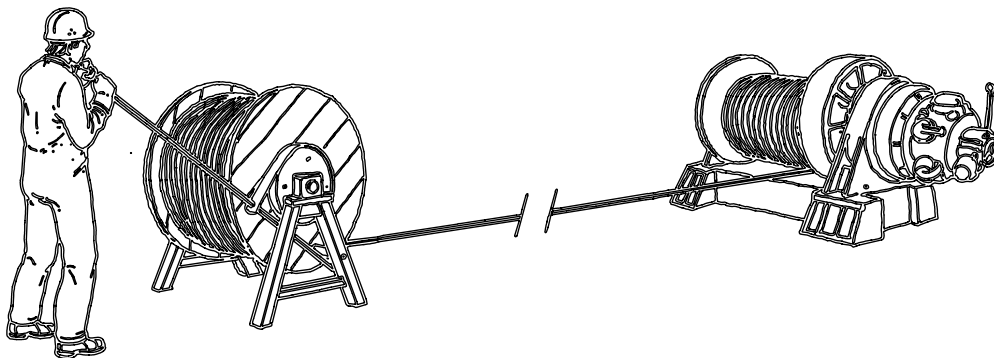

Figure 4 — Example of transfer of wire rope from bottom of reel to bottom of drum with control of rope tension

For those ropes that are subjected to multi-layer spooling, apply a back-tension to the rope during installation that is equivalent to about 2 1/2 % to 5 % of the minimum breaking force of the rope. This helps to ensure that the rope on the bottom layer is tightly wound, forming a firm base for succeeding layers.

Follow the crane manufacturer's instructions for the securing of the ends of the rope at the drum and outboard anchorages.

Protect the rope from rubbing against any part of the crane or hoist during installation.

4.6 Running-in the new rope

Before bringing the rope into full operation on the crane, the user shall ensure that all limiting and indicating devices associated with the operation of the crane are correctly functioning.

In order to allow the components of the rope to better adjust to the normal operating conditions, the user shall operate the crane at reduced speed and loading [i.e. down to 10 % of the Working Load Limit (WLL)] for a number of operational cycles.

4.7 Maintaining the rope

Maintenance of the rope shall be carried out relative to the type of crane, its frequency of use, the environmental conditions and the type of rope.

During the life of the rope, and before it shows any signs of dryness or corrosion, particularly over those lengths which travel through sheaves and enter and exit the drum and those sections which are coincident with a compensating sheave, the rope shall be dressed from time to time, as determined by a competent person. In some cases, it may be necessary to clean the rope before applying the dressing in order for it to be effective.

The rope dressing shall be compatible with the original lubricant applied by the rope manufacturer and shall have penetrating characteristics. If the type of rope dressing is not identified in the crane manual, the user shall seek guidance from the supplier of the rope or the wire rope manufacturer.

A shorter rope life is likely to result from a lack of maintenance, particularly if the crane or hoist is used in a corrosive environment or, for whatever reason, no rope dressing can be applied. In such cases, the period between inspections shall be reduced accordingly.

In order to avoid any localized deterioration, which might otherwise originate from a broken wire which protrudes excessively from the rope and overlies others when that portion travels through a sheave, it may be removed by gripping the protruding end(s) and bending the wire backwards and forwards (see Figure 5), until it eventually breaks (which is, invariably, in the valley position between the strands). When a broken wire is removed from the rope as part of a maintenance exercise, its location should be recorded for the information of the rope inspector. If such action is taken, this should be counted as one broken wire and taken into account when assessing the condition of the rope in relation to the discard criteria for broken wires.

When broken wires are evident close to or at the termination, but the rope is unaffected elsewhere along its length, the rope may be shortened and the terminal fitting may be re-fitted. Before doing so, the remaining length of wire rope should be checked to ensure that the required minimum number of wraps would remain on the drum with the crane at its most extreme operating limit.

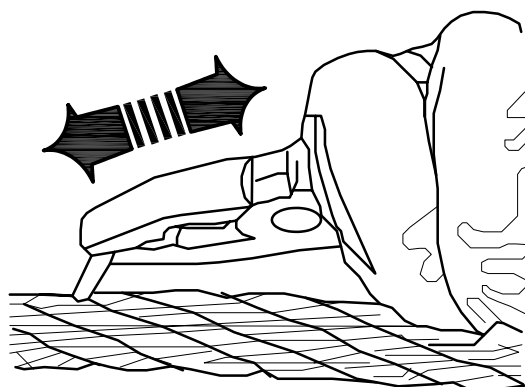

Figure 5 — Removal of protruding wire

4.8 Maintenance of rope-related parts of the crane

In addition to following the instructions contained in the crane manual, winding drums and sheaves should be periodically checked to ensure that they rotate freely in their bearings.

Stiff or jammed sheaves or rollers wear heavily and unevenly, causing severe abrasion of the rope. Ineffective compensating sheaves can give rise to unequal loading in the rope reeving.

5 Inspection

5.1 General

In the absence of any instructions provided by the manufacturer of the crane in his manual and/or any provided by the manufacturer or supplier of the rope, the general principles for inspection given in 5.2 to 5.5 shall be followed.

5.2 Daily visual inspection

At least the intended working section of rope for that particular day shall be observed with the objective of detecting any general deterioration or mechanical damage. This shall include the points of attachment of the rope to the crane (see Figure A.2).

The rope should also be checked to ensure that it is sitting correctly on the drum and over the sheave(s) and has not been displaced from its normal operating position.

Any appreciable change in condition shall be reported and the rope examined by a competent person in accordance with 5.3.

If, at any time, the rigging arrangement is modified, such as when the crane has been moved to a new site and re-rigged, the rope shall be subjected to a visual inspection as described in this subclause.

NOTE The driver/operator of the crane can be appointed to carry out daily checks to the extent that he is sufficiently trained and considered competent to carry out this action.

5.3 Periodic inspection

5.3.1 General

Periodic inspections shall be carried out by a competent person.

The information gained from a periodic inspection is used to assist in deciding whether a crane rope

- a) can safely remain in service and by which latest time it shall undergo its next periodic inspection, or
- b) needs to be withdrawn immediately or within a specified timeframe.

Through an appropriate assessment method, i.e. by counting, visual means and/or measurement, the severity of deterioration shall be assessed and expressed either as a percentage (e.g. 20 %, 40 %, 60 %, 80 % or 100 %) of the particular individual discard criteria or in words (e.g. slight, medium, high, very high or discard).

Any damage that might have occurred to the rope prior to it being run in and entering service shall be assessed by a competent person and observations shall be recorded.

A list of the more common modes of deterioration and whether each one can be readily quantified (i.e. by counting or measuring) or has to be subjectively assessed (i.e. by visual means) by the competent person is given in Table 1.

Table 1 — Modes of deterioration and assessment methods

Mode of deterioration	Assessment method
Number of visible broken wires (including those which are randomly distributed, localized groupings, valley wire breaks and those that are at, or in the vicinity of, the termination)	By counting
Decrease in rope diameter (resulting from external wear/abrasion, internal wear and core deterioration)	By measurement
Fracture of strand(s)	Visual
Corrosion (external, internal and fretting)	Visual
Deformation	Visual and by measurement (wave only)
Mechanical damage	Visual
Heat damage (including electric arcing)	Visual

For some examples of typical modes of deterioration, see Annex B.

5.3.2 Frequency

The frequency of the periodic inspection shall be determined by the competent person, who shall take account of at least the following:

- a) the statutory requirements covering the application in the country of use;
- b) the type of crane and the environmental conditions in which it operates;
- c) the classification group of the mechanism;
- d) the results of previous inspection(s);
- e) experience gained from inspecting ropes on comparable cranes;
- f) the length of time the rope has been in service;
- g) the frequency of use.

NOTE 1 The competent person can find it prudent to initiate or recommend more frequent periodic inspections than those required by legislation. This decision can be influenced by the type and frequency of operation. Also, depending on the condition of the rope at any time and/or whether there is any change in circumstances, such as an incident or change in operating conditions, the competent person can deem it necessary to reduce or recommend the reduction of the interval between periodic inspections.

NOTE 2 Generally, ropes develop broken wires at a greater rate later on in the life of a rope than in the early stages.

NOTE 3 For two examples of rate of increase in broken wires over time, see Figure 6.

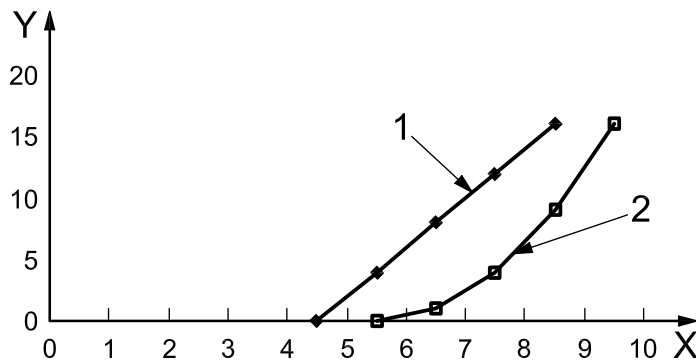

Key

- X time, in cycles
- Y number of randomly distributed broken wires per unit length
- 1 rope 1
- 2 rope 2

Figure 6 — Examples of rate of increase in broken wires

5.3.3 Extent of inspection

Each rope shall be inspected along its entire length.

However, in the case of a long length, and at the discretion of the competent person, the working length plus at least five wraps on the drum may be inspected. In such a case, and where a greater working length is subsequently foreseen after the previous inspection and prior to the next one, that additional length should also be inspected before the additional length of rope is used.

Particular care, however, shall be taken at the following critical areas and locations:

- a) drum anchorage;
- b) any section at, and in the vicinity of, a rope termination;
- c) any section that travels through one or more sheaves;
- d) any section that travels through a safe load indicator which incorporates sheaves;
- e) any section that travels through the hook block;
- f) in the case of cranes performing a repetitive operation, any part of the rope that lies over a sheave while the crane is in a loaded condition;
- g) that part of the rope which lies over a compensating sheave;
- h) any section that travels through a spooling device;
- i) those sections that spool on the drum, particularly cross-over zones that are associated with multi-layer spooling;
- j) any section that is subjected to abrasion by external features (e.g. hatch combings);
- k) any part of rope that is exposed to heat.

NOTE For areas requiring particular close inspection, see Annex A.

If the competent person judges it necessary to open up the rope to establish if there is any detrimental internal deterioration, this should be done with extreme care to avoid damaging the rope (see Annex C).

5.3.4 Inspection at, or in the vicinity of, a termination

The rope shall be inspected in the vicinity of the termination, particularly where it enters the termination, as this location is vulnerable to the onset of wire breaks due to vibration and other dynamic effects and, depending on the state of the environment, corrosion. Some probing with a spike may be carried out to establish if there is any looseness in any of the wires, suggesting the existence of a broken wire within the termination. The termination itself should also be inspected for any excessive amounts of distortion and wear.

Additionally, ferrules used in the securing of eyes or loops shall be visually inspected for any cracks in the material and for evidence of any possible slippage between the ferrule and the rope.

Detachable terminations such as symmetrical wedge sockets shall be inspected for evidence of any broken wires in the vicinity of the entry of the rope into the termination and checked to see that the termination has been correctly assembled.

Eye splices shall be checked to see that the serving is only over the tapered section of the splice, thus allowing the remainder of the splice to be visually inspected for broken wires.

5.3.5 Inspection record

After each periodic inspection, the competent person shall provide a rope inspection record (for typical examples, see Annex D), and state a maximum time interval that shall not be exceeded before the next periodic inspection takes place.

Preferably, a running record (see D.2), should be maintained.

5.4 Inspection following an incident

If an incident has occurred that might have caused damage to a rope and/or its termination, the rope and/or its termination shall be inspected as described for a periodic inspection (see 5.3), prior to re-commencement of work or as required by the competent person.

NOTE Where a twin rope hoisting system is employed, it is often necessary to replace both ropes even if only one has reached discard, because the new rope is larger than the one remaining and also has a different elongation property, both of which have an effect on the respective amounts of rope being paid out from the drum.

5.5 Inspection following period with crane out of operation

If the crane has been out of operation for more than three months, the rope(s) shall undergo a periodic inspection, as described in 5.3, prior to re-commencement of work.

5.6 Non-destructive testing

Non-destructive testing (NDT) by electro-magnetic means may be used as an aid to visual inspection to determine the location of those sections of rope which could be suffering deterioration. If it is the intention to carry out NDT by electro-magnetic means at some point during the life of the rope, it should be subjected to an initial examination as soon as possible/practicable in the lifetime of the rope (which might be at rope manufacture, during installation of the rope or, preferably, after the rope has been installed) to serve as a reference point (sometimes referred to as “rope signature”) for future comparison.

6 Discard criteria

6.1 General

In the absence of any instructions provided by the manufacturer of the crane in his manual or any provided by the supplier or manufacturer of the rope, the individual discard criteria as given in 6.2 to 6.6 shall apply (for useful background information in support of these criteria, see Annex E).

As deterioration often results from a combination of different modes at the same position in the rope, the competent person shall assess the “combined effect”, one method of which is described in Annex F.

If, for whatever reason, there is a noticeable change in the rate of deterioration of the rope, the reason for this shall be investigated and, wherever possible, corrective action taken. In extreme cases, the competent person may decide to discard the rope or amend the discard criteria, for example by reducing the allowable number of visible broken wires.

In those instances where a long length of rope has suffered deterioration over a relatively short section, the competent person may decide that it is not necessary to discard the whole length of rope, provided that the affected section can be satisfactorily removed and the remaining length is in a serviceable condition.

6.2 Visible broken wires

6.2.1 Criteria for visible broken wires

The discard criteria for the various natures of visible broken wire shall be as specified in Table 2.

Table 2 — Discard criteria for visible broken wires

	Nature of visible broken wire	Discard criteria
1	Wire breaks occurring randomly in sections of rope which run through one or more steel sheaves and spool on and off the drum when single-layer spooling or occurring at sections of rope which are coincident with cross-over zones when multi-layer spooling ^a	See Table 3 for single-layer and parallel-closed ropes and Table 4 for rotation-resistant ropes.
2	Localized grouping of wire breaks in sections of rope which do not spool on and off the drum	If grouping is concentrated in one or two neighbouring strands it might be necessary to discard the rope, even if the number is lower than the values over a length of $6d$, which are given in Tables 3 and 4.
3	Valley wire breaks ^b	Two or more wire breaks in a rope lay length (approximately equivalent to a length of $6d$)
4	Wire breaks at a termination	Two or more wire breaks
^a For typical example, see Figure B.13. ^b For typical example, see Figure 7 and Figure B.14.		

6.2.2 Use of Tables 3 and 4 and Rope Category Number

If the rope is a single-layer or parallel-closed rope, as shown in Annex G, apply the corresponding Rope Category Number (RCN) and read off the discard values in Table 3 for broken wires over a length of $6d$ and $30d$. If the construction is not shown in Annex G, determine the total number of load-bearing wires in the rope (by adding together all of the wires in the outer layer of strands except for any filler wires) and read off the discard values in Table 3 for broken wires over a length of $6d$ and $30d$ for the appropriate conditions.

If the rope is a rotation-resistant rope, as shown in Annex G, apply the corresponding RCN and read off the discard values in Table 4 for broken wires over a length of $6d$ and $30d$. If the construction is not shown in

Annex G, determine the number of outer strands and the total number of load-bearing wires in the outer layer of strands in the rope (by adding together all of the wires in the outer layer of strands except for any filler wires) and read off the discard values in Table 4 for broken wires over a length of $6d$ and $30d$ for the appropriate conditions.

6.2.3 Wire breaks other than those resulting from service

As a consequence of shipping, storage, handling, installation and manufacturing, an individual wire can be broken. As such, isolated wire breaks are not attributed to deterioration resulting from in-service operation, such as bending fatigue on which the values in Tables 3 and 4 are largely based; they would not normally be counted when inspecting the rope for broken wires. Their existence, however, if discovered, should be recorded, as this can assist future inspections.

In the event that such broken wires are found to have their ends protruding from the rope and it is considered that leaving them unattended might lead to the development of some potential localized deterioration, they should be removed (for removal, see 4.7).

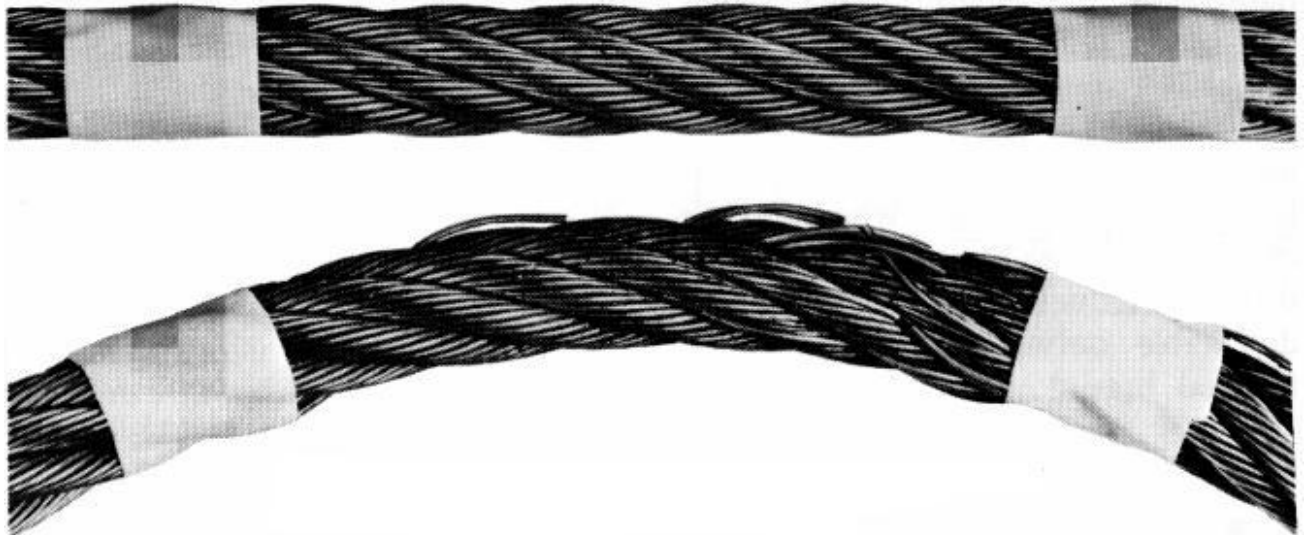

Figure 7 — Flexing a rope can often expose broken wires hidden in valleys between strands

6.2.4 Single-layer and parallel-closed ropes

Table 3 — Number of wire breaks, reached or exceeded, of visible broken wires occurring in single-layer and parallel-closed ropes, signalling discard of rope

Rope category number RCN (see Annex G)	Total number of load-bearing wires in the outer layer of strands in the rope ^a <i>n</i>	Number of visible broken outer wires ^b					
		Sections of rope working in steel sheaves and/or spooling on a single-layer drum (wire breaks randomly distributed)				Sections of rope spooling on a multi-layer drum ^c	
		Classes M1 to M4 or class unknown ^d				All classes	
		Ordinary lay		Lang lay		Ordinary and Lang lay	
		Over a length of $6d^e$	Over a length of $30d^e$	Over a length of $6d^e$	Over a length of $30d^e$	Over a length of $6d^e$	Over a length of $30d^e$
01	$n \leq 50$	2	4	1	2	4	8
02	$51 \leq n \leq 75$	3	6	2	3	6	12
03	$76 \leq n \leq 100$	4	8	2	4	8	16
04	$101 \leq n \leq 120$	5	10	2	5	10	20
05	$121 \leq n \leq 140$	6	11	3	6	12	22
06	$141 \leq n \leq 160$	6	13	3	6	12	26
07	$161 \leq n \leq 180$	7	14	4	7	14	28
08	$181 \leq n \leq 200$	8	16	4	8	16	32
09	$201 \leq n \leq 220$	9	18	4	9	18	36
10	$221 \leq n \leq 240$	10	19	5	10	20	38
11	$24 \leq n \leq 260$	10	21	5	10	20	42
12	$261 \leq n \leq 280$	11	22	6	11	22	44
13	$281 \leq n \leq 300$	12	24	6	12	24	48
	$n > 300$	$0,04 \times n$	$0,08 \times n$	$0,02 \times n$	$0,04 \times n$	$0,08 \times n$	$0,16 \times n$

NOTE Ropes having outer strands of Seale construction where the number of wires in each strand is 19 or less (e.g. 6×19 Seale) are placed in this table two rows above that row in which the construction would normally be placed based on the number of load bearing wires in the outer layer of strands.

^a For the purposes of this International Standard, filler wires are not regarded as load-bearing wires and are not included in the values of *n*.

^b A broken wire has two ends (counted as one wire).

^c The values apply to deterioration that occurs at the cross-over zones and interference between wraps due to fleet angle effects (and not to those sections of rope which only work in sheaves and do not spool on the drum).

^d Twice the number of broken wires listed may be applied to ropes on mechanisms whose classification is known to be M5 to M8.

^e *d* = nominal diameter of rope.

6.2.5 Rotation-resistant ropes

Table 4 — Number of wire breaks, reached or exceeded, of visible broken wires occurring in rotation-resistant rope, signalling discard of rope

Rope category number RCN (see Annex G)	Number of outer strands and total number of load-bearing wires in the outer layer of strands in the rope ^a <i>n</i>	Number of visible broken outer wires ^b			
		Sections of rope working in steel sheaves and/or spooling on a single-layer drum (wire breaks randomly distributed)		Sections of rope spooling on a multi-layer drum ^c	
		Over a length of $6d^d$	Over a length of $30d^d$	Over a length of $6d^d$	Over a length of $30d^d$
21	4 strands $n \leq 100$	2	4	2	4
22	3 or 4 strands $n \geq 100$	2	4	4	8
	At least 11 outer strands				
23-1	$71 \leq n \leq 100$	2	4	4	8
23-2	$101 \leq n \leq 120$	3	5	5	10
23-3	$121 \leq n \leq 140$	3	5	6	11
24	$141 \leq n \leq 160$	3	6	6	13
25	$161 \leq n \leq 180$	4	7	7	14
26	$181 \leq n \leq 200$	4	8	8	16
27	$201 \leq n \leq 220$	4	9	9	18
28	$221 \leq n \leq 240$	5	10	10	19
29	$241 \leq n \leq 260$	5	10	10	21
30	$261 \leq n \leq 280$	6	11	11	22
31	$281 \leq n \leq 300$	6	12	12	24
	$n > 300$	6	12	12	24

NOTE Ropes having outer strands of Seale construction where the number of wires in each strand is 19 or less (e.g. 18 × 19 Seale – WSC) are placed in this table two rows above that row in which the construction would normally be placed based on the number of wires in the outer layer of strands.

^a For the purposes of this International Standard, filler wires are not regarded as load-bearing wires and are not included in the values of *n*.

^b A broken wire has two ends.

^c The values apply to deterioration that occurs at the cross-over zones and interference between wraps due to fleet angle effects (and not to those sections of rope that only work in sheaves and do not spool on the drum).

^d *d* = nominal diameter of rope.

6.3 Decrease in rope diameter

6.3.1 Uniform decrease along the rope

The discard criteria values for uniform decrease in rope diameter for sections of rope which spool on a single-layer drum and/or run through a steel sheave are shown, in bold, in Table 5. They do not apply to those sections of rope which are coincident with cross-over zones or other sections of rope which are similarly deformed as a result of spooling on a multi-layer drum.

The reference diameter for the decrease is the diameter of a section of non-running rope, measured immediately after the rope has been broken in. The calculation to determine the amount of decrease in diameter and expression as a percentage of nominal diameter of rope is given in 6.3.2.

Table 5 also shows the equivalent uniform decreases in diameter, expressed as a percentage of nominal diameter of rope, for severity ratings expressed in increments, for convenience, of 20 % (i.e. 20 %, 40 %, 60 %, 80 % and 100%). Other severity ratings, e.g. expressed in increments of 25 % (i.e. 25 %, 50 %, 75 % and 100 %), may also be selected.

Table 5 — Uniform decrease in diameter signalling discard of rope — Rope spooling on a single-layer drum and/or running through a steel sheave

Rope type	Uniform decrease in diameter (expressed as % of nominal diameter)	Severity rating	
		Description	%
Single-layer rope with fibre core	Less than 6 %	—	0
	6 % and over but less than 7 %	Slight	20
	7 % and over but less than 8 %	Medium	40
	8 % and over but less than 9 %	High	60
	9 % and over but less than 10 %	Very high	80
	10 % and over	Discard	100
Single-layer rope with steel core or parallel-closed rope	Less than 3,5 %	—	0
	3,5 % and over but less than 4,5 %	Slight	20
	4,5 % and over but less than 5,5 %	Medium	40
	5,5 % and over but less than 6,5 %	High	60
	6,5 % and over but less than 7,5 %	Very high	80
	7,5 % and over	Discard	100
Rotation-resistant rope	Less than 1 %	—	0
	1 % and over but less than 2 %	Slight	20
	2 % and over but less than 3 %	Medium	40
	3 % and over but less than 4 %	High	60
	4 % and over but less than 5 %	Very high	80
	5 % and over	Discard	100

6.3.2 Calculation to determine actual uniform decrease in diameter and expression as percentage of nominal rope diameter

Actual uniform decrease in diameter expressed as a per cent of nominal diameter is calculated using Equation (1):

$$[(d_{\text{ref}} - d_{\text{m}})/d] \times 100 (\%) \quad (1)$$

where

d_{ref} is the reference diameter;

d_{m} is the measured diameter;

d is the nominal diameter.

EXAMPLE 1 For a 40 mm diameter 6 × 36-IWRC rope having a reference diameter of 41,2 mm and measuring 39,5 mm at inspection, the per cent decrease is equal to

$$[(41,2 - 39,5)/40] \times 100 = 4,25 \%$$

NOTE 1 From Table 5, the severity rating for uniform decrease in diameter is 20 % towards discard (i.e. slight).

NOTE 2 Discard is reached when the rope decreases from reference diameter by an amount equivalent to 7,5 % of nominal diameter, i.e. 3 mm. In this case, diameter at discard would be 38,2 mm.

EXAMPLE 2 For the same rope, but measuring 38,5 mm at inspection, the per cent decrease is equal to

$$[(41,2 - 38,5)/40] \times 100 = 6,75 \%$$

NOTE 3 From Table 5, the severity rating is 80 % (i.e. very high).

6.3.3 Local decrease

If there is an obvious local decrease in diameter, such as that caused by failure of a core or rope centre, the rope shall be discarded (for an example of a decrease associated with a sunken strand, see Figure B.3).

6.4 Fracture of strands

If a complete strand fracture occurs, the rope shall be immediately discarded.

6.5 Corrosion

The discard criteria and intermediate severity ratings for corrosion are given in Table 6.

When assessing the extent of corrosion, it is important to recognize the difference between corrosion of the wires and any corrosion on the rope surface that is associated with the oxidation of foreign particles.

Therefore, before making an assessment, the rope sections undergoing inspection shall be wiped or brushed clean. The use of solvents for cleaning should be avoided.

Table 6 — Discard criteria for corrosion and intermediate severity ratings

Type of corrosion	Condition	Severity rating
External corrosion ^a	Signs of surface oxidation but can be wiped clean	Superficial – 0 %
	Wire surface rough to touch	High – 60 % ^c
	Wire surface heavily pitted and slack wires^b	Discard – 100 %
Internal corrosion ^d	Obvious visible signs of internal corrosion – i.e. corrosion debris exuding from the valleys between the outer strands^e	Discard – 100 %
		or if deemed practicable by the competent person, internal examination in accordance with the procedure described in Annex C
Fretting corrosion	The process of fretting involves the removal of fine particles of steel from the wires due to dry wires and strands constantly rubbing together and then oxidizing and creating internal corrosion debris, which manifests itself as a dry powder, similar to a red rouge.	Evidence of such a characteristic should be further investigated and if there is any doubt about its severity, the rope should be discarded (100 %).

^a For examples, see Figures B.11 and B.12. For an example of the progression of external corrosion in a rope, see Annex H.

^b For any other intermediate condition, an assessment should be made as to its severity rating (i.e. contribution towards the combined effect).

^c The oxidation of zinc-coated wires can result in a wire surface which is also rough to the touch, but the overall condition might not be as serious as wires which are not coated. In such cases, the inspector may consider applying a lower contribution towards the combined effect to that given above in this table.

^d For an example, see Figure B.19.

^e Assessment of internal corrosion is subjective; however, if there is any doubt about the seriousness of any internal corrosion, the rope should be discarded.

NOTE An increase in diameter can result from internal or fretting corrosion.

6.6 Deformation and damage

6.6.1 General

Visible distortion of the rope from its normal shape is classified as deformation. It usually results in an uneven stress distribution in the rope in the area of the deformation, often found to be localized.

Deformation and damage can manifest themselves in a number of ways and the discard criteria for the more common types are given in 6.6.2 to 6.6.10.

Any rope considered to be in a dangerous condition shall be immediately discarded.

6.6.2 Waviness

The rope shall be discarded if, under any condition, either of the following conditions exists (see Figure 8):

- on a straight portion of rope, which never runs through or around a sheave or spools on to the drum, the gap between a straightedge and the underside of the helix is $1/3 \times d$ or greater;
- on a portion of rope, which runs through a sheave or spools on to the drum, the gap between a straightedge and the underside of the helix is $1/10 \times d$ or greater.

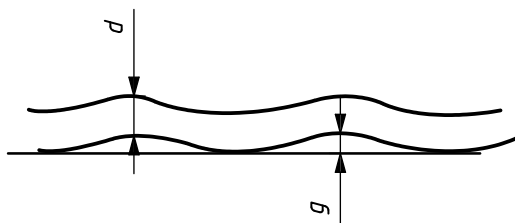

Key

d nominal rope diameter

g gap

Figure 8 — Waviness of rope

NOTE For an example of a wavy rope, see Figure B.8.

6.6.3 Basket deformation

Ropes with a basket or lantern deformation (see Figure B.9) shall be immediately discarded or, provided the remaining length of rope is in a serviceable condition, have the affected section removed.

6.6.4 Core or strand protrusion or distortion

Ropes with core or strand protrusion (see Figures B.2 and B.4) shall be immediately discarded or, provided the remaining length of rope is in a serviceable condition, have the affected section removed.

NOTE This is a special type of basket or lantern deformation, in which the rope imbalance is characterized by either protrusion of the core or centre between the outer strands of the rope or protrusion of an outer strand of the rope or strand of the core.

6.6.5 Protruding wires in loops

Ropes with protruding wires, usually occurring in groups on the opposite side of the rope to that which is in contact with a sheave groove, shall be immediately discarded (see Figure B.1).

NOTE Evidence of a single king wire from the core that protrudes between the outer strands of the rope may not necessarily be a reason for discard, provided that it can either be removed or does not interfere with other elements of the rope during operation.

6.6.6 Local increase in rope diameter

If the rope diameter increases by 5 % or more for a rope with a steel core or 10 % or more for a rope with a fibre core during service, the reason for this shall be investigated and consideration given to discarding the rope (see Figure B.16).

NOTE An increase in rope diameter that might affect a relatively long length of the rope, such as that resulting from the swelling of a natural fibre core, can occur due to excessive absorption of moisture, creating imbalance in the outer strands, which become incorrectly oriented.

6.6.7 Flattened portion

Flattened portions of rope which run through a sheave are likely to deteriorate more quickly and exhibit broken wires. In such cases, but depending on the extent of the flattening, consideration may be given to discarding the rope.

Flattened portions of rope in standard rigging can suffer a greater degree of corrosion than other non-affected portions, more so when the outer strands open up and allow ingress of moisture. If retained in service, they shall be inspected more frequently; otherwise, consideration should be given to discarding the rope.

It is possible for flattened portions of rope, which result from multi-layer spooling, to not give rise to discard, providing the numbers of broken wires associated with the flattening do not exceed the values given in Tables 3 and 4.

Figures B.5 and B.18 illustrate two different types of flattening.

6.6.8 Kink or tightened loop

Ropes with a kink or tightened loop shall be immediately discarded (see Figures B.6, B.7 and B.17).

NOTE A kink or tightened loop is a deformation created by a loop in the rope, which has been tightened without allowing for rotation about its axis. Imbalance of lay length occurs which causes excessive wear and, in severe cases, the rope becomes so distorted that it only has a small proportion of its strength remaining.

6.6.9 Bend in rope

Portions of rope with a severe bend which run through a sheave are likely to quickly deteriorate and exhibit broken wires. In such cases, the rope shall be immediately discarded.

If the degree of bend is not considered to be severe and the rope is retained in service, it shall be inspected more frequently; otherwise, consideration should be given to discarding the rope.

NOTE Bends are angular deformations of the rope, caused by external influences.

The decision as to whether or not the bend is severe is subjective. If there is a fold in the rope on the underside of the bend, this should be considered severe, whether or not the rope runs over a sheave.

6.6.10 Damage due to heat or electric arcing

Ropes that are not normally operated at temperature, but have been subjected to exceptionally high thermal effects, externally recognizable by the associated heat colours produced in the steel wires and/or a distinct loss of grease from the rope, shall be immediately discarded.

If two or more wires have been affected locally, due to electric arcing, such as that resulting from incorrectly grounded welding leads, the rope shall be discarded. This can occur at the point where the current enters or leaves the rope.

Annex A (informative)

Key areas requiring particular close inspection

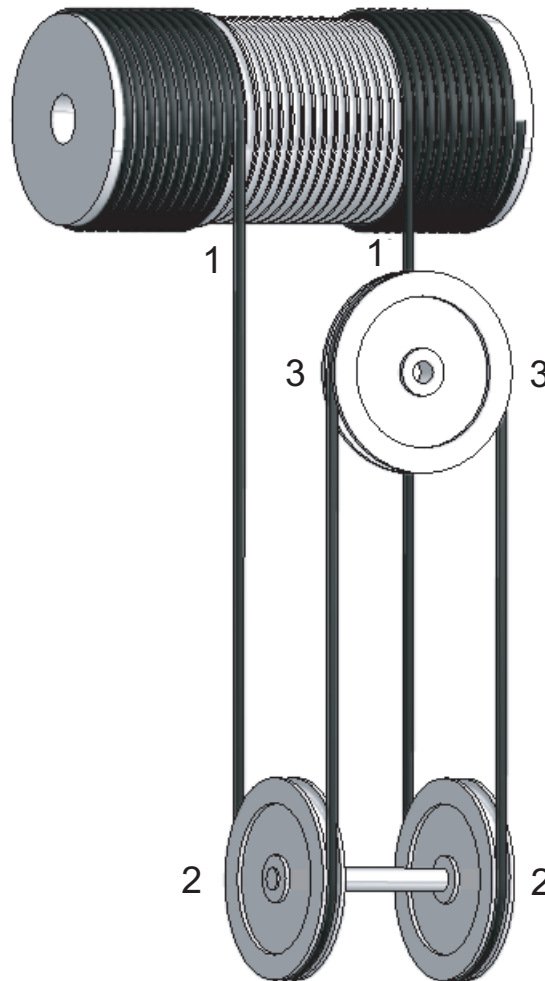

Key

- 1 sections spooling on drum at point of load being lifted and other sections suffering greatest interference (usually coinciding with maximum fleet angle)
- 2 section(s) entering block sheave(s) at point of load being lifted
- 3 sections in direct contact with compensating sheave, particularly at points of entry

Figure A.1 — Single-layer spooling

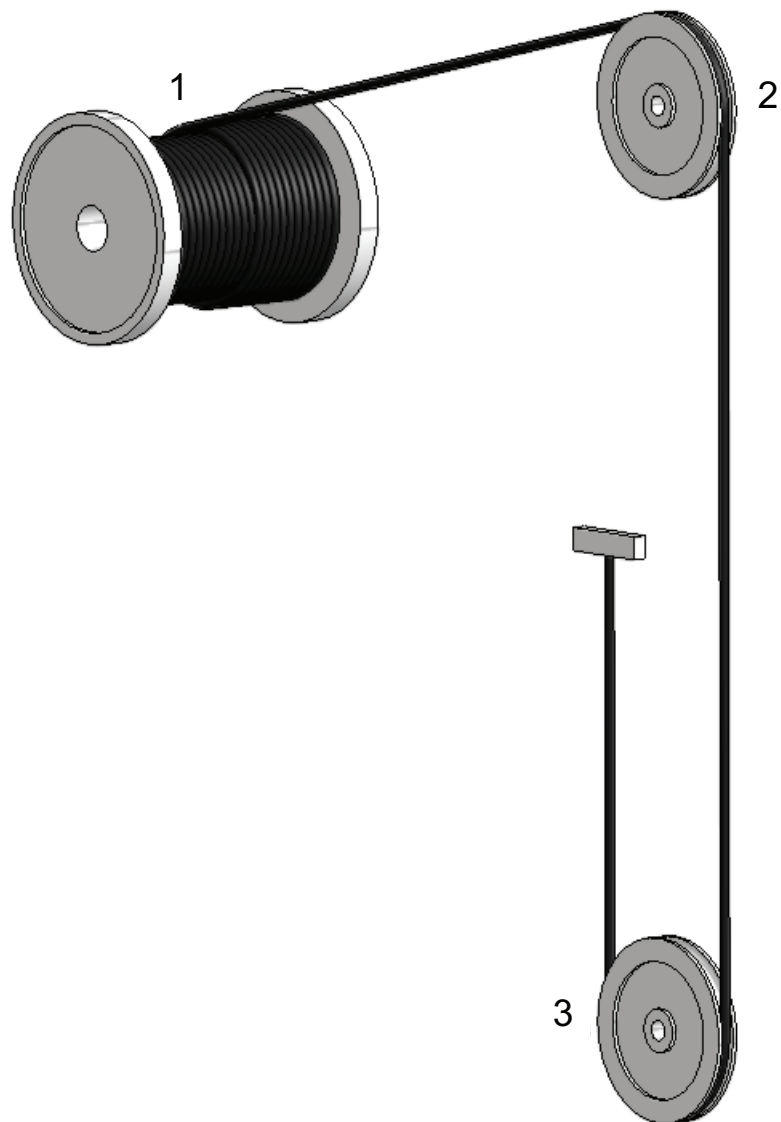

Key

- 1 cross-over zones and those sections suffering greatest interference (usually coinciding with maximum fleet angle)
- 2 section where rope enters head sheave at point of load being lifted
- 3 section(s) entering bottom block sheave(s) at point of load being lifted

Figure A.2 — Multi-layer spooling

Annex B (informative)

Typical modes of deterioration

Table B.1 shows the defects which can occur and the corresponding discard criteria. Figures B.1 to B.19 show a typical example of each defect.

Table B.1 — Defects occurring in wire rope

Figure	Defect	Clause /subclause reference
B.1	Wire protrusion	6.6.5
B.2	Core protrusion – Single-layer rope	6.6.4
B.3	Local reduction in rope diameter (sunken strand)	6.3
B.4	Strand protrusion/distortion	6.6.4
B.5	Flattened portion	6.6.7
B.6	Kink (positive)	6.6.8
B.7	Kink (negative)	6.6.8
B.8	Waviness	6.6.2
B.9	Basket deformation	6.6.3
B.10	External wear	5.3.1, Table 1 and E.2
B.11	External corrosion	6.5
B.12	Enlargement of Figure B.11	6.5
B.13	Crown wire breaks	6.2
B.14	Valley wire breaks	6.2
B.15	Protrusion of inner rope of rotation-resistant rope	E.4 c)
B.16	Local increase in rope diameter due to core distortion	6.6.6
B.17	Kink	6.6.8
B.18	Flattened portion	6.6.7
B.19	Internal corrosion	6.5



Figure B.1 — Wire protrusion



Figure B.2 — Core protrusion – Single-layer rope

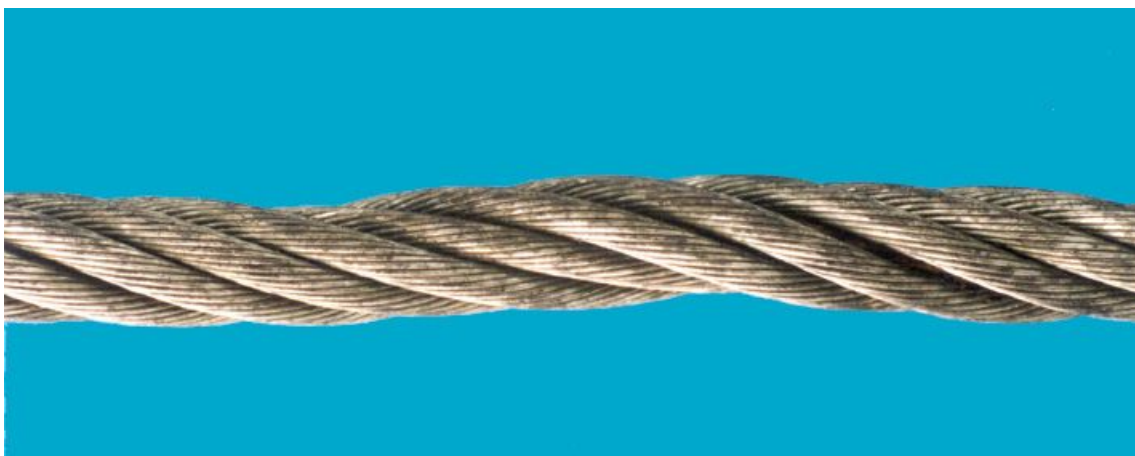

Figure B.3 — Local reduction in rope diameter (sunken strand)

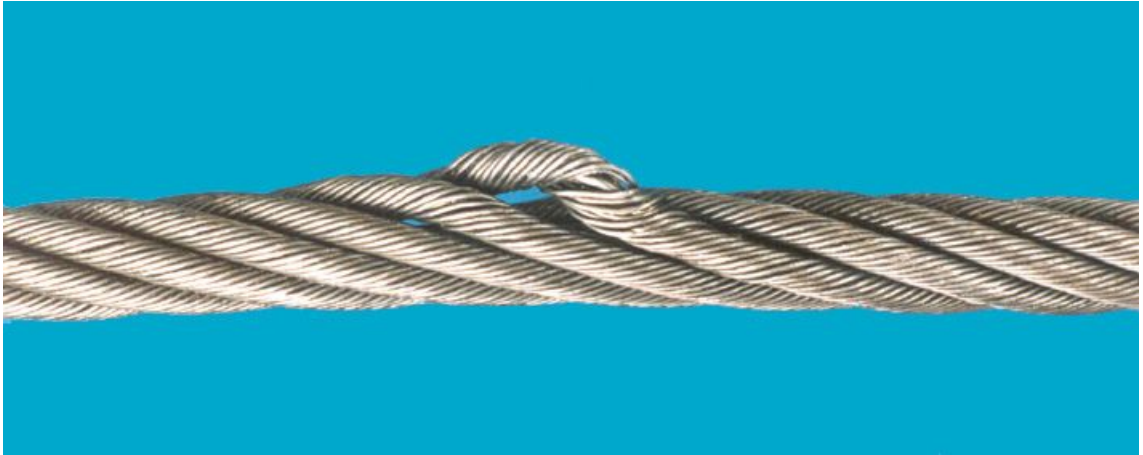

Figure B.4 — Strand protrusion or distortion



Figure B.5 — Flattened portion



Figure B.6 — Kink (positive)

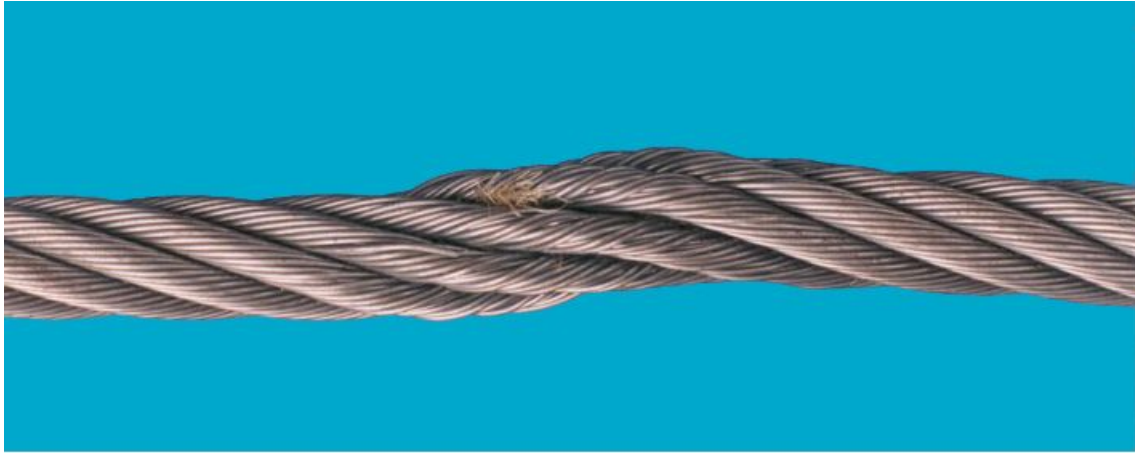

Figure B.7 — Kink (negative)

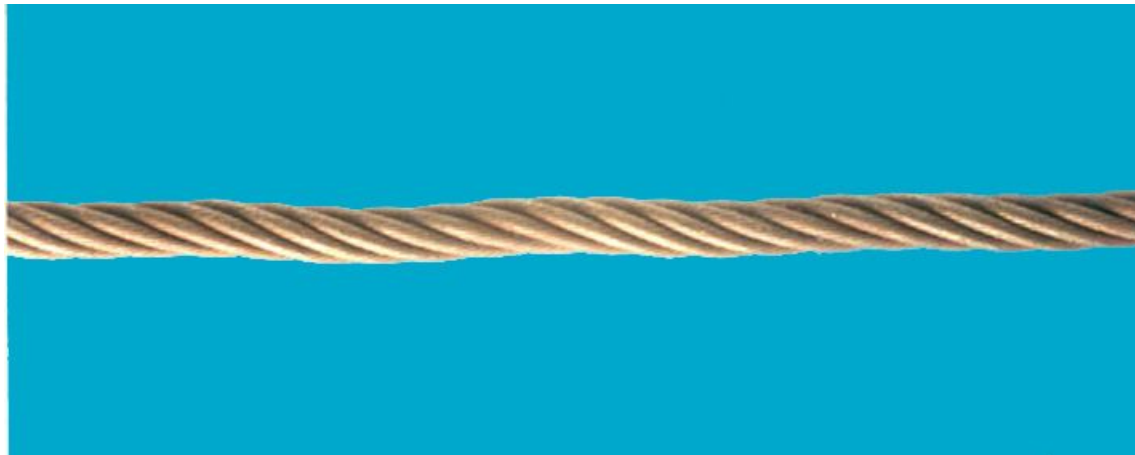

Figure B.8 — Waviness

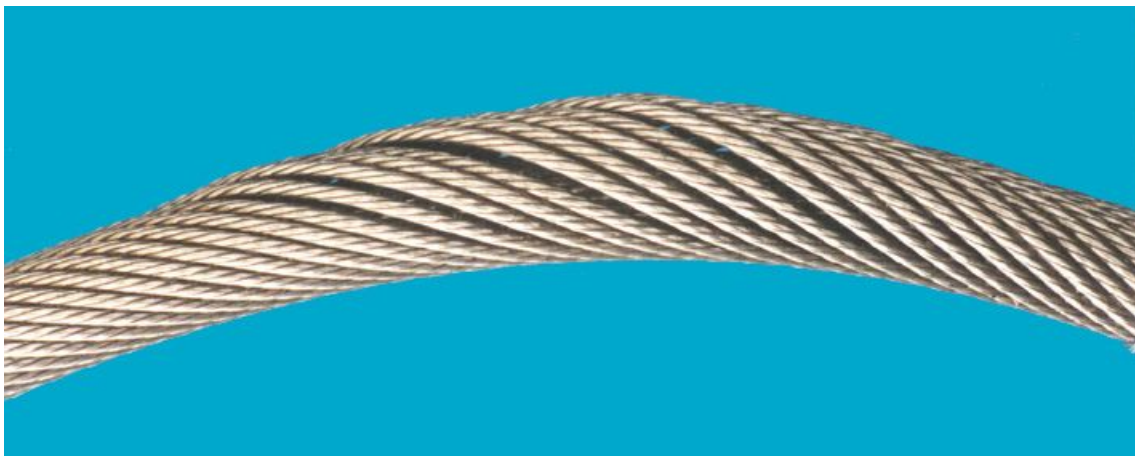

Figure B.9 — Basket deformation

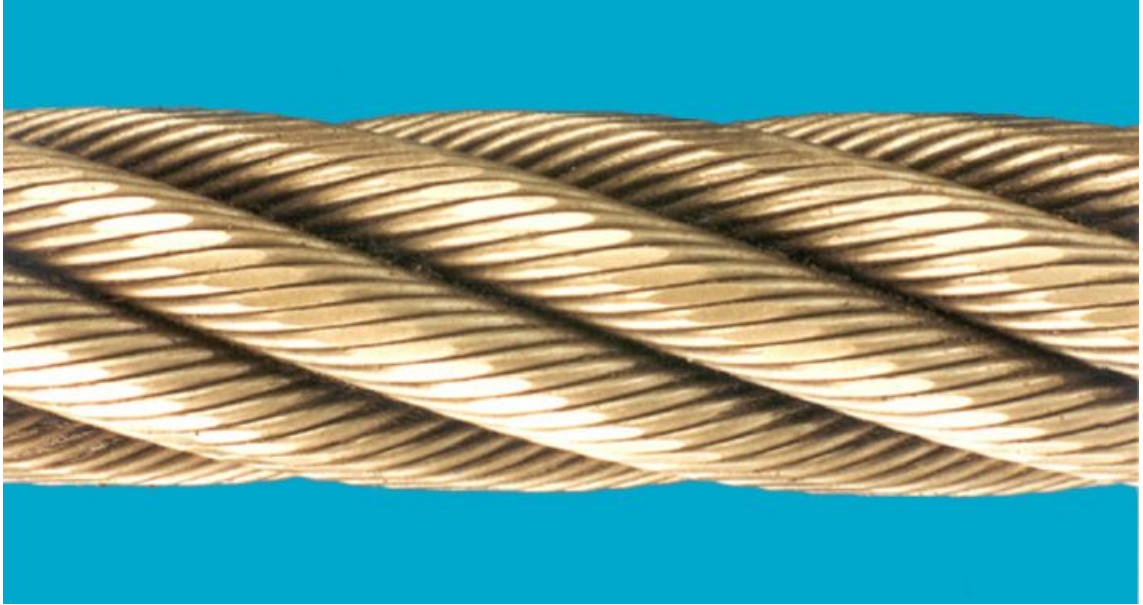

Figure B.10 — External wear

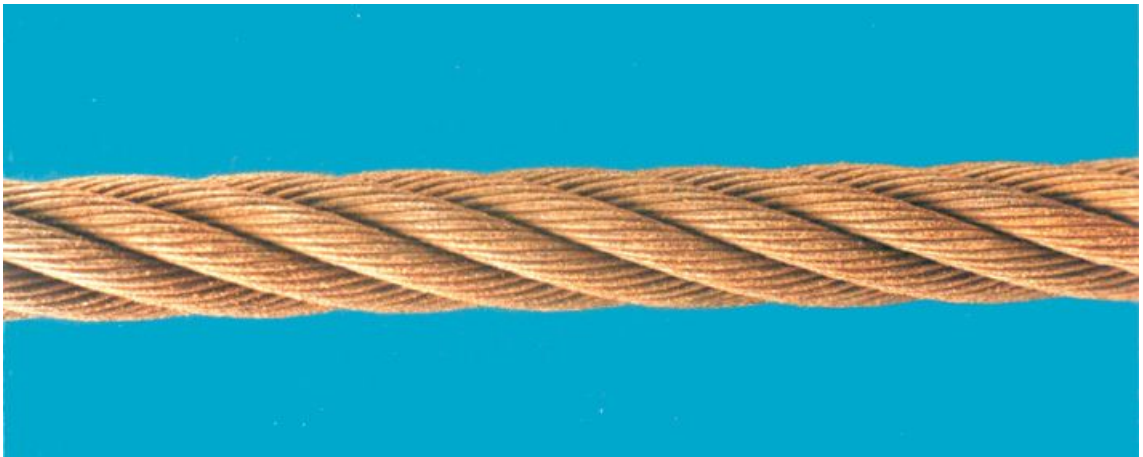

Figure B.11 — External corrosion



Figure B.12 — Enlargement of Figure B.11

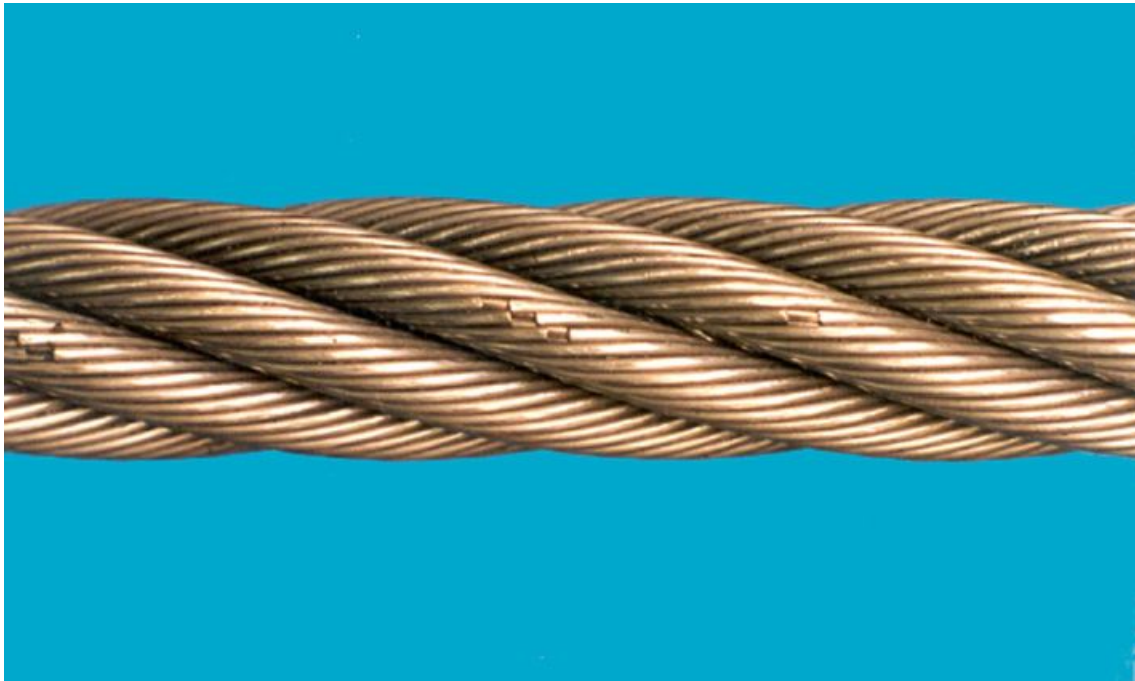

Figure B.13 — Crown wire breaks

30

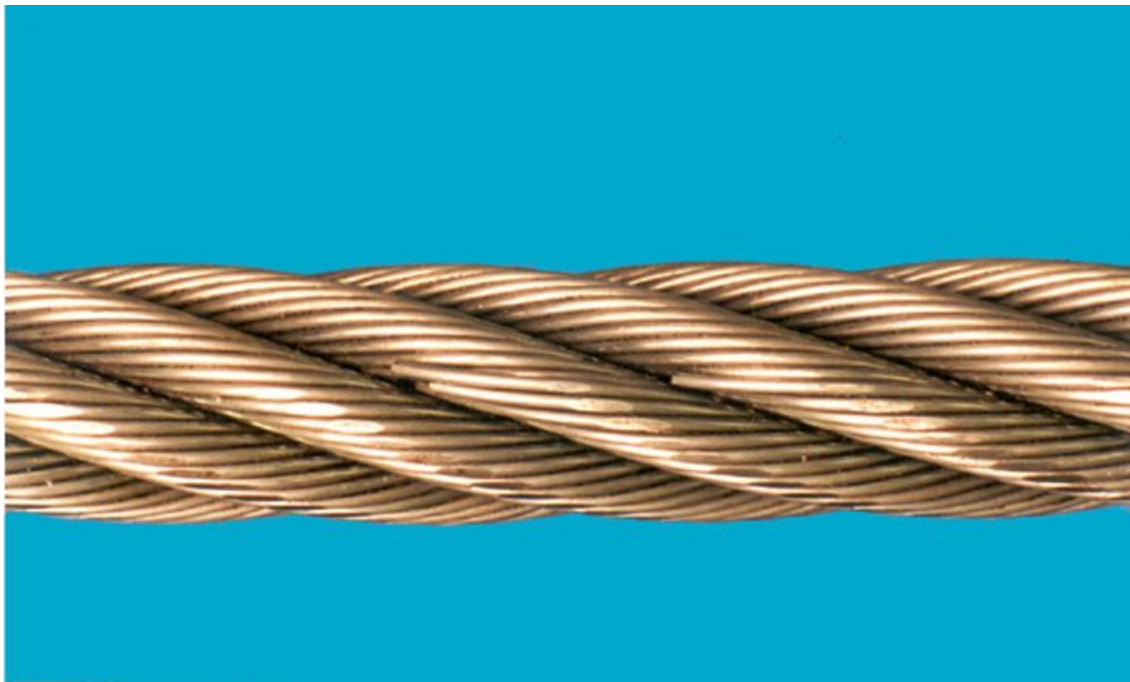

Figure B.14 — Valley wire breaks

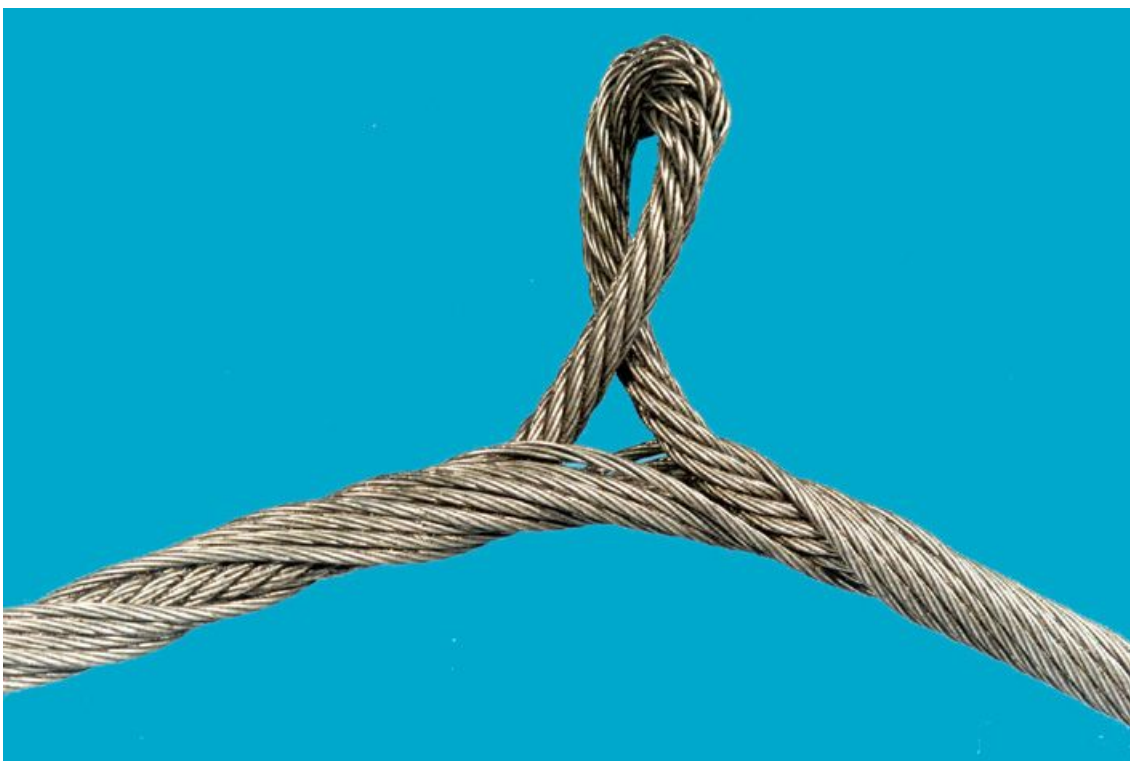

Figure B.15 — Protrusion of inner rope of rotation-resistant rope



Figure B.16 — Local increase in rope diameter due to core distortion



Figure B.17 — Kink



Figure B.18 — Flattened portion

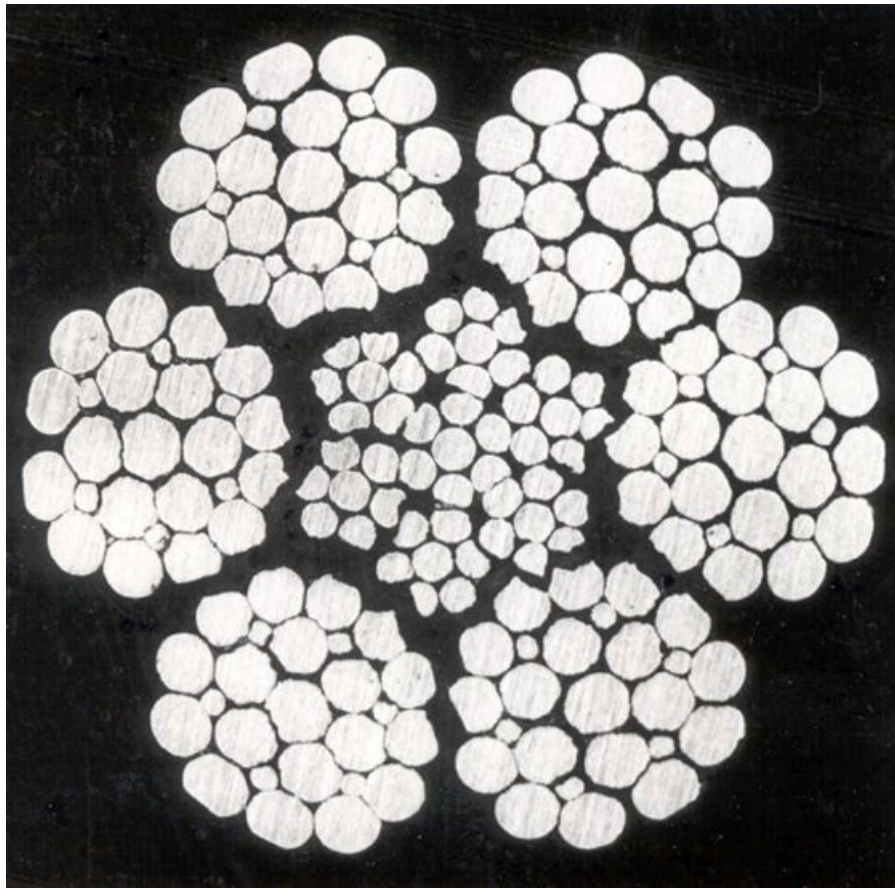

Figure B.19 — Internal corrosion

Annex C (informative)

Internal examination of rope

C.1 General

Where the competent person decides that an internal examination is necessary in service, this should be done with extreme care, thus avoiding permanently damaging and/or deforming the rope. Practically, this is more readily performed when the rope is lying on the floor, as opposed to being up in the air.

Not all types and/or sizes of rope can be sufficiently opened up to permit assessment of their internal condition.

If carried out, this is usually limited to a position where visual evidence creates doubt as to the internal condition of the rope and should be carried out with no tension at all in the rope.

NOTE Experience of rope deterioration can be gained by subjecting discarded rope to a detailed examination after removal from service, involving unlaying the rope and exposing its inner elements, which would otherwise be unseen when inspecting the rope in service. This has occasionally revealed a more serious condition than was assumed during routine periodic visual inspection, even to the point where fracture of the rope is imminent.

C.2 Procedure

C.2.1 General examination of rope

Firmly attach two clamps to the rope [see Figure C.1 a)] and note their position. The jaws should be

- a) of a size capable of gripping the rope without distorting it, and
- b) made from a material which allows the rope to be opened up without slipping and damaging the rope.

To assist this process, the jaws may incorporate inserts, such as those made from leather.

Rotate the clamps in the opposite direction to the rope lay, such that the outer strands separate and move away from the core or rope centre, thus opening up the rope. Ensure that the strands are not excessively displaced.

When the rope opens up a little, a small probe, such as a T-needle (modified screwdriver), can be used to remove grease or debris, which might otherwise hinder observation of the interior of the rope.

The following should be observed:

- the degree of any corrosion;
- any indentation of the wires (resulting from pressure or wear);
- the presence of any broken wires in the outer strands and in the core or rope centre (these might not be easily visible);
- the state of the internal lubrication.

A service dressing (lubricant) should be applied at the opened section of rope before closing up the rope.

The clamps should be rotated with moderate force to close up the rope and ensure correct replacement of the outer strands around the core or rope centre. This often necessitates taking the jaws just past their original starting position.

After removing the jaws, but before allowing the crane to return to normal operation, the rope should be dressed in the vicinity of where the examination was undertaken.

C.2.2 Examination of rope adjacent to a termination

At such positions, it is sufficient to only use one clamp since the end anchorage system, or a bar suitably located through the end portion of the termination, usually ensures the immobilization of the outer end [see Figure C.1 b)].

The examination should be carried out as in C.2.1.

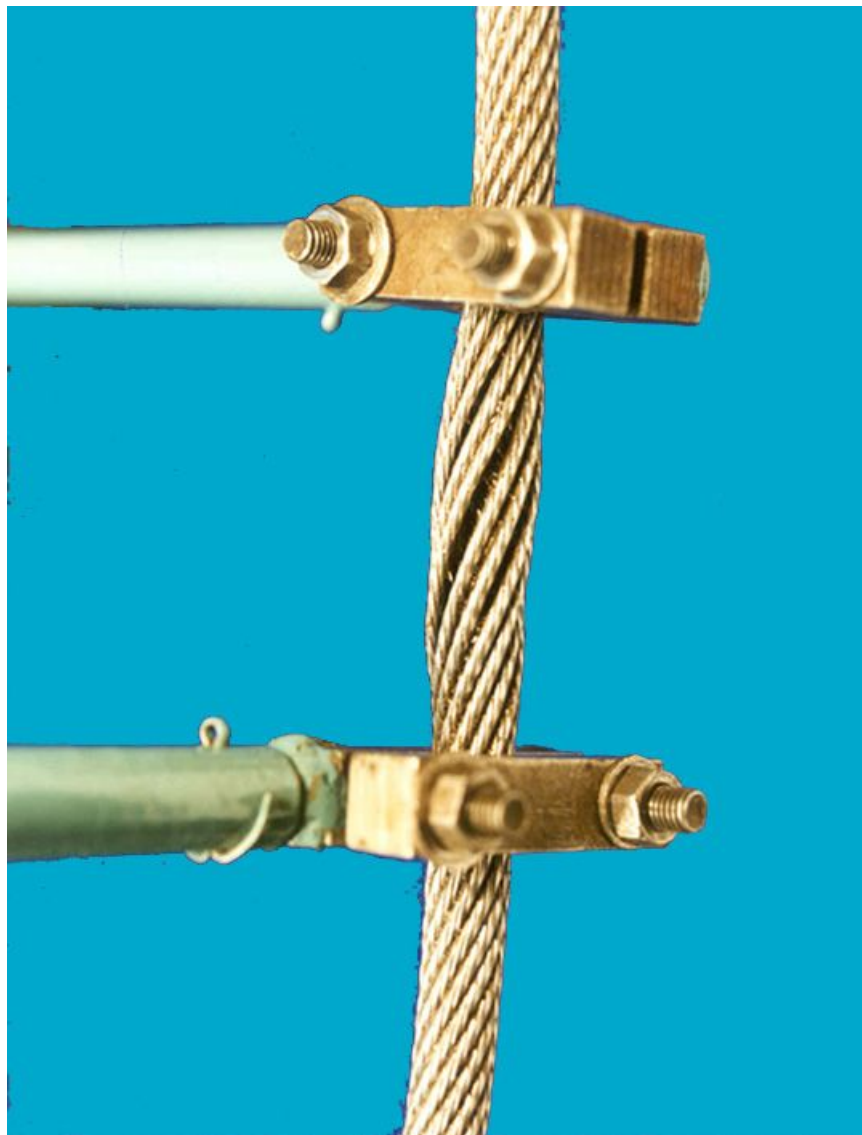

a) Of a continuous portion of rope (zero tension)

Figure C.1 — Internal examination (*continued*)



b) At the end of a rope, close to the terminal fitting (zero tension)

Figure C.1 — Internal examination

Annex D (informative)

Typical examples of inspection record

D.1 Single record

Crane reference					Rope application						
Rope details Brand name (if known) Nominal diameter mm Construction Core ^a : IWRC FC WSC Wire finish ^a : Uncoated Zinc/Gal. Direction and type of lay ^a : (Right) sZ zZ Z (Left) zS sS S Permissible number of visible broken outer wires in 6 <i>d</i> and in 30 <i>d</i> Reference diameter mm Permissible decrease in diameter from reference diameter mm											
Date installed (yy/mm/dd) Date discarded (yy/mm/dd)											
Visible broken outer wires				Diameter			Corrosion	Damage and/or deformation		Position in rope	Overall assessment i.e. combined severity rating ^b at position indicated
Number in length of		Severity rating ^b		Measured diameter	Actual decrease from reference	Severity rating ^b	Severity rating ^b	Severity rating ^b	Nature		
6 <i>d</i>	30 <i>d</i>	6 <i>d</i>	30 <i>d</i>	mm	mm						
Other observations/comments											
Performance to date (cycles/hours/days/months/etc.)											
Date of inspection (yy/mm/dd)											
Name (print) of competent person Name (signature)											
^a Tick as applicable. ^b Describe degree of deterioration as: slight, medium, high, very high, or discard.											

D.2 Running record

Crane reference			Date rope installed		Rope details (see ISO 17893 for rope designation)											
			yy/mm/dd		RCN ^a	Nominal diameter mm	Band name	Core ^b	Wire finish ^b	Direction and type of lay ^b		Right: sZ zZ Z Left: zS sS S		Permissible decrease in diameter from reference diameter		
Rope duty			Date rope discarded		Reference diameter mm											
			yy/mm/dd		Permissible number of visible broken outer wires in 6 <i>d</i> and in 30 <i>d</i>											
Date of inspection	yy/mm/dd	Visible broken outer wires			Diameter		Corrosion		Damage and deformations		Overall assessment		Name (print) and signature of competent person			
		Number in length of	Position in rope	Severity rating ^c	Measured diameter mm	Actual decrease from reference diameter mm	Position in rope	Severity rating ^c	Position in rope	Severity rating ^c	i.e. combined severity rating ^c					
		6 <i>d</i>	30 <i>d</i>		6 <i>d</i>	30 <i>d</i>										

^a RCN is Rope Category Number (see Tables 1 and 2 and Annex E).

^b Tick as applicable.

^c Describe severity rating as: slight or 20 %; medium or 40 %; high or 60 %; very high or 80 %; or discard or 100 %.

Annex E (informative)

Useful information on rope deterioration and discard criteria

E.1 Broken wires

a) General – randomly distributed

In the case of single-layer (such as six- and eight-strand ropes) and parallel-closed type ropes running through steel sheaves, broken wires usually occur randomly along the rope at the strand crown positions, i.e. the external surfaces of the outer strands. Often, such broken wires are associated with areas of external wear.

In the case of rotation-resistant type ropes, there is a possibility that the majority of broken wires occur internally and would be difficult to detect when carrying out a visual inspection. For this reason, the allowable number of visual broken wires for a rotation-resistant rope is less than that for a single-layer or parallel-closed rope. Tables 3 and 4 reflect the above-mentioned factors.

In applications where the predominant mode of deterioration is bending fatigue, broken wires begin to occur after a certain number of operating cycles. However, this number progressively increases over time, in which case, it is recommended that careful periodic inspection and recording of the number detected be undertaken with a view to establishing the rate of their increase. This premise can then be used to propose a future date for the next periodic inspection.

b) Cross-over zones (multi-layer spooling)

For those machines with ropes which are subjected to multi-layer spooling at the drum, it is expected that the principal mode of deterioration would be broken wires and deformation at the cross-over zones. As testing and experience has shown that the performance of a rope can be drastically reduced at these positions, compared with those sections of rope which simply run through sheaves, these zones become the focus of attention of the competent person during periodic rope inspection.

c) Localized

It is difficult to put a precise figure on the number of allowable broken wires when they are localized or concentrated in any one strand. In some cases, localized broken wires can be repeated each lay length, often beginning with localized areas of wear. In such cases, the number of allowable broken wires is decided on by the competent person, but is less than the numbers stated in Tables 3 and 4.

d) Valley wire breaks

One valley break can be indicative of internal rope deterioration, hence the need for a closer inspection of this section of rope. More particularly with smaller rope sizes, such wire breaks can sometimes be exposed by displacing the rope from its normal position and flexing it under no tension. If two or more valley breaks are found in one lay length, it should be assumed that the core or centre of the rope is not fully supporting the outer strands.

E.2 Decrease in diameter

A decrease in rope diameter can result from a number of factors, one of which is external wear. It can be general or localized and usually results from contact with sheaves or drums or from pressure of rope on rope, as would be expected at the cross-over zones as the rope traverses the drum. Wear can be uniform along or

around the rope, or can occur along one side of the rope. If the wear is uneven, the cause should be ascertained and, if possible, corrective action taken.

More pronounced amounts of wear are usually found in those sections of rope which are in contact with the grooves of sheaves and drums when the load is being accelerated or decelerated.

A lack of lubrication or incorrect lubrication and the presence of abrasive dust and grit can also affect the rate of wear.

In addition to the obvious visible mode of deterioration described above (in this clause), the rope can also decrease as a result of one or a number of internal mechanisms, such as:

- a) internal wear and wire indentation;
- b) internal wear caused by friction between adjacent strands and wires in the rope, particularly when it is subjected to bending;
- c) deterioration of a fibre core or fracture of a steel core;
- d) fracture of the inner layers of strands of a rotation-resistant rope.

By reducing the metallic cross-sectional area of the rope by wear, the strength of the rope is reduced.

E.3 Corrosion

Corrosion occurs particularly in marine and industrial polluted atmospheres and not only reduces the strength of the rope by reducing its metallic cross-sectional area, but also accelerates fatigue by causing an irregular surface from which stress cracking can propagate. Severe corrosion can also cause decreased elasticity of the rope.

Internal corrosion is more difficult to detect than external corrosion, but they often occur together, although this might not always be obvious from a visual inspection of the rope. If suspected, the rope should be subjected to an internal examination by a competent person, although this can often be extremely difficult to perform.

E.4 Deformation and damage

- a) Waviness

Waviness is a deformation in which the longitudinal axis of the rope takes the shape of a helix under either a loaded or unloaded condition. While not necessarily resulting in a loss of strength, it can promote the setting up of abnormal stresses, giving rise to unusual wear patterns and premature broken wires. If severe, it can also affect the condition of rope-related equipment, such as sheave bearings, sheave grooves, rope guides and rope drums.

- b) Basket or lantern deformation

Basket or lantern deformation, also called "birdcage", results from a difference in length between the rope core and the outer layer of strands. Different mechanisms can produce this type of deformation.

If, for example, the rope is running over a sheave or on to the drum under a great fleet angle, it touches the flange of the sheave or the drum groove first and then rolls down into the bottom of the groove. This action unlays the outer strands to a greater extent than the rope core, producing a difference in length between these rope elements.

When running over a tight sheave, i.e. a sheave with a groove radius which is too small, the wire rope becomes compressed. This reduction in diameter results, at the same time, in an increase in rope length. As the outer layer of the strands becomes compressed and lengthened to a greater extent than the rope core, this mechanism again produces a difference in length between these rope elements.

In both cases, the sheaves and the drum are then able to displace the loose outer strands and massage the length difference to one location in the reeving system, where it appears as a basket or lantern deformation.

c) Core or strand protrusion

This characteristic is a special type of basket or lantern deformation, in which the rope imbalance is indicated by the protrusion of the core or centre of the rope in the case of a rotation-resistant rope, between the outer strands, or protrusion of an outer strand of the rope or strand from the core.

d) Wire protrusion

When wire protrusion occurs, certain wires or groups of wires rise up from the rope, often on the side of the rope opposite to that which makes contact with the sheave groove, in the form of loops.

e) Increase in rope diameter

This characteristic is often related to a change in condition of the core, such as a fibre core swelling up due to the absorption of moisture or the accumulation of corrosion debris within the rope.

f) Flattened portions

Flattened portions of rope, which run through a sheave, quickly deteriorate, exhibiting broken wires and potentially damaging the sheave.

g) Damage due to heat or electric arcing

Portions of rope that have been subjected to exceptional thermal effects can sometimes be detected by changes in the colour of the rope, e.g. a “blueing” effect.

h) Decreased elasticity

Under certain circumstances, usually associated with the working environment, a rope can sustain a substantial decrease in elasticity, rendering it unfit for further use.

This characteristic, often difficult to detect, can be associated with the following:

- 1) a decrease in rope diameter;
- 2) an elongation of the rope length;
- 3) a lack of clearance between individual strands and/or wires;
- 4) the appearance of a fine, brown powder in the valleys between the strands and/or wires (i.e. suggesting fretting corrosion);
- 5) a noticeable stiffening of the rope when handled and a decrease in diameter greater than that related purely to wear of the individual wires, even though there might be no visible wire breaks.

Annex F (informative)

Combined effect assessment of rope condition and severity rating — One method

F.1 General

Although broken wires are a common reason for discard, deterioration often results from a combination of factors. For example, a rope can be suffering from broken wires and uniform wear due to repeated running through a sheave, while at the same time deteriorating from corrosion due to working in a marine environment. In such cases, the competent person needs to:

- a) take account of the different modes of deterioration, particularly when they occur at the same location in the rope;
- b) make an overall assessment of the “combined effect” of the different modes of deterioration;
- c) decide whether the rope is safe to remain in service and, if so, whether it needs to be subjected to any revised inspection/discard provisions.

One method of determining the combined effect is as follows:

- d) inspect the rope and record the type and amount of each individual mode of deterioration, e.g. number of broken wires in $6d$, decrease in diameter in millimetres and extent of corrosion;
- e) for each of these individual modes of deterioration, rate the severity and express it either as a percentage of the respective individual discard criteria, e.g. if 40 % of the allowable number of broken wires according to the individual discard criteria are found to exist, this represents a rating of 40 % towards discard, or in words, e.g. slight, medium, high, very high or discard;
- f) either add together the individual ratings at selected locations, only when they occur at the same location and express the severity as a combined per cent value or make a judgement as to the combined degree of severity and express the rating in words, e.g. slight, medium, high, very high or discard.

NOTE 1 The “combined effect” method of assessment given in this clause assumes that deterioration occurs progressively, rather than suddenly. If the result of the combined rating is more or less shared equally between two or three of the more common individual modes of deterioration (e.g. 40 % due to broken wires and 40 % due to reduction in diameter), this is considered to be not as serious as if only one mode of deterioration occurs at any given section (e.g. 80 % due to broken wires and little decrease in diameter or corrosion).

NOTE 2 Uniform decrease in diameter ratings do not apply to those sections of rope which spool on to a multi-layer drum and suffer deterioration in the form of crushing and associated deformation/broken wires, such as that occurring at cross-over zones.

NOTE 3 The “combined effect” method of assessment in this clause offers a simple approach to rating the overall condition of a specific portion of rope. Other equally acceptable methods can be developed and practised by the competent person in the light of his experience gained from inspecting similar ropes operating on similar cranes.

F.2 Examples

The following are four examples to assist in understanding how the “combined effect” method is applied.

EXAMPLE 1 22 mm diameter 6 × 36WS-IWRC sZ rope operating on an overhead hoist (classification M4) and spooling on a single-layer drum.

From Table 3, the number of outer wire breaks signalling discard is 9 in $6d$ and 18 in $30d$. Therefore, if two broken wires are found in $6d$ (but no more than 18 in $30d$), this equates to an individual severity rating of 20 %.

From Table 5, the uniform decrease in diameter from reference diameter signalling discard is 7,5 % of nominal diameter = 1,65 mm. Therefore, if reference diameter is 22,6 mm and measured diameter at inspection is 21,8 mm, then the decrease in diameter, expressed as a percentage of nominal diameter, is $[(22,6 - 21,8)/22] \times 100 = 3,6$ %. From Table 5, this equates to a severity rating of 20 %.

Therefore, if the amounts of deterioration mentioned in this example occur at the same position in the rope, they can be combined, the resultant severity rating being 40 %.

EXAMPLE 2 22 mm diameter 18 × 7-WSC sZ rope operating on an overhead hoist (classification M4) and spooling on a single-layer drum.

From Table 4, the number of outer wire breaks signalling discard is two in $6d$ and four in $30d$. Therefore, if one broken wire is found in $6d$ (but no more than four in $30d$), this equates to an individual severity rating of 50 %.

From Table 5, the uniform decrease in diameter from reference diameter signalling discard is 5 % of nominal diameter = 1,10 mm. Therefore, if reference diameter is 22,6 mm and measured diameter at inspection is 21,8 mm, the decrease in diameter, expressed as a percentage of nominal diameter, is $[(22,6 - 21,8)/22] \times 100 = 3,6$ %. From Table 5, this equates to a severity rating of 60 %.

Therefore, if the amounts of deterioration mentioned in this example occur at the same position in the rope, they can be combined, the resultant severity rating being 110 % (i.e. discard).

EXAMPLE 3 22 mm diameter 6 × 25F-IWRC zZ rope operating as a boom hoist rope on a crawler crane (classification M4) and spooling on a multi-layer drum.

From Table 3, the number of outer wire breaks at cross-over zone signalling discard is 10 in $6d$. Therefore, if seven broken wires are found in $6d$ at cross-over zone (but no more than 20 in $30d$), this equates to a severity rating of 70 % (i.e. high).

As a decrease in diameter is not taken into account at cross-over zones, the resultant severity rating is 70 %.

EXAMPLE 4 22 mm diameter 18 × 19-WSC zZ rope operating as a hoist rope on a mobile crane (classification M4) and spooling on a multi-layer drum.

From Table 4, the number of outer wire breaks at cross-over zone signalling discard is 8 in $6d$. Therefore, if four broken wires are found in $6d$ at cross-over zone (but no more than 16 in $30d$), this equates to a severity rating of 50 % (i.e. medium).

As a decrease in diameter is not taken into account at cross-over zones, the resultant severity rating is 50 %.

Table F.1 — Examples of severity rating

Example	Severity rating of individual modes of deterioration %			Combined severity rating %	Comment
	Wire breaks	Decrease in diameter ^a	External corrosion		
1	0	20	20	40	Safe to continue
2	20	20	0	40	Safe to continue
3	20	20	20	60	Safe to continue
4	40	20	20	80	Inspect more frequently
5	40	40	0	80	Inspect more frequently
6	0	80	0	80	Consider discard if reduction in diameter is mainly attributed to external wear
7	60	0	0	60	Inspect (particularly for broken wires) more frequently
8	60	20	0	80	Inspect more frequently (particularly for broken wires) and prepare for replacement

^a Only taken into account when rope travels through steel sheave and/or spools on to single-layer drum.

Annex G
(informative)

Examples of cross-sections of ropes and corresponding rope category number (RCN)

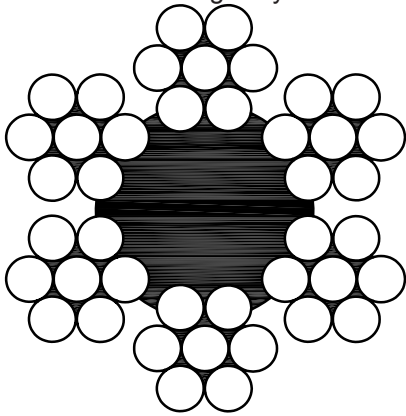
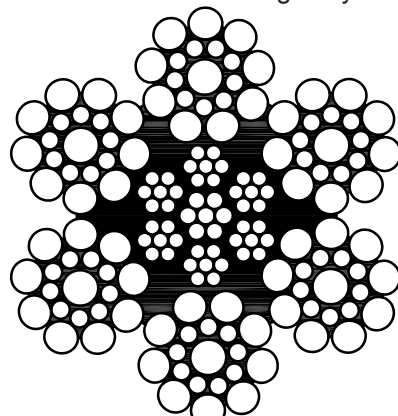
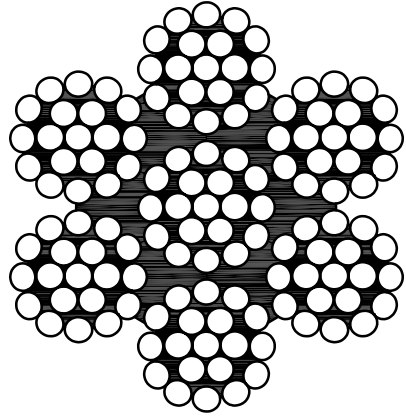
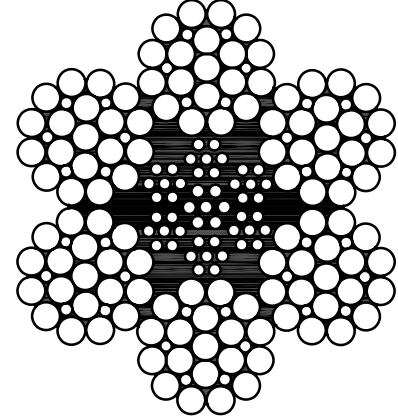
<p>Construction : 6×7-FC Single layer</p>  <p>RCN.01</p>	<p>Construction : 6×19S-IWRC Single-layer rope</p>  <p>RCN.02</p>
<p>Construction : 6×19M-WSC Single-layer rope</p>  <p>RCN.04</p>	<p>Construction : 6×25F-IWRC Single-layer rope</p>  <p>RCN.04</p>

Construction : 6 × 25TS-IWRC Single-layer rope

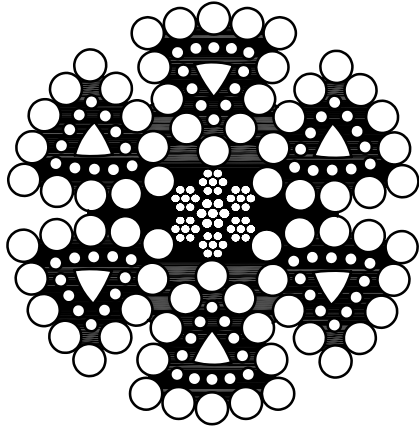

RCN.04

Construction : 6 × 36WS-IWRC Single-layer rope

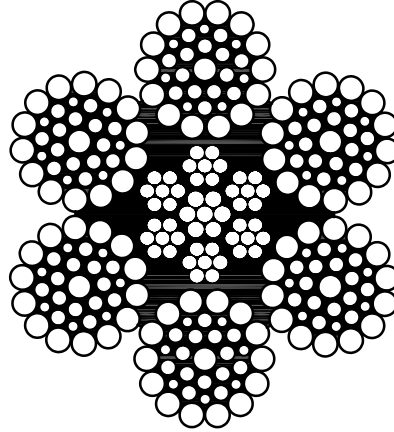

RCN.09

Construction : 6 × 41WS-IWRC Single-layer rope

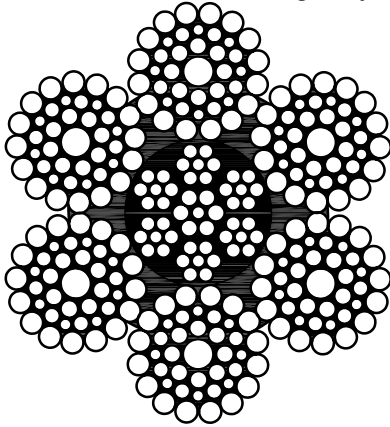

RCN.11

Construction : 6 × 37M-IWRC Single-layer rope

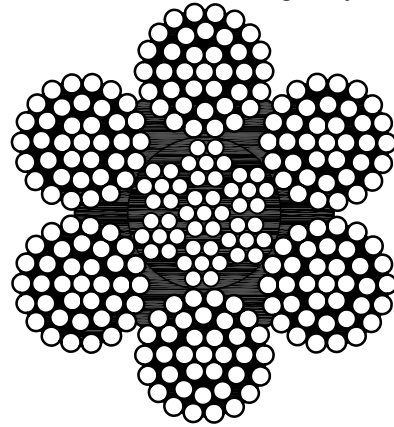

RCN.10

Construction : 8 × 19S-IWRC Single-layer rope

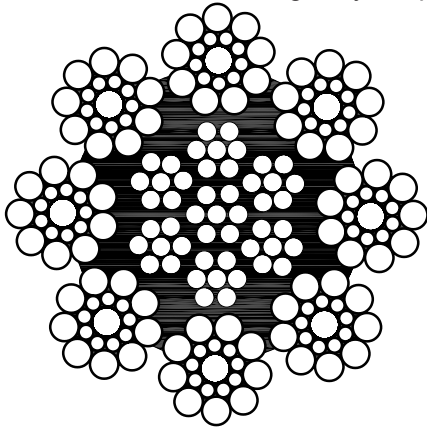

RCN.04

Construction : 8 × 25F-IWRC Single-layer rope

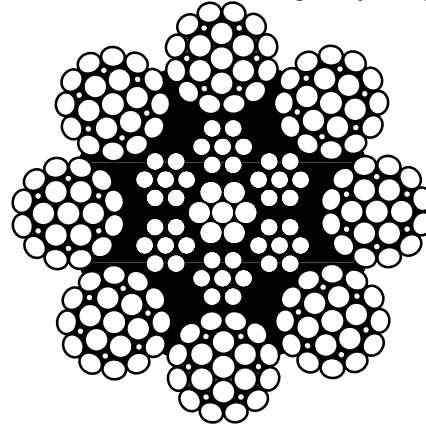

RCN.06

Construction : $8 \times 19S$ -PWRC
Parallel-closed rope

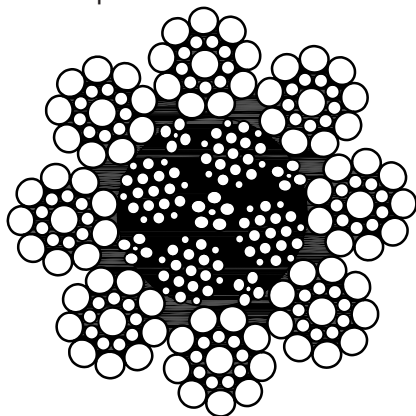

RCN.04

Construction : $8 \times K26WS$ -IWRC
Single-layer rope with compacted strands

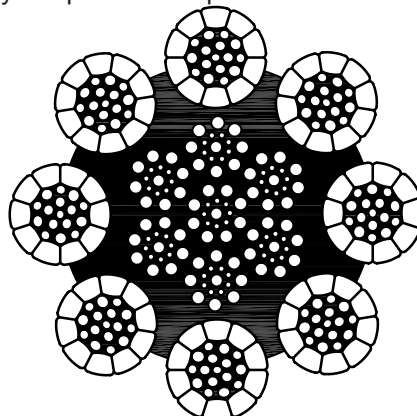

RCN.09

Construction : $4 \times K26WS$
Single-layer rope/Rotation-resistant rope with compacted strands

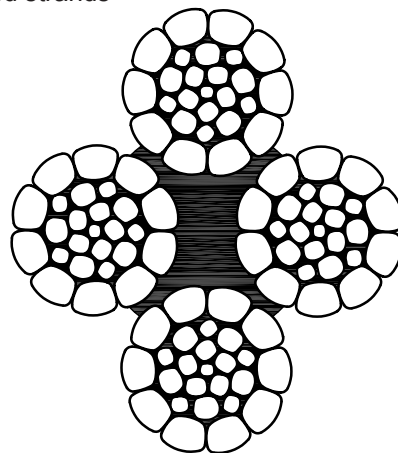

RCN.22

Construction : $6 \times K26WS$ -IWRC
Single-layer rope with compacted strands

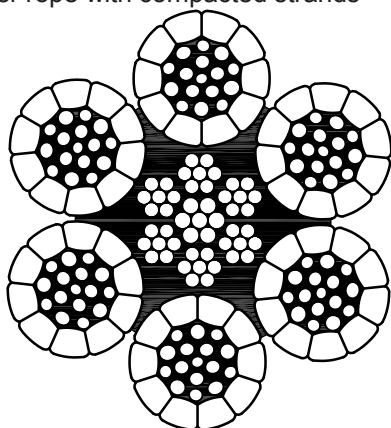

RCN.06

Construction : $6 \times K36WS$ -IWRC
Single-layer rope with compacted strands

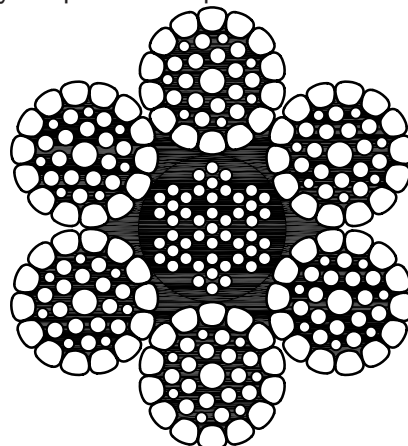

RCN.09

Construction : $8 \times K26WS-PWRC$
 Parallel-closed rope with compacted strands

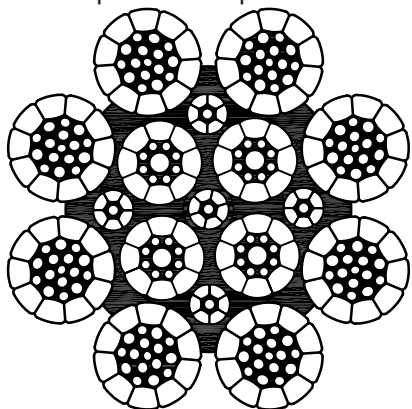

RCN.09

Construction : $18 \times K19S-WSC$ or $19 \times K19S$
 Rotation-resistant rope with compacted strands

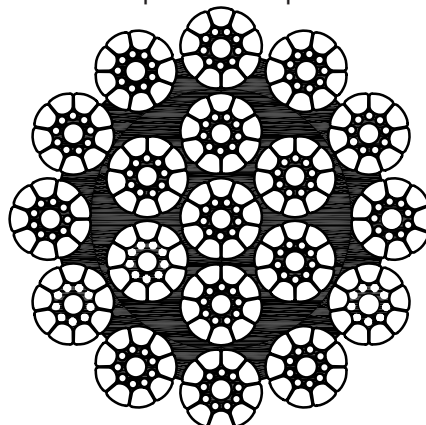

RCN.26

Construction : $4 \times 29F$
 Single-layer rope / Rotation-resistant rope $4 \times 29F$

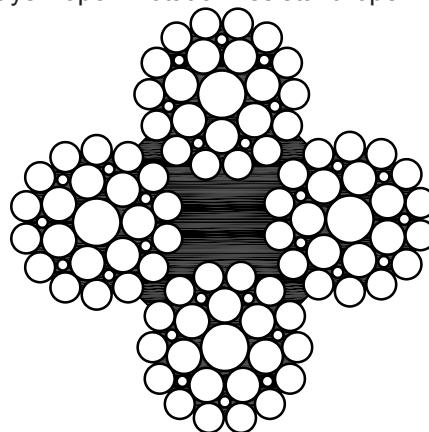

RCN.21

Construction : $K3 \times 40$
 Single-layer compacted (swaged) rope/Rotation-resistant compacted (swaged) rope

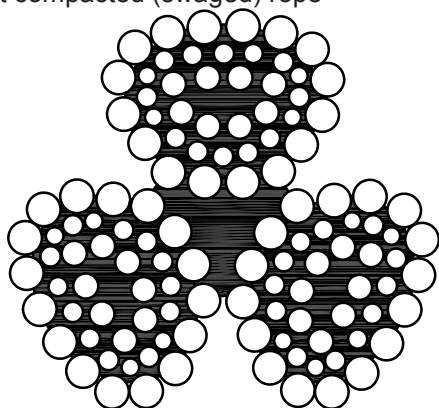

RCN.22

Construction : $K4 \times 40$
 Single-layer compacted (swaged) rope/Rotation-resistant compacted (swaged) rope

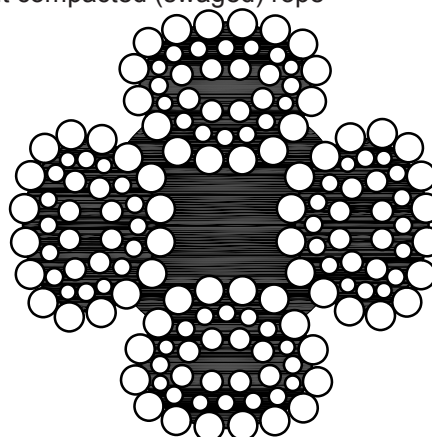

RCN.22

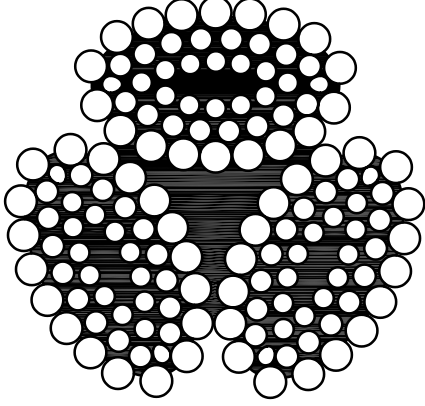
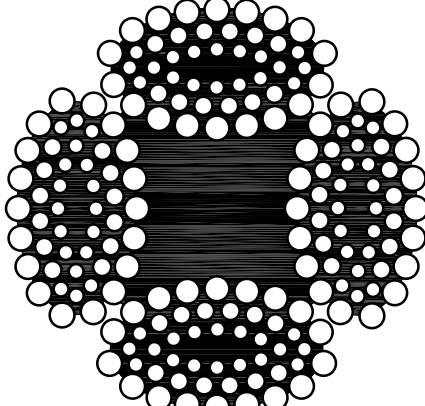
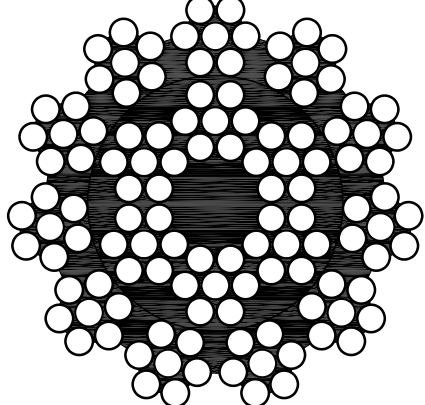
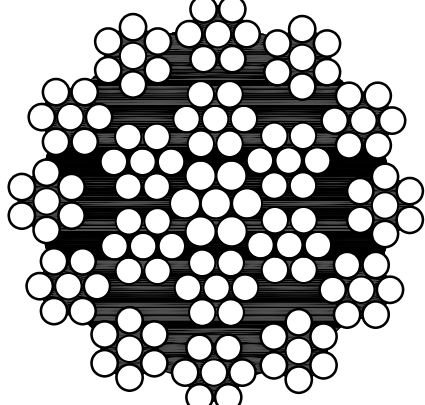
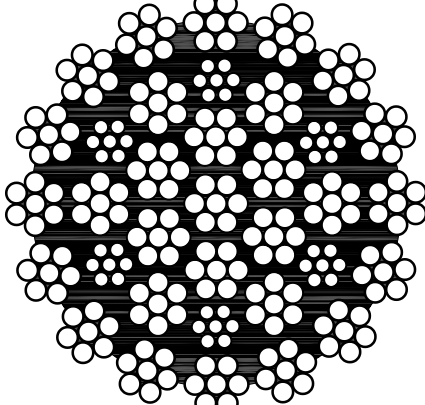
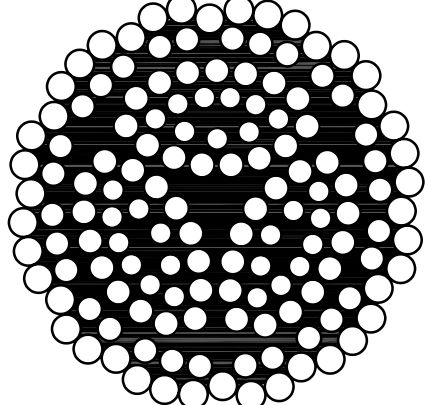
<p>Construction : $K3 \times 48$ Single-layer compacted (swaged) rope/Rotation-resistant compacted (swaged) rope</p>  <p>RCN.22</p>	<p>Construction : $K4 \times 48$ Single-layer compacted (swaged) rope/Rotation-resistant compacted (swaged) rope</p>  <p>RCN.22</p>
<p>Construction : $17 \times 7\text{-FC}$ Rotation-resistant rope</p>  <p>RCN.23-1</p>	<p>Construction : $18 \times 7\text{-WSC}$ or 19×7 Rotation-resistant rope</p>  <p>RCN.23-1</p>
<p>Construction : $34(W) \times 7\text{-WSC}$ or $35(W) \times 7$ Rotation-resistant rope</p>  <p>RCN.23-2</p>	<p>Construction : $12 \times P6:3 \times Q24$ Rotation-resistant rope (Paragon)</p>  <p>RCN.23-1</p>

Construction : 39(W) × 7-WSC
Rotation-resistant rope

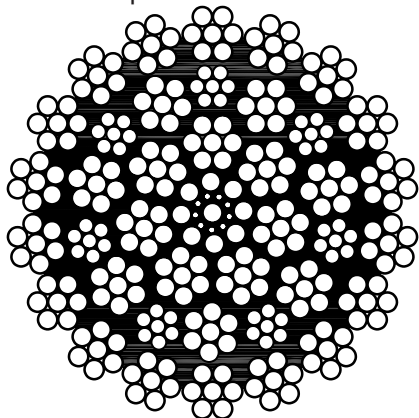

RCN.23-3

Construction : 34(W) × K7-WSC
Rotation-resistant rope with compacted strands
Compacted

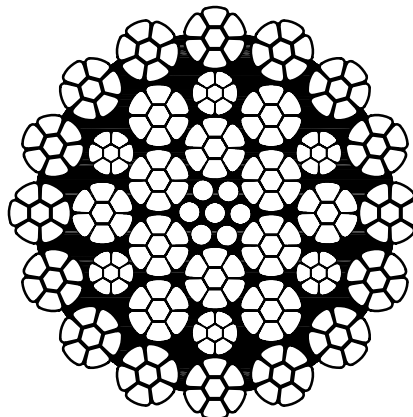

RCN.23-2

Construction : 39(W) × K7-KWSC
Rotation-resistant rope with compacted strands

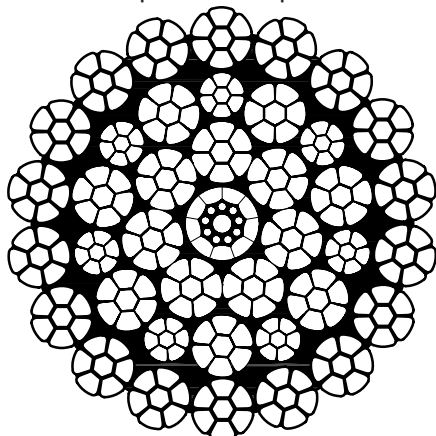

RCN.23-3

.....

Annex H (informative)

Guidance on assessment and rating of external corrosion



Figure H.1 — Beginning of surface oxidation, can be wiped clean, superficial —
Rating: 0 % towards discard



Figure H.2 — Wires rough to touch, general surface oxidation —
Rating: 20 % towards discard



Figure H.3 — Surface of wire now greatly affected by oxidation —
Rating: 60 % towards discard



**Figure H.4 — Surface heavily pitted and wires quite slack, gaps between wires —
Discard immediately**

Bibliography

- [1] ISO 4301-1, *Cranes and lifting appliances — Classification — Part 1: General*
- [2] ISO 4306-1, *Cranes — Vocabulary — Part 1: General*
- [3] ISO 4308-1, *Cranes and lifting appliances — Selection of wire ropes — Part 1: General*
- [4] ISO 4308-2, *Cranes and lifting appliances — Selection of wire ropes — Part 2: Mobile cranes — Coefficient of utilization*

ICS 53.020.30

Price based on 53 pages

Vertical line of small characters on the right edge of the page.

British Standards Institution (BSI)

BSI is the independent national body responsible for preparing British Standards and other standards-related publications, information and services.

It presents the UK view on standards in Europe and at the international level.

It is incorporated by Royal Charter.

Revisions

British Standards are updated by amendment or revision. Users of British Standards should make sure that they possess the latest amendments or editions.

It is the constant aim of BSI to improve the quality of our products and services. We would be grateful if anyone finding an inaccuracy or ambiguity while using this British Standard would inform the Secretary of the technical committee responsible, the identity of which can be found on the inside front cover.

Tel: +44 (0)20 8996 9001 Fax: +44 (0)20 8996 7001

BSI offers Members an individual updating service called PLUS which ensures that subscribers automatically receive the latest editions of standards.

Tel: +44 (0)20 8996 7669 Fax: +44 (0)20 8996 7001

Email: plus@bsigroup.com

Buying standards

You may buy PDF and hard copy versions of standards directly using a credit card from the BSI Shop on the website www.bsigroup.com/shop. In addition all orders for BSI, international and foreign standards publications can be addressed to BSI Customer Services.

Tel: +44 (0)20 8996 9001 Fax: +44 (0)20 8996 7001

Email: orders@bsigroup.com

In response to orders for international standards, it is BSI policy to supply the BSI implementation of those that have been published as British Standards, unless otherwise requested.

Information on standards

BSI provides a wide range of information on national, European and international standards through its Knowledge Centre.

Tel: +44 (0)20 8996 7004 Fax: +44 (0)20 8996 7005

Email: knowledgecentre@bsigroup.com

Various BSI electronic information services are also available which give details on all its products and services.

Tel: +44 (0)20 8996 7111 Fax: +44 (0)20 8996 7048

Email: info@bsigroup.com

BSI Subscribing Members are kept up to date with standards developments and receive substantial discounts on the purchase price of standards. For details of these and other benefits contact Membership Administration.

Tel: +44 (0)20 8996 7002 Fax: +44 (0)20 8996 7001

Email: membership@bsigroup.com

Information regarding online access to British Standards via British Standards Online can be found at www.bsigroup.com/BSOL

Further information about BSI is available on the BSI website at www.bsigroup.com/standards

Copyright

Copyright subsists in all BSI publications. BSI also holds the copyright, in the UK, of the publications of the international standardization bodies. Except as permitted under the Copyright, Designs and Patents Act 1988 no extract may be reproduced, stored in a retrieval system or transmitted in any form or by any means – electronic, photocopying, recording or otherwise – without prior written permission from BSI. This does not preclude the free use, in the course of implementing the standard of necessary details such as symbols, and size, type or grade designations. If these details are to be used for any other purpose than implementation then the prior written permission of BSI must be obtained. Details and advice can be obtained from the Copyright & Licensing Manager.

Tel: +44 (0)20 8996 7070

Email: copyright@bsigroup.com

BSI Group Headquarters

389 Chiswick High Road London W4 4AL UK

Tel +44 (0)20 8996 9001

Fax +44 (0)20 8996 7001

www.bsigroup.com/standards

raising standards worldwide™

Copyright British Standards Institution
Provided by IHS under license with BSI - Uncontrolled Copy
No reproduction or networking permitted without license from IHS

Not for Resale

