

BS ISO 3864-1:2011



BSI Standards Publication

Graphical symbols — Safety colours and safety signs

Part 1: Design principles for safety signs and safety markings

NO COPYING WITHOUT BSI PERMISSION EXCEPT AS PERMITTED BY COPYRIGHT LAW

raising standards worldwide™



National foreword

This British Standard is the UK implementation of ISO 3864-1:2011. It supersedes BS 5499-1:2002 which is withdrawn.

The UK participation in its preparation was entrusted to Technical Committee PH/8/1, Graphical Symbols - Safety Signs.

A list of organizations represented on this committee can be obtained on request to its secretary.

This publication does not purport to include all the necessary provisions of a contract. Users are responsible for its correct application.

© BSI 2011

ISBN 978 0 580 66515 8

ICS 01.080.10

Compliance with a British Standard cannot confer immunity from legal obligations.

This British Standard was published under the authority of the Standards Policy and Strategy Committee on 30 September 2011.

Amendments issued since publication

Date	Text affected
------	---------------

**Graphical symbols — Safety colours and
safety signs —**

Part 1:

**Design principles for safety signs and
safety markings**

Symboles graphiques — Couleurs de sécurité et signaux de sécurité —

*Partie 1: Principes de conception pour les signaux de sécurité et les
marquages de sécurité*





COPYRIGHT PROTECTED DOCUMENT

© ISO 2011

All rights reserved. Unless otherwise specified, no part of this publication may be reproduced or utilized in any form or by any means, electronic or mechanical, including photocopying and microfilm, without permission in writing from either ISO at the address below or ISO's member body in the country of the requester.

ISO copyright office
Case postale 56 • CH-1211 Geneva 20
Tel. + 41 22 749 01 11
Fax + 41 22 749 09 47
E-mail copyright@iso.org
Web www.iso.org

Published in Switzerland

Contents

Page

Foreword	iv
Introduction.....	v
1 Scope	1
2 Normative references	1
3 Terms and definitions	1
4 Purpose of safety colours and safety signs	3
5 General meaning of geometric shapes and safety colours	3
6 Layout for safety signs	5
6.1 General	5
6.2 Prohibition signs	5
6.3 Mandatory action signs	5
6.4 Warning signs	6
6.5 Safe condition signs	6
6.6 Fire equipment signs	7
7 Layout for supplementary signs	7
8 Layout for combination signs	9
9 Layout for multiple signs	9
10 Design principles for graphical symbols	10
11 Layout for safety markings	11
Annex A (informative) Relationship between dimensions of safety signs and distance of observation	12
Bibliography.....	17

Foreword

ISO (the International Organization for Standardization) is a worldwide federation of national standards bodies (ISO member bodies). The work of preparing International Standards is normally carried out through ISO technical committees. Each member body interested in a subject for which a technical committee has been established has the right to be represented on that committee. International organizations, governmental and non-governmental, in liaison with ISO, also take part in the work. ISO collaborates closely with the International Electrotechnical Commission (IEC) on all matters of electrotechnical standardization.

International Standards are drafted in accordance with the rules given in the ISO/IEC Directives, Part 2.

The main task of technical committees is to prepare International Standards. Draft International Standards adopted by the technical committees are circulated to the member bodies for voting. Publication as an International Standard requires approval by at least 75 % of the member bodies casting a vote.

Attention is drawn to the possibility that some of the elements of this document may be the subject of patent rights. ISO shall not be held responsible for identifying any or all such patent rights.

ISO 3864-1 was prepared by Technical Committee ISO/TC 145, *Graphical symbols*, Subcommittee SC 2, *Safety identification, signs, shapes, symbols and colours*.

This part of ISO 3864, together with ISO 3864-4, cancels and replaces ISO 3864-1:2002, which has been technically revised.

ISO 3864 consists of the following parts, under the general title *Graphical symbols — Safety colours and safety signs*:

- *Part 1: Design principles for safety signs and safety markings*
- *Part 2: Design principles for product safety labels*
- *Part 3: Design principles for graphical symbols for use in safety signs*
- *Part 4: Colorimetric and photometric properties of safety sign materials*

Introduction

There is a need to standardize a system of giving safety information that relies as little as possible on the use of words to achieve understanding.

Continued growth in international trade, travel and mobility of labour requires a common method of communicating safety information.

Lack of standardization may lead to confusion and the risk of accidents.

The use of standardized safety signs does not replace proper work methods, instructions and accident prevention training or measures. Education is an essential part of any system that provides safety information.

NOTE Information on procedures, criteria of acceptability, safety sign templates and application of safety signs are given on the website: <http://www.iso.org/tc145/sc2>.

Graphical symbols — Safety colours and safety signs —

Part 1: Design principles for safety signs and safety markings

IMPORTANT — The colours represented in the electronic file of this part of ISO 3864 can be neither viewed on screen nor printed as true representations. Although the copies of this part of ISO 3864 printed by ISO have been produced to correspond (with an acceptable tolerance as judged by the naked eye) to the colour requirements, it is not intended that these printed copies be used for colour matching. Instead, consult ISO 3864-4 which provides colorimetric and photometric properties together with, as a guideline, references from colour order systems.

1 Scope

This part of ISO 3864 establishes the safety identification colours and design principles for safety signs and safety markings to be used in workplaces and in public areas for the purpose of accident prevention, fire protection, health hazard information and emergency evacuation. It also establishes the basic principles to be applied when developing standards containing safety signs.

This part of ISO 3864 is applicable to all locations where safety issues related to people need to be addressed. However, it is not applicable to the signalling used for guiding rail, road, river, maritime and air traffic and, generally speaking, to those sectors subject to a regulation which may differ.

NOTE Some countries' statutory regulations might differ in some respect from those given in this part of ISO 3864.

2 Normative references

The following referenced documents are indispensable for the application of this document. For dated references, only the edition cited applies. For undated references, the latest edition of the referenced document (including any amendments) applies.

ISO 3864-3, *Graphical symbols — Safety colours and safety signs — Part 3: Design principles for graphical symbols for use in safety signs*

ISO 3864-4, *Graphical symbols — Safety colours and safety signs — Part 4: Colorimetric and photometric properties of safety sign materials*

ISO 17724:2003, *Graphical symbols — Vocabulary*

3 Terms and definitions

For the purposes of this document, the terms and definitions given in ISO 17724 and the following apply.

3.1

combination sign

sign that combines a safety sign and one or more associated supplementary signs on the same rectangular carrier

3.2
factor of distance

z

relationship between the height (*h*) of a sign and the observation distance (*l*), used to determine observation distances of signs

$$z = l/h$$

[ISO 17724:2003, 28]

3.3
fire equipment sign

safety sign that indicates the location or identification of fire equipment

3.4
identifiability

property of a graphical symbol which enables its elements to be perceived as the objects or shapes depicted

[ISO 9186-2:2008, 3.1]

3.5
mandatory action sign

safety sign that indicates that a specific course of action is to be taken

3.6
multiple sign

sign that combines two or more safety signs and associated supplementary signs on the same rectangular carrier

3.7
prohibition sign

safety sign that indicates that a specific behaviour is forbidden

3.8
safe condition sign

safety sign that indicates an evacuation route, the location of safety equipment or a safety facility, or a safety action

3.9
safe observation distance

distance a person can be from a safety sign while still able to identify the safety sign and have the opportunity to follow the message

NOTE Adapted from ISO 3864-2.

3.10
safety colour

colour with special properties to which a safety meaning is attributed

3.11
safety marking

marking which adopts the use of safety colours and safety contrast colours to convey a safety message or render an object or location conspicuous

3.12
safety sign

sign which gives a general safety message, obtained by a combination of a colour and geometric shape and which, by the addition of a graphical symbol, gives a particular safety message

3.13

sign height

diameter of a circular geometric shape or height of a rectangular or triangular geometric shape

3.14

supplementary sign

sign that is supportive of a safety sign and the main purpose of which is to provide additional clarification

3.15

visual acuity

capacity for seeing distinctly fine details that have a very small angular separation

[ISO 17724:2003, 82]

3.16

warning sign

safety sign that indicates a specific source of potential harm

4 Purpose of safety colours and safety signs





4.1 The purpose of safety colours and safety signs is to draw attention rapidly to objects and situations affecting safety and health and to gain rapid understanding of a specific message.

4.2 Safety signs shall be used only for instructions which are related to the safety and health of people.

5 General meaning of geometric shapes and safety colours

The general meaning assigned to geometric shapes, safety colours and contrast colours is given in Tables 1 and 2.

Table 1 — Geometric shapes, safety colours and contrast colours for safety signs

Geometric shape	Meaning	Safety colour	Contrast colour to the safety colour	Graphical symbol colour	Examples of use
 Circle with diagonal bar	Prohibition	Red	White ^a	Black	<ul style="list-style-type: none"> — No smoking — Not drinking water — Do not touch
 Circle	Mandatory action	Blue	White ^a	White ^a	<ul style="list-style-type: none"> — Wear eye protection — Wear protective clothing — Wash your hands
 Equilateral triangle with radiused outer corners	Warning	Yellow	Black	Black	<ul style="list-style-type: none"> — Warning; Hot surface — Warning; Biological hazard — Warning; Electricity
 Square	Safe condition	Green	White ^a	White ^a	<ul style="list-style-type: none"> — First aid — Emergency exit — Evacuation assembly point
 Square	Fire equipment	Red	White ^a	White ^a	<ul style="list-style-type: none"> — Fire alarm call point — Collection of fire fighting equipment — Fire extinguisher

^a The colour white includes the colour for phosphorescent material under daylight conditions with properties as defined in ISO 3864-4.

Table 2 — Geometric shape, background colours and contrast colours for supplementary signs

Geometric shape	Meaning	Background colour	Contrast colour to background colour	Colour of supplementary safety information
 Rectangle	Supplementary information	White	Black	Any
		Safety colour of the safety sign	Black or white	

It is essential to achieve a luminance contrast between the safety sign and its background as well as between the supplementary sign and its background on which they are mounted or displayed.

6 Layout for safety signs

6.1 General

The safety colours, contrast colours and geometric shapes (see Clause 5) shall be used only in the following combinations to obtain the five types of safety signs (see Figures 1 to 5).

NOTE Layout templates for safety signs for ISO 7010 are available from the website of ISO/TC 145/SC 2.

6.2 Prohibition signs

Prohibition signs shall comply with the layout requirements given in Figure 1. The centre line of the diagonal bar shall pass through the centre point of the prohibition sign and shall cover the graphical symbol.

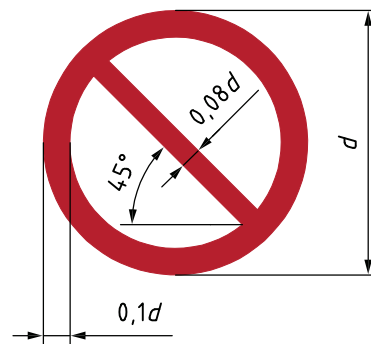

The colours of the sign shall be as follows:

Background colour:	white
Circular band and diagonal bar:	red
Graphical symbol:	black

Figure 1 — Layout requirements for a prohibition sign

6.3 Mandatory action signs

Mandatory action signs shall comply with the layout requirements given in Figure 2.

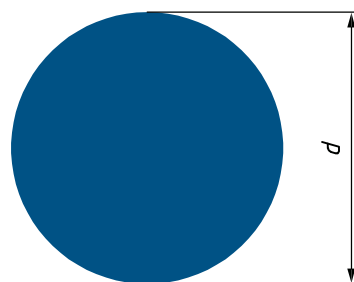

The colours of the sign shall be as follows:

Background colour:	blue
Graphical symbol:	white

The safety colour blue shall cover at least 50 % of the area of the sign.

Figure 2 — Layout requirements for a mandatory action sign

6.4 Warning signs

Warning signs shall comply with the layout requirements given in Figure 3.

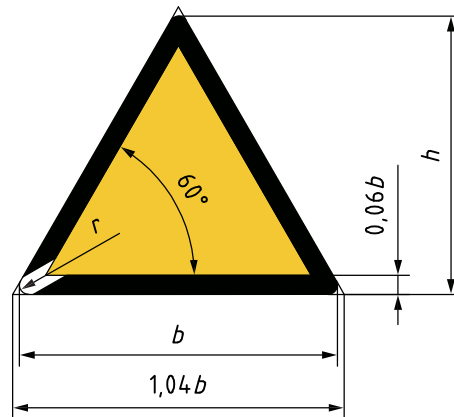

If $b = 70$ mm, then $r = 2$ mm.

The colours of the sign shall be as follows:

Background colour:	yellow
Triangular band:	black
Graphical symbol:	black

The safety colour yellow shall cover at least 50 % of the total area of the sign.

Figure 3 — Layout requirements for a warning sign

6.5 Safe condition signs

Safe condition signs shall comply with the layout requirements given in Figure 4.

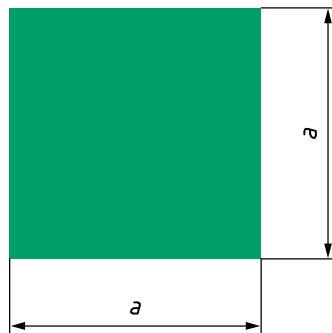

The colours of the sign shall be as follows:

Background colour:	green
Graphical symbol:	white

The safety colour green shall cover at least 50 % of the area of the sign.

Figure 4 — Layout requirements for a safe condition sign

6.6 Fire equipment signs

Fire equipment signs shall comply with the layout requirements given in Figure 5.

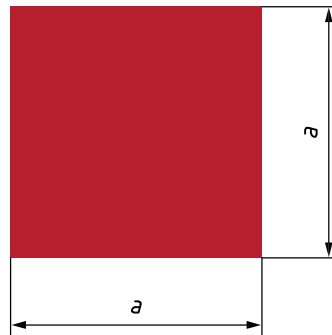

The colours of the sign shall be as follows:

Background colour:	red
Graphical symbol:	white

The safety colour red shall cover at least 50 % of the area of the sign.

Figure 5 — Layout requirements for a fire equipment sign

7 Layout for supplementary signs

Supplementary safety information, as text and/or in the form of a graphical symbol may be used to describe, supplement or clarify the meaning of a safety sign. The supplementary safety information shall be placed in a separate supplementary sign or included as part of a combination sign (see Clause 8) or a multiple sign (see Clause 9).

Supplementary signs shall comply with the layout requirements given in Figure 6.

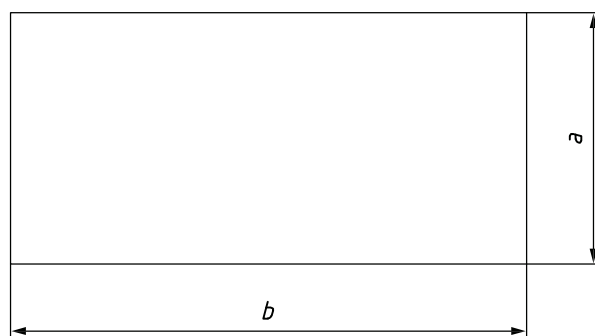

The colours of the sign shall be as follows:

Background colour:	white or safety colour of the safety sign
--------------------	---

Figure 6 — Layout requirements for a supplementary sign

Supplementary signs can be placed above, below, to the left or to the right of a safety sign; see Figure 7.

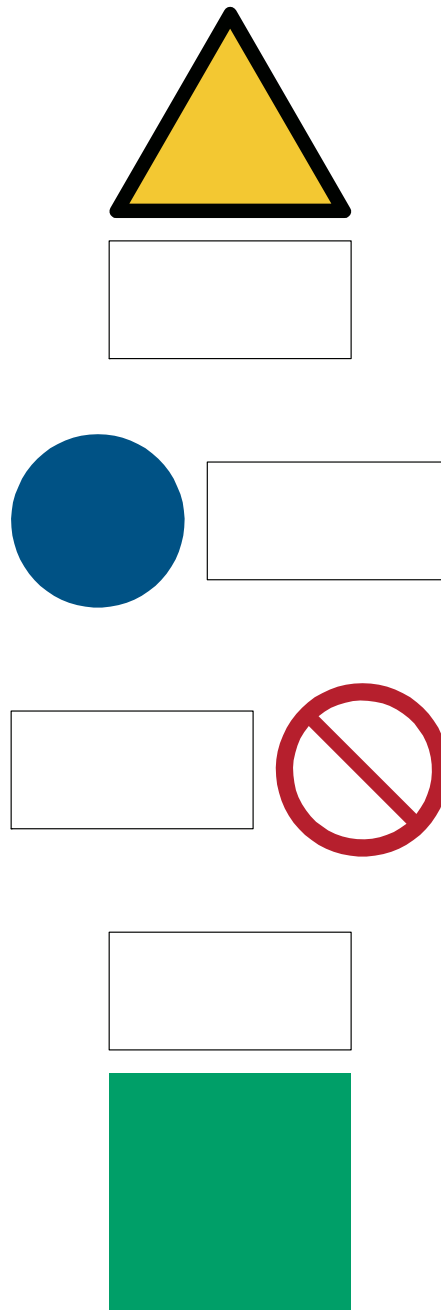
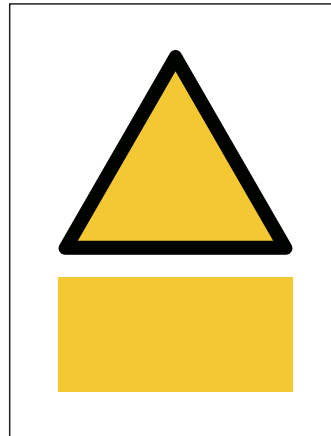

Figure 7 — Examples of position assignment of a supplementary sign

8 Layout for combination signs

Examples of layouts for a combination sign are shown in Figures 8 and 9.



The colours of the sign shall be as follows:

Colour of sign carrier: safety colour of the safety sign or white

Figure 8 — Layout for a combination sign with the supplementary sign below the safety sign



The colours of the sign shall be as follows:

Colour of sign carrier: safety colour of the safety sign or white

Figure 9 — Layout for a combination sign with the supplementary sign to the right of the safety sign

9 Layout for multiple signs

Multiple signs are a means of communicating complex safety messages. Examples of layouts for a multiple sign used to communicate a warning, a mandatory action and a prohibition are given in Figures 10 and 11.

The order of the safety signs (and any corresponding supplementary signs) should be displayed according to the order of priority that is chosen for each of the safety messages.

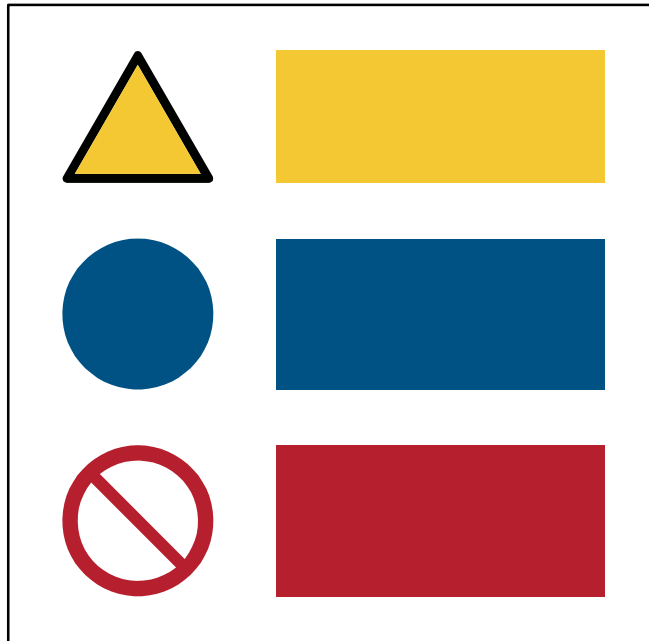

Figure 10 — Example of a vertical layout for a multiple sign

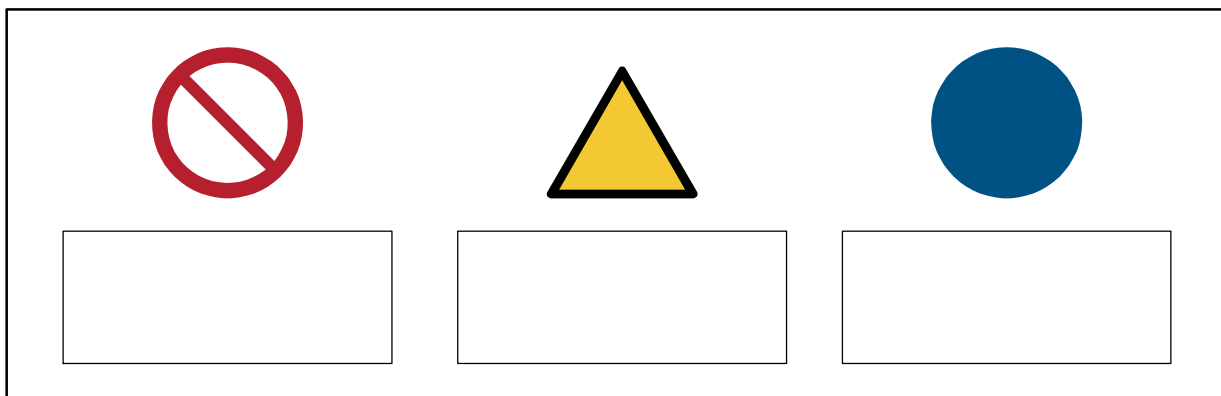

Figure 11 — Example of a horizontal layout for a multiple sign





10 Design principles for graphical symbols

Graphical symbols for use in safety signs shall be designed according to the principles given in ISO 3864-3.

11 Layout for safety markings

For the layout and meaning of safety markings see Table 3. The bands are of equal width inclined at an angle of approximately 45°.

Table 3 — Layout and meaning of safety markings

Layout	Colour combination	Meaning/Use	
	Yellow and contrast black	Hazard locations and obstacles where there is the risk of	To warn of potential hazards
	Red and contrast white	— people bumping, falling or tripping or — loads falling	To prohibit entry
	Blue and contrast white	To indicate a mandatory instruction	
	Green and contrast white	To indicate a safe condition	

Annex A (informative)

Relationship between dimensions of safety signs and distance of observation

A.1 General

This annex relates to the perceptual quality of the graphical symbol elements of safety signs, not the comprehension or meaning of the safety sign. In addition to being comprehensible, a graphical symbol should have sufficient perceptual quality to enable the eventual user population in a practical situation to identify its elements correctly. If the symbol's ultimate meaning is to be understood, it is essential that its elements be identifiable.

NOTE 1 ISO 9186-2 describes the concept of perceptual quality of graphical symbol elements.

As the distance of observation from a safety sign increases, the subtended visual angles of graphical symbols decrease. The task of identifying the graphical symbol elements is more difficult as the distance of observation increases, which results in smaller percentages of the user population correctly identifying the graphical symbol elements. Hence at some short distance of observation, the design of the graphical symbol elements should be such that a very high percentage of the intended user population is able to correctly identify the graphical symbol elements; whereas at some longer distance of observation, a low percentage or none of the intended user population would be able to do so. Because the distance for correct identification of the graphical symbol elements varies between individuals, the probability that a certain percentage of the intended user population can make the correct identification is statistical in nature. It is therefore important that a high percentage of the intended user population be able to correctly identify the graphical symbol elements and comprehend the meaning of the safety sign at a distance such that they are able to follow the safety message. A practical criterion is that at least 85 % of the intended user population would correctly identify the graphical symbol elements at the minimum safe observation distance for the safety sign.

The evaluation of identifiability of graphical symbol elements is a complex task. Various factors and conditions influence the identifiability:

- size of the graphical symbol elements and parts thereof within the safety sign geometrical shape;
- whether the safety sign is an externally illuminated or internally illuminated safety sign and the materials used;
- luminance, luminance contrast or contrast between the graphical symbols and background of the safety sign geometrical shape;
- illumination conditions;
- observation angle;
- visual acuity of the intended user population — whether normal sighted (normal visual acuity), wearing correction lenses or having vision impairments;
- familiarity with the depicted object or shape.

NOTE 2 ISO 3864-4:2011, Annex D provides guidance on contrast for externally illuminated safety signs and luminance contrast for internally illuminated safety signs.

A.2 Distance factor for observing normal to the safety sign

A.2.1 Distance factor z is used in the relationship between observation distance, l , and the height of the safety sign, h , which is specified in 6.2 to 6.6. The dimensional units of h and l are the same. Figure A.1 illustrates an observation distance from an observation position normal to the centre of the safety sign. The subscript "0" on z_0 denotes that the observation position is normal to the centre of the safety sign.

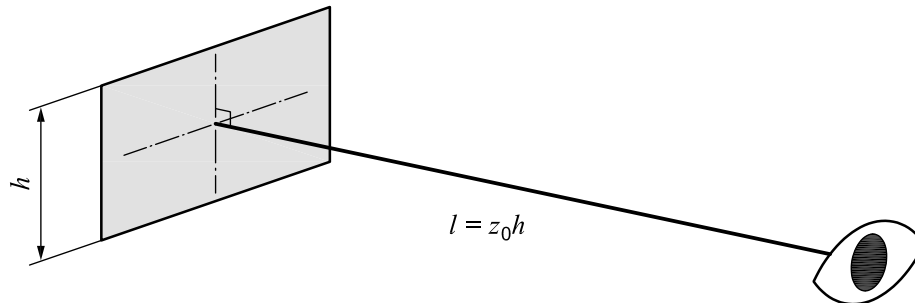

Figure A.1 — Example of observation distance normal to the centre of the safety sign

For the height h of the sign take:

- d for prohibition and mandatory action signs (see 6.2 and 6.3);
- h for warning signs (see 6.4);
- a for safe condition signs, fire equipment signs and supplementary signs (see 6.5, 6.6 and Clause 7).

The distance factor depends upon the perceptual characteristics of the graphical symbol elements and their size within the basic geometric shape of the safety sign. The relative size of the graphical symbol elements and the basic geometric shape of the safety sign are fixed in the safety signs registered in ISO 7010.

For a given intended user population and illumination condition, the value of z_0 can vary between safety signs. For externally illuminated safety signs with about 100 lx measured on the surface of the safety sign and a user population with normal sight or corrected sight, use the test method specified in ISO 9186-2 to determine a value of z_0 associated with a criterion percentage of at least 85 % correct identification of the graphical symbol elements. However, where the percentage of a normal sighted population correctly identifying the graphical symbol elements is not known for the specific safety sign, use a general value of z_0 of 60.

A.2.2 For externally illuminated safety signs, the distance factor is affected by the level of illumination at the sign. In general, for externally illuminated safety signs in a low illumination environment, such as illumination by emergency lighting, z_0 should be multiplied by a factor of 0,5.

For externally illuminated ISO 7010-E001 and -E002 emergency exit signs, the recommended values of z_0 at different illumination levels are given in Table A.1. The same values of z_0 can be applied to externally illuminated supplementary direction arrows.

Table A.1 — Distance factor z_0 for externally illuminated emergency exit signs based on ordinary materials or phosphorescent materials

Vertical illuminance at sign lx	Distance factor z_0
≥ 5	95
≥ 100	170
≥ 200	185
≥ 400	200

NOTE Over the illuminance range up to about 200 lx, z_0 varies approximately linearly with the logarithm of illuminance.

For internally illuminated safety signs, distance factor is affected by the luminance and luminance contrast of the safety sign. Generalized values of distance factor are not available. The test method of ISO 9186-2 can be adapted by using set longer observation distances in a darkened environment.

For internally illuminated ISO 7010-E001 and -E002 emergency exit signs, recommended values of z_0 at different luminances of the white contrast colour are given in Table A.2. The same values of z_0 can be applied to internally illuminated supplementary direction arrows.

Table A.2 — Distance factor z_0 for internally illuminated emergency exit signs

Mean luminance of white contrast colour cd/m ²	Distance factor z_0
≥ 10	150
≥ 30	175
≥ 100	200
≥ 200	215
≥ 500	230

NOTE Over the luminance range up to about 50 cd/m², z_0 varies approximately linearly with logarithm of luminance.

A.2.3 People with impaired vision can have low visual acuity. For people with 6/60 visual acuity, z_0 should be multiplied by a factor of 0,1.

NOTE The equivalent numerical visual acuity of 6/60 is 0,1. 6/6 for people with normal sight is a numerical visual acuity of 1.

A.3 Distance factor for observing the safety sign from different angles

When the observation is at an angle to the normal of the safety sign, the projected dimensions of the sign are reduced, thereby reducing the observation distance for correct identification of the graphical symbol elements. For an externally or internally illuminated safety sign with Lambertian intensity characteristics, if α is the angle between the direct line of sight and line of the normal to the sign (from the centre point of the sign), the factor for this angle, z_α is calculated as follows:

$$z_\alpha = z_0 \cos \alpha$$

For example, when observing a safety sign at 30°, 45° or 60° to the normal, z_0 should be multiplied by 0,87, 0,71 or 0,5 respectively.

Observation distances for equal identifiability of graphical symbol elements of a safety sign are rings of diameter z_0 . Figure A.2 illustrates rings in vertical and horizontal planes. In three dimensions, the rings form the outer surface of a sphere of diameter z_0 .

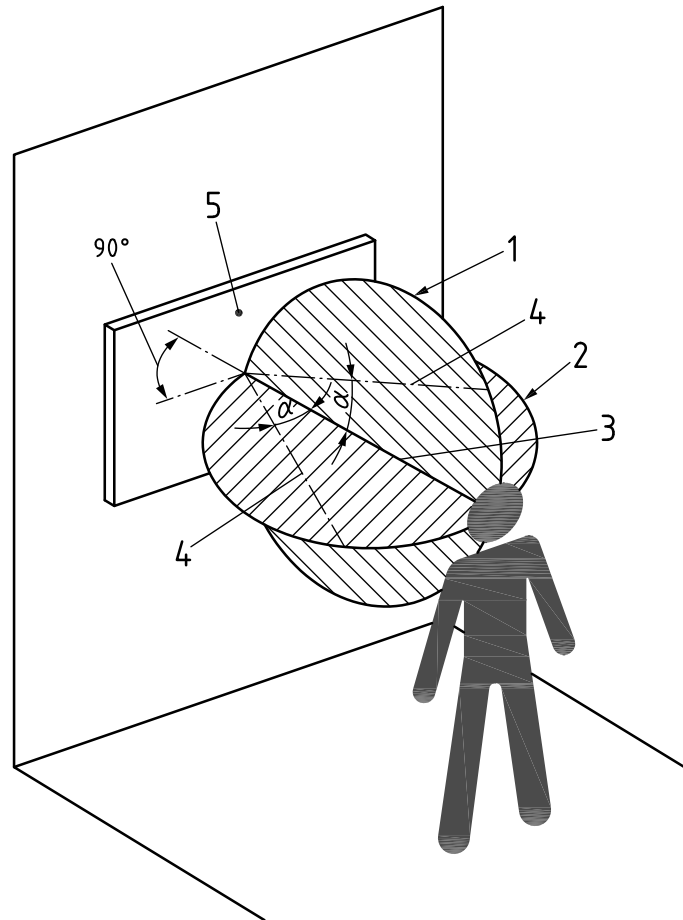

Key

- 1 vertical ring of diameter z_0
- 2 horizontal ring of diameter z_0
- 3 observation distance normal to safety sign, z_0
- 4 observation distance at angle α to normal, $z_0 \cos \alpha$
- 5 plane of safety sign

Figure A.2 — Vertical and horizontal rings for observation distances of equal identifiability of graphical symbol elements of the safety sign

A.4 Selection of size of safety sign

Observers need to be informed of potential hazards and of the safety precautions and/or actions required to avoid the hazards before the observer makes any contact with the hazards. The diameter of circular rings of equal identifiability varies according to the percentage of correct identifiability. Figure A.3 illustrates three circular rings on the horizontal plane normal to the centre of the safety sign for different percentages for correct identification of the graphical symbol elements.

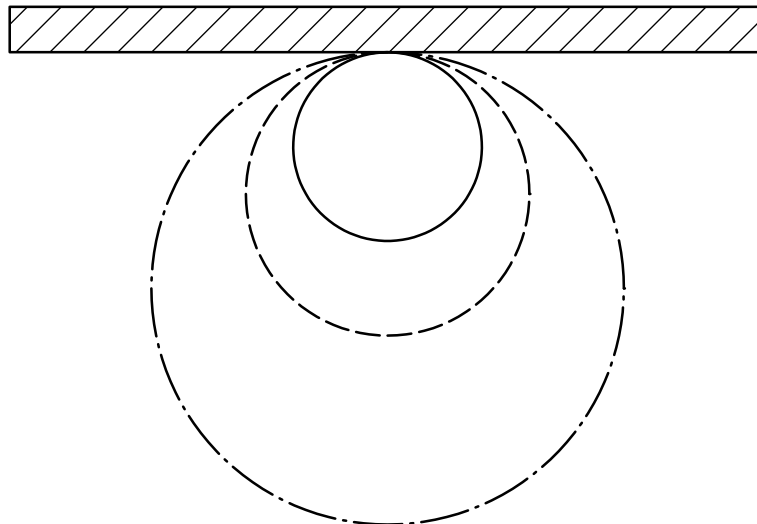

- Horizontal ring for 85 % correct identification - ring diameter z_0
- - - - Horizontal ring for 50 % correct identification - ring diameter $1,5 z_0$
- . - . Horizontal ring for 15 % correct identification - ring diameter $2,5 z_0$

Figure A.3 — Example of horizontal rings for observation distances for correction identification of the graphical symbol elements of the safety sign by 85 %, 50 % and 15 % of a user population

Risk assessment of the hazard should be carried out to determine an appropriate safe observation distance, l_s , for the intended user population, angles of observation (including angles of approach to the safety sign) and lighting conditions.

The minimum height of the safety sign, in millimetres (mm), can be calculated from the following equation:

$$h \geq l_s / z$$

where

l_s is the required safe observation distance in millimetres (mm);

z is the relevant distance factor.

Bibliography

- [1] ISO 3864-2, *Graphical symbols — Safety colours and safety signs — Part 2: Design principles for product safety labels*
- [2] ISO 7010, *Graphical symbols — Safety colours and safety signs — Registered safety signs*
- [3] ISO 9186-2:2008, *Graphical symbols — Test method — Part 2: Method for testing perceptual quality*

British Standards Institution (BSI)

BSI is the independent national body responsible for preparing British Standards and other standards-related publications, information and services.

It presents the UK view on standards in Europe and at the international level.

It is incorporated by Royal Charter.

Revisions

British Standards are updated by amendment or revision. Users of British Standards should make sure that they possess the latest amendments or editions.

It is the constant aim of BSI to improve the quality of our products and services. We would be grateful if anyone finding an inaccuracy or ambiguity while using this British Standard would inform the Secretary of the technical committee responsible, the identity of which can be found on the inside front cover.

Tel: +44 (0)20 8996 9001 Fax: +44 (0)20 8996 7001

BSI offers Members an individual updating service called PLUS which ensures that subscribers automatically receive the latest editions of standards.

Tel: +44 (0)20 8996 7669 Fax: +44 (0)20 8996 7001

Email: plus@bsigroup.com

Buying standards

You may buy PDF and hard copy versions of standards directly using a credit card from the BSI Shop on the website www.bsigroup.com/shop. In addition all orders for BSI, international and foreign standards publications can be addressed to BSI Customer Services.

Tel: +44 (0)20 8996 9001 Fax: +44 (0)20 8996 7001

Email: orders@bsigroup.com

In response to orders for international standards, it is BSI policy to supply the BSI implementation of those that have been published as British Standards, unless otherwise requested.

Information on standards

BSI provides a wide range of information on national, European and international standards through its Knowledge Centre.

Tel: +44 (0)20 8996 7004 Fax: +44 (0)20 8996 7005

Email: knowledgecentre@bsigroup.com

Various BSI electronic information services are also available which give details on all its products and services.

Tel: +44 (0)20 8996 7111 Fax: +44 (0)20 8996 7048

Email: info@bsigroup.com

BSI Subscribing Members are kept up to date with standards developments and receive substantial discounts on the purchase price of standards. For details of these and other benefits contact Membership Administration.

Tel: +44 (0)20 8996 7002 Fax: +44 (0)20 8996 7001

Email: membership@bsigroup.com

Information regarding online access to British Standards via British Standards Online can be found at www.bsigroup.com/BSOL

Further information about BSI is available on the BSI website at www.bsigroup.com/standards

Copyright

Copyright subsists in all BSI publications. BSI also holds the copyright, in the UK, of the publications of the international standardization bodies. Except as permitted under the Copyright, Designs and Patents Act 1988 no extract may be reproduced, stored in a retrieval system or transmitted in any form or by any means – electronic, photocopying, recording or otherwise – without prior written permission from BSI. This does not preclude the free use, in the course of implementing the standard of necessary details such as symbols, and size, type or grade designations. If these details are to be used for any other purpose than implementation then the prior written permission of BSI must be obtained. Details and advice can be obtained from the Copyright & Licensing Manager.

Tel: +44 (0)20 8996 7070

Email: copyright@bsigroup.com

BSI Group Headquarters

389 Chiswick High Road London W4 4AL UK

Tel +44 (0)20 8996 9001

Fax +44 (0)20 8996 7001

www.bsigroup.com/standards