



BSI Standards Publication

Heat treatable steels, alloy steels and free-cutting steels

Part 5: Nitriding steels

National foreword

This British Standard is the UK implementation of ISO 683-5:2017. It supersedes BS ISO 683-5:2014, which is withdrawn.

The UK participation in its preparation was entrusted to Technical Committee ISE/105, Steels for Heat Treatment, Alloy Steels, Free-Cutting Steels and Stainless Steels.

A list of organizations represented on this committee can be obtained on request to its secretary.

This publication does not purport to include all the necessary provisions of a contract. Users are responsible for its correct application.

© The British Standards Institution 2017
Published by BSI Standards Limited 2017

ISBN 978 0 580 97837 1

ICS 77.140.20; 77.140.10

Compliance with a British Standard cannot confer immunity from legal obligations.

This British Standard was published under the authority of the Standards Policy and Strategy Committee on 31 July 2017.

Amendments/corrigenda issued since publication

Date	Text affected
------	---------------

INTERNATIONAL
STANDARD

ISO
683-5

Second edition
2017-07

**Heat treatable steels, alloy steels and
free-cutting steels —**

**Part 5:
Nitriding steels**

*Aciers pour traitement thermique, aciers alliés et aciers pour
décolletage —*

Partie 5: Aciers pour nitruration



Reference number
ISO 683-5:2017(E)

© ISO 2017



COPYRIGHT PROTECTED DOCUMENT

© ISO 2017, Published in Switzerland

All rights reserved. Unless otherwise specified, no part of this publication may be reproduced or utilized otherwise in any form or by any means, electronic or mechanical, including photocopying, or posting on the internet or an intranet, without prior written permission. Permission can be requested from either ISO at the address below or ISO's member body in the country of the requester.

ISO copyright office
Ch. de Blandonnet 8 • CP 401
CH-1214 Vernier, Geneva, Switzerland
Tel. +41 22 749 01 11
Fax +41 22 749 09 47
copyright@iso.org
www.iso.org

Contents

Page

Foreword	v
1 Scope	1
2 Normative references	1
3 Terms and definitions	2
4 Classification and designation	3
4.1 Classification.....	3
4.2 Designation.....	3
5 Information to be supplied by the purchaser	3
5.1 Mandatory information.....	3
5.2 Options/supplementary or special requirements.....	3
5.3 Ordering example.....	4
6 Manufacturing process	4
6.1 General.....	4
6.2 Deoxidization.....	4
6.3 Heat treatment and surface condition at delivery.....	4
6.3.1 Normal condition at delivery.....	4
6.3.2 Particular heat-treatment condition.....	4
6.3.3 Particular surface conditions.....	4
6.4 Traceability of the cast.....	4
7 Requirements	4
7.1 Chemical composition, hardness and mechanical properties.....	4
7.1.1 General.....	4
7.1.2 Chemical composition.....	5
7.1.3 Mechanical properties.....	5
7.2 Machinability.....	5
7.3 Cold shearability.....	5
7.4 Grain size.....	5
7.5 Non-metallic inclusions.....	5
7.5.1 Microscopic inclusions.....	5
7.5.2 Macroscopic inclusions.....	5
7.6 Internal soundness.....	5
7.7 Surface quality.....	5
7.8 Decarburization.....	6
7.9 Shape, dimensions and tolerances.....	6
8 Inspection	6
8.1 Testing procedures and types of documents.....	6
8.2 Frequency of testing.....	7
8.3 Specific inspection and testing.....	7
8.3.1 Verification of the hardness and mechanical properties.....	7
8.3.2 Visual and dimensional inspection.....	7
9 Test methods	7
9.1 Chemical analysis.....	7
9.2 Hardness and mechanical tests.....	7
9.2.1 Hardness.....	7
9.2.2 Mechanical tests.....	7
9.2.3 Impact test.....	7
9.3 Retests.....	8
10 Marking	8
Annex A (normative) Ruling sections for mechanical properties	18
Annex B (normative) Supplementary or special requirements	22

Annex C (informative) Designation of steels given in this document and of comparable grades covered in various designation systems	24
Annex D (informative) Dimensional standards applicable to products complying with this document	25
Bibliography	26

Foreword

ISO (the International Organization for Standardization) is a worldwide federation of national standards bodies (ISO member bodies). The work of preparing International Standards is normally carried out through ISO technical committees. Each member body interested in a subject for which a technical committee has been established has the right to be represented on that committee. International organizations, governmental and non-governmental, in liaison with ISO, also take part in the work. ISO collaborates closely with the International Electrotechnical Commission (IEC) on all matters of electrotechnical standardization.

The procedures used to develop this document and those intended for its further maintenance are described in the ISO/IEC Directives, Part 1. In particular the different approval criteria needed for the different types of ISO documents should be noted. This document was drafted in accordance with the editorial rules of the ISO/IEC Directives, Part 2 (see www.iso.org/directives).

Attention is drawn to the possibility that some of the elements of this document may be the subject of patent rights. ISO shall not be held responsible for identifying any or all such patent rights. Details of any patent rights identified during the development of the document will be in the Introduction and/or on the ISO list of patent declarations received (see www.iso.org/patents).

Any trade name used in this document is information given for the convenience of users and does not constitute an endorsement.

For an explanation on the voluntary nature of standards, the meaning of ISO specific terms and expressions related to conformity assessment, as well as information about ISO's adherence to the World Trade Organization (WTO) principles in the Technical Barriers to Trade (TBT) see the following URL: www.iso.org/iso/foreword.html.

This document was prepared by Technical Committee ISO/TC 17, *Steel*, Subcommittee SC 4, *Heat treatable and alloy steels*.

This second edition cancels and replaces the first edition (ISO 683-5:2014), of which it constitutes a minor revision.

The main changes compared to the previous edition are as follows:

- in the Scope, “see [5.2](#)” has been added as a cross reference;
- in [3.1](#), note 1 to entry has been revised;
- in [5.2](#), the ordering example has been moved into a new subclause, as [5.3](#);
- in [7.7.3](#), the surface class given has been changed from A to 1z2;
- in [9.2.3](#), the option for retesting has been revised;
- Figure 3 has been renamed as [Table 9](#);
- in [A.2.1](#), the cross references have been corrected to [A.2.2](#) to [A.2.4](#).

A list of all parts in the ISO 683 series can be found on the ISO website.

Heat treatable steels, alloy steels and free-cutting steels —

Part 5: Nitriding steels

1 Scope

This document gives the technical delivery requirements for

- semi-finished products, e.g. blooms, billets, slabs (see note 1),
- bars (see note 1),
- wire rod,
- hot-rolled plates (see note 2), and
- hammer or drop forgings (see note 1)

manufactured from the nitriding steels listed in [Table 3](#) and supplied in one of the heat-treatment conditions given for the different types of products in [Table 1](#), rows 2 to 5, and in one of the surface conditions given in [Table 2](#).

The steels are generally intended for the fabrication of quenched and tempered and, subsequently, nitriding machine parts.

The requirements for mechanical properties given in this document are restricted to the sizes given in [Table 6](#).

NOTE 1 Hammer-forged semi-finished products (blooms, billets, slabs, etc.), seamless rolled rings and hammer-forged bars are in the following covered under semi-finished products or bars and not under the term “hammer and drop forgings”.

NOTE 2 The term “plate” includes in the following also wide flats unless otherwise stated.

In special cases, variations in these technical delivery requirements or additions to these requirements can form the subject of an agreement at the time of enquiry and order (see [5.2](#) and [Annex B](#)).

In addition to this document, the general technical delivery requirements of ISO 404 are applicable.

2 Normative references

The following documents are referred to in the text in such a way that some or all of their content constitutes requirements of this document. For dated references, only the edition cited applies. For undated references, the latest edition of the referenced document (including any amendments) applies.

ISO 148-1, *Metallic materials — Charpy pendulum impact test — Part 1: Test method*

ISO 377, *Steel and steel products — Location and preparation of samples and test pieces for mechanical testing*

ISO 404:2013, *Steel and steel products — General technical delivery requirements*

ISO 643, *Steels — Micrographic determination of the apparent grain size*

ISO 3887, *Steels — Determination of depth of decarburization*

ISO 4885, *Ferrous materials — Heat treatments — Vocabulary*

ISO 4948-1, *Steels — Classification — Part 1: Classification of steels into unalloyed and alloy steels based on chemical composition*

ISO 4948-2, *Steels — Classification — Part 2: Classification of unalloyed and alloy steels according to main quality classes and main property or application characteristics*

ISO/TS 4949, *Steel names based on letter symbols*

ISO 4967, *Steel — Determination of content of non-metallic inclusions — Micrographic method using standard diagrams*

ISO 6506-1, *Metallic materials — Brinell hardness test — Part 1: Test method*

ISO 6892-1, *Metallic materials — Tensile testing — Part 1: Method of test at room temperature*

ISO 6929, *Steel products — Vocabulary*

ISO 7788, *Steel — Surface finish of hot-rolled plates and wide flats — Delivery requirements*

ISO 9443, *Heat-treatable and alloy steels — Surface quality classes for hot-rolled round bars and wire rods — Technical delivery conditions*

ISO/TR 9769, *Steel and iron — Review of available methods of analysis*

ISO 10474, *Steel and steel products — Inspection documents*

ISO 14284, *Steel and iron — Sampling and preparation of samples for the determination of chemical composition*

3 Terms and definitions

For the purposes of this document, the terms and definitions given in ISO 377, ISO 4885, ISO 4948-1, ISO 4948-2, ISO 6929 and ISO 14284 and the following apply.

ISO and IEC maintain terminological databases for use in standardization at the following addresses:

- IEC Electropedia: available at <http://www.electropedia.org/>
- ISO Online browsing platform: available at <http://www.iso.org/obp>

3.1 ruling section

section for which the specified mechanical properties shall apply

Note 1 to entry: Independent of the actual shape and dimensions of the cross-section of the product, the size of its ruling section is always given by a diameter. This corresponds to the diameter of an “equivalent round bar”. That is a round bar which will show the same cooling rate as the actual ruling section of the product concerned at its position for taking the test pieces when being cooled from austenitizing temperature.

3.2 nitriding steel

heat-treatable steel containing controlled amounts of the nitride forming elements, aluminium, chromium, molybdenum and/or vanadium and are particularly suited for nitriding

3.3 nitriding

heat treatment characterized by keeping a steel product for a sufficiently long time at temperatures below the transformation temperature AC1 in a nitrogen providing gaseous or liquid salt environment to achieve diffusion of the nitrogen into the steel surface

Note 1 to entry: An increase in surface hardness, wear resistance and fatigue properties is attained with this treatment.

4 Classification and designation

4.1 Classification

The classification of the relevant steel grades is allocated in accordance with ISO 4948-1 and ISO 4948-2. All steels covered by this document are classified as alloy special steels.

4.2 Designation

For the steel grades covered by this document, the steel names as given in the relevant tables are allocated in accordance with ISO/TS 4949.

The designation of steels given in this document and of comparable grades covered in various designation systems is given in [Annex C](#).

5 Information to be supplied by the purchaser

5.1 Mandatory information

The manufacturer shall obtain the following information from the purchaser at the time of enquiry and order:

- a) the quantity to be delivered;
- b) the designation of the product form (e.g. slab, bloom, billet, round bar, wire rod);
- c) either the designation of the dimensional standard and the dimensions and tolerances selected from this (see [7.9](#)) or the designation of the drawing or any other document covering the dimensions and tolerances required for the product;
- d) reference to this document, i.e. ISO 683-5;
- e) the designation of the steel grade given in [Table 3](#);
- f) designation for a test report 2.2 or, if required, any other type of inspection document in accordance with ISO 10474.

5.2 Options/supplementary or special requirements

A number of options are specified in this document and listed below in this subclause. If the purchaser does not indicate the wish to implement any of these options, the products will be supplied in accordance with the basic specification of this document (see [5.1](#)):

- a) if a heat-treatment condition other than the untreated condition is required, the symbol for this other condition (see [Table 1](#), column 2);
- b) if another surface condition than hot worked or a special surface quality is required, the surface condition (see [Table 2](#), column 2) and the surface quality (see [7.7](#));
- c) any supplementary requirement that shall be complied with, the symbol and, where necessary, the details of this supplementary requirement (see [Annex B](#));
- d) any requirement relating to the removal of surface defects (see [7.7.4](#));
- e) any requirement regarding the permissible depth of decarburization (see [7.8](#));
- f) impact test at a temperature lower than room temperature (see [9.2.3](#)).

5.3 Ordering example

EXAMPLE 2 t hot-rolled round bars according to ISO 1035-1 with a nominal diameter of 40 mm and a nominal length of 8 000 mm with diameter tolerance according to class S and with length tolerance according to class L2 made of steel grade ISO 683-5, 31CrMo12 (see [Table 3](#)) in heat-treatment condition +QT (see [Table 1](#)) with surface blast cleaned +BC (see [Table 2](#)) and with an inspection document 2.2.

Round bars ISO 1035 - 40,0S × 8 000L2

ISO 683-5 - 31CrMo12+QT

inspection document ISO 10474 2.2

6 Manufacturing process

6.1 General

The manufacturing process of the steel and of the products is with the restrictions given by the requirements in [6.2](#) and [6.4](#), left to the discretion of the manufacturer.

6.2 Deoxidization

All steels shall be deoxidized.

6.3 Heat treatment and surface condition at delivery

6.3.1 Normal condition at delivery

Unless otherwise agreed at the time of enquiry and order, the products shall be delivered in the untreated, i.e. hot-worked condition.

6.3.2 Particular heat-treatment condition

If so agreed at the time of enquiry and order, the products shall be delivered in one of the particular heat-treatment conditions given in [Table 1](#), lines 3 to 5.

6.3.3 Particular surface conditions

If so agreed at the time of enquiry and order, the products shall be delivered in another particular surface condition as given in [Table 2](#), lines 3 to 6.

6.4 Traceability of the cast

Each product shall be traceable to the cast (see [Clause 10](#)).

7 Requirements

7.1 Chemical composition, hardness and mechanical properties

7.1.1 General

[Table 1](#) shows the combinations of usual heat-treatment conditions at delivery, product forms and requirements as specified in [Tables 3](#) to [6](#).

7.1.2 Chemical composition

The chemical composition determined by cast analysis shall comply with the values in [Table 3](#). Permissible deviations between the limiting values for cast analysis and the values for product analysis are given in [Table 4](#).

The product analysis shall be carried out when specified at the time of enquiry and order (see [B.5](#)).

7.1.3 Mechanical properties

The requirements for the mechanical properties are for steels delivered in the “soft annealed condition” (+A) according to the maximum Brinell hardness (see [Table 5](#)) and for steels delivered in the “quenched and tempered condition” (+QT) according to the values cited in [Table 6](#).

7.2 Machinability

All steels are in the condition: “soft annealed” (+A) machinable.

Where a further improved machinability is required, special heat treatments may be agreed at the time of enquiry and order.

7.3 Cold shearability

Under suitable shearing conditions (avoiding local stress peaks, preheating, application of blades with a profile adapted to that of the product, etc.), all steels are shearable in the “soft annealed” (+A) condition.

7.4 Grain size

Unless otherwise agreed at the time of enquiry and order, the steel shall show a fine grain structure with an austenitic grain size of 5 and finer when tested in accordance with ISO 643. For verification, see [B.3](#).

The ferrite content in the core of the quenched and tempered product shall be determined on one microsection per cast, dimension and heat treatment batch, if agreed at the time of enquiry and order.

7.5 Non-metallic inclusions

7.5.1 Microscopic inclusions

The special steels shall have a certain degree of cleanness; however, verification of the non-metallic inclusion content requires a special agreement. If there is such an agreement at the time of enquiry and order, the microscopic non-metallic inclusion content shall be determined to an agreed procedure and within agreed limits in accordance with ISO 4967 or another standard, e.g. regional standards EN 10247 or JIS G 0555.

7.5.2 Macroscopic inclusions

This requirement is applicable to the verification of the macroscopic inclusions in special steels. If verification is agreed, the method and acceptance limits shall be agreed at the time of enquiry and order.

7.6 Internal soundness

The steels shall be free from internal defects likely to have an adverse effect (see [B.4](#)).

7.7 Surface quality

7.7.1 All products shall have a smooth surface finish appropriate to the manufacturing processes applied.

7.7.2 Minor surface imperfections which may occur under normal manufacturing conditions, such as prints originating from rolled-in scale, are not to be regarded as defects.

7.7.3 Bars and wire rod are delivered with surface class 1z2 in accordance with ISO 9443 and hot-rolled plates and wide flats shall be delivered with a surface in accordance with ISO 7788, unless otherwise agreed at the time of enquiry and order.

Where no International Standard on the surface quality of steel products exists, detailed requirements referring to this characteristic shall, where appropriate, be agreed at the time of enquiry and order.

It is more difficult to detect and eliminate surface discontinuities from coiled products than from cut lengths. This should be taken into account when agreements on surface quality are made.

NOTE Bars and wire rod for cold heading and cold extrusion are covered fully by ISO 4954.

7.7.4 The removal of surface defects by welding shall only be permitted with the approval of the customer or his/her representative.

If surface discontinuities are repaired, the method and maximum depth of removal shall be agreed at the time of enquiry and order.

7.8 Decarburization

Requirements relating to the permissible depth of decarburization may be agreed at the time of enquiry and order.

The depth of decarburization shall be determined in accordance with the micrographic method specified in ISO 3887.

7.9 Shape, dimensions and tolerances

The shape, dimensions and tolerances of the products shall comply with the requirements agreed at the time of enquiry and order. The agreements shall, as far as possible, be based on corresponding International Standards (see [Annex D](#)), otherwise on suitable national standards.

8 Inspection

8.1 Testing procedures and types of documents

8.1.1 Products complying with this document shall be ordered and delivered with one of the inspection documents as specified in ISO 10474. The type of document shall be agreed upon at the time of enquiry and order. If the order does not contain any specification of this type, a test report 2.2 shall be issued.

8.1.2 If, in accordance with the agreements made at the time of enquiry and order, a test report 2.2 is to be provided, this shall cover following information:

- a) confirmation that the material complies with the requirements of the order;
- b) results of the cast analysis for all elements specified in [Table 3](#) for the steel grade concerned.

8.1.3 If in accordance with the agreements in the order an inspection certificate [3.1](#) or [3.2](#) is to be provided, the specific inspections and tests described in [8.2](#), [8.3](#) and [Clause 9](#) shall be carried out and the results shall be confirmed in the inspection certificate.

In addition, the inspection certificate shall cover:

- a) confirmation that the material complies with the requirements of the order;

- b) results of the cast analysis for all elements specified in [Table 3](#) for the steel grade concerned;
- c) the result of all inspections and tests ordered by supplementary requirements (see [Annex B](#));
- d) the symbol letters or numbers relating the inspection certificate, test pieces and products to each other.

8.2 Frequency of testing

The amount of testing, the sampling conditions and the test methods to be applied for the verification of compliance with the requirements shall be in accordance with the prescriptions of [Table 8](#).

8.3 Specific inspection and testing

8.3.1 Verification of the hardness and mechanical properties

The hardness requirements and/or mechanical properties given for the relevant treatment condition in [Table 1](#), column 8, subcolumn 2, shall be verified, with the following exception. The requirements given in footnotes a to [Table 1](#) (mechanical properties of reference test pieces) shall only be verified if the supplementary requirement given in [B.2](#) is ordered.

8.3.2 Visual and dimensional inspection

A sufficient number of products shall be inspected to ensure compliance with the specification.

9 Test methods

9.1 Chemical analysis

The choice of a suitable physical or chemical analytical method for the analysis shall be at the discretion of the manufacturer. In cases of dispute, the method for product analysis used shall be agreed taking into account the relevant existing International Standards.

NOTE The list of available International Standards on chemical analysis is given in ISO/TR 9769.

9.2 Hardness and mechanical tests

9.2.1 Hardness

For products in the “soft annealed” condition (+A), the hardness shall be measured in accordance with ISO 6506-1.

9.2.2 Mechanical tests

For products in the “quenched and tempered” condition (+QT), the tensile test shall be carried out in accordance with ISO 6892-1.

For the specified yield strength in the tables of mechanical properties in this document, the upper yield strength, R_{eH} , shall be determined.

If a yield phenomenon is not present, the 0,2 % proof strength, $R_{p0,2}$, shall be determined.

9.2.3 Impact test

The impact test shall be carried out in accordance with ISO 148-1.

At the time of enquiry and order, additional requirements concerning the impact energy and the verification at temperatures other than room temperature (0 °C, -20 °C and -40 °C) can be agreed.

NOTE Impact values at lower temperatures cannot be achieved for all steel grades.

The average values of a set of three test pieces shall be equal to or greater than the specified value. One individual value may be below the specified value, provided it is not less than 70 % of that value.

If these conditions are not satisfied, additional tests can be done according to ISO 404:2013, 8.3.4.2.

9.3 Retests

Retests for steels for quenching and tempering and criteria are specified in ISO 404.

10 Marking

The manufacturer shall mark the products or the bundles or boxes containing the products in a suitable way, so that the identification of the cast, the steel type and the origin of the delivery is possible (see [B.7](#)).

Table 1 — Combination of usual heat-treatment conditions at delivery, product forms and requirements according to [Tables 3 to 6](#)

	1	2	3	4	5	6	7	8		9
1	Heat-treatment condition at delivery	Symbol	x = applicable for					Requirements		Remarks
			Semi-products	Bars	Wire rod	Plates	Hammer and drop forging	1	2	
2	Untreated	None or +U	x	x	x	x	x	Chemical composition according to Tables 3 and 4	— ^a	Observe also the supplementary requirements given in Annex B
3	Soft annealed	+A	x	x	x	x	x		Maximum Brinell hardness according to Table 5^a	
4	Quenched and tempered	+QT	—	x	—	x	x		Mechanical properties according to Table 6	
5	Others	Other treatment conditions, for example, special heat treatments for improving the machinability, may be agreed at the time of enquiry and order.								

^a For deliveries in the “untreated” or “soft annealed” condition, the values given in [Table 6](#) for the quenched and tempered condition shall be achievable after appropriate heat treatment if so agreed at the time of enquiry and order (for reference test pieces, see [B.2](#)).

Table 2 — Surface condition at delivery

	1	2	3	4	5	6	7	8	9	
1	Surface condition at delivery		Symbol	x = in general, applicable for					Hammer and drop forgings	Notes
				Semi-finished products	Bars	Wire rod	Plates			
2	Unless otherwise agreed	As hot worked	None or +HW	x ^a	x	x	x	x	—	
3	Particular conditions supplied by agreement	HW + pickled	+PI	x	x	x	x	x	— ^c	
4		HW + blast cleaned	+BC	x	x	x	x	x		
5		HW + rough machined	+RM ^b	—	x	x	—	x		
6		Others	—	—	x	x	x	x		
<p>^a The term “hot worked” also includes the continuously cast condition (+CC) in the case of the semi-finished products.</p> <p>^b Until the term “rough machined” is defined by, for example, machining allowance, the details shall be agreed at the time of enquiry and order.</p> <p>^c In addition, it may be agreed that the products are oiled or, where appropriate, limed or phosphated.</p>										

Table 3 — Steel grades and chemical composition (cast analysis)

Steel name	% mass fraction ^a									
	C	Si	Mn	P	S ^b	Cr	Mo	Ni	Al	Others
20CrMoV5-7	0,16 to 0,24	0,40	0,40 to 0,80	0,025	0,035	1,20 to 1,50	0,65 to 0,80	—	0,30	V: 0,25 to 0,35
34CrAl-Mo5-10	0,30 to 0,37	0,40	0,40 to 0,70	0,025	0,035	1,00 to 1,30	0,15 to 0,25	—	0,80 to 1,20	—
32CrAl-Mo7-10	0,28 to 0,35	0,40	0,40 to 0,70	0,025	0,035	1,50 to 1,80	0,20 to 0,40	—	0,80 to 1,20	—
41CrAl-Mo7-10	0,38 to 0,45	0,40	0,40 to 0,70	0,025	0,035	1,50 to 1,80	0,20 to 0,35	—	0,80 to 1,20	—
34CrAl-Ni7-10	0,30 to 0,37	0,40	0,40 to 0,70	0,025	0,035	1,50 to 1,80	0,15 to 0,25	0,85 to 1,15	0,80 to 1,20	—
31CrMoV9	0,27 to 0,34	0,40	0,40 to 0,70	0,025	0,035	2,30 to 2,70	0,15 to 0,25	—	—	V: 0,10 to 0,20
31CrMo12	0,28 to 0,35	0,40	0,40 to 0,70	0,025	0,035	2,80 to 3,30	0,30 to 0,50	0,30	—	—
33CrMoV12-9	0,29 to 0,36	0,40	0,40 to 0,70	0,025	0,035	2,80 to 3,30	0,70 to 1,00	—	—	V: 0,15 to 0,25
24CrMo13-6	0,20 to 0,27	0,40	0,40 to 0,70	0,025	0,035	3,00 to 3,50	0,50 to 0,70	—	—	—
40CrMoV13-9	0,36 to 0,43	0,40	0,40 to 0,70	0,025	0,035	3,00 to 3,50	0,80 to 1,10	—	—	V: 0,15 to 0,25
8CrMo16-5	0,04 to 0,12	0,40	0,85 to 1,20	0,025	0,035	3,70 to 4,30	0,40 to 0,60	—	—	Cu: 0,25
<p>Elements not quoted shall not be intentionally added to the steel without the agreement of the purchaser, other than for the purpose of finishing the heat. All reasonable precautions should be taken to prevent the addition, from scrap or other materials used in manufacture, of such elements which affect the mechanical properties and applicability.</p> <p>^a Maximum values unless otherwise indicated.</p> <p>^b By agreement between the purchaser and manufacturer, the steel may be ordered with an upper limit of sulfur less than 0,035 %.</p>										

Table 4 — Permissible deviations between the product analysis and the limiting values given in [Table 3](#) for the cast analysis

Element	Permissible maximum content according to cast analysis % mass fraction	Permissible deviation ^a % mass fraction
C	≤ 0,45	±0,02
Si	≤ 0,40	+0,03
Mn	≤ 1,20	±0,04
P	≤ 0,25	+0,005
S	≤ 0,035	+0,005
Cr	≥ 1,00 ≤ 2,00	±0,05
	≥ 2,00 ≤ 4,30	±0,10
Mo	≤ 0,30	±0,03
	> 0,30 ≤ 1,10	±0,04
Ni	≤ 1,15	±0,05
Al	≥ 0,80 ≤ 1,20	±0,10
Cu	≤ 0,25	+0,05
V	≤ 0,35	±0,02

^a “±” means that in one cast, the deviation may occur over the upper value or under the lower value of the specified range in [Table 3](#), but not both at the same time.

Table 5 — Hardness in the “soft annealed” condition

Steel name	Hardness HBW ^a max.
20CrMoV5-7	240
34CrAlMo5-10	248
32CrAlMo7-10	248
41CrAlMo7-10	248
34CrAlNi7-10	248
31CrMoV9	248
31CrMo12	248
33CrMoV12-9	248
24CrMo13-6	248
40CrMoV13-9	248
8CrMo16-5	220

^a HBW is Brinell hardness (conforming to ISO 6506-1).

Table 6 — Mechanical properties in the quenched and tempered condition (+QT)^a

Steel name	16 mm ≤ <i>d</i> ≤ 40 mm				40 mm < <i>d</i> ≤ 100 mm				100 mm < <i>d</i> ≤ 160 mm				160 mm < <i>d</i> ≤ 250 mm				<i>HV</i> ^b
	8 mm ≤ <i>t</i> ≤ 20 mm				20 mm ≤ <i>t</i> ≤ 60 mm				60 mm ≤ <i>t</i> ≤ 100 mm				100 mm ≤ <i>t</i> ≤ 160 mm				
	<i>R_e</i> MPa min.	<i>R_m</i> MPa	<i>A</i> % min.	<i>KV₂</i> J min.	<i>R_e</i> MPa min.	<i>R_m</i> MPa	<i>A</i> % min.	<i>KV₂</i> J min.	<i>R_e</i> MPa min.	<i>R_m</i> MPa	<i>A</i> % min.	<i>KV₂</i> J min.	<i>R_e</i> MPa min.	<i>R_m</i> MPa	<i>A</i> % min.	<i>KV₂</i> J min.	
20CrMoV5-7	800	900 to 1 100	14	35	800	900 to 1 100	14	35	800	900 to 1 100	14	35	—	—	—	—	850
34CrAlMo5-10	600	800 to 1 000	14	35	600	800 to 1 000	14	35	—	—	—	—	—	—	—	—	950
32CrAlMo7-10	750	950 to 1 150	11	25	720	900 to 1 100	13	25	670	850 to 1 050	14	30	625	800 to 1 000	15	30	950
41CrAlMo7-10	835	1 030 to 1 230	10	25	835	980 to 1 190	10	25	735	930 to 1 130	12	30	675	880 to 1 080	12	30	—
34CrAlNi7-10	680	900 to 1 100	10	30	650	850 to 1 050	12	30	600	800 to 1 000	13	35	600	800 to 1 000	13	35	950
31CrMoV9	900	1 100 to 1 300	9	25	800	1 000 to 1 200	10	30	700	900 to 1 100	11	35	650	850 to 1 050	12	40	800
31CrMo12	835	1 030 to 1 230	10	25	785	980 to 1 180	11	30	735	930 to 1 130	12	30	675	880 to 1 080	12	30	800
33CrMoV12-9	950	1 150 to 1 350	11	30	850	1 050 to 1 250	12	35	750	950 to 1 150	12	40	700	900 to 1 100	13	45	—
24CrMo13-6	800	1 000 to 1 200	10	25	750	950 to 1 150	11	30	700	900 to 1 100	12	30	650	850 to 1 050	13	30	—
40CrMoV13-9 ^c	750	950 to 1 150	11	25	720	900 to 1 100	13	25	700	870 to 1 070	14	30	625	800 to 1 000	15	30	—
8CrMo16-5 ^d	700	800 to 1 000	14	35	700	800 to 1 000	14	35	700	800 to 1 000	14	35	—	—	—	—	950

^a *R_e*: yield strength (0,2 % proof stress); *R_m*: tensile strength; *A*: Elongation after fracture; *KV₂*: impact strength with V-notch test pieces.

^b *HV* = hardness for nitrided surface. Values for information/guidance only. Actual surface hardness may vary with nitriding treatment and initial quenched and tempered condition.

^c Available for thicknesses *d* ≤ 70 mm.

^d Available for thicknesses *d* ≤ 120 mm.

Table 7 — Conditions for heat treatment (for guidance only)

Steel name	Soft annealing Temperature °C	Hardening		Tempering Temperature ^{b,c} °C	Nitriding ^d Temperature °C
		Temperature ^a °C	Quenching agent		
20CrMoV5-7	700 to 750	900 to 960	Water	690 to 710	—
34CrAlMo5-10	650 to 750	870 to 930	Oil or water	580 to 700	480 to 570
32CrAlMo7-10	650 to 750	870 to 930	Oil or water	580 to 700	480 to 570
41CrAlMo7-10	650 to 750	870 to 930	Oil or water	580 to 700	480 to 570
34CrAlNi7-10	650 to 700	870 to 930	Oil or water	580 to 700	480 to 570
31CrMoV9	680 to 720	870 to 930	Oil or water	580 to 700	480 to 570
31CrMo12	650 to 700	870 to 930	Oil or water	580 to 700	490 to 570
24CrMo13-6	650 to 700	870 to 970	Oil or water	580 to 700	480 to 570
40CrMoV13-9	680 to 720	870 to 970	Oil or water	580 to 700	480 to 570
8CrMo16-5	640 to 660	940 to 960	Water	620 to 660	—

NOTE The base composition and the heat treatment (quenching and tempering) prior to nitriding both have an influence on the results of nitriding treatment. The tempering temperature should not be less than 50 °C higher than the nitriding temperature. A difference of less than 50 °C should be the subject of a special agreement.

^a Time for austenitizing as a guide: 0,5 h minimum.

^b Time for tempering as a guide: 1 h minimum.

^c With very large sizes, the tempering temperature may be agreed at the time of enquiry and order.

^d Time for nitriding depends on the desired depth of the nitrided case.

Table 8 — Test conditions for the verification of the requirements given in column 1

	1		2	3	4	5	6
No.	Requirements	See Table	Test unit ^a	Number of sample products per test unit	Number of tests per sample product	Sampling	Test method
1	Chemical composition	3, 4	C	(The cast analysis is given by the manufacturer; for product analysis, see B.5.)			
2	Hardness in the condition +A	5	C + D + T	1	1	Hardness tests In case of dispute, the hardness shall be measured, if possible, at the circumference of the product in a distance of 1 × thickness from one end and in cases of products with square or rectangular cross-section in a distance of 0,25 × w, where w is the width of the product, from one longitudinal edge . If, for example, for hammer and drop forgings the above prescriptions prove unrealistic, a more appropriate position of the hardness indentations shall be agreed at the time of enquiry and order.	In accordance with ISO 6506-1
<p>NOTE Verification of the requirements is only necessary if an inspection certificate is ordered and if the requirement is applicable to Table 1, columns 8 and 9.</p> <p>^a The tests are to be carried out separately for each cast as indicated by “C”, each dimensions as indicated by “D”, and each heat treatment batch as indicated by “T”. Products with different thickness may be grouped if the thicknesses lie in the same dimension range for mechanical properties and if the differences in thickness do not affect the properties. In cases of doubt, the thinnest and the thickest product shall be tested.</p>							

Table 8 (continued)

	1		2	3	4	5	6
No.	Requirements		Test unit ^a	Number of sample products per test unit	Number of tests per sample product	Sampling	Test method
3	Mechanical properties of quenched and tempered products +QT	6	C + D + T	1	1 tensile and 3 ISO-V-notch impact tests	Tensile and impact tests, the test pieces for tensile tests and the test pieces for the ISO-V-notch shall be taken — for bars and wire rod in accordance with Figure 1 , and — for plates in accordance with Figure 2 and Table 9 . For hammer and drop forgings, the test pieces shall be taken with their longitudinal axis parallel to the direction of principal grain flow from a position to be agreed at the time of enquiry and order.	The tensile test shall be carried out in accordance with ISO 6892-1 on proportional test pieces having a gauge length of $L_0 = 5,65 \sqrt{s_0}$ where s_0 is the cross-section of the test piece. Where this is not possible, that means for flat products with thicknesses of about <3 mm, a test piece with constant gauge length in accordance with ISO 6892-1 shall be agreed at the time of enquiry and order. In this case also the minimum elongation value to be obtained for these test pieces shall be agreed. The impact test, where required, shall be carried out in accordance with ISO 148-1.

NOTE Verification of the requirements is only necessary if an inspection certificate is ordered and if the requirement is applicable to [Table 1](#), columns 8 and 9.

^a The tests are to be carried out separately for each cast as indicated by “C”, each dimensions as indicated by “D”, and each heat treatment batch as indicated by “T”. Products with different thickness may be grouped if the thicknesses lie in the same dimension range for mechanical properties and if the differences in thickness do not affect the properties. In cases of doubt, the thinnest and the thickest product shall be tested.

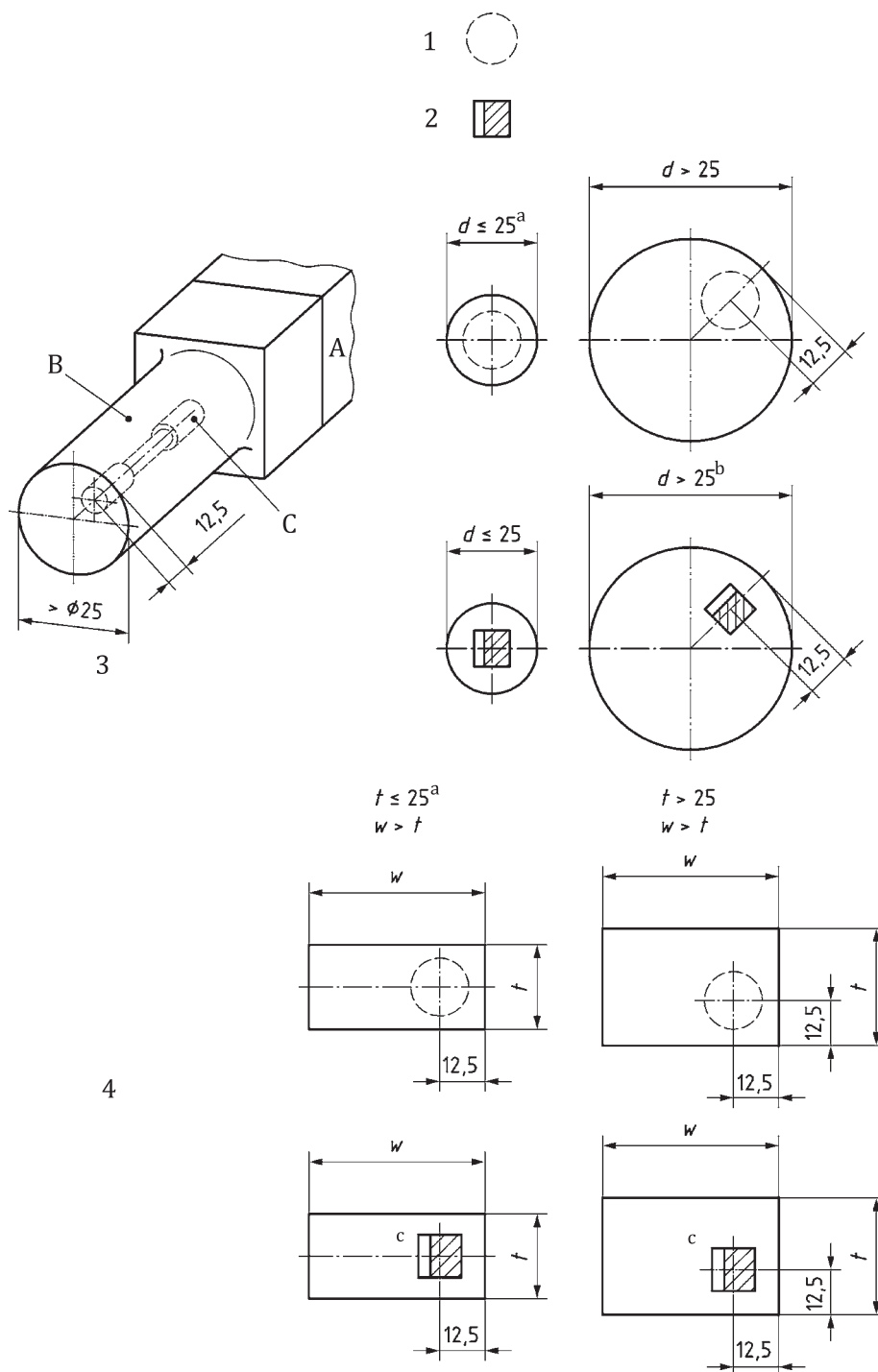

Key

- | | | | |
|---|-----------------------------------|---|------------|
| 1 | tensile test piece | A | sample |
| 2 | notched bar impact test piece | B | rough |
| 3 | round and similar shaped sections | C | test piece |

4 rectangular and square sections

a For small products (d or $w \leq 25$ mm), the test piece shall, if possible, consist of an un-machined part of the bar.

b For round bars, the longitudinal axis of the notch shall be about parallel to the direction of a diameter.

c For rectangular bars, the longitudinal axis of the notch shall be perpendicular to the wider rolling surface.

Figure 1 — Location of the test pieces in bars and wire rods

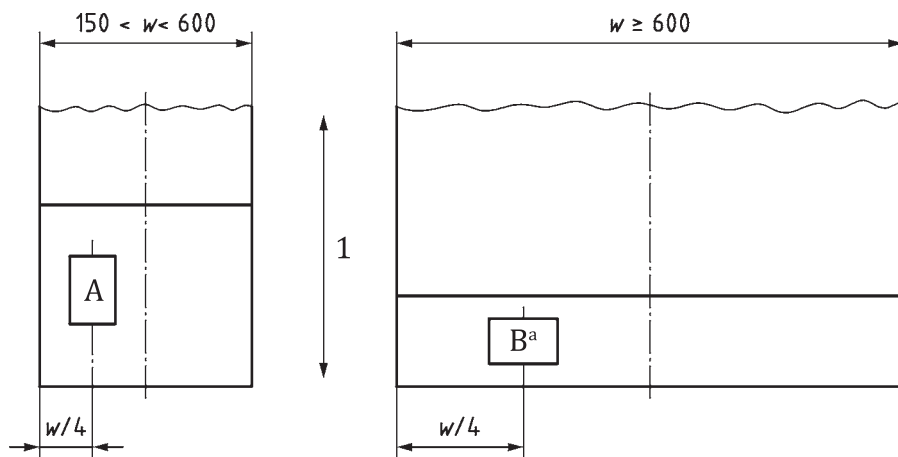

Key

- 1 principal direction of rolling
- a In the case of steel grades in the quenched and tempered condition with requirements for impact energy, the width of the sample shall be sufficient for longitudinal impact test pieces to be taken as specified in [Table 9](#).

NOTE In case of difficulty taking the test piece from $w/4$, take the sample from the position where the centre of it is getting as close as possible to $w/4$.

Figure 2 — Location of the samples (A and B) in flat products in relation to the product width

Table 9 — Location of the test piece from flat products in relation to product thickness and principal direction of rolling

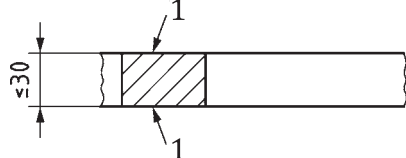
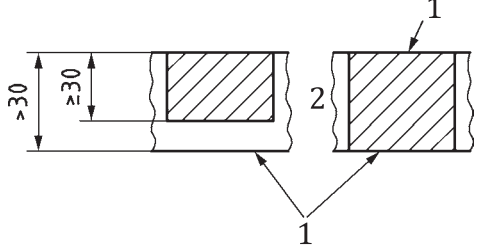
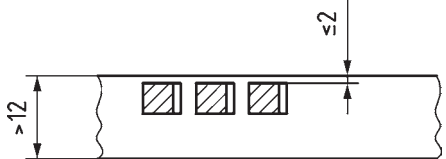
Type of test	Product thickness mm	Location of the test piece ^a for a product width of		Distance of the test piece from the rolled surface mm
		$w < 600$ mm	$w \geq 600$ mm	
Tensile test ^b	≤ 30	longitudinal	transverse	
	> 30			
Impact test ^c	$> 12^d$	longitudinal	longitudinal	
<p>^a Location of the longitudinal axis of the test piece with respect to the principal rolling direction.</p> <p>^b The test piece shall comply with ISO 6892-1.</p> <p>^c The longitudinal axis of the notch shall be perpendicular to the rolled surface.</p> <p>^d If agreed at the time of ordering, the test piece from products with a thickness exceeding 40 mm may be taken from 1/4 product thickness.</p> <p>1 rolled surface</p> <p>2 alternatives</p>				

Annex A (normative)

Ruling sections for mechanical properties

A.1 Definition

Ruling section is defined in [3.1](#).

A.2 Determination of the diameter of the equivalent ruling section

A.2.1 If the test pieces are taken from products with simple sections and from positions with quasi two-dimensional heat flow, [A.2.2](#) to [A.2.4](#) shall apply.

A.2.2 For rounds, the nominal diameter of the product (not comprising the machining allowance) shall be taken as the diameter of the ruling section.

A.2.3 For hexagons and octagons, the nominal distance between two opposite sides of the cross-section shall be taken as the diameter of the ruling section

A.2.4 For square and rectangular bars, the diameter of the ruling section shall be determined in accordance with the example shown in [Figure A.1](#)

Dimensions in millimetres

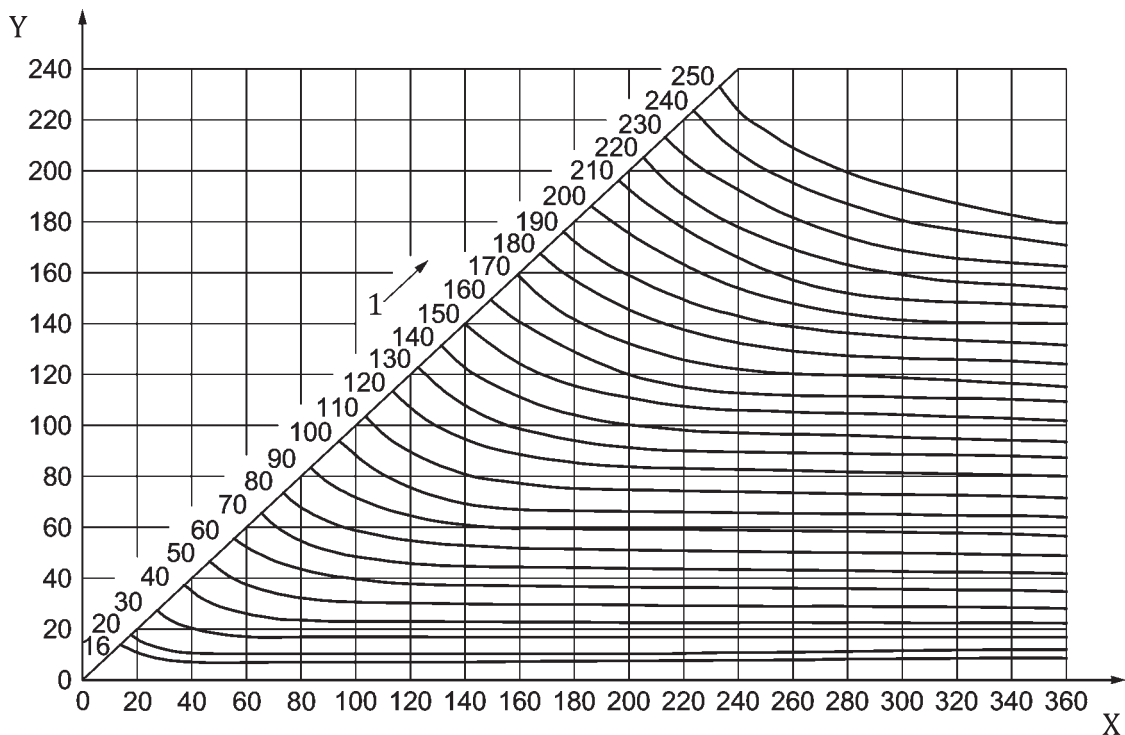

Key

- X width
- Y thickness
- 1 diameter of the ruling cross-section

EXAMPLE For a rectangular bar with a section of 40 mm × 60 mm, the diameter of the ruling section is 50 mm.

Figure A.1 — Diameter of the equivalent ruling section for square and rectangular sections for quenching in oil or water

A.2.5 For other product forms, the ruling section shall be agreed at the time of enquiry and order.

NOTE For this purpose, the following procedure can serve as a guideline. The product is hardened in accordance with usual practice. It is then cut so that the hardness and structure at the position of the ruling section provided for taking test pieces can be determined. From another product of the type under consideration and of the same cast, an end quench piece is taken from the prescribed position and tested in the usual way. Then, the distance is determined at which the end quench test piece shows the same hardness and structure as the ruling section at the position provided for taking test pieces. On the basis of this distance, the diameter of the ruling section is then estimated using [Figure A.2](#) and [Figure A.3](#).

Dimensions in millimetres

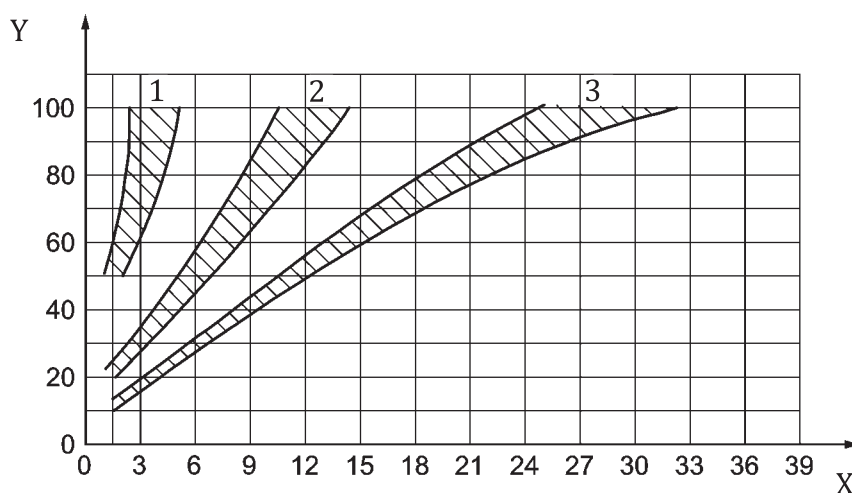

Key

- X distance from the quenched end
- Y bar diameter
- 1 surface
- 2 3/4 radius
- 3 centre

NOTE Source: Reference [16].

Figure A.2 — Relationship between the cooling rates in end quench test pieces (Jominy test pieces) and in quenched round bars in mildly agitated water

Dimensions in millimetres

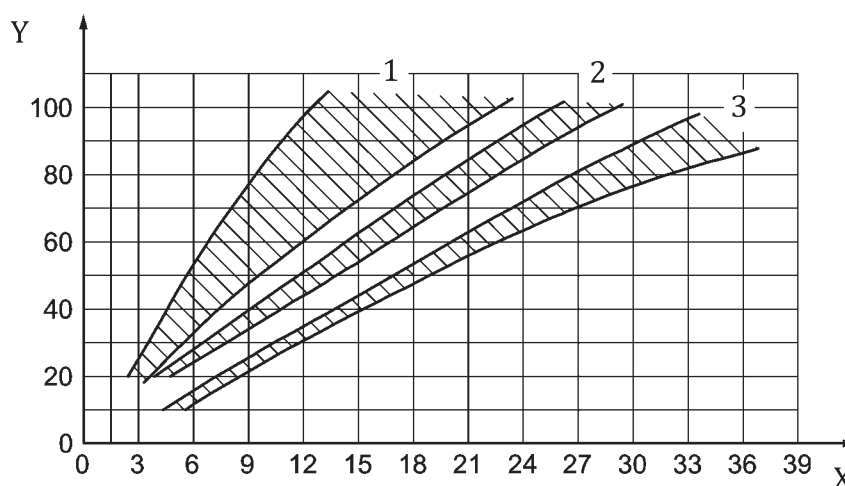

Key

- X distance from the quenched end
- Y bar diameter
- 1 surface
- 2 3/4 radius
- 3 centre

NOTE Source: Reference [16].

Figure A.3 — Relationship between the cooling rates in end quench test pieces (Jominy test pieces) and in quenched round bars in mildly agitated oil

Annex B (normative)

Supplementary or special requirements

B.1 General

One or more of the following supplementary or special requirements can be applied but only when specified in the enquiry and order. Details of these requirements shall, where necessary, be agreed upon by the manufacturer and purchaser at the time of enquiry and order.

B.2 Mechanical properties of reference test pieces in the quenched and tempered condition

For deliveries of steels for quenching and tempering, in a condition other than quenched and tempered, the requirements for the mechanical properties in the quenched and tempered condition (see [Table 6](#)) shall be verified on a reference test piece.

In the case of bars, wire rods and bright steel, the sample to be quenched and tempered shall, unless otherwise agreed, have the cross-section of the product. In all other cases, the dimensions and the manufacture of the sample shall be agreed at the time of enquiry and order where appropriate, taking into consideration the indications for the determination of the ruling section given in [Annex A](#). The samples shall be quenched and tempered in accordance with the conditions given in [Table 7](#) or as agreed at the time of enquiry and order. The details of the heat treatment shall be given in the inspection document. The test pieces shall, unless otherwise agreed, be taken in accordance with [Figure 1](#) for bars and rods and in accordance with [Figure 2](#) and [Table 9](#) for flat products.

B.3 Fine grain steel

The steel shall have an austenite grain size of 5 or finer. If specific testing is ordered, it shall also be agreed whether this grain size requirement is to be verified by determining the aluminium content or micrographically. In the case of determining the grain size by the Al content, the fine grain structure is normally achieved when the total aluminium content is a minimum of 0,007 %. For micrographical tests in accordance with ISO 643, information is given in ISO 683-2.

B.4 Non-destructive tests

The products shall be non-destructively tested under conditions and to an acceptance standard agreed at the time of enquiry and order (e.g. for flats ≥ 6 mm, see ISO 17577).

B.5 Product analysis

One product analysis shall be carried out per cast for the determination of all elements for which values are specified for the cast analysis of the steel type concerned.

The conditions for sampling shall be in accordance with ISO 14284. In cases of dispute, the analysis shall be carried out, if possible, in accordance with a reference method taken from one of the International Standards listed in ISO/TR 9769.

B.6 Reduction ratio and deformation ratio

If the central soundness of the hot-rolled or forged products is important, the purchaser shall be made aware that a minimum reduction ratio (referred to the cross-section) for long products or a minimum thickness deformation ratio (referred to the thickness) for flat products is necessary. In this case, a minimum reduction ratio or a minimum thickness deformation ratio of, for example, 4:1 may be agreed at the time of enquiry and order.

B.7 Special agreements for marking

The products shall be marked as agreed at the time of enquiry and order.

Annex C (informative)

Designation of steels given in this document and of comparable grades covered in various designation systems

Table C.1 — Designation of steels given in this document and of comparable grades covered in various designation systems

ISO name (ISO 683-5)	ISO number (ISO 683-5)	ASTM/ UNS ^b		EN 10085 Number ^c			JIS ^d		GB/T 3077 ^e	
			i/n/w ^f			i/n/ w ^f		i/n/ w ^f		i/n/w ^f
20CrMoV5-7	—	—	—	20CrMoV5-7	1.8503	i	—	—	—	—
34CrAlMo5-10	—	—	—	34CrAlMo5-10	1.8507	i	—	—	—	—
32CrAlMo7-10	—	—	—	32CrAlMo7-10	1.8505	i	—	—	—	—
41CrAlMo7-10	—	—	—	41CrAlMo7-10	1.8509	i	SACM645	n	38CrMoAl	n
34CrAlNi7-10	—	—	—	34CrAlNi7-10	1.8550	i	—	—	—	—
31CrMoV9	—	—	—	31CrMoV9	1.8519	i	—	—	—	—
31CrMo12	—	—	—	31CrMo12	1.8515	i	—	—	—	—
33CrMoV12-9	—	—	—	33CrMoV12-9	1.8522	i	—	—	—	—
24CrMo13-6	—	—	—	24CrMo13-6	1.8516	i	—	—	—	—
40CrMoV13-9	—	—	—	40CrMoV13-9	1.8523	i	—	—	—	—
8CrMo16-5	—	—	—	8CrMo16-5	1.8527	i	—	—	—	—

^a See sources in Bibliography.
^b US steel listed in ASTM and in UNS — if the steel number is given in brackets, then the steel has only a UNS number.
^c European steel listed in EN 10085 and in the “Stahl-Eisen-Liste” — if the steel number is given in brackets, then the steel is only listed in the “Stahl-Eisen-Liste”.
^d Japanese Industrial Standard.
^e Chinese National Standard.
^f i = identical steel to ISO-steel grade, n = steel grade with closer match of composition but not identical, w = wider match.

Annex D (informative)

Dimensional standards applicable to products complying with this document

- ISO 1035-1
- ISO 1035-2
- ISO 1035-3
- ISO 1035-4
- ISO 7452
- ISO 16124
- ISO 16160

Bibliography

- [1] ISO 683-2, *Heat-treatable steels, alloy steels and free-cutting steels -- Part 2: Alloy steels for quenching and tempering*
- [2] ISO 1035-1, *Hot-rolled steel bars — Part 1: Dimensions of round bars*
- [3] ISO 1035-2, *Hot-rolled steel bars — Part 2: Dimensions of square bars*
- [4] ISO 1035-3, *Hot-rolled steel bars — Part 3: Dimensions of flat bars*
- [5] ISO 1035-4, *Hot-rolled steel bars — Part 4: Tolerances*
- [6] ISO 4954, *Steels for cold heading and cold extruding*
- [7] ISO 6507-1, *Metallic materials — Vickers hardness test — Part 1: Test method*
- [8] ISO 7452, *Hot-rolled steel plates — Tolerances on dimensions and shape*
- [9] ISO 16124, *Steel wire rod — Dimensions and tolerances*
- [10] ISO 16160, *Hot-rolled steel sheet products — Dimensional and shape tolerances*
- [11] ISO 17577, *Steel — Ultrasonic testing of steel flat products of thickness equal to or greater than 6 mm*
- [12] GB/T 3077, *Alloy structural steels*
- [13] EN 10085, *Nitriding steels — Technical delivery conditions*
- [14] EN 10247, *Micrographic examination of the non-metallic inclusion content of steels using standard pictures*
- [15] JIS G 0555, *Microscopic testing method for the non-metallic inclusions in steel*
- [16] SAE J406c, *Methods of determining hardenability of steels*

British Standards Institution (BSI)

BSI is the national body responsible for preparing British Standards and other standards-related publications, information and services.

BSI is incorporated by Royal Charter. British Standards and other standardization products are published by BSI Standards Limited.

About us

We bring together business, industry, government, consumers, innovators and others to shape their combined experience and expertise into standards-based solutions.

The knowledge embodied in our standards has been carefully assembled in a dependable format and refined through our open consultation process. Organizations of all sizes and across all sectors choose standards to help them achieve their goals.

Information on standards

We can provide you with the knowledge that your organization needs to succeed. Find out more about British Standards by visiting our website at bsigroup.com/standards or contacting our Customer Services team or Knowledge Centre.

Buying standards

You can buy and download PDF versions of BSI publications, including British and adopted European and international standards, through our website at bsigroup.com/shop, where hard copies can also be purchased.

If you need international and foreign standards from other Standards Development Organizations, hard copies can be ordered from our Customer Services team.

Copyright in BSI publications

All the content in BSI publications, including British Standards, is the property of and copyrighted by BSI or some person or entity that owns copyright in the information used (such as the international standardization bodies) and has formally licensed such information to BSI for commercial publication and use.

Save for the provisions below, you may not transfer, share or disseminate any portion of the standard to any other person. You may not adapt, distribute, commercially exploit, or publicly display the standard or any portion thereof in any manner whatsoever without BSI's prior written consent.

Storing and using standards

Standards purchased in soft copy format:

- A British Standard purchased in soft copy format is licensed to a sole named user for personal or internal company use only.
- The standard may be stored on more than 1 device provided that it is accessible by the sole named user only and that only 1 copy is accessed at any one time.
- A single paper copy may be printed for personal or internal company use only.

Standards purchased in hard copy format:

- A British Standard purchased in hard copy format is for personal or internal company use only.
- It may not be further reproduced – in any format – to create an additional copy. This includes scanning of the document.

If you need more than 1 copy of the document, or if you wish to share the document on an internal network, you can save money by choosing a subscription product (see 'Subscriptions').

Reproducing extracts

For permission to reproduce content from BSI publications contact the BSI Copyright & Licensing team.

Subscriptions

Our range of subscription services are designed to make using standards easier for you. For further information on our subscription products go to bsigroup.com/subscriptions.

With **British Standards Online (BSOL)** you'll have instant access to over 55,000 British and adopted European and international standards from your desktop. It's available 24/7 and is refreshed daily so you'll always be up to date.

You can keep in touch with standards developments and receive substantial discounts on the purchase price of standards, both in single copy and subscription format, by becoming a **BSI Subscribing Member**.

PLUS is an updating service exclusive to BSI Subscribing Members. You will automatically receive the latest hard copy of your standards when they're revised or replaced.

To find out more about becoming a BSI Subscribing Member and the benefits of membership, please visit bsigroup.com/shop.

With a **Multi-User Network Licence (MUNL)** you are able to host standards publications on your intranet. Licences can cover as few or as many users as you wish. With updates supplied as soon as they're available, you can be sure your documentation is current. For further information, email subscriptions@bsigroup.com.

Revisions

Our British Standards and other publications are updated by amendment or revision.

We continually improve the quality of our products and services to benefit your business. If you find an inaccuracy or ambiguity within a British Standard or other BSI publication please inform the Knowledge Centre.

Useful Contacts

Customer Services

Tel: +44 345 086 9001

Email (orders): orders@bsigroup.com

Email (enquiries): cservices@bsigroup.com

Subscriptions

Tel: +44 345 086 9001

Email: subscriptions@bsigroup.com

Knowledge Centre

Tel: +44 20 8996 7004

Email: knowledgecentre@bsigroup.com

Copyright & Licensing

Tel: +44 20 8996 7070

Email: copyright@bsigroup.com

BSI Group Headquarters

389 Chiswick High Road London W4 4AL UK