



BSI Standards Publication

Function blocks (FB) for process control —

Part 2: Specification of FB concept and Electronic Device Description Language (EDDL)

NO COPYING WITHOUT BSI PERMISSION EXCEPT AS PERMITTED BY COPYRIGHT LAW

National foreword

This British Standard is the UK implementation of EN 61804-2:2007. It is identical to IEC 61804-2:2006. Together with BS EN 61804-3:2007, it supersedes BS EN 61804-2:2004 which is withdrawn.

The UK participation in its preparation was entrusted to Technical Committee AMT/7, Industrial communications: process measurement and control, including fieldbus.

A list of organizations represented on this committee can be obtained on request to its secretary.

This publication does not purport to include all the necessary provisions of a contract. Users are responsible for its correct application.

© BSI 2010

ISBN 978 0 580 70026 2

ICS 25.040.40; 35.240.50

Compliance with a British Standard cannot confer immunity from legal obligations.

This British Standard was published under the authority of the Standards Policy and Strategy Committee on 28 February 2010

Amendments issued since publication

Amd. No.	Date	Text affected
----------	------	---------------

English version

**Function blocks (FB) for process control -
Part 2: Specification of FB concept
(IEC 61804-2:2006)**

Blocs fonction
pour les processus industriels -
Partie 2: Spécification du concept
de bloc fonction
(CEI 61804-2:2006)

Funktionsbausteine
für die Prozessautomation -
Teil 2: Festlegung
des Funktionsbausteinkonzepts
(IEC 61804-2:2006)

This European Standard was approved by CENELEC on 2007-05-01. CENELEC members are bound to comply with the CEN/CENELEC Internal Regulations which stipulate the conditions for giving this European Standard the status of a national standard without any alteration.

Up-to-date lists and bibliographical references concerning such national standards may be obtained on application to the Central Secretariat or to any CENELEC member.

This European Standard exists in three official versions (English, French, German). A version in any other language made by translation under the responsibility of a CENELEC member into its own language and notified to the Central Secretariat has the same status as the official versions.

CENELEC members are the national electrotechnical committees of Austria, Belgium, Bulgaria, Cyprus, the Czech Republic, Denmark, Estonia, Finland, France, Germany, Greece, Hungary, Iceland, Ireland, Italy, Latvia, Lithuania, Luxembourg, Malta, the Netherlands, Norway, Poland, Portugal, Romania, Slovakia, Slovenia, Spain, Sweden, Switzerland and the United Kingdom.

CENELEC

European Committee for Electrotechnical Standardization
Comité Européen de Normalisation Electrotechnique
Europäisches Komitee für Elektrotechnische Normung

Central Secretariat: rue de Stassart 35, B - 1050 Brussels

Foreword

The text of the International Standard IEC 61804-2:2006, prepared by SC 65C, Industrial networks, of IEC TC 65, Industrial-process measurement and control, was submitted to the formal vote and was approved by CENELEC as EN 61804-2 on 2007-05-01 without any modification.

This European Standard, together with EN 61804-3:2007, supersedes EN 61804-2:2004.

EN 61804-2:2007 includes the following significant technical changes with respect to EN 61804-2:2004:

- transfer of the EDDL-specific clauses to EN 61804-3;
- the FB-specific subclauses 4.1 and 4.2 as well as Clauses 5, 6, 7 and 8 are unchanged.

The following dates were fixed:

- latest date by which the EN has to be implemented
at national level by publication of an identical
national standard or by endorsement (dop) 2008-05-01
- latest date by which the national standards conflicting
with the EN have to be withdrawn (dow) 2010-05-01

The International Electrotechnical Commission (IEC) and CENELEC draw attention to the fact that it is claimed that compliance with this document may involve the use of patents

U.S. Patent No. 5,333,114

U.S. Patent No. 5,485,400

U.S. Patent No. 5,825,664

U.S. Patent No. 5,909,368

U.S. Patent Pending No. 08/916,178

Australian Patent No. 638507

Canadian Patent No. 2,066,743

European Patent No. 0495001

Validated in:

UK – Patent No. 0495001

France – Patent No. 0495001

Germany – Patent No. 69032954.7

Netherlands – Patent No. 0495001

Japan Patent No. 3137643

The IEC and CENELEC take no position concerning the evidence, validity and scope of this patent right. The holder of this patent right has assured the IEC that he is willing to negotiate licenses under reasonable and non-discriminatory terms and conditions with applicants throughout the world. In this respect, the statement of the holder of this patent right is registered with IEC. Information may be obtained from:

Fieldbus Foundation,
9390 Research Boulevard, Suite II-250,
Austin, Texas, USA 78759,
Attention: President.

Attention is drawn to the possibility that some of the elements of this document may be the subject of patent rights other than those identified above. IEC and CENELEC shall not be held responsible for identifying any or all such patent rights.

Annex ZA has been added by CENELEC.

Endorsement notice

The text of the International Standard IEC 61804-2:2006 was approved by CENELEC as a European Standard without any modification.

Annex ZA (normative)

Normative references to international publications with their corresponding European publications

The following referenced documents are indispensable for the application of this document. For dated references, only the edition cited applies. For undated references, the latest edition of the referenced document (including any amendments) applies.

NOTE Where an International Publication has been modified by common modifications, indicated by (mod), the relevant EN/HD applies.

<u>Publication</u>	<u>Year</u>	<u>Title</u>	<u>EN/HD</u>	<u>Year</u>
IEC 60050-351	1998	International Electrotechnical Vocabulary (IEV) – Part 351: Automatic control	-	-
IEC 60584-1	- ¹⁾	Thermocouples – Part 1: Reference tables	EN 60584-1	1995 ²⁾
IEC 61131-3	2003	Programmable controllers – Part 3: Programming languages	EN 61131-3	2003
IEC 61158	Series	Digital data communications for measurement and control - Fieldbus for use in industrial control systems	EN 61158	Series
IEC 61499-1	2005	Function blocks – Part 1: Architecture	EN 61499-1	2005
IEC 61499-2	2005	Function blocks – Part 2: Software tools requirements	EN 61499-2	2005
IEC/TS 61804-1	2003	Function blocks (FB) for process control – Part 1: Overview of system aspects	-	-
ISO/IEC 7498-1	1994	Information technology - Open systems interconnection - Basic reference model – Part 1: The basic model	EN ISO/IEC 7498-1	1995
ISO/IEC 9899	- ¹⁾	Programming languages - C	-	-
ISO/IEC 10646-1	- ¹⁾	Information technology - Universal Multiple- Octet Coded Character Set (UCS) – Part 1: Architecture and Basic Multilingual Plane	-	-

¹⁾ Undated reference.

²⁾ Valid edition at date of issue.

CONTENTS

FOREWORD.....	4
INTRODUCTION.....	6
1 Scope.....	7
2 Normative references	7
3 Terms, definitions and abbreviated terms and acronyms.....	8
3.1 Terms and definitions	8
3.2 Abbreviated terms and acronyms	14
4 General Function Block (FB) definition and EDD model	14
4.1 Device structure (device model)	14
4.2 Block combinations	25
5 Detailed block definition	28
5.1 General	28
5.2 Application FBs	28
5.3 Component FBs	36
5.4 Technology Block	36
5.5 Device (Resource) Block	45
5.6 Algorithms common to all blocks	47
6 FB Environment.....	49
7 Mapping to System Management.....	49
8 Mapping to Communication	49
9 Conformance statement.....	51
Annex A (informative) Parameter description	52
Annex B (normative) IEC 61804 Conformance Declaration	58
Bibliography.....	59
Figure 1 – Position of the IEC 61804 series related to other standards and products	6
Figure 2 – FB structure is derived out of the process (P&ID view)	15
Figure 3 – FB structure may be distributed between devices.....	16
Figure 4 – IEC 61804 FBs can be implemented in different devices	17
Figure 5 – General components of devices	17
Figure 6 – Block types of IEC 61804	18
Figure 7 – IEC 61804 block overview (graphical representation not normative).....	19
Figure 8 – UML class diagram of the device model	22
Figure 9 – Measurement process signal flow.....	26
Figure 10 – Actuation process signal flow	26
Figure 11 – Application process signal flow.....	27
Figure 12 – Analog Input FB	28
Figure 13 – Analog Output FB.....	30
Figure 14 – Discrete input FB	31
Figure 15 – Discrete Output FB.....	32

Figure 16 – Calculation FB.....	34
Figure 17 – Control FB.....	35
Figure 18 – Temperature Technology Block.....	36
Figure 19 – Pressure Technology Block.....	39
Figure 20 – Modulating actuation technology block.....	41
Figure 21 – On/Off Actuation Technology Block.....	43
Figure 22 – Harel state chart.....	46
Figure 23 – Application structure of ISO OSI Reference Model.....	49
Figure 24 – Client/Server relationship in terms of OSI Reference Model.....	50
Figure 25 – Mapping of IEC 61804 FBs to APOs.....	50
Table 1 – References of model elements.....	21
Table 2 – Variables and parameter description template.....	24
Table 3 – Example of temperature sensors of Sensor_Type.....	37
Table 4 – Device status state table.....	45
Table 5 – Device status transition table.....	46
Table A.1 – Parameter description.....	52
Table B.1 – Conformance (sub)clause selection table.....	58
Table B.2 – Contents of (sub)clause selection tables.....	58

INTERNATIONAL ELECTROTECHNICAL COMMISSION

FUNCTION BLOCKS (FB) FOR PROCESS CONTROL –**Part 2: Specification of FB concept**

FOREWORD

- 1) The International Electrotechnical Commission (IEC) is a worldwide organization for standardization comprising all national electrotechnical committees (IEC National Committees). The object of IEC is to promote international co-operation on all questions concerning standardization in the electrical and electronic fields. To this end and in addition to other activities, IEC publishes International Standards, Technical Specifications, Technical Reports, Publicly Available Specifications (PAS) and Guides (hereafter referred to as "IEC Publication(s)"). Their preparation is entrusted to technical committees; any IEC National Committee interested in the subject dealt with may participate in this preparatory work. International, governmental and non-governmental organizations liaising with the IEC also participate in this preparation. IEC collaborates closely with the International Organization for Standardization (ISO) in accordance with conditions determined by agreement between the two organizations.
- 2) The formal decisions or agreements of IEC on technical matters express, as nearly as possible, an international consensus of opinion on the relevant subjects since each technical committee has representation from all interested IEC National Committees.
- 3) IEC Publications have the form of recommendations for international use and are accepted by IEC National Committees in that sense. While all reasonable efforts are made to ensure that the technical content of IEC Publications is accurate, IEC cannot be held responsible for the way in which they are used or for any misinterpretation by any end user.
- 4) In order to promote international uniformity, IEC National Committees undertake to apply IEC Publications transparently to the maximum extent possible in their national and regional publications. Any divergence between any IEC Publication and the corresponding national or regional publication shall be clearly indicated in the latter.
- 5) IEC provides no marking procedure to indicate its approval and cannot be rendered responsible for any equipment declared to be in conformity with an IEC Publication.
- 6) All users should ensure that they have the latest edition of this publication.
- 7) No liability shall attach to IEC or its directors, employees, servants or agents including individual experts and members of its technical committees and IEC National Committees for any personal injury, property damage or other damage of any nature whatsoever, whether direct or indirect, or for costs (including legal fees) and expenses arising out of the publication, use of, or reliance upon, this IEC Publication or any other IEC Publications.
- 8) Attention is drawn to the Normative references cited in this publication. Use of the referenced publications is indispensable for the correct application of this publication.

The International Electrotechnical Commission (IEC) draws attention to the fact that it is claimed that compliance with this document may involve the use of patents

U.S. Patent No. 5,333,114

U.S. Patent No. 5,485,400

U.S. Patent No. 5,825,664

U.S. Patent No. 5,909,368

U.S. Patent Pending No. 08/916,178

Australian Patent No. 638507

Canadian Patent No. 2,066,743

European Patent No. 0495001

Validated in:

UK – Patent No. 0495001

France – Patent No. 0495001

Germany – Patent No. 69032954.7

Netherlands – Patent No. 0495001

Japan Patent No. 3137643

IEC take no position concerning the evidence, validity and scope of this patent right. The holder of this patent right has assured the IEC that he is willing to negotiate licenses under reasonable and non-discriminatory terms and conditions with applicants throughout the world. In this respect, the statement of the holder of this patent right is registered with IEC. Information may be obtained from:

Fieldbus Foundation,
9390 Research Boulevard, Suite II-250,
Austin, Texas, USA 78759,
Attention: President.

Attention is drawn to the possibility that some of the elements of this document may be the subject of patent rights other than those identified above. IEC shall not be held responsible for identifying any or all such patent rights.

This International Standard has been prepared by subcommittee 65C: Digital communications, of IEC technical committee 65: Industrial-process measurement and control.

This second edition, together with the first edition of IEC 61804-3, cancels and replaces the first edition of IEC 61804-2 published in 2004. This edition constitutes a technical revision.

This edition includes the following significant technical changes with respect to the previous edition:

- a) transfer of the EDDL-specific clauses to IEC 61804-3;
- b) the FB-specific subclauses 4.1 and 4.2 as well as Clauses 5, 6, 7 and 8 are unchanged.

The text of this standard is based on the following documents:

CDV	Report on voting
65C/405/CDV	65C/420/RVC

Full information on the voting for the approval of this standard can be found in the report on voting indicated in the above table.

This publication has been drafted in accordance with ISO/IEC Directives, Part 2.

The list of all parts of the IEC 61804 series, under the general title *Function Blocks (FB) for process control*, can be found on the IEC website.

The committee has decided that the contents of this publication will remain unchanged until the maintenance result date indicated on the IEC web site under "<http://webstore.iec.ch>" in the data related to the specific publication. At this date, the publication will be

- reconfirmed;
- withdrawn;
- replaced by a revised edition, or
- amended.

A bilingual version of this publication may be issued at a later date.

INTRODUCTION

This part of IEC 61804 provides conceptual Function Block specifications, which can be mapped to specific communication systems, and their accompanying definitions by industrial groups.

The EDDL fills the gap between the conceptual FB specification of IEC 61804-2 and a product implementation. Figure 1 shows these aspects.

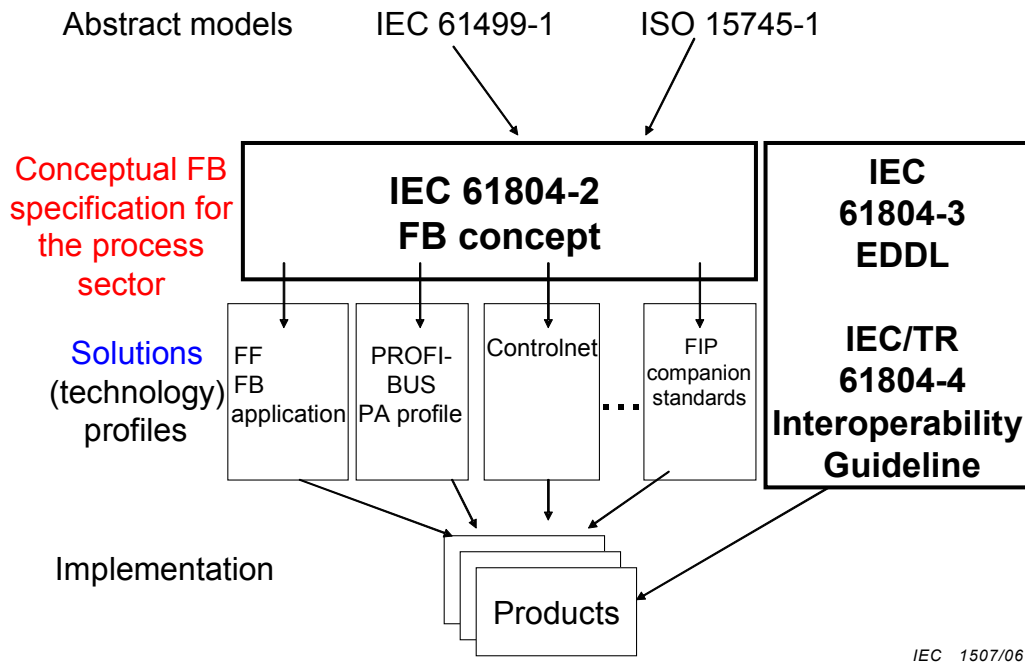

Figure 1 – Position of the IEC 61804 series related to other standards and products

FUNCTION BLOCKS (FB) FOR PROCESS CONTROL –

Part 2: Specification of FB concept

1 Scope

This part of IEC 61804 is applicable to Function Blocks (FB) for process control.

This standard specifies FB by using the result of harmonization work as regards several elements:

- c) the device model which defines the components of an IEC 61804-2 conformant device;
- d) conceptual specifications of FBs for measurement, actuation and processing. This includes general rules for the essential features to support control, whilst avoiding details which stop innovation as well as specialization for different industrial sectors.

This standard defines a subset of the requirements of IEC 61804-1 (hereafter referred to as Part 1) only, while Part 1 describes requirements for a distributed system.

The conformance statement in Annex B, which covers the conformance declaration, is related to this standard only. Requirements of Part 1 are not part of these conformance declarations.

The standardization work for FB was carried out by harmonizing the description of concepts of existing technologies. It results in an abstract level that allowed the definition of the common features in a unique way. This abstract vision is called here the conceptual FB specification and mapped to specific communication systems and their accompanying definitions by the industrial groups. This standard is also based on the abstract definitions of IEC 61499-1.

NOTE This standard can be mapped to ISO 15745-1.

There are solutions on the market today, which fulfil the requirements of this standard and show how the conceptual specification is implemented in a given technology. New technologies will need to find equivalent solutions (see Figure 4).

2 Normative references

The following referenced documents are indispensable for the application of this document. For dated references, only the edition cited applies. For undated references, the latest edition of the referenced document (including any amendments) applies.

IEC 60050-351:1998, *International Electrotechnical Vocabulary (IEV) – Part 351: Automatic control*

IEC 60584-1, *Thermocouples – Part 1: Reference tables*

IEC 61131-3:2003, *Programmable controllers – Part 3: Programming languages*

IEC 61158 (all parts), *Digital data communications for measurement and control – Fieldbus for use in industrial control systems*

IEC 61499-1:2005, *Function blocks – Part 1: Architecture*

IEC 61499-2:2005, *Function blocks – Part 2: Software tools requirements*

IEC 61804-1:2003, *Function blocks (FB) for process control – Part 1: Overview of system aspects*

ISO/IEC 7498-1:1994, *Information technology – Open Systems Interconnection – Basic Reference Model: The Basic Model*

ISO/IEC 9899, *Programming languages – C*

ISO/IEC 10646-1, *Information technology – Universal Multiple-Octet Coded Character Set (UCS) – Part 1: Architecture and Basic Multilingual Plane*

3 Terms, definitions, and abbreviated terms and acronyms

3.1 Terms and definitions

For the purposes of this document, the following terms and definitions, some of which have been compiled from the referenced documents, apply.

3.1.1

algorithm

finite set of well-defined rules for the solution of a problem in a finite number of operations

3.1.2

application

software functional unit that is specific to the solution of a problem in industrial-process measurement and control

NOTE An application may be distributed among resources and may communicate with other applications.

3.1.3

application function block

FB which has no input or output to the process

3.1.4

attribute

property or characteristic of an entity, for instance, the version identifier of an FB type specification

[IEC 61499-1]

NOTE The formal description of attributes is part of the solution profiles to achieve domain-specific interoperability. IEC 61804 defines the general rules to define the attributes and specifies the EDDL to describe attributes, which may be described in solution profiles.

3.1.5

component function block

FB instance which is used in the specification of an algorithm of a composite FB type

NOTE A component FB can be an FB or a composite FB type.

3.1.6

composite FB type

FB type whose algorithm is expressed entirely in terms of interconnected component FBs and variables

[IEC 61499-1]

3.1.7**configuration** (of a system or device)

step in system design: selecting functional units, assigning their locations and defining their interconnections

[IEC 61499-1]

3.1.8**data**

representation of facts, concepts or instructions in a formalized manner suitable for communication, interpretation or processing by human beings or by automatic means

[ISO/AFNOR Dictionary of Computer Science]

3.1.9**data connection**

association established between functional units for conveyance of data

[IEC 61499-1]

3.1.10**data input**

interface of an FB which receives data from a data connection

[IEC 61499-1]

3.1.11**data output**

interface of an FB, which supplies data to a data connection

[IEC 61499-1]

3.1.12**data type**

set of values together with a set of permitted operations

[ISO 2382 series]

3.1.13**device**

independent physical entity capable of performing one or more specified functions in a particular context and delimited by its interfaces

[IEC 61499-1]

3.1.14**device block**

FB which has no input and no output

3.1.15**device management application**

application whose primary function is the management of a multiple resources within a device

[IEC 61499-1]

3.1.16**Electronic Device Description Language (EDDL)**

methodology for describing parameter(s) of an automation system component

3.1.17**Electronic Device Description (EDD)**

data collection containing the device parameter(s), their dependencies, their graphical representation and a description of the data sets which are transferred.

NOTE The Electronic Device Description is created using the Electronic Device Description Language (EDDL).

3.1.18**entity**

particular thing, such as a person, place, process, object, concept, association, or event

[IEC 61499-1]

3.1.19**event**

instantaneous occurrence that is significant to scheduling the execution of an algorithm

[IEC 61499-1]

NOTE The execution of an algorithm may make use of variables associated with an event.

3.1.20**exception**

event that causes suspension of normal execution

[IEC 61499-1]

3.1.21**function**

specific purpose of an entity or its characteristic action

[IEC 61499-1]

3.1.22**functional unit**

entity of hardware or software, or both, capable of accomplishing a specified purpose

[ISO/AFNOR Dictionary of Computer Science]

3.1.23**function block (function block instance)**

software functional unit comprising an individual, named copy of a data structure and associated operations specified by a corresponding FB type

[IEC 61499-1]

NOTE Typical operations of an FB include modification of the values of the data in its associated data structure.

3.1.24**function block diagram**

network in which the nodes are function block instances, variables, literals, and events

NOTE This is not the same as the function block diagram defined in IEC 61131-3.

[IEC 61499-1]

3.1.25**hardware**

physical equipment, as opposed to programs, procedures, rules and associated documentation

[ISO/AFNOR Dictionary of Computer Science]

3.1.26**implementation**

development phase in which the hardware and software of a system become operational

[IEC 61499-1]

3.1.27**input variable**

variable whose value is supplied by a data input, and which may be used in one or more operations of an FB

NOTE An input parameter of an FB, as defined in IEC 61131-3, is an input variable.

[IEC 61499-1]

3.1.28**instance**

functional unit comprising an individual, named entity with the attributes of a defined type

[IEC 61499-1]

3.1.29**instance name**

identifier associated with, and designating, an instance

[IEC 61499-1]

3.1.30**instantiation**

creation of an instance of a specified type

[IEC 61499-1]

3.1.31**interface**

shared boundary between two functional units, defined by functional characteristics, signal characteristics, or other characteristics as appropriate

[IEV 351-11-19:1998]

3.1.32**internal variable**

variable whose value is used or modified by one or more operations of an FB but is not supplied by a data input or to a data output

[IEC 61499-1]

3.1.33**invocation**

process of initiating the execution of the sequence of operations specified in an algorithm

[IEC 61499-1]

3.1.34**management function block**

FB whose primary function is the management of applications within a resource

[IEC 61499-1]

3.1.35**mapping**

set of values having defined correspondence with the quantities or values of another set

[ISO/AFNOR Dictionary of Computer Science]

3.1.36**model**

representation of a real world process, device, or concept

[IEC 61499-1]

3.1.37**operation**

well-defined action that, when applied to any permissible combination of known entities, produces a new entity

[ISO/AFNOR Dictionary of Computer Science]

3.1.38**output variable**

variable whose value is established by one or more operations of a FB and is supplied to a data output

NOTE An output parameter of an FB, as defined in IEC 61131-3, is an output variable.

[IEC 61499-1]

3.1.39**parameter**

variable that is given a constant value for a specified application and that may denote the application

[ISO/AFNOR Dictionary of Computer Science]

3.1.40**resource**

functional unit contained within a device which has independent control of its operation and which provides various services to applications, including the scheduling and execution of algorithms

NOTE 1 The RESOURCE defined in IEC 61131-3 is a programming language element corresponding to the resource defined above.

NOTE 2 A device contains one or more resources.

3.1.41**resource management application**

application whose primary function is the management of a single resource

[IEC 61499-1]

3.1.42**service**

functional capability of a resource, which can be modelled by a sequence of service primitives

[IEC 61499-1]

3.1.43

software

intellectual creation comprising the programs, procedures, rules and any associated documentation pertaining to the operation of a system

[IEC 61499-1]

3.1.44

system

set of interrelated elements considered in a defined context as a whole and separated from its environment

[IEV 351-11-01:1998]

NOTE 1 Such elements may be both material objects and concepts as well as the results thereof (for example, forms of organization, mathematical methods, and programming languages).

NOTE 2 The system is considered to be separated from the environment and other external systems by an imaginary surface, which can cut the links between them and the considered system.

3.1.45

technology block

FB which has at least one input or one output to the process

3.1.46

text dictionary

collection of multilingual or other texts within the EDD

NOTE References within an EDD are used to select an appropriate text dictionary.

3.1.47

type

software element, which specifies the common attributes shared by all instances of the type

[IEC 61499-1]

3.1.48

type name

identifier associated with, and designating, a type

[IEC 61499-1]

3.1.49

variable

software entity that may take different values, one at a time

NOTE 1 The values of a variable are usually restricted to a certain data type.

NOTE 2 Variables are described as input variables, output variables, and internal variables.

[IEC 61499-1]

3.2 Abbreviated terms and acronyms

The terms in IEC 60050-351:1998 apply partially.

ADU	Analog Digital Unit
AFB	Application Function Block
ANSI	American National Standard Institut:
ANSI C	American National Standard Institute for the programming language C (see ISO/IEC 9899)
AP	Application Process
ASCII	American Standard Code for Information Interchange (see ISO/IEC 10646-1)
ASN.1	Abstract Lexical Structure Notation 1
BNF	Backus Naur Format
CFB	Component Function Block
DAU	Digital Analog Unit
EDD	Electronic Device Description
EDDL	Electronic Device Description Language
FB	Function Block
FBD	Function Block Diagram
FMS	Fieldbus Message Specification
HMI	Human Machine Interface
HTML	Hypertext Mark-up Language
I/O	Input/Output
IAM	Intelligent Actuation and Measurement
ID	Identifier
mA	Milliampere
NOAH	Network Oriented Application Harmonization
OSI	Open Systems Interconnection
P&ID	Piping and Instrument Diagram
PDU	Protocol Data Unit
SM	System Management
TB	Technology Block
UML	Unified Modelling Language
wao	Write as one

4 General Function Block (FB) definition and EDD model

4.1 Device structure (device model)

4.1.1 Device model description

FBs are encapsulations of variables and their processing algorithms. The variables and algorithms are those required by the design of the process and its control system.

NOTE FBs can be derived from the diagram in

Figure 2.

FBs perform the application (measurement, actuation, control and monitoring) by connecting their data inputs and data outputs.

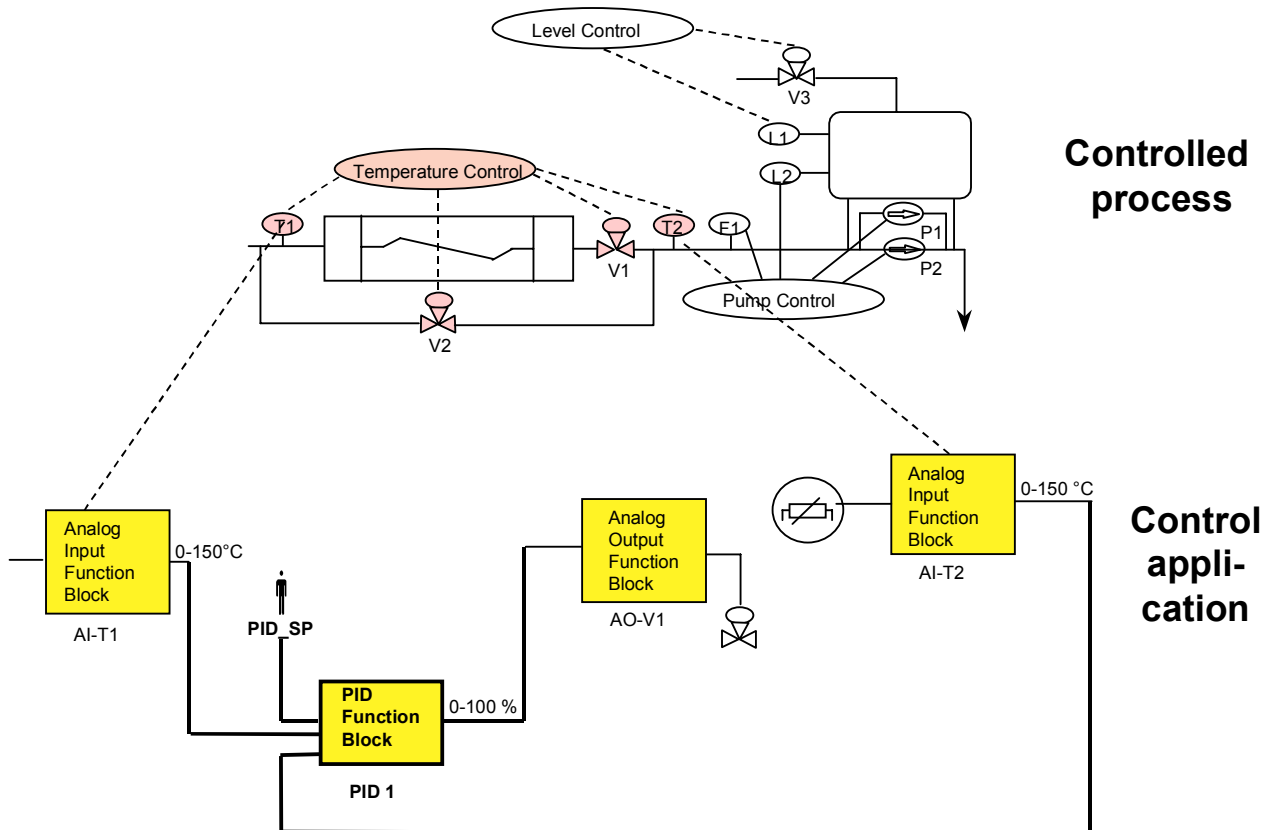

IEC 353/04

Figure 2 – FB structure is derived out of the process (P&ID view)

The devices are connected via a communication network or a hierarchy of communication networks.

NOTE The application may be distributed among several devices; see, for example, Figure 3. FB structure may be distributed between devices according to IEC 61499-1.

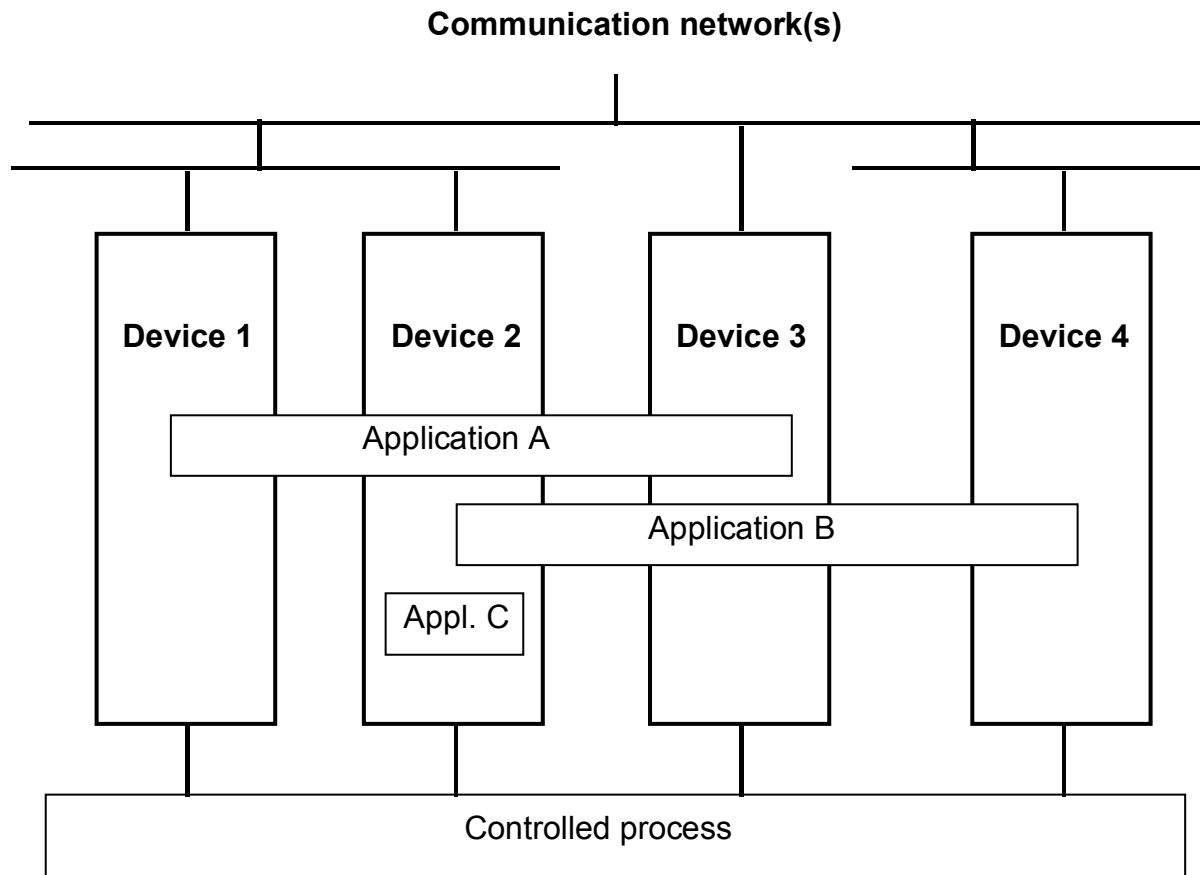

Figure 3 – FB structure may be distributed between devices

IEC 354/04

The FBs resulting from the design of the control system are abstract representations.

NOTE 1 These can be implemented in different ways in different device types (see Figure 4). FBs can be implemented, for example, in field devices, programmable logic controller, visualization stations and device descriptions.

Additionally, other applications such as system engineering and supervisory system have to handle or interact with the FBs.

NOTE 2 Algorithms defined for a FB in the conceptual model are not necessarily mapped one-to-one to the device; they can be mapped to the device, a proxy or a supervisory station if the current technology does not solve it in the device.

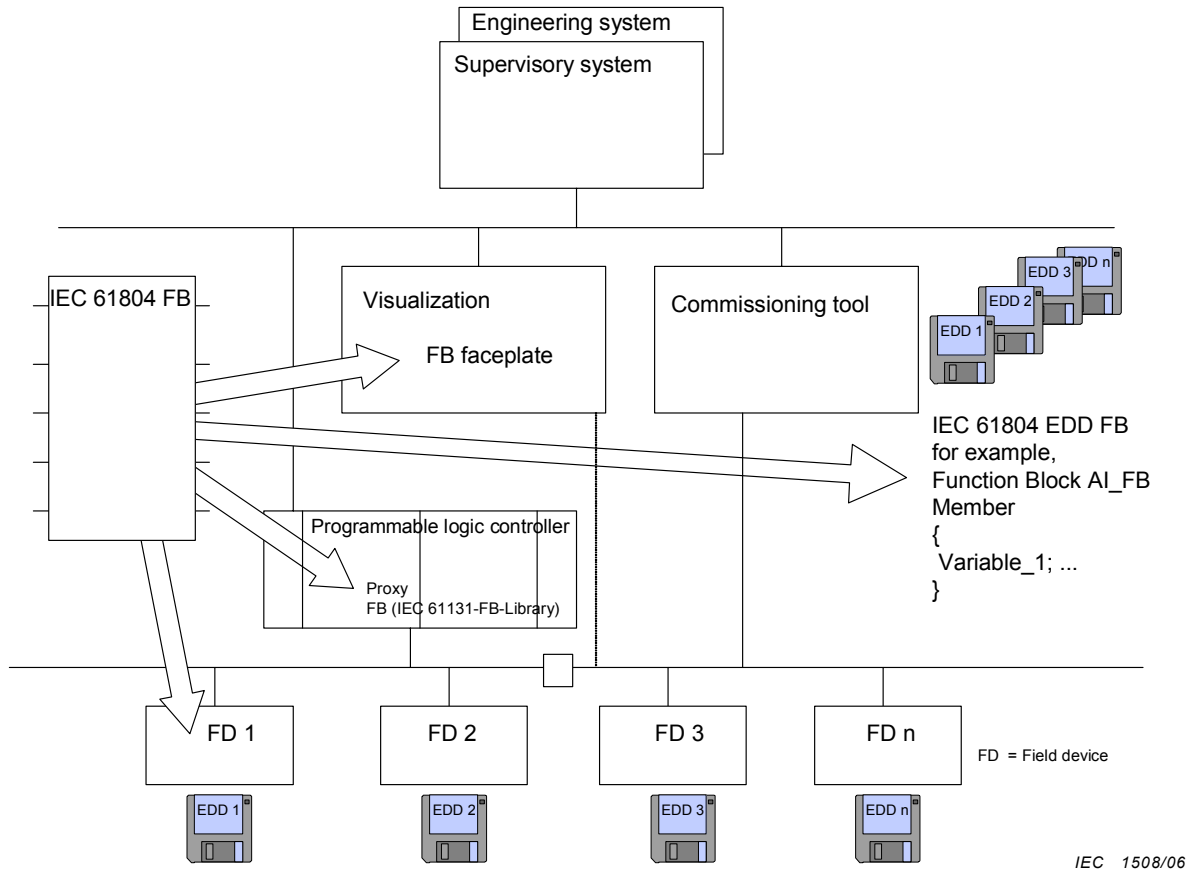

Figure 4 – IEC 61804 FBs can be implemented in different devices

For the purposes of this standard, devices implement algorithms derived out of the design of the controlled process in terms of FBs. The devices are hardware and software modular (see, for example, Figure 5). The components of devices are Modules, Blocks, Variables and Algorithms. There are defined relations between the components that are specified in the UML class diagram below (see Figure 8).

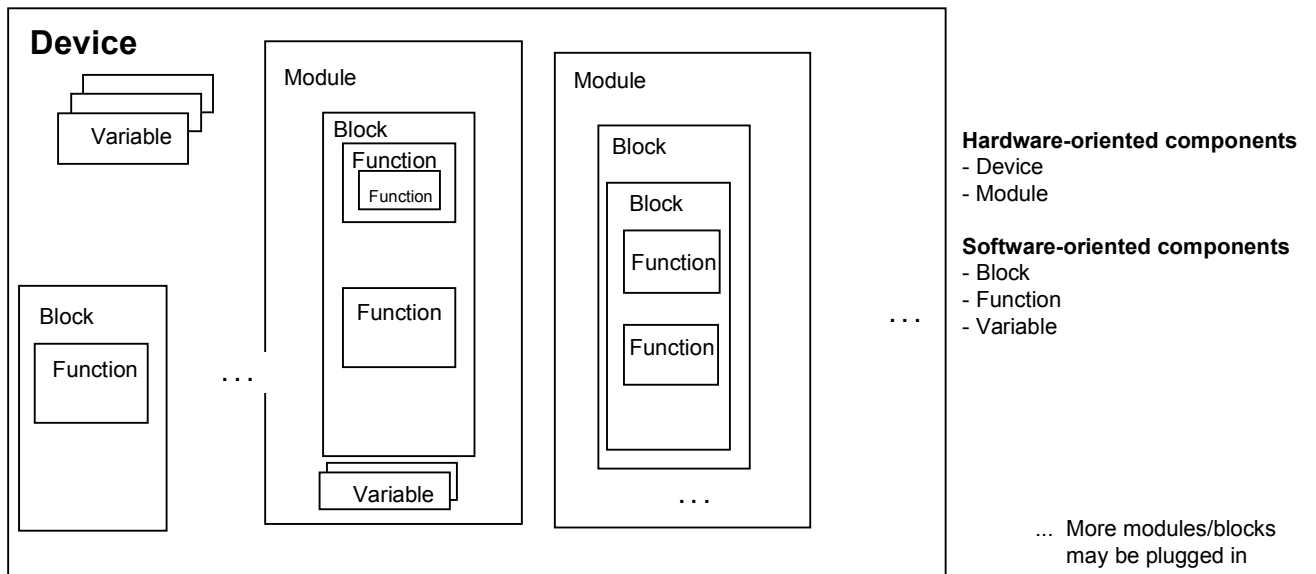

Figure 5 – General components of devices

For the purposes of this standard, there are different block types (see

Figure 6), which encapsulate specific functionality of devices performing an automation application. The Technology Block represents the process attachment of a device. It contains the measurement or actuation principles of a device. The technology block is composed of acquisition or output and transformation parts. The application FB (hereafter called FB) contains application-related signal processing, such as scaling, alarm detection or control and calculation. Component FBs may perform mathematical and logical processing with specific additional exception handling procedures such as not-allowed parameter values. They shall be encapsulated within composite FBs.

The Device Block represents the resource of the device that contains information and function about the device itself, the operation system of the device and the device hardware. The device shall have an interface to the communication system and may have system management functionalities.

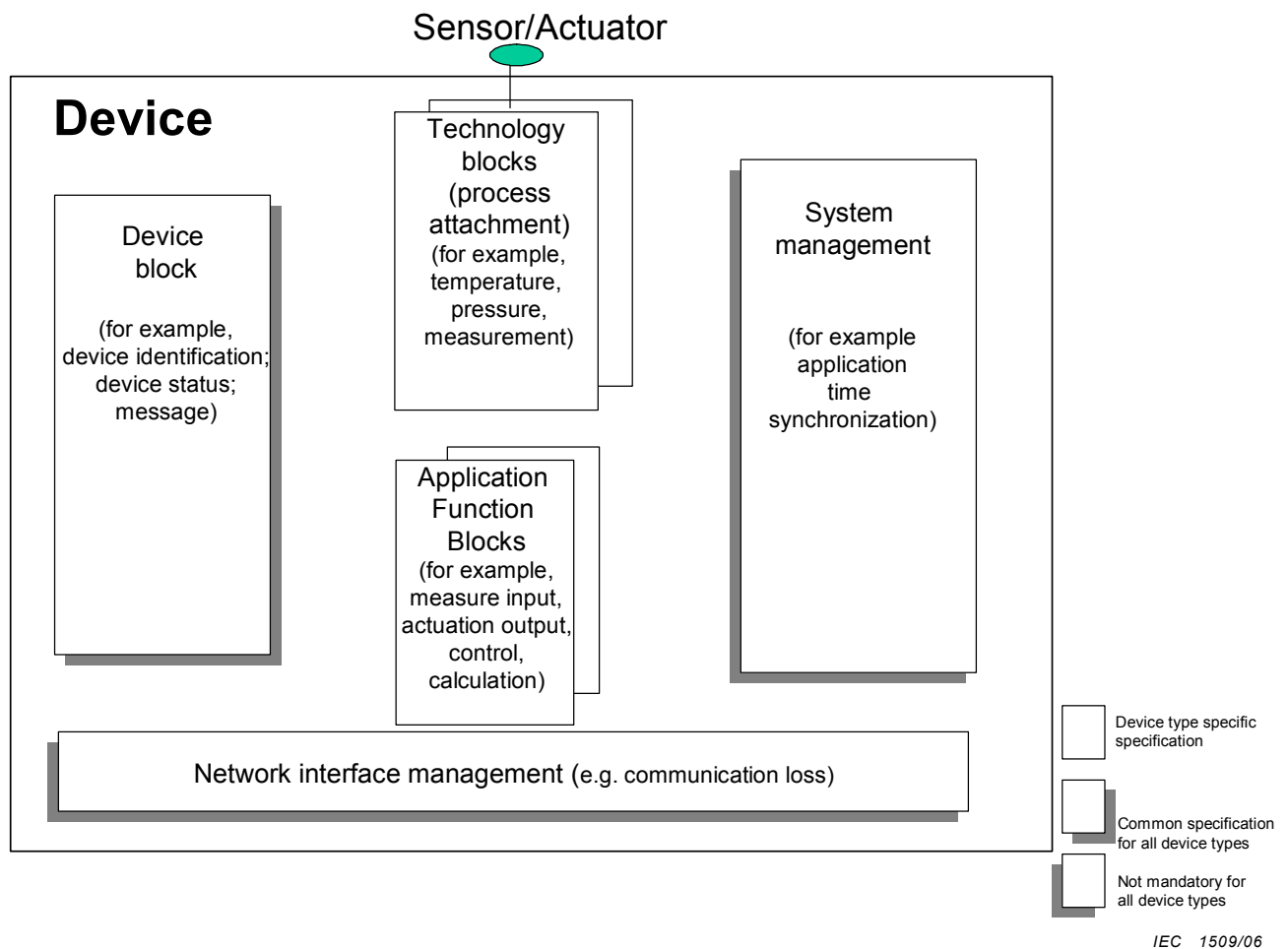

Figure 6 – Block types of IEC 61804

All devices within the scope of this standard shall have the same logical device structure (see

Figure 6). The number and types of blocks, which are instantiated in a device, are device- and manufacturer-specific. At least, it shall have one Device Block, one application FB and one network interface management.

There is a data flow chain from signal detection through the Technology Block and FBs and vice versa. The signals between the parts of the chain are internal within the blocks or visible

as linkages between blocks. The logical chain of technology and FB is called a channel. This concept is clarified in 4.2.1 and 4.2.2.

4.1.2 FB type

FBs are functional units in software, which encapsulate variables and algorithms. A FB type is defined by its behaviour. One FB contains one or more than one algorithm. The description of an FB is a list of algorithms, which are encapsulated in the FB together with the related data inputs and data outputs and parameters. There are algorithms, which are related to the process signal flow and those, which are related to other block specific algorithms. These other algorithms are called management. Parameters are related to process signal flow and management.

Graphical representation is not normative (see Figure 7). In other words, the data inputs and data outputs represents the intention of the process signal flow (conceptual definition) not the specific data that carry the according values.

The parameter table specifies all the necessary accessible data inputs, data outputs and parameters of the FB.

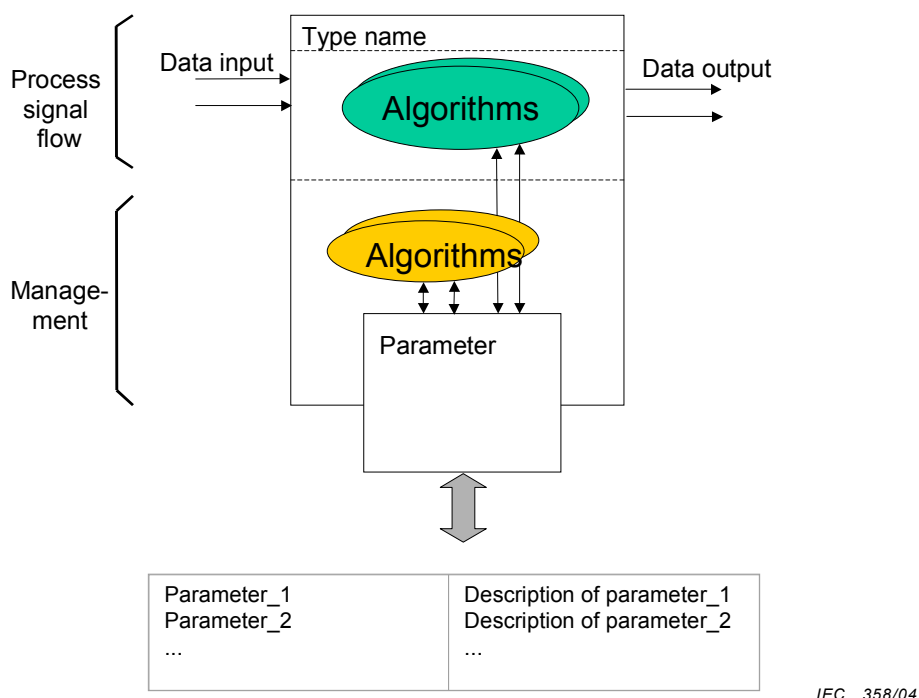

Figure 7 – IEC 61804 block overview (graphical representation not normative)

The FB is summarized by the following components:

- a) data Inputs² which support status² and are related to the process signal flow only;
- b) data Outputs² which support status² and are related to the process signal flow only;
- c) parameters² related to the process signal flow and management;
- d) maintain values to influence functions;
- e) notify and make visible internal behaviour;
- f) selection of functions in the signal flow;

- g) internal variables with memory for support of for example initialization;
- h) mathematical/logical algorithm.

The influence of the FB behaviour is possible by data inputs and parameters only. The data inputs and parameters are used in the following ways:

- a) data, which are used as inputs or outputs of functions (for example, setpoint for scaling functions);
- b) data, which are used as parameter of functions (for example, limits for alarms and warnings);
- c) changes of parameter data are interpreted as events which switch transitions of state automata (for example, start, stop, resume of operation modus of devices);
- d) changes of parameter data are interpreted as events, which start transactions of sequences of algorithms (for example, start of calibration procedures).

The data name and their description shall be checked to understand the purpose of the data.

4.1.3 FB execution

Execution control of FB algorithms is a feature of each device. Different execution policies are allowed.

NOTE For example, combinations of the following execution control methods are possible and others may be added:

- a) free running;
- b) device internal time schedule (time synchronization), for example, 2.7.2 of IEC 61131-3;
- c) device internal event triggered;
- d) parameter data changes are interpreted as events (see 4.1.2);
- e) system wide time synchronization (time synchronization across the communication system);
- f) communication service triggered;
- g) system wide event triggered (for example, IEC 61499-1);
- h) distributed execution control;
- i) device internal time schedule (time synchronization).

The FB execution control within a device is only one aspect of the overall application execution control. The overall execution control is determined, for example (see 3.10 of IEC/TR 61131-8), by:

- a) Sequence order (sequential or parallel):
 - 1) Execution order of blocks along the signal flow
 - 2) Piping of data in parallel execution
 - 3) Handling of loss of communication between devices
- b) Synchronization:
 - 1) Time synchronization between device
 - 2) Use of time in scheduling
- c) Time constraints; the following elements are covered:
 - 1) Block execution time
 - 2) Communication time delay
 - 3) Scan rate of measurement
 - 4) Actuation time
 - 5) Choice of block algorithms
 - 6) Time delay resulting from communication behaviour
- d) Block execution time:
 - 1) Communication time delay
 - 2) Scan rate of measurement
 - 3) Actuation time
 - 4) Choice of block algorithms

e) Impact of exception handling:

- 1) Clock error
- 2) Device error
- 3) Communication error

The decision as to which technology fulfils the requirements should be based on a detailed check of at least all these aspects. The choice of execution control method also depends on the technology level used to build the devices. So the method of FB execution control is also constrained to those available in the fieldbus used by the system.

4.1.4 Reference between IEC 61499-1, IEC 61499-2 and IEC 61804 models

The relations to IEC 61499-1 and IEC 61499-2 are given in Table 1.

Table 1 – References of model elements

IEC 61804 model element	IEC 61499-1 model element
Reference of block types	
Application FB	Application FB
Technology Block	Technology Block
Device (Resource) Block	Device (Resource) Block
Reference of FB elements	
Component Block	Component Block
Type Name	Type Name
Data Input ^a	Data Input ^a
Data Output ^a	Data Output ^a
Algorithms	Algorithms
Parameter	Parameter
Internal Variable	Internal Variable
Principle relations between EDDL elements and IEC 61499-2 transfer syntax elements^b	
BLOCK_A, BLOCK_B	FUNCTION BLOCK
VARIABLE and CLASS INPUT	VAR_INPUT, END_VAR
VARIABLE and CLASS OUTPUT	VAR_OUTPUT, END_VAR
– ^c	ALGORITHM
VARIABLE and CLASS CONTAINED	–
VARIABLE	VAR, END_VAR
^a The data inputs and data outputs represent the source and sink points for the process signal flow (conceptual definition) not the specific variables, which carry the according data. ^b This is not an exact syntax reference. It is intended to show the general relations. ^c Describing algorithms are not the intention of EDDL.	

An IEC 61804 FB is an IEC 61499-1 FB without execution control and, therefore, has no event inputs and event outputs. The execution control of the IEC 61804 FBs algorithms are hidden (see 4.1.3).

4.1.5 UML specification of the device model

The device model definitions in 4.1.1, in Figure 5 and

Figure 6 are general. To solve the ambiguity, the model is described as a UML class diagram (see Bibliography). The components are transformed to the UML language elements in Figure 8.

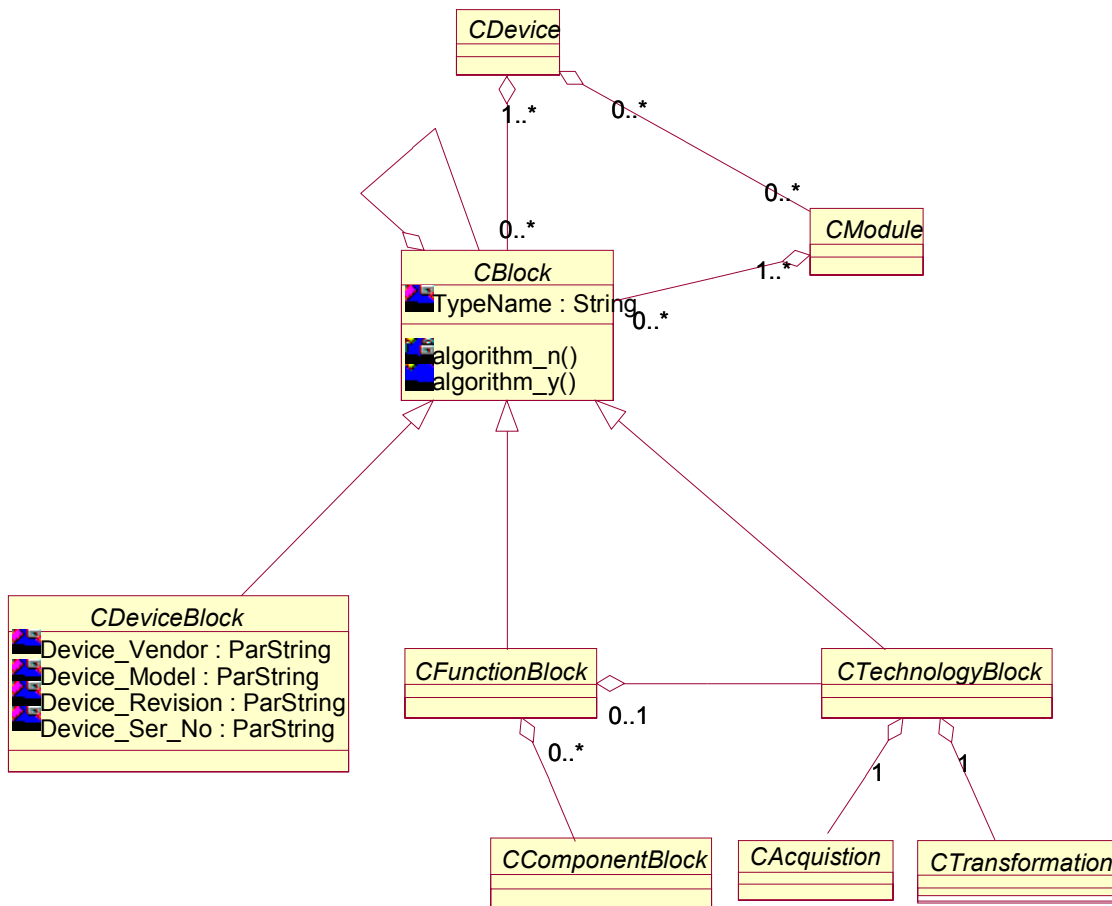

IEC 359/04

Figure 8 – UML class diagram of the device model

The following major steps are used to convert the device model into a UML class diagram:

- the device becomes the class CDevice;
- the module becomes the class CModule;
- the Device Block, FB, Component FB and Technology Block become CDeviceBlock, CFunctionBlock, CComponentFunctionBlock and CTechnologyBlock;
- the block types are of the type Block which becomes CBlock;
- a device contains a minimum of one block;
- a device may contain modules;
- a module contains a minimum of one block;
- blocks can be composed out of other blocks, i.e. may be of composite FB type;
- a block contains a minimum of zero or more parameters;
- a block shall have algorithms which can be internal only or visible from the outside (i.e. private or public);
- a Device Block contains the attribute Device_Vendor, Device_Model, Device_Revision and Device_Ser_No which are parameters;
- the FB, Component FB and Technology Block contain the attribute TypeName.

NOTE The CBlock class can be referenced to the Basic FB Type Declaration of the IEC 61499-1 (see Figure C.1.4). The IEC 61804 block type has no aggregation to the ECCDeclaration class.

4.1.6 Classification of the algorithms

The following list provides common algorithms for use in application FBs, transducer blocks and device blocks.

- a) Process signal algorithms
 - 1) Measurement acquisition
 - i) Sensor connection
 - ii) Sensor range/calibration
 - iii) AD conversion
 - iv) Status estimation
 - 2) Measurement transformation
 - i) Linearization
 - ii) Filtering
 - iii) Compensation
 - iv) Scaling
 - 3) Measurement application
 - i) Limit
 - ii) Unit
 - iii) Scaling
 - iv) Linearization
 - v) Simulation
 - 4) Actuation provision
 - i) Amplification
 - ii) Conversion
 - iii) Status estimation
 - 5) Actuation acquisition
See measurement acquisition for readback of actuator output value
 - 6) Actuation transformation
 - i) Scaling
 - ii) Compensation
 - iii) Transition or activity limits
 - 7) Actuation application
 - i) Limit
 - ii) Unit
 - iii) Scaling
 - iv) Linearization
 - v) Simulation
- b) Management
 - 1) Estimation of Device Status
 - 2) Test
 - 3) Diagnosis
 - 4) Operating Mode

4.1.7 Algorithm description

The algorithm description is made individually for each algorithm in the appropriate language, for example, plain English, Harel State Diagram or one of the IEC 61131-3 languages (for example FBD (FB diagram) or IEC 61131 ST (structured text)).

The object of the profile description is to define a general set of rules allowing identification of a device together with classification and specification of the algorithms supported by the device.

4.1.8 Input and output variables and parameter definition

For the description of the block parameters, Table 2 shall be used. This table provides a template for describing the interface to a block. It is comparable with a data dictionary or a database.

Table 2 – Variables and parameter description template

Parameter name	Description	Data type	User access read/write	Class m/o/c
Block class				

Parameter name:

Identifier of the variable/parameters that are accessed within the FB. The name is valid within this specification but not normative for products on the market. The decision if a data is an input, output or parameter is application-dependent.

Description:

Informative text, describing the purpose of the variable/parameter.

Data type:

The following data types are conceptual ones, i.e. they identify the signal type not the implementable data type. These will be mapped by technology profile to supported data in the following categories:

- a) numeric (for example, float, real, long real, integer);
- b) enumerated;
- c) boolean;
- d) string (for example, visible string, octet string);
- e) array;
- f) structure.

User access read/write

This specifies that the variable/parameter is changeable by a remote device or not.

Class m/o/c

This specifies if the variable/parameter shall be supported within the block or not; the states are: mandatory (m), optional (o), conditional (c).

Additional parameter attributes that shall be specified when mapping IEC 61804 blocks to other FB specifications are:

- a) class of recovery after power fails shall have the value N or D as follows:
 - N indicates a non-volatile parameter which shall be remembered through a power cycle but which is not under the static update code;
 - D indicates a dynamic parameter that is calculated by the process, the block or read from another block.
- b) default value
indicates the value is assigned to a parameter in the initialization process for an unconfigured block.

4.1.9 Choice of variables and parameters

The block variables, parameters and algorithms included in a block will be those that are significant for the algorithm and device. As a minimum, FBs will include the variables and parameters defined in the P&ID. The names of parameters and variables are not normative.

4.1.10 Mode, status and diagnosis

These parameters manage and indicate channel performance. They can be reported; however, the report mechanisms are technology-dependent. Reported values may also include additional items, such as time stamps, priorities, indication of possible reasons, etc.

Mode describes the operation state of a channel or FB and influences the signal flow within the channel. Examples of modes are manual, automatic, local override, out of service.

Status is a characteristic aspect of a channel which may accompany information transferred within the channel, i.e. FB data inputs and data outputs.

Device state describes the operational state of a device and interacts with the device technology and application blocks; it is maintained within a device by the device block.

Diagnosis is a report available from algorithms which assess channel or device internal performance. The results of these internal assessments may be used to construct generic measurement, control and actuation status information.

4.2 Block combinations

4.2.1 Measurement channel

The technology and application FBs provide a functional chain along which the process signals flow. Together they comprise a measurement channel (see Figure 9) or an actuation channel (see Figure 10).

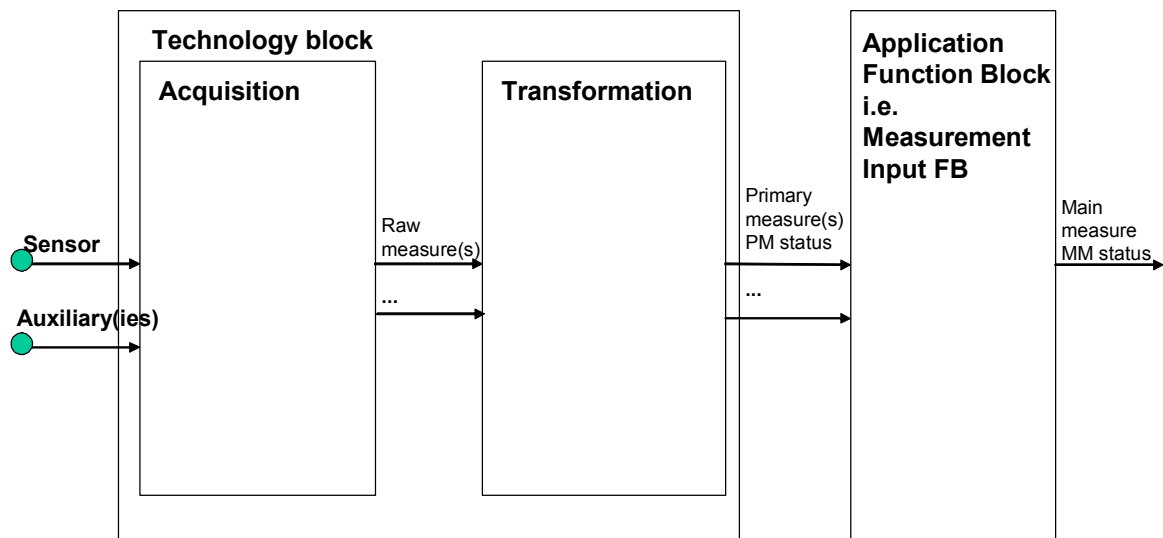

IEC 1510/06

Figure 9 – Measurement process signal flow

A measurement may be accompanied by optional additional auxiliary measurements, for purposes such as compensation. The technology block provides a primary measured value and its accompanying status. Additionally, the technology block may provide other outputs – for example, diagnosis or validation information.

NOTE Additional sensor inputs may also be used and transferred by a technology block.

The application FB uses the outputs of the technology block and other internal data to generate the main measure and its accompanied status. The status is accomplished by every function in the signal flow starting with the sensor(s) until the last function in the application FB. Information from one technology block is offered to more than one application FB. A measurement channel shall consist of at least one application FB. Channels without a technology block are possible.

4.2.2 Actuation channel

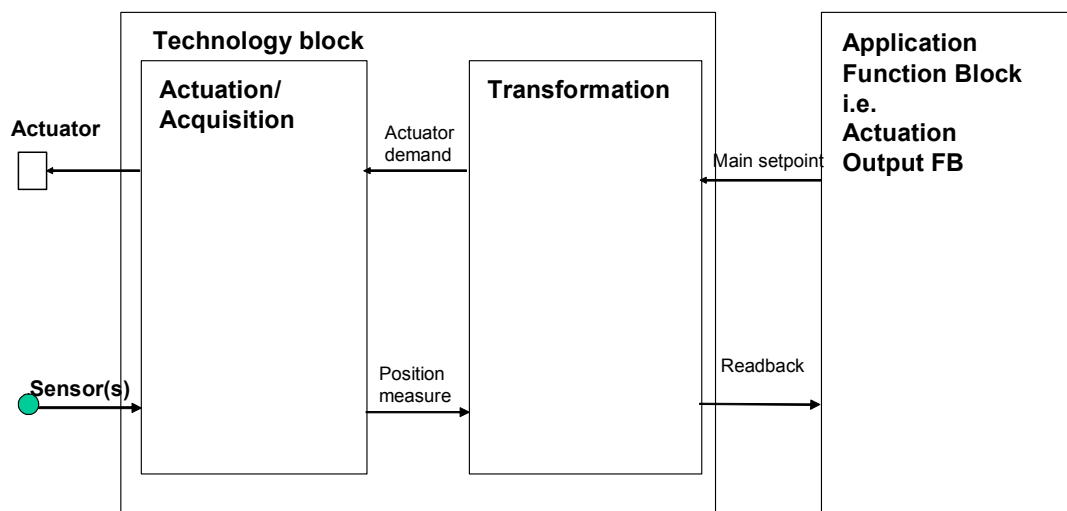

IEC 1511/06

Figure 10 – Actuation process signal flow

The actuation channel is performed out of the function of the actuation signal flow and the additional measurement functions for the measurement of the current position of the actuator. If there is not a sensor for the position measurement, then the actuator demand will be used in the transformation to determine the readback value. Optionally, status values may accompany both signal flow directions and include information about the involved entities. The status accompanying the main setpoint carries information to give the technology block the opportunity to go in fail-safe position, if the main setpoint is not good. The status accompanying the readback carries information if the measure value is good or not. An actuation channel shall consist of at least one application FB. Channels without a technology block are possible.

4.2.3 Application

A complete application is supported by combinations of measurement and actuation channels together with control and calculation FBs (see Figure 11). The technology blocks are technology dependent and the other FBs are technology independent. There may be many different implementations of an application, depending on the technology used within the devices. The application may be performed by implementations using only measurement and actuation devices (i.e. complex devices able to perform measurement, control and actuation), or the application may be built from measurement and actuation devices together with controller devices and other system components.

NOTE A controller can, for instance, be integrated in the application as one calculation FB, or an actuation device can take parts of programmable functions from controller devices in terms of calculation FBs.

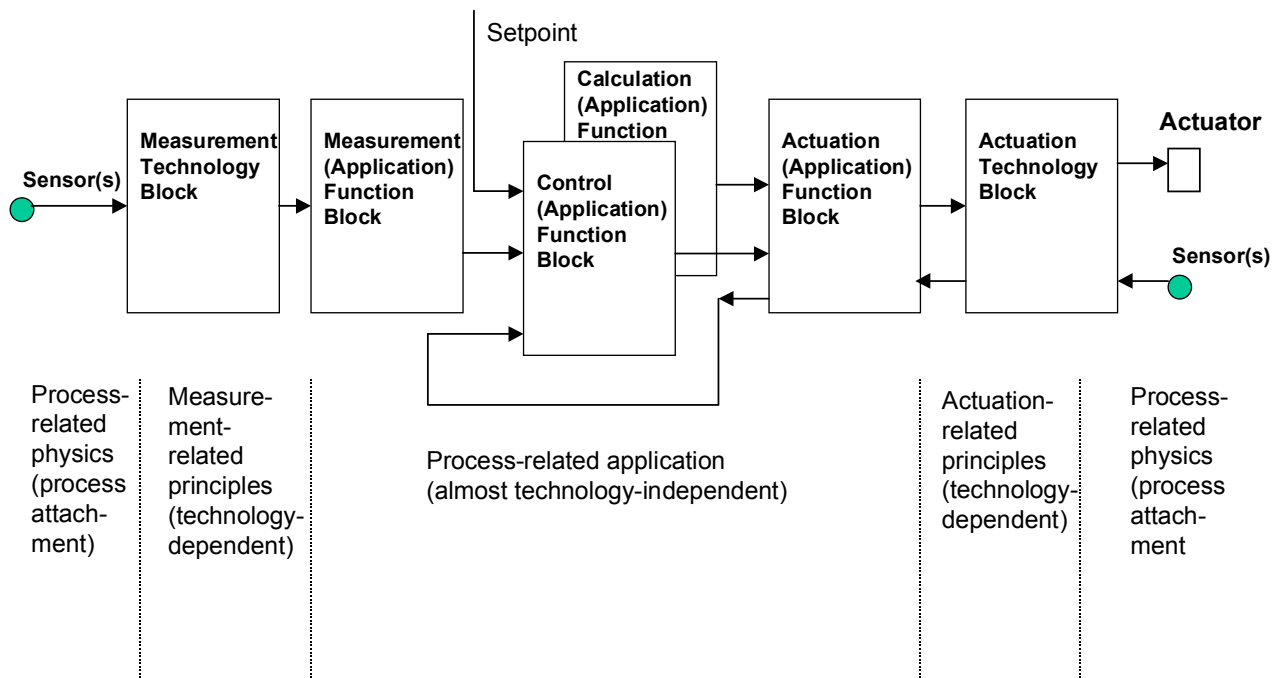

IEC 362/04

Figure 11 – Application process signal flow

5 Detailed block definition

5.1 General

This selection of blocks is not intended to be complete. It is a selection of very common measurement and actuation.

5.2 Application FBs

5.2.1 Analog Input FB

5.2.1.1 Analog Input FB Overview

The measure process signal function shall be used to convert signal(s) from a Technology Block to units appropriate for the primary measurement required for an application. The result is the MEASUREMENT_VALUE.

NOTE For example, conversion from inches of water to litres per minute. Also, this block may be used to provide operator notification that the primary measurement has detected a high or low alarm. The ability may be provided to simulate the process measurement during system checkout and testing.

Each process signal involves more information than only the value of the signal; the management parameters are generally required. Each measurement has a status, which indicates the quality of the measurement value.

The status provided by the technology block is propagated to measurement (Input) FB by the PRIMARY_MEASUREMENT_STATUS. The status is a piece of an information provided with every measurement to assist the user of measurement data (typically control functions) in assessing its utility. For example, it may be a Boolean value (valid/non-valid), a continuous value (measurement uncertainty), a discrete value, or a combination, see 5.6.1.

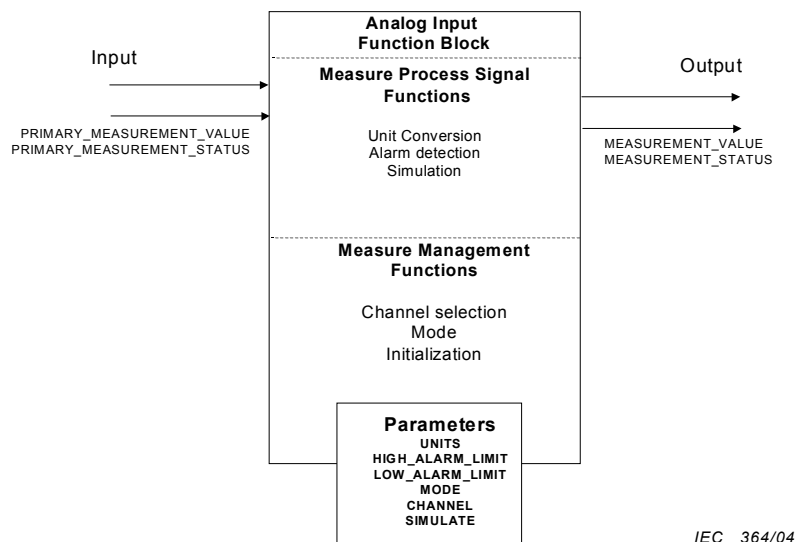

NOTE For parameter description, see Annex A

Figure 12 – Analog Input FB

5.2.1.2 Unit conversion

This algorithm converts the signal from a technology block into an understandable value. That may be used directly by the operator.

The user uses the UNITS to select the engineering units in which the MEASUREMENT_VALUE is to be displayed; for example, bar or mbar.

NOTE This algorithm may also provide information on the channel and device operating state to assist in the diagnostic of management activities.

5.2.1.3 Alarm detection

The FB shall provide the optional alarm detection inside.

Examples are low alarm, high alarm, deviation, update.

When implemented, the LOW_ALARM_LIMIT and HIGH_ALARM_LIMIT values shall be compared with the MEASUREMENT_VALUE of the FB. The results are high and low alarm notification, for example, for an operator.

NOTE The way of reporting the detected alarms is technology-dependent; therefore, it is not described in this standard and shown in the relevant figure.

5.2.1.4 Simulation

This algorithm shall be used to simulate the MEASUREMENT_VALUE value to an assigned value using the SIMULATE parameter. This operation is usually carried out during commissioning, adjustment phases, or test purposes, and allows the running application to be temporarily uncoupled from the process.

5.2.1.5 Channel selection

One technology block will be used for primary final element data. Channel numbers (CHANNEL) will be defined for the measurement device when using more than one technology block.

5.2.1.6 Mode

The mode algorithm determines the source of the output for a measurement input FB based on the MODE parameter value. In the automatic mode, the measurement algorithm determines the output. When the mode is set to manual, the output of the FB is set by a different source; for example, it may be set by the operator.

5.2.1.7 Initialization

The initialization algorithm is applied to this block and described in 5.6.3.

5.2.2 Analog Output FB

5.2.2.1 Analog Output FB overview

The actuation process signal algorithm converts REMOTE_SETPOINT_VALUE into a useful value (OUT_VALUE) for the hardware specified by the channel selection for the technology block. The feedback value (received from the actuator) is provided as the READBACK_VALUE. If the Analog Output FB is part of a cascade chain, the READBACK_OUT_VALUE provides the actual value to the upstream FB. All these input and output parameters shall be accompanied by their status (see 5.6.1).

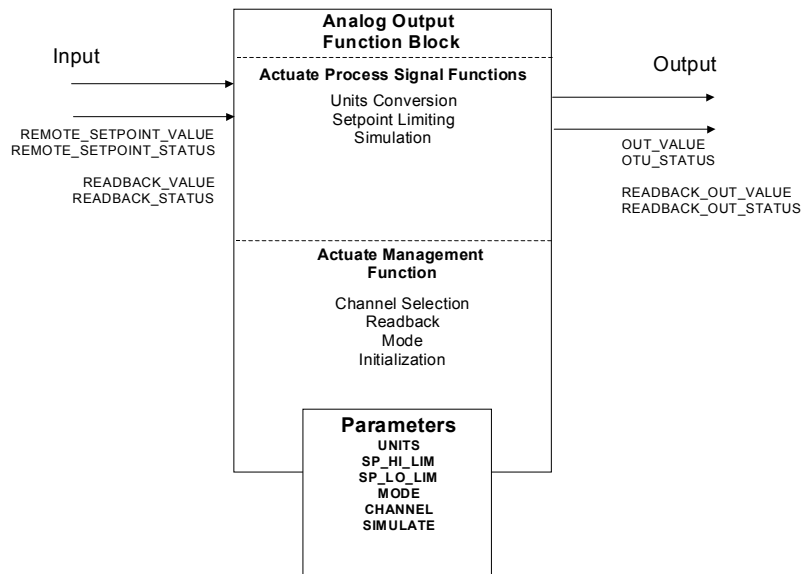

IEC 365/04

NOTE For parameter description, see Annex A.

Figure 13 – Analog Output FB**5.2.2.2 Unit conversion**

This algorithm converts the `REMOTE_SETPOINT_VALUE` to a value, which can be used by the actuator. `UNITS` of the `REMOTE_SETPOINT_VALUE` main setpoint value define the units of the setpoint. The `READBACK_VALUE` (i.e. the actual delivered value or the final demanded value) is also provided in the units of the setpoint.

5.2.2.3 Setpoint limiting

The `REMOTE_SETPOINT_VALUE` that is provided to the FB will be limited to the setpoint lower (`SP_LO_LIM`) and higher (`SP_HI_LIM`) range limits.

5.2.2.4 Simulation

This algorithm is used to force the `READBACK_VALUE` and the `READBACK_STATUS` to assigned values through the `SIMULATE` parameter. The simulation can be used, for example, to simulate technology block faults. In simulation mode, the technology block ignores the Analog Actuation FB output value(s) and maintains the last value. This operation is usually carried out during commissioning, adjustment phases, or test purpose, and allows the running application to be temporarily uncoupled from the process.

5.2.2.5 Channel selection

One technology block will be used for primary final element data. Channel numbers (`CHANNEL`) will be defined for the Modulation Actuator Device when using more than one technology block.

5.2.2.6 Readback

This algorithm gives information about the actual delivered value of the actuator in the process.

The `READBACK_STATUS` information is provided to reflect the state of the actuating value. This may be a Boolean value (valid/non-valid), a continuous value (measurement uncertainty), a discrete value, or a combination.

5.2.2.7 Fail safe

The fail-safe algorithm is described in 5.6.4.

5.2.2.8 Mode

The mode algorithm determines the source of the output for the modulating actuation FB based on the MODE parameter value. In the automatic mode, the output is determined by the modulating actuation algorithm. When the mode is set to manual, the output of the FB is set by a different source; for example, it may be set by the operator.

5.2.2.9 Initialization

The initialization algorithm is applied to this block and described in 5.6.3.

5.2.3 Discrete Input FB

5.2.3.1 Discrete Input overview

Discrete Inputs represent, for example, inductive, optical, capacitive, ultrasonic, etc., proximity switches. When the digital input changes state, the discrete output also changes the state.

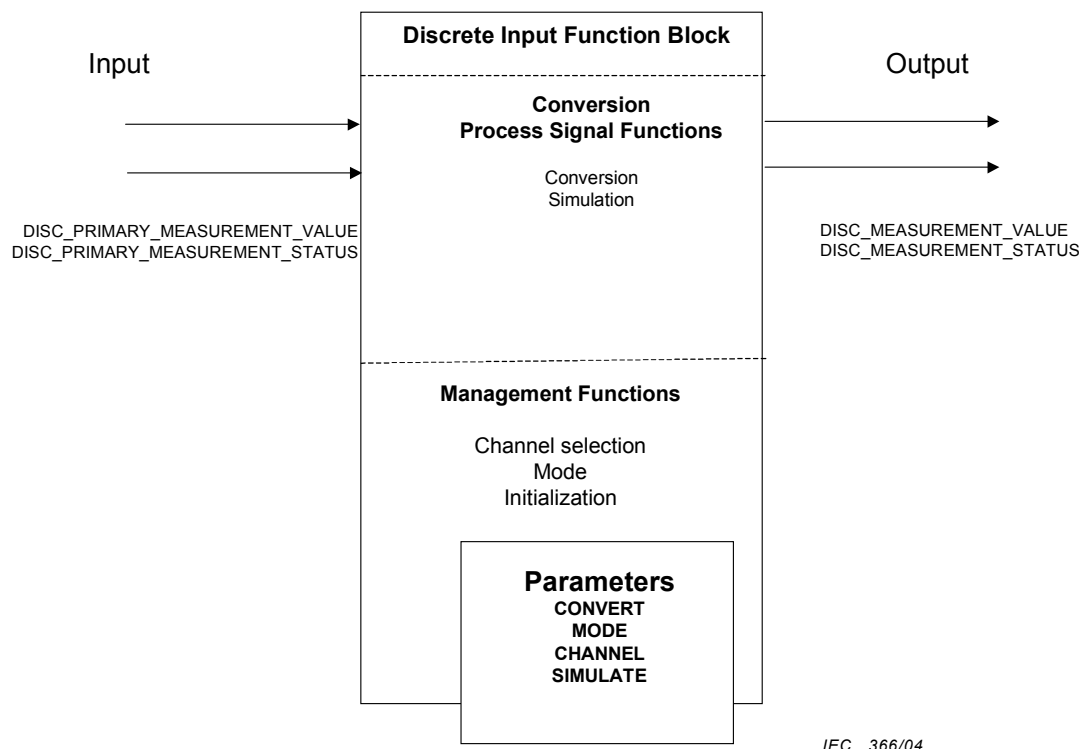

NOTE For parameter description, see Annex A.

Figure 14 – Discrete input FB

5.2.3.2 Conversion

This algorithm converts the Boolean or discrete measure into a logical signal.

The result is the DISC_MEASUREMENT_VALUE accompanied by the DISC_MEASUREMENT_STATUS.

5.2.3.3 Channel selection

One technology block will be used for primary final element data. Channel numbers (CHANNEL) will be defined for the discrete detection device when using more than one technology block.

5.2.3.4 Simulation

This algorithm is used to force the main discrete value to an assigned value using the SIMULATE parameter. This operation is usually carried out during commissioning, adjustment phases, or test purposes, and allows the running application to be temporarily uncoupled from the process.

5.2.3.5 Mode

The mode algorithm determines source of the measure input FB output (main discrete measure) based on the MODE parameter value. In the automatic mode, the discrete measure algorithm determines the output. When the mode is set to manual, the output of the FB is set by a different source; for example, it may be set by the operator.

5.2.3.6 Initialization

The initialization algorithm is applied to this block and described in 5.6.3.

5.2.4 On/Off Actuation (Output) FB Discrete Output FB

5.2.4.1 On/Off Actuation (Output) FB Discrete Output FB overview

The actuation process signal algorithm converts the DISC_REMOTE_SETPOINT_VALUE value to a useful value (DISC_OUT_VALUE) for the hardware at the channel selection to the Technology block. The DISC_READBACK_VALUE defines the target value of the final element. If the Discrete Output FB is part of a cascade chain, the DISC_READBACK_OUT_VALUE provides the actual value to the upstream FB. All these input and output parameters shall be accompanied by their status (see 5.6.1).

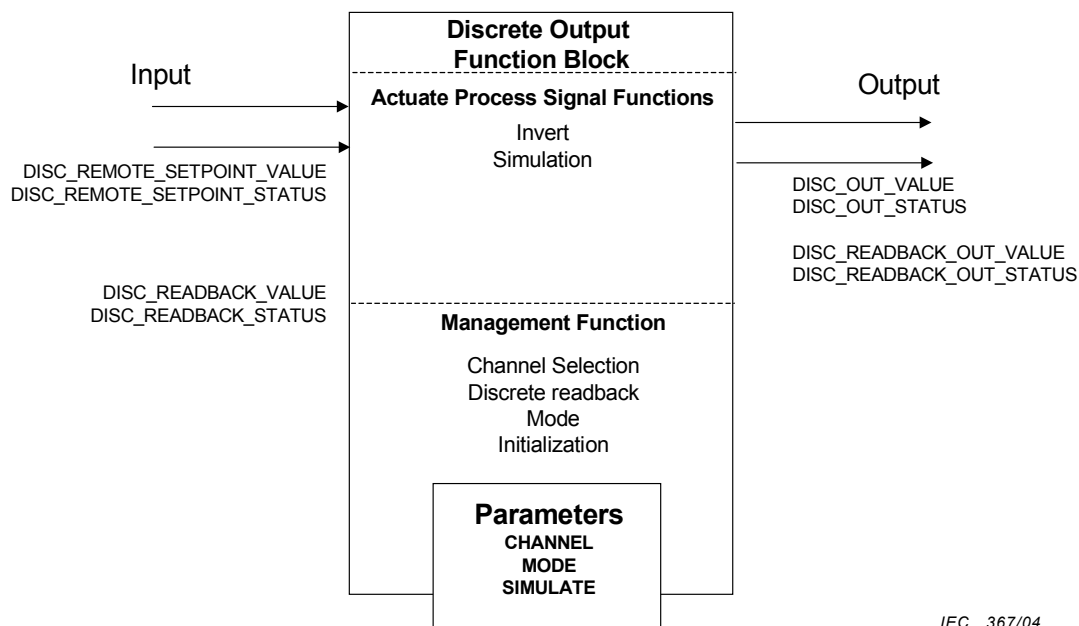

IEC 367/04

NOTE For parameter description, see Annex A.

Figure 15 – Discrete Output FB

5.2.4.2 Invert

Sometimes it is necessary to invert logically the DISC_REMOTE_SETPOINT_VALUE before forwarding it to the discrete actuation demand. This is done in this algorithm.

5.2.4.3 Simulation

This algorithm is used to force the DISC_READBACK_VALUE and the DISC_READBACK_STATUS to assigned values using the SIMULATE setting. The simulation can be used, for example, to simulate technology block faults. In simulation mode, the technology block ignores the DISC_OUT_VALUE value and maintains the last value. This operation is usually carried out during commissioning, adjustment phases, or test purpose, and allows the running application to be temporarily uncoupled from the process.

5.2.4.4 Channel selection

One technology block will be used for primary final element data. Channel numbers (CHANNEL) will be defined for the Modulation Actuator Device when using more than one technology block.

5.2.4.5 Fail safe

The fail-safe algorithm is described in 5.6.4.

5.2.4.6 Mode

The mode algorithm determines the source of the on/off actuation FB output based on the MODE parameter value. In the automatic mode, the on/off actuation algorithm determines the output. When the mode is set to manual, the output of the FB is set by a different source; for example, it may be set by the operator.

5.2.4.7 Initialization

The initialization algorithm is applied to this block and described in 5.6.3.

5.2.5 Calculation FB

5.2.5.1 Calculation FB overview

The calculation FB acts upon the input signal(s) (IN_VALUE_x) from another FB to provide an application value (OUT_VALUE_x). If the Calculation FB is part of a cascade chain, the READBACK_OUT_VALUE provides the actual value to the upstream FB and the READBACK_VALUE is provided by a downstream FB. All these input and output parameters shall be accompanied by their status (see 5.6.1).

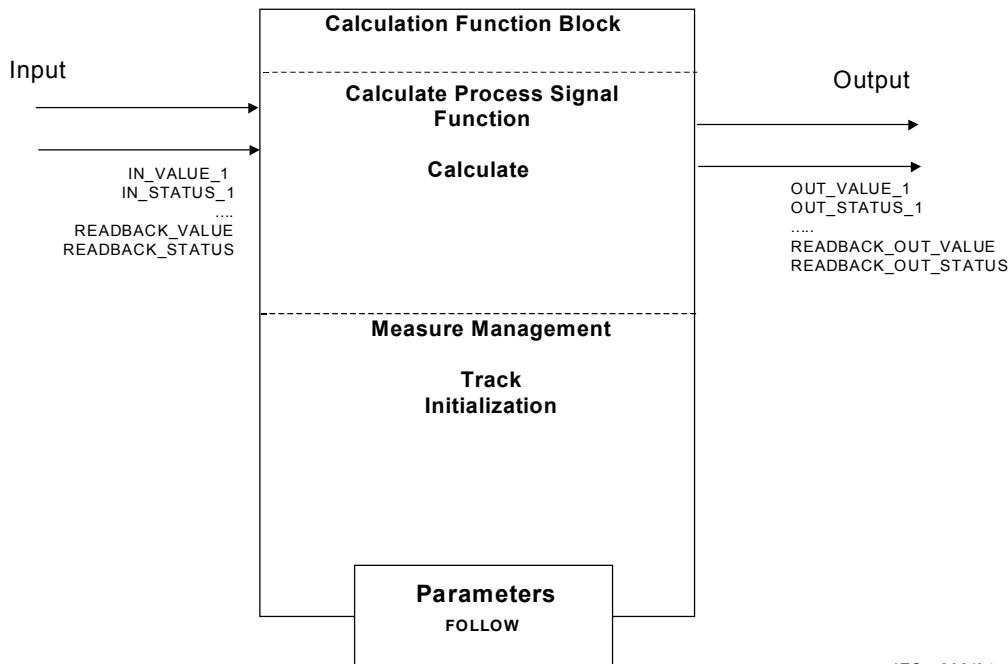

NOTE For parameter description, see Annex A.

IEC 368/04

Figure 16 – Calculation FB

5.2.5.2 Calculate

This algorithm determines the output signal(s) based on a pre-defined algorithm and the input(s) to the FB. Examples of calculation functions are filtering, delay, input select.

5.2.5.3 Track

The track algorithm allows the FB output to be set to an input value when the FOLLOW parameter is active, i.e. non-zero in value. For example this algorithm may be used to initialize a block or to force the calculation results to a specific value.

This does not apply to all blocks.

5.2.5.4 Initialization

The initialization algorithm is applied to this block and is described in 5.6.3.

5.2.6 Control FB

5.2.6.1 Control FB overview

The control FB maintains a process input (IN_VALUE) at the setpoint value (SETPOINT) through the regulation of one or more process actuation outputs. The process input measurement is provided by an appropriate FB through the primary input connection. The primary output of the control FB regulates the process through an appropriate actuation FB. The SETPOINT defines the target value of the process measurement in mode "auto". The readback value and status provided by the downstream actuation block may be used in the initialization and to modify control action when the output is limited by a downstream condition.

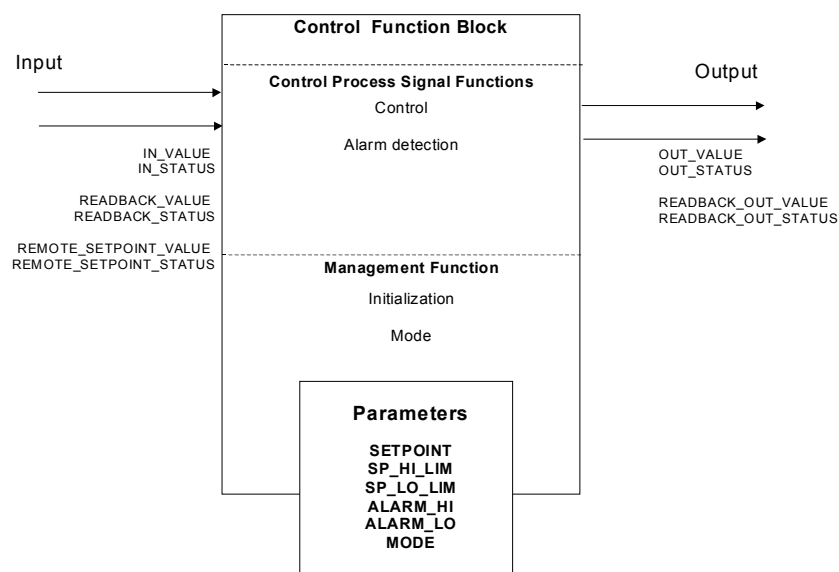

Figure 17 – Control FB

5.2.6.2 Control

This algorithm determines the FB output value that is needed to drive the primary input value to the target value specified by the SETPOINT parameter. Changes in the SETPOINT value are limited to the range specified by the SP_HI and SP_LO limits. Actions may be modified when a readback input from the downstream block indicates that a downstream condition limits the adjustment of the block output.

5.2.6.3 Alarm detection

The alarm detection is optional. When implemented, the LOW_ALARM_LIMIT and HIGH_ALARM_LIMIT values shall be compared with the primary control measurement value of the block. The results are high and low alarm notification, for example, for an operator.

NOTE The way of reporting the detected alarms is technology-dependent; therefore, it is not described in this standard and shown in the relevant figure.

5.2.6.4 MODE

The mode algorithm determines the source of the control block output based on the MODE parameter value. In Automatic mode, the output is determined by the control algorithm and the SETPOINT is specified by the operator. When mode is set to Manual, the output of the block is set by a different source; for example, it may be set by the operator.

In remote mode, the output is determined by the control algorithm and the setpoint is determined by the REMOTE_SETPOINT input from another FB.

5.2.6.5 Initialization

When the feedback status indicates that the path to the process input is blocked, the output of the FB will be set based on the readback value to provide bumpless transfer when the downstream mode is changed to remote.

5.3 Component FBs

A process control application is built out of application FBs as defined above. In addition, the application may include component FBs combined in an application-specific way and encapsulated by FBs of composite FB type. The exception handling and status handling is technology-specific and is part of the component FB definitions.

5.4 Technology Block

5.4.1 Temperature Technology Block

5.4.1.1 Temperature Technology Block overview

The algorithms of the Temperature Technology Block are summarized below.

- a) Sensor connection
- b) Channel range/scaling
- c) AD conversion
- d) Test
- e) Diagnosis
- f) Cold junction compensation
- g) Linearization
- h) Filtering
- i) Initialization

The algorithms are encapsulated in the Acquisition and Transformation part of the Technology Block (see Figure 18).

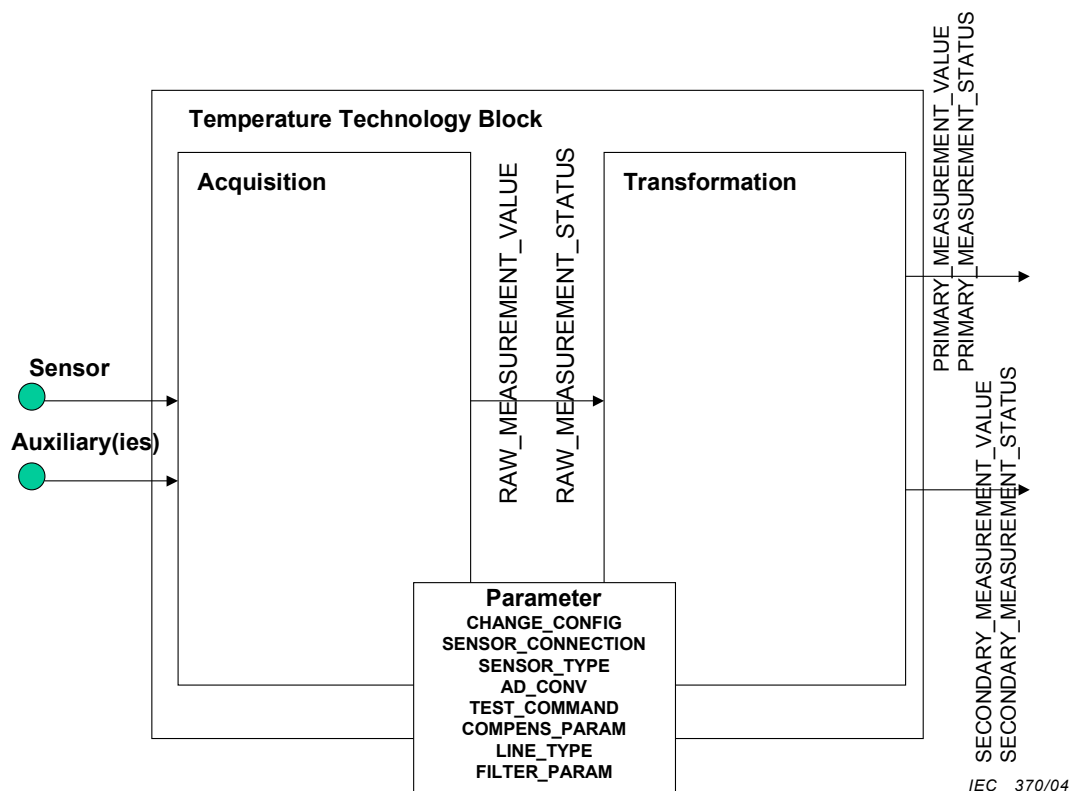

IEC 370/04

Figure 18 – Temperature Technology Block

5.4.1.2 Temperature Acquisition Functions

5.4.1.2.1 Sensor connection

The process signal is connected directly to the interface module.

There is a possibility to connect the thermo resistance with 2, 3 or 4 wires. Compensation is chosen by the parameter SENSOR_CONNECTION.

This algorithm checks the sensor link and signals a fault if there is a short-circuit or an open circuit. The wiring check is enabled/disabled via configuration (CHAN_CONFIG).

5.4.1.2.2 Channel range

This algorithm selects the sensor type which is connected to the device. According to the configuration (SENSOR_TYPE), it is necessary to differentiate between:

- electrical range (± 10 V, 0 ... 10 V, 0 ... 5 V, 1 ... 5 V, 0 ... 20 mA or 4 ... 20 mA);
- thermocouple;
- temperature probes.

Table 3 gives an example of several types of sensor.

Table 3 – Example of temperature sensors of Sensor_Type

Symbol	Description
Type B	Platinum - 30% Rhodium/ Platinum - 6% Rhodium
Type C	Tungsten - 5% Rhenium/Tungsten - 26% Rhenium
Type D	Tungsten - 3% Rhenium/Tungsten - 25% Rhenium
Type E	Chromel/Constantan
Type G	Tungsten/Tungsten - 26% Rhenium
Type J	Iron/Constantan
Type K	Chromel/Alumel
Type L	Platinel 5355/Platinel 7674
Type N	Nicrosil/Nisil
Type R	Platinum 13 % Rhodium/ Platinum
Type S	Platinum 10 % Rhodium/ Platinum
Type T	Copper/Constantan
Pt50	Platinum 50 Ω
Pt100	Platinum 100 Ω
Pt200	Platinum 200 Ω
Pt500	Platinum 500 Ω
Pt1000	Platinum 1 000 Ω
Ni10	Nickel 10 Ω
Ni50	Nickel 50 Ω
Ni100	Nickel 100 Ω
Ni120	Nickel 120 Ω
Cu10	Copper 10 Ω
Cu25	Copper 25 Ω
Cu100	Copper 100 Ω
NOTE The temperature range can be the default range of the selected thermocouple or temperature probe defined in tenths of degree (e.g. - 600 to + 11 000 tenths of $^{\circ}\text{C}$ for a Ni 1 000 probe).	

5.4.1.2.3 AD Conversion

Digitalization of input measurement analogue signal, according to the parameter set during configuration (ADCONV).

5.4.1.2.4 Test

Many test strategies are possible, for example, switching the input from the sensor to a reference signal and checking the output of the technology block against the expected value, in order to assess correct operation.

Test results then contribute to the status information processing. During tests it is recommended that the output of the connected AB maintains the previous value or other 'best estimate' of the true current value.

This algorithm is started by the TEST_COMMAND parameter, which is optional, and its implementation is manufacturer-specific.

5.4.1.2.5 Diagnosis

This algorithm is device-specific to assess internal performance of the related channel. The results of internal assessments are used to construct the generic measurement status information. Technology-specific report mechanisms provide according status information, for example, to maintenance planning.

5.4.1.3 Initialization

The initialization algorithm is applied to this block and described in 5.6.3.

5.4.1.4 Temperature Transformation Functions

5.4.1.4.1 Cold-junction Compensation

The voltage generated from thermocouple is compensated with a reference junction value. COMPENS_PARAM defines the type of compensation. The type of cold junction compensation is either Internal or External (Internal: the device itself measures the reference junction temperature via an internal mounted sensor).

5.4.1.4.2 Linearization

Thermocouple and RTD values are linearized and compensated internally. The linearization is done according to the IEC 60584-1 reference standard for the thermocouple curve. Optionally, the manufacturer may offer an additional user-defined linearization. LINE_TYPE defines the linearization curve coefficients.

5.4.1.4.3 Filtering

A filtering is performed on the measured values and compensated.

With the FILTER_PARAM, the filter efficiency shall be selected, for example 1 s, 2 s, 5 s, etc.

5.4.1.4.4 Initialization

The initialization algorithm is applied to this block and described in 5.6.3.

5.4.2 Pressure Technology Block

5.4.2.1 Pressure Technology Block overview

The algorithms of the Pressure Technology Block are summarized below.

- a) Sensor connection
- b) Channel range/Scaling
- c) Sensor calibration
- d) Test
- e) Diagnosis
- f) Linearization
- g) Filtering
- h) Temperature compensation
- i) Initialization

The algorithms are encapsulated in the Acquisition and Transformation part of the Technology Block (see Figure 19).

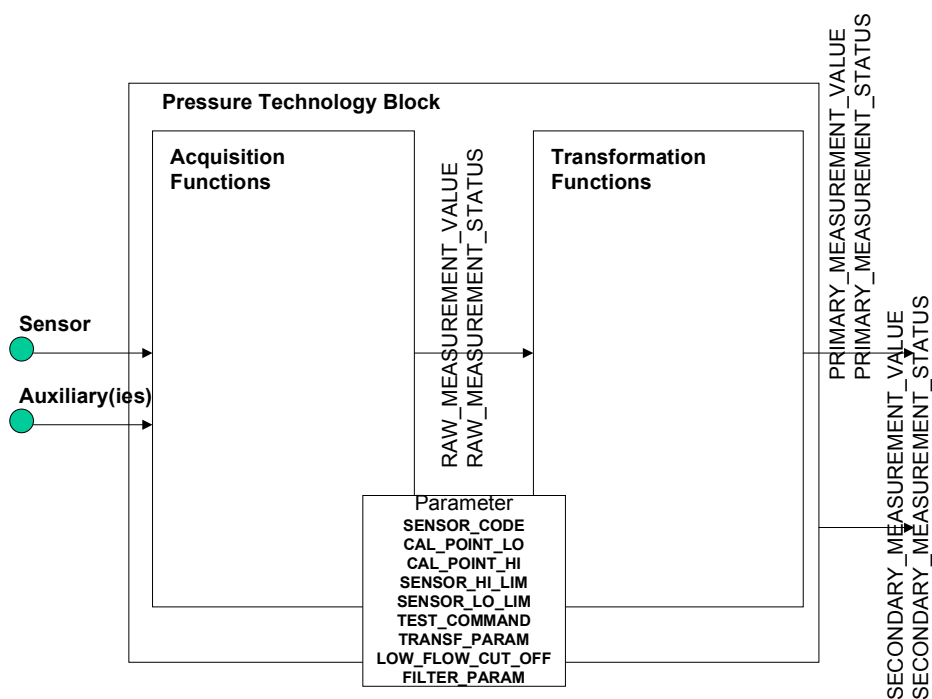

Figure 19 – Pressure Technology Block

IEC 371/04

5.4.2.2 Pressure Acquisition Functions

5.4.2.2.1 Sensor connection

There is a possibility to connect the different pressure or differential pressure sensors to the transmitter. Compensation is chosen by the parameter `SENSOR_CODE` depending from the measurement principle.

5.4.2.2.2 Channel range scaling

This algorithm selects the display format in which the measurements are supplied to the user. The `SENSOR_HI_LIM` and `SENSOR_LO_LIM` parameter define the maximum and minimum values the sensor is capable of indicating.

5.4.2.2.3 Sensor calibration

The calibration process is used to match the channel value combined with the applied input. The calibration of the sensor itself is not changed, because that is a factory procedure. Four parameters are defined to configure this process: CAL_POINT_HI, CAL_POINT_LO, SENSOR_HI_LIM and SENSOR_LO_LIM. The CAL_* parameters define the highest and lowest calibrated values for this sensor.

5.4.2.2.4 Test

Many test strategies are possible, for example, switching the input from the sensor to a reference signal and checking the output of the technology block against the expected value, in order to assess correct operation.

Test results then contribute to the status information processing. During tests it is recommended that the output of the Application Block maintains the previous value or other 'best estimate' of the true current value.

This algorithm is started by the TEST_COMMAND parameter which is optional, and its implementation is manufacturer-specific.

5.4.2.2.5 Diagnosis

This algorithm is device specific to assess internal performance of the related channel. The results of internal assessments are used to construct the generic measurement status information. Technology specific report mechanisms provide according status information for example to maintenance planning.

5.4.2.2.6 Initialization

The initialization algorithm is applied to this block and described in 5.6.3.

5.4.2.3 Pressure Transformation Functions

5.4.2.3.1 Linearization

Pressure sensor values are linearized and compensated internally. Generally, a linearization is realized in the factory to meet initial accuracy. Additional linearization is done by using the TRANSF_PARAM parameter if flow or level measurement is applied with the pressure transmitter. The square root function is chosen as well as user-defined linearization tables. LOW_FLOW_CUT_OFF parameter determines the starting point for flow measurement at the lowest level.

5.4.2.3.2 Filtering

Filter values are selected (no filter, low level of filtering, medium level of filtering, high level of filtering) in the according FILTER_PARAM. The filtering is done on the measure that is linearized and compensated.

5.4.2.3.3 Temperature compensation

Usually the pressure of a liquid or gas is dependent on its temperature. The measured pressure value is compensated with the according temperature using this algorithm.

5.4.2.3.4 Initialization

The initialization algorithm is applied to this block and described in 5.6.3.

5.4.3 Modulating Actuation Technology Block

5.4.3.1 Modulating Actuation Technology Block overview

The elementary algorithms and parameters of modulated actuation are summarized below. Valves as well as motor drives are represented because the functions do not include technology details:

- a) amplification;
- b) readback measurement;
- c) output limits;
- d) self-calibration;
- e) failsafe;
- f) diagnosis;
- g) test;
- h) initialization.

A graphical representation with the inputs (left), the outputs (right) and the parameters (bottom) is used.

NOTE The inputs and outputs are logical connections and they do not always represent the signal flow from the view of the automation application (process control) or the process itself.

The algorithms are encapsulated in the acquisition and transformation part of the technology block (see Figure 20).

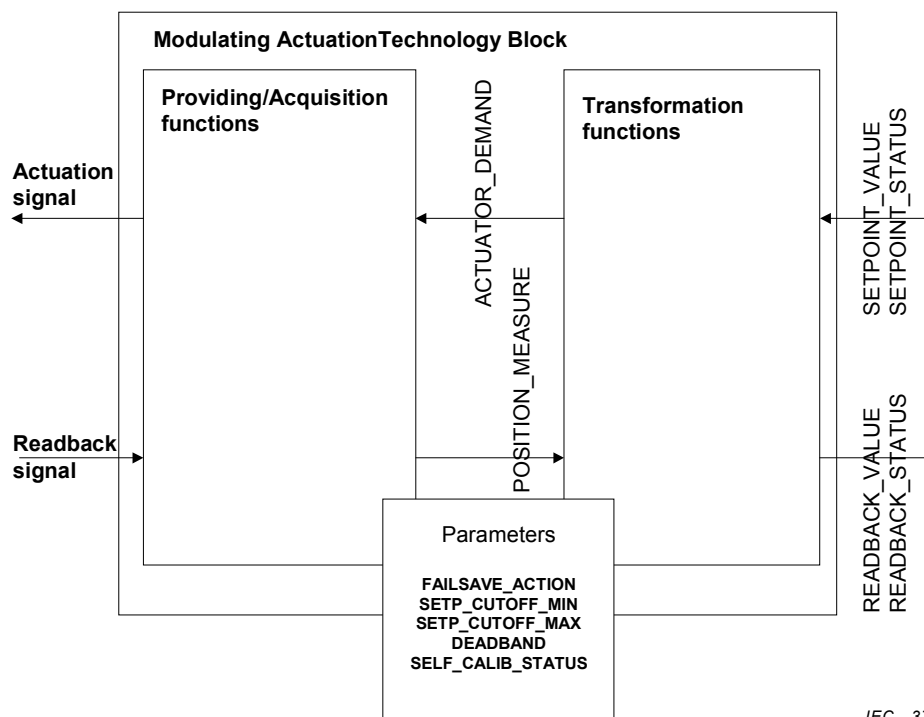

IEC 372/04

Figure 20 – Modulating actuation technology block

5.4.3.2 Providing and Acquisition Functions

5.4.3.2.1 Amplification

The block provides as an output a signal (actuation signal) from the ACTUATOR_DEMAND for the final element (for example, a valve or motor). The final element modifies the process in response to this actuation demand output sent from the AB to the technology block (SETPOINT_VALUE).

5.4.3.2.2 Readback measurement

The block measures the actual readback signal from the final element and converts it to the transfer part of the technology block (POSITION_MEASURE).

5.4.3.2.3 Fail safe

The fail-safe algorithm is described in 5.6.4.

5.4.3.2.4 Test

Many test strategies are possible; for example, driving the actuator in a defined range and check the measured values, in order to assess correct operation. Test results then contribute to the status information processing. During tests it is recommended that the output of the test reflects the actual actions.

This algorithm is started by the TEST_COMMAND parameter, which is optional, and its implementation is manufacturer-specific.

5.4.3.2.5 Diagnosis

This algorithm is device-specific to assess the internal performance of the related channel. The results of internal assessments are used to construct the generic measurement status information. Technology-specific report mechanisms provide additional status information for example to maintenance planning.

5.4.3.2.6 Initialization

The initialization algorithm is applied to this block and described in 5.6.3.

5.4.3.3 Transformation Functions

5.4.3.3.1 Output limits

When the setpoint goes below the defined SETP_CUTOFF_MIN limit, the output (actuation signal) goes to the minimum value. With an electro-pneumatic actuator, this is done by venting/filling the actuator. With a variable-speed actuator, the actuator goes to the stopped condition.

When the setpoint goes above the defined SETP_CUTOFF_MAX limit, the output (actuation signal) goes to the maximum value. With an electro-pneumatic actuator, this is done by totally ventilation/filling of the actuator. With a variable speed actuator, the actuator goes to the full value condition.

5.4.3.3.2 Self-calibration

The procedure of self-calibrating is manufacturer-specific. The following status information (SELF_CALIB_STATUS) are typical examples: undetermined, aborted, error in mechanical system, timeout, aborted by means of emergency override, zero point error, success.

5.4.3.3.3 Deadband

There is a deadband in which the changes of SETPOINT_VALUE does not affect the actuation signal. This is indicated in the DEADBAND parameter.

5.4.3.3.4 Initialization

The initialization algorithm is applied to this block and described in 5.6.3.

5.4.4 On/Off Actuation Technology Block

5.4.4.1 On/Off Actuation Technology Block overview

The elementary algorithms and parameters of the device are summarized below.

- a) Signal conversion
- b) Signal detection
- c) Self-calibrating
- d) Count limits
- e) Failsafe
- f) Test
- g) Diagnosis
- h) Initialization

A graphical representation with the inputs (left), the outputs (right) and the parameters (bottom) is used.

NOTE Both simple and complex implementations are available using various technologies.

5.4.4.2 Technology/Providing and Acquisition Functions

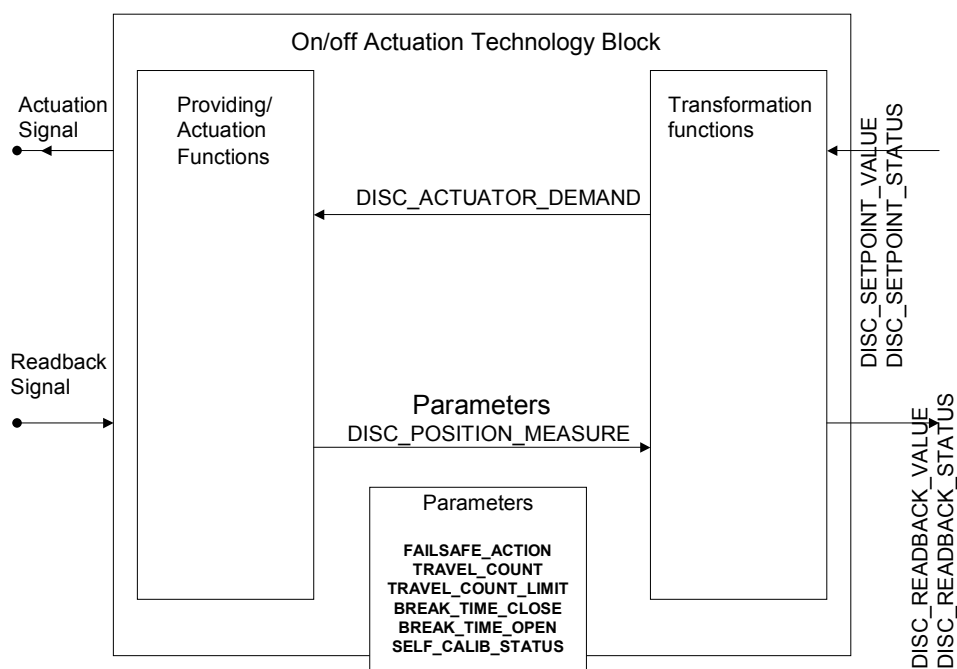

IEC 373/04

Figure 21 – On/Off Actuation Technology Block

5.4.4.2.1 Signal conversion

The block provides as an output a two-state Signal (Discrete actuation signal) from the DISC_ACTUATOR_DEMAND to the final element (e.g. a relay or valve). The final element modifies the process in response to this discrete actuation demand output sent from the application block to the technology block (DISC_SETPOINT_VALUE).

5.4.4.2.2 Signal detection

The block receives the actual demanded state (e.g. the discrete position signal) from the final element and converts it to the transfer part of the technology block (DISC_POSITION_MEASURE).

5.4.4.2.3 Break time

The actuator needs a certain period of time to switch. The break time function in the technology block provides an adjustable dead time between a new DISC_SETPOINT_VALUE value and the change of the DISC_ACTUATOR_DEMAND by the parameters BREAK_TIME_CLOSE and BREAK_TIME_OPEN.

5.4.4.2.4 Fail safe

The fail-safe algorithm is described in 5.6.4.

5.4.4.2.5 Test

Many test strategies are possible; for example, switching the actuator on and off and checking actual reached positions, in order to assess correct operation. Test results then contribute to the status information processing. During tests it is recommended that the output of the AB reflect the actual actions.

This algorithm is started by the TEST_COMMAND parameter, which is optional, and its implementation is manufacturer-specific.

5.4.4.2.6 Diagnosis

This algorithm is device specific to assess the internal performance of the related channel. The results of internal assessments are used to construct the generic measurement status information. Technology-specific report mechanisms provide relevant status information for example to maintenance planning.

5.4.4.2.7 Initialization

The initialization algorithm is applied to this block and described in 5.6.3.

5.4.4.3 Transformation Functions

5.4.4.3.1 Count limits

This algorithm counts the numbers of cycles (TRAVEL_COUNT) of an actuator. A cycle is two successive transitions from one state to the other and back to the first. The detection of transitions and the count function is manufacturer-specific. The count is often used internally to assist diagnosis and the TRAVEL_COUNT_LIMIT can trigger a suitable maintenance report.

5.4.4.3.2 Self-calibrating

The procedure of self-calibrating is manufacturer-specific. The following status information (SELF_CALIB_STATUS) are recommended:

Undetermined, Aborted, Error in mechanical system, Timeout, Aborted by means of Emergency override, Zero point error, Success.

5.4.4.3.3 Initialization

The initialization algorithm is applied to this block and described in 5.6.3.

5.5 Device (Resource) Block

5.5.1 Identification

The Device provides documentation information electronically to assist the user of a device (in particular a Control operator/algorithm) in checking the device type and revision. For the different phases of the device life cycle (Design, commissioning, documentation (on-line), it is absolutely necessary to have an unambiguous identification of the devices. Therefore, the following parameters are supported:

- DEVICE_VENDOR
- DEVICE_MODEL
- DEVICE_REVISION
- DEVICE_SER_NO for identification of multiple devices of the same type is optional.

5.5.2 Device state

The Device synthesized status is devoted to assist the user of a device (in particular a Control operator/algorithm) in assessing its remaining capabilities and to adapt accordingly its strategies. This status is called DEVICE_STATUS.

As an example the following state models are provided to aid in understanding the relevant device behaviour. Behaviour is described using a state table, a Harel state model and a transition table.

Table 4 – Device status state table

State	Description
NETWORK EXECUTING	Initial state of the device. Device is capable of responding to network commands for normal operation. The processor is running
NETWORK FAULTED	The normal operation of the device is not available, because the device functionality is not accessible through the network
APPLICATION EXECUTING	Initial state of the application. Device is available for operation (normal, test and fault detection)
NORMAL	The device is available for normal operation including the reporting of detected diagnostics and process alarms
AUTOMATIC	The device processes the value from the transmitter according to all algorithms (Scaling, filtering, limit checks, engineering unit conversion)
MANUAL	This state is used to force the main measurement to an assigned value
LEARNING	The device is performing an automatic adjustment of some parameters (for example, functional threshold). This state is optional; it depends on the device
FAULTED	The device is not available for normal operation. Within this state, additional sub categories of fault status may be reported. Examples are: diagnosis, event time stamp and maintenance priority
TEST	Device is performing test. This state is optional, it depends on the device

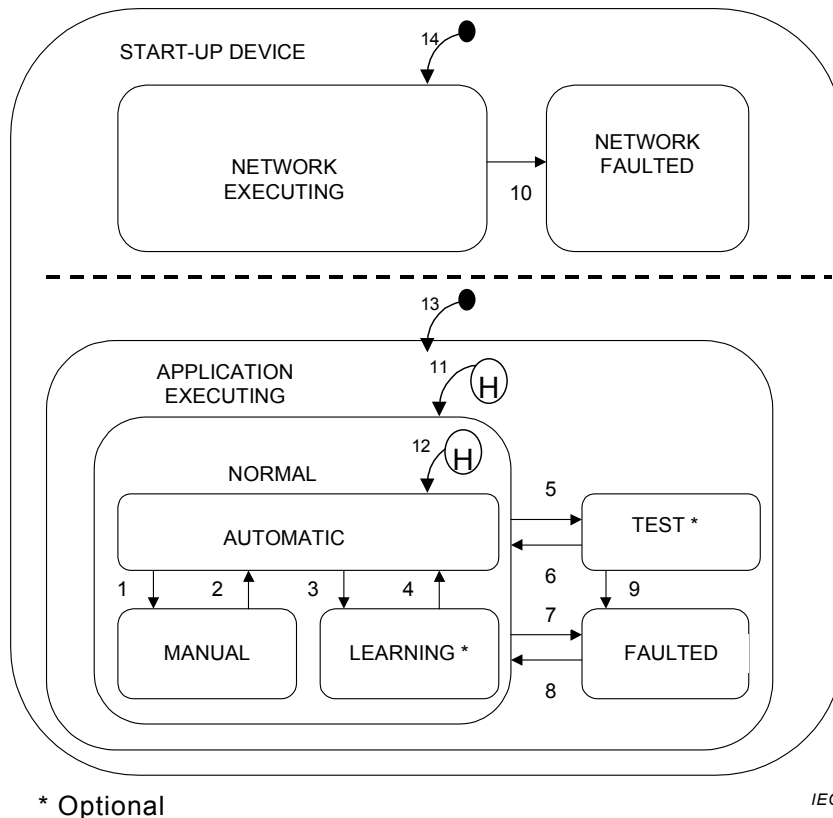

Figure 22 – Harel state chart

Table 5 – Device status transition table

Transition	From state	To State	Description
1	AUTOMATIC	MANUAL	A control command with the operating mode "Manual" is received by the device
2	MANUAL	AUTOMATIC	A control command with the operating mode "Automatic" is received by the device
3	AUTOMATIC	LEARNING	Not mandatory for all devices
4	LEARNING	AUTOMATIC	Not mandatory for all devices
5	NORMAL	TEST	Not mandatory for all devices
6	TEST	NORMAL	Not mandatory for all devices
7	NORMAL	FAULTED	A fault is detected
8	FAULTED	NORMAL	Fault reset
9	TEST	FAULTED	Not mandatory for all device
10	NETWORK EXECUTING	NETWORK FAULTED	Communication port failed, processor failed
11	APPLICATION EXECUTION	NORMAL or state before restart	Initialization of application to provide diagnosis and alarm information
12	NORMAL	AUTOMATIC or state before restart	Application run now in AUTOMATIC or states LEARNING or MANUAL and recovering the states according the device data
13	Power off	APPLICATION EXECUTION	Initialization to device application
14	Power off	NETWORK EXECUTING	Initialization of the communication

5.5.3 Message

The device provides memory space to store user information arising during the lifetime of the device. The user, for example, service staff or maintenance operator, writes textual information in this parameter. For example, it can be used for documentation purposes.

5.5.4 Initialization

The initialization algorithm is applied to this block and described in 5.6.3.

5.6 Algorithms common to all blocks

5.6.1 Data Input/Data Output status

The synthesized output status is determined by a block based on its algorithm execution results, which for example consider block inputs, block parameters, diagnosis and device state. It is provided to assist the user of a device or a measurement (in particular a control operator/algorithm) when assessing its current performance capabilities and to adapt accordingly its strategies.

For example, input status is used by some FBs to change MODE and execute alternative algorithms.

5.6.2 Validity

Each FB can optionally offer a validity function, which provides a more detailed information about the quality of the measurement than one expressed with the input/output status. In this case the FB has to record in the parameter list the relevant contained parameters (for example, Uncertainty_Value and Uncertainty_Status). Validity functions shall be separated from status functions.

NOTE The distribution of the validity information can be carried out in an acyclic or in a cyclic way.

5.6.3 Restart Initialization

Many process control applications require control strategies to take pre-defined initialization actions when restarting components and devices in the process control system. This capability is commonly called a Restart Initialization function. The restart initialization actions are highly dependent on the control system technologies and are often configured uniquely for the particular process application.

The following optional behaviour may apply:

- first activation of a new device;
- cold restart of a device (extended power failure);
- warm restart of a device (short power failure);
- return of a device from fail-safe.

NOTE 1 This may be implemented as part of device management, FB management, mode or application program.

For example, output technology blocks include defined default values for input (channel) parameters and the associated block functions to drive the output hardware to its unpowered state when the technology block input (channel) is not configured (i.e. the technology block input (channel) is not connected to a FB output).

NOTE 2 The physical device is represented by the Device Block. The initialization of the device block is the visible initialization of the physical device.

5.6.4 Fail-safe

In many process control applications, it is critical for control strategies and devices to take safe pre-defined actions in the event of a failure of strategies, components, or devices in the process control system. This capability is commonly called a fail-safe function. The following optional behaviour may apply:

- a resource fail-safe command, when set, will cause appropriate technology and FBs within the resource to execute their defined fail-safe actions;
- also, a resource fail-safe disable command, when set, will disable all fail-safe actions within the resource;
- initiate a fail-safe command on detection of lack of communication with other devices or resources within the system.

The particular pre-defined actions taken are highly dependent on the process application. The precise implementations of fail-safe functions are highly dependent on the control system technologies.

For example, resource blocks in some technologies and applications include parameters and functions to provide fail-safe action of device hardware and blocks associated with the resource. Fail-safe disable is enabled with a hardware jumper in this example profile. When fail-safe disable is active, the resource sends fail-safe disabled notifications to other appropriate resources in the system.

For example, technology blocks in some technologies and applications include parameters and functions to provide fail-safe action of device hardware associated with the block. For example, a technology block in one profile will execute pre-defined fail-safe actions on detection of bad channel or hardware values. The technology block will also execute pre-defined fail-safe actions on receipt of a resource block fail-safe command.

For example, control, calculation, and output FBs in some technologies and applications include parameters and functions to provide fail-safe action of control functionality within the block. For example, a FB in one technology profile will execute pre-defined fail-safe actions on detection of bad input, output, or transfer values. The FB will also execute pre-defined fail-safe actions on receipt of a resource fail-safe command. When fail-safe is active, these FBs send fail-safe notifications to appropriate resources in the system via their own resource.

5.6.5 Remote Cascade Initialization

A control block out value may connect to the remote setpoint of an output or control block. The downstream block will be set its setpoint to this remote setpoint input value when the block mode parameter is set to remote cascade. To prevent the block setpoint from changing when the mode transitions from auto or manual to remote cascade, the output of the block providing the remote setpoint value must match the setpoint. To allow this coordination, the Readback Out value and status of the downstream block are connected to the Readback value and status of the upper block. The Readback Out value must reflect the block setpoint or In_Value value. The Readback Out status reflects the mode and initialization state. Similarly, the control block OUT Status should reflect action taken by the block based on its Readback input.

When the control block Readback status indicates that the downstream block is not in Cascade mode, then its Out Value will be set to the Readback value. When the mode of the downstream block transitions to Remote Cascade, then its Readback status should indicate that initialization is required. Only after the control block has taken action on this initialization request should its out status indicate that initialization is complete. Once the Remote Input status reflects that initialization is complete, then the block must set the setpoint to the Remote Setpoint value and provide a status indicating normal operation in its Readback Out status.

6 FB environment

The FB environment is composed of additional object and block types to the types defined in 4.1.1. These object and blocks are

- Link Block;
- Alert Block;
- Trend Block.

NOTE The FB Environment is very platform- and technology-dependent.

7 Mapping to System Management

The mapping to System Management is an open issue regarding the IEC 61158 series. Therefore it is not done within this specification.

NOTE Fieldbus specific solutions may define their own mapping without changing the definition of this standard.

8 Mapping to communication

To provide a systematic mapping to communication networks, the ISO OSI Reference Model of IEC 7498-1 shall be used. Regarding the application representation, the model shown in Figure 23 is used.

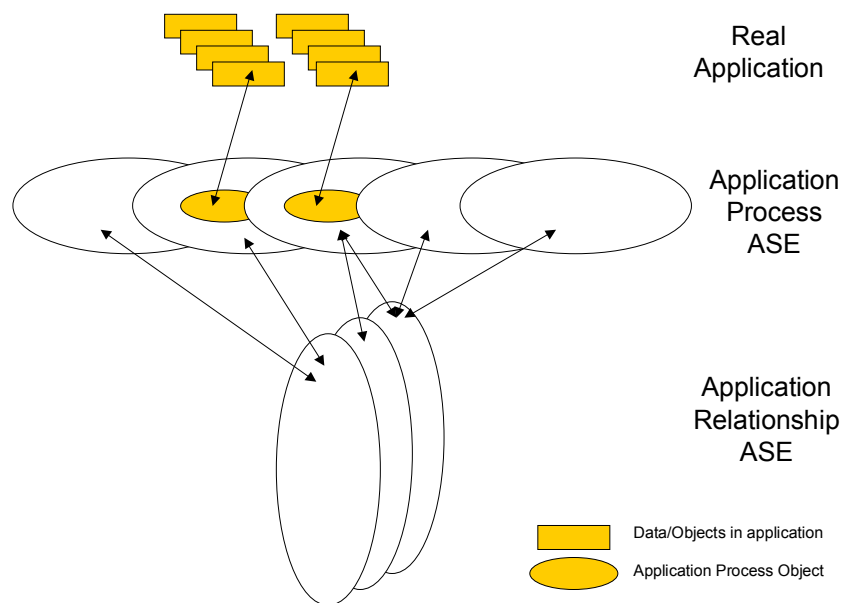

IEC 375/04

Figure 23 – Application structure of ISO OSI Reference Model

The real application data inputs, data outputs and parameters and object are represented by so-called Application Process Objects (APOs) which are managed by so-called Application Process Application Service Entities (AP ASEs) (see OSI Reference Model). These AP ASEs communicate via so-called Application Relationship ASEs.

For example, a client server relationship is modelled as shown in Figure 24.

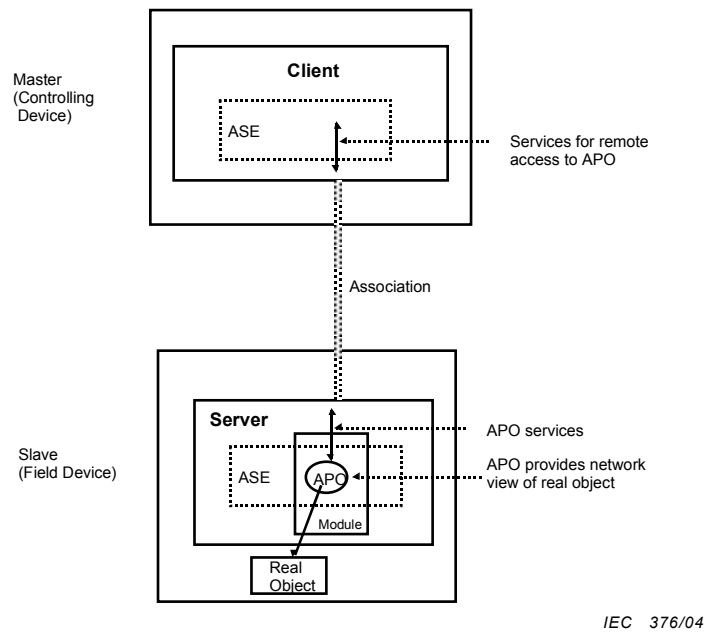

Figure 24 – Client/Server relationship in terms of OSI Reference Model

IEC 61158 uses exactly this model. Therefore, mapping shall use the same.

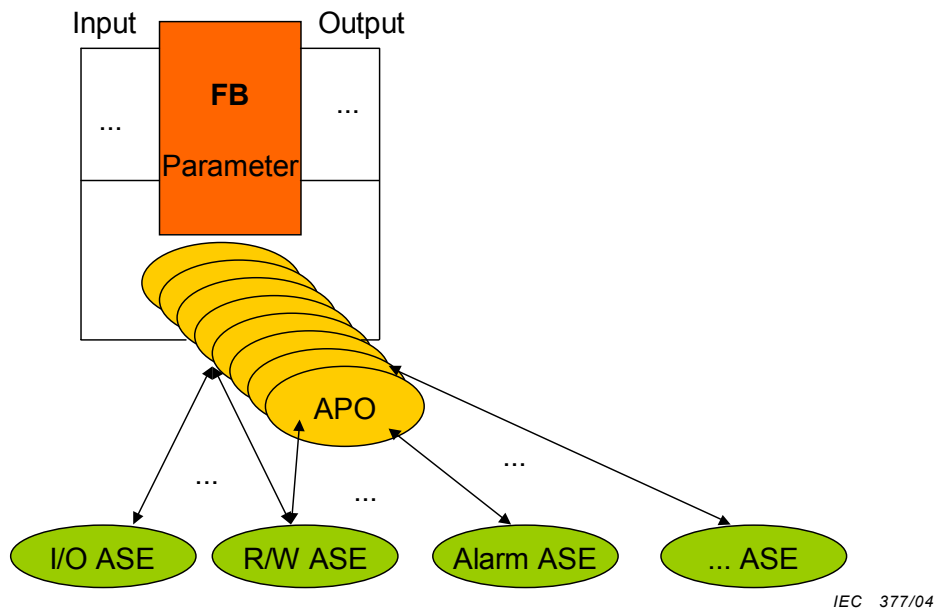

Figure 25 – Mapping of IEC 61804 FBs to APOs

The proposed mapping rules are as follows.

- Inputs, Outputs, parameter and the blocks themselves should be mapped to according APOs.
- For each APO the allowed ASEs have to be defined. More than one ASE per APO is possible.

The mapping to a fieldbus according to IEC 61158 or any other communication system shall be done by the appropriate expert group of the communication system.

9 Conformance statement

A conformant device shall implement all the mandatory requirements of this standard (recognizable by the “shall ...” declaration). The manufacturer of a device shall declare conformance of the device to IEC 61804-2. To show the optional features, the conformance declaration shall use the template conventions given in Annex B.

Annex A (informative)

Parameter description

Annex A describes the parameter of the different FBs (see Table A.1).

NOTE The acronyms have the meaning: M = mandatory, O = optional, C = conditional, R = read, R/W = read/write.

Table A.1 – Parameter description

Parameter name	Description	Data type	User access read/write	Class M/O/C
Analog Input FB				
MEASUREMENT_VALUE	Main measurement value as a result of the Measurement FB	Numeric	R	M
MEASUREMENT_STATUS	Status of the MEASUREMENT_VALUE	List of Boolean	R	M
PRIMARY_MEASUREMENT_VALUE	Primary measurement value as a result of the measurement technology block	Numeric	R	M
PRIMARY_MEASUREMENT_STATUS	Status of the PRIMARY_MEASUREMENT_VALUE parameter	List of Boolean	R	M
UNITS	Units of the main measurement value	Enumerated	R/W	O
HIGH_ALARM_LIMIT	Value for upper limit of alarms	Numeric	R/W	O
LOW_ALARM_LIMIT	Value for lower limit of alarms	Numeric	R/W	O
MODE	Operation mode of the block (for example, manual, automatic, remote cascade)	Enumerated	R/W	O
CHANNEL	Logical reference to the technology block measurement	Enumerated	R/W	O
SIMULATE	Used to carry out internal tests	Enumerated	R/W	O
Analog Output FB				
REMOTE_SETPOINT_VALUE	Remote setpoint from the output of an upstream application block	Numeric	R/W	M
REMOTE_SETPOINT_STATUS	Status of the REMOTE_SETPOINT_VALUE parameter	List of Boolean	R/W	M
OUT_VALUE	Primary output value of the analog actuation output function	Numeric	R/W	M
OUT_STATUS	Status of the OUT_VALUE parameter	List of Boolean	R/W	M
READBACK_VALUE	Feedback of the downstream technology block readback output value	Numeric	R/W	M
READBACK_STATUS	Status of the READBACK_VALUE parameter	List of Boolean	R	M
READBACK_OUT_VALUE	Feedback to the upstream application block readback value	Numeric	R/W	M
READBACK_OUT_STATUS	Status of the READBACK_OUT_VALUE parameter	List of Boolean	R/W	M
UNITS	Unit selection	Enumerated	R/W	O
SP_HI_LIM	Setpoint value high limit	Numeric	R/W	O
SP_LO_LIM	Setpoint value low limit	Numeric	R/W	O

Parameter name	Description	Data type	User access read/write	Class M/O/C
MODE	Operation mode of the block (for example, manual, automatic, remote cascade)	Enumerated	R/W	O
CHANNEL	Reference to the technology block actuator	Enumerated	R/W	O
SIMULATE	Used to carry out internal tests	Enumerated	R/W	O
Discrete Input FB				
DISC_MEASUREMENT_VALUE	Discrete input measurement value	Boolean	R	M
DISC_MEASUREMENT_STATUS	Status of the DISC_MEASUREMENT_VALUE parameter	List of Boolean	R	M
DISC_PRIMARY_MEASUREMENT_VALUE	Primary discrete measurement value as a result of the discrete input technology block	Boolean	R	M
DISC_PRIMARY_MEASUREMENT_STATUS	Status of the DISC_PRIMARY_MEASUREMENT_VALUE parameter	List of Boolean	R	M
CONVERT	Boolean invert of the discrete primary value or of the sensor value	Boolean	R/W	O
MODE	Operation mode of the block, (for example, manual, automatic, remote cascade)	Enumerated	R/W	O
CHANNEL	Reference to the technology block input	Enumerated	R/W	O
SIMULATE	Used to carry out internal tests	Enumerated	R/W	O
Discrete Output FB				
DISC_REMOTE_SETPOINT_VALUE	Discrete remote setpoint from the output of an upstream application block	Boolean	R/W	M
DISC_REMOTE_SETPOINT_STATUS	Status of DISC_REMOTE_SETPOINT_VALUE parameter	List of Boolean	R/W	M
DISC_OUT_VALUE	Primary output value of the on/off actuation output function	Numeric	R/W	M
DISC_OUT_STATUS	Status of the DISC_OUT_VALUE parameter	List of Boolean	R	M
DISC_READBACK_VALUE	Readback of the discrete readback output from a downstream technology block	Boolean	R/W	M
DISC_READBACK_STATUS	Status of the DISC_READBACK_VALUE parameter	List of Boolean	R/W	M
DISC_READBACK_OUT_VALUE	Feedback to the upstream application block discrete readback value	Numeric	R/W	M
DISC_READBACK_OUT_STATUS	Status of the DISC_READBACK_OUT_VALUE parameter	List of Boolean	R/W	M
MODE	Operation mode of the block, (for example, manual, automatic, remote cascade)	Enumerated	R/W	O
CHANNEL	Reference to the technology block of the actuator	Enumerated	R/W	O
SIMULATE	Used to carry out internal tests of the actuator	Enumerated	R/W	O
Calculation FB				
FOLLOW	Forces the output value to track a block input	Numeric	R/W	O
IN_VALUE	Primary input value to the calculation	Numeric	R	M
IN_STATUS	Status of the primary input value	List of Boolean	R	M

Parameter name	Description	Data type	User access read/write	Class M/O/C
OUT_VALUE	Primary output value of the calculation	Numeric	R/W	M
OUT_STATUS	Status of the primary output value	List of Boolean	R	M
READBACK_VALUE	Feedback of the downstream block readback output value	Numeric	R/W	M
READBACK_STATUS	Status of the readback value	List of Boolean	R/W	M
READBACK_OUT_VALUE	Feedback to the upstream block readback value	Numeric	R/W	M
READBACK_OUT_STATUS	Status of the readback output value	List of Boolean	R/W	M
Control FB				
IN_VALUE	Primary input measurement	Numeric	R	M
IN_STATUS	Status of primary input measurement	List of Boolean	R	M
OUT_VALUE	Primary output value of the control function	Numeric	R/W	M
OUT_STATUS	Status of the OUT_VALUE parameter	List of Boolean	R	M
READBACK_VALUE	Feedback of the downstream block readback output value	Numeric	R/W	M
READBACK_STATUS	Status of the READBACK_VALUE parameter	Numeric	R/W	M
READBACK_OUT_VALUE	Feedback to the upstream block readback value	Numeric	R/W	M
READBACK_OUT_STATUS	Status of the READBACK_OUT_VALUE parameter	Numeric	R/W	M
REMOTE_SETPOINT_VALUE	Remote target value for a process output measurement from an upstream application block	Numeric	R/W	M
REMOTE_SETPOINT_STATUS	Status of the REMOTE_SETPOINT_VALUE parameter	List of Boolean	R	M
SETPOINT	Local target value for a process output measurement	Numeric	R/W	M
SP_HI_LIM	Upper limit for setpoint value	Numeric	R/W	O
SP_LO_LIM	Lower limit for setpoint value	Numeric	R/W	O
ALARM_HI	Upper alarm limit for the primary input value	Numeric	R/W	O
ALARM_LO	Lower alarm limit for the primary input value	Numeric	R/W	O
MODE	Operation mode of the block, (for example, manual, automatic, remote cascade)	Enumerated	R/W	O
Temperature Technology Block				
RAW_MEASUREMENT_VALUE	Raw measurement value as result of measurement acquisition	Numeric	R	M
RAW_MEASUREMENT_STATUS	Status of RAW_MEASUREMENT_VALUE parameter	List of Boolean	R	M
PRIMARY_MEASUREMENT_VALUE	Primary measurement value as result of the transformation function	Numeric	R	M
PRIMARY_MEASUREMENT_STATUS	Status of PRIMARY_MEASUREMENT_VALUE parameter	List of Boolean	R	M
SECONDARY_MEASUREMENT_VALUE	Secondary measurement value(s) as result of the transformation function	Numeric	R	O
SECONDARY_MEASUREMENT_STATUS	Status of the corresponding SECONDARY_MEASUREMENT_VALUE Parameters	List of Boolean	R	O

Parameter name	Description	Data type	User access read/write	Class M/O/C
CHANGE_CONFIG	Wiring check	Enumerated	R	O
SENSOR_CONNECTION	Two, 3 or 4 wires for RTD measurement	Enumerated	R/W	O
SENSOR_TYPE	Thermocouple, thermoresistance (RTD), low voltage i.e. in the range +/-25 mV or +/-100 mV	Enumerated	R/W	M
AD_CONV	A/D conversion parameters	Numeric	R/W	O
TEST_COMMAND	Starts test procedure to check the sensor	Enumerated	R/W	O
COMPENS_PARAM	Cold junction compensation parameters	Numeric	R/W	O
LINE_TYPE	Linearization curve coefficients, supplementary measure parameters	Enumerated	R/W	O
FILTER_PARAM	Filter parameters, (for example, anti-aliasing pre-filtering)	Enumerated	R/W	O
Pressure Technology Block				
RAW_MEASUREMENT_VALUE	Raw measurement value as a result of measurement acquisition	Numeric	R	M
RAW_MEASUREMENT_STATUS	Status of RAW_MEASUREMENT_VALUE parameter	List of Boolean	R	M
PRIMARY_MEASUREMENT_VALUE	Primary measurement value as a result of the transformation function	Numeric	R	M
PRIMARY_MEASUREMENT_STATUS	Status of PRIMARY_MEASUREMENT_VALUE parameter	List of Boolean	R	M
SECONDARY_MEASUREMENT_VALUE	Secondary measurement value(s) as a result of the transformation function	Numeric	R	O
SECONDARY_MEASUREMENT_STATUS(es)	Status of SECONDARY_MEASUREMENT_VALUE parameters	List of Boolean	R	O
SENSOR-CODE	Type of sensor (it identifies the transformation curve to be used)	Enumerated	R/W	O
CAL_POINT_LO	This parameter contains the lowest calibrated value, which is put to the sensor and transfer this point as LOW to the transmitter.	Numeric	R/W	O
CAL_POINT_HI	This parameter contains the highest calibrated value, which is put to the sensor and transfer this point as HIGH to the transmitter.	Numeric	R/W	O
SENSOR_HI_LIM	Physical upper limit of the sensor	Numeric	R/W	O
SENSOR_LO_LIM	Physical lower limit of the sensor	Numeric	R/W	O
TEST_COMMAND	Starts test procedure to check the sensor	Enumerated	R/W	O
TRANSF_PARAM	Linearization curve coefficients and supplementary measure parameters	Numeric	R/W	O
LOW_FLOW_CUT_OFF	Lowest flow value which is determined as the minimum value	Numeric	R/W	O
FILTER_PARAM	Filter parameters, (for example, anti-aliasing pre-filtering)	Enumerated	R/W	O

Parameter name	Description	Data type	User access read/write	Class M/O/C
Modulating Actuation Technology Block				
SETPOINT_VALUE	Setpoint value for a process output from an upstream application block	Numeric	R/W	M
SETPOINT_STATUS	Status of the SETPOINT_STATUS parameter	List of Boolean	R/W	M
READBACK_VALUE	Feedback to the upstream AB readback value	Numeric	R	M
READBACK_STATUS	Status of the READBACK_VALUE parameter	List of Boolean	R	M
ACTUATOR_DEMAND	Demand to the actuator resulting from the transformation function	Enumerated	R	O
POSITION_MEASURE	Result feedback from the actuation/acquisition function	Numeric	R	O
FAILSAFE_ACTION	Fail-safe position for power-loss of the actuator respectively the valve	Enumerated	R/W	O
TEST_COMMAND	Starts test procedure to check the actuator	Enumerated	R/W	O
SETP_CUTOFF_MIN	When the setpoint (OUT_VALUE) goes below the defined per cent of span, the actuator signal goes to the minimum limit.	Numeric	R/W	O
SETP_CUTOFF_MAX	When the setpoint (OUT_VALUE) goes over the defined per cent of span, the actuator signal goes to the maximum limit.	Numeric	R/W	O
DEADBAND	Deadband of the actuator	Numeric	R/W	O
SELF_CALIB_STATUS:	Result of the calibration procedure (undetermined, aborted, success)	List of Boolean	R	O
On/Off Actuation Technology Block				
DISC_SETPOINT_VALUE	Local target value for the discrete actuation output	Boolean	R/W	M
DISC_SETPOINT_STATUS	Status of the discrete setpoint	List of Boolean	R/W	M
DISC_READBACK_VALUE	Feedback to the upstream application block readback value	Boolean	R	M
DISC_READBACK_STATUS	Status of the discrete readback output value	List of Boolean	R	M
DISC_ACTUATOR_DEMAND	Demand to the actuator resulting from the transformation function	Boolean	R	O
DISC_POSITION_MEASURE	Result feedback from the actuation/acquisition function	Boolean	R	O
FAILSAFE_ACTION	Fail-Safe position for power-loss of the actuator respectively the valve	Enumerated	R/W	O
TRAVEL_COUNT	Number of cycles from OPEN to CLOSE and CLOSE to OPEN	Numeric	R	O
TRAVEL_COUNT_LIMIT	Limit for TRAVEL_COUNT	Numeric	R/W	O
BREAK_TIME_CLOSE	Dead time between the change of the state (DISC_SETPOINT_VALUE) from CLOSE and the indication that the actuator starts its action	Numeric	R/W	O
BREAK_TIME_OPEN	Dead time between the change of the state (DISC_SETPOINT_VALUE) from OPEN and the indication that the actuator starts its action	Numeric	R/W	O
SELF_CALIB_STATUS	Result of the calibration procedure (undetermined, aborted, success)	List of Boolean	R	O

Parameter name	Description	Data type	User access read/ write	Class M/O/C
Device Block				
DEVICE_VENDOR	Company name of the manufacturer	String	R	M
DEVICE_MODEL	Name of the device model	String	R	M
DEVICE_REVISION	Device revision number	String	R	M
DEVICE_SER_NO	Serial number of the device	String	R	O
DEVICE_STATUS	Status of the device	List of Boolean	R	M

Annex B (normative)

IEC 61804 conformance declaration

The following conventions are given as a guideline and template and are common to all conformance declarations.

The conformance is described as follows. The (sub)clause selection is defined in Table B.1 and Table B.2. The selected options are indicated by (sub)clause and key words. Selection is made at the highest (sub)clause level.

Table B.1 – Conformance (sub)clause selection table

Clause #	Key word	Presence	Constraints

Table B.2 – Contents of (sub)clause selection tables

Column	Text	Meaning
Clause #	<#>	(Sub)clause number of the base specifications
Keyword	<text>	(Sub)clause title of the base specifications
Presence	NO	This (sub)clause is not included in the profile
	YES	This (sub)clause is fully (100 %) included in the profile (in this case no further detail is given)
	—	Presence is defined in the following subclauses
	Partial	Parts of this (sub)clause are included in the profile
Constraints	see <#>	Constraints/remarks are defined in the given subclause, table or figure of this conformance document
	—	No constraints other than those given in the reference document (sub)clause, or not applicable
	<text>	The text defines the constraint directly; for longer text, table footnotes or table notes may be used

Bibliography

ISO/IEC 2022:1994, *Information technology – Character code structure and extension techniques*

ISO/IEC 2375:2003, *Information technology – Procedure for registration of escape sequences and coded character sets*

ISO/IEC 8859-1, *Information technology – 8-bit single-byte coded graphic character sets – Part 1: Latin alphabet No. 1*

ISO 15745-1, *Industrial automation systems and integration – Open systems application integration frameworks – Part 1: Generic reference description*

ISO 2382 (all parts), *Information technology – Vocabulary*

ISO/Afnor, *Dictionary of Computer Science*

IEEE 754:1985 (R1990), *Binary Floating-Point Arithmetic*

British Standards Institution (BSI)

BSI is the independent national body responsible for preparing British Standards and other standards-related publications, information and services.

It presents the UK view on standards in Europe and at the international level.

It is incorporated by Royal Charter.

Revisions

British Standards are updated by amendment or revision. Users of British Standards should make sure that they possess the latest amendments or editions.

It is the constant aim of BSI to improve the quality of our products and services. We would be grateful if anyone finding an inaccuracy or ambiguity while using this British Standard would inform the Secretary of the technical committee responsible, the identity of which can be found on the inside front cover.

Tel: +44 (0)20 8996 9001 Fax: +44 (0)20 8996 7001

BSI offers Members an individual updating service called PLUS which ensures that subscribers automatically receive the latest editions of standards.

Tel: +44 (0)20 8996 7669 Fax: +44 (0)20 8996 7001

Email: plus@bsigroup.com

Buying standards

You may buy PDF and hard copy versions of standards directly using a credit card from the BSI Shop on the website www.bsigroup.com/shop. In addition all orders for BSI, international and foreign standards publications can be addressed to BSI Customer Services.

Tel: +44 (0)20 8996 9001 Fax: +44 (0)20 8996 7001

Email: orders@bsigroup.com

In response to orders for international standards, it is BSI policy to supply the BSI implementation of those that have been published as British Standards, unless otherwise requested.

BSI Group Headquarters

389 Chiswick High Road London W4 4AL UK

Tel +44 (0)20 8996 9001

Fax +44 (0)20 8996 7001

www.bsigroup.com/standards

Information on standards

BSI provides a wide range of information on national, European and international standards through its Knowledge Centre.

Tel: +44 (0)20 8996 7004 Fax: +44 (0)20 8996 7005

Email: knowledgecentre@bsigroup.com

Various BSI electronic information services are also available which give details on all its products and services.

Tel: +44 (0)20 8996 7111 Fax: +44 (0)20 8996 7048

Email: info@bsigroup.com

BSI Subscribing Members are kept up to date with standards developments and receive substantial discounts on the purchase price of standards. For details of these and other benefits contact Membership Administration.

Tel: +44 (0)20 8996 7002 Fax: +44 (0)20 8996 7001

Email: membership@bsigroup.com

Information regarding online access to British Standards via British Standards Online can be found at www.bsigroup.com/BSOL

Further information about BSI is available on the BSI website at www.bsigroup.com/standards

Copyright

Copyright subsists in all BSI publications. BSI also holds the copyright, in the UK, of the publications of the international standardization bodies. Except as permitted under the Copyright, Designs and Patents Act 1988 no extract may be reproduced, stored in a retrieval system or transmitted in any form or by any means – electronic, photocopying, recording or otherwise – without prior written permission from BSI. This does not preclude the free use, in the course of implementing the standard of necessary details such as symbols, and size, type or grade designations. If these details are to be used for any other purpose than implementation then the prior written permission of BSI must be obtained. Details and advice can be obtained from the Copyright & Licensing Manager.

Tel: +44 (0)20 8996 7070

Email: copyright@bsigroup.com